



U.S. Department of
Transportation

**Federal Railroad
Administration**

Crash Energy Management Coupling Test between a Coach Car and a Passenger Locomotive

Office of Research,
Development
and Technology
Washington, DC 20590



NOTICE

This document is disseminated under the sponsorship of the Department of Transportation in the interest of information exchange. The United States Government assumes no liability for its contents or use thereof. Any opinions, findings and conclusions, or recommendations expressed in this material do not necessarily reflect the views or policies of the United States Government, nor does mention of trade names, commercial products, or organizations imply endorsement by the United States Government. The United States Government assumes no liability for the content or use of the material contained in this document.

NOTICE

The United States Government does not endorse products or manufacturers. Trade or manufacturers' names appear herein solely because they are considered essential to the objective of this report.

REPORT DOCUMENTATION PAGE			<i>Form Approved</i> <i>OMB No. 0704-0188</i>	
Public reporting burden for this collection of information is estimated to average 1 hour per response, including the time for reviewing instructions, searching existing data sources, gathering and maintaining the data needed, and completing and reviewing the collection of information. Send comments regarding this burden estimate or any other aspect of this collection of information, including suggestions for reducing this burden, to Washington Headquarters Services, Directorate for Information Operations and Reports, 1215 Jefferson Davis Highway, Suite 1204, Arlington, VA 22202-4302, and to the Office of Management and Budget, Paperwork Reduction Project (0704-0188), Washington, DC 20503.				
1. AGENCY USE ONLY (Leave blank)		2. REPORT DATE January 2021		3. REPORT TYPE AND DATES COVERED Technical Report, 2/8/2016-1/31/2018
4. TITLE AND SUBTITLE Crash Energy Management Coupling Test between a Coach Car and a Passenger Locomotive			5. FUNDING NUMBERS Task Order 0009/0021 DTFR53-11-D-00008L FR15RPD00-TTCI-00-030	
6. AUTHOR(S) Przemyslaw Rakoczy and Enrico Sciandra				
7. PERFORMING ORGANIZATION NAME(S) AND ADDRESS(ES) Transportation Technology Center, Inc. a subsidiary of Association of American Railroads 55500 DOT Road Pueblo, CO 81001			8. PERFORMING ORGANIZATION REPORT NUMBER	
9. SPONSORING/MONITORING AGENCY NAME(S) AND ADDRESS(ES) U.S. Department of Transportation Federal Railroad Administration Office of Railroad Policy and Development Office of Research, Development and Technology Washington, DC 20590			10. SPONSORING/MONITORING AGENCY REPORT NUMBER DOT/FRA/ORD-21/01	
11. SUPPLEMENTARY NOTES COR: Jeff Gordon				
12a. DISTRIBUTION/AVAILABILITY STATEMENT This document is available to the public through the FRA website .			12b. DISTRIBUTION CODE	
13. ABSTRACT Transportation Technology Center, Inc. conducted impact tests with a Budd M1 passenger car and an F40 locomotive to evaluate the performance of both vehicles under dynamic conditions. The locomotive was retrofitted with crash energy management components, including a push-back coupler (PBC) and crushable anti-climbers. A series of impact tests were performed October 3 and 4, 2017, at the Transportation Technology Center in Pueblo, Colorado. The M1 passenger car was impacted by the locomotive at 1.8 mph, 3.74 mph, 5.66 mph, 6.84 mph, 7.63 mph, and 8.85 mph. The most substantial damage was inflicted upon the M1 passenger car, with the F40 locomotive sustaining no noticeable damage. The most significant damage was the buckling of the M1 traction rod that occurred during the third test. The traction rod was replaced and buckled again during the fourth test, and was not replaced. The PBC activated during the last test at 8.85 mph.				
14. SUBJECT TERMS Coupling impact test, crash energy management, transportation safety, passenger car safety			15. NUMBER OF PAGES 136	
			16. PRICE CODE	
17. SECURITY CLASSIFICATION OF REPORT Unclassified	18. SECURITY CLASSIFICATION OF THIS PAGE Unclassified	19. SECURITY CLASSIFICATION OF ABSTRACT Unclassified	20. LIMITATION OF ABSTRACT	

METRIC/ENGLISH CONVERSION FACTORS

ENGLISH TO METRIC

METRIC TO ENGLISH

<p style="text-align: center;">LENGTH (APPROXIMATE)</p> <p>1 inch (in) = 2.5 centimeters (cm)</p> <p>1 foot (ft) = 30 centimeters (cm)</p> <p>1 yard (yd) = 0.9 meter (m)</p> <p>1 mile (mi) = 1.6 kilometers (km)</p>	<p style="text-align: center;">LENGTH (APPROXIMATE)</p> <p>1 millimeter (mm) = 0.04 inch (in)</p> <p>1 centimeter (cm) = 0.4 inch (in)</p> <p>1 meter (m) = 3.3 feet (ft)</p> <p>1 meter (m) = 1.1 yards (yd)</p> <p>1 kilometer (km) = 0.6 mile (mi)</p>
<p style="text-align: center;">AREA (APPROXIMATE)</p> <p>1 square inch (sq in, in²) = 6.5 square centimeters (cm²)</p> <p>1 square foot (sq ft, ft²) = 0.09 square meter (m²)</p> <p>1 square yard (sq yd, yd²) = 0.8 square meter (m²)</p> <p>1 square mile (sq mi, mi²) = 2.6 square kilometers (km²)</p> <p>1 acre = 0.4 hectare (he) = 4,000 square meters (m²)</p>	<p style="text-align: center;">AREA (APPROXIMATE)</p> <p>1 square centimeter (cm²) = 0.16 square inch (sq in, in²)</p> <p>1 square meter (m²) = 1.2 square yards (sq yd, yd²)</p> <p>1 square kilometer (km²) = 0.4 square mile (sq mi, mi²)</p> <p>10,000 square meters (m²) = 1 hectare (ha) = 2.5 acres</p>
<p style="text-align: center;">MASS - WEIGHT (APPROXIMATE)</p> <p>1 ounce (oz) = 28 grams (gm)</p> <p>1 pound (lb) = 0.45 kilogram (kg)</p> <p>1 short ton = 2,000 pounds (lb) = 0.9 tonne (t)</p>	<p style="text-align: center;">MASS - WEIGHT (APPROXIMATE)</p> <p>1 gram (gm) = 0.036 ounce (oz)</p> <p>1 kilogram (kg) = 2.2 pounds (lb)</p> <p>1 tonne (t) = 1,000 kilograms (kg) = 1.1 short tons</p>
<p style="text-align: center;">VOLUME (APPROXIMATE)</p> <p>1 teaspoon (tsp) = 5 milliliters (ml)</p> <p>1 tablespoon (tbsp) = 15 milliliters (ml)</p> <p>1 fluid ounce (fl oz) = 30 milliliters (ml)</p> <p>1 cup (c) = 0.24 liter (l)</p> <p>1 pint (pt) = 0.47 liter (l)</p> <p>1 quart (qt) = 0.96 liter (l)</p> <p>1 gallon (gal) = 3.8 liters (l)</p> <p>1 cubic foot (cu ft, ft³) = 0.03 cubic meter (m³)</p> <p>1 cubic yard (cu yd, yd³) = 0.76 cubic meter (m³)</p>	<p style="text-align: center;">VOLUME (APPROXIMATE)</p> <p>1 milliliter (ml) = 0.03 fluid ounce (fl oz)</p> <p>1 liter (l) = 2.1 pints (pt)</p> <p>1 liter (l) = 1.06 quarts (qt)</p> <p>1 liter (l) = 0.26 gallon (gal)</p> <p>1 cubic meter (m³) = 36 cubic feet (cu ft, ft³)</p> <p>1 cubic meter (m³) = 1.3 cubic yards (cu yd, yd³)</p>
<p style="text-align: center;">TEMPERATURE (EXACT)</p> <p style="text-align: center;">[(x-32)(5/9)] °F = y °C</p>	<p style="text-align: center;">TEMPERATURE (EXACT)</p> <p style="text-align: center;">[(9/5)y + 32] °C = x °F</p>

QUICK INCH - CENTIMETER LENGTH CONVERSION

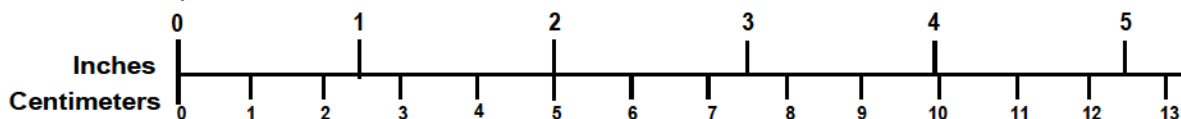

QUICK FAHRENHEIT - CELSIUS TEMPERATURE CONVERSION

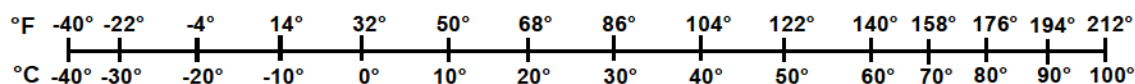

For more exact and or other conversion factors, see NIST Miscellaneous Publication 286, Units of Weights and Measures. Price \$2.50 SD Catalog No. C13 10286

Contents

Executive Summary	1
1. Introduction	2
1.1 Background	2
1.2 Objectives	2
1.3 Overall Approach	2
1.4 Scope	2
1.5 Organization of the Report	2
1.6 M1 Passenger Car	3
1.7 F40 Locomotive	3
1.8 Test Setup	4
2. Test Instrumentation	8
2.1 Definition of Coordinate Axes	8
2.2 Locomotive Accelerometers	8
2.3 F40 Locomotive String Potentiometers	10
2.4 Locomotive Strain Gages	14
2.5 Locomotive Speed Sensors	16
2.6 M1 Passenger Car Accelerometers	16
2.7 M1 Passenger Car String Potentiometers	18
2.8 M1 Passenger Car Strain Gages	20
2.9 Real-Time and High-Speed Photography	21
2.10 Data Acquisition	22
3. Results	24
3.1 Test Details	24
3.2 Measured Data	24
3.3 Post-Test Damage	62
4. Conclusion	65
5. References	66
Abbreviations and Acronyms	Error! Bookmark not defined.
Appendix A. Target Positions	67
Appendix B. 2 mph Test Data	68
Appendix C. 4 mph Test Data	78
Appendix D. 6 mph Test Data	88
Appendix E. 7 mph Test Data	98
Appendix F. 8 mph Test Data	108
Appendix G. 9 mph Test Data	118

Illustrations

Figure 1. M1 Passenger Car 8221	3
Figure 2. F40 Locomotive.....	4
Figure 3. Initial Coupler Misalignment	5
Figure 4. Coupler Carrier on the Locomotive.....	6
Figure 5. Coupler Carrier and Shims on the M1 Car.....	7
Figure 6. Accelerometer Locations on F40 Locomotive	9
Figure 7. Accelerometer Locations on F40 Locomotive	10
Figure 8. Locations of Accelerometers on F40 Locomotive Truck.....	11
Figure 9. F40 Locomotive Truck Secondary Suspension String Potentiometers	11
Figure 10. F40 Locomotive Coupler Instrumentation	12
Figure 11. F40 Locomotive Underframe String Potentiometers	12
Figure 12. Right Side F40 Locomotive String Potentiometers.....	13
Figure 13. F40 Locomotive Coupler String Potentiometers.....	13
Figure 14. Strain Gage Locations on F40 Locomotive Coupler Shank.....	15
Figure 15. Strain Gage Locations on F40 Locomotive Sliding Lug.....	15
Figure 16. Strain Gage Locations on F40 Locomotive Sliding Lug.....	16
Figure 17. Strain Gage Locations on F40 Locomotive Sliding Lug.....	16
Figure 18. Accelerometer Locations on M1 Passenger Car	17
Figure 19. String Potentiometer and Accelerometer on M1 Passenger Car Truck.....	18
Figure 20. M1 Passenger Car Coupler Instrumentation.....	19
Figure 21. M1 Passenger Car Underframe String Potentiometer Left.....	19
Figure 22. M1 Passenger Car Underframe String Potentiometer Right	20
Figure 23. Strain Gage Locations on M1 Passenger Car Draft Sill and Center Sill.....	21
Figure 24. Strain Gage Locations on M1 Passenger Car	21
Figure 25. High-Speed Camera Locations.....	22
Figure 26. High-Definition Camera Locations	22
Figure 27. Longitudinal Average Acceleration at 2 mph Impact	25
Figure 28. Longitudinal Average Accelerations at 4 mph Impact.....	26
Figure 29. Longitudinal Average Accelerations at 6 mph Impact.....	26
Figure 30. Longitudinal Average Accelerations at 7 mph Impact.....	27
Figure 31. Longitudinal Average Accelerations at 8 mph Impact.....	27

Figure 32. Longitudinal Average Accelerations at 9 mph Impact.....	28
Figure 33. Couplers Displacement at 2 mph.....	29
Figure 34. Couplers Displacement at 4 mph.....	29
Figure 35. Couplers Displacement at 6 mph.....	30
Figure 36. Couplers Displacement at 7 mph.....	30
Figure 37. Couplers Displacement at 8 mph.....	31
Figure 38. Couplers Displacement at 9 mph.....	31
Figure 39. F40 Locomotive Coupler Shank Strain Gages (2 mph)	32
Figure 40. F40 Locomotive Sliding Lug Strain Gages (2 mph)	33
Figure 41. F40 Locomotive Draft Pocket Strain Gages (2 mph).....	33
Figure 42. F40 Locomotive Top of Draft Pocket Strain Gages (2 mph)	33
Figure 43. F40 Locomotive Center Sill Strain Gages (2 mph).....	34
Figure 44. M1 Passenger Car Draft Sill Strain Gages (2 mph)	34
Figure 45. M1 Passenger Car Center Sill Transition Strain Gages (2 mph).....	35
Figure 46. M1 Passenger Car Side Sill Strain Gages (2 mph).....	35
Figure 47. F40 Locomotive Coupler Shank Strain Gages (4 mph)	36
Figure 48. F40 Locomotive Sliding Lug Strain Gages (4 mph)	36
Figure 49. F40 Locomotive Draft Pocket Strain Gages (4 mph).....	37
Figure 50. F40 Locomotive Top of Draft Pocket Strain Gages (4 mph)	37
Figure 51. F40 Locomotive Center Sill Strain Gages (4 mph).....	38
Figure 52. M1 Passenger Car Draft Sill Strain Gages (4 mph)	38
Figure 53. M1 Passenger Car Center Sill Transition Strain Gages (4 mph).....	39
Figure 54. M1 Passenger Car Side Sill Strain Gages (4 mph).....	39
Figure 55. F40 Locomotive Coupler Shank Strain Gages (6 mph)	40
Figure 56. F40 Locomotive Sliding Lug Strain Gages (6 mph)	40
Figure 57. F40 Locomotive Draft Pocket Strain Gages (6 mph).....	41
Figure 58. F40 Locomotive Top of Draft Pocket Strain Gages (6 mph)	41
Figure 59. F40 Locomotive Center Sill Strain Gages (6 mph).....	42
Figure 60. M1 Passenger Car Draft Sill Strain Gages (6 mph)	42
Figure 61. M1 Passenger Car Center Sill Transition Strain Gages (6 mph).....	43
Figure 62. M1 Passenger Car Side Sill Strain Gages (6 mph).....	43
Figure 63. F40 Locomotive Coupler Shank Strain Gages (7 mph)	44
Figure 64. F40 Locomotive Sliding Lug Strain Gages (7 mph)	44

Figure 65. F40 Locomotive Draft Pocket Strain Gages (7 mph).....	45
Figure 66. F40 Locomotive Top of Draft Pocket Strain Gages (7 mph).....	45
Figure 67. F40 Locomotive Center Sill Strain Gages (7 mph).....	46
Figure 68. M1 Passenger Car Draft Sill Strain Gages (7 mph).....	46
Figure 69. M1 Passenger Car Center Sill Transition Strain Gages (7 mph).....	47
Figure 70. M1 Passenger Car Side Sill Strain Gages (7 mph).....	47
Figure 71. F40 Locomotive Coupler Shank Strain Gages (8 mph).....	48
Figure 72. F40 Locomotive Sliding Lug Strain Gages (8 mph).....	48
Figure 73. F40 Locomotive Draft Pocket Strain Gages (8 mph).....	49
Figure 74. F40 Locomotive Top of Draft Pocket Strain Gages (8 mph).....	49
Figure 75. F40 Locomotive Center Sill Strain Gages (8 mph).....	50
Figure 76. M1 Passenger Car Draft Sill Strain Gages (8 mph).....	50
Figure 77. M1 Passenger Car Center Sill Transition Strain Gages (8 mph).....	51
Figure 78. M1 Passenger Car Side Sill Strain Gages (8 mph).....	51
Figure 79. F40 Locomotive Coupler Shank Strain Gages (9 mph).....	52
Figure 80. F40 Locomotive Sliding Lug Strain Gages (9 mph).....	52
Figure 81. F40 Locomotive Draft Pocket Strain Gages (9 mph).....	53
Figure 82. F40 Locomotive Top of Draft Pocket Strain Gages (9 mph).....	53
Figure 83. F40 Locomotive Center Sill Strain Gages (9 mph).....	54
Figure 84. M1 Passenger Car Draft Sill Strain Gages (9 mph).....	54
Figure 85. M1 Passenger Car Center Sill Transition Strain Gages (9 mph).....	55
Figure 86. M1 Passenger Car Side Sill Strain Gages (9 mph).....	55
Figure 87. Impact Force at 2 mph.....	56
Figure 88. Impact Force at 4 mph.....	56
Figure 89. Impact Force at 6 mph.....	57
Figure 90. Impact Force at 7 mph.....	57
Figure 91. Impact Force at 8 mph.....	58
Figure 92. Impact Force at 9 mph.....	58
Figure 93. Energy Balance at 2 mph.....	59
Figure 94. Energy Balance at 4 mph.....	60
Figure 95. Energy Balance at 6 mph.....	60
Figure 96. Energy Balance at 7 mph.....	61
Figure 97. Energy Balance at 8 mph.....	61

Figure 98. Energy Balance at 9 mph.....	62
Figure 99. Bent Traction Rod after Third Test	63
Figure 100. Bent Traction Rod after Fourth Test	63
Figure 101. Bent Traction Rod after Fifth Test	64
Figure 102. Bent Traction Rod after Sixth Test.....	64

Tables

Table 1. Instrumentation Summary.....	8
Table 2. F40 Locomotive Accelerometers Summary	8
Table 3. F40 Locomotive String Potentiometers Summary.....	10
Table 4. F40 Locomotive Strain Gage Summary	14
Table 5. M1 Passenger Car Instrumentation – Accelerometers.....	17
Table 6. M1 Passenger Car Instrumentation – String Potentiometers	18
Table 7. M1 Passenger Car Instrumentation.....	20
Table 8. Summary of Ambient Conditions	24
Table 9. Summary of Test Results.....	24

Executive Summary

This report documents coupler impact testing between a conventional passenger car and a passenger locomotive. This testing was intended to evaluate the minimum force and impact speed required to activate a retrofitted push-back coupler (PBC).

Transportation Technology Center, Inc. (TTCI) conducted the impact tests between a Budd M1 passenger car and an F40 locomotive to evaluate the performance of the PBC under dynamic conditions. TTCI researchers retrofitted the locomotive with crash energy management components, including PBC and crushable anti-climbers. They performed this series of impact tests on October 3 and 4, 2017, at the Transportation Technology Center (TTC) in Pueblo, Colorado.

The M1 passenger car was impacted by the locomotive in six impact tests at 1.8 mph, 3.74 mph, 5.66 mph, 6.84 mph, 7.63 mph, and 8.85 mph, respectively. The passenger car and locomotive coupled successfully during the first two tests, but failed to couple during all other test runs. The vertical coupler misalignment between the locomotive and the M1 car was noted and corrected by shims before the test; however, this could have influenced the coupling performance. The M1 passenger car sustained some damage during the tests, but the F40 locomotive sustained no noticeable damage. The traction rod on the M1 passenger car buckled during the third test. The traction rod was substituted with another one, and it buckled again during the fourth test. The traction rod was not replaced for subsequent tests.

The PBC was activated during the last test with the impact speed of 8.85 mph. The PBC crushable tube was pushed approximately 1 inch from the initial position after the last test.

Future testing will include vehicle-to-vehicle impact tests which will be performed at speeds selected to result in near exhaustion of the energy-absorbing capacity of the crash energy management components. This test series will be followed by a full-scale train-to-train test to evaluate the performance of the crash energy performance in a high-energy collision scenario.

1. Introduction

In 2017, Transportation Technology Center, Inc. (TTCI) conducted impact tests between a conventional passenger locomotive and an M1 passenger car. These tests measured and characterized the structural performance of the coupling vehicles under a range of increasing dynamic coupling speeds until activation of the push-back coupler (PBC) occurred on the locomotive. Results of these tests established a maximum activation force for the PBC.

This research program integrated two crash energy management (CEM) components onto a locomotive to demonstrate that these components work together to mitigate the effects of a collision and prevent override. The first CEM component was a deformable anti-climber, the second a PBC. A series of dynamic CEM coupling tests demonstrated that the PBC triggered at a velocity close to 9 mph.

1.1 Background

The Office of Research, Development and Technology at the Federal Railroad Administration (FRA) and the Volpe National Transportation Systems Center (Volpe) evaluate new technologies for increasing the safety of passengers and operators in rail equipment. In recognition of the importance of override prevention in train-to-train collisions in which one of the vehicles is a locomotive, and in light of the success of CEM technologies in passenger trains, FRA sought to evaluate the effectiveness of components integrated into the end structure of a locomotive specifically designed to mitigate the effects of a collision and to prevent override of one of the lead vehicles onto the other.

1.2 Objectives

TTCI researchers conducted these tests to demonstrate the robustness of the PBC design. The tests measured and characterized the performance of the PBC and the coupling vehicles under a range of dynamic coupling speeds. In the future, the whole CEM system will be tested in a full-scale impact test.

1.3 Overall Approach

This test used M1 passenger car 8221, a type of electric multiple unit vehicle built by the Budd Company for the Long Island Railroad to serve as the stationary passenger car. The F40 Locomotive 234, a four-axle diesel electric locomotive intended for passenger service, was used as the impacting vehicle. Before testing, TTCI conducted two separate speed trials using the F40 locomotive to determine the optimum release location for each impact speed. The testing was performed by positioning the F40 locomotive uphill from the stationary M1 passenger car and allowing the locomotive to roll into the car.

1.4 Scope

This report presents the test results, discusses the execution of the test, and summarizes the overall results of the test.

1.5 Organization of the Report

Section 2 describes the test instrumentation and data collection system used in testing.

Section 3 describes the results of the test. These results include the test details, the data measured, and a discussion of the post-test damage.

Section 4 contains the concluding remarks.

Section 5 contains a list of the references made in this report.

[Appendix A](#) describes the target positions.

[Appendix B](#) contains the test data at 2 mph.

[Appendix C](#) contains the test data at 4 mph.

[Appendix D](#) contains the test data at 6 mph.

[Appendix E](#) contains the test data at 7 mph.

[Appendix F](#) contains the test data at 8 mph.

[Appendix G](#) contains the test data at 9 mph.

1.6 M1 Passenger Car

The M1 passenger car is a type of electric multiple unit vehicle, built by the Budd Company for the Long Island Railroad. This test used M1 passenger car 8221, weighing 89,700 lbs, to serve as the stationary passenger car ([Figure 1](#)).



Figure 1. M1 Passenger Car 8221

1.7 F40 Locomotive

The F40 locomotive is a four-axle diesel electric locomotive intended for use in passenger service. This test used F40 Locomotive 234, weighing 232,600 lbs, as the impacting vehicle ([Figure 2](#)).



Figure 2. F40 Locomotive

1.8 Test Setup

TTCI performed the CEM coupling testing on October 3 and 4, 2017, at the TTC in Pueblo, Colorado. The testing was performed by positioning the F40 uphill from the stationary M1 passenger car and allowing the locomotive to roll into the car. The release positions of the locomotive were determined through speed trials and adjusted shortly before the release to achieve the desired impact speeds. The couplers were initially misaligned by more than 3 inches, as shown in [Figure 3](#). The M1 coupler was shimmed to compensate, making the coupler height difference between 1 and 2 inches for the first five tests. For the last (9 mph) test, the F40

coupler carrier was lowered to reduce the misalignment to less than 1 inch. The couplers of the locomotive and M1 passenger car were opened and aligned to allow the M1 and locomotive to couple upon impact. [Figure 4](#) shows the retrofitted locomotive coupler carrier and [Figure 5](#) shows coupler shims on the M1 car.



Figure 3. Initial Coupler Misalignment



Figure 4. Coupler Carrier on the Locomotive



Figure 5. Coupler Carrier and Shims on the M1 Car

The M1 passenger car's air brakes were applied and the hand brake secured before each impact. The M1's front coupler was placed at the predesignated point of impact before each test run. A string of loaded hopper cars was placed roughly 200 feet behind the M1 passenger car to arrest any remaining momentum if the brakes were not sufficient.

Before testing, two separate F40 speed trials were conducted to determine the optimum release location for each impact speed. Data from these speed runs was used in calculations, which accounted for wind speed and direction, to determine a more precise release location for each target speed.

2. Test Instrumentation

The test configuration and instrumentation were all consistent with the specifications in the test implementation plan. [Table 1](#) lists all instrumentation used for this testing. Additional descriptions of instrumentation are provided in the following subsections.

Table 1. Instrumentation Summary

Type of Instrumentation	Channel Count
Accelerometers	43
String Potentiometers	15
Strain Gages	49
Total Data Channels	107
High-Definition Video	5
High-Speed Video	6

2.1 Definition of Coordinate Axes

All local acceleration and displacement coordinate systems are defined relative to the front (lead) end of the F40 Locomotive 234. Positive X, Y, and Z directions are forward, left, and up—relative to the lead end of the locomotive and facing the direction of travel.

2.2 Locomotive Accelerometers

Tri-axial accelerometers were placed at the two ends and the center along the locomotive centerline. The F40 locomotive had longitudinal and vertical accelerometers placed on the left and right sides of its underframe at its longitudinal center. Each locomotive truck was equipped with a vertical accelerometer and two longitudinal accelerometers, right and left. The locomotive’s PBC was fitted with three longitudinal accelerometers, one on each side of the coupler and one on the bottom of the sliding lug. The typical scale factor calibration error for the accelerometers used was 2 percent. The names, ranges, and locations of the accelerometers used in the test are summarized in [Table 2](#), [Figure 5](#), and [Figure 6](#).

Table 2. F40 Locomotive Accelerometers Summary

Name	Range	Location
ALLE_X	400 g	Locomotive, lead end, center – longitudinal
ALLE_Y	200 g	Locomotive, lead end, center – lateral
ALLE_Z	200 g	Locomotive, lead end, center – vertical
ALUC_X	200 g	Locomotive, underframe center – longitudinal
ALUC_Y	200 g	Locomotive, underframe center – lateral
ALUC_Z	200 g	Locomotive, underframe center – vertical
ALUCR_X	200 g	Locomotive, underframe center right – longitudinal
ALUCR_Z	200 g	Locomotive, underframe center right – vertical
ALUCL_X	200 g	Locomotive, underframe center left – longitudinal
ALUCL_Z	200 g	Locomotive, underframe center left – vertical

Name	Range	Location
ALTEC_X	200 g	Locomotive, trailing end, center – longitudinal
ALTEC_Y	200 g	Locomotive, trailing end, center – lateral
ALTEC_Z	200 g	Locomotive, trailing end, center – vertical
ALLT_Z	400 g	Locomotive, lead truck – vertical
ALLTR_X	400 g	Locomotive, lead truck, right – longitudinal
ALLTL_X	400 g	Locomotive, lead truck, left – longitudinal
ALTT_Z	400 g	Locomotive, trailing truck – vertical
ALTTR_X	400 g	Locomotive, trailing truck, right – longitudinal
ALLTL_X	400 g	Locomotive, trailing truck, left – longitudinal
ALCR_X	5000 g	Locomotive coupler, right – longitudinal
ALCL_X	5000 g	Locomotive coupler, left – longitudinal
ALS_X	5000 g	Locomotive sliding lug – longitudinal

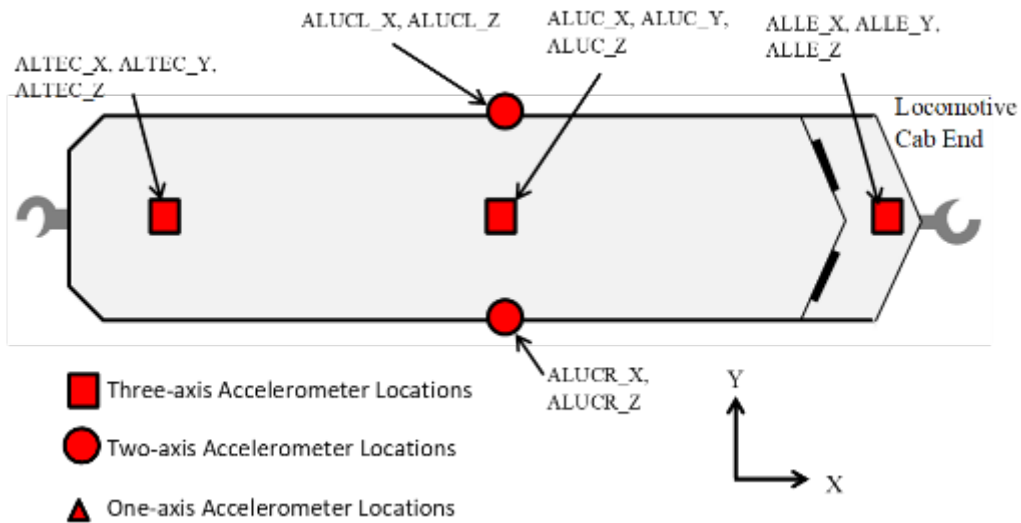

Figure 6. Accelerometer Locations on F40 Locomotive

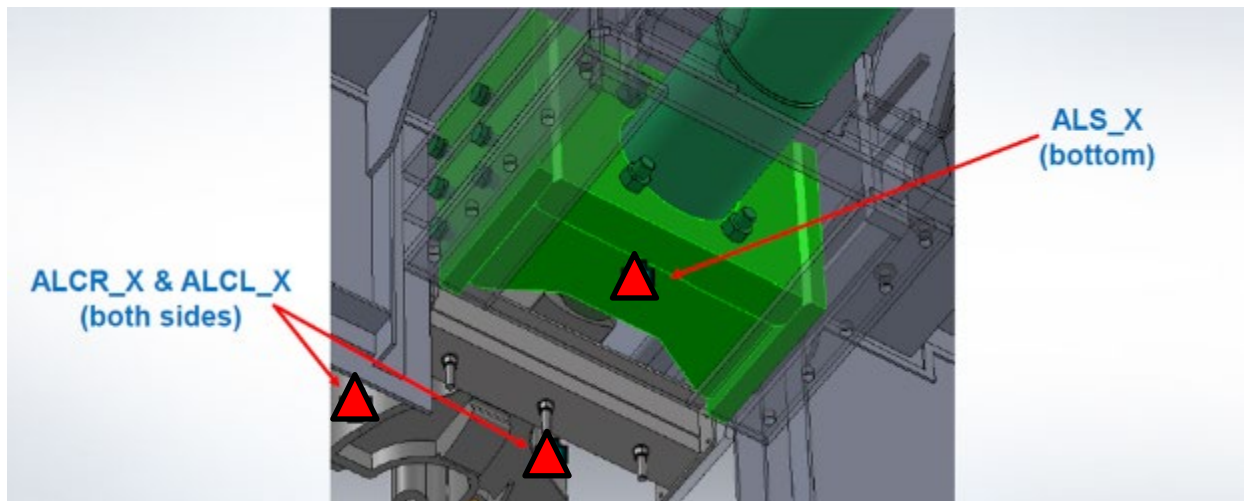

Figure 7. Accelerometer Locations on F40 Locomotive

2.3 F40 Locomotive String Potentiometers

In addition to accelerometers, the locomotive was instrumented with string potentiometers across each truck's secondary suspension. Two string potentiometers were also fitted to the coupler of the locomotive to measure the longitudinal displacement. Two more string potentiometers were fitted to the front of the locomotive underframe to measure longitudinal displacements. [Table 3](#) summarizes all string potentiometers on the locomotive. [Figure 8](#) through [Figure 13](#) show locations of the string potentiometers.

Table 3. F40 Locomotive String Potentiometers Summary

Name	Range	Location
DLLTR	+/- 5 inches	Locomotive secondary suspension, lead truck, right
DLLTL	+/- 5 inches	Locomotive secondary suspension, lead truck, left
DLTTR	+/- 5 inches	Locomotive secondary suspension, trailing truck, right
DLTTL	+/- 5 inches	Locomotive secondary suspension, trailing truck, left
DLUL	+5/-45 inches	Locomotive underframe, front – longitudinal, left
DLUR	+5/-45 inches	Locomotive underframe, front – longitudinal, right
DLC	+20/-30 inches	Locomotive coupler – longitudinal
DLS	+20/-30 inches	Locomotive sliding lug – longitudinal

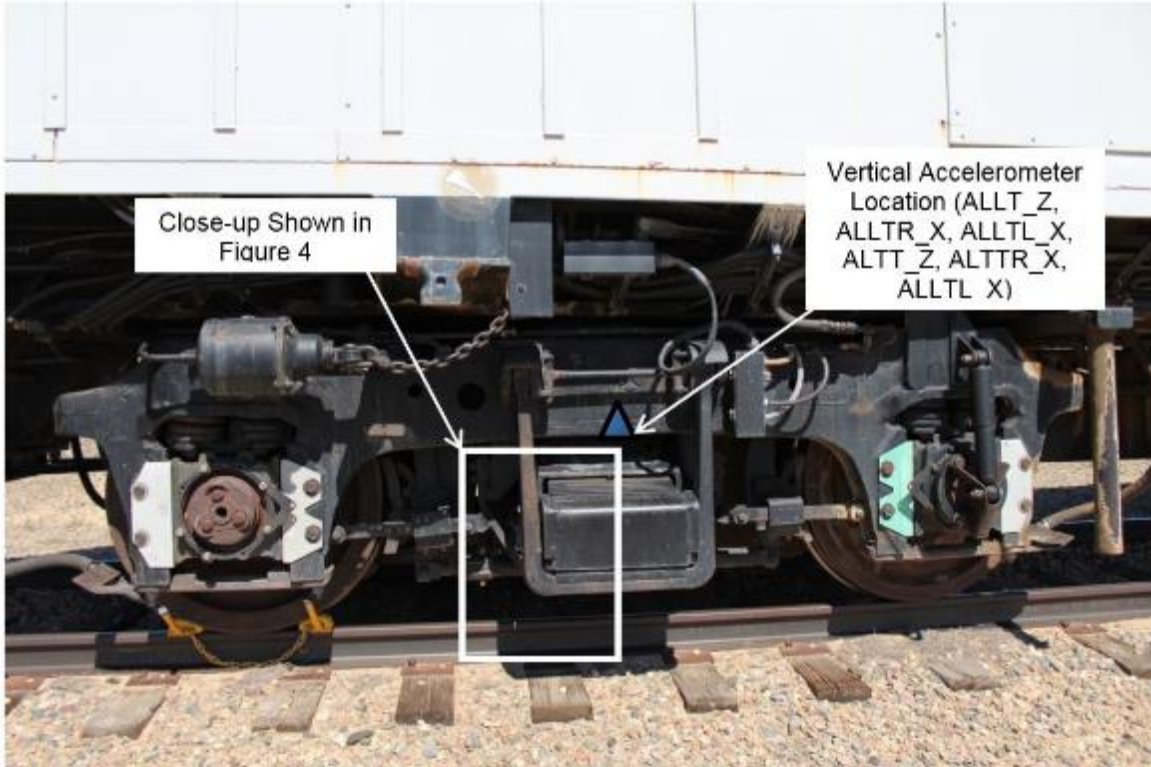

Figure 8. Locations of Accelerometers on F40 Locomotive Truck

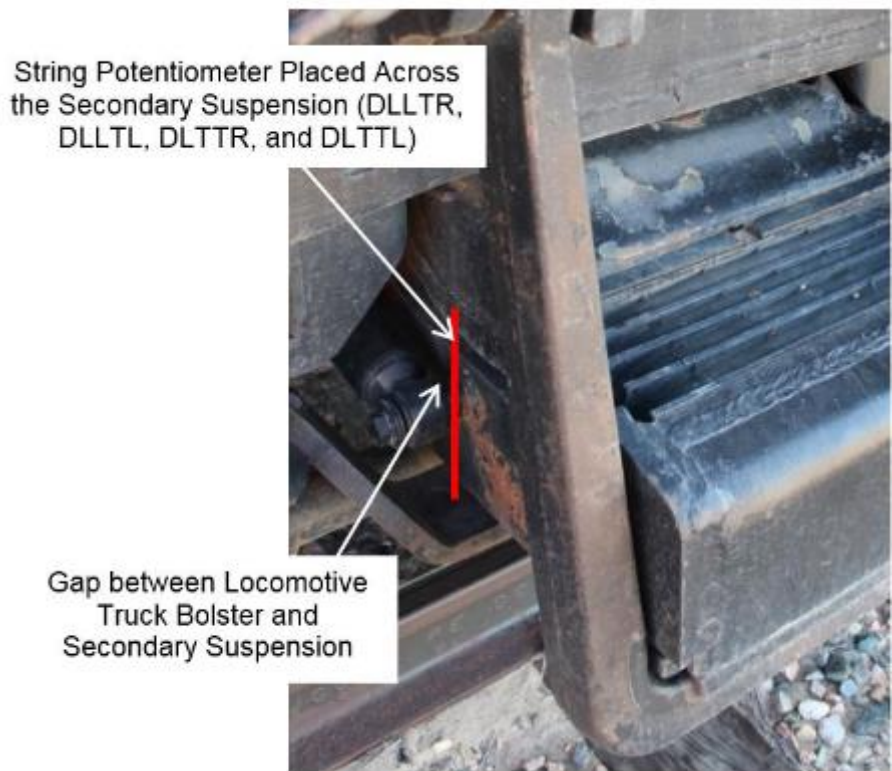

Figure 9. F40 Locomotive Truck Secondary Suspension String Potentiometers

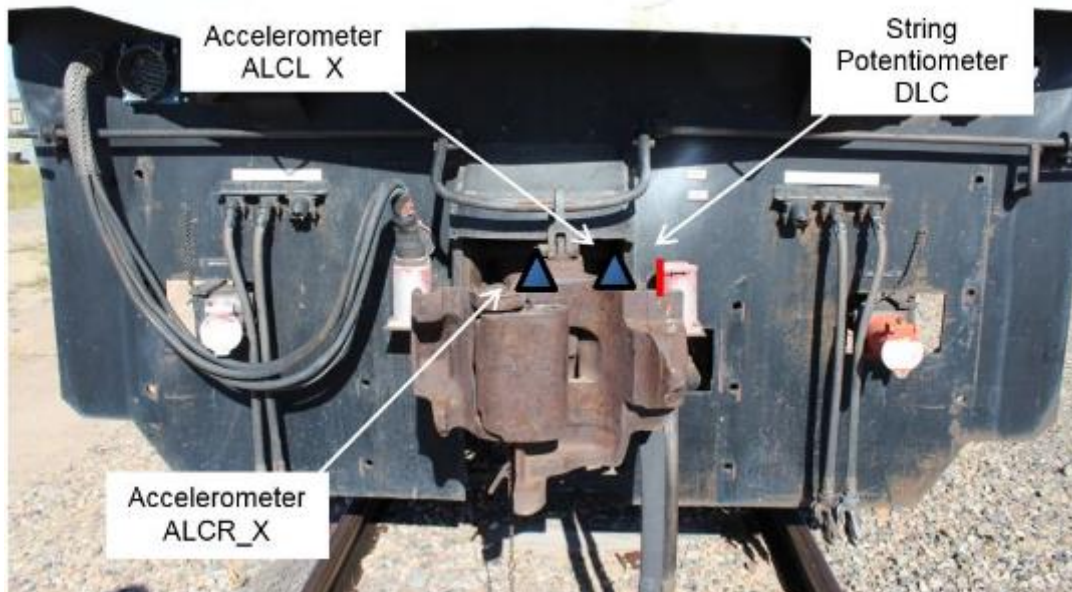

Figure 10. F40 Locomotive Coupler Instrumentation

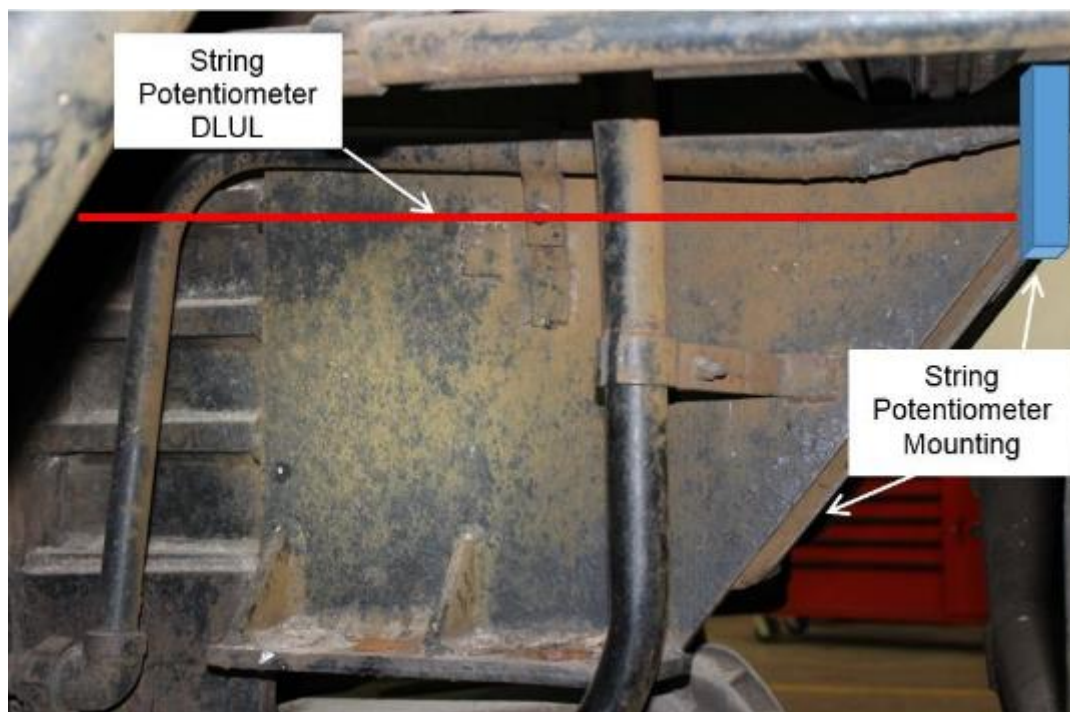

Figure 11. F40 Locomotive Underframe String Potentiometers

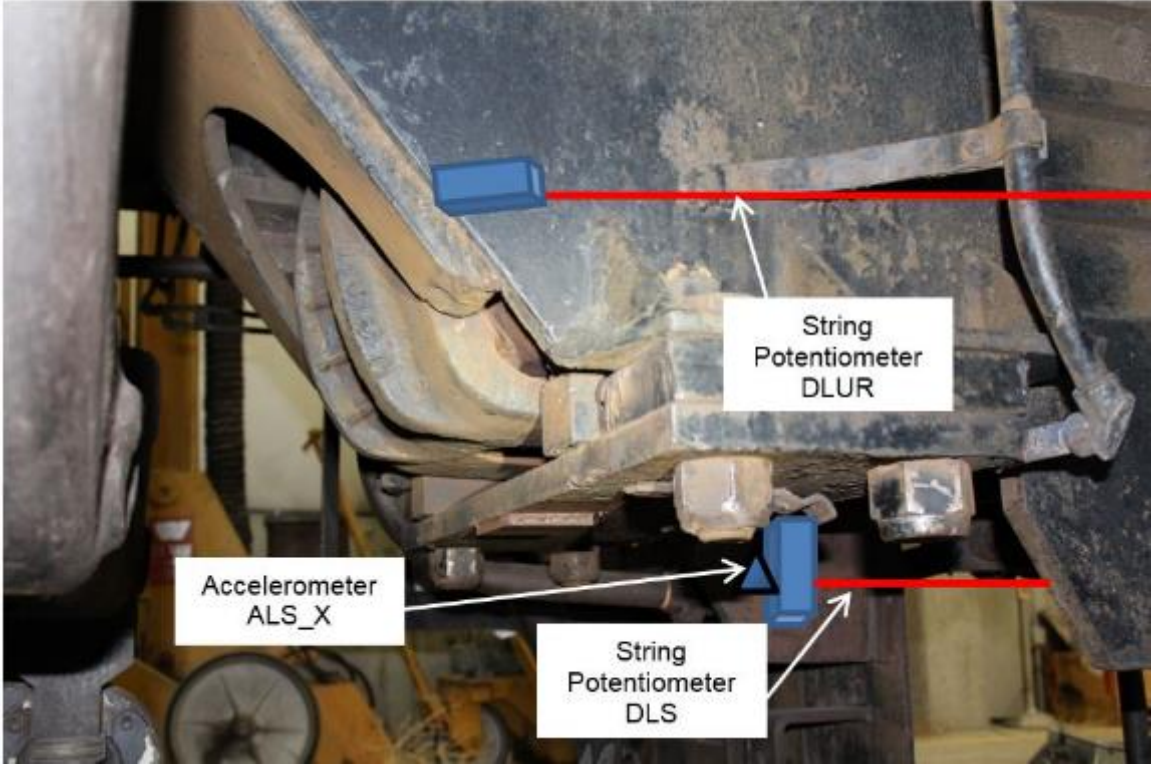

Figure 12. Right Side F40 Locomotive String Potentiometers

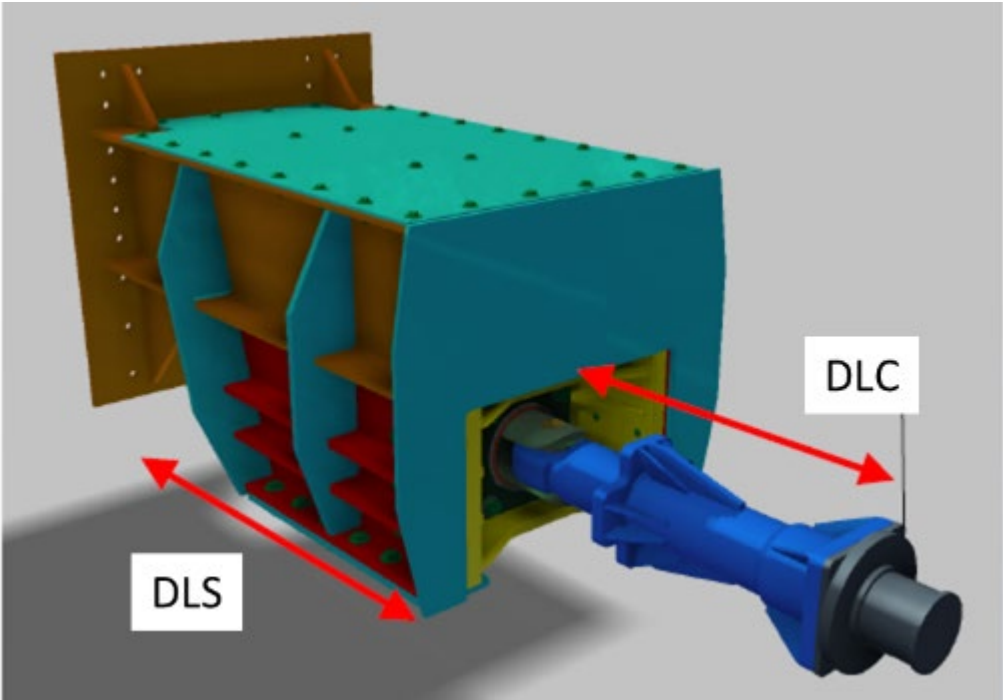

Figure 13. F40 Locomotive Coupler String Potentiometers

2.4 Locomotive Strain Gages

The F40 locomotive was instrumented with 29 strain gages on the draft gear pocket and coupler, as shown in Table 4 and Figure 14 to Figure 17.

Table 4. F40 Locomotive Strain Gage Summary

Name	Orientation	Location
SLCST	Longitudinal	Locomotive, coupler shank, above coupler carrier, top
SLCSR	Longitudinal	Locomotive, coupler shank, above coupler carrier, right
SLCRL	Longitudinal	Locomotive, coupler shank, above coupler carrier, left
SLCPR	Longitudinal	Locomotive, coupler shank at pin, right
SLCPL	Longitudinal	Locomotive, coupler shank at pin, left
SLSL1	Longitudinal	Locomotive, sliding lug 1, top right front bolt hole
SLSL2	Longitudinal	Locomotive, sliding lug 2, top right rear bolt hole
SLSL3	Longitudinal	Locomotive, sliding lug 3, bottom right front bolt hole
SLSL4	Longitudinal	Locomotive, sliding lug 4, bottom right rear bolt hole
SLSL5	Longitudinal	Locomotive, sliding lug 5, top left front bolt hole
SLSL6	Longitudinal	Locomotive, sliding lug 6, top left rear bolt hole
SLSL7	Longitudinal	Locomotive, sliding lug 7, bottom left front bolt hole
SLSL8	Longitudinal	Locomotive, sliding lug 8, bottom left rear bolt hole
SLDP1	Longitudinal	Locomotive, draft pocket 1, top right front bolt hole
SLDP2	Longitudinal	Locomotive, draft pocket 2, top right rear bolt hole
SLDP3	Longitudinal	Locomotive, draft pocket 3, bottom right front bolt hole
SLDP4	Longitudinal	Locomotive, draft pocket 4, bottom right rear bolt hole
SLDP5	Longitudinal	Locomotive, draft pocket 5, top left front bolt hole
SLDP6	Longitudinal	Locomotive, draft pocket 6, top left rear bolt hole
SLDP7	Longitudinal	Locomotive, draft pocket 7, bottom left front bolt hole
SLDP8	Longitudinal	Locomotive, draft pocket 8, bottom left rear bolt hole
SLTDR1	Longitudinal	Locomotive, top of draft pocket, right front
SLTDR2	Longitudinal	Locomotive, top of draft pocket, right rear
SLTDL1	Longitudinal	Locomotive, top of draft pocket, left front
SLTDL2	Longitudinal	Locomotive, top of draft pocket, left rear
SLCRT	Longitudinal	Locomotive, center sill, right front
SLCRB	Longitudinal	Locomotive, center sill, right rear
SLCLT	Longitudinal	Locomotive, center sill, left front
SLCLB	Longitudinal	Locomotive, center sill, left rear

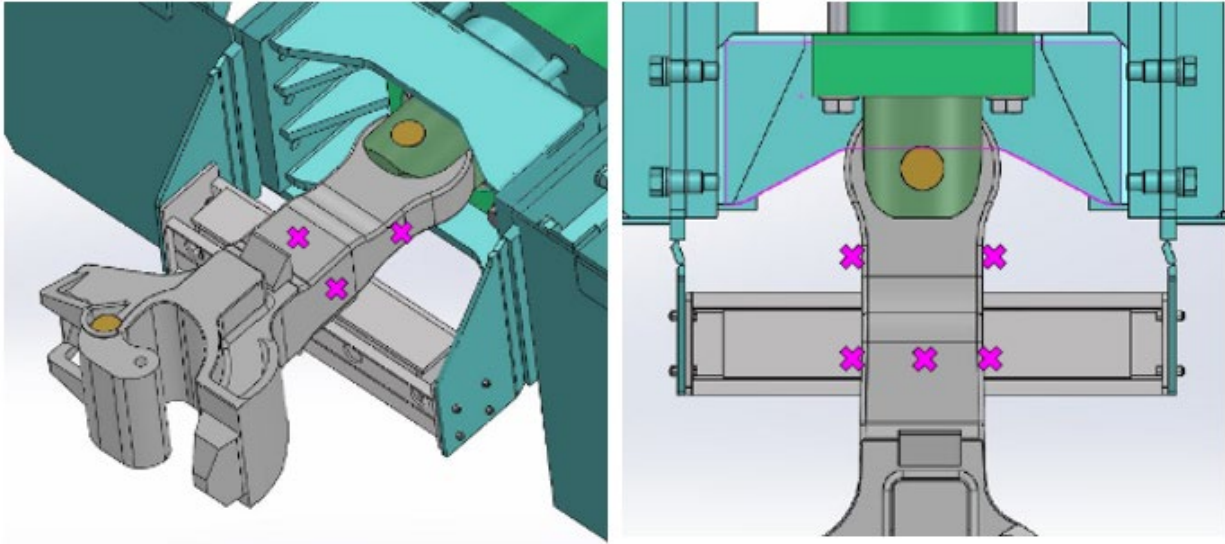

Figure 14. Strain Gage Locations on F40 Locomotive Coupler Shank

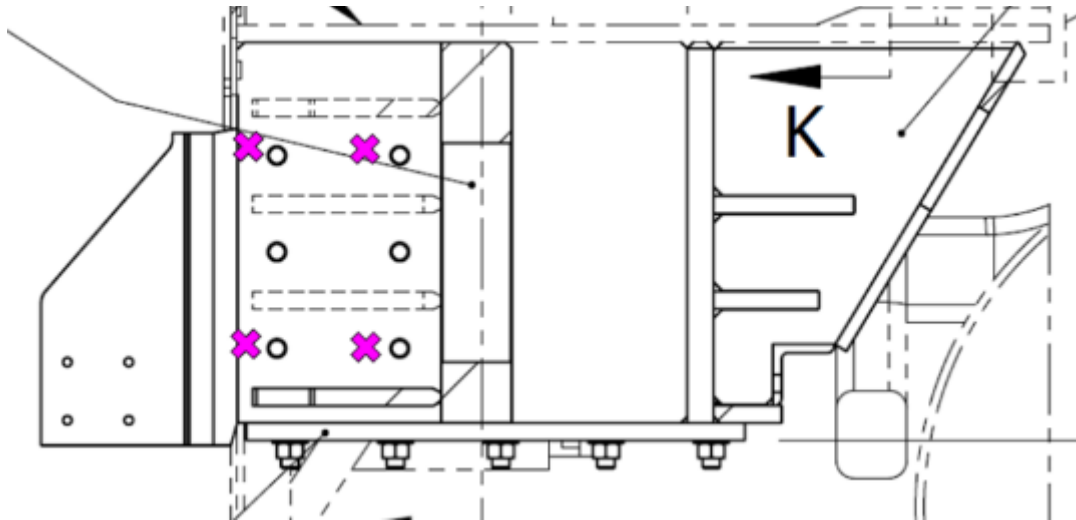

Figure 15. Strain Gage Locations on F40 Locomotive Sliding Lug

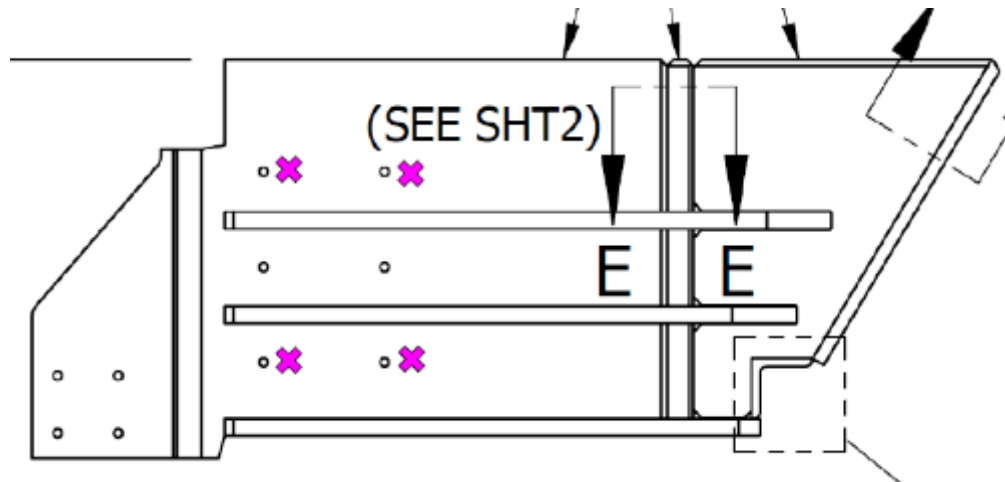

Figure 16. Strain Gage Locations on F40 Locomotive Sliding Lug

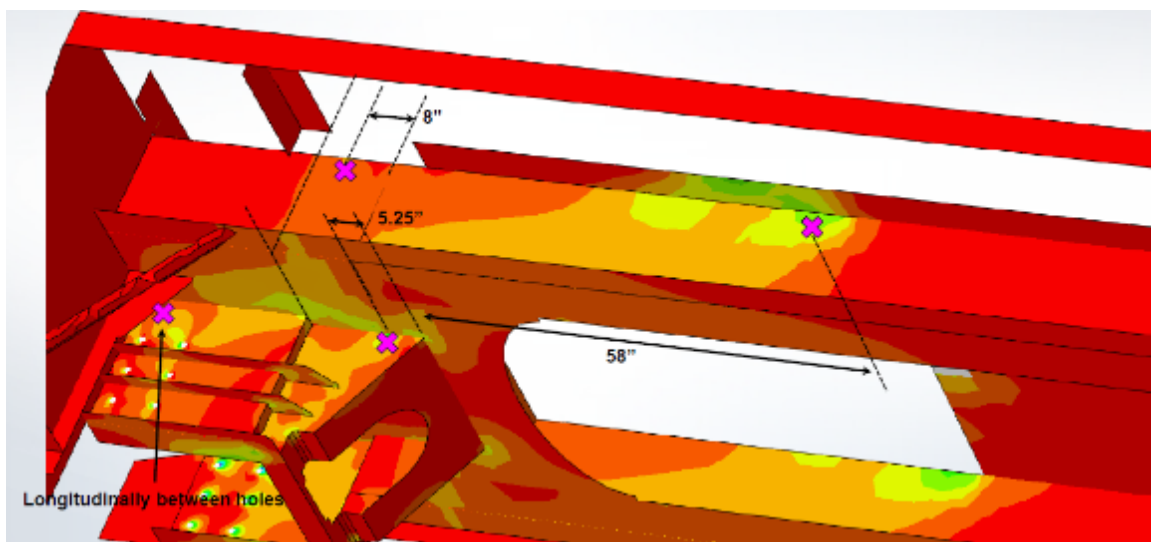

Figure 17. Strain Gage Locations on F40 Locomotive Sliding Lug

2.5 Locomotive Speed Sensors

Multiple speed sensors accurately measured the impact speed of the F40 locomotive when it was within 20 inches of the impact point. The speed trap was a reflector-based sensor. It used ground-based reflectors separated by a known distance and a vehicle-based light sensor that triggered as the locomotive passed over the reflectors. The last reflector was within 10 inches of the impact point. The time interval between passing the reflectors was recorded, and speed was calculated from distance and time. Backup speed measurements were made with a handheld radar gun.

2.6 M1 Passenger Car Accelerometers

Tri-axial accelerometers were placed at the two ends and the center along the car centerline. The M1 had longitudinal and vertical accelerometers placed on the left and right side of its

underframe at its center. Each truck was fitted with a vertical accelerometer and two longitudinal accelerometers, right and left. The typical scale factor calibration error for the accelerometers used was 2 percent. The accelerometers are summarized in Table 5 and Figure 18.

Table 5. M1 Passenger Car Instrumentation – Accelerometers

Name	Range	Location
AMLE_X	400 g	M1 car, lead end, center – longitudinal
AMLE_Y	200 g	M1 car, lead end, center – lateral
AMLE_Z	200 g	M1 car, lead end, center – vertical
AMUC_X	200 g	M1 car, underframe center – longitudinal
AMUC_Y	200 g	M1 car, underframe center – lateral
AMUC_Z	200 g	M1 car, underframe center – vertical
AMUCR_X	200 g	M1 car, underframe center right – longitudinal
AMUCR_Z	200 g	M1 car, underframe center right – vertical
AMUCL_X	200 g	M1 car, underframe center left – longitudinal
AMUCL_Z	200 g	M1 car, underframe center left – vertical
AMTEC_X	200 g	M1 car, trailing end, center – longitudinal
AMTEC_Y	200 g	M1 car, trailing end, center – lateral
AMTEC_Z	200 g	M1 car, trailing end, center – vertical
AMLT_Z	400 g	M1 car, lead truck – vertical
AMTT_Z	400 g	M1 car, trailing truck
AMCR_X	5000 g	M1 car coupler, right
AMCL_X	5000 g	M1 car coupler, left

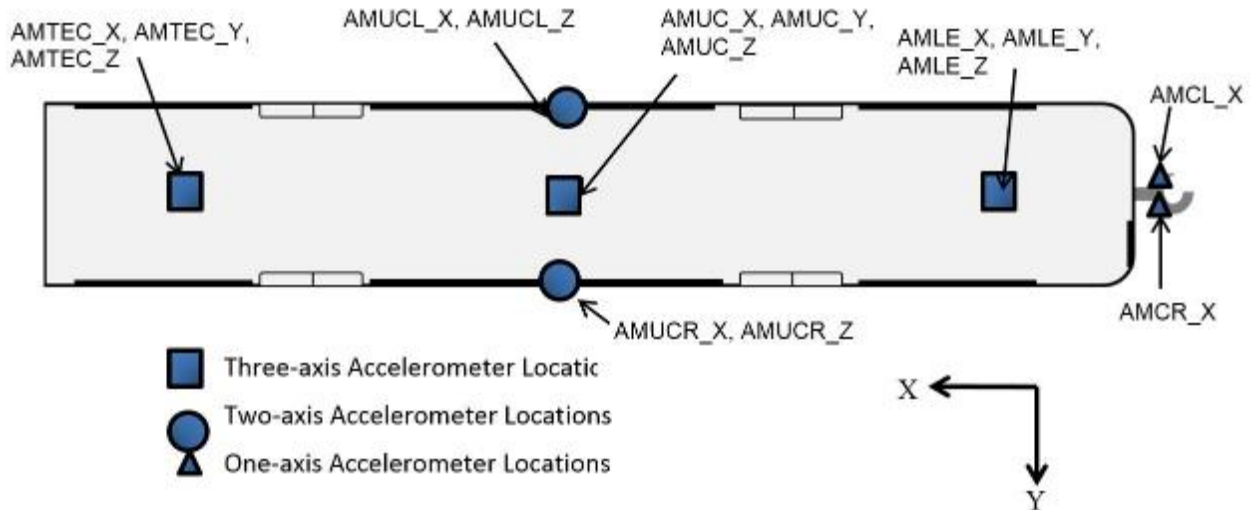

Figure 18. Accelerometer Locations on M1 Passenger Car

2.7 M1 Passenger Car String Potentiometers

In addition to these accelerometers, the M1 passenger car was fitted with string potentiometers across each truck's secondary suspension. The underframe of the car was also fitted with two string potentiometers near the coupler to measure longitudinal displacement. Table 6 summarizes all string potentiometers on the M1 passenger car, shown in Figure 19 to Figure 22.

Table 6. M1 Passenger Car Instrumentation – String Potentiometers

Name	Range	Location
DMLTR	+/- 5 inches	M1 car secondary suspension, lead truck, right
DMLTL	+/- 5 inches	M1 car secondary suspension, lead truck, left
DMTTR	+/- 5 inches	M1 car secondary suspension, trailing truck, right
DMTTL	+/- 5 inches	M1 car secondary suspension, trailing truck, left
DMUL	+5/-45 inches	M1 car underframe, front left - longitudinal
DMUR	+5/-45 inches	M1 car underframe, front right - longitudinal
DMC X	+20/-30 inches	M1 car coupler – longitudinal



Figure 19. String Potentiometer and Accelerometer on M1 Passenger Car Truck

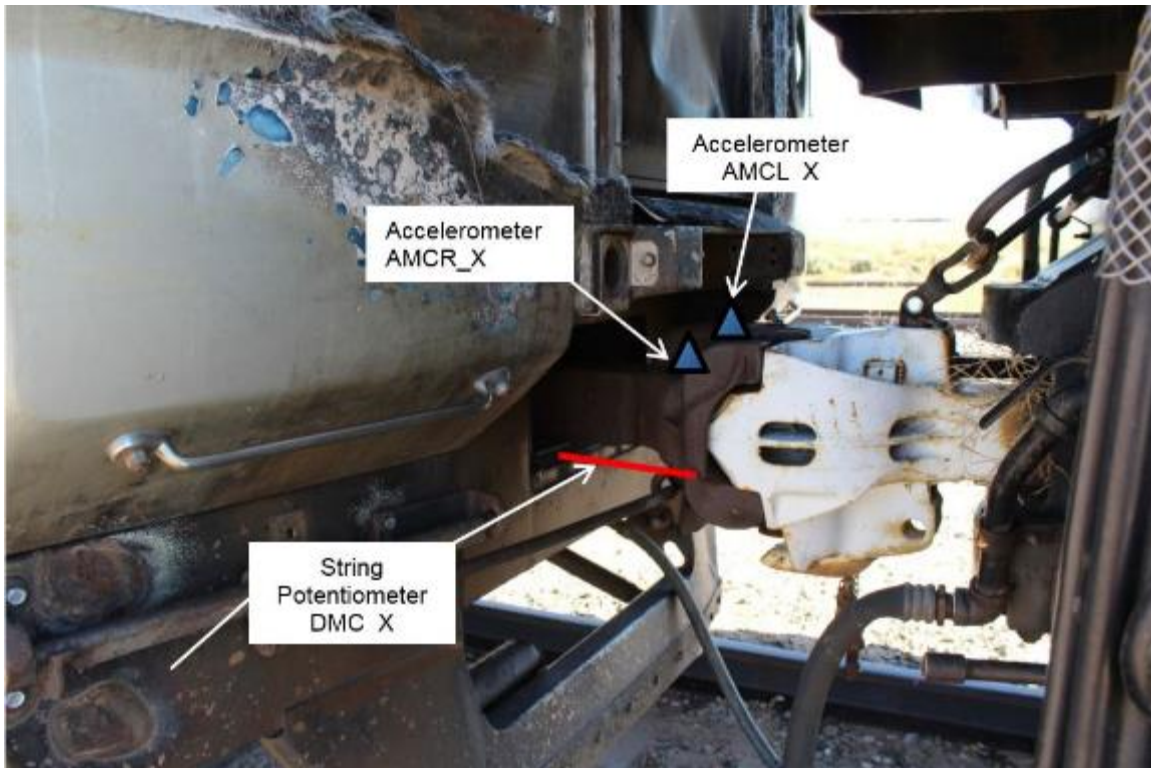

Figure 20. M1 Passenger Car Coupler Instrumentation

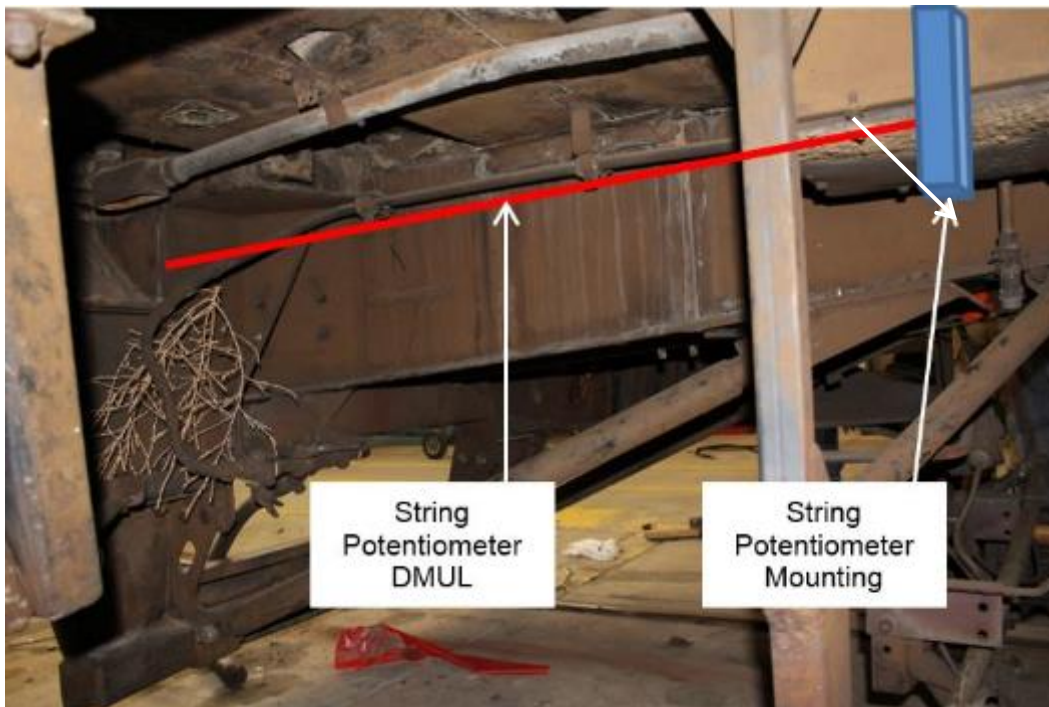

Figure 21. M1 Passenger Car Underframe String Potentiometer Left

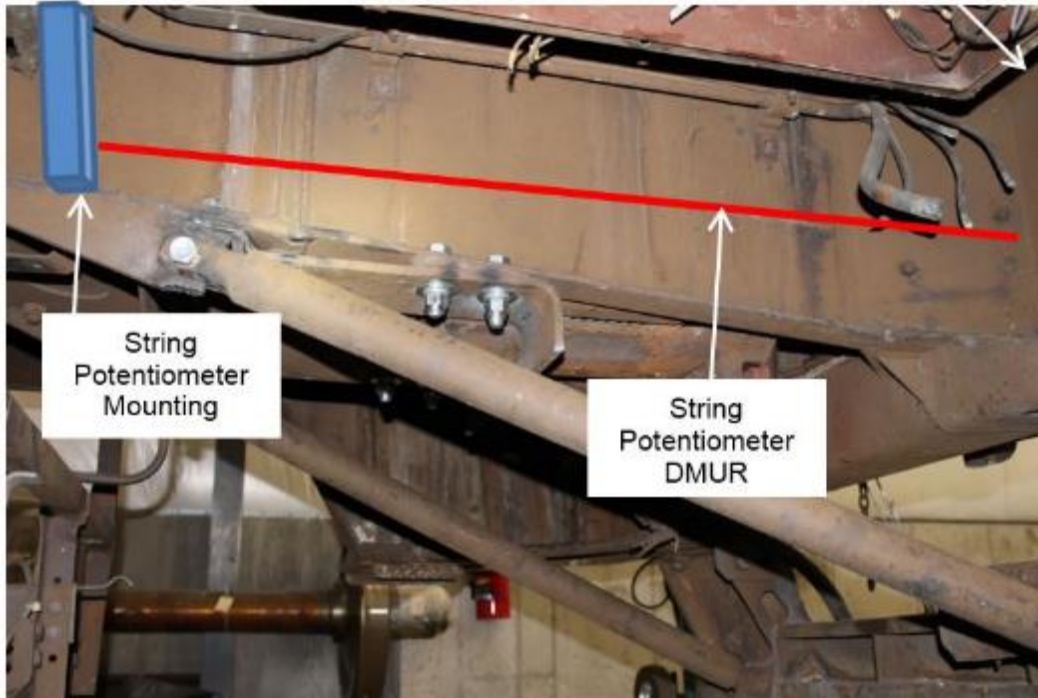

Figure 22. M1 Passenger Car Underframe String Potentiometer Right

2.8 M1 Passenger Car Strain Gages

The M1 passenger car was also fitted with 20 strain gages. [Table 7](#) summarizes all strain gages on the M1. [Figure 23](#) and [Figure 24](#) show locations of the gages.

Table 7. M1 Passenger Car Instrumentation

Name	Orientation	Location
SMDR1	Longitudinal	M1 car, draft sill, right, outboard of buff stop, top
SMDR2	Longitudinal	M1 car, draft sill, right, outboard of buff stop, bottom
SMDR3	Longitudinal	M1 car, draft sill, right, inboard of buff stop, top
SMDR4	Longitudinal	M1 car, draft sill, right, inboard of buff stop, bottom
SMDL1	Longitudinal	M1 car, draft sill, left, outboard of buff stop, top
SMDL2	Longitudinal	M1 car, draft sill, left, outboard of buff stop, bottom
SMDL3	Longitudinal	M1 car, draft sill, left, inboard of buff stop, top
SMDL4	Longitudinal	M1 car, draft sill, left, inboard of buff stop, bottom
SMCR1	Longitudinal	M1 car, center sill transition, right, top
SMCR2	Longitudinal	M1 car, center sill transition, right, bottom
SMCL1	Longitudinal	M1 car, center sill transition, left, top
SMCL2	Longitudinal	M1 car, center sill transition, left, bottom
SMSLFO	Longitudinal	M1 car, left side sill, front truck, outboard
SMSLFI	Longitudinal	M1 car, left side sill, front truck, inboard
SMSLTO	Longitudinal	M1 car, left side sill, trailing truck, outboard
SMSLTI	Longitudinal	M1 car, left side sill, trailing truck, inboard
SMSRFO	Longitudinal	M1 car, right side sill, front truck, outboard
SMSRFI	Longitudinal	M1 car, right side sill, front truck, inboard
SMSRTO	Longitudinal	M1 car, right side sill, trailing truck, outboard
SMSRTI	Longitudinal	M1 car, right side sill, trailing truck, inboard

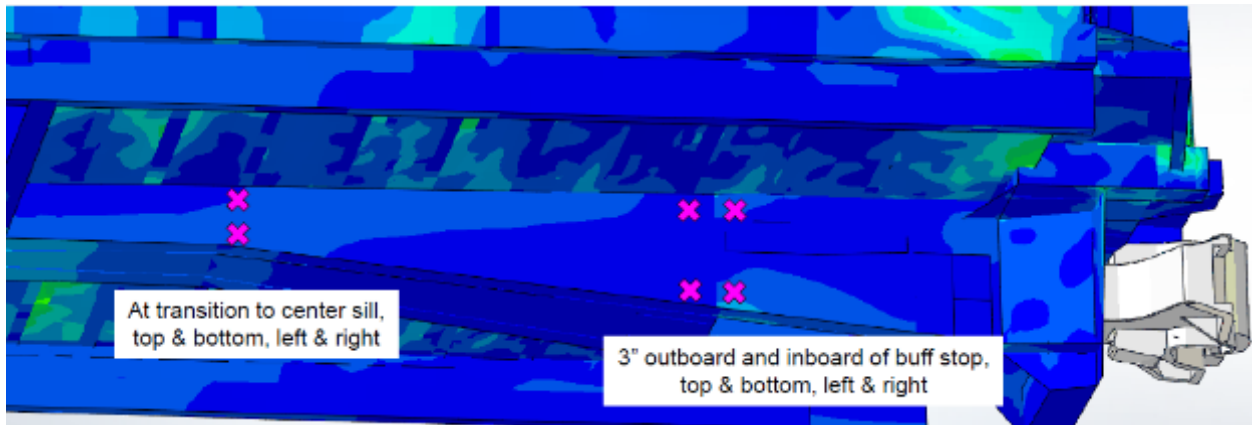

Figure 23. Strain Gage Locations on M1 Passenger Car Draft Sill and Center Sill



Figure 24. Strain Gage Locations on M1 Passenger Car

2.9 Real-Time and High-Speed Photography

Six high-speed and five real-time high-definition video cameras documented each impact event. [Figure 25](#) and [Figure 26](#) show schematics of the setup positions of the high-speed and high-definition cameras. All high-speed test cameras were crashworthy and rated for peak accelerations of 100 g. Final alignment and sighting of the cameras was done when the F40 and M1 were positioned at the impact point prior to the start of each test. Two flash lights were installed on both the F40 and the M1, and they were triggered at the same time as the data acquisition systems. Flashes were visible from the high-speed cameras and were used to confirm the time of trigger and to evaluate any trigger time discrepancies between both vehicles.

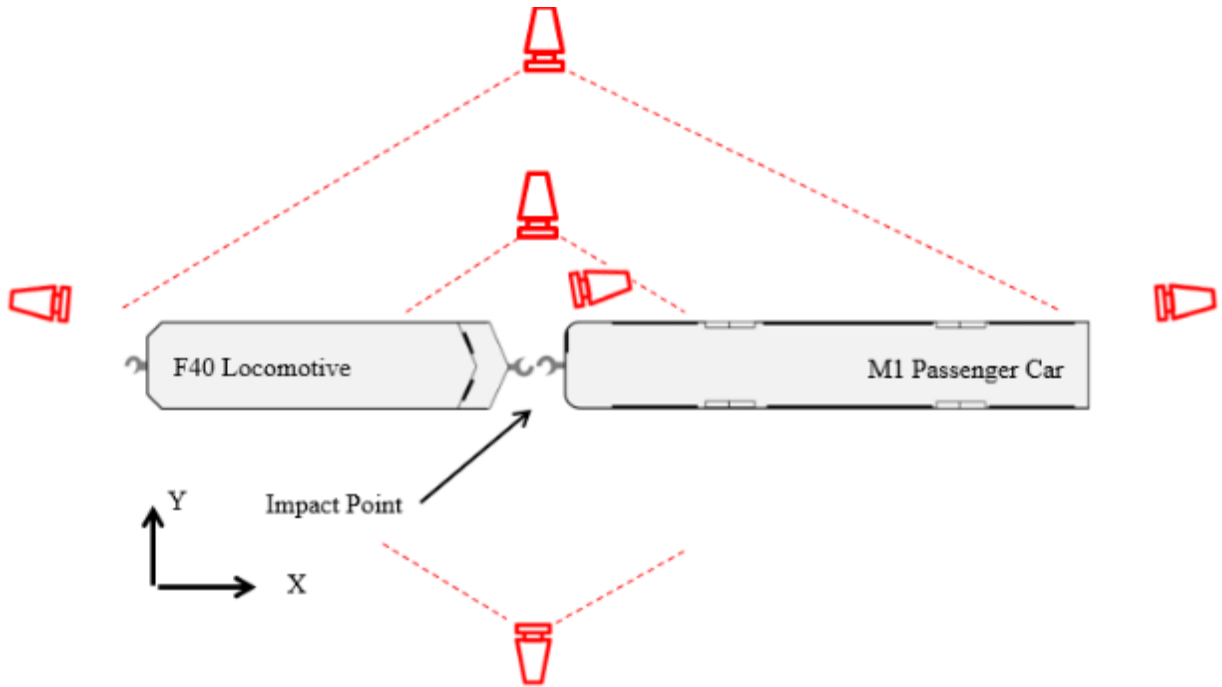

Figure 25. High-Speed Camera Locations

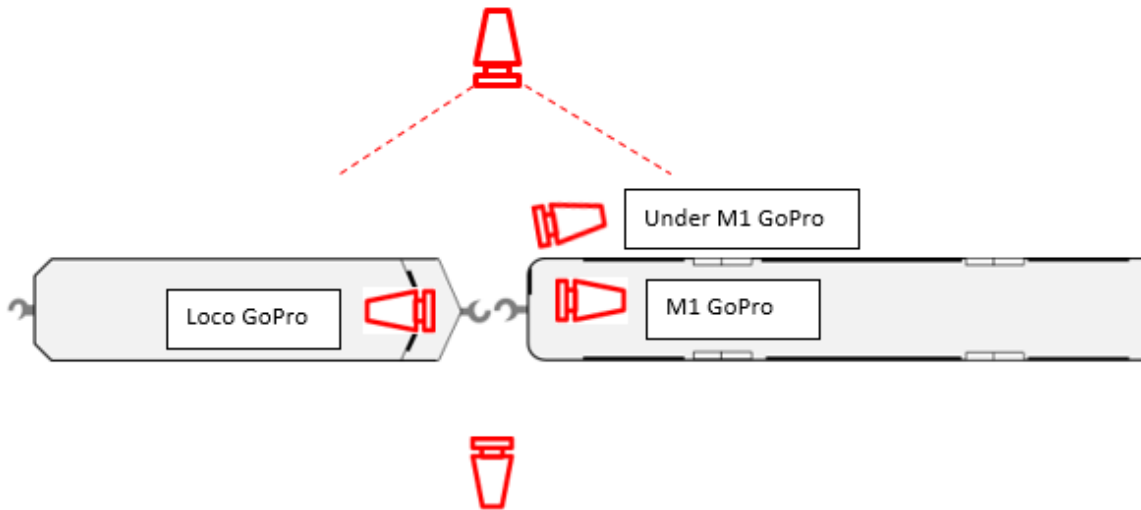

Figure 26. High-Definition Camera Locations

2.10 Data Acquisition

A set of 8-channel battery-powered onboard data acquisition systems recorded data from instrumentation mounted on both the F40 and the M1. These systems provided excitation to the instrumentation, analog anti-aliasing filtering of the signals, analog-to-digital conversion, and recording of each data stream.

The data acquisition systems were GMH Engineering Data BRICK Model III units. Data acquisition was in compliance with the appropriate sections of SAE J211. Data from each channel were anti-alias filtered at 1,735 Hz, then sampled and recorded at 12,800 Hz. Data recorded on the Data BRICKS were synchronized to time zero at initial impact. The time reference came from closure of the tape switches on the front of the test vehicle. Each Data BRICK was ruggedized for shock loading up to at least 100 g. Onboard battery power was provided by GMH Engineering 1.7 amp-hour 14.4 volt NiCad packs. Tape Switches, Inc., model 1201-131-A tape switches provided event initial contact.

Software in the Data BRICK was used to determine zero levels and calibration factors rather than relying on set gains and expecting no zero drift. The Data BRICKS were set to record 1 second of data before initial impact and 7 seconds of data after initial impact.

3. Results

As described in Section 1, this test program included a series of coupling impacts between an F40 locomotive and an M1 passenger car, performed on October 3 and 4, 2017. The target impact speeds were 2, 4, 6, 7, 8, and 9 mph. The M1 passenger car's hand brakes were applied. Ambient conditions for all test runs are summarized in [Table 8](#).

Table 8. Summary of Ambient Conditions

Test Run	Time	Wind Speed (mph)	Gust Speed (mph)	Wind Direction	Temperature (F)
2 mph	10:10 a.m.	6	14	E-NE	51.1
4 mph	11:15 a.m.	3	14	E-SE	53.3
6 mph	2:20 p.m.	7	14	S-SE	59.3
7 mph	9:45 a.m.	8	14	S-SE	54
8 mph	2:20 p.m.	5	16	E	57.4
9 mph	4:00 p.m.	4	16	E	59

3.1 Test Details

The actual impact speeds for all test runs are shown in [Table 9](#), as well as the approximate impact forces and energy levels based on accelerometer data. The last column reports the travel distance of both the locomotive and M1 passenger car from the impact point to the point where both vehicles came to a complete stop. The distance measured after the third test seemed large and did not follow the trend. This could possibly have been because the hand brake on the M1 car was not sufficiently tightened or because of an erroneous measurement.

Table 9. Summary of Test Results

Test	Target Impact Speed (mph)	Actual Impact Speed (mph)	Approximate Impact Force (lbs)	Approximate Impact Energy (ft-lb)	Travel Distance after Impact (feet)
1	2	1.8	80,000	25,000	11.0
2	4	3.74	250,000	110,000	37.5
3	6	5.66	450,000	250,000	90.0
4	7	6.84	500,000	360,000	83.8
5	8	7.63	600,000	450,000	118.1
6	9	8.85	680,000	600,000	135.7

3.2 Measured Data

The data collected was processed for zero offset corrections and filtering. To ensure the data plotted and analyzed contained only impact-related information and excluded electronic offsets or steady biases, an offset adjustment procedure was developed. The offset was determined by averaging the data collected before the impact. The offset was then subtracted from the entire dataset for each channel. This post-test offset adjustment was independent of the pre-test offset adjustment made by the data acquisition system.

The post-test filtering of the data was accomplished using a phaseless 4-pole digital filter algorithm consistent with SAE J211 requirements [1]. A 60 Hz channel frequency class filter was applied to obtain the filtered acceleration data shown in this report. A brief summary of the measured data is provided in this section. [Appendices B](#) through [G](#) contain plots of the time histories of the filtered data from all transducers for all tests.

3.2.1 Accelerations

Multiple accelerometers were used on the locomotive to capture its longitudinal acceleration. The locomotive's acceleration was used to derive the impact energy and contact force between the F40 locomotive and the M1 passenger car. The average longitudinal acceleration was obtained by averaging the accelerations measured by the longitudinal accelerometers, both on the M1 and the F40. Since there was a minor time delay in some of the channels on the locomotive, only the accelerations that were in phase were averaged. Any outliers were removed from the average.

The average longitudinal acceleration time history from the locomotive accelerometers is shown in [Figure 27](#) to [Figure 32](#). Impact accelerations are shown as positive in these graphs; however, during an impact the locomotive was accelerated in the negative X direction based on the established coordinate system. During the 6, 7, 8, and 9 mph test runs, the locomotive and the passenger car failed to couple.

All the other acceleration data results for each speed are reported in [Appendices B, C, D, E, F,](#) and [G](#) at the end of the report.

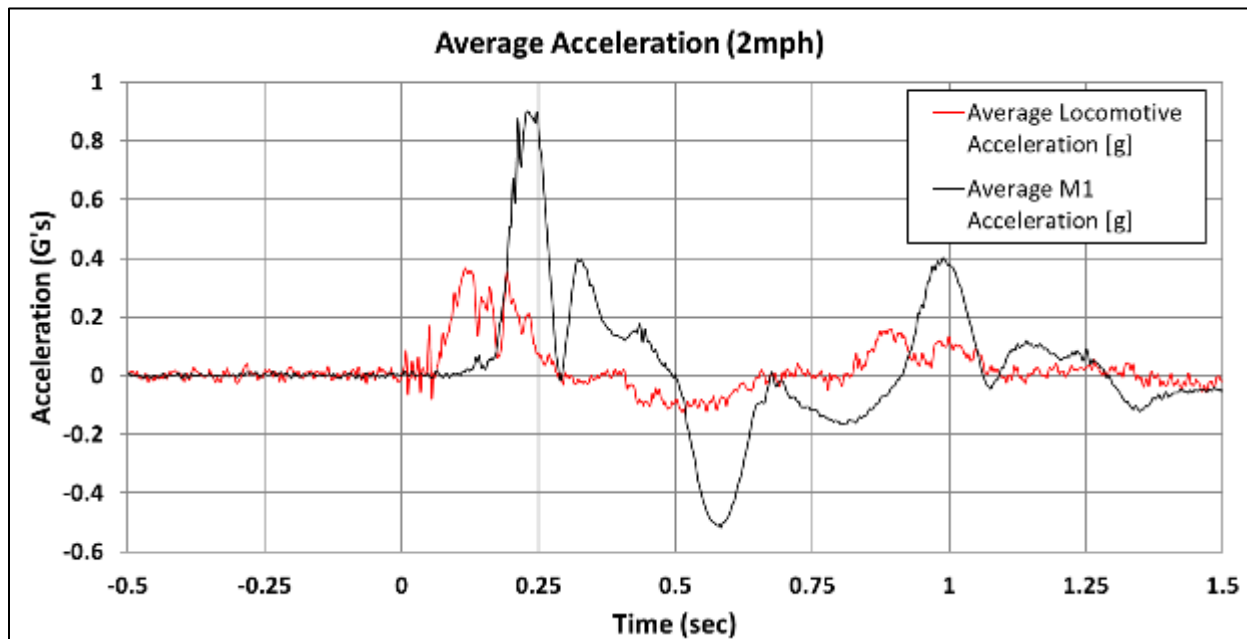

Figure 27. Longitudinal Average Acceleration at 2 mph Impact

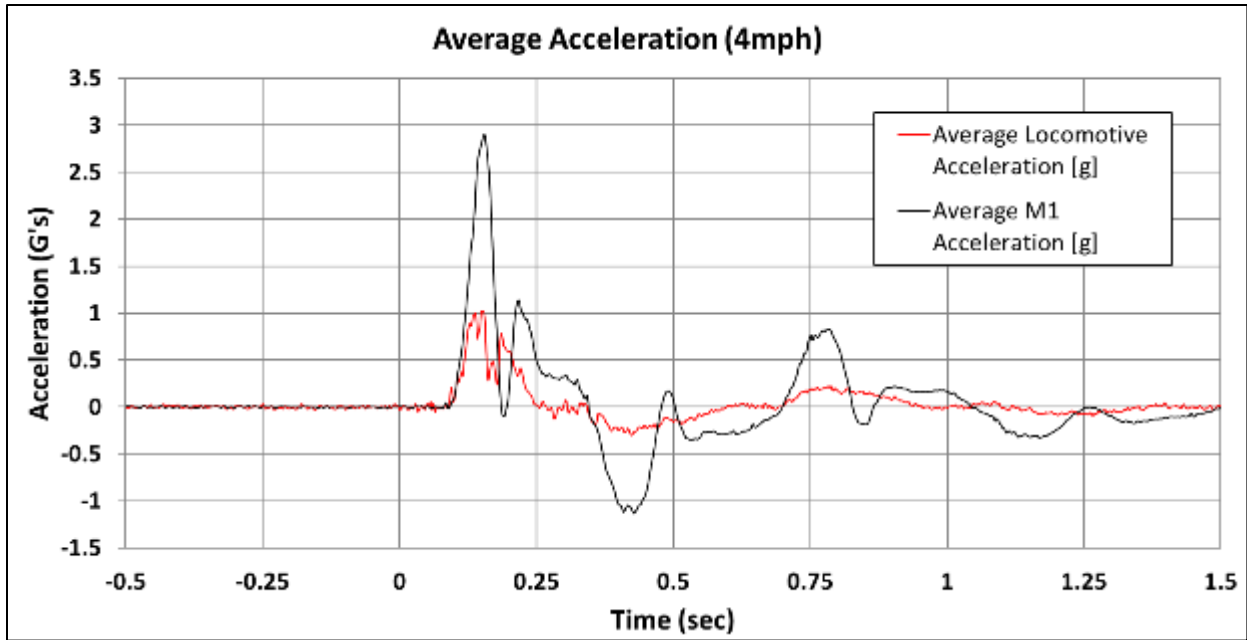

Figure 28. Longitudinal Average Accelerations at 4 mph Impact

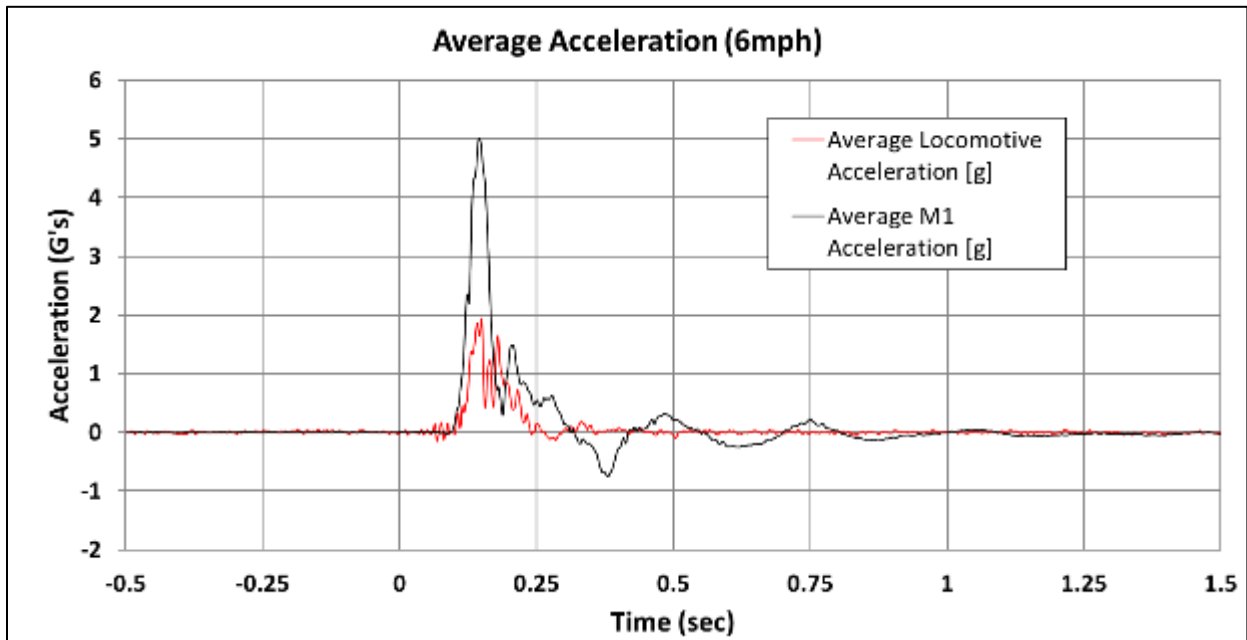

Figure 29. Longitudinal Average Accelerations at 6 mph Impact

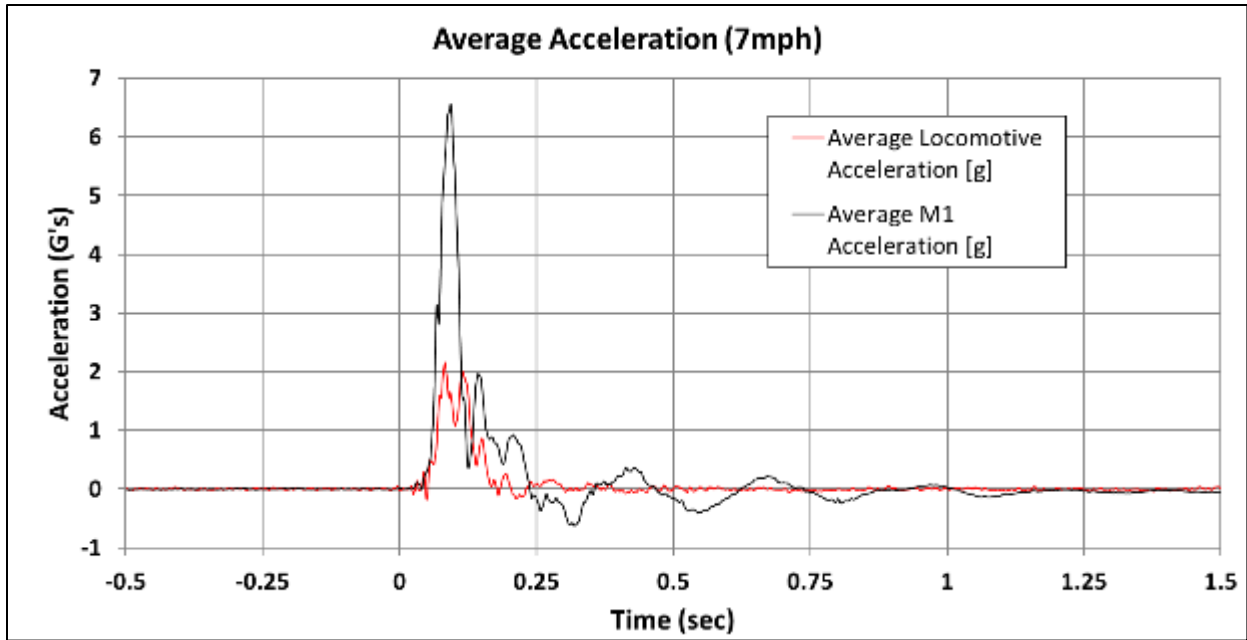

Figure 30. Longitudinal Average Accelerations at 7 mph Impact

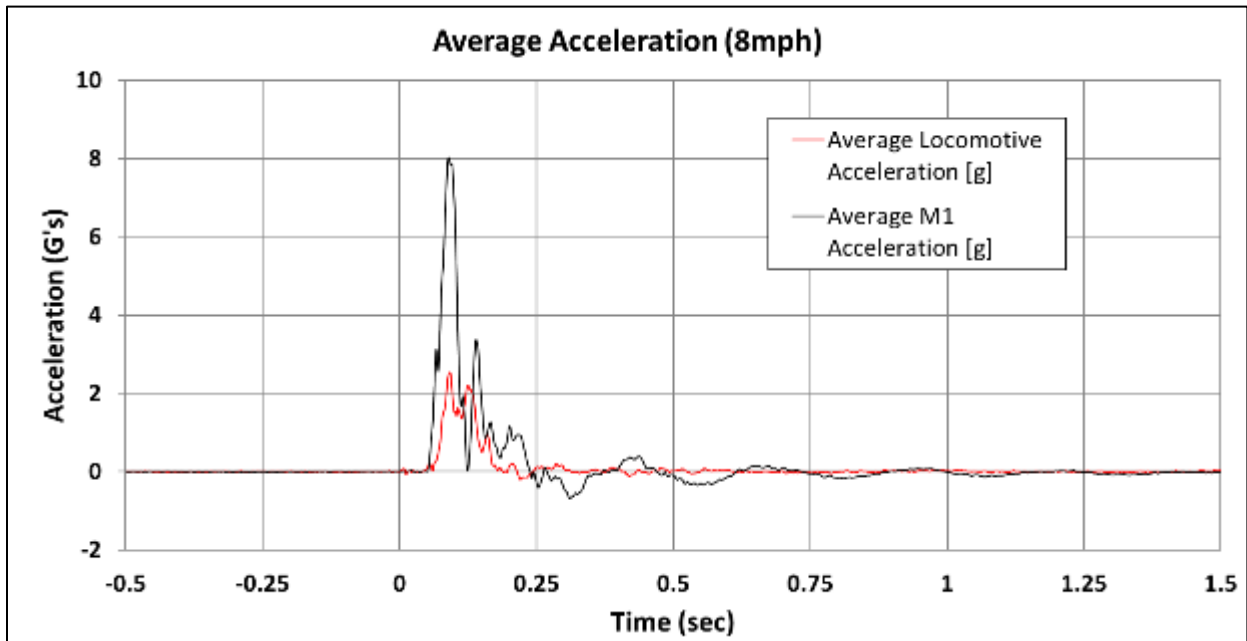

Figure 31. Longitudinal Average Accelerations at 8 mph Impact

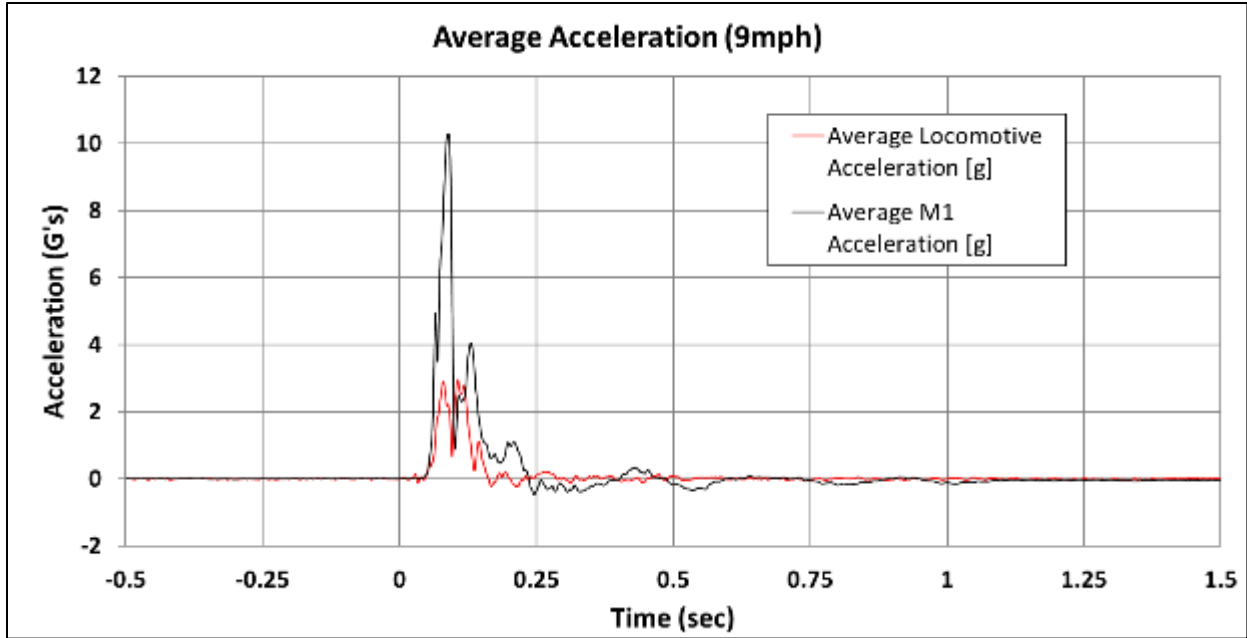

Figure 32. Longitudinal Average Accelerations at 9 mph Impact

3.2.2 Displacements

The displacement of the couplers is shown in [Figure 33](#) to [Figure 38](#) for each impact speed. The DMC_X curves represent the response of the M1 coupler; the DLC_X curves represent that of the locomotive coupler. According to the coordinate system, the coupler moving into the draft pocket was reported as a positive displacement for the F40 locomotive, and negative for the M1 passenger car. During the first two tests (2 mph and 4 mph), the two vehicles coupled. Similar to acceleration, the locomotive coupler displacement curve was offset in time for the first impact. The time offset was corrected during data post-processing to match the data recording starting time on both vehicles. The tests in which the cars did not couple should have shown a displacement on both couplers approaching the initial position. The difference between the initial position of the coupler measured by the string potentiometers and its position after the initial impact was due to the coupler's lateral shift.

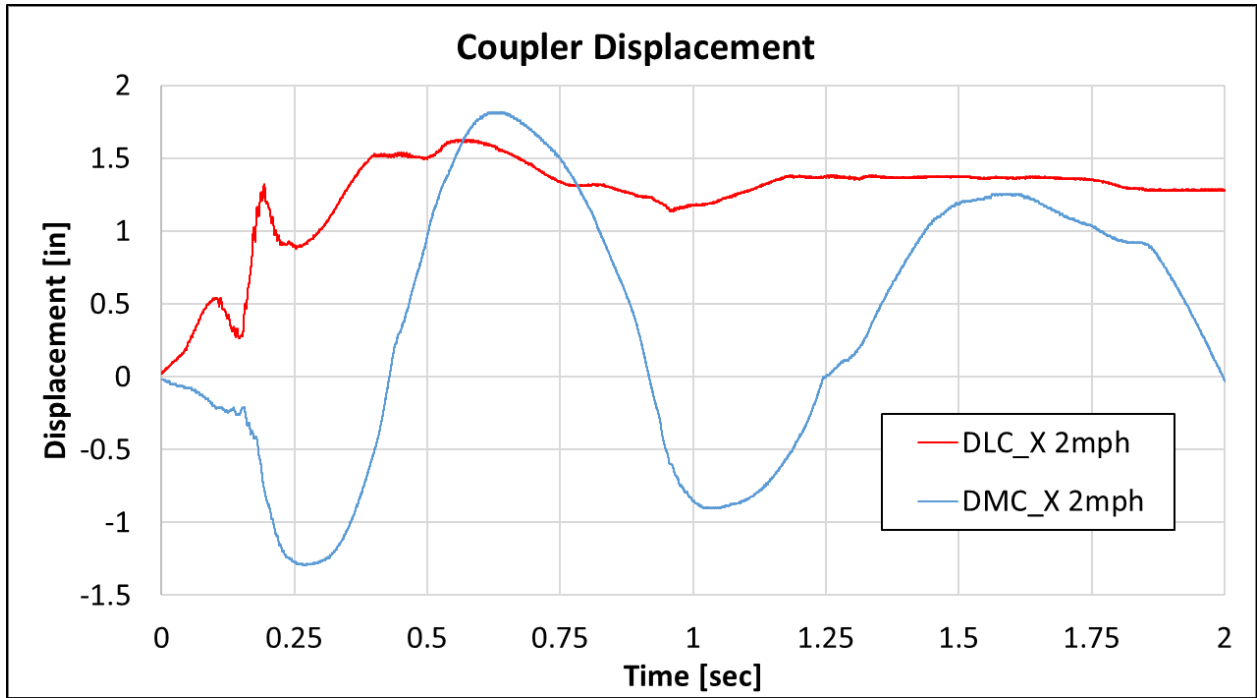

Figure 33. Couplers Displacement at 2 mph

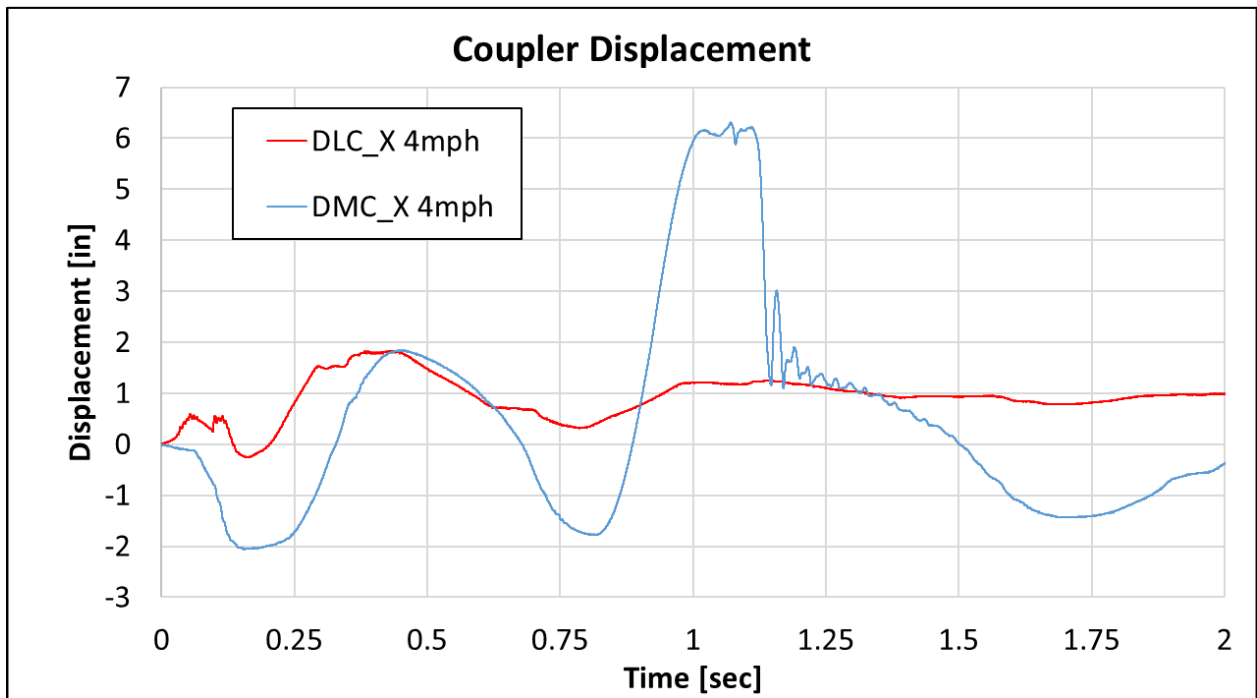

Figure 34. Couplers Displacement at 4 mph

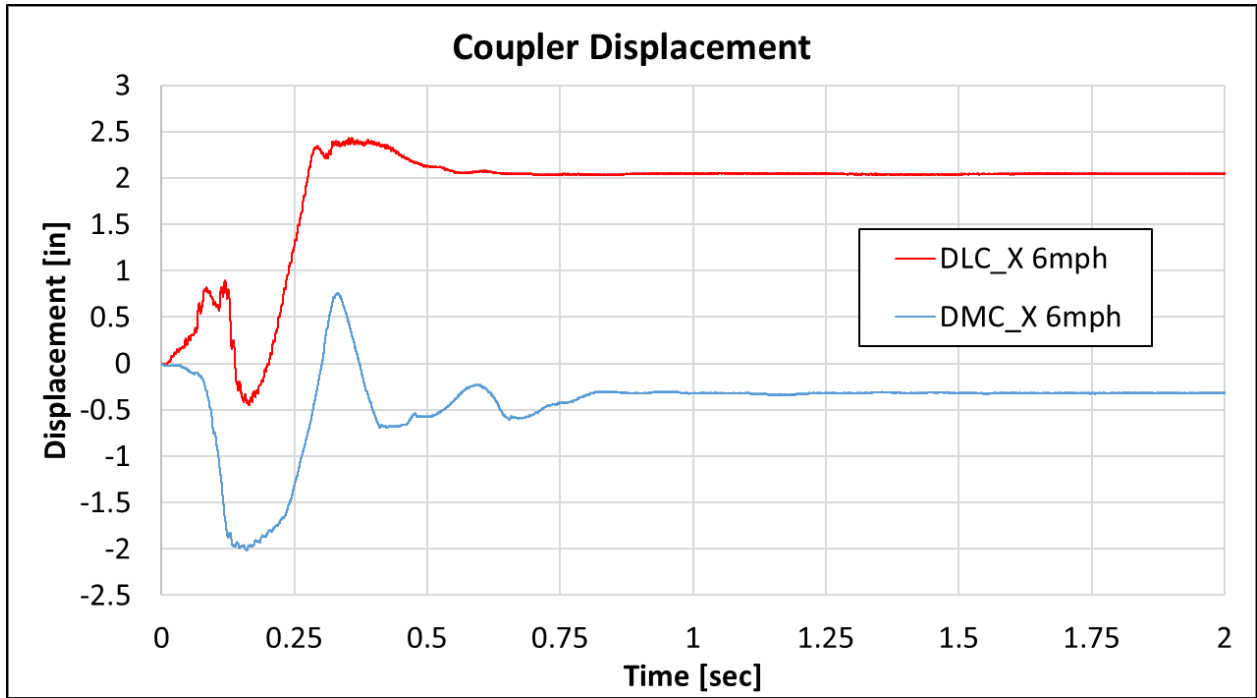

Figure 35. Couplers Displacement at 6 mph

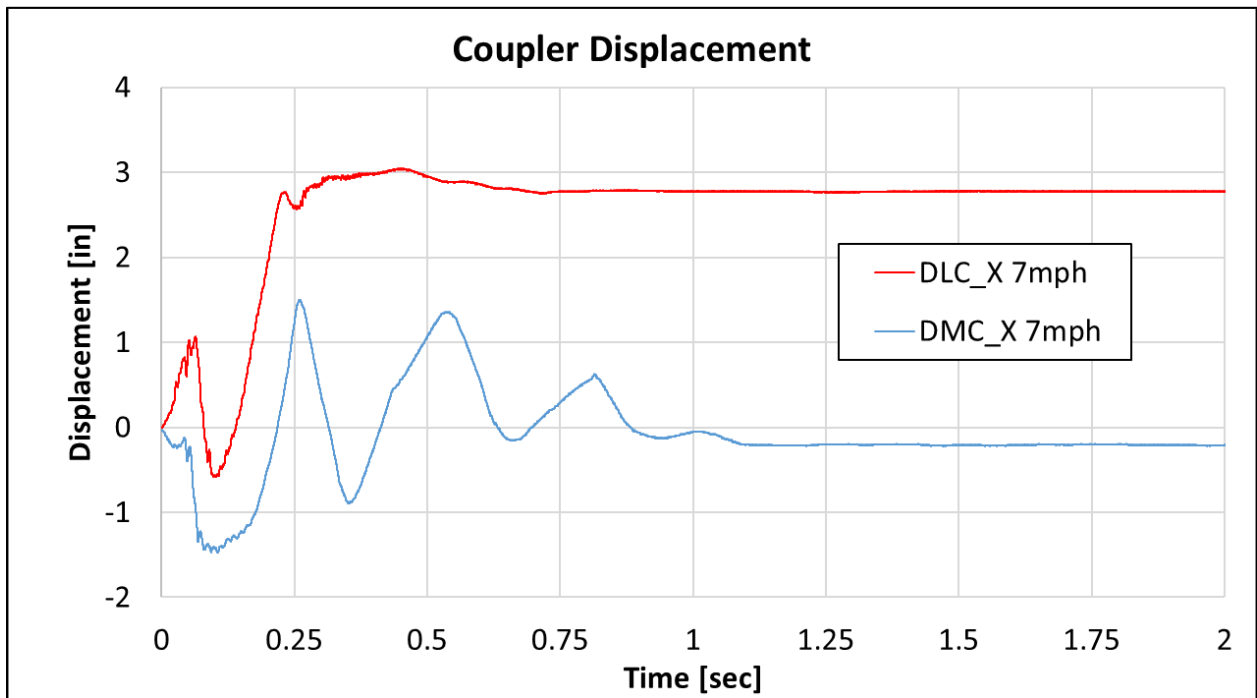

Figure 36. Couplers Displacement at 7 mph

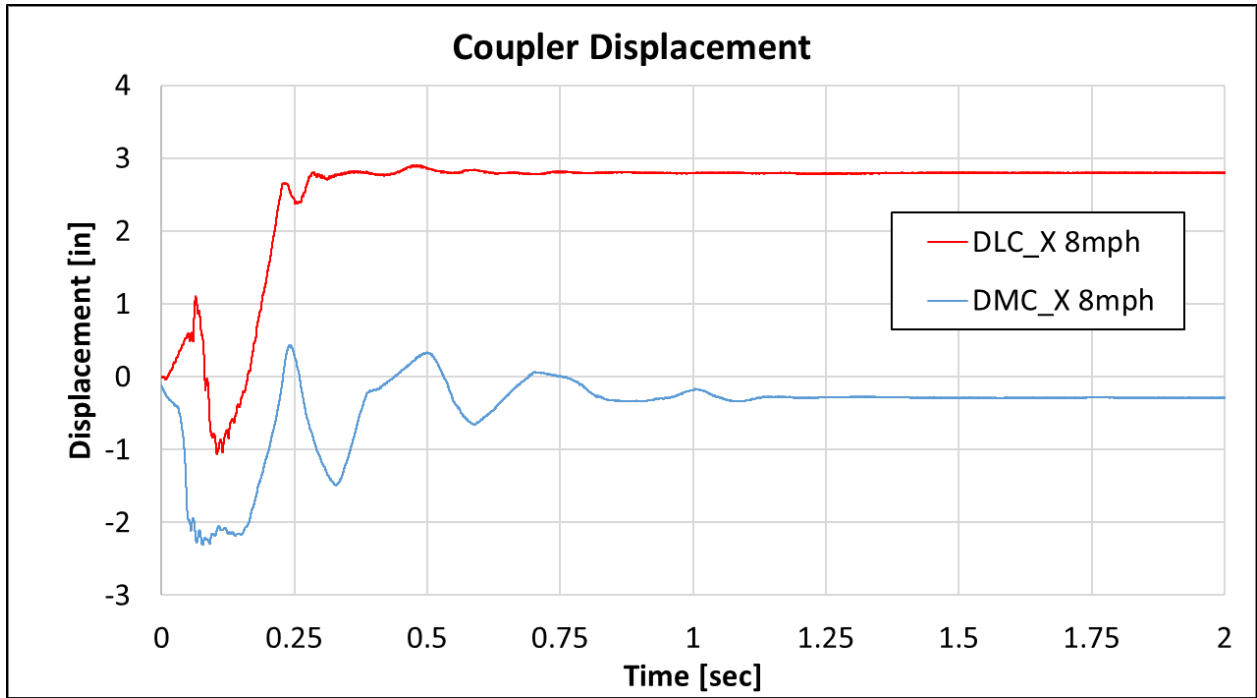

Figure 37. Couplers Displacement at 8 mph

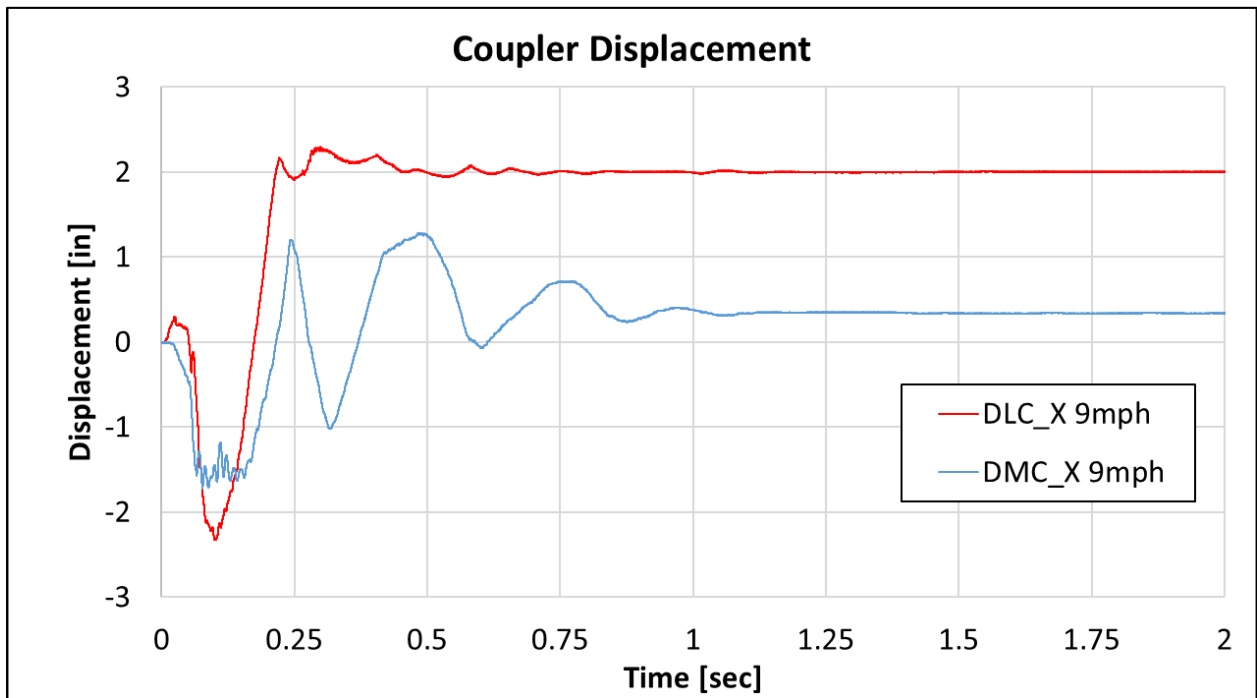

Figure 38. Couplers Displacement at 9 mph

3.2.3 Strains

The F40 locomotive was equipped with 29 strain gages, and another 20 strain gages were on the M1 passenger car. Strain gage data from both the F40 and the M1 were grouped according to

their positions in the car. [Figure 39](#) to [Figure 86](#) report the strain gage data for the locomotive and passenger car for each impact speed.

2mph

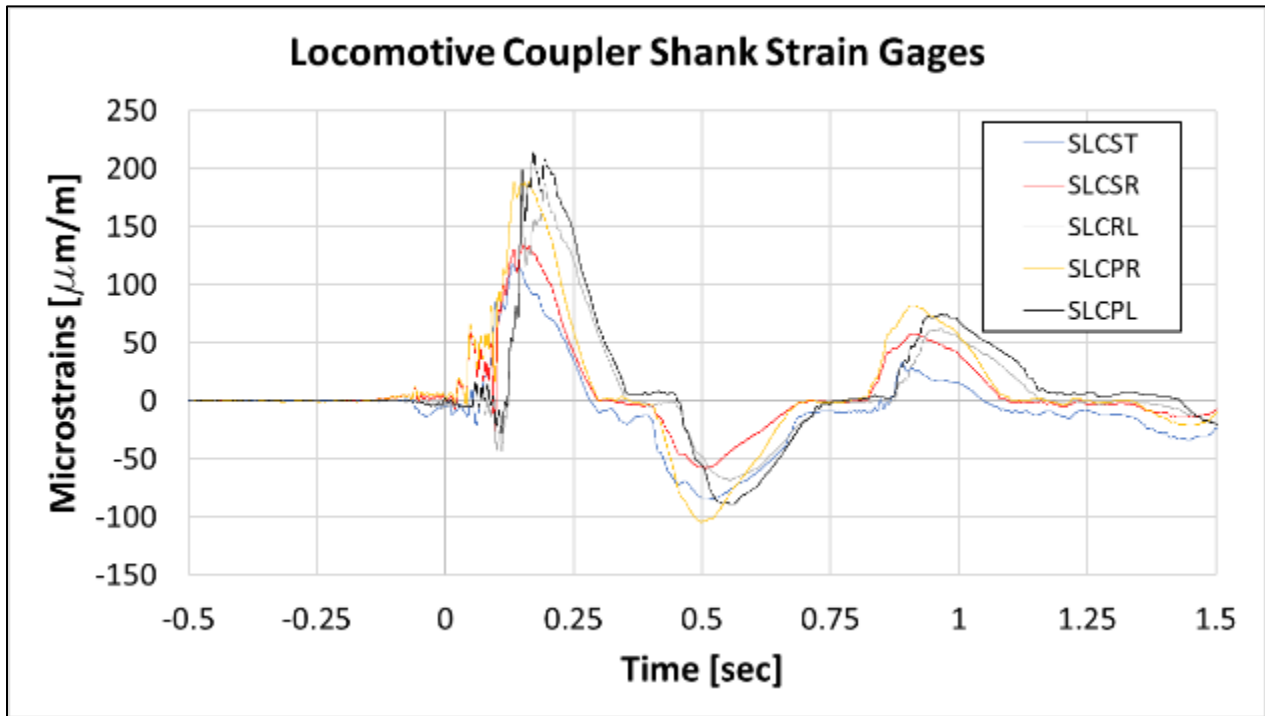

Figure 39. F40 Locomotive Coupler Shank Strain Gages (2 mph)

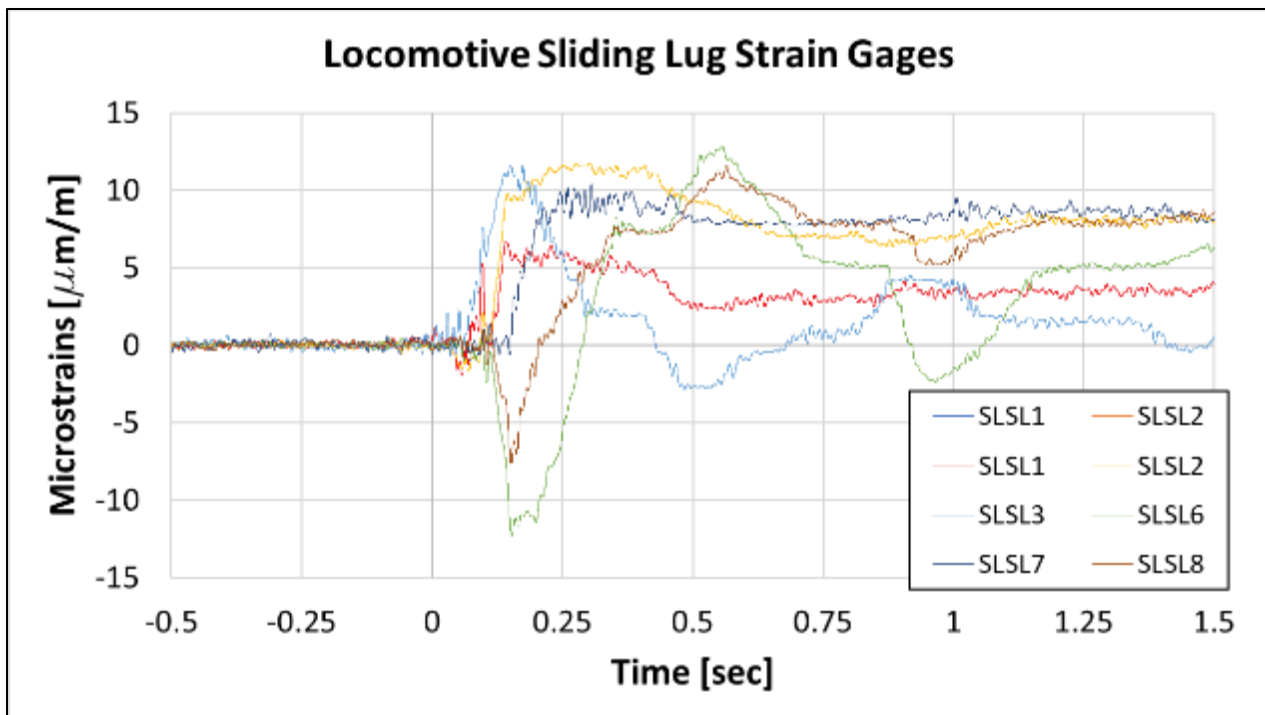

Figure 40. F40 Locomotive Sliding Lug Strain Gages (2 mph)

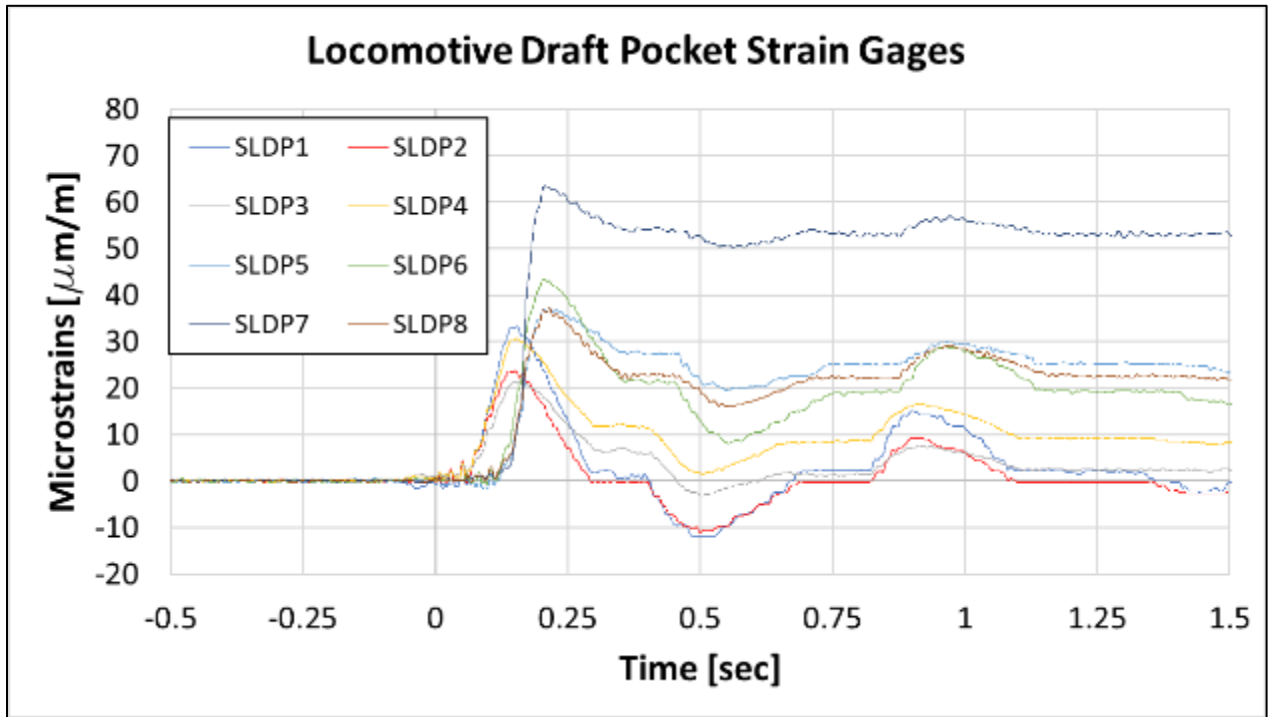

Figure 41. F40 Locomotive Draft Pocket Strain Gages (2 mph)

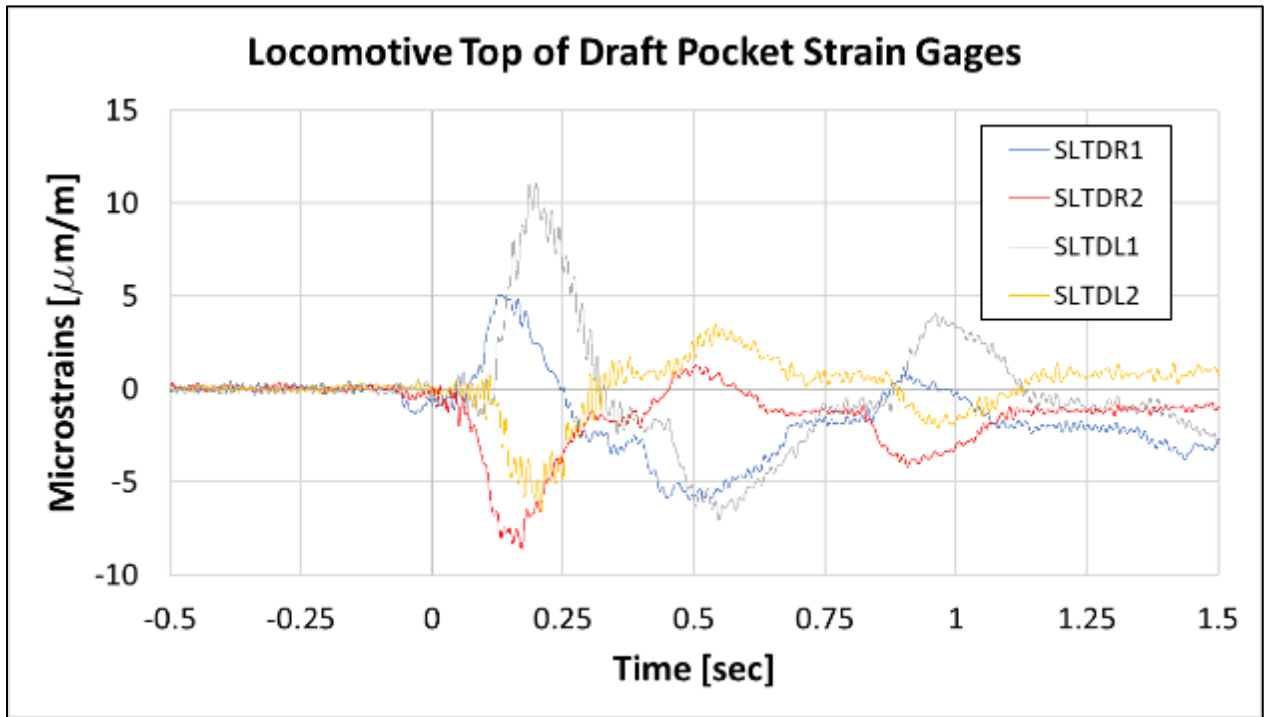

Figure 42. F40 Locomotive Top of Draft Pocket Strain Gages (2 mph)

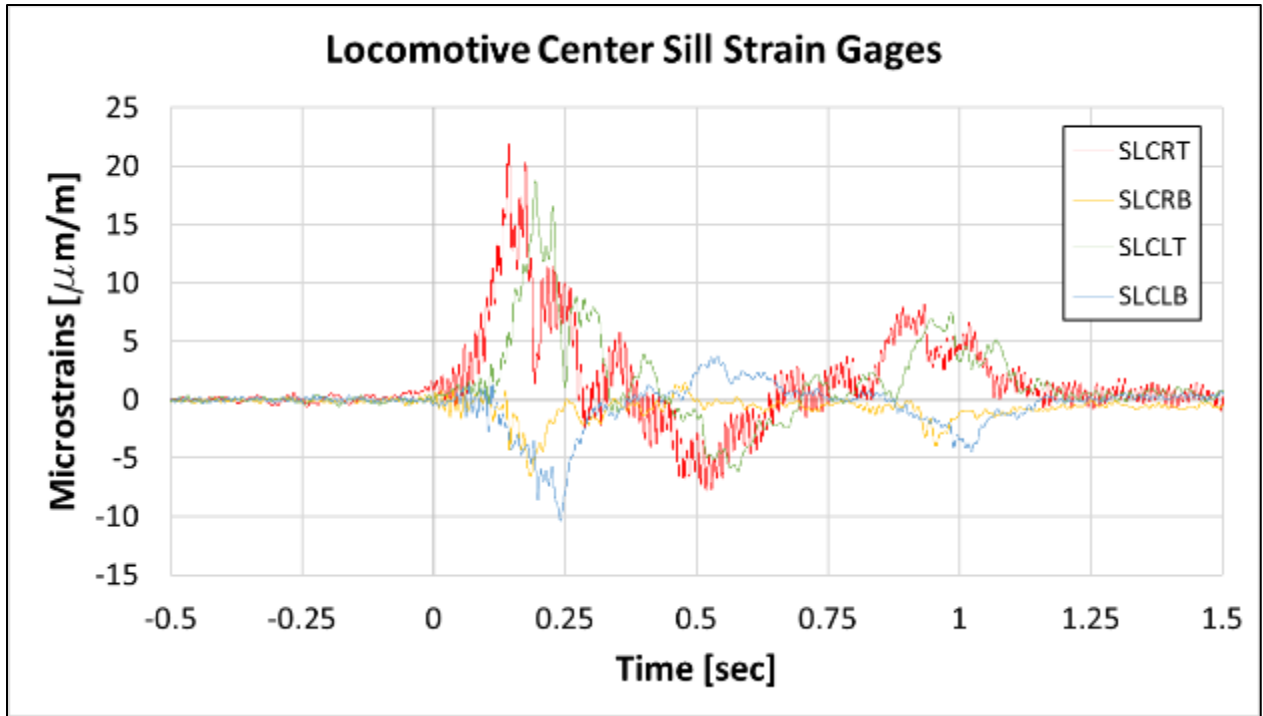

Figure 43. F40 Locomotive Center Sill Strain Gages (2 mph)

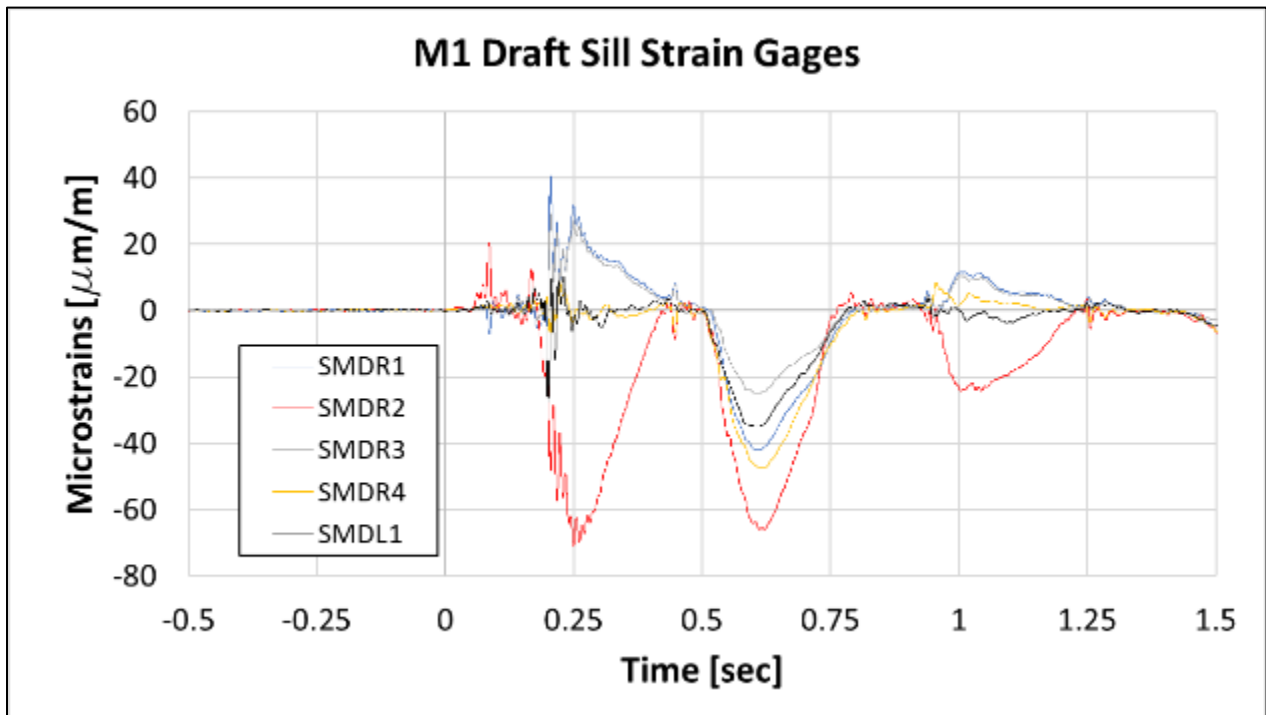

Figure 44. M1 Passenger Car Draft Sill Strain Gages (2 mph)

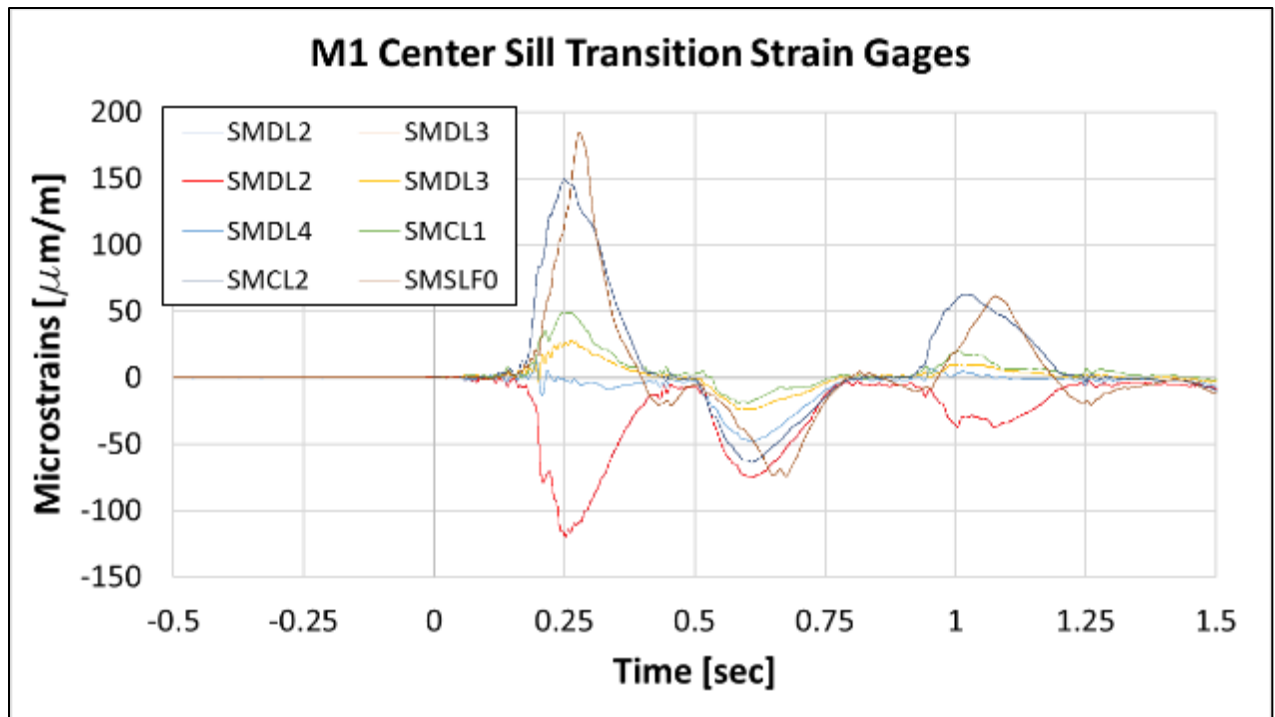

Figure 45. M1 Passenger Car Center Sill Transition Strain Gages (2 mph)

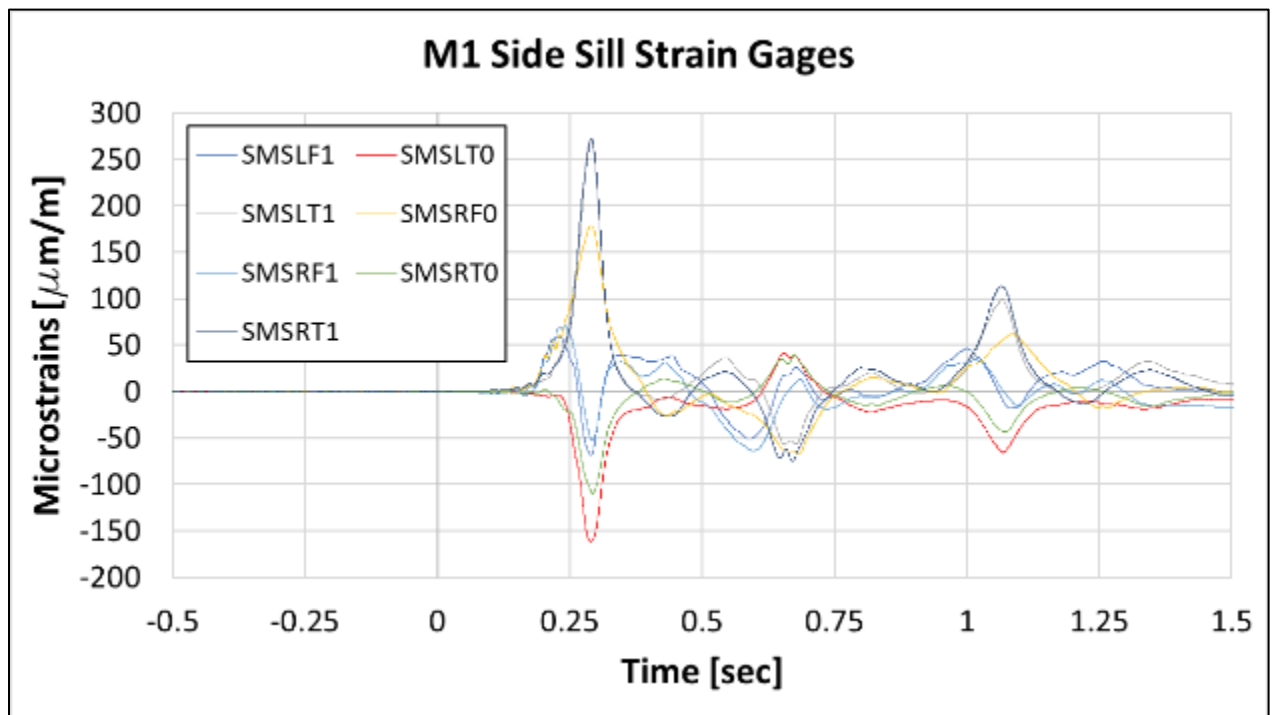

Figure 46. M1 Passenger Car Side Sill Strain Gages (2 mph)

4 mph

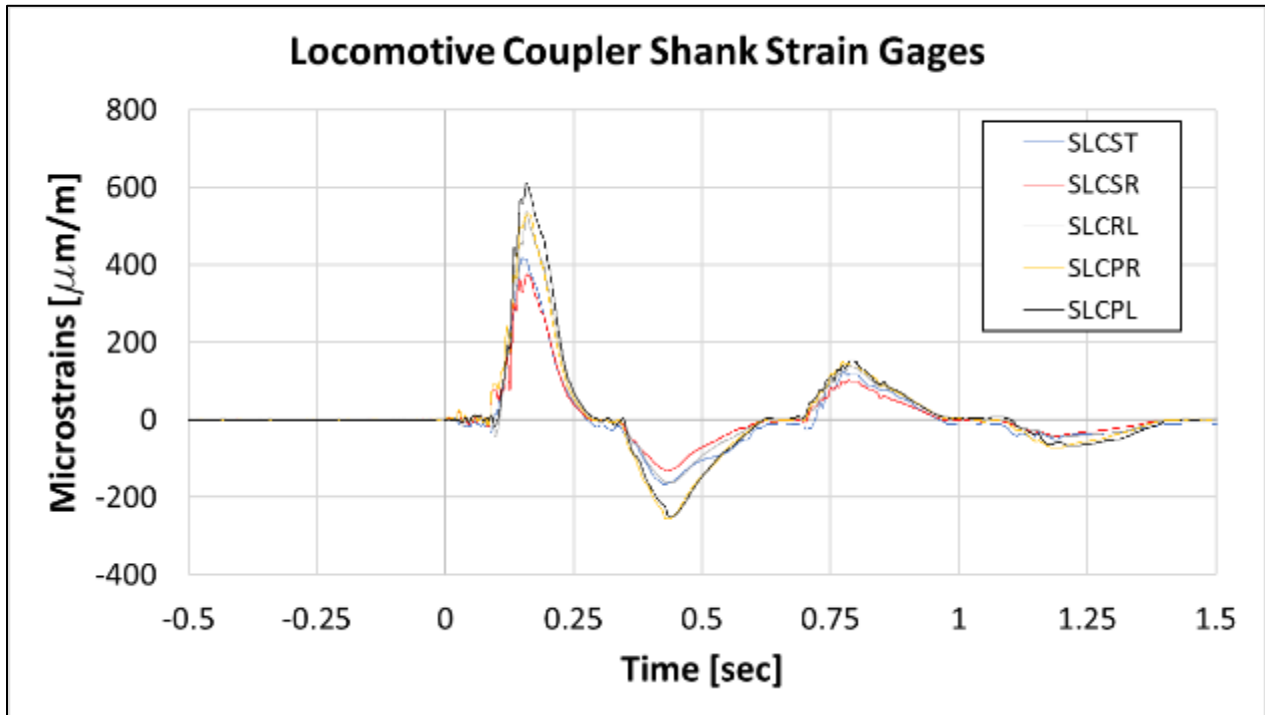

Figure 47. F40 Locomotive Coupler Shank Strain Gages (4 mph)

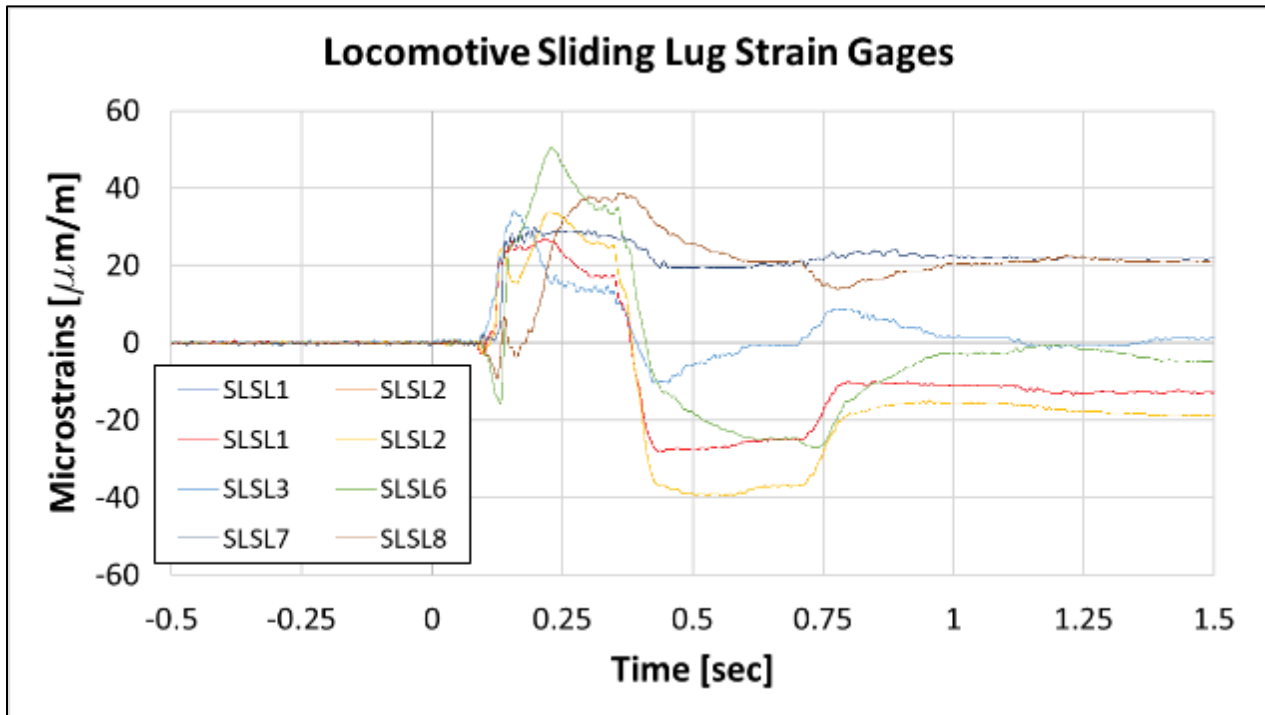

Figure 48. F40 Locomotive Sliding Lug Strain Gages (4 mph)

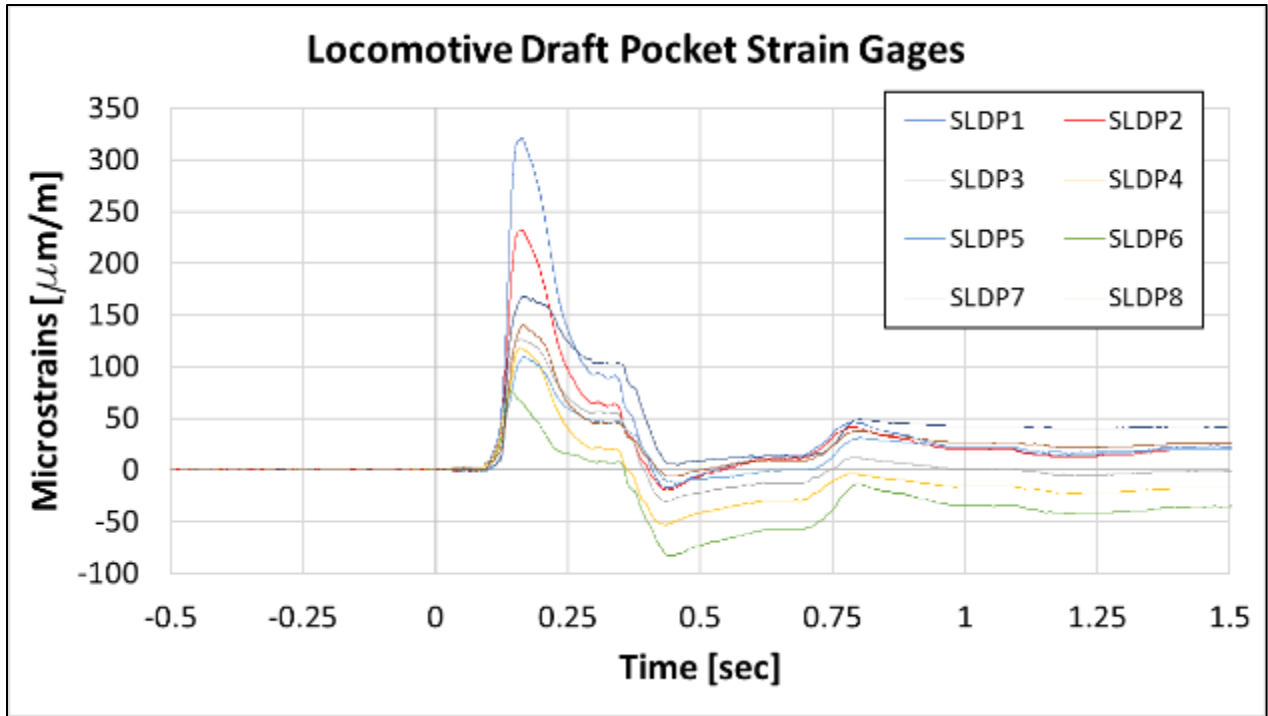

Figure 49. F40 Locomotive Draft Pocket Strain Gages (4 mph)

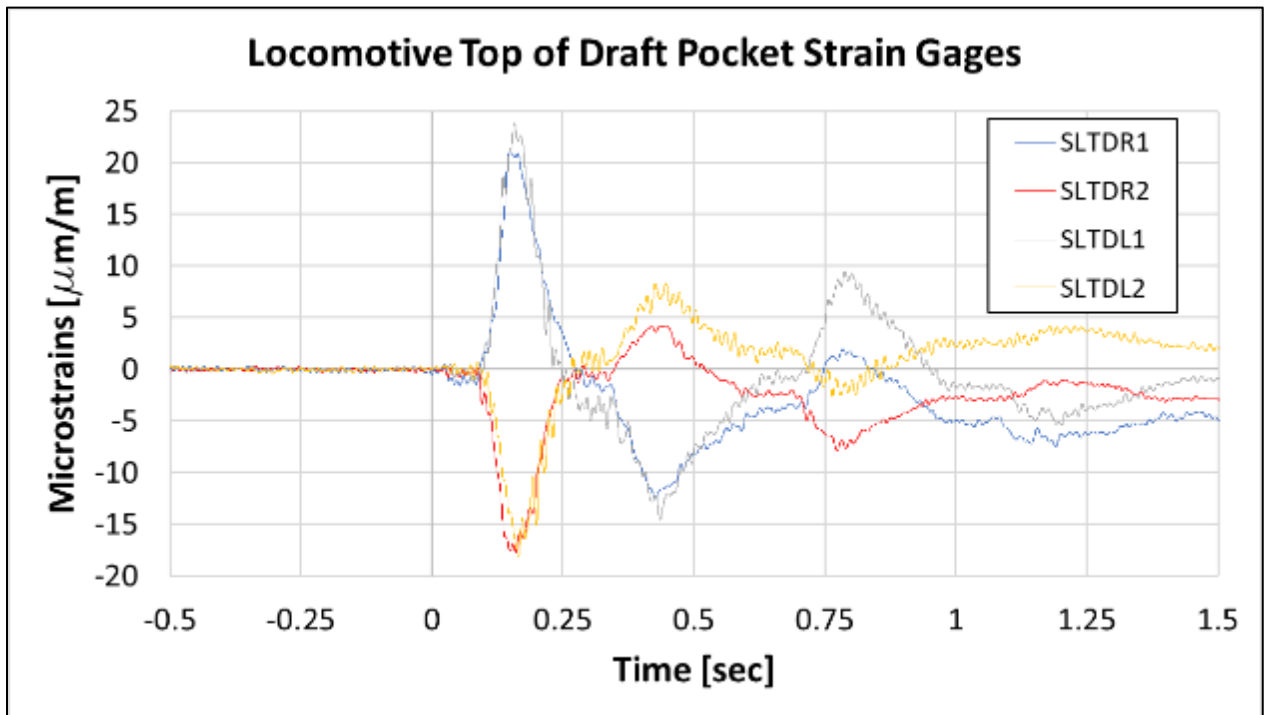

Figure 50. F40 Locomotive Top of Draft Pocket Strain Gages (4 mph)

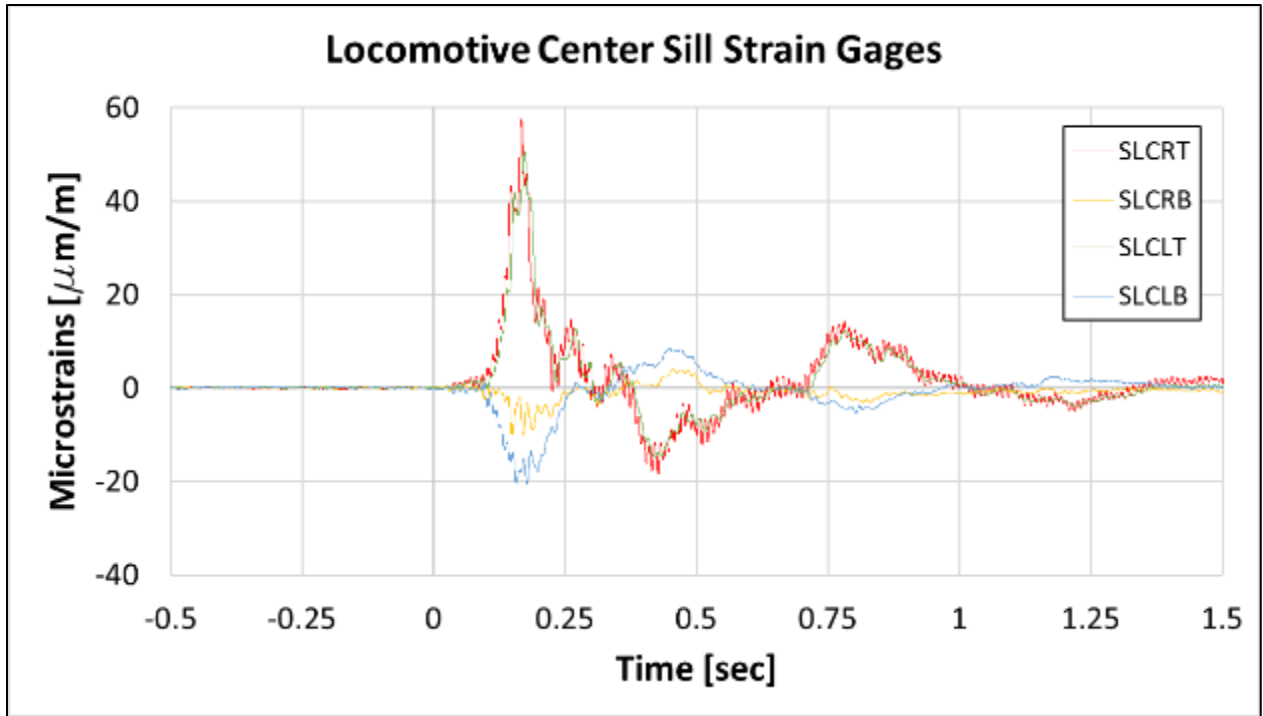

Figure 51. F40 Locomotive Center Sill Strain Gages (4 mph)

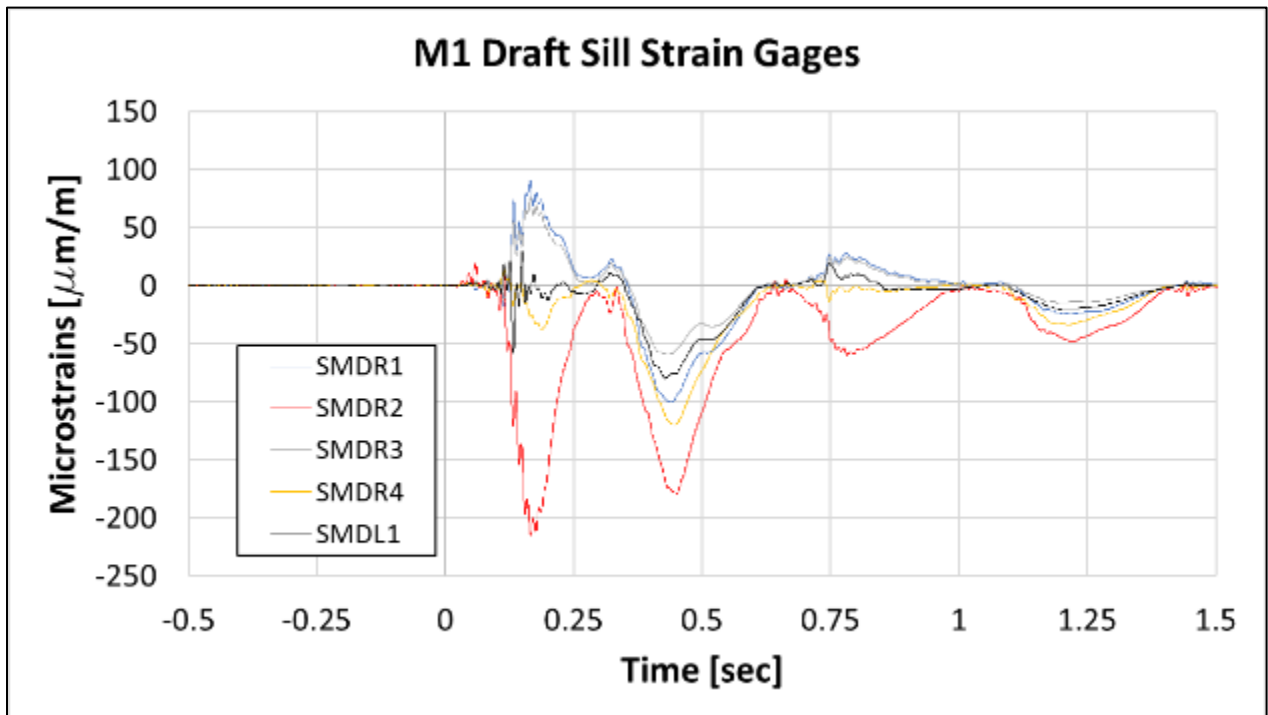

Figure 52. M1 Passenger Car Draft Sill Strain Gages (4 mph)

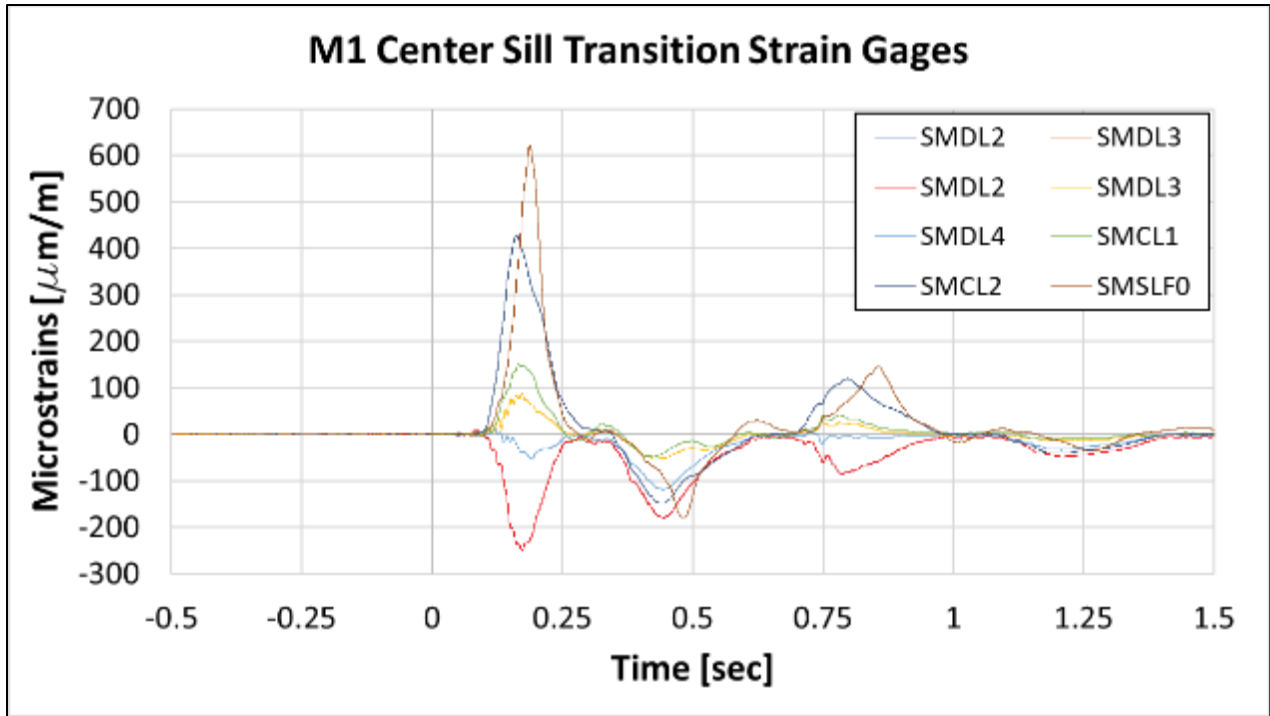

Figure 53. M1 Passenger Car Center Sill Transition Strain Gages (4 mph)

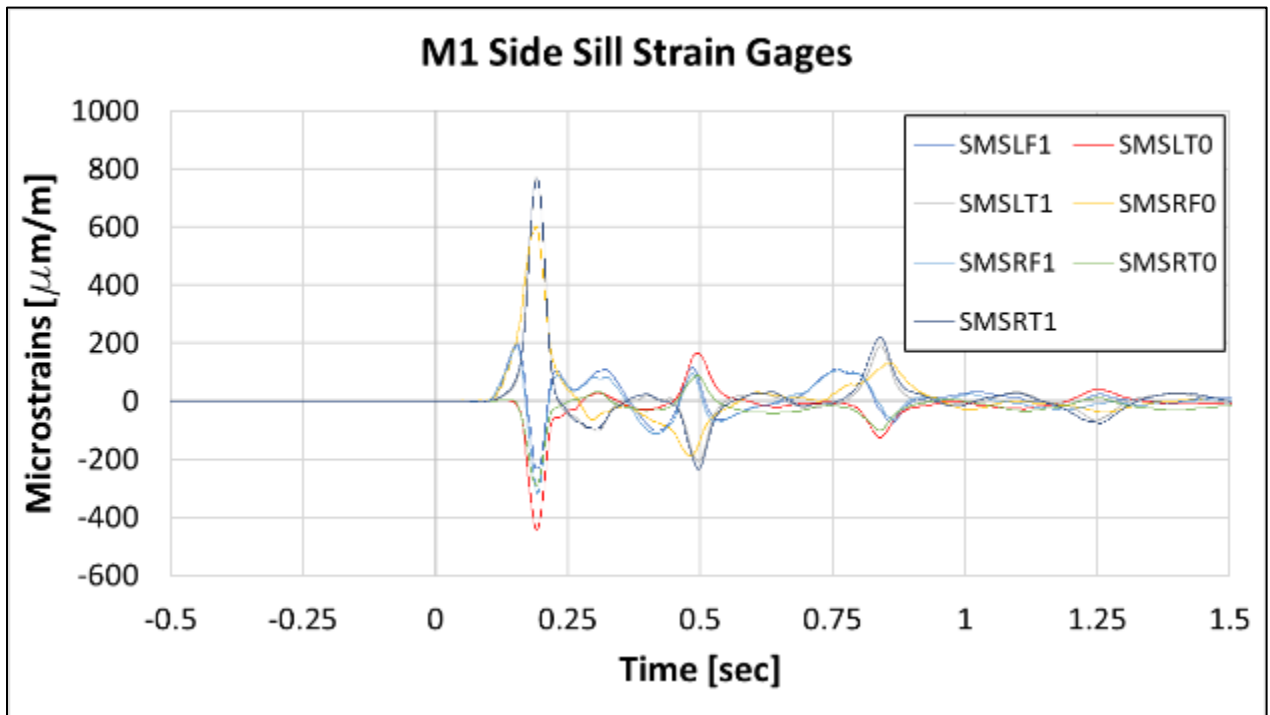

Figure 54. M1 Passenger Car Side Sill Strain Gages (4 mph)

6 mph

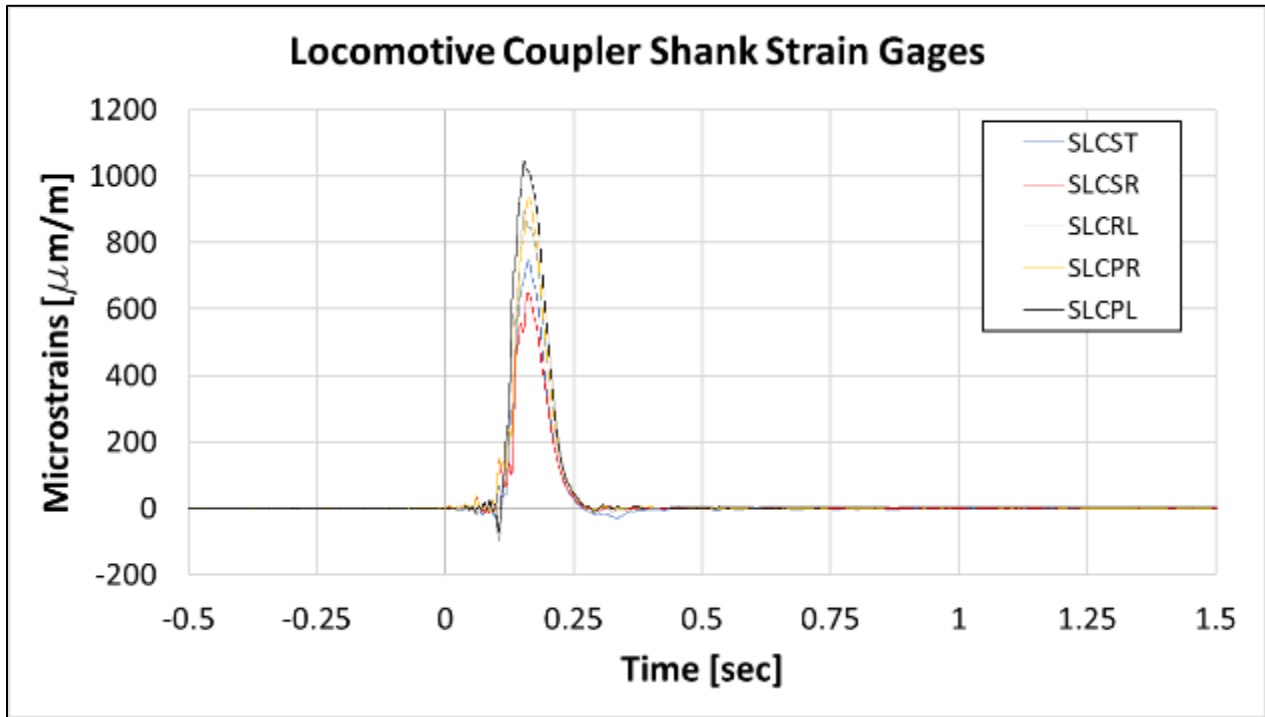

Figure 55. F40 Locomotive Coupler Shank Strain Gages (6 mph)

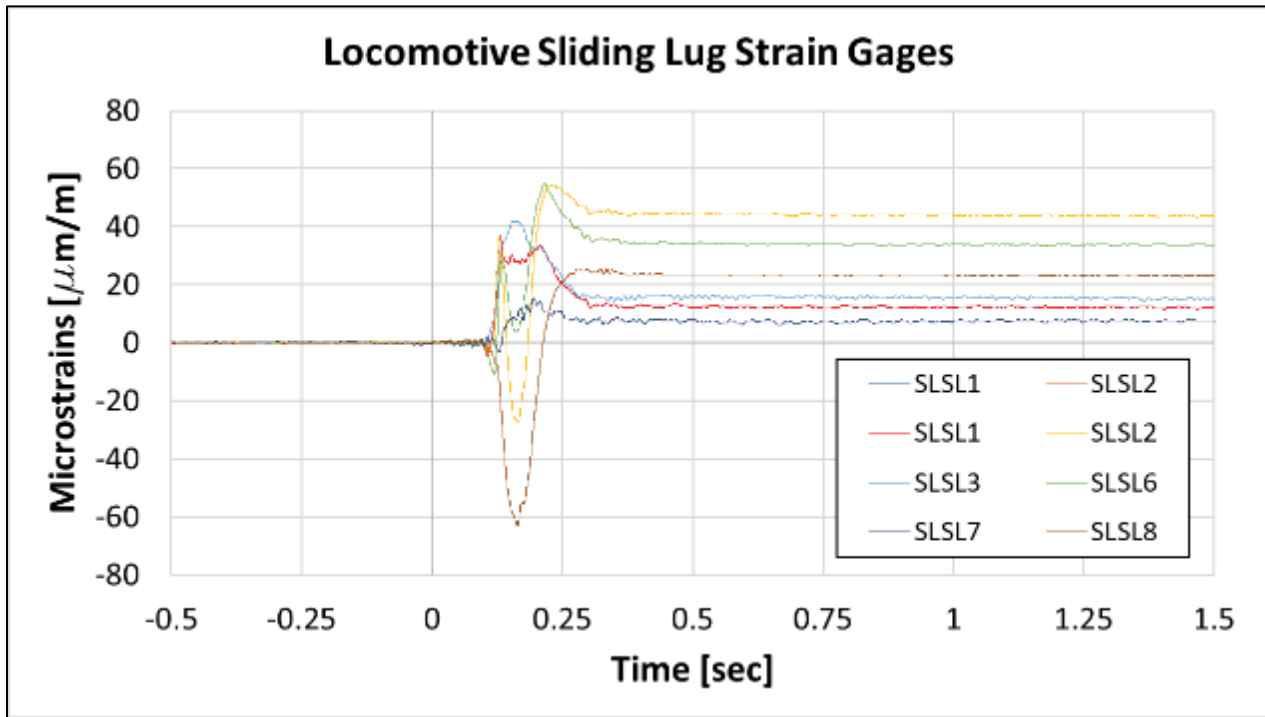

Figure 56. F40 Locomotive Sliding Lug Strain Gages (6 mph)

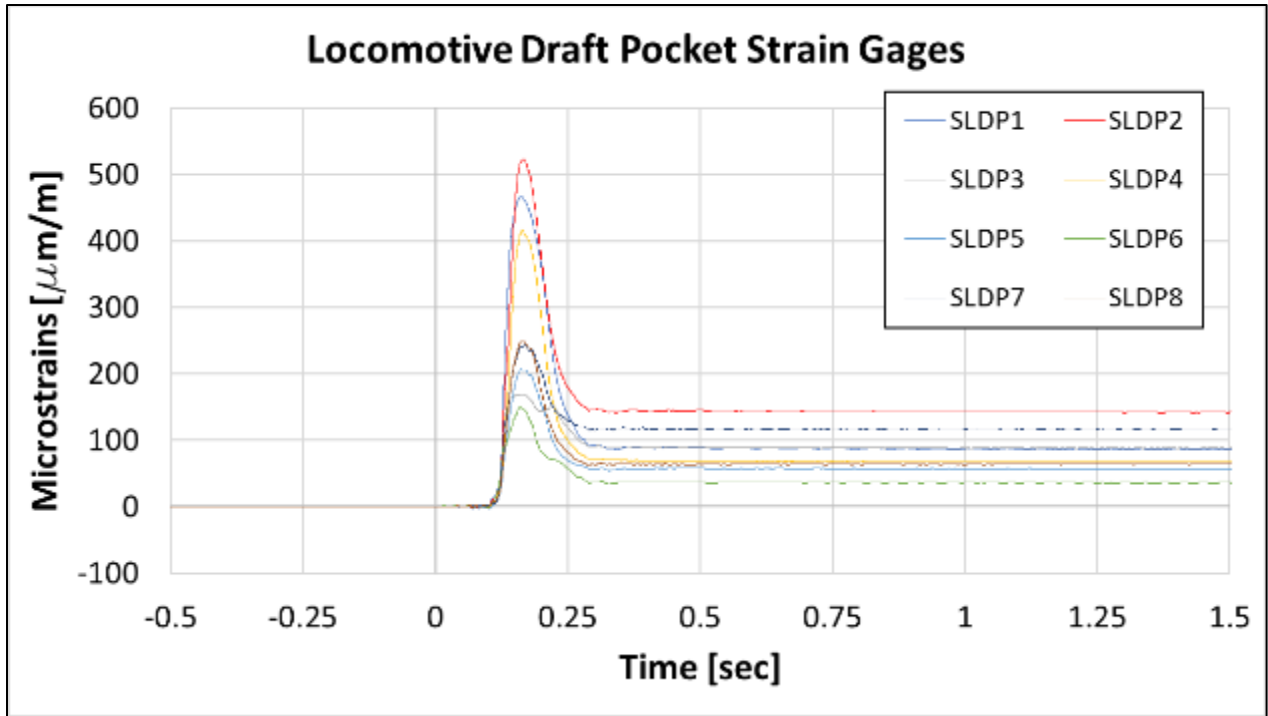

Figure 57. F40 Locomotive Draft Pocket Strain Gages (6 mph)

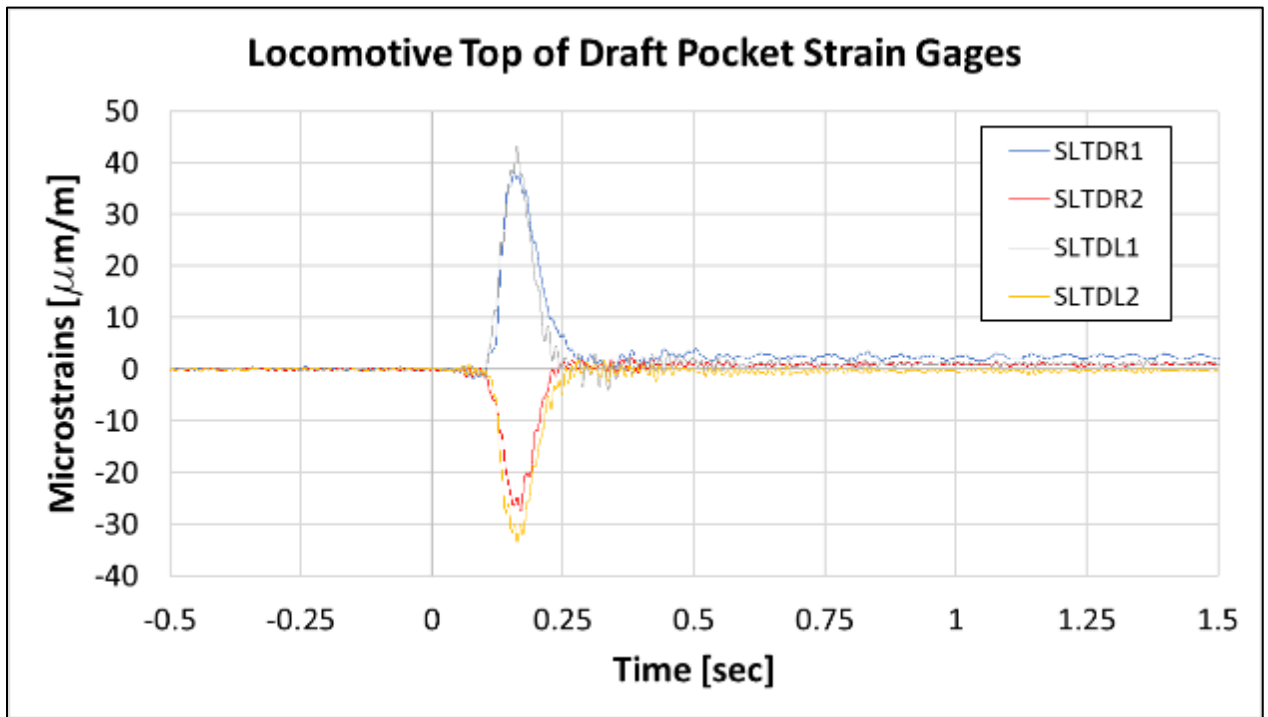

Figure 58. F40 Locomotive Top of Draft Pocket Strain Gages (6 mph)

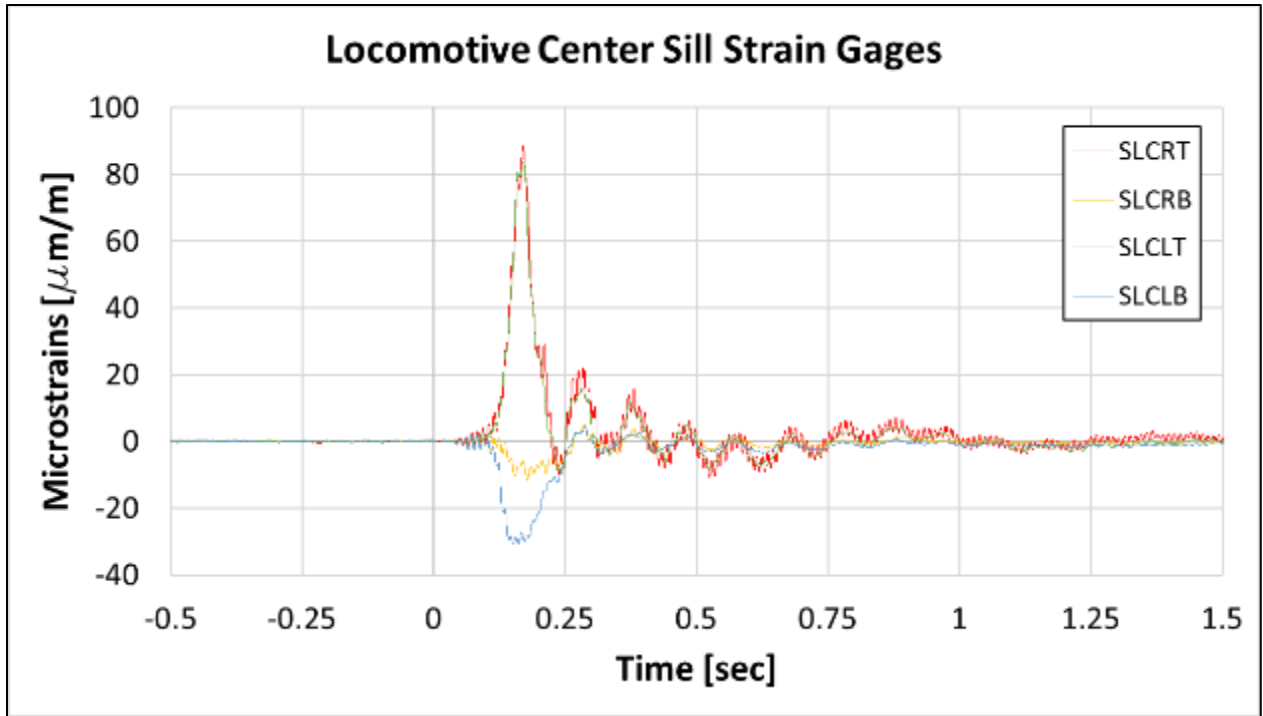

Figure 59. F40 Locomotive Center Sill Strain Gages (6 mph)

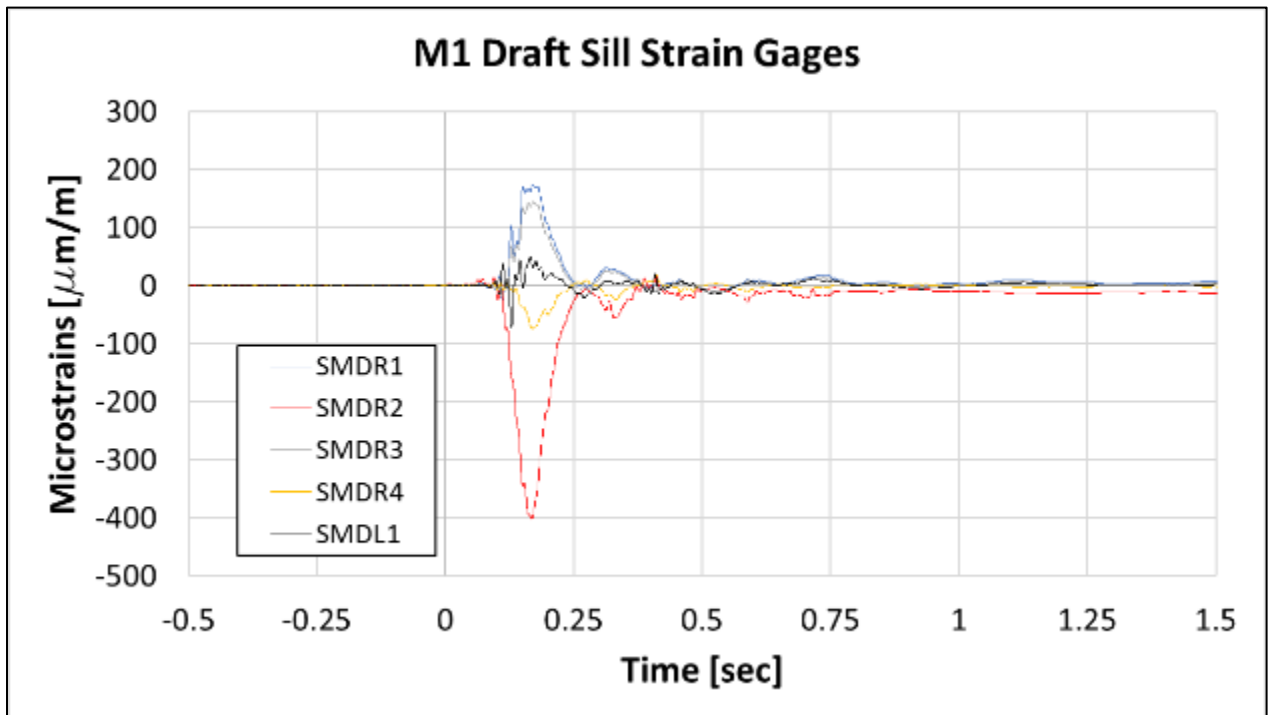

Figure 60. M1 Passenger Car Draft Sill Strain Gages (6 mph)

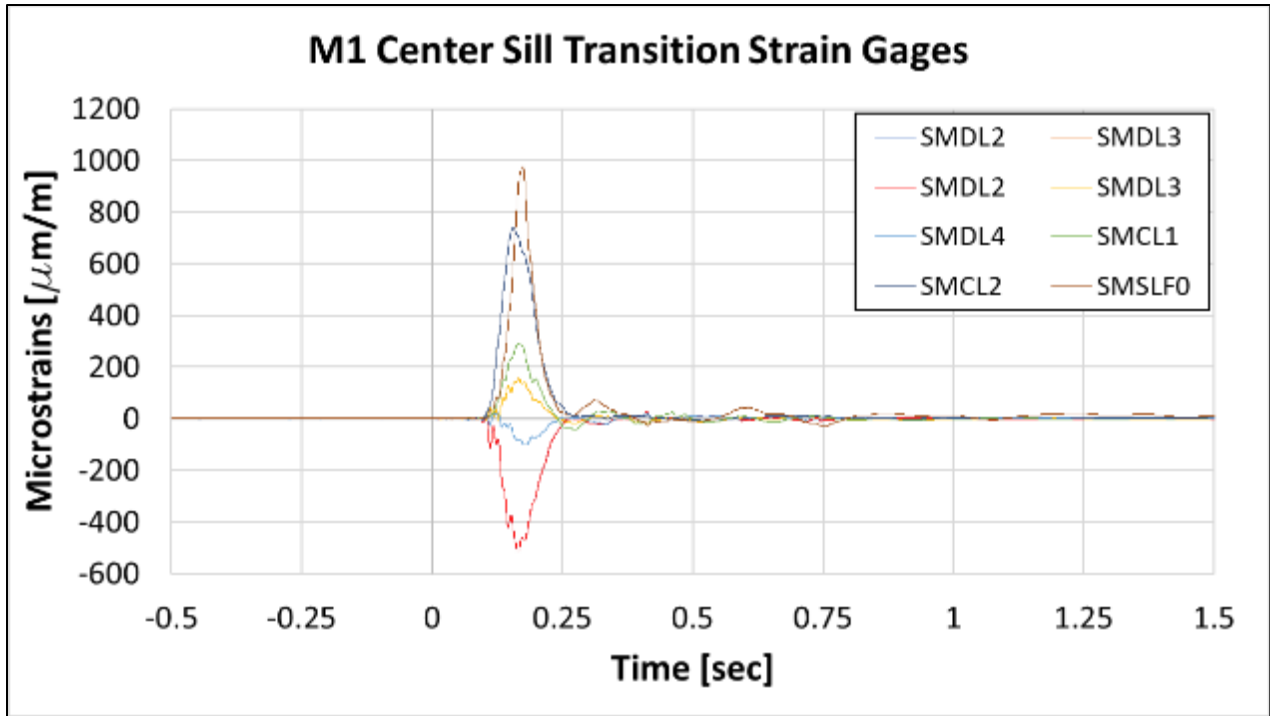

Figure 61. M1 Passenger Car Center Sill Transition Strain Gages (6 mph)

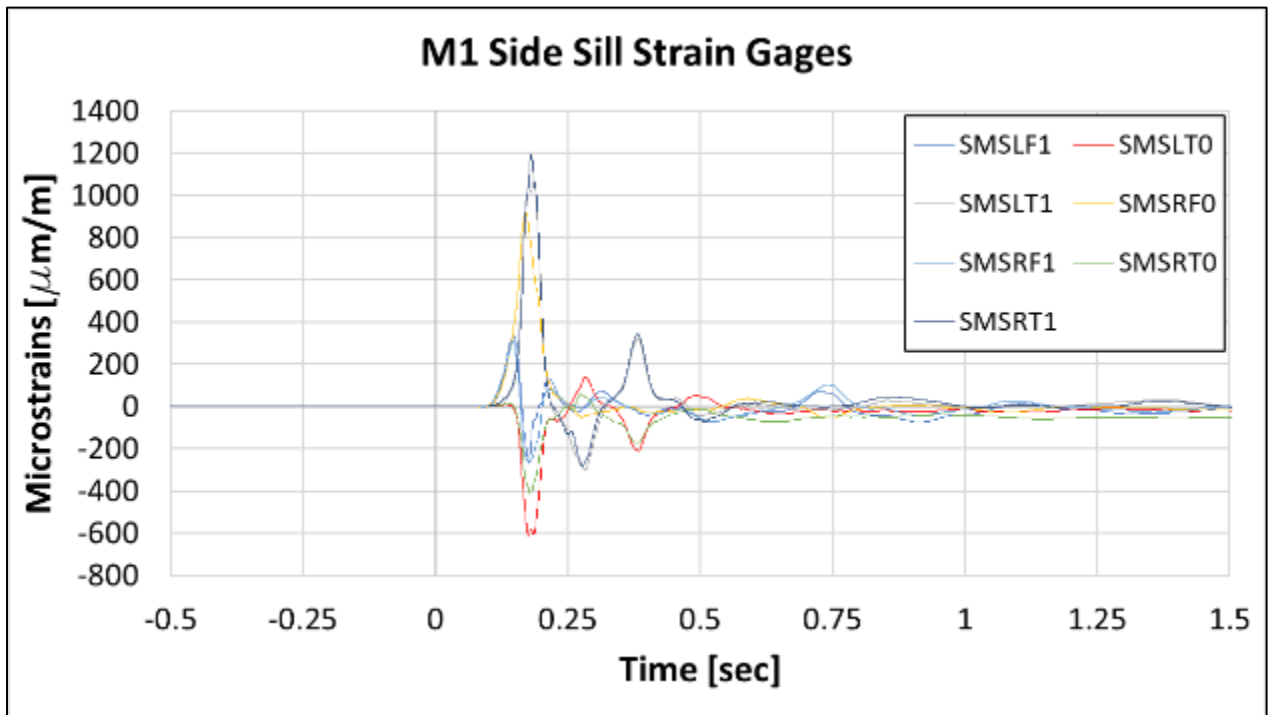

Figure 62. M1 Passenger Car Side Sill Strain Gages (6 mph)

7 mph

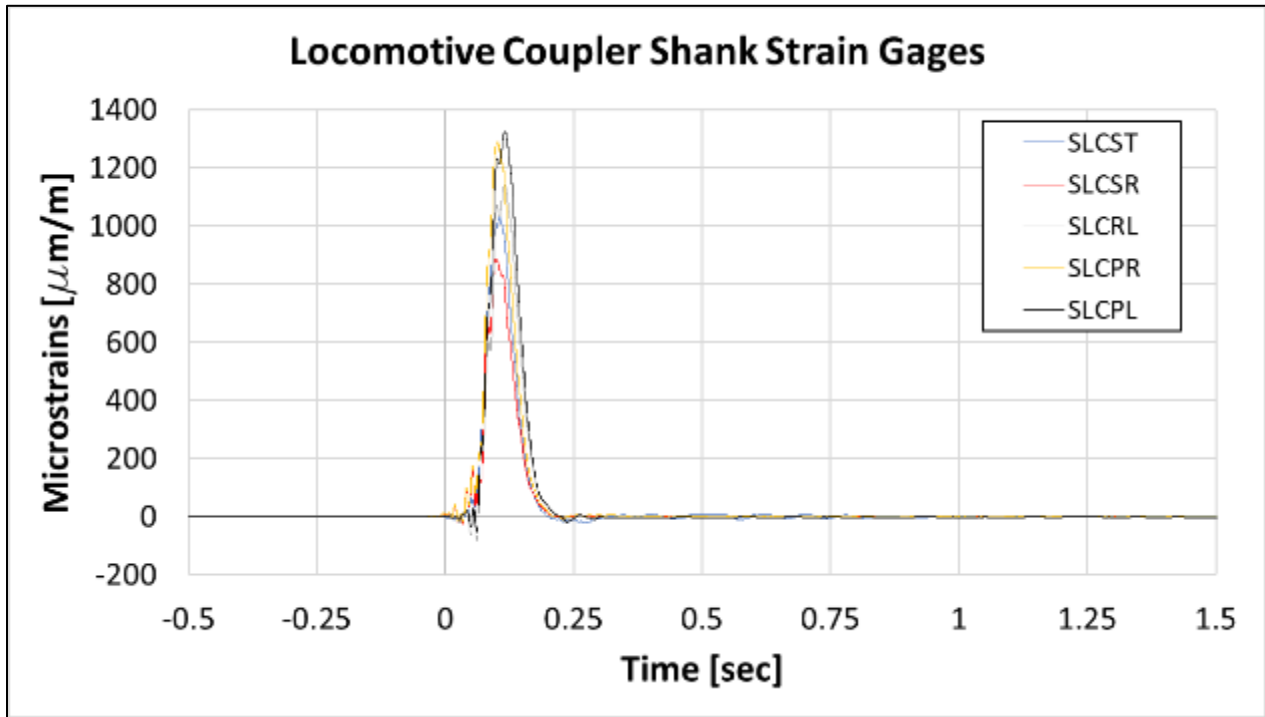

Figure 63. F40 Locomotive Coupler Shank Strain Gages (7 mph)

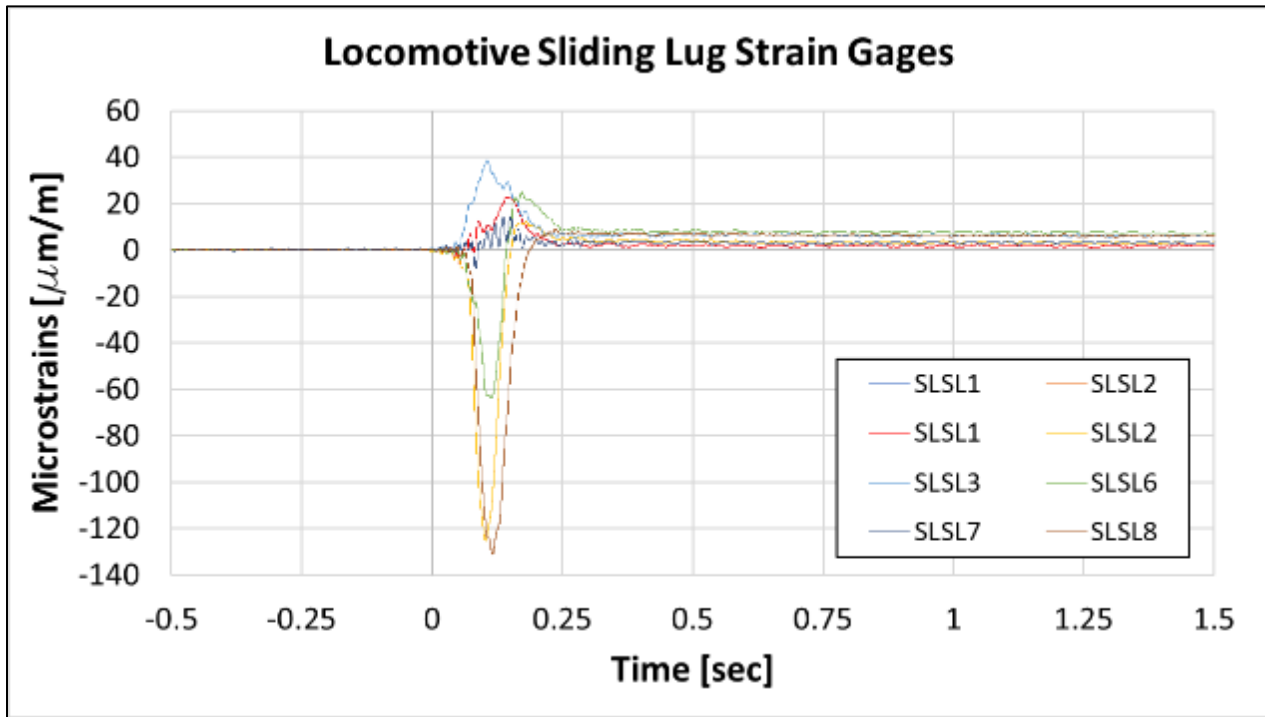

Figure 64. F40 Locomotive Sliding Lug Strain Gages (7 mph)

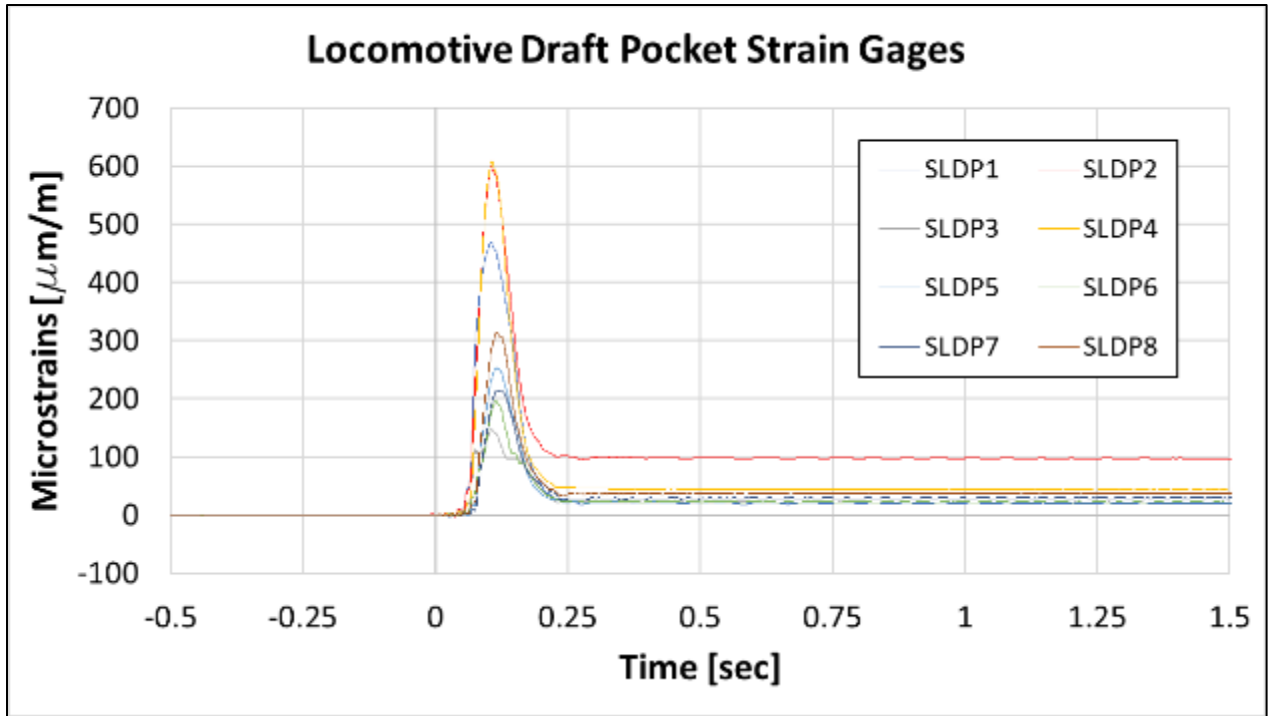

Figure 65. F40 Locomotive Draft Pocket Strain Gages (7 mph)

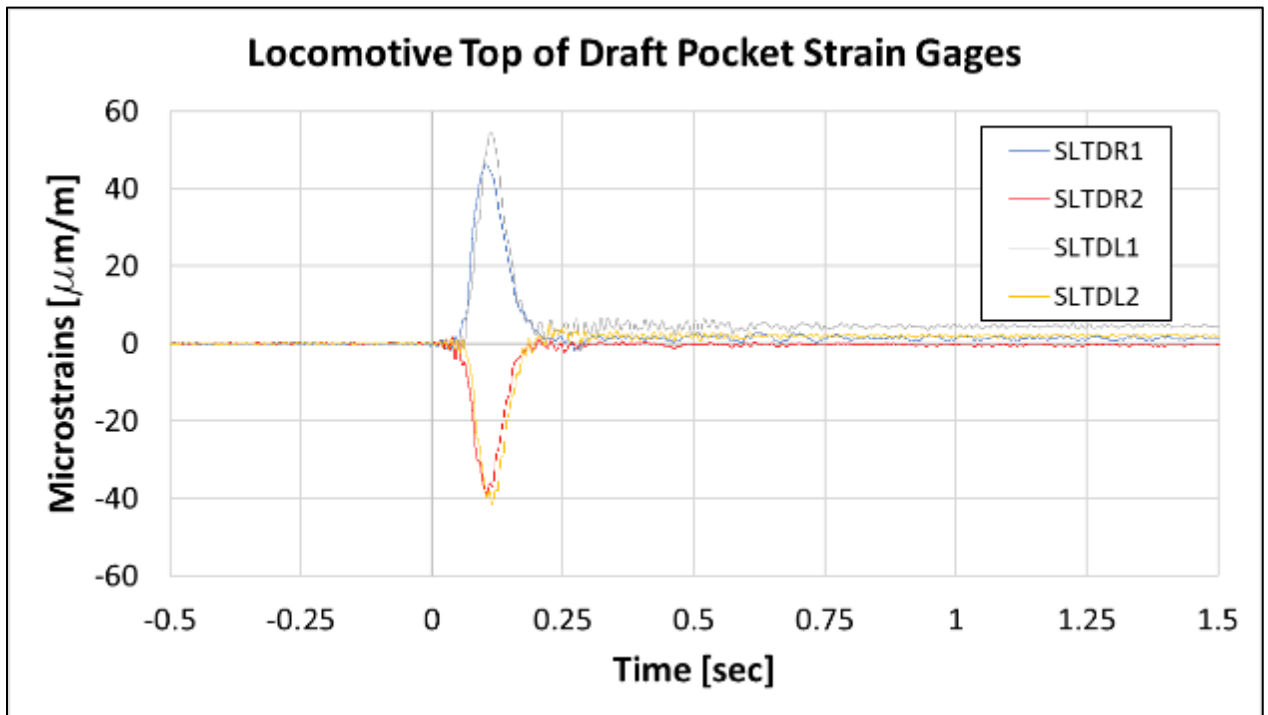

Figure 66. F40 Locomotive Top of Draft Pocket Strain Gages (7 mph)

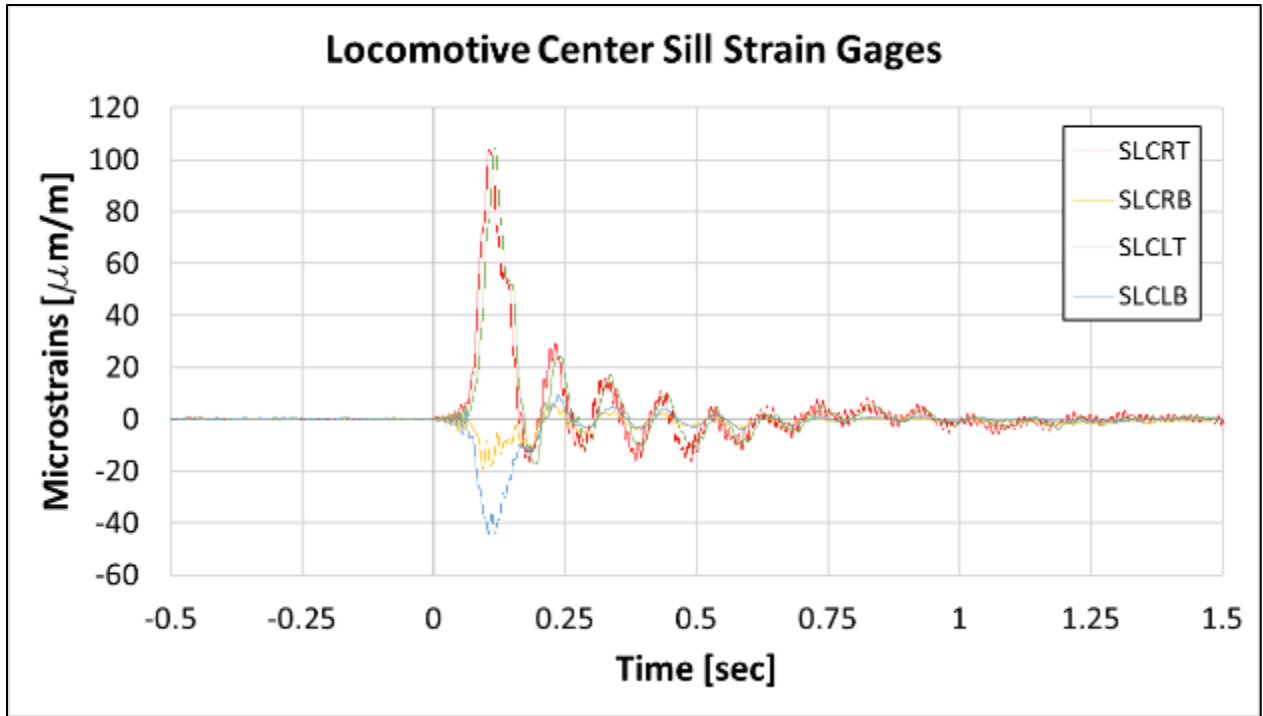

Figure 67. F40 Locomotive Center Sill Strain Gages (7 mph)

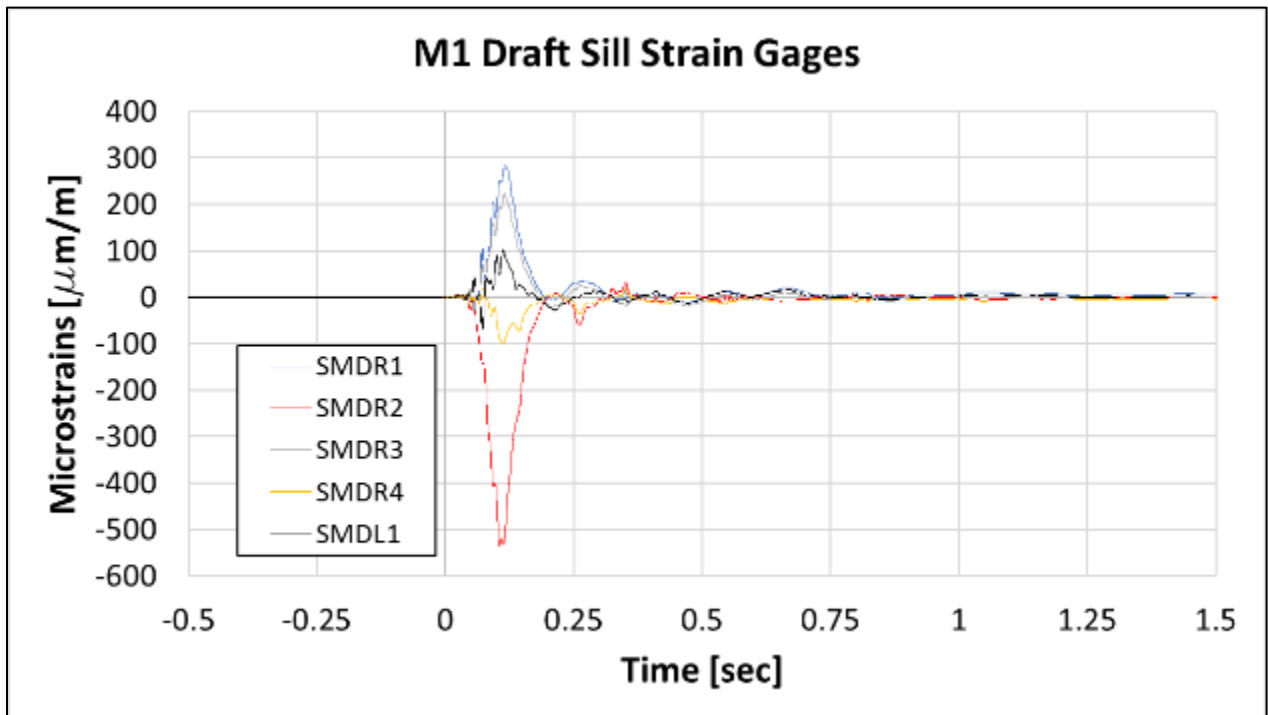

Figure 68. M1 Passenger Car Draft Sill Strain Gages (7 mph)

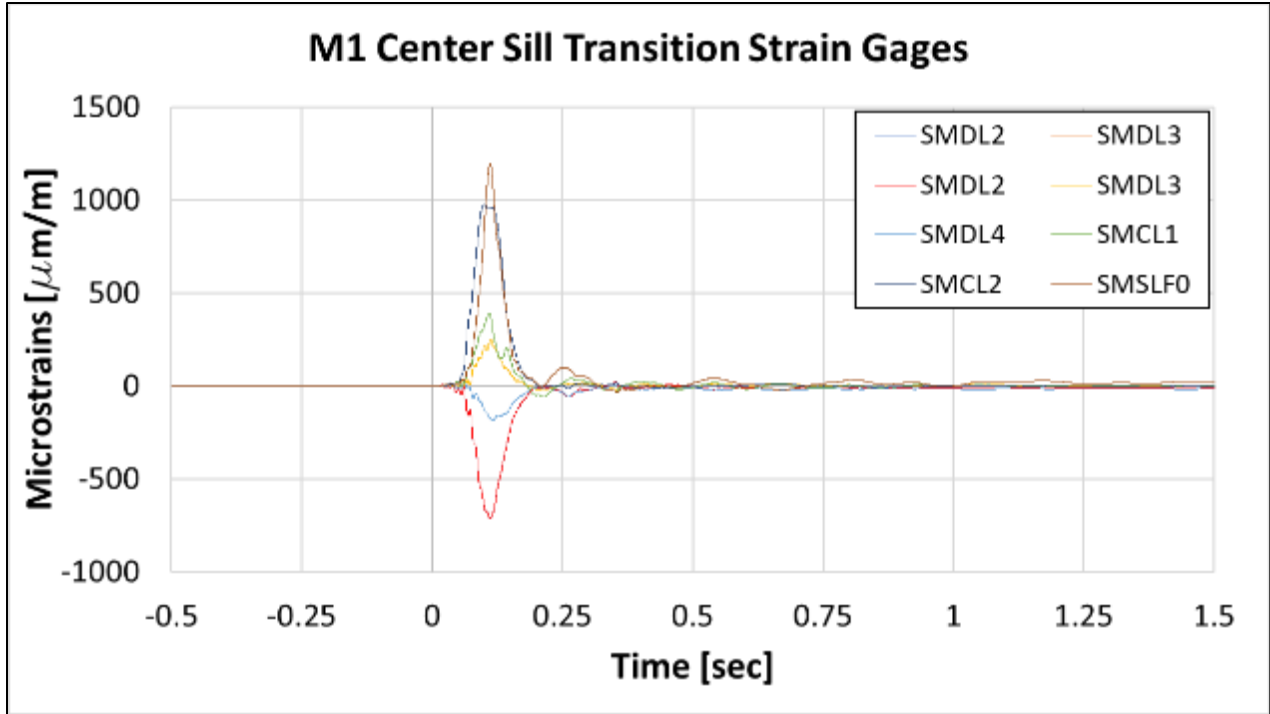

Figure 69. M1 Passenger Car Center Sill Transition Strain Gages (7 mph)

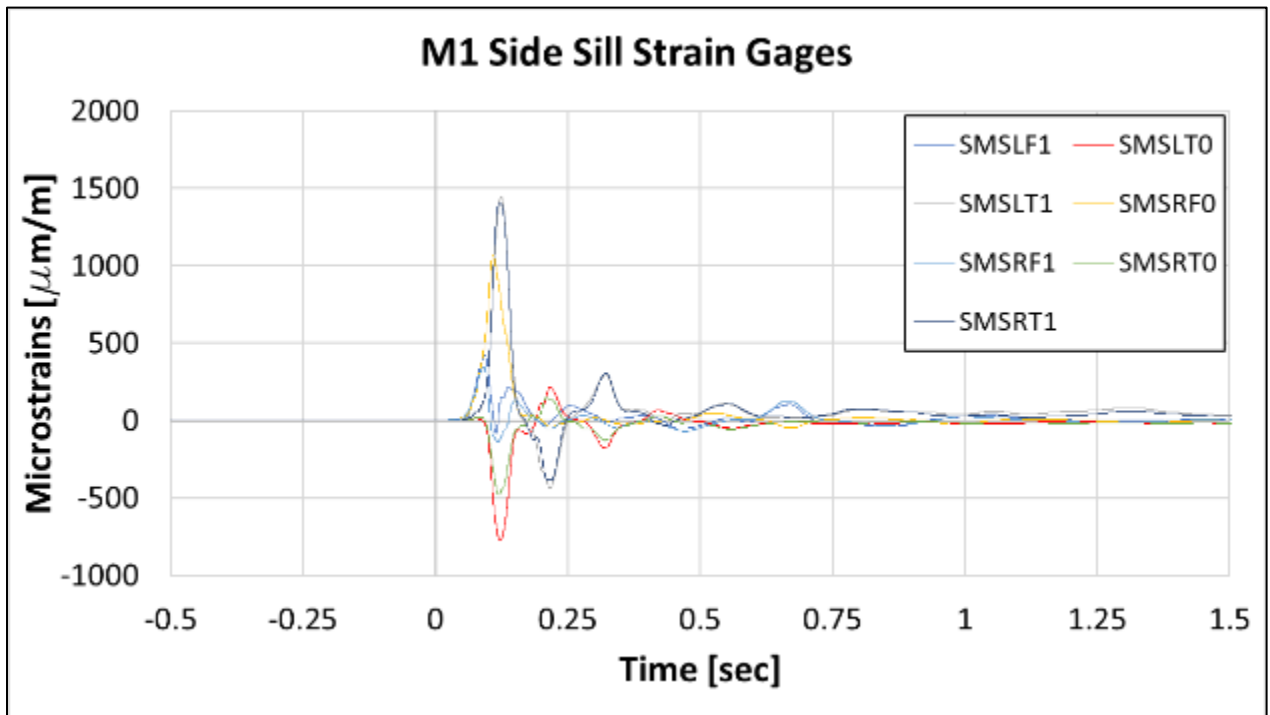

Figure 70. M1 Passenger Car Side Sill Strain Gages (7 mph)

8 mph

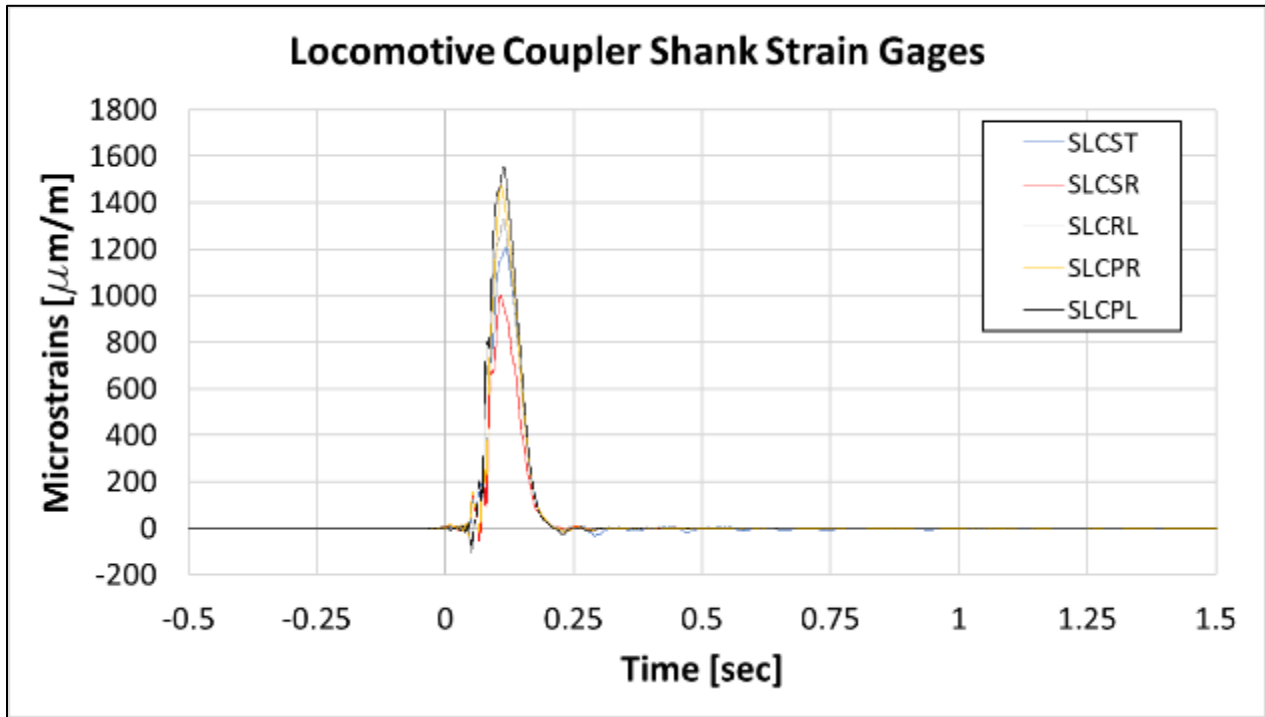

Figure 71. F40 Locomotive Coupler Shank Strain Gages (8 mph)

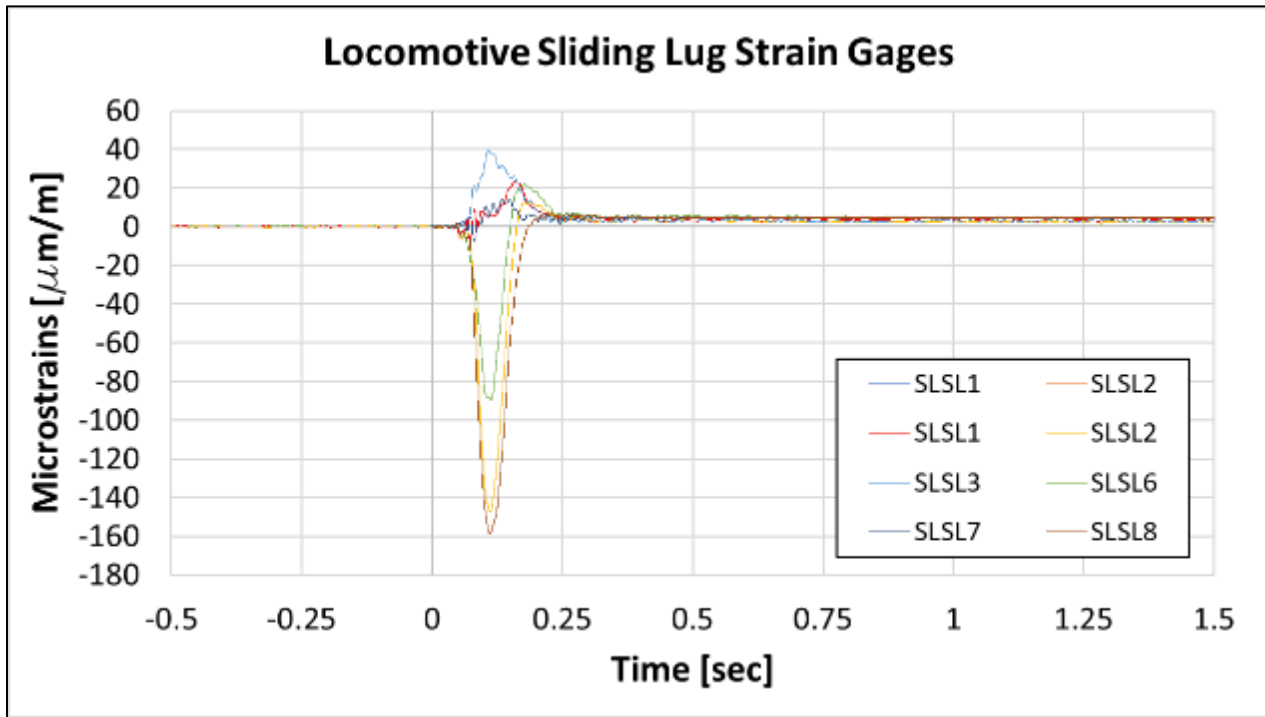

Figure 72. F40 Locomotive Sliding Lug Strain Gages (8 mph)

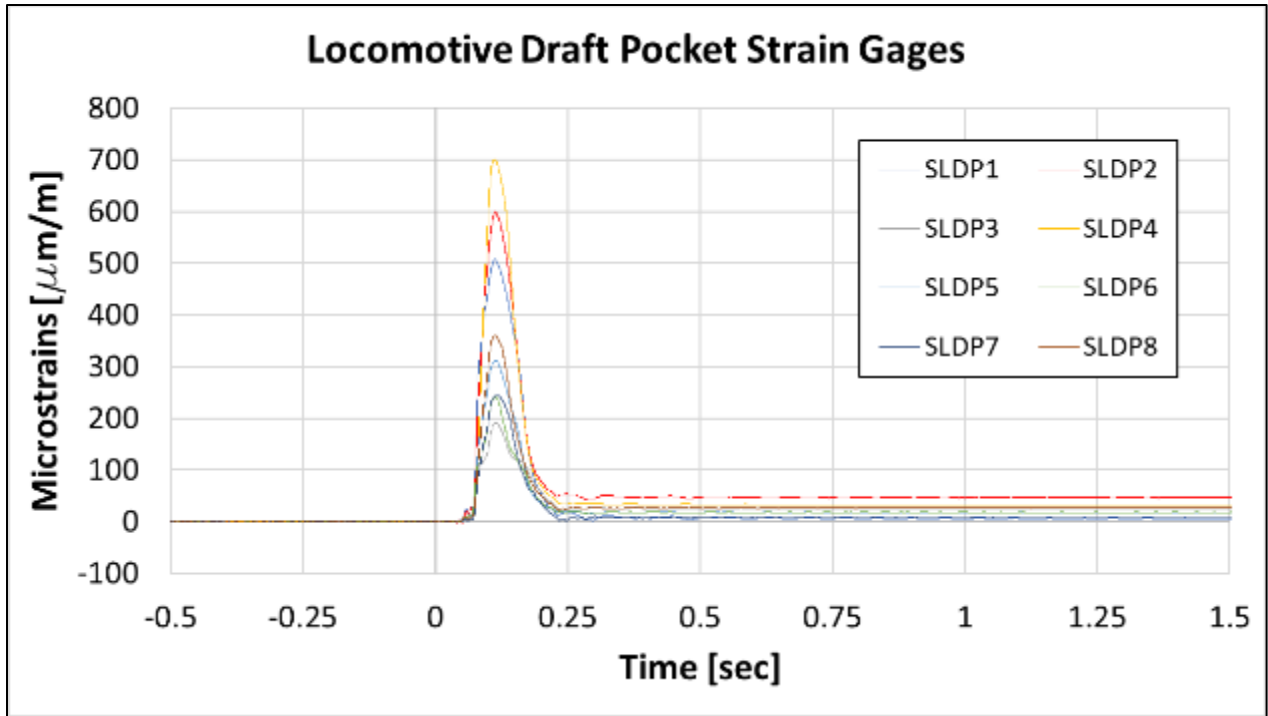

Figure 73. F40 Locomotive Draft Pocket Strain Gages (8 mph)

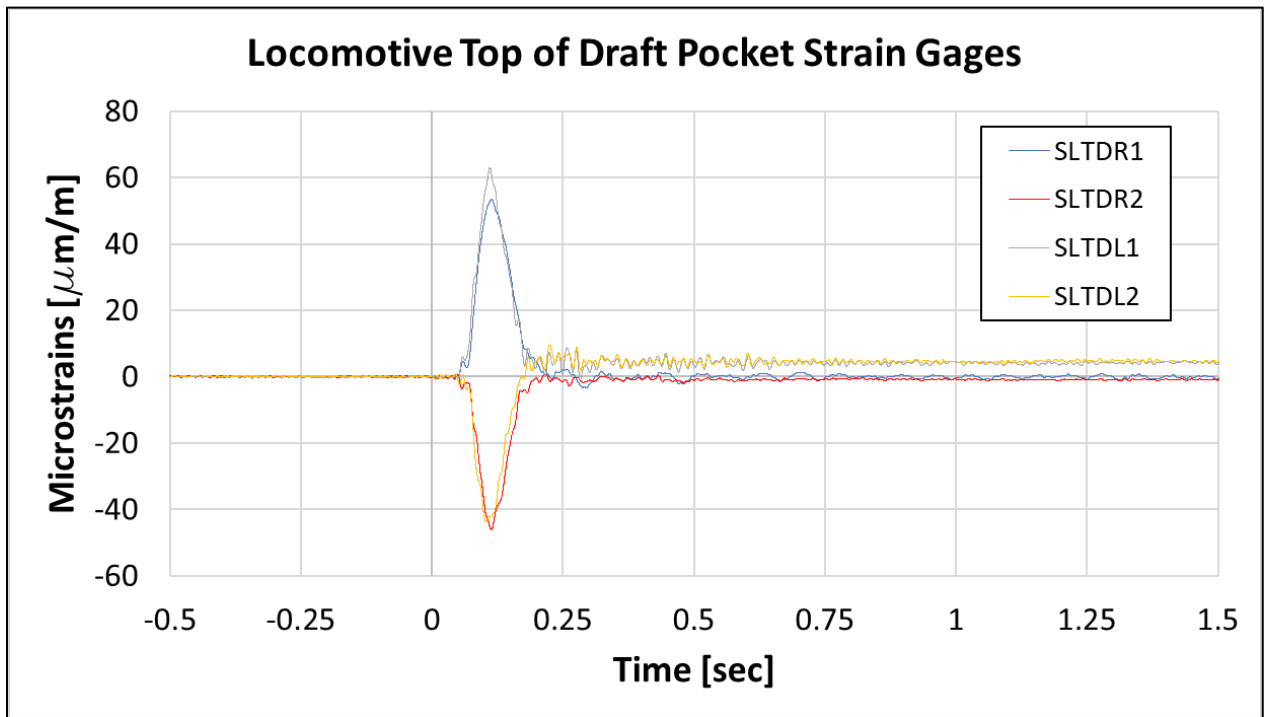

Figure 74. F40 Locomotive Top of Draft Pocket Strain Gages (8 mph)

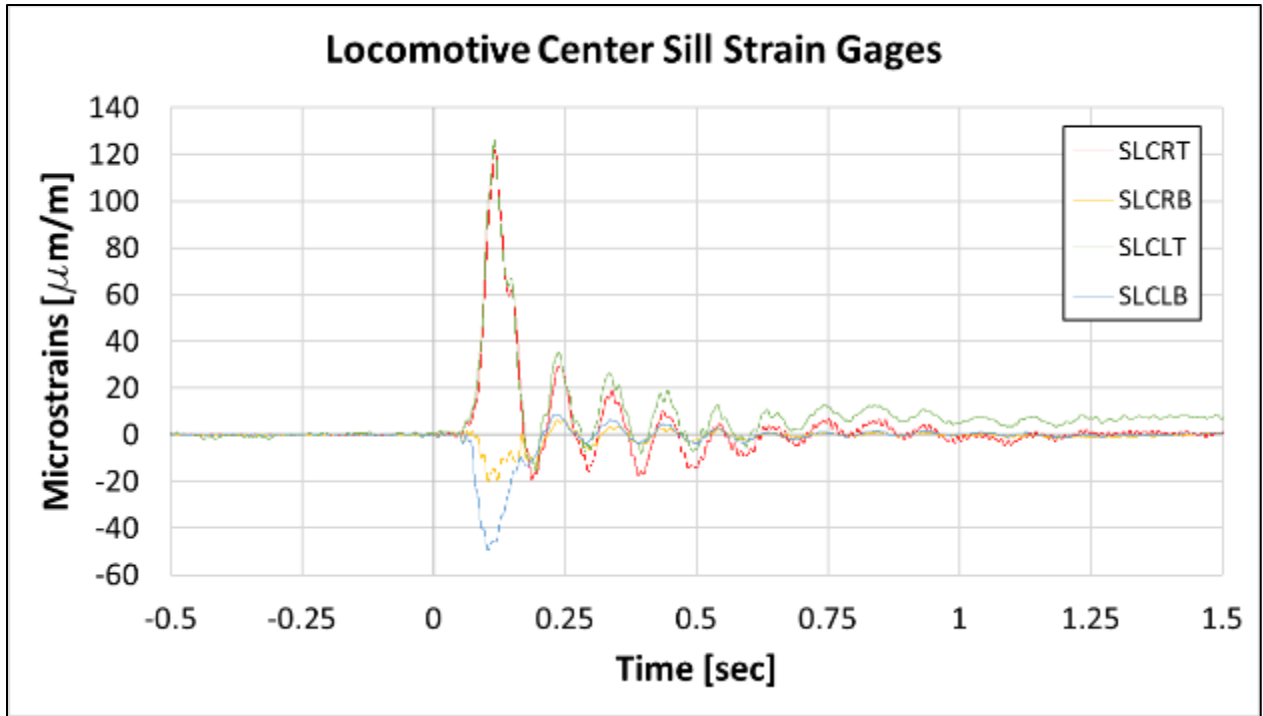

Figure 75. F40 Locomotive Center Sill Strain Gages (8 mph)

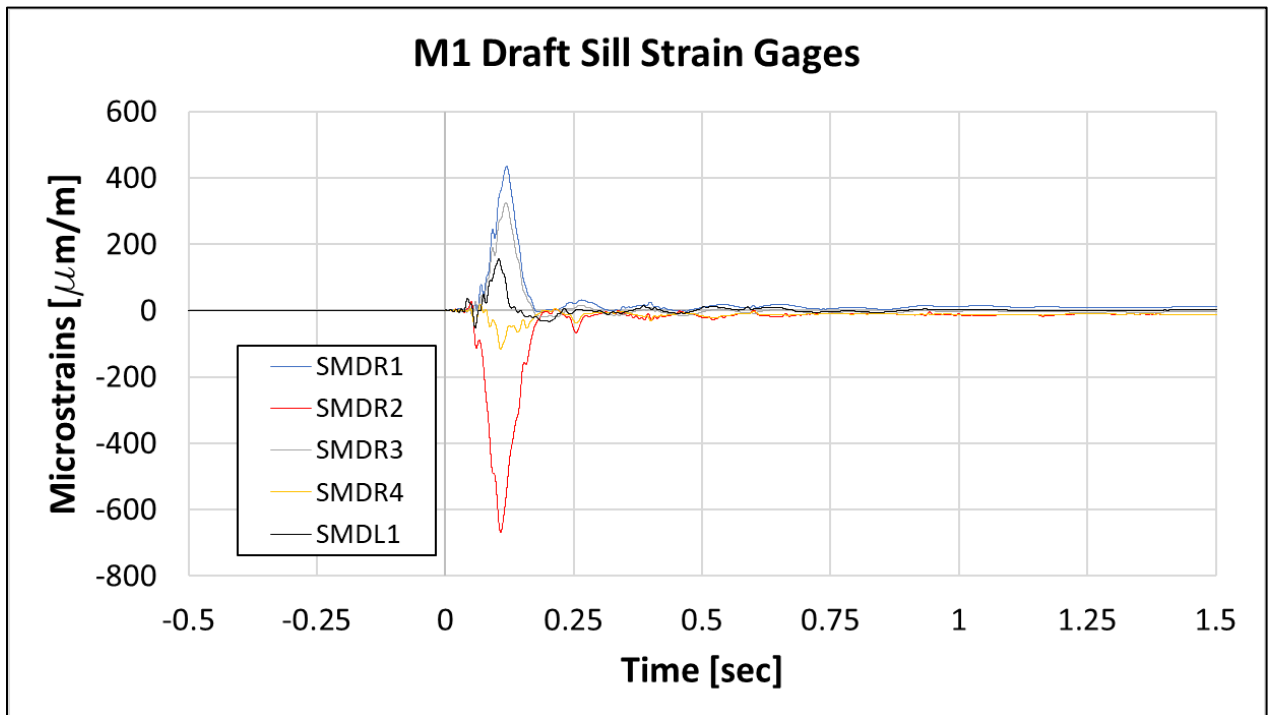

Figure 76. M1 Passenger Car Draft Sill Strain Gages (8 mph)

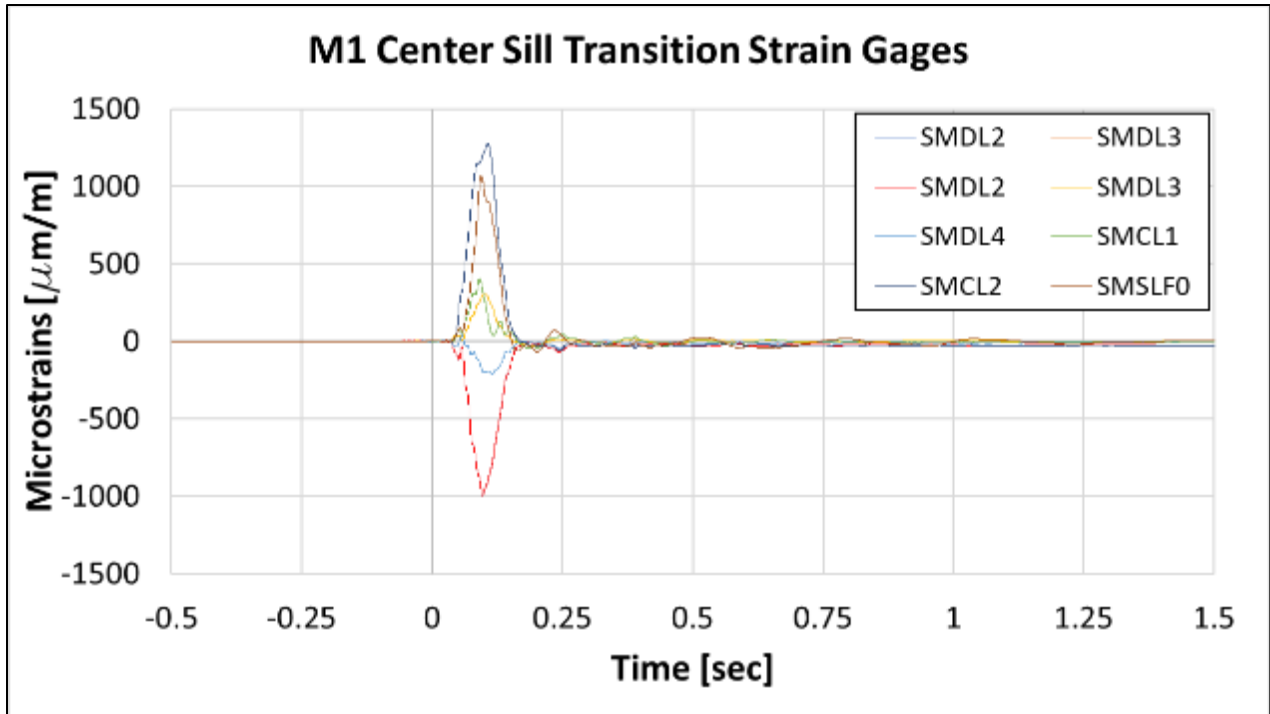

Figure 77. M1 Passenger Car Center Sill Transition Strain Gages (8 mph)

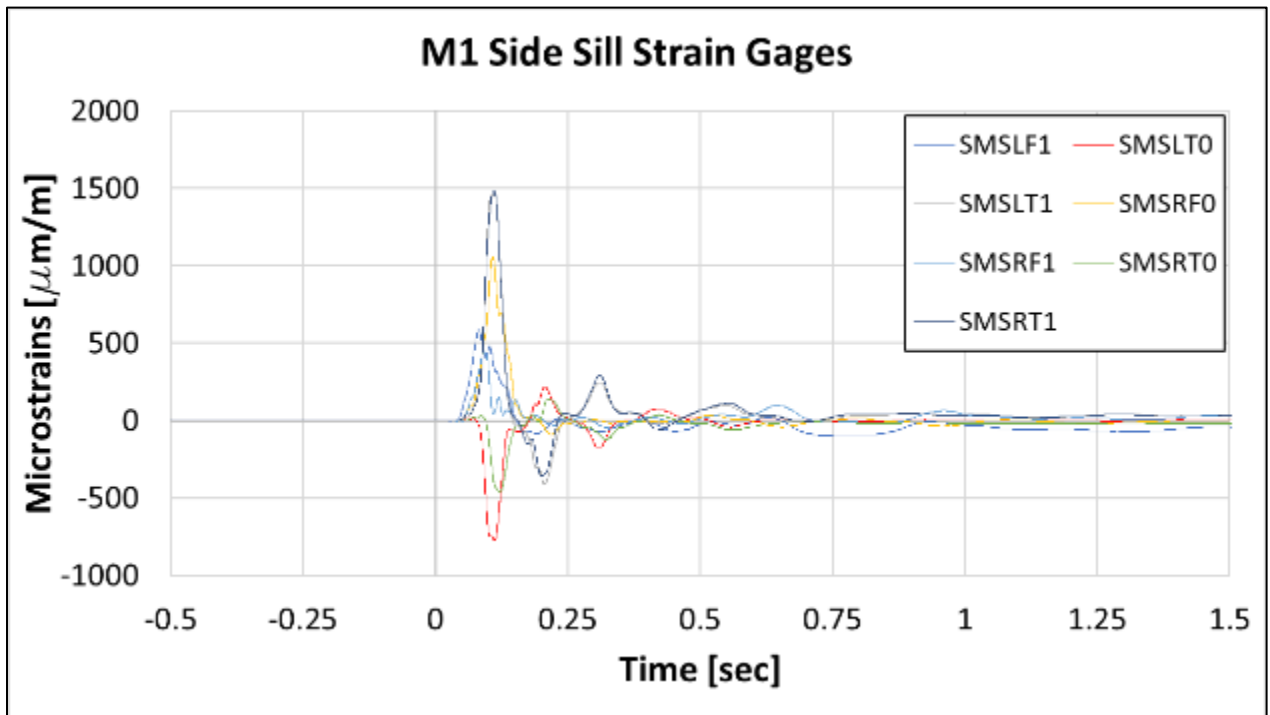

Figure 78. M1 Passenger Car Side Sill Strain Gages (8 mph)

9 mph

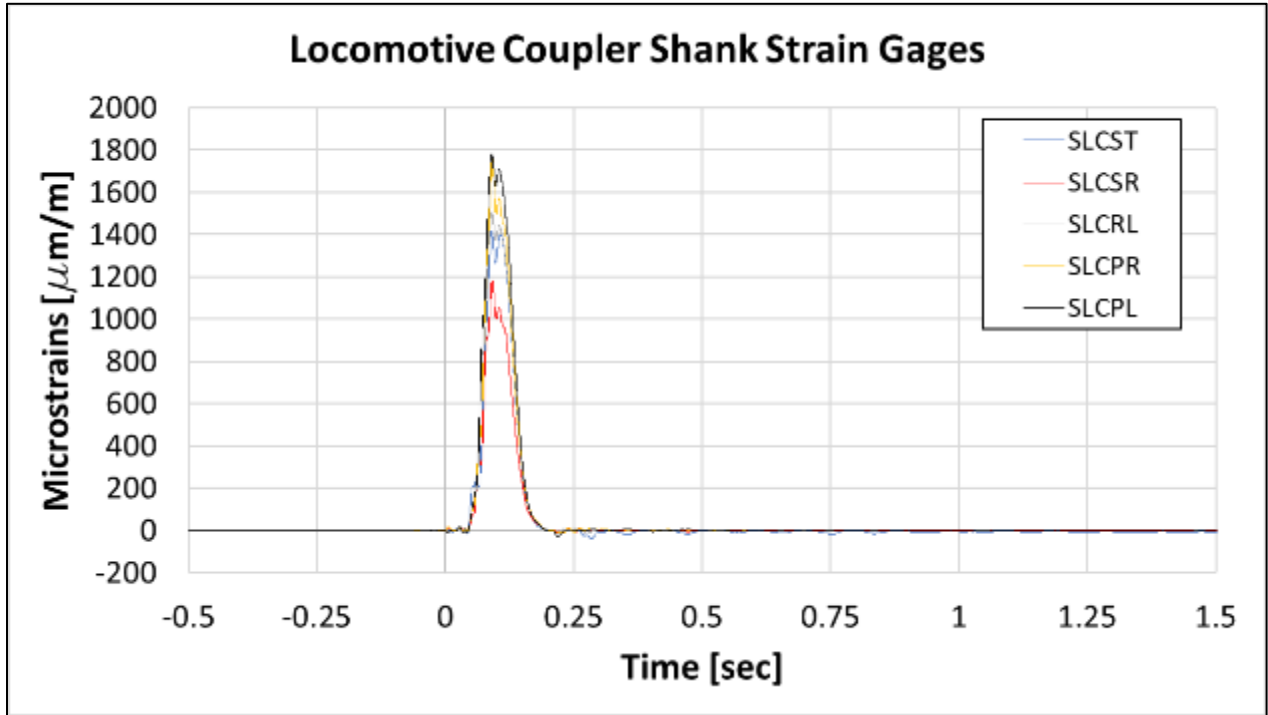

Figure 79. F40 Locomotive Coupler Shank Strain Gages (9 mph)

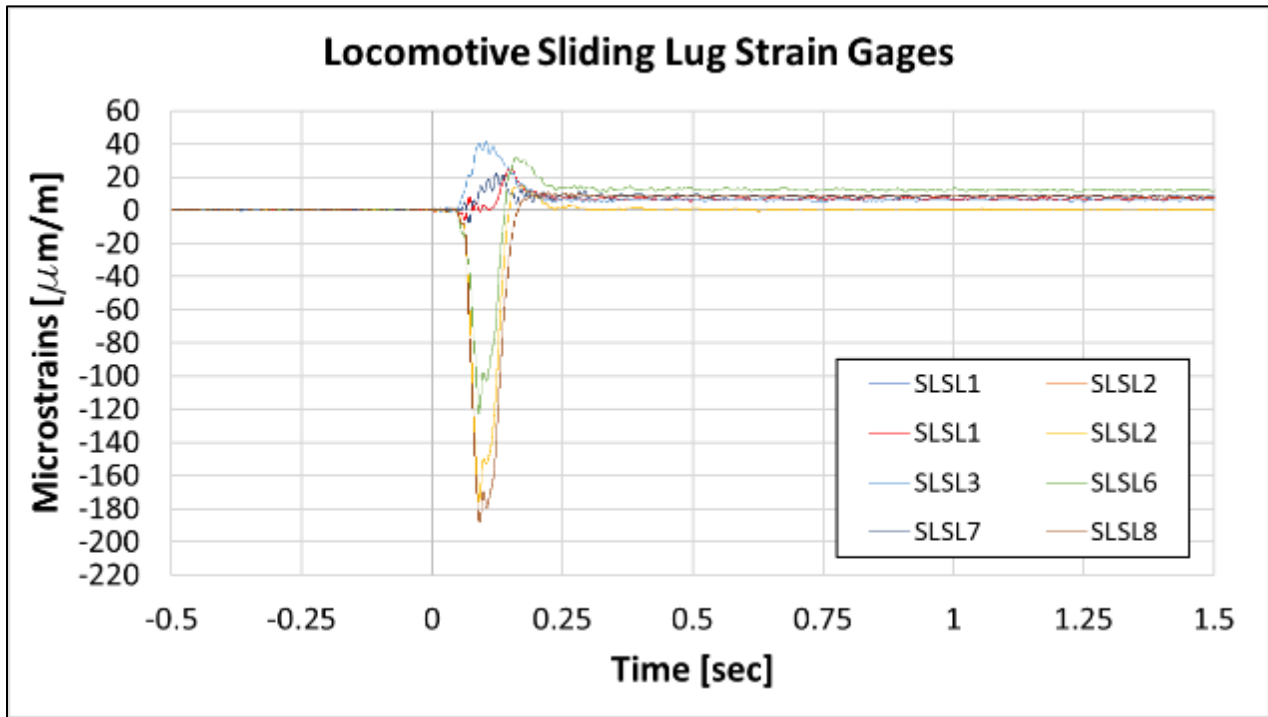

Figure 80. F40 Locomotive Sliding Lug Strain Gages (9 mph)

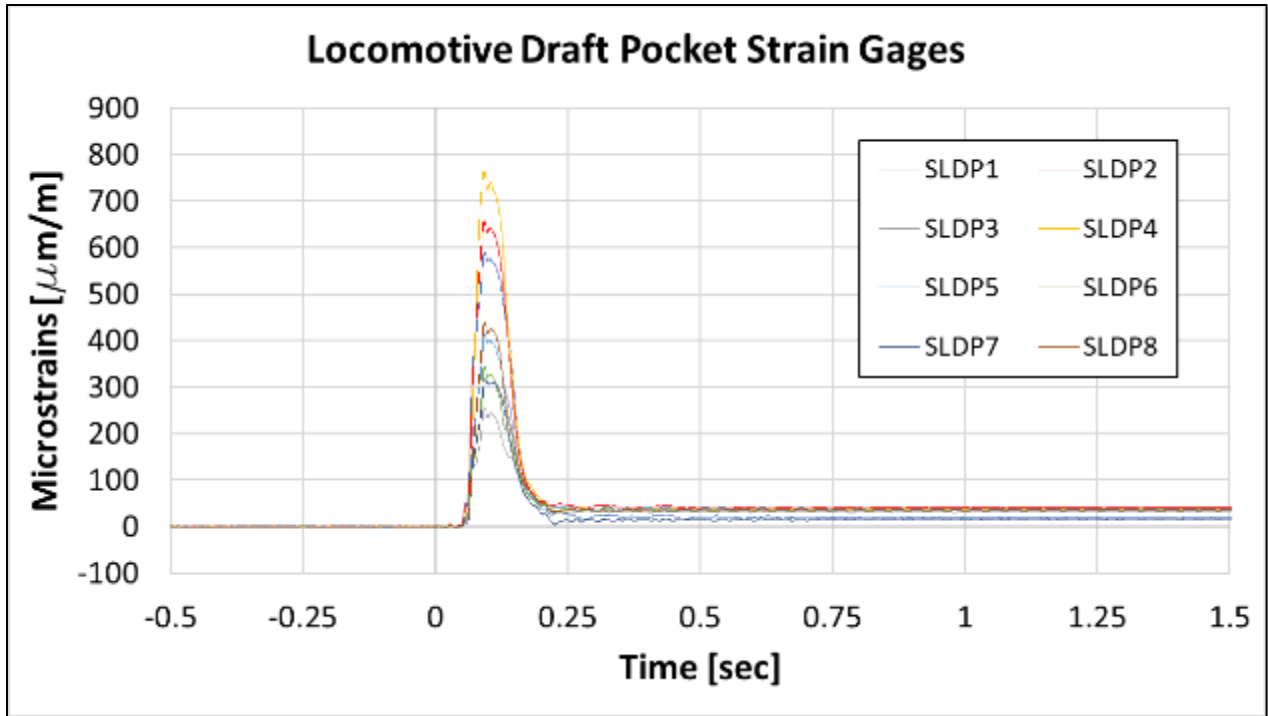

Figure 81. F40 Locomotive Draft Pocket Strain Gages (9 mph)

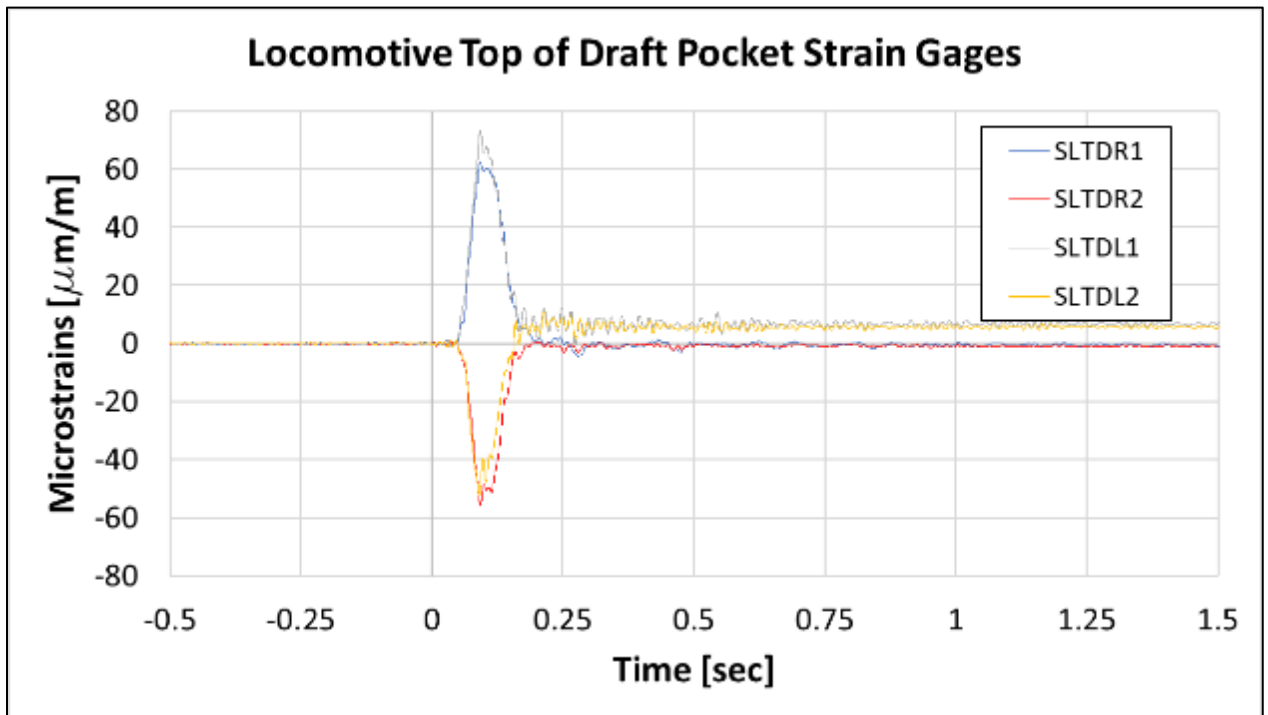

Figure 82. F40 Locomotive Top of Draft Pocket Strain Gages (9 mph)

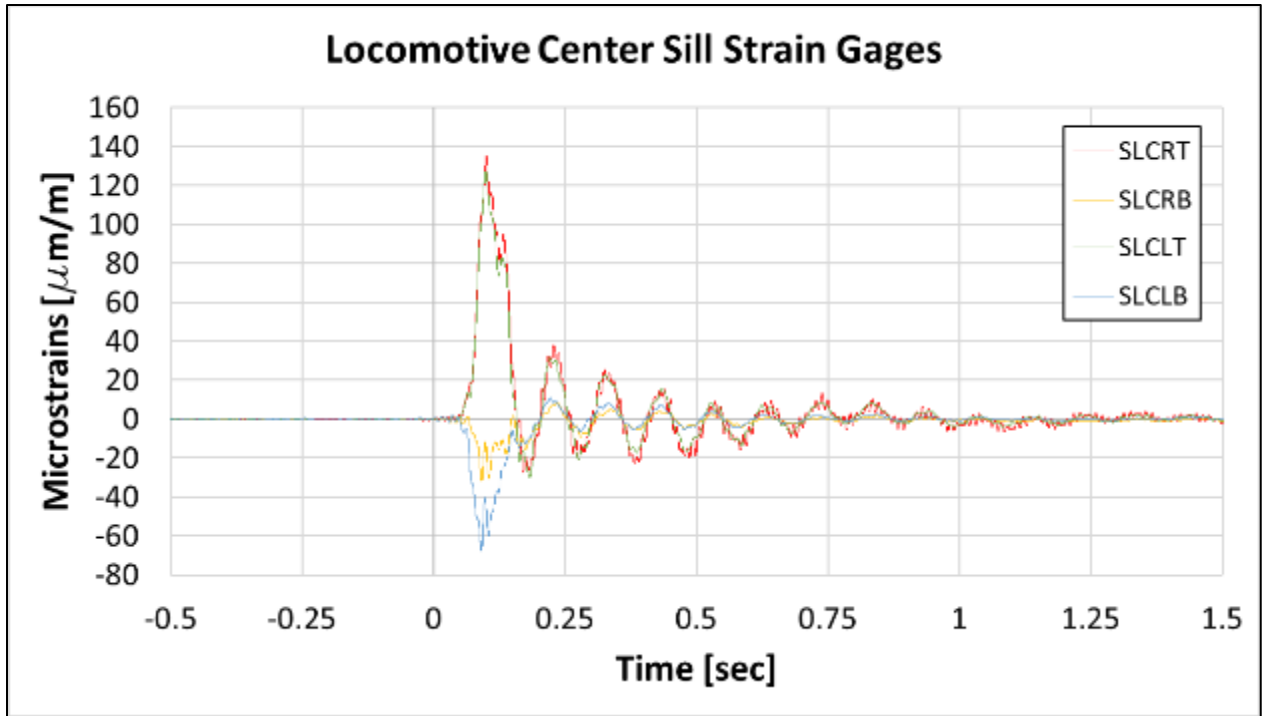

Figure 83. F40 Locomotive Center Sill Strain Gages (9 mph)

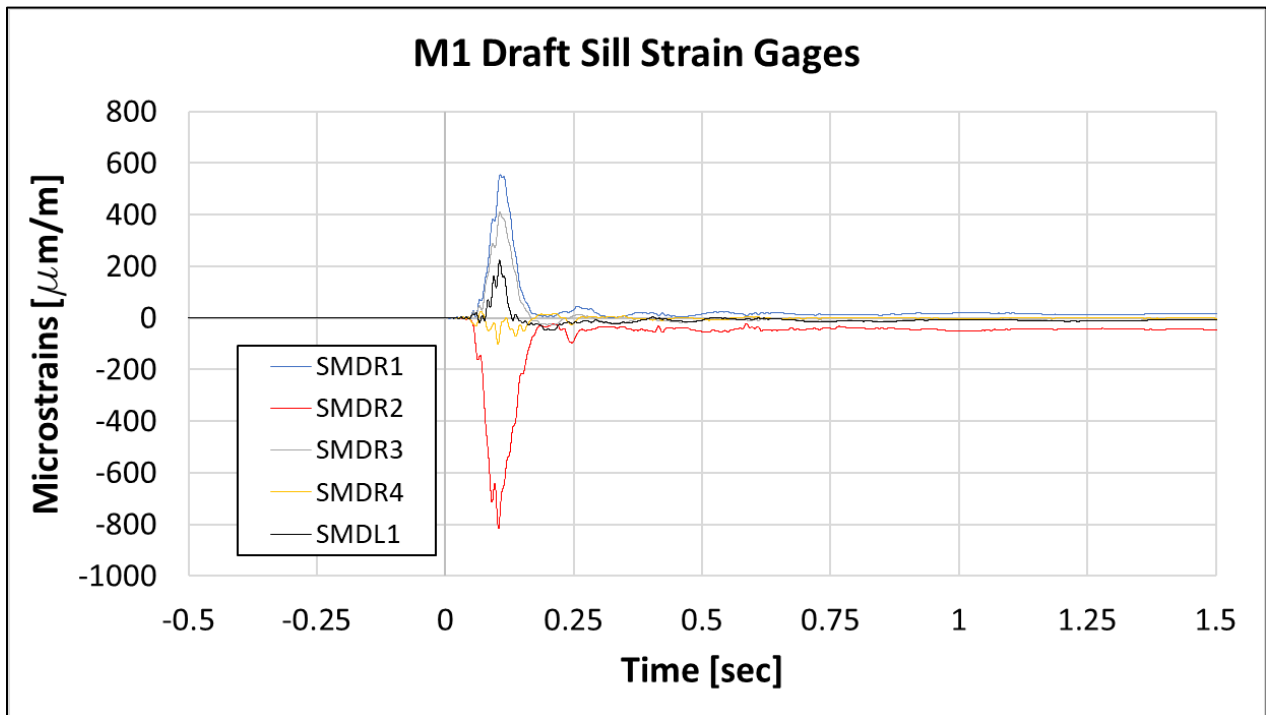

Figure 84. M1 Passenger Car Draft Sill Strain Gages (9 mph)

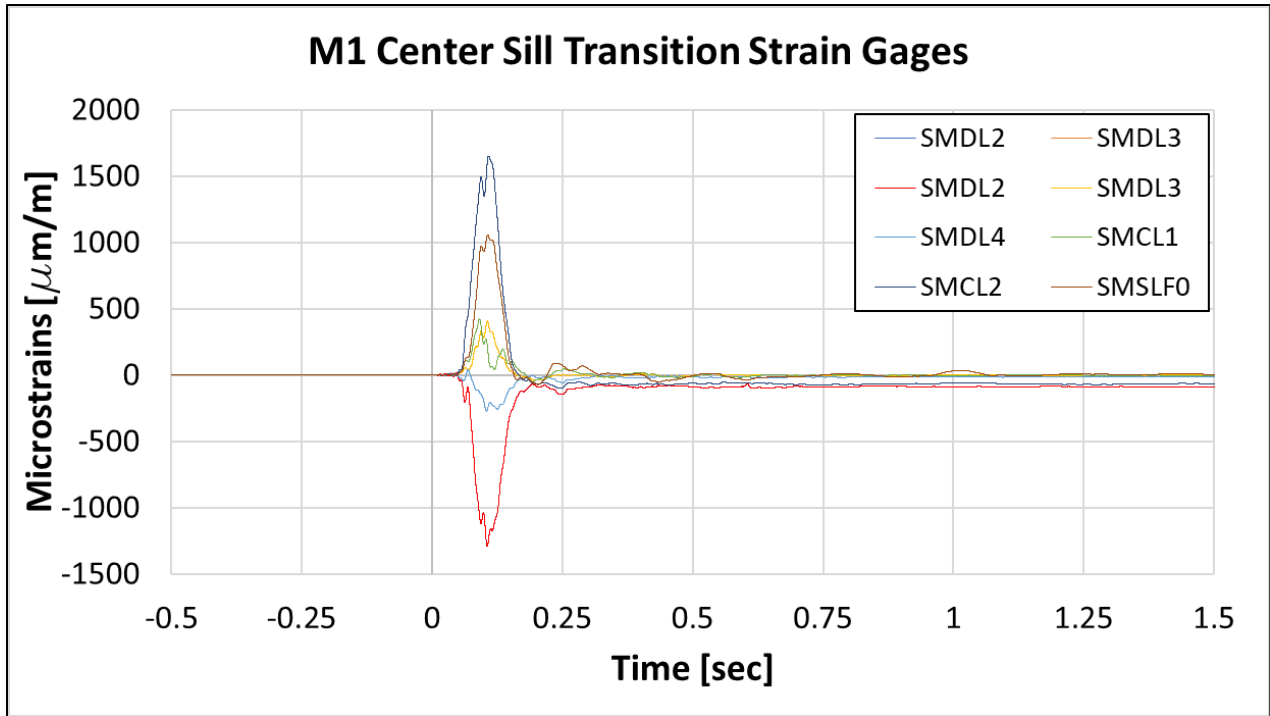

Figure 85. M1 Passenger Car Center Sill Transition Strain Gages (9 mph)

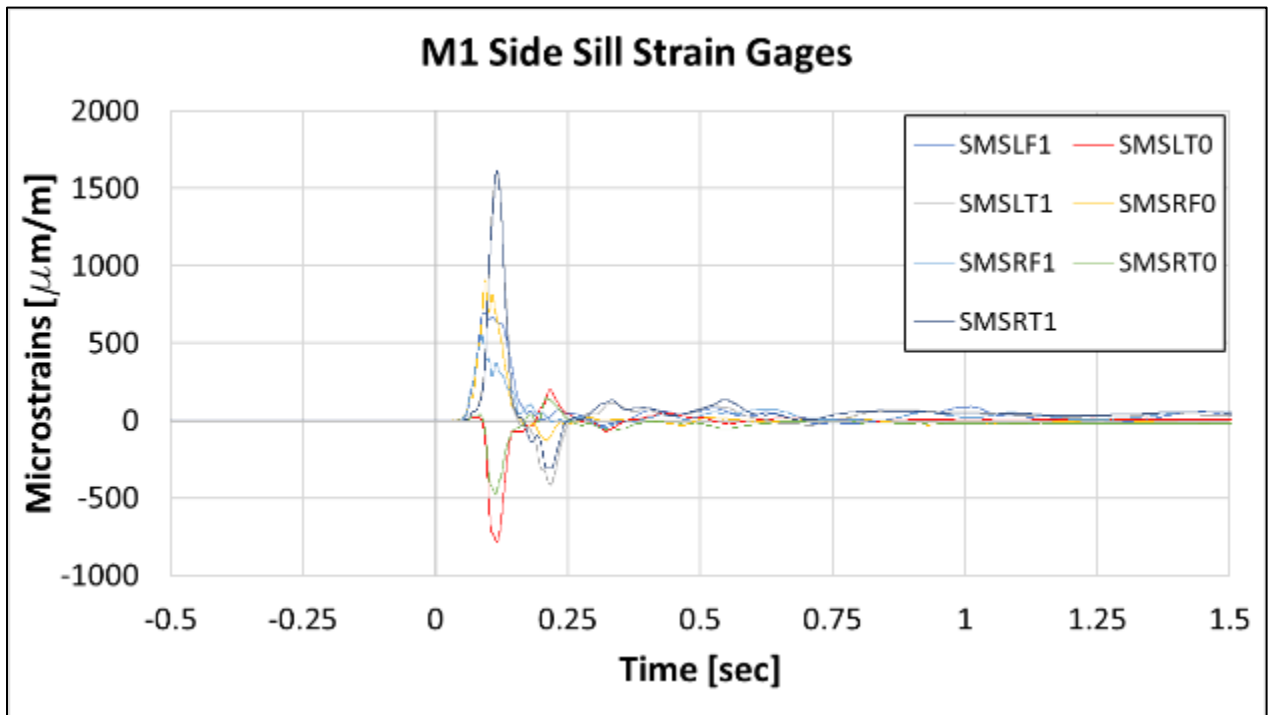

Figure 86. M1 Passenger Car Side Sill Strain Gages (9 mph)

3.2.4 Forces

Impact forces between the F40 locomotive and M1 passenger car can be calculated as a product of the average acceleration and mass of the corresponding vehicle. Figure 87 to Figure 92 show the force history of the F40 and M1.

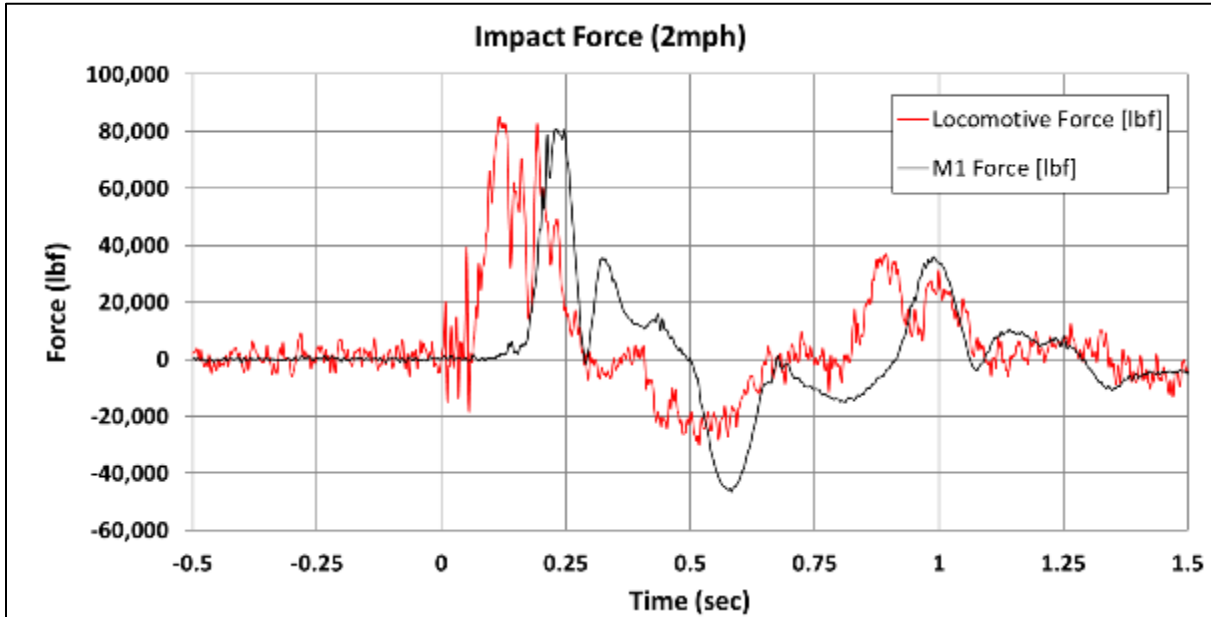

Figure 87. Impact Force at 2 mph

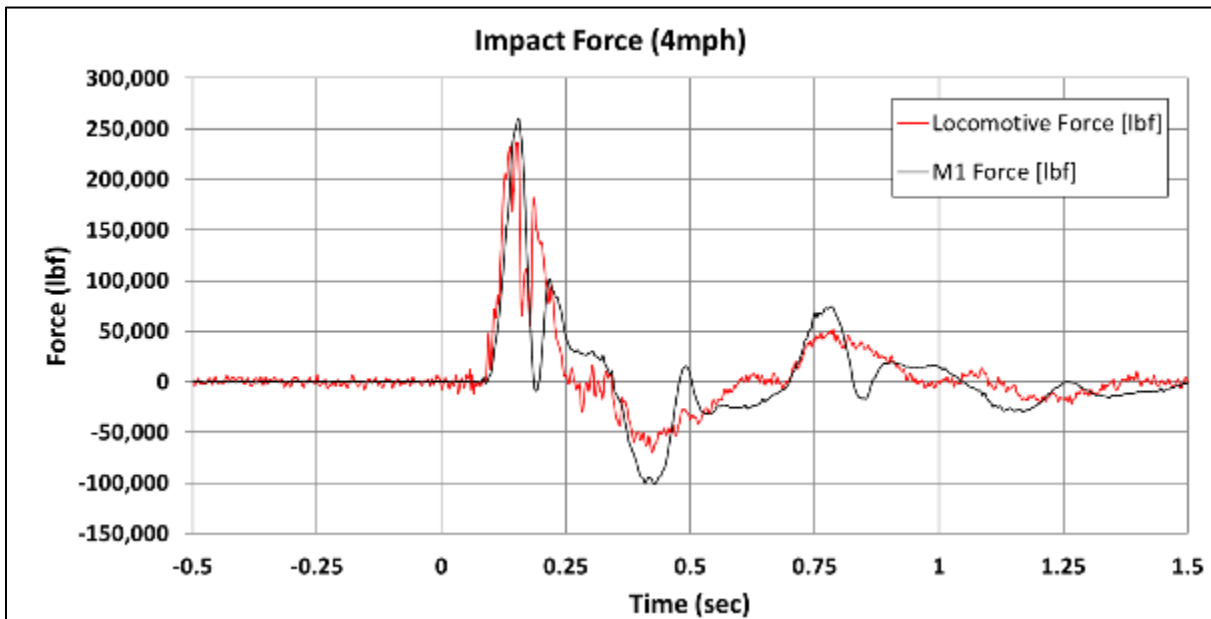

Figure 88. Impact Force at 4 mph

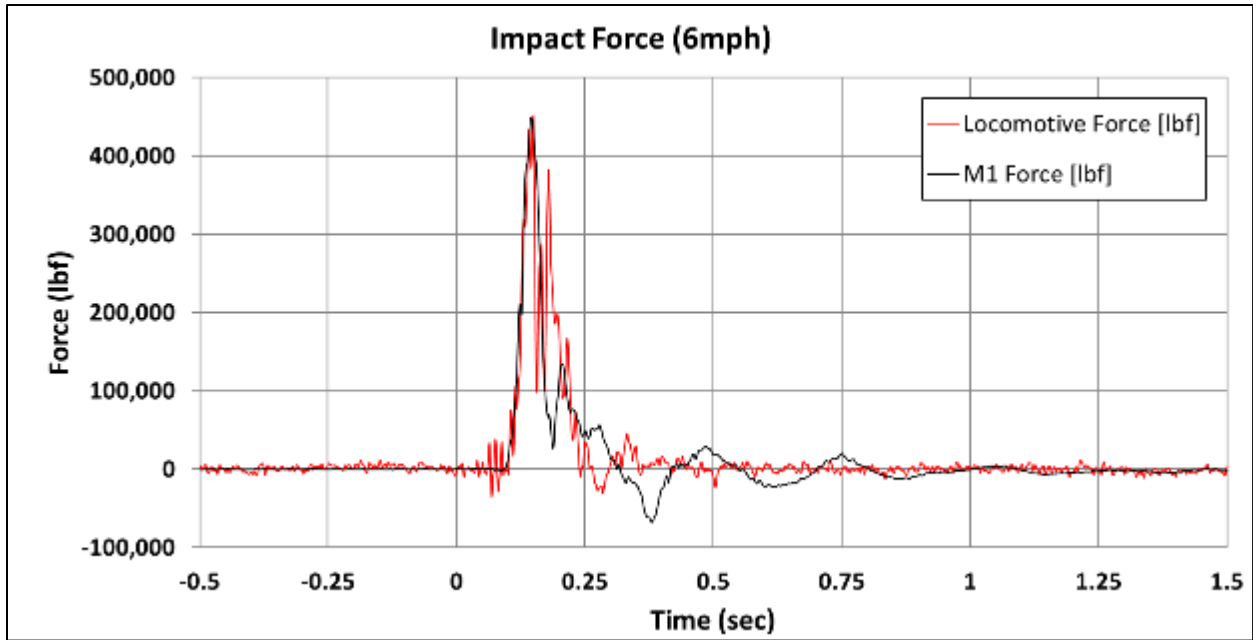

Figure 89. Impact Force at 6 mph

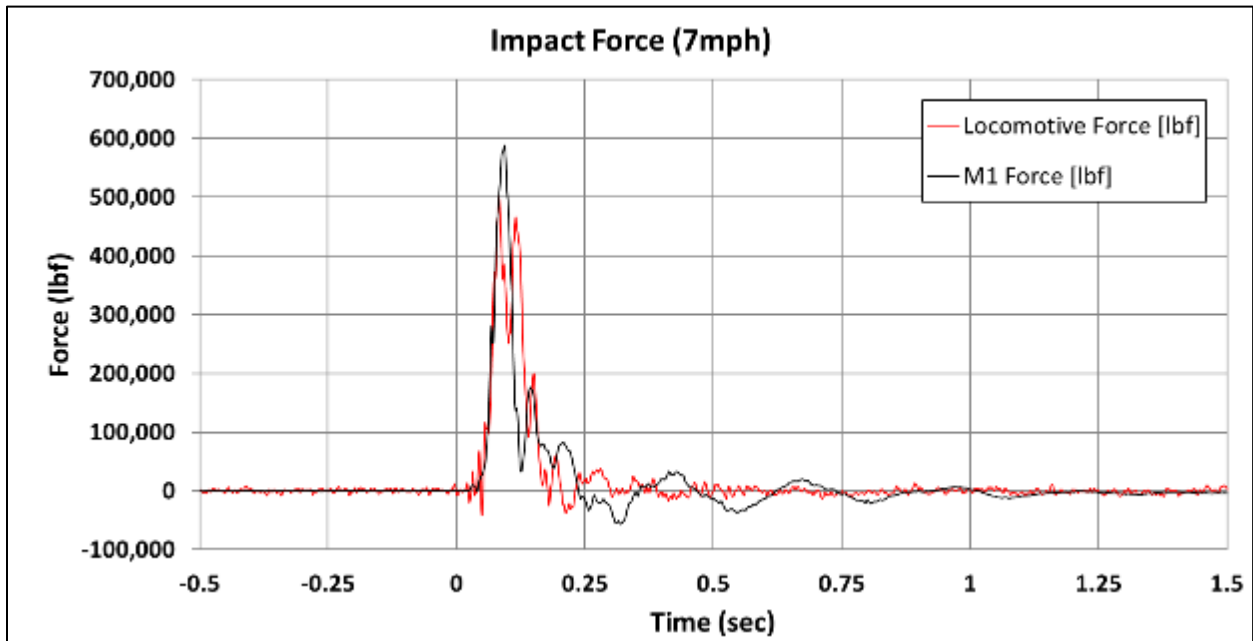

Figure 90. Impact Force at 7 mph

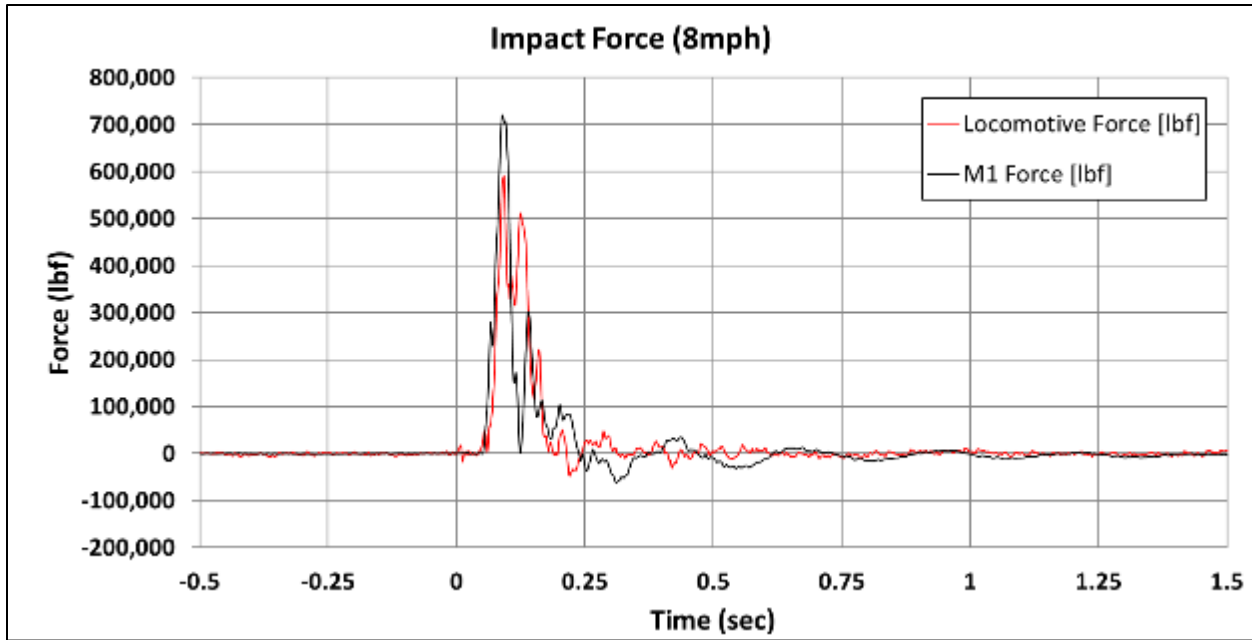

Figure 91. Impact Force at 8 mph

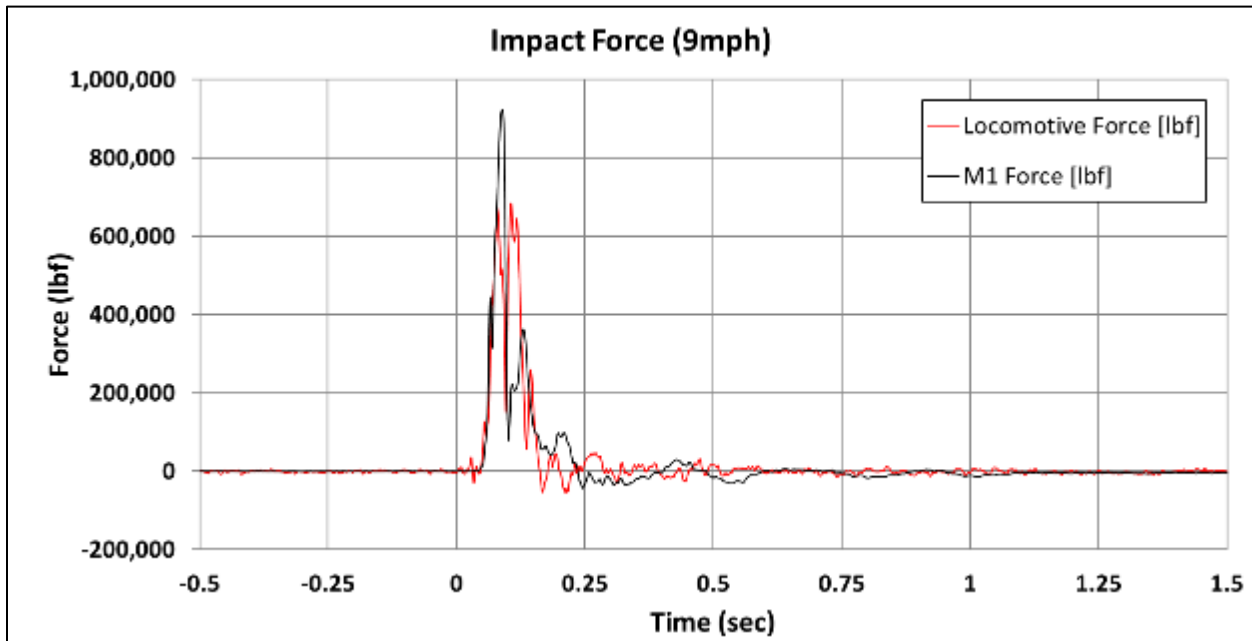

Figure 92. Impact Force at 9 mph

Resultant peak forces on both vehicles were very similar up to a 6 mph impact. After 6 mph, the peak force on the locomotive was lower than on the M1 passenger car. The basic impact principle is balance of the impact force, which means that the force should have been equal on both vehicles. The force was calculated by multiplying vehicle weight and average carbody acceleration. The average acceleration was calculated as described in Section 3.2.1 and was taken from longitudinal accelerometers mounted on the underframe of each vehicle. The

assumption was that the weight was constant. However, the buckled traction rod on the leading M1 truck reduced stiffness of the connection between the truck and carbody. The truck was still attached; therefore, it was not affecting the overall energy calculations, but it would affect the initial force peak. To match the locomotive impact force in 6 mph and 7 mph impacts, the M1 car would need to be approximately 14,000 lbs lighter—which corresponds to the weight of a single truck. However, to match the 9 mph impact force, the M1 car would need to be approximately 24,000 lbs lighter, which meant the trailing truck connection to the carbody was compromised.

3.2.5 Energies

Energy balance is the summary of the energy evolution during the impact. The total energy at the beginning of the impact is equal to the kinetic energy of the locomotive. After the first impact, the F40 locomotive and the M1 passenger car moved forward on the track until they stopped. Energy due to the track grade after the impact was accounted for as “added energy” to the system, and linearly increased from the impact point to the point where both the F40 and the M1 stopped. The other energies in the energy balance were the kinetic energy of both vehicles and the dissipated energy that accounted for deformation, braking, and other energy losses. Because the energies should balance, the dissipated energy was obtained by subtracting the kinetic energies from the total energy. Figure 93 to Figure 98 show the energy balance for each impact speed.

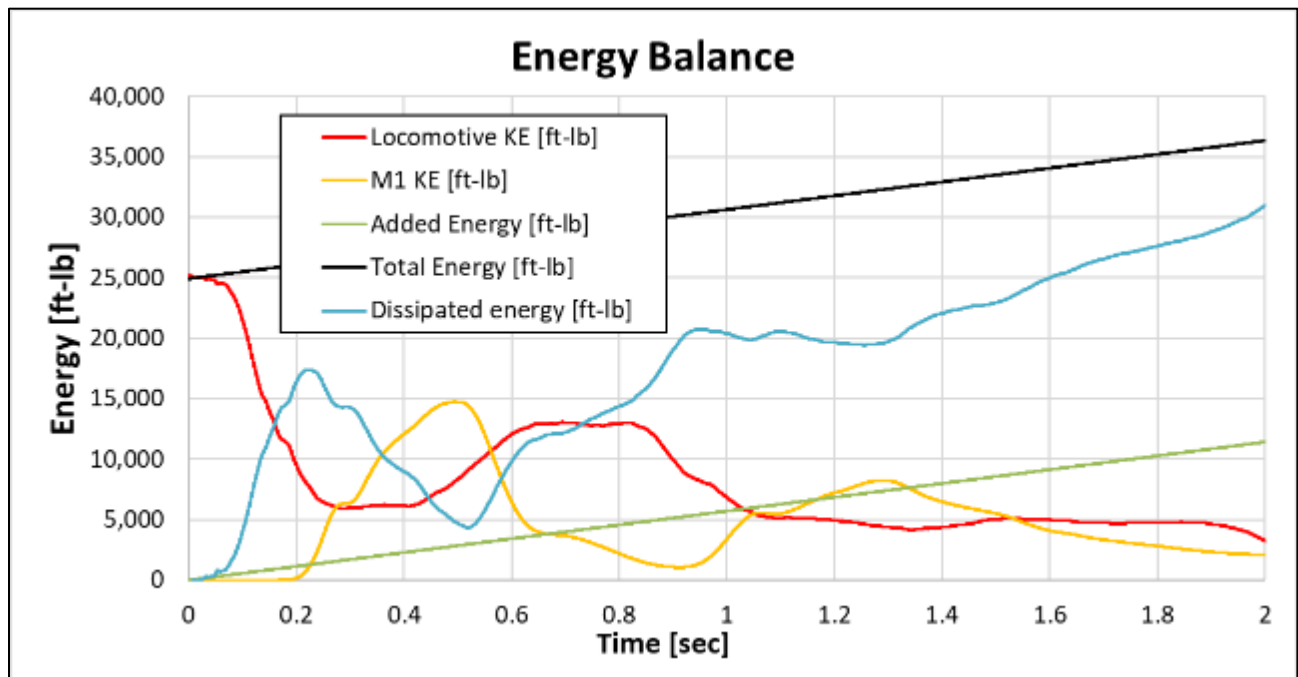

Figure 93. Energy Balance at 2 mph

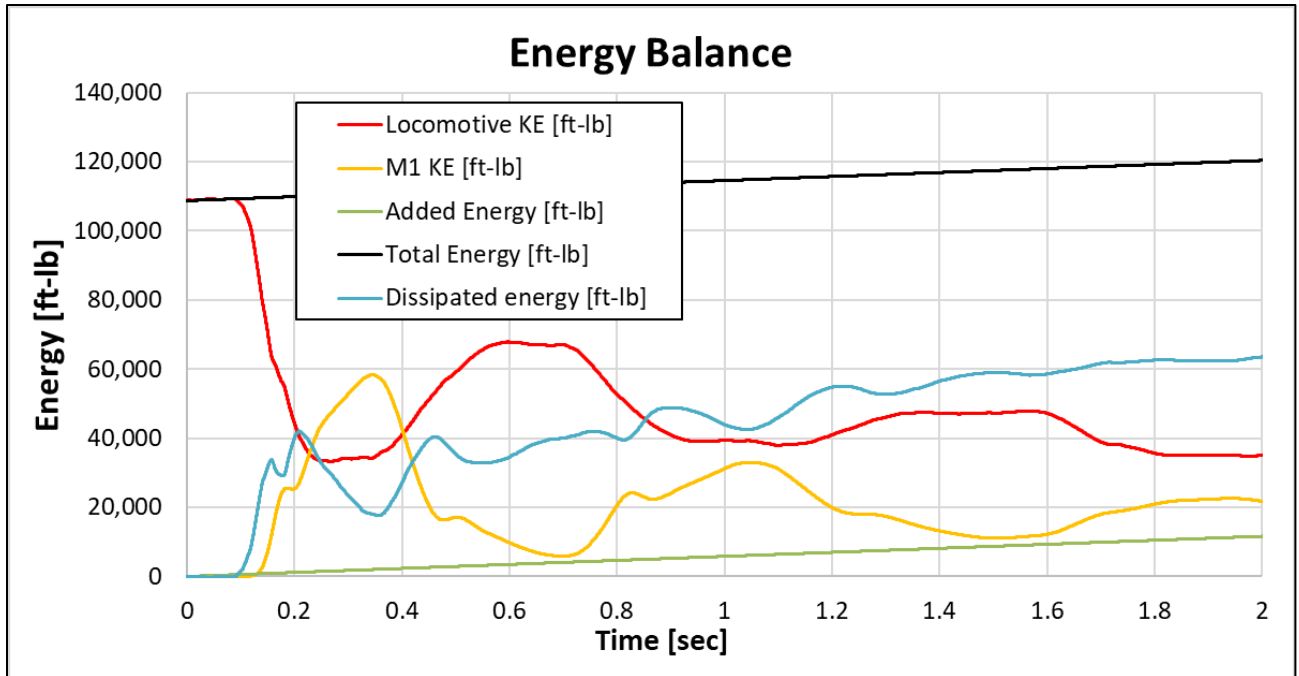

Figure 94. Energy Balance at 4 mph

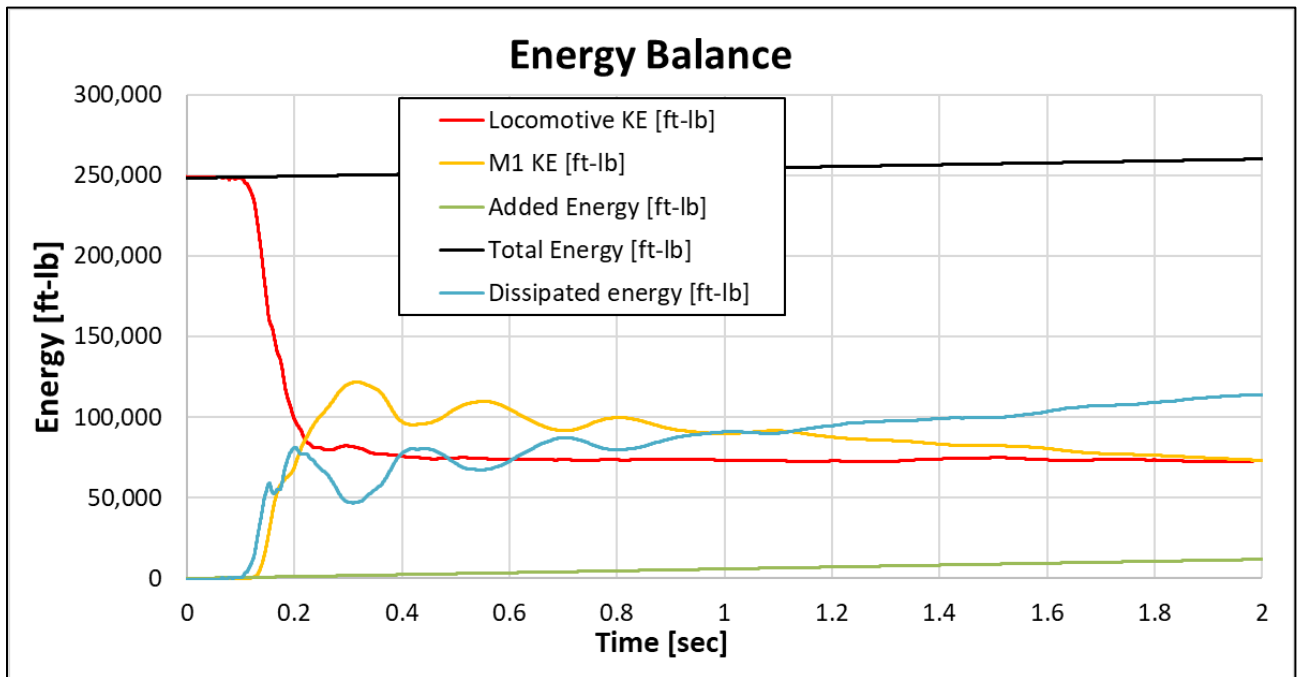

Figure 95. Energy Balance at 6 mph

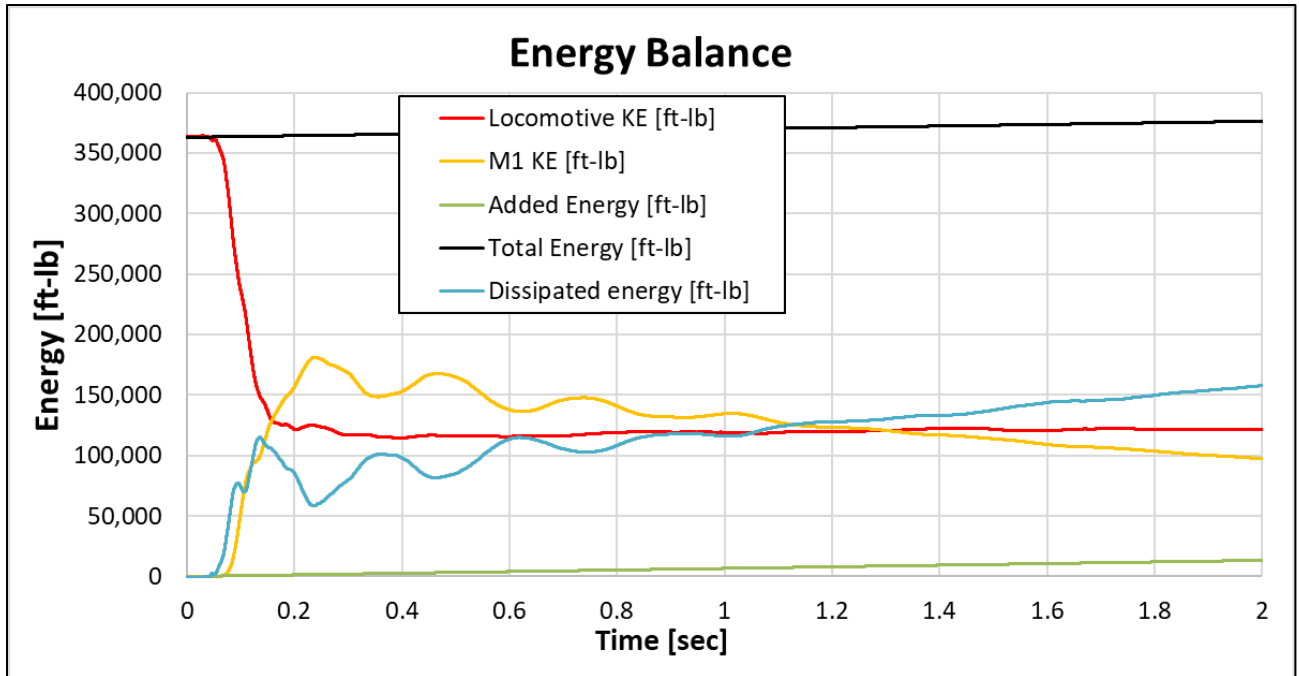

Figure 96. Energy Balance at 7 mph

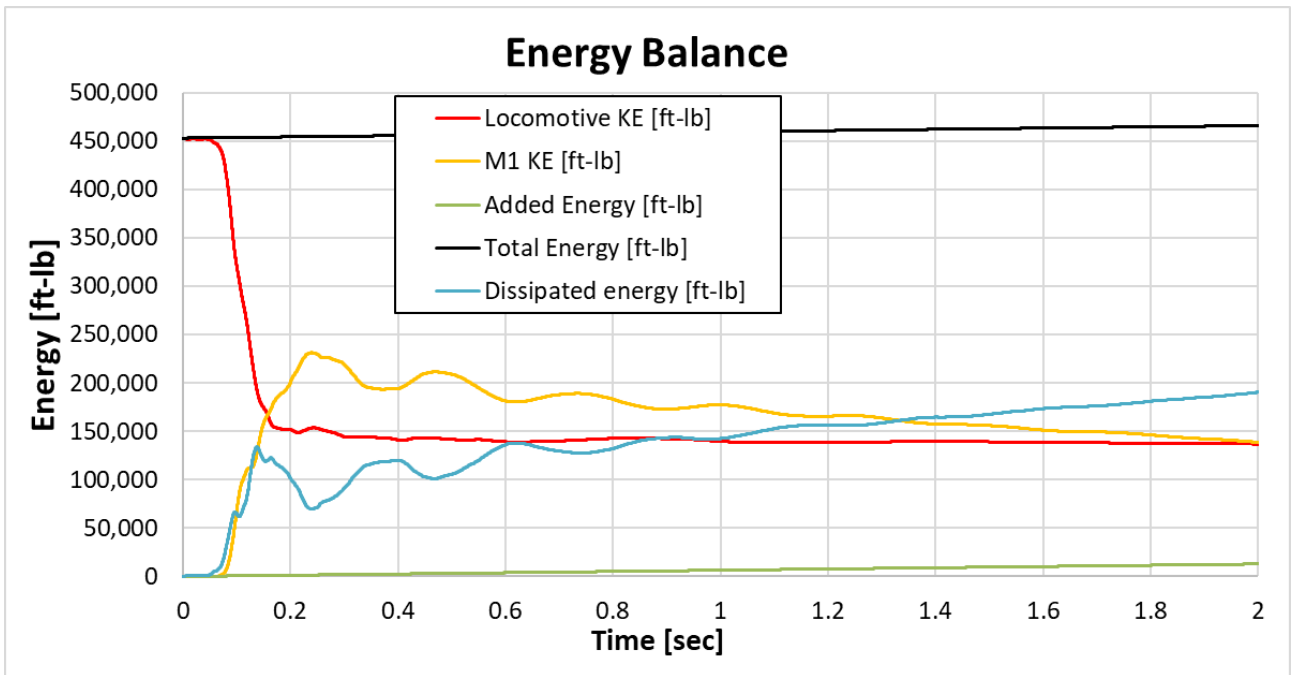

Figure 97. Energy Balance at 8 mph

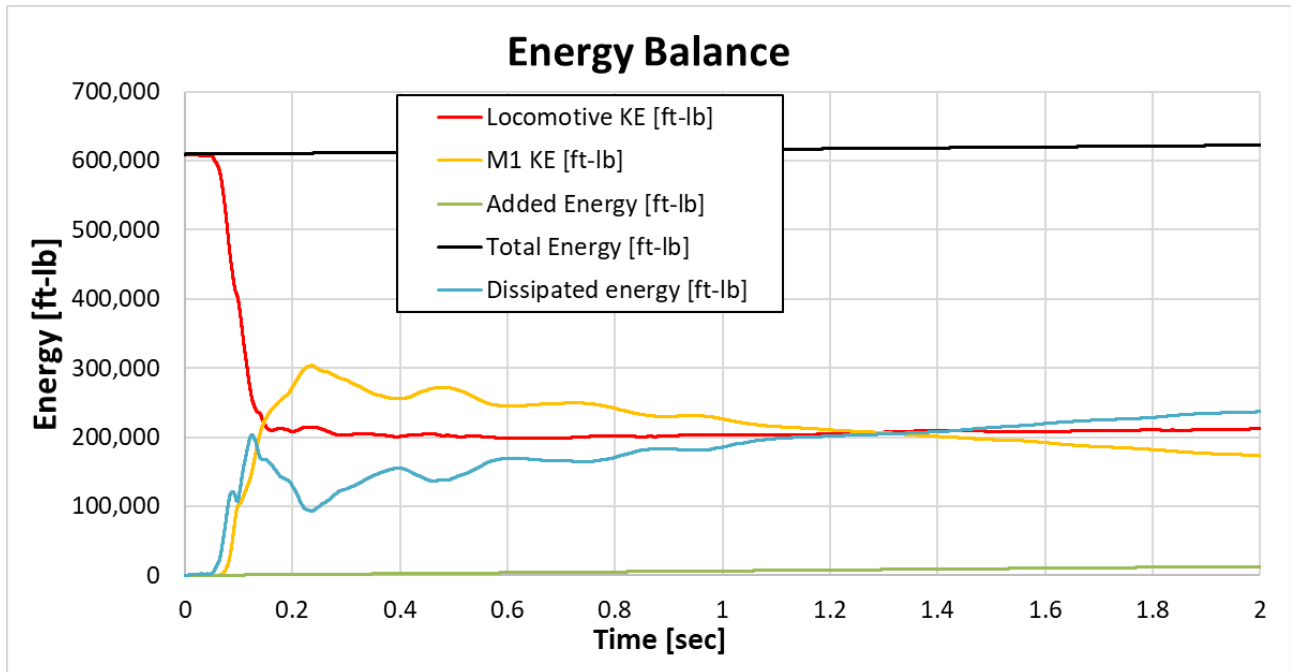

Figure 98. Energy Balance at 9 mph

3.3 Post-Test Damage

One of the M1 passenger car traction rods buckled after the third test (Figure 99) at 5.7 mph, and it was replaced with an original traction rod taken from a different M1 passenger car. During the fourth test at 6.8 mph, the traction rod buckled again (Figure 100) and was not replaced. During the last two tests, the traction rod deformation continued to increase. Pictures of the traction rod after the fifth and sixth tests are shown in Figure 101 and Figure 102.



Figure 99. Bent Traction Rod after Third Test



Figure 100. Bent Traction Rod after Fourth Test



Figure 101. Bent Traction Rod after Fifth Test



Figure 102. Bent Traction Rod after Sixth Test

4. Conclusion

This report documents the coupler impact tests between a passenger car and a locomotive retrofitted with CEM components. This testing was intended to evaluate the minimum force and establish impact speed to activate the retrofitted PBC.

TTCI conducted these impact tests on October 3 and 4, 2017, at the TTC in Pueblo, Colorado.

The M1 passenger car was impacted by the 232,600-lb locomotive six times, with increasing speeds of 1.8 mph, 3.74 mph, 5.66 mph, 6.84 mph, 7.63 mph, and 8.85 mph. The car and locomotive successfully coupled during the 1.8 mph and 3.74 mph tests, but failed to couple during the other impacts at higher speeds. The vertical coupler misalignment between the locomotive and the M1 car was noted and corrected by shims before the test; however, this could have influenced the coupling performance. The car and locomotive continued to move after each impact, which, due to the downhill track grade, added additional energy to the system. Knowing the traveled distance, it was possible to account for that additional energy in the energy balance calculations.

The most substantial damage that occurred during each test was inflicted upon the M1 passenger car. After the second test, the traction rod buckled and was replaced for the next test. During the third test, the traction rod buckled again and was not replaced for subsequent tests.

The tests showed that the PBC activated at the impact speed of 8.85 mph, with a corresponding force of approximately 680,000 lbs. The PBC crushable tube was pushed approximately 1 inch from the initial position after the last test.

Project researchers recommend adding longitudinal accelerometers on M1 car trucks to confirm the delay in truck and carbody motions that influence impact force calculations.

5. References

1. Instrumentation for Impact Test – Part 1 – Electronic Instrumentation. 1995 (2007). SAE International, Warrendale, PA. Retrieved from https://www.sae.org/standards/content/j211/1_201403/

**Appendix A.
Target Positions**

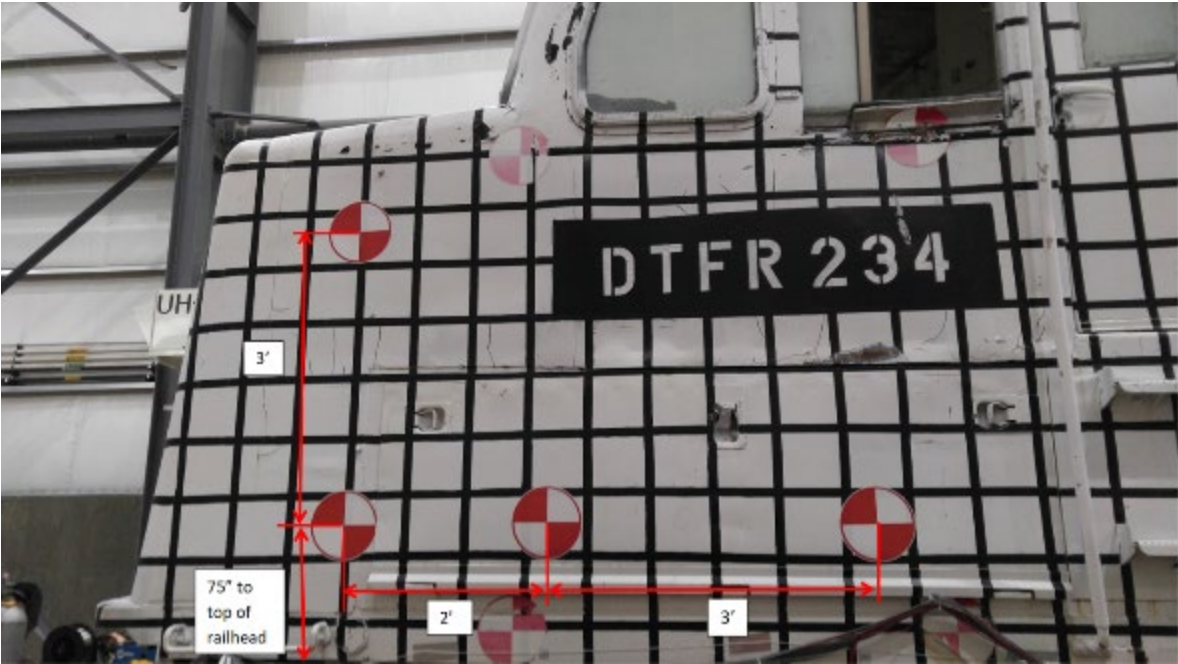

Figure A1. Target Positions for Locomotive



Figure A2. Target Positions for M1 Passenger Car

Appendix B. 2 mph Test Data

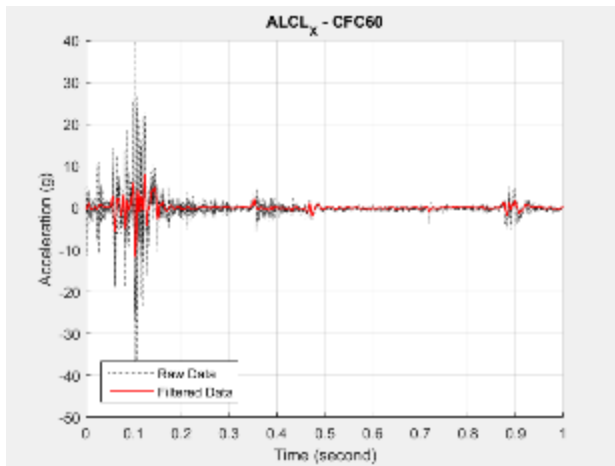

Figure B1. ALCL_X Accelerometer Data

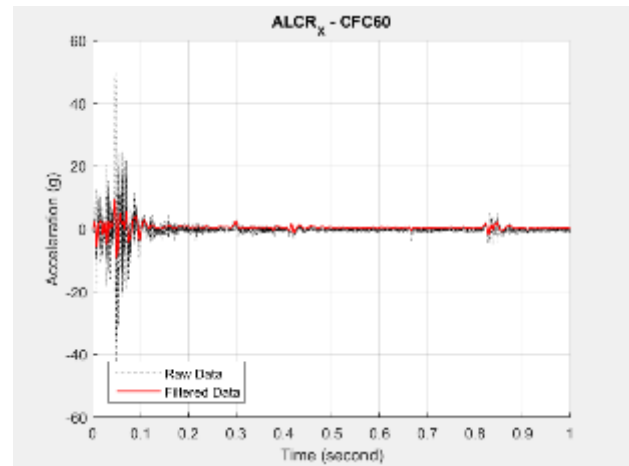

Figure B2. ALCR_X Accelerometer Data

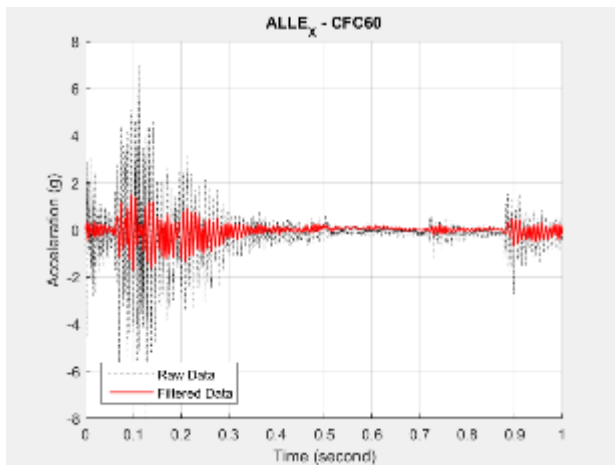

Figure B3. ALLE_X Accelerometer Data

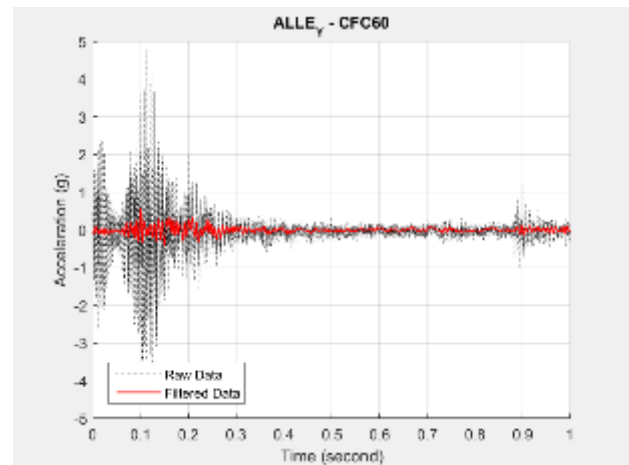

Figure B4. ALLE_Y Accelerometer Data

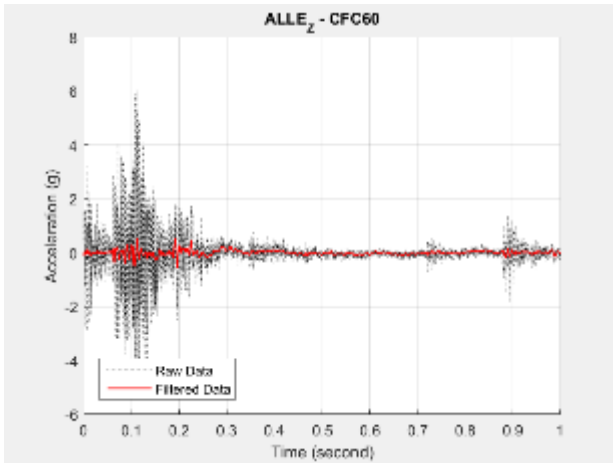

Figure B5. ALLE_Z Accelerometer Data

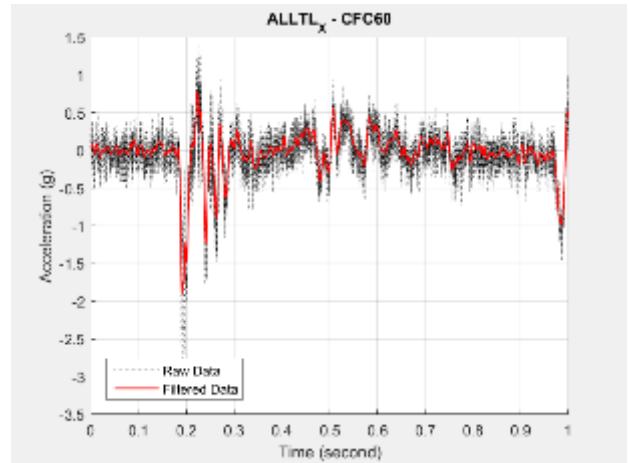

Figure B6. ALLTL_X Accelerometer Data

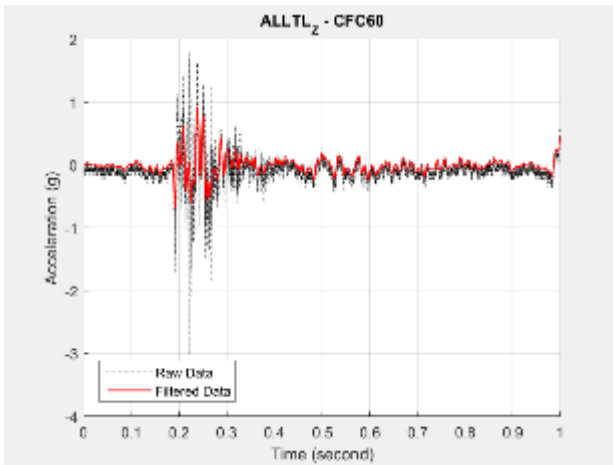

Figure B7. ALLTL_Z Accelerometer Data

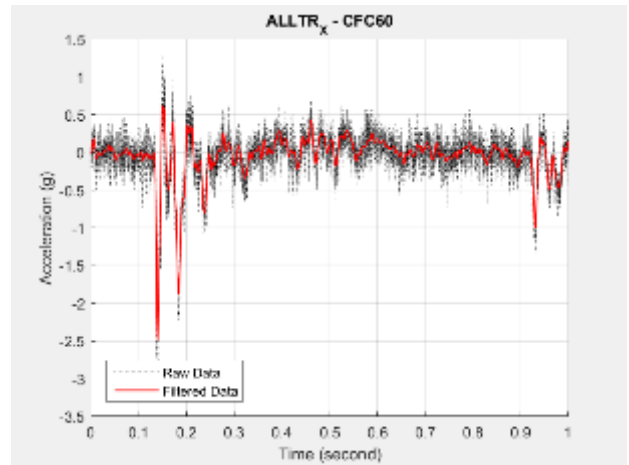

Figure B8. ALLTR_X Accelerometer Data

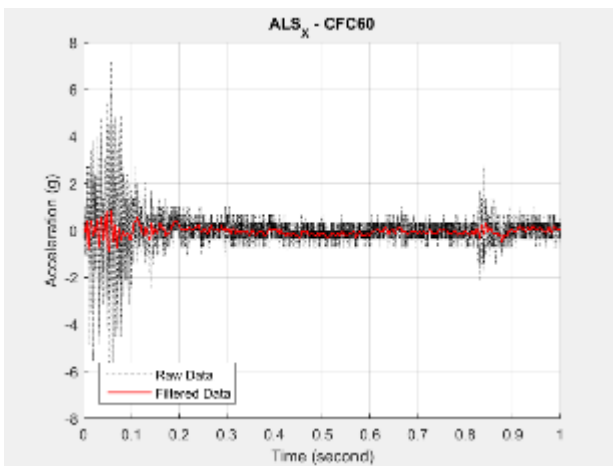

Figure B9. ALS_X Accelerometer Data

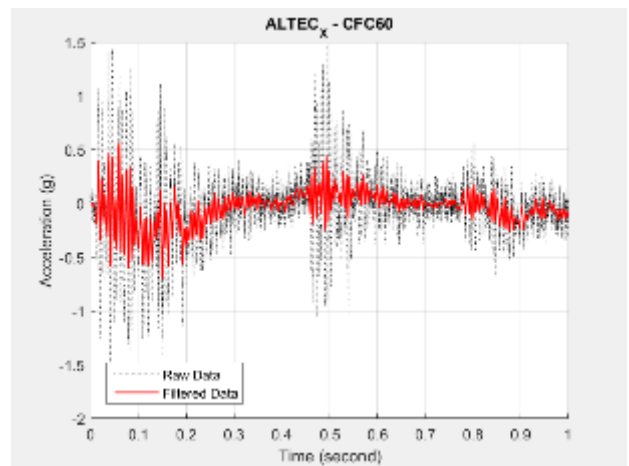

Figure B10. ALTEC_X Accelerometer Data

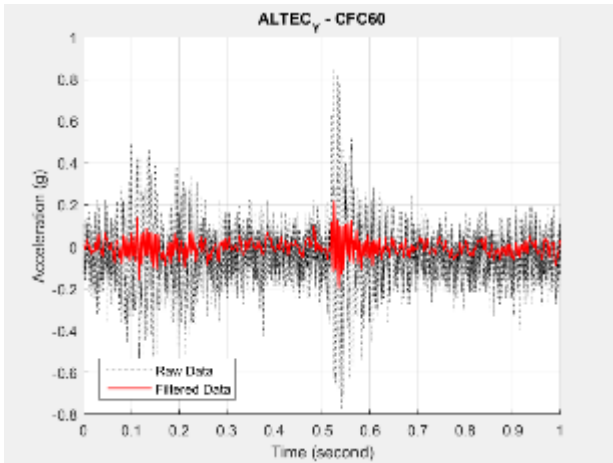

Figure B11. ALTEC_Y Accelerometer Data

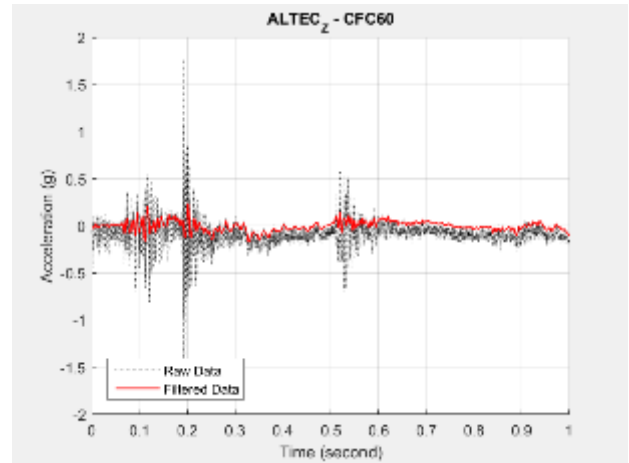

Figure B12. ALTEC_Z Accelerometer Data

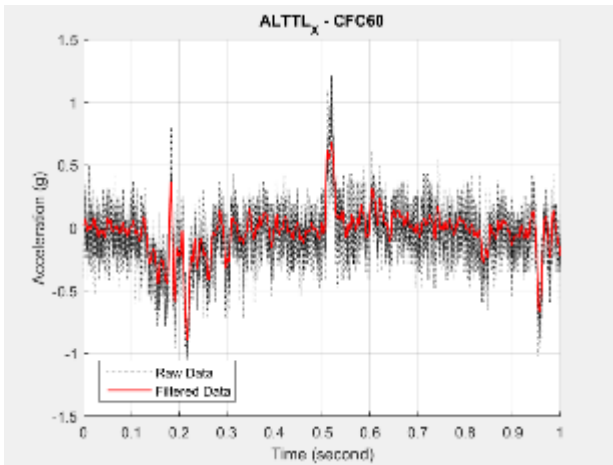

Figure B13. ALTTL_X Accelerometer Data

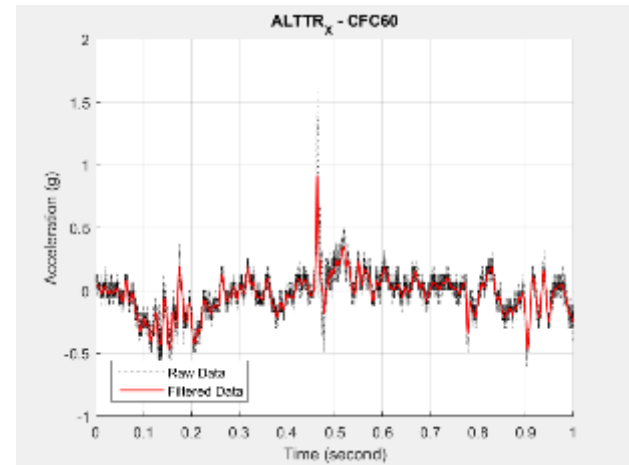

Figure B14. ALTTR_X Accelerometer Data

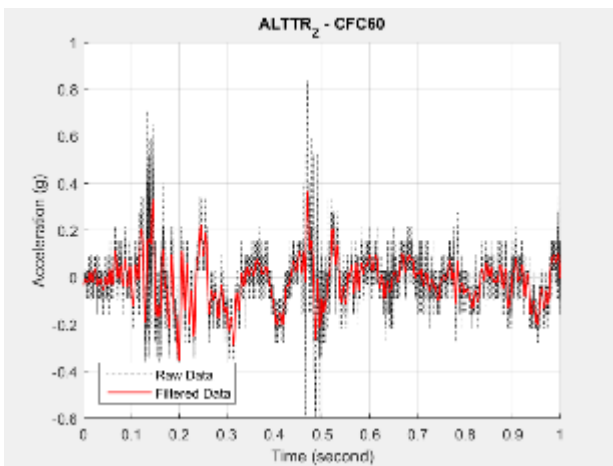

Figure B15. ALTTR_Z Accelerometer Data

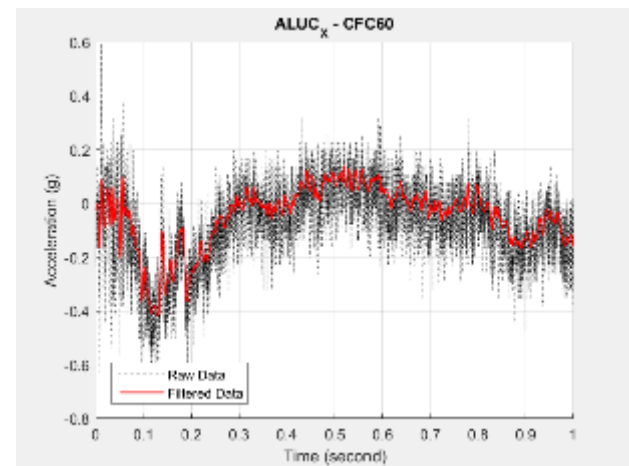

Figure B16. ALUC_X Accelerometer Data

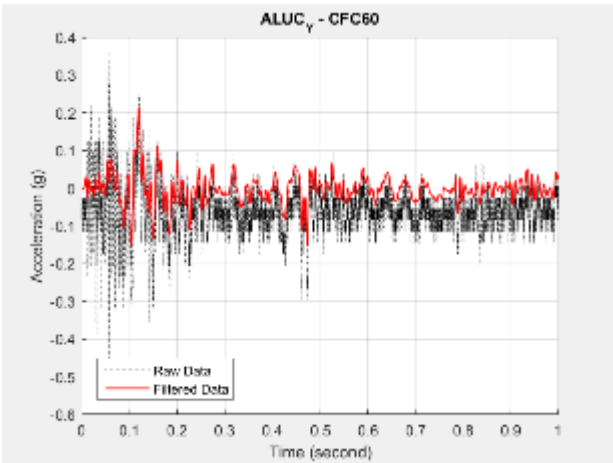

Figure B17. ALUC_Y Accelerometer Data

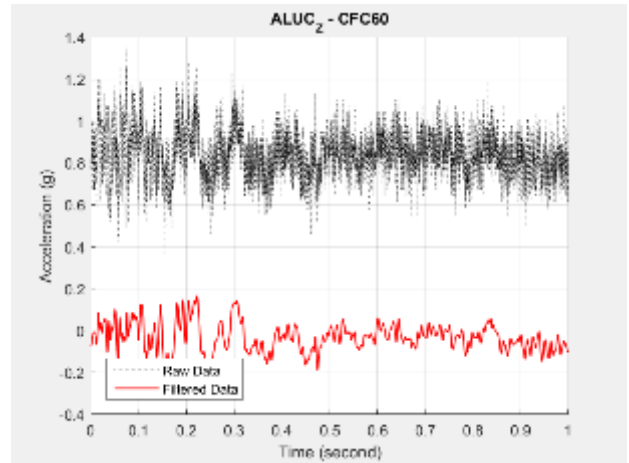

Figure B18. ALUC_Z Accelerometer Data

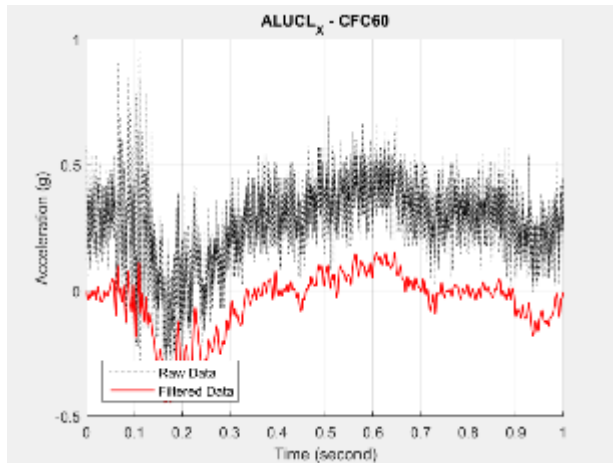

Figure B19. ALUCL_X Accelerometer Data

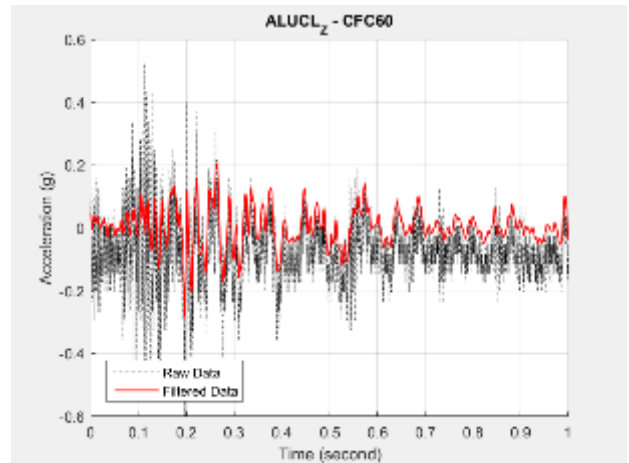

Figure B20. ALUCL_Z Accelerometer Data

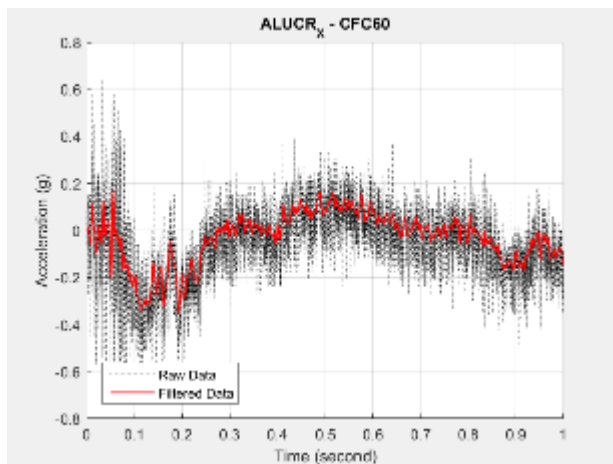

Figure B21. ALUCR_X Accelerometer Data

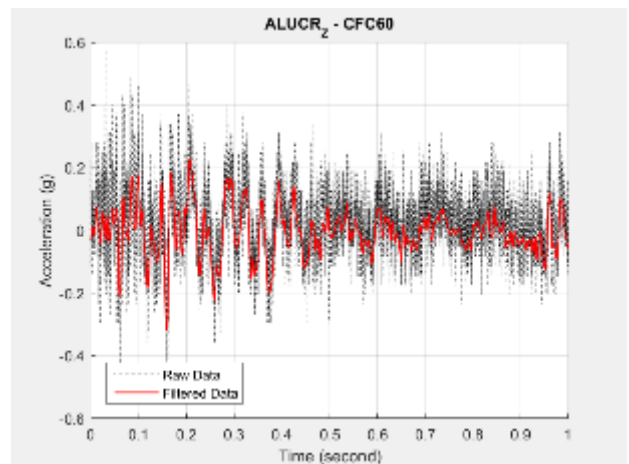

Figure B22. ALUCR_Z Accelerometer Data

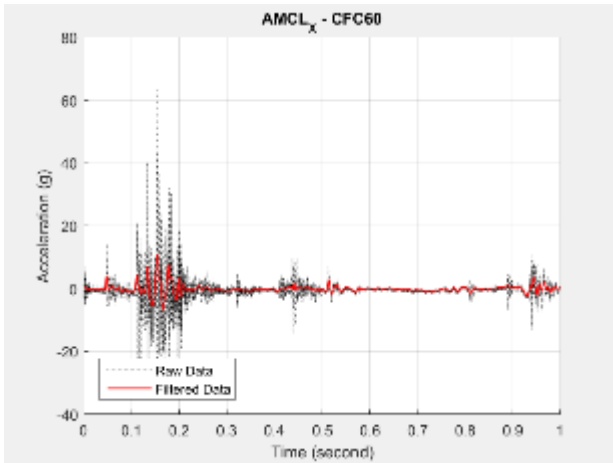

Figure B23. AMCL_X Accelerometer Data

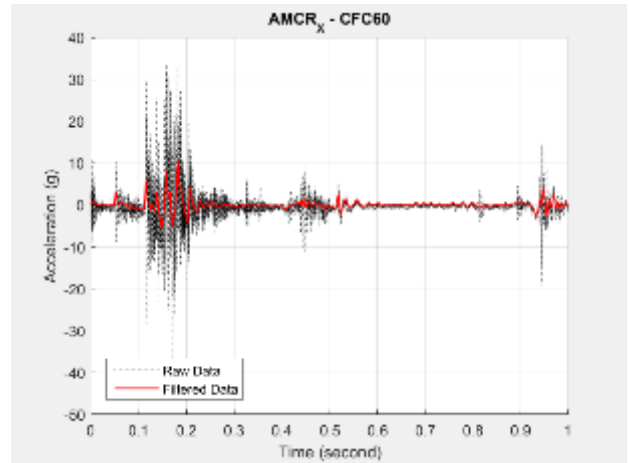

Figure B24. AMCR_X Accelerometer Data

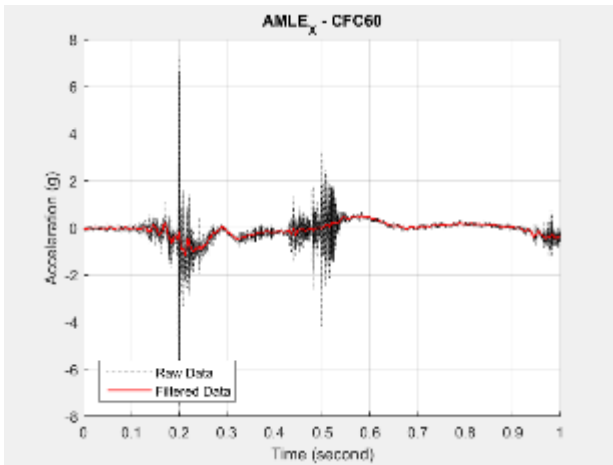

Figure B25. AMLE_X Accelerometer Data

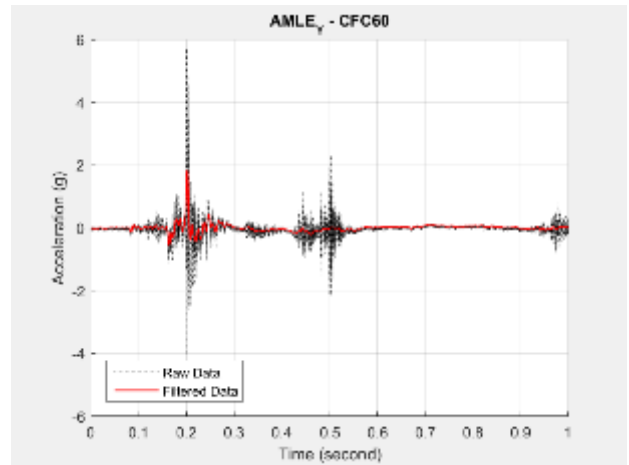

Figure B26. AMLE_Y Accelerometer Data

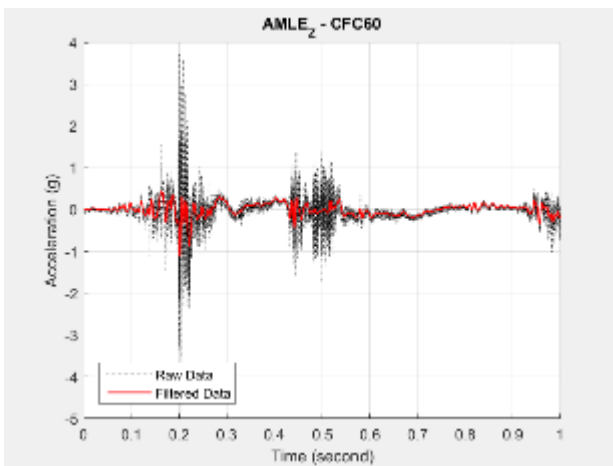

Figure B27. AMLE_Z Accelerometer Data

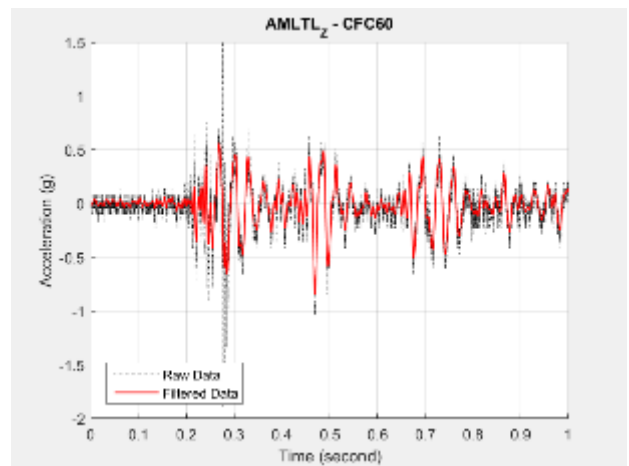

Figure B28. AMLTL_Z Accelerometer Data

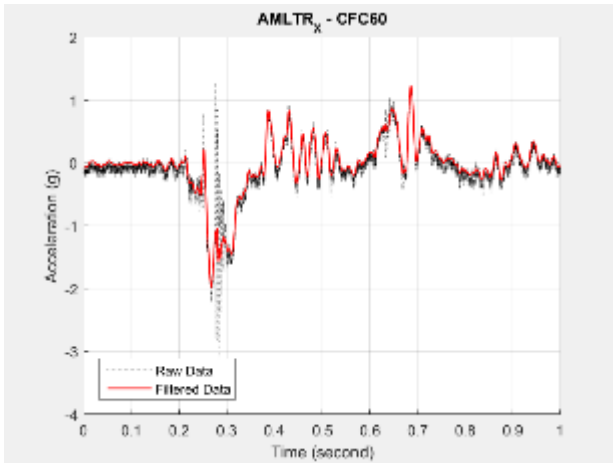

Figure B29. AMLTR_X Accelerometer Data

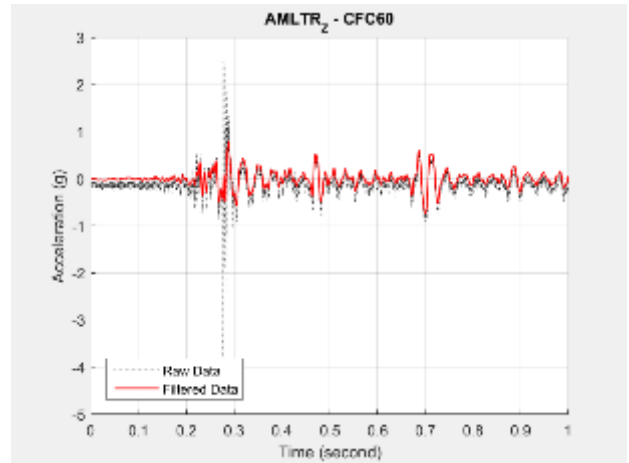

Figure B30. AMLTR_Z Accelerometer Data

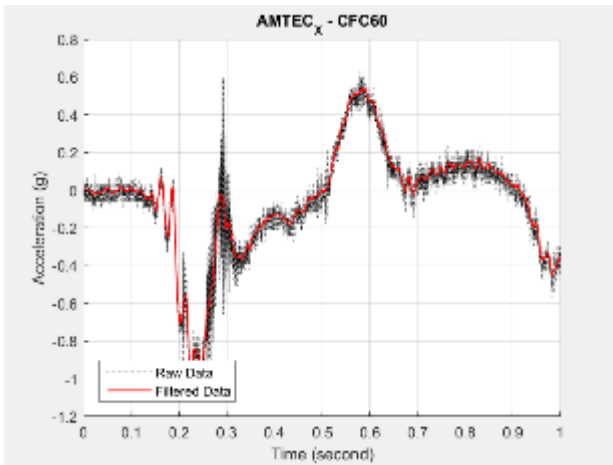

Figure B31. AMTEC_X Accelerometer Data

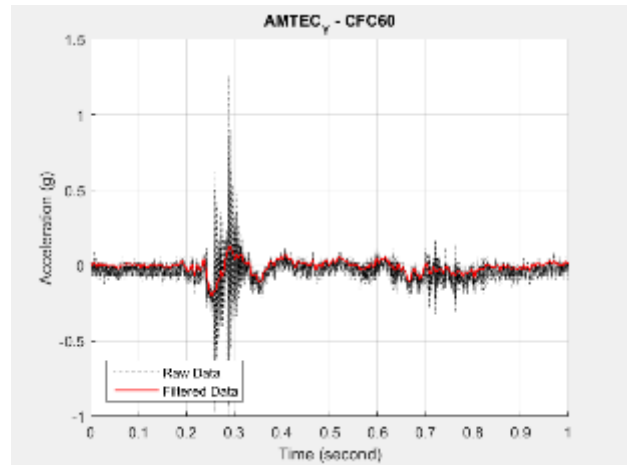

Figure B32. AMTEC_Y Accelerometer Data

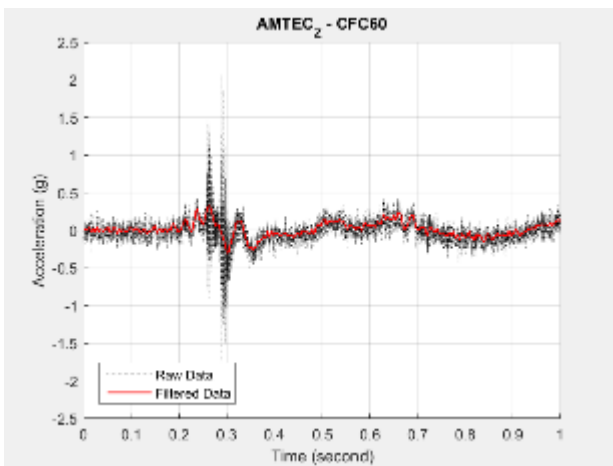

Figure B33. AMTEC_Z Accelerometer Data

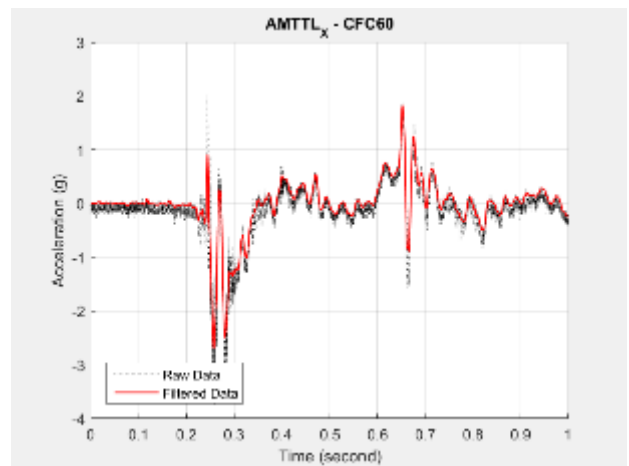

Figure B34. AMTTL_X Accelerometer Data

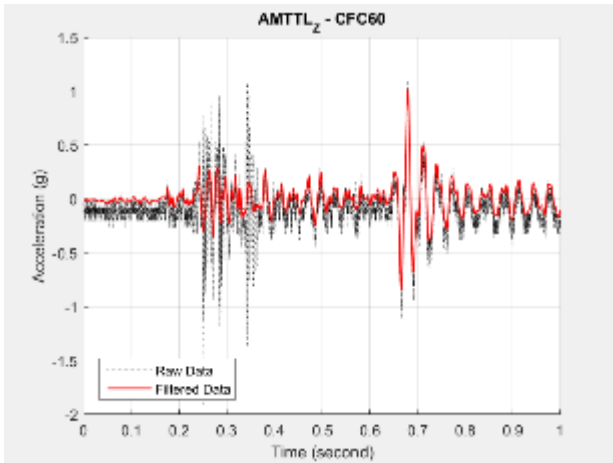

Figure B35. AMTTL_Z Accelerometer Data

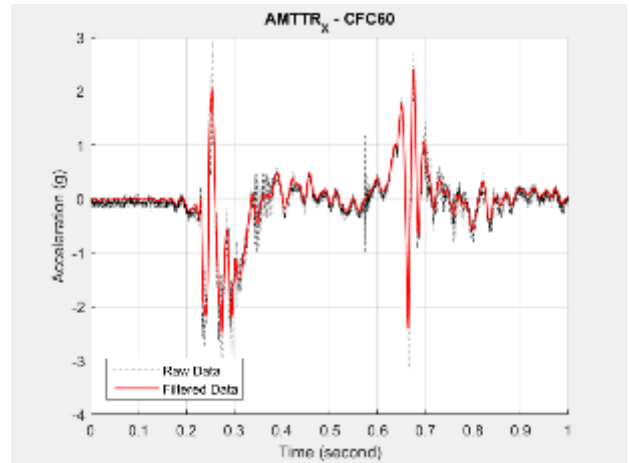

Figure B36. AMTTR_X Accelerometer Data

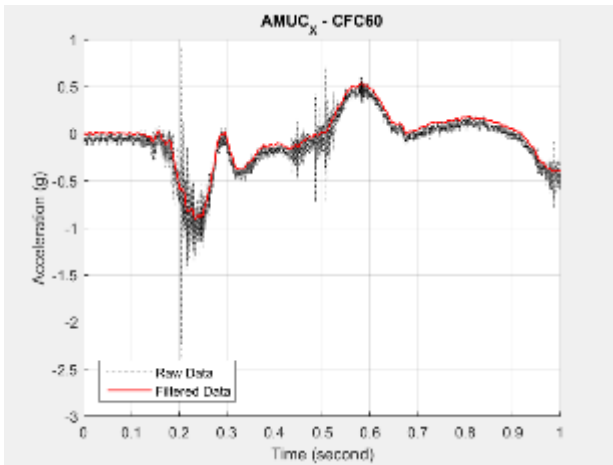

Figure B37. AMUC_X Accelerometer Data

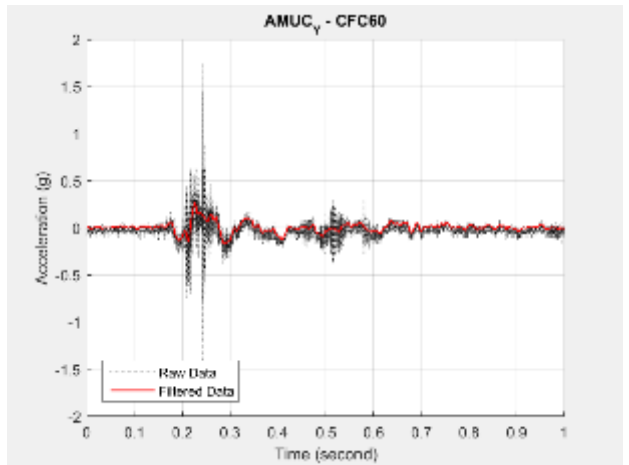

Figure B38. AMUC_Y Accelerometer Data

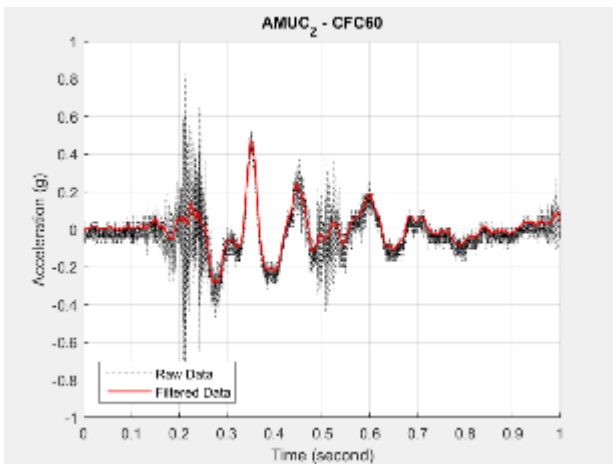

Figure B39. AMUC_Z Accelerometer Data

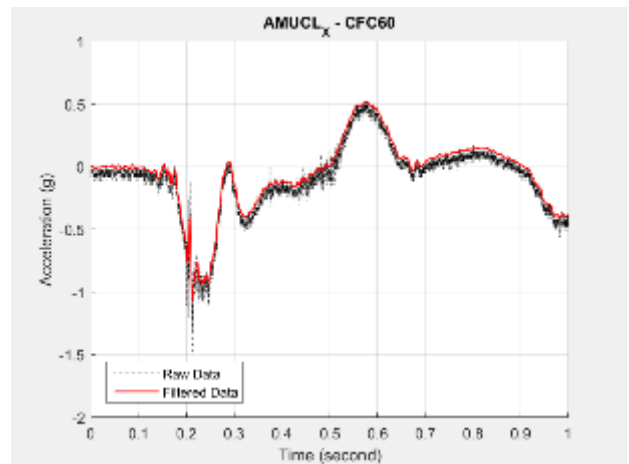

Figure B40. AMUCL_X Accelerometer Data

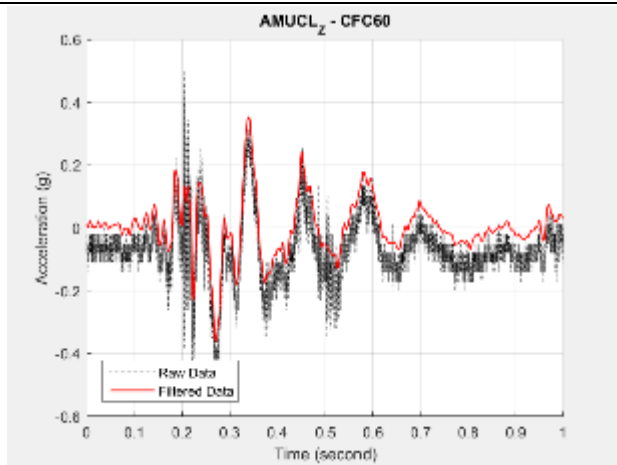

Figure B41. AMUCL_Z Accelerometer Data

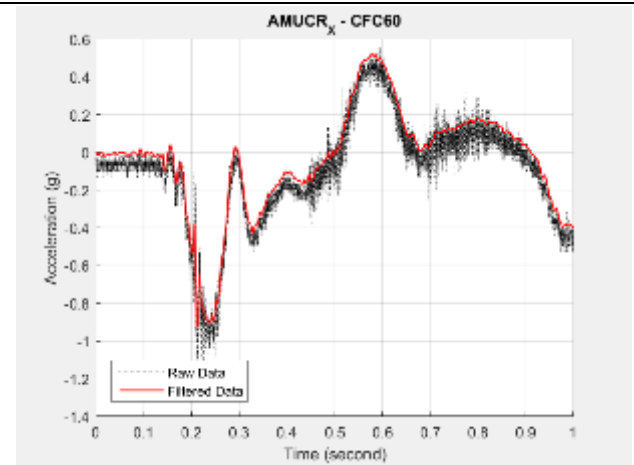

Figure B42. AMUCR_X Accelerometer Data

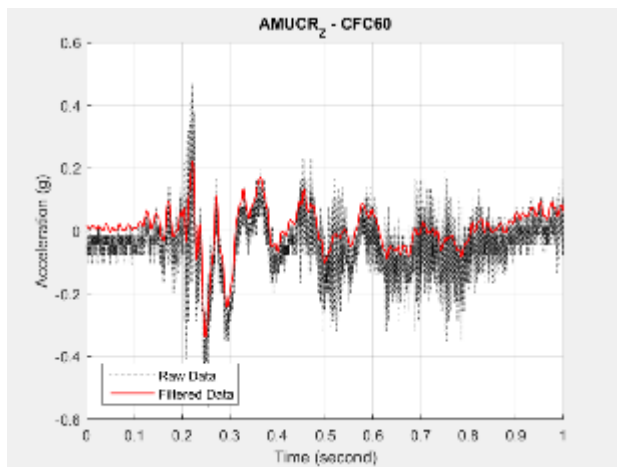

Figure B43. AMUCR_Z Accelerometer Data

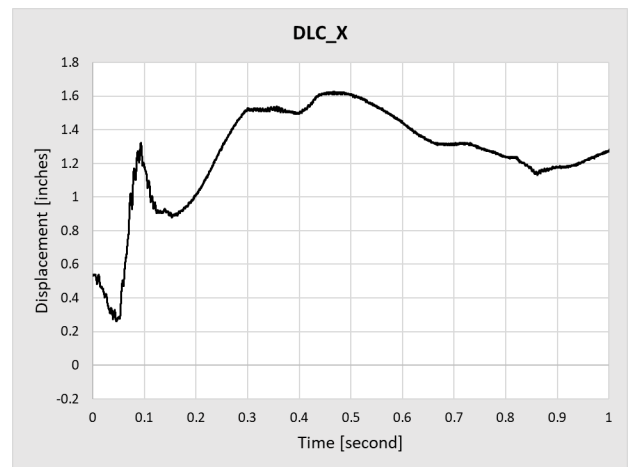

Figure B44. DLC_X Displacement Data

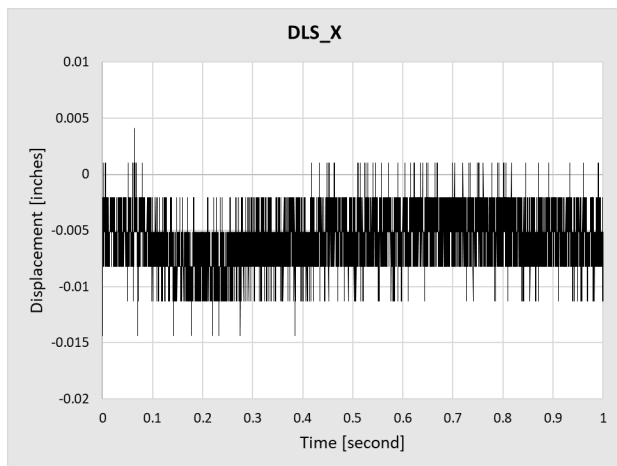

Figure B45. DLS_X Displacement Data

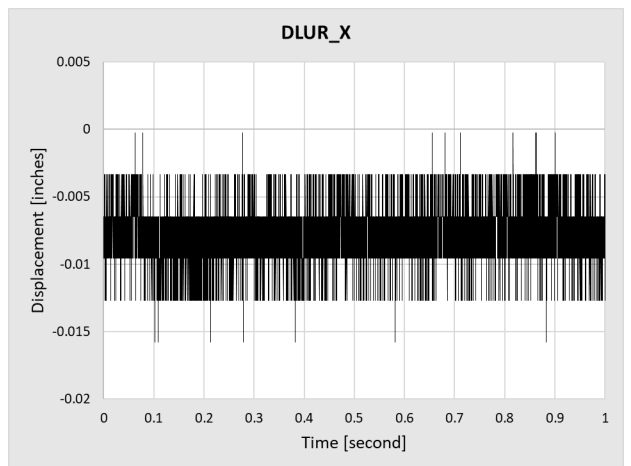

Figure B46. DLUR_X Displacement Data

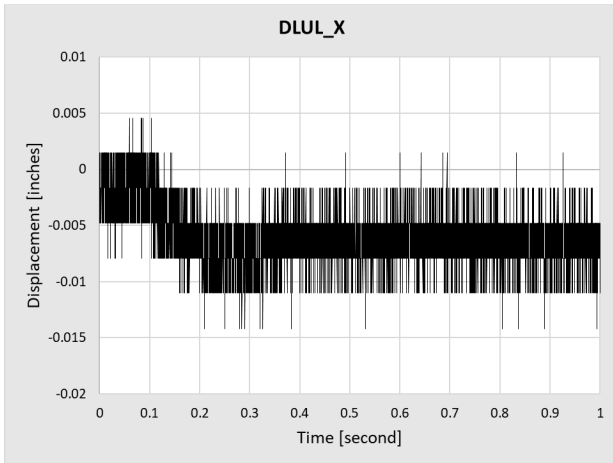

Figure B47. DLUL_X Displacement Data

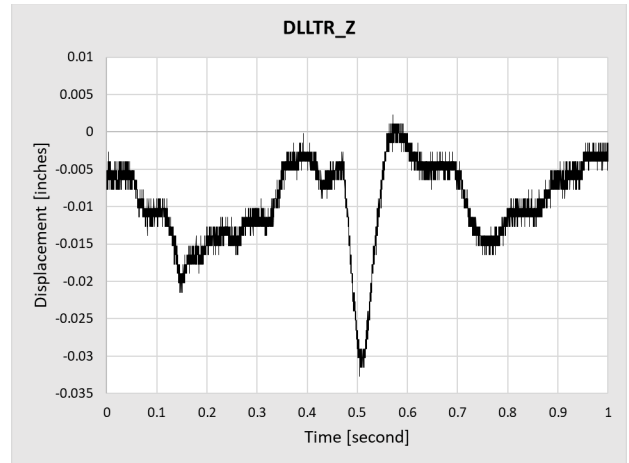

Figure B48. DLLTR_Z Displacement Data

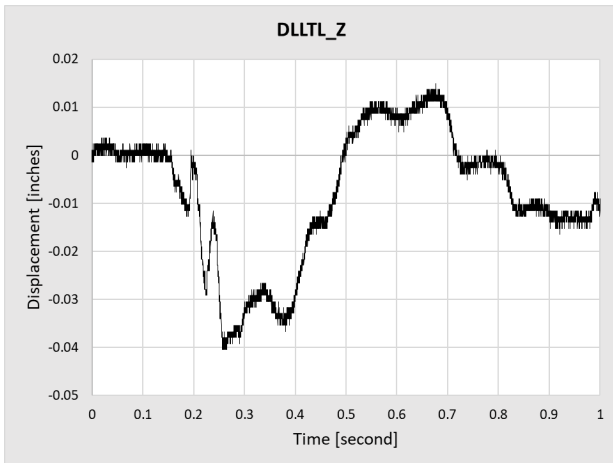

Figure B49. DLLTL_Z Displacement Data

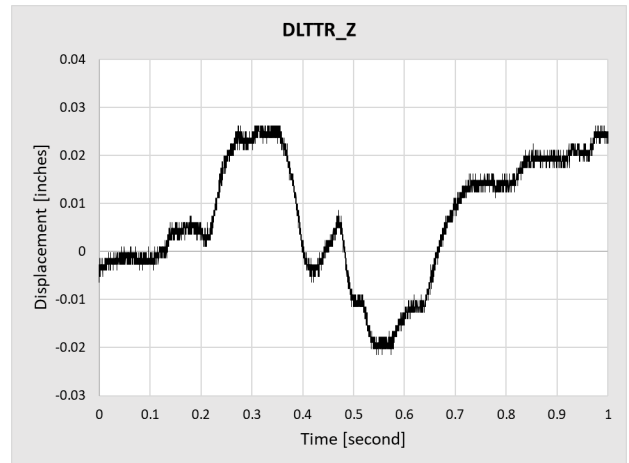

Figure B50. DLTR_Z Displacement Data

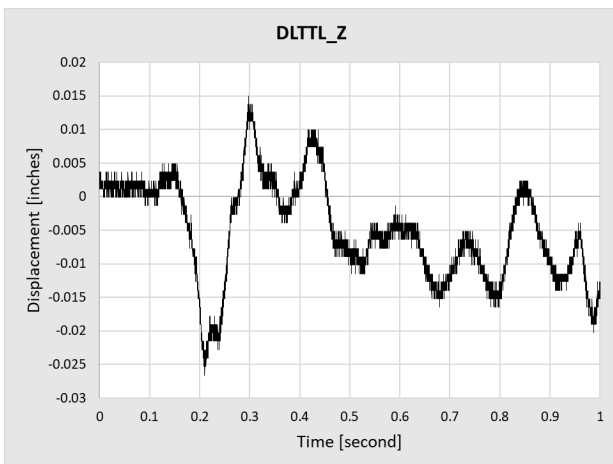

Figure B51. DLTTL_Z Displacement Data

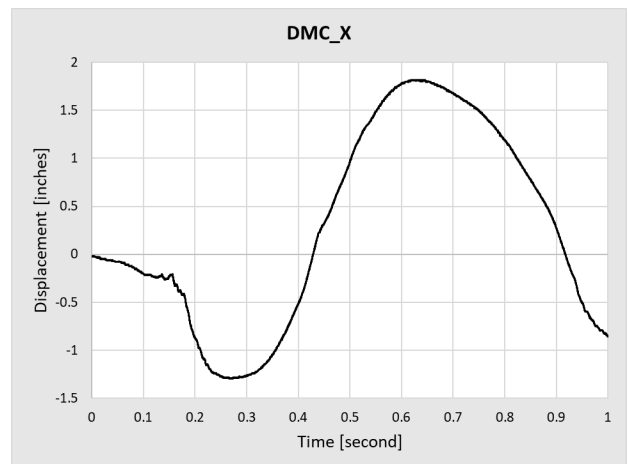

Figure B52. DMC_X Displacement Data

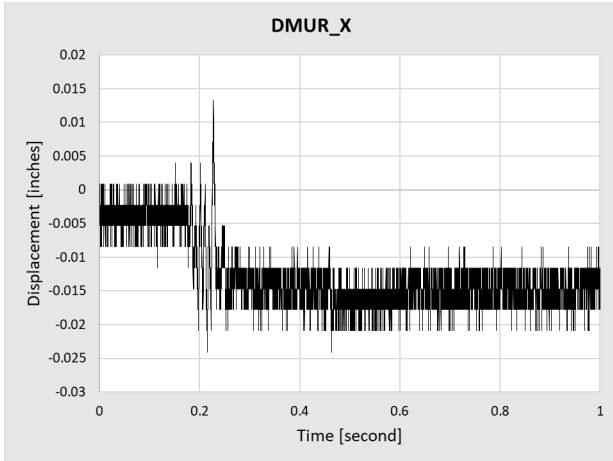

Figure B53. DMUR_X Displacement Data

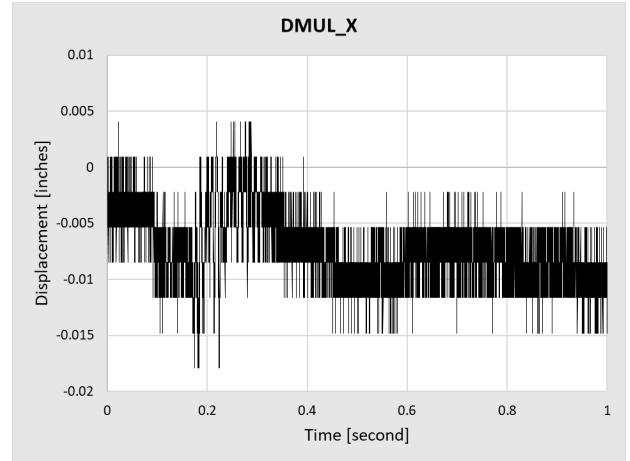

Figure B54. DMUL_X Displacement Data

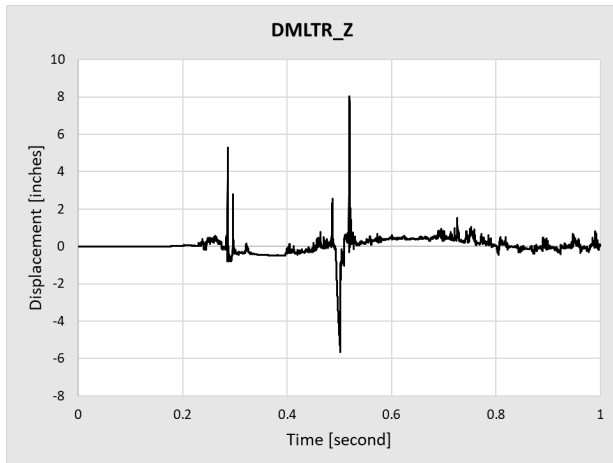

Figure B55. DMLTR_Z Displacement Data

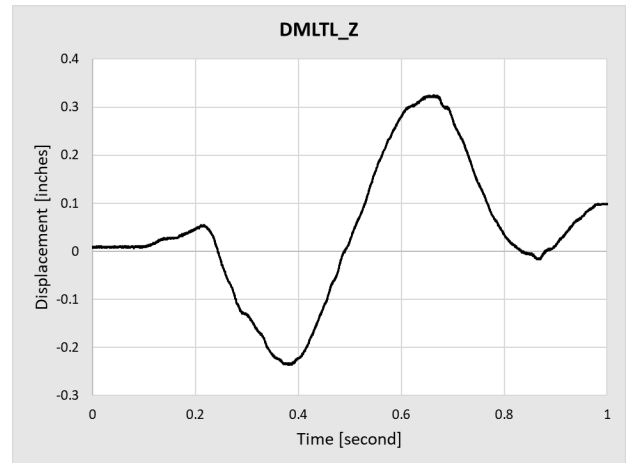

Figure B56. DMLTL_Z Displacement Data

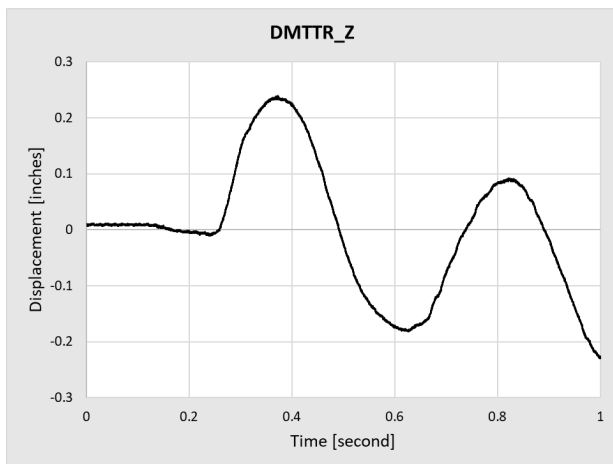

Figure B57. DMTTR_Z Displacement Data

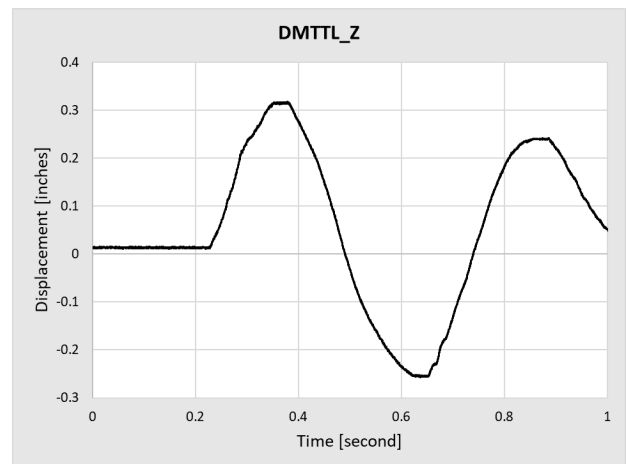

Figure B58. DMTTL_Z Displacement Data

Appendix C. 4 mph Test Data

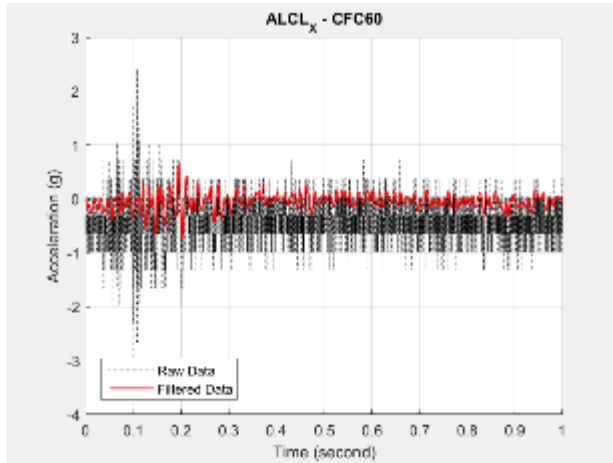

Figure C1. ALCL_X Accelerometer Data

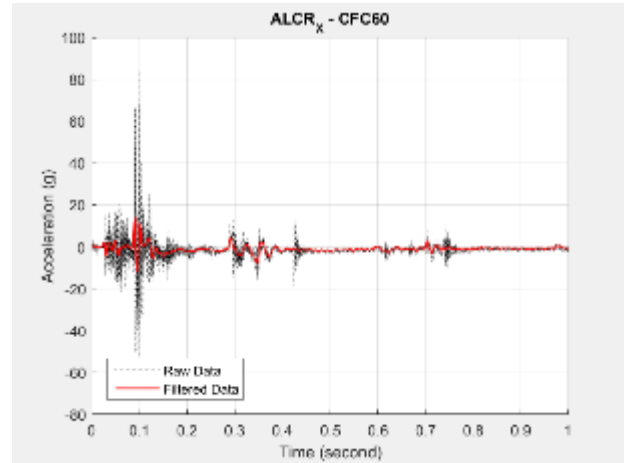

Figure C2. ALCR_X Accelerometer Data

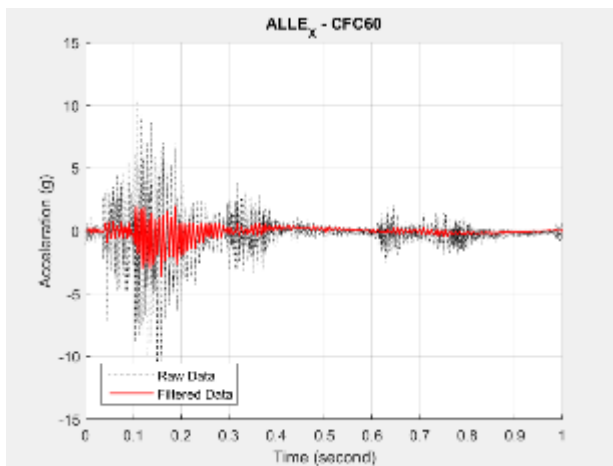

Figure C3. ALLE_X Accelerometer Data

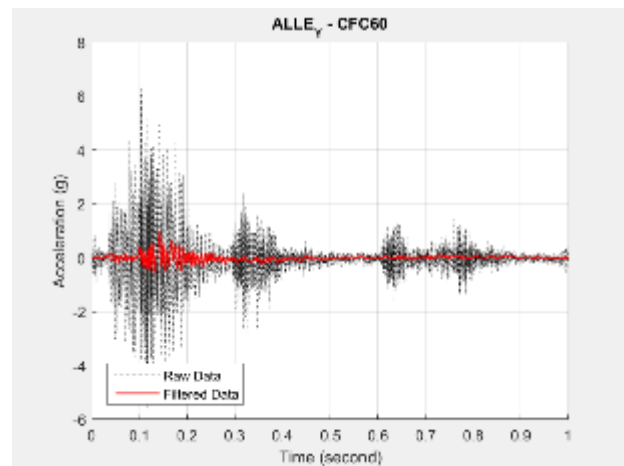

Figure C4. ALLE_Y Accelerometer Data

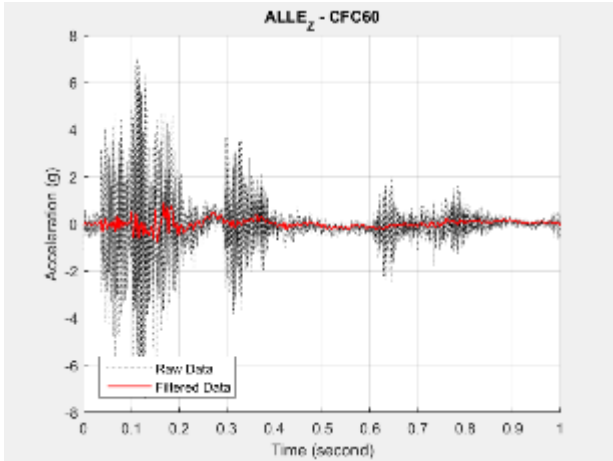

Figure C5. ALLE_Z Accelerometer Data

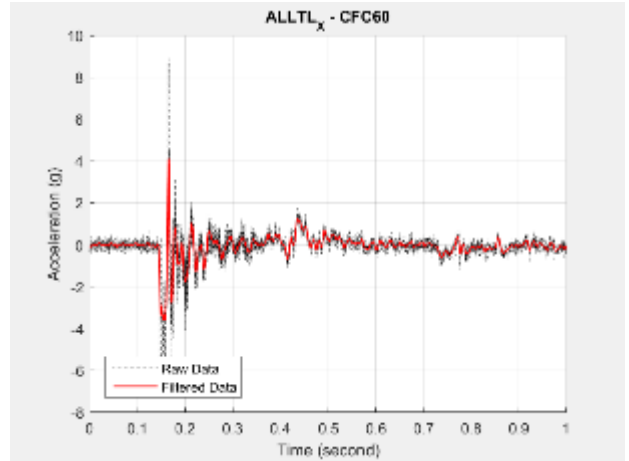

Figure C6. ALLTL_X Accelerometer Data

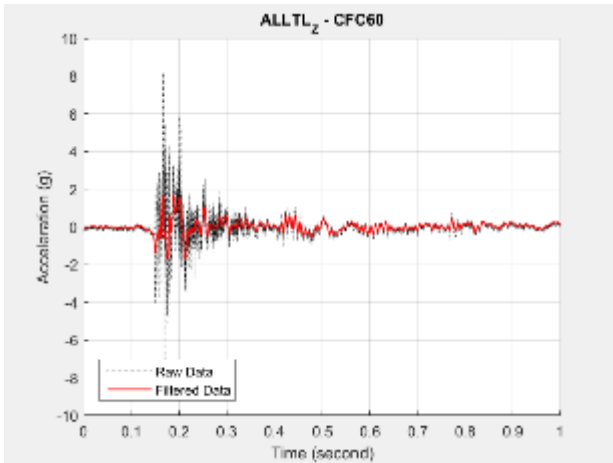

Figure C7. ALLTL_Z Accelerometer Data

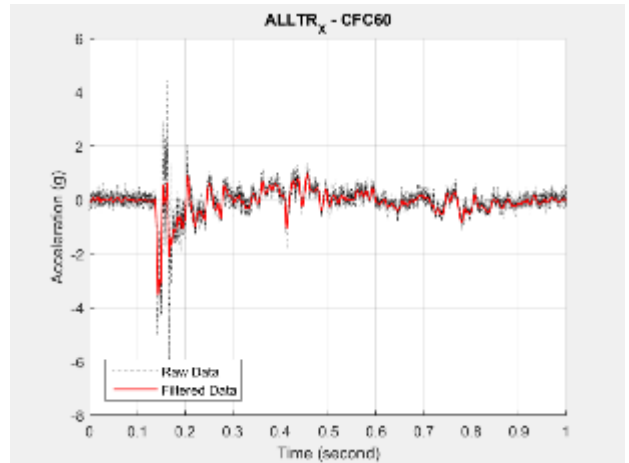

Figure C8. ALLTR_X Accelerometer Data

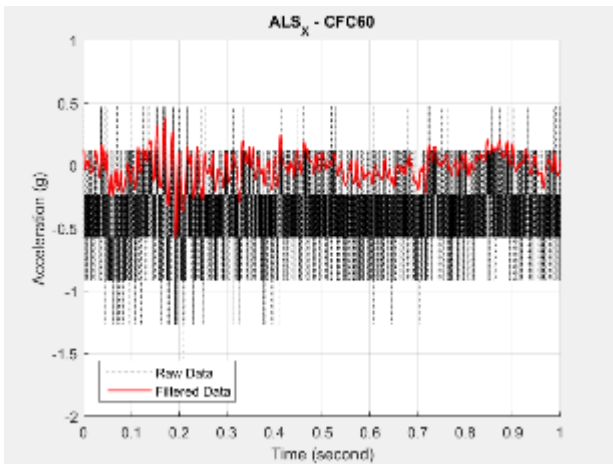

Figure C9. ALS_X Accelerometer Data

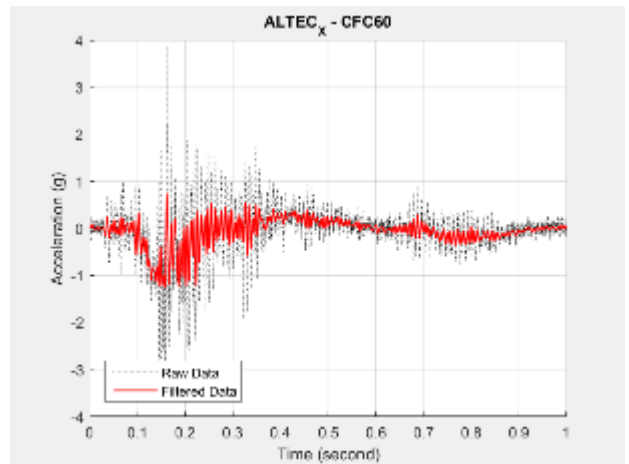

Figure C10. ALTEC_X Accelerometer Data

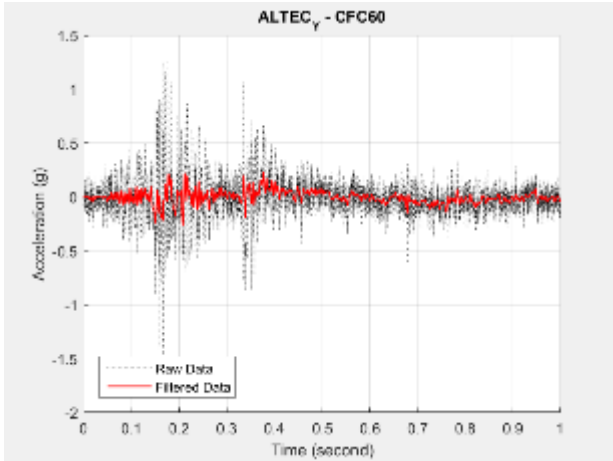

Figure C11. ALTEC_Y Accelerometer Data

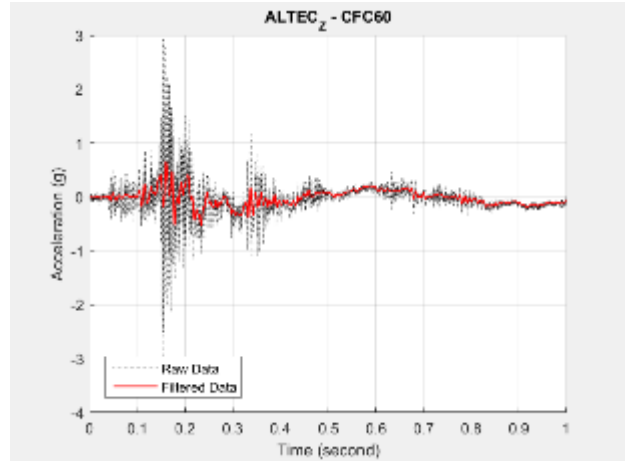

Figure C12. ALTEC_Z Accelerometer Data

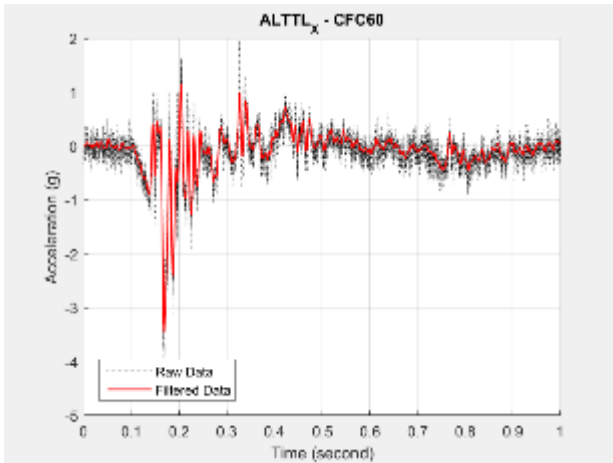

Figure C13. ALTTL_X Accelerometer Data

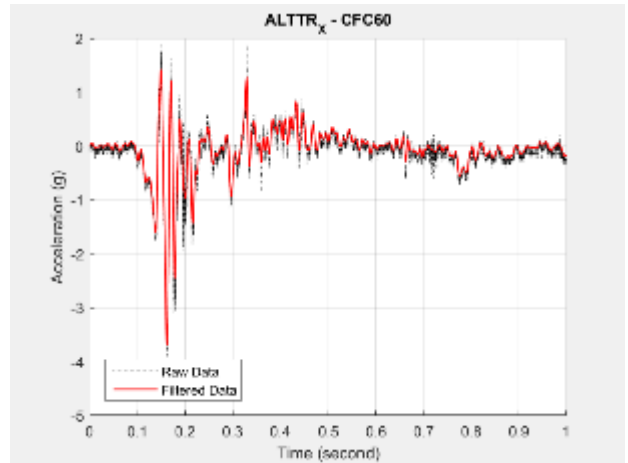

Figure C14. ALTRR_X Accelerometer Data

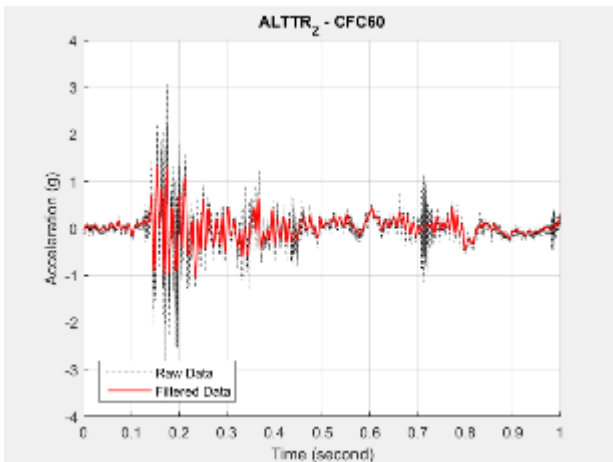

Figure C15. ALTRR_Z Accelerometer Data

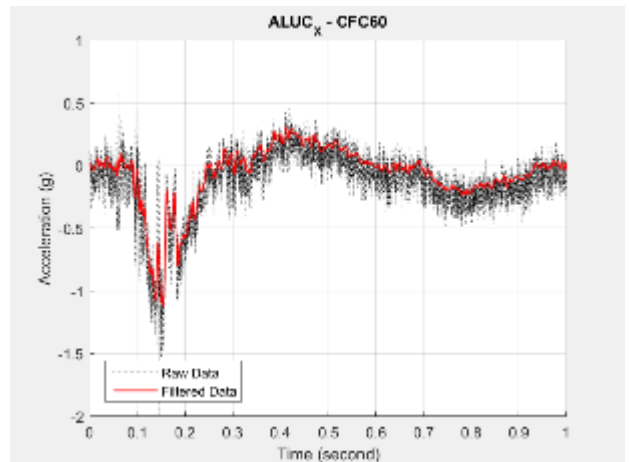

Figure C16. ALUC_X Accelerometer Data

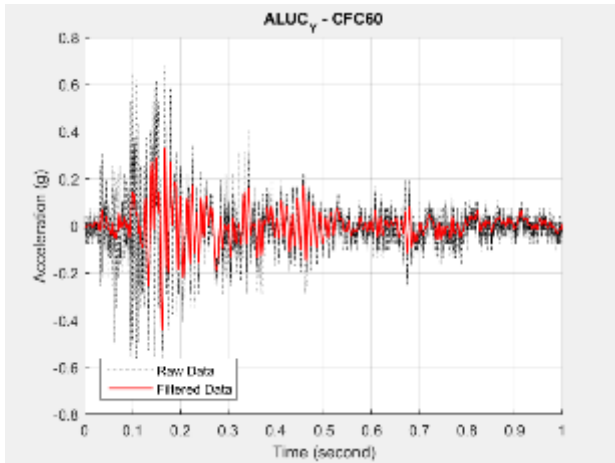

Figure C17. ALUC_Y Accelerometer Data

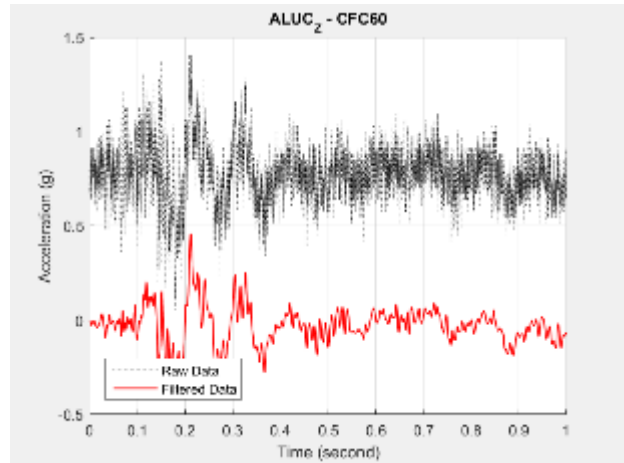

Figure C18. ALUC_Z Accelerometer Data

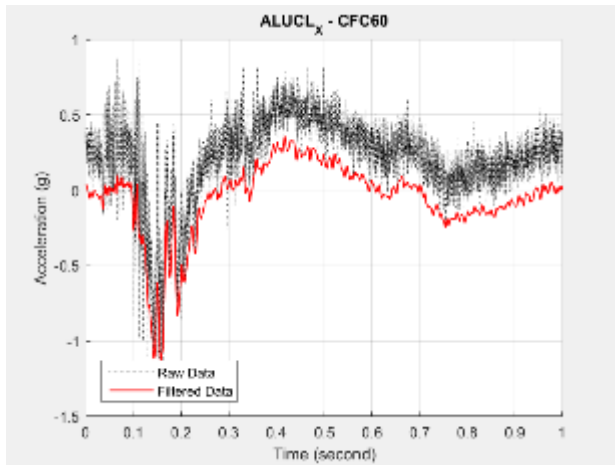

Figure C19. ALUCL_X Accelerometer Data

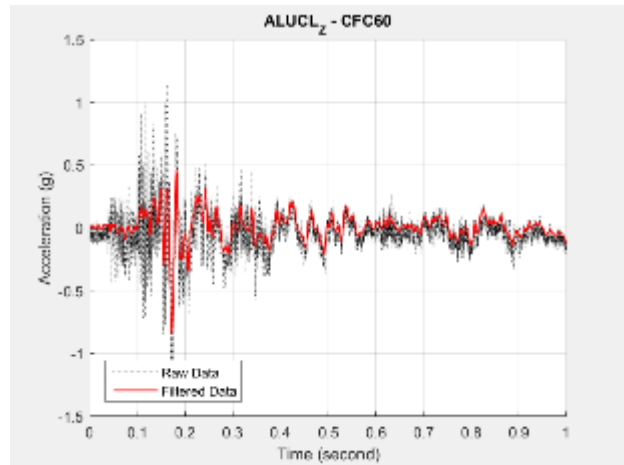

Figure C20. ALUCL_Z Accelerometer Data

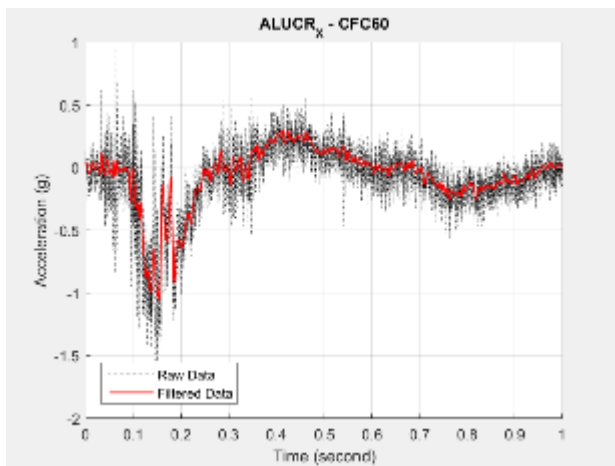

Figure C21. ALUCR_X Accelerometer Data

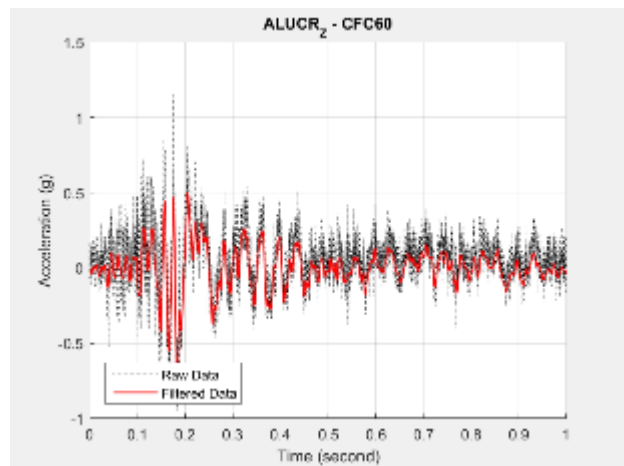

Figure C22. ALUCR_Z Accelerometer Data

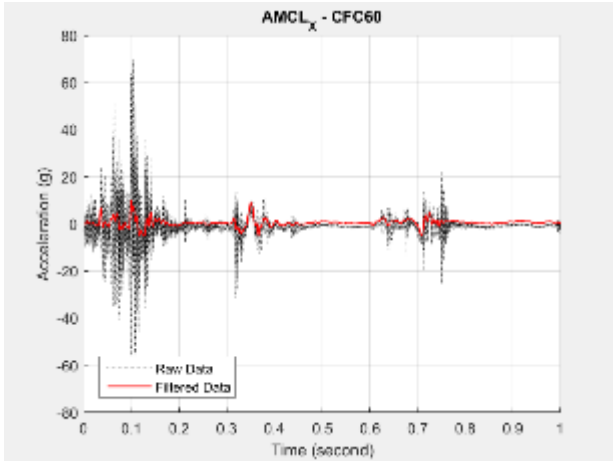

Figure C23. AMCL_X Accelerometer Data

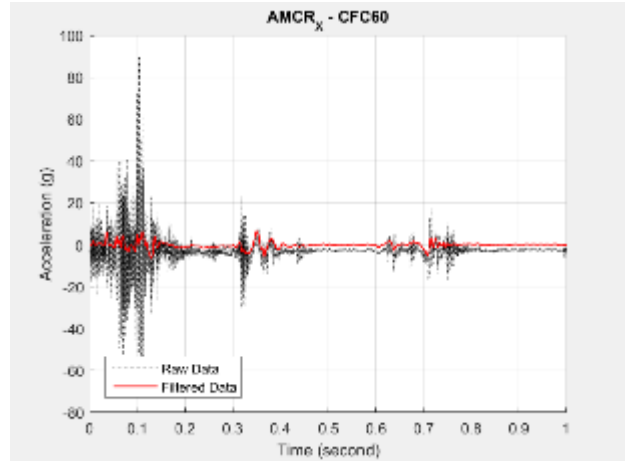

Figure C24. AMCR_X Accelerometer Data

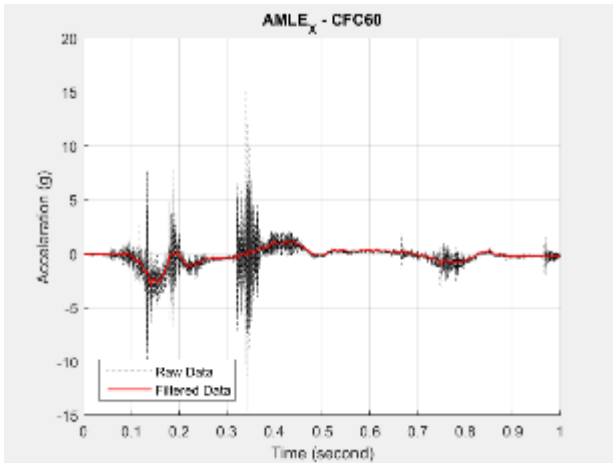

Figure C25. AMLE_X Accelerometer Data

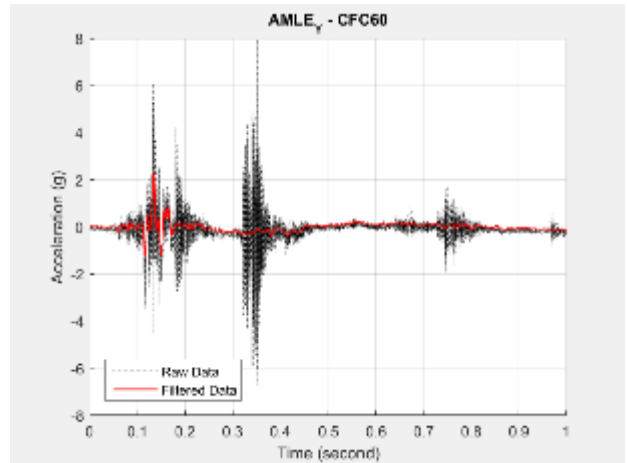

Figure C26. AMLE_Y Accelerometer Data

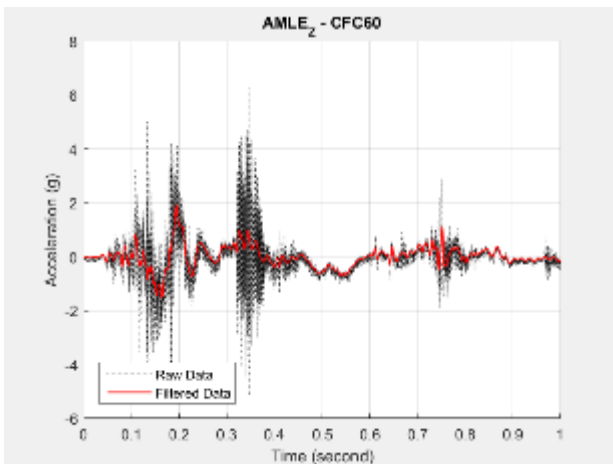

Figure C27. AMLE_Z Accelerometer Data

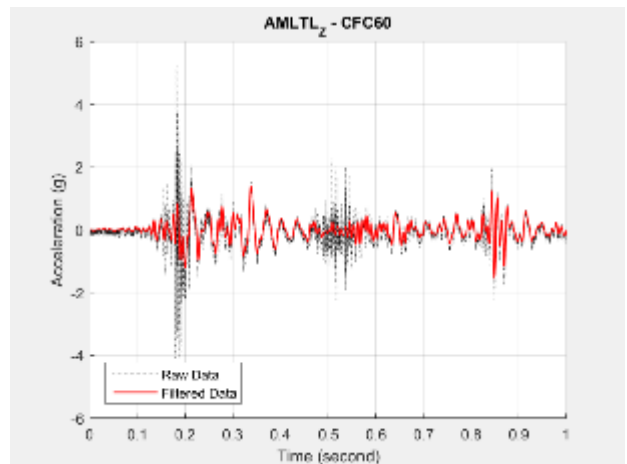

Figure C28. AMLTL_Z Accelerometer Data

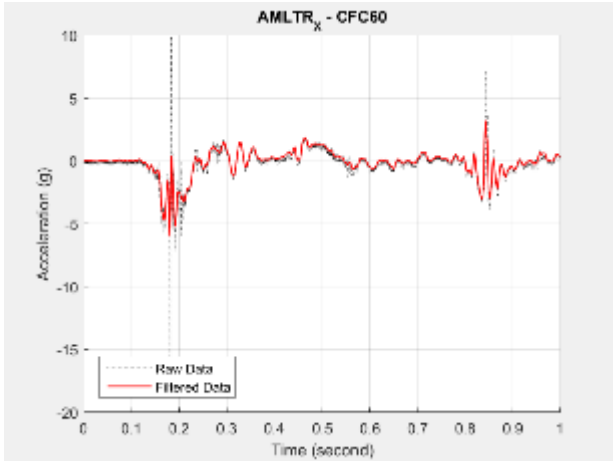

Figure C29. AMLTR_X Accelerometer Data

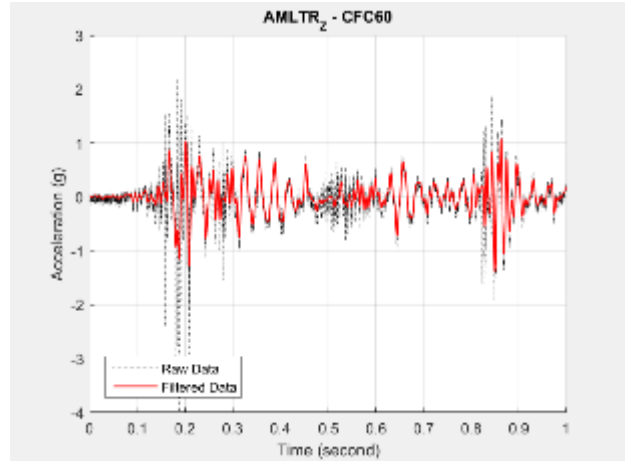

Figure C30. AMLTR_Z Accelerometer Data

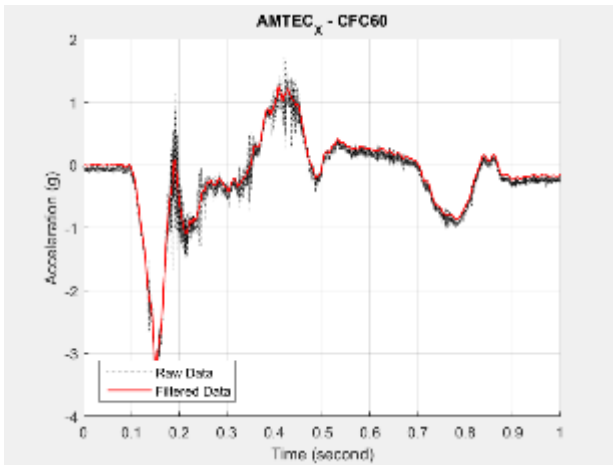

Figure C31. AMTEC_X Accelerometer Data

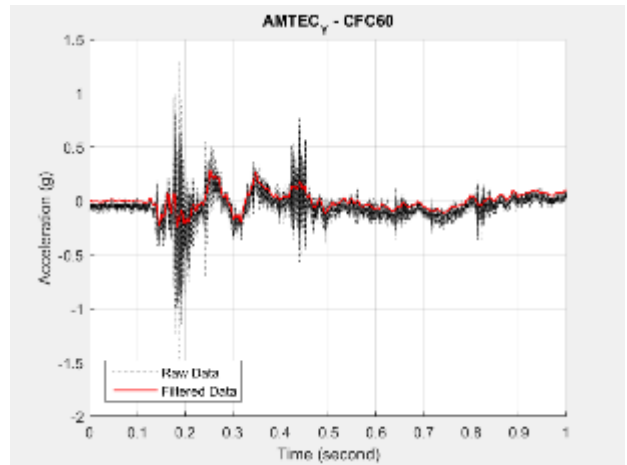

Figure C32. AMTEC_Y Accelerometer Data

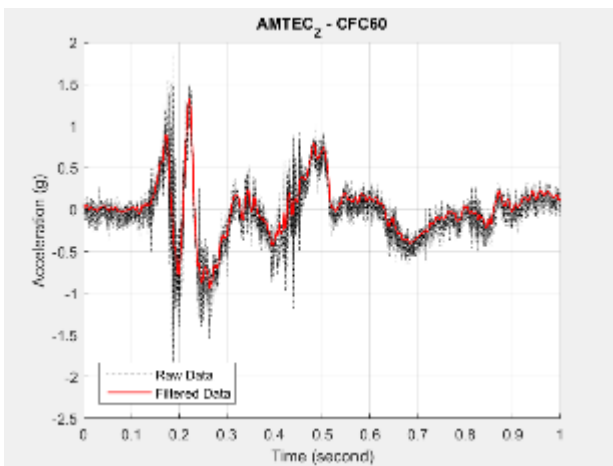

Figure C33. AMTEC_Z Accelerometer Data

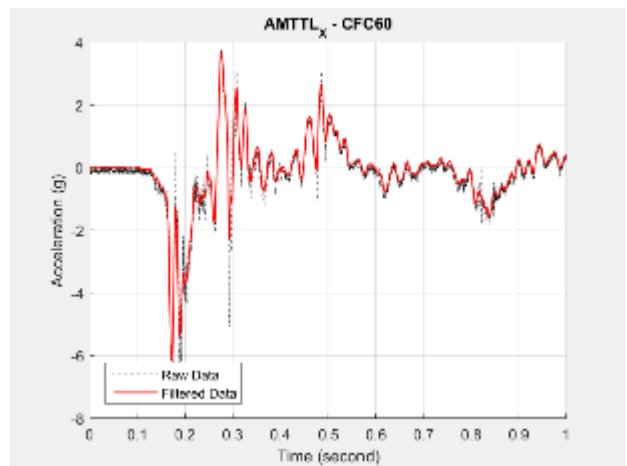

Figure C34. AMTTL_X Accelerometer Data

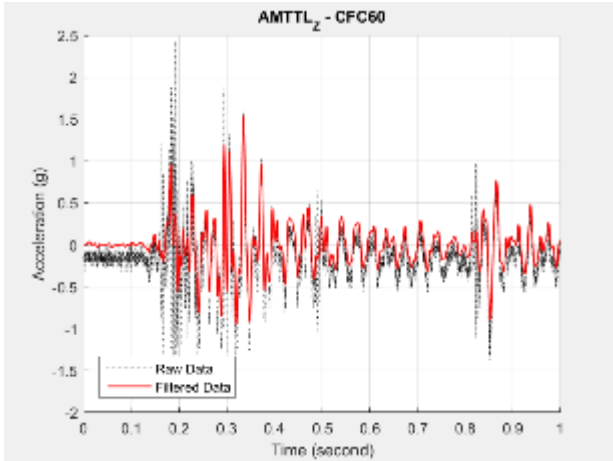

Figure C35. AMTTL_Z Accelerometer Data

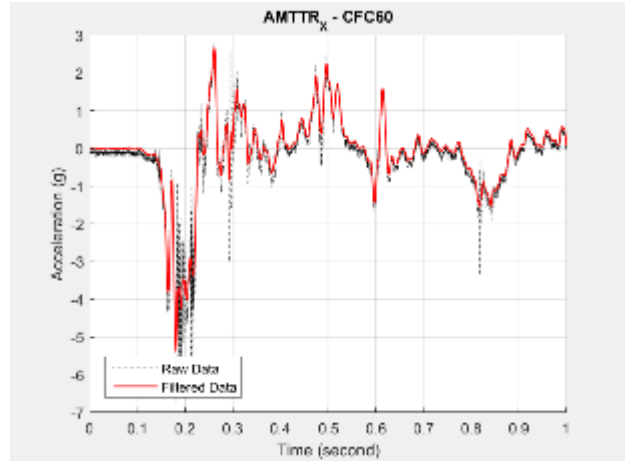

Figure C36. AMTTR_X Accelerometer Data

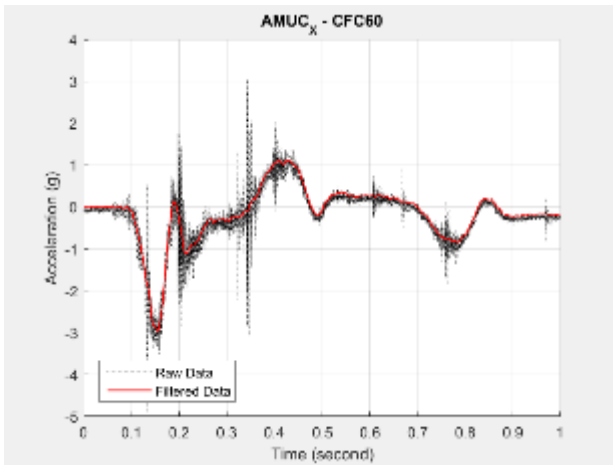

Figure C37. AMUC_X Accelerometer Data

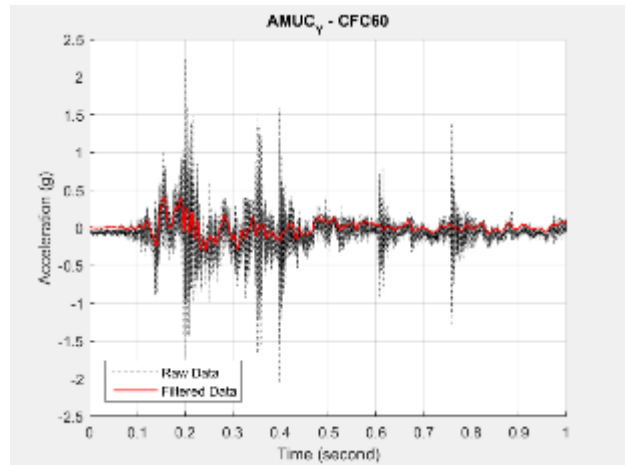

Figure C38. AMUC_Y Accelerometer Data

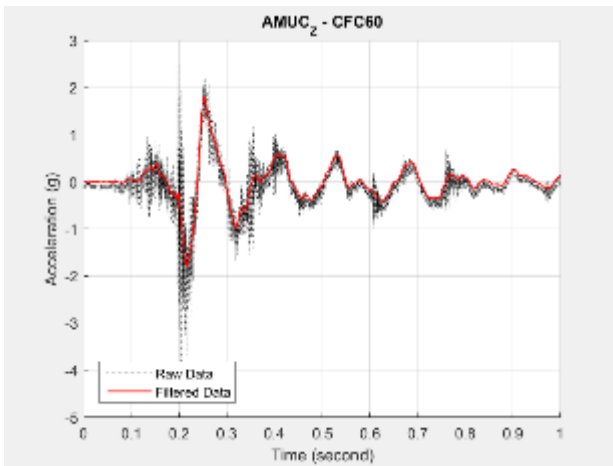

Figure C39. AMUC_Z Accelerometer Data

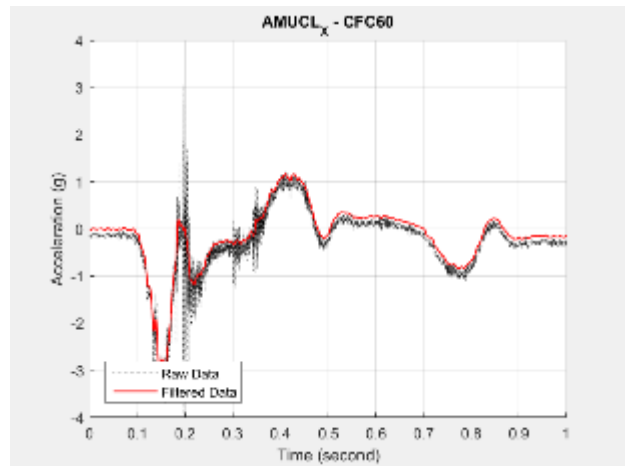

Figure C40. AMUCL_X Accelerometer Data

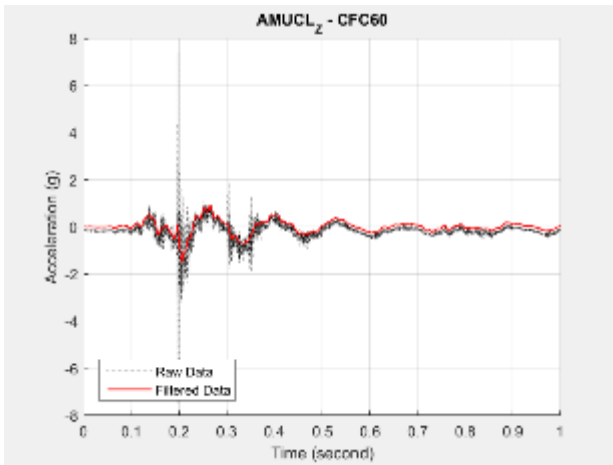

Figure C41. AMUCL_Z Accelerometer Data

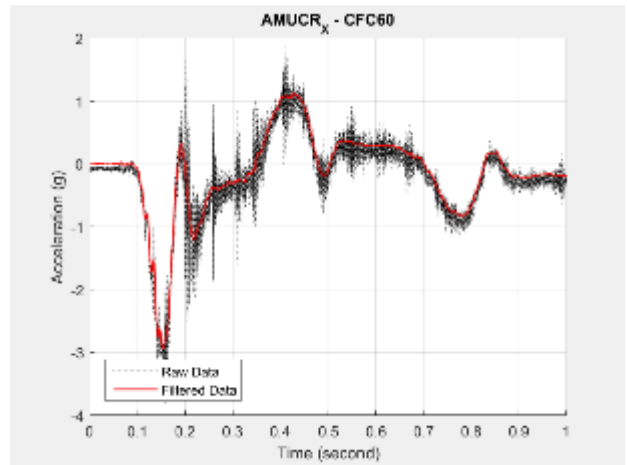

Figure C42. AMUCR_X Accelerometer Data

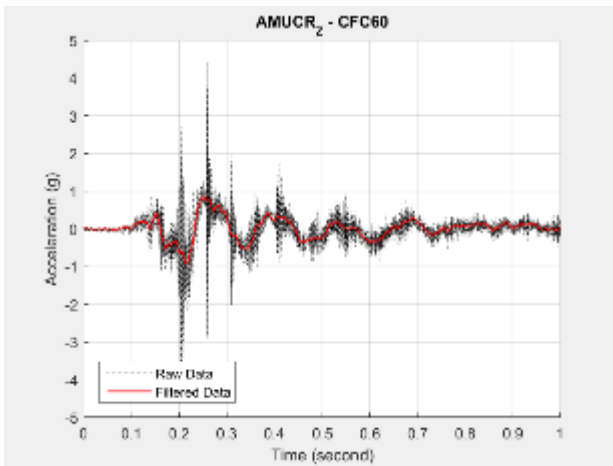

Figure C43. AMUCR_Z Accelerometer Data

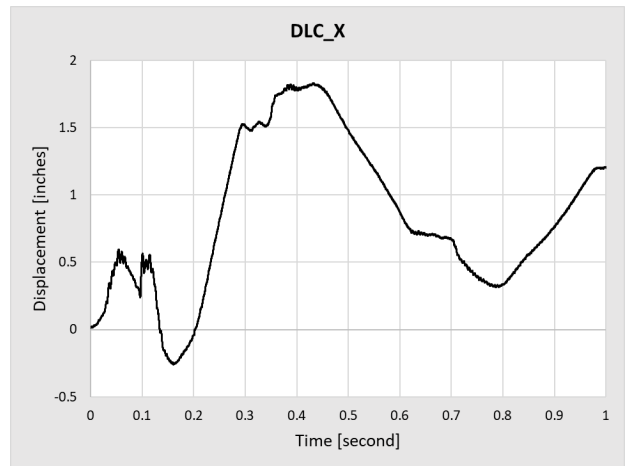

Figure C44. DLC_X Displacement Data

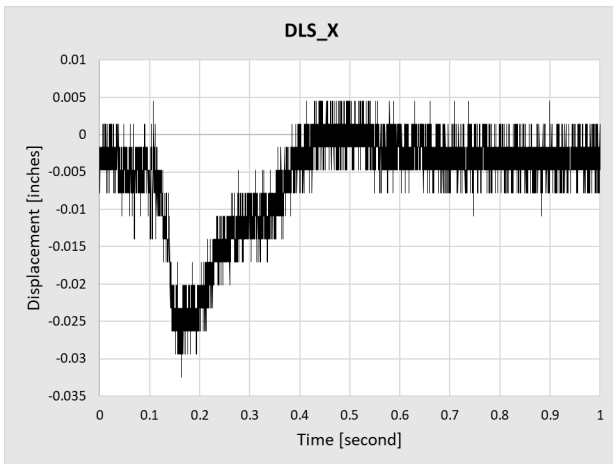

Figure C45. DLS_X Displacement Data

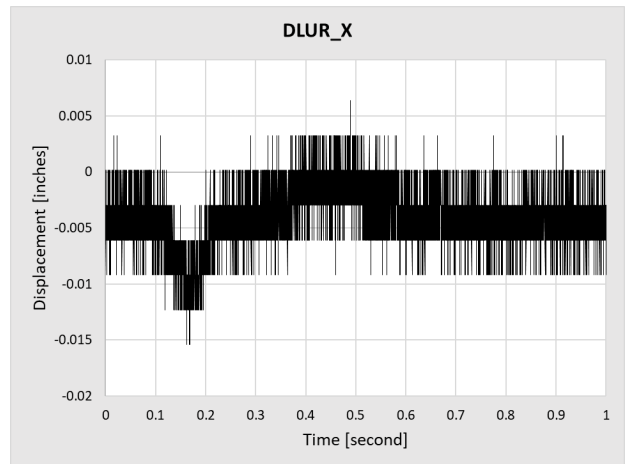

Figure C46. DLUR_X Displacement Data

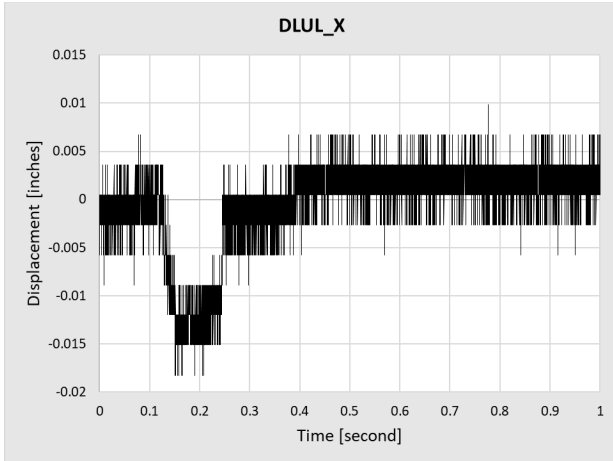

Figure C47. DLUL_X Displacement Data

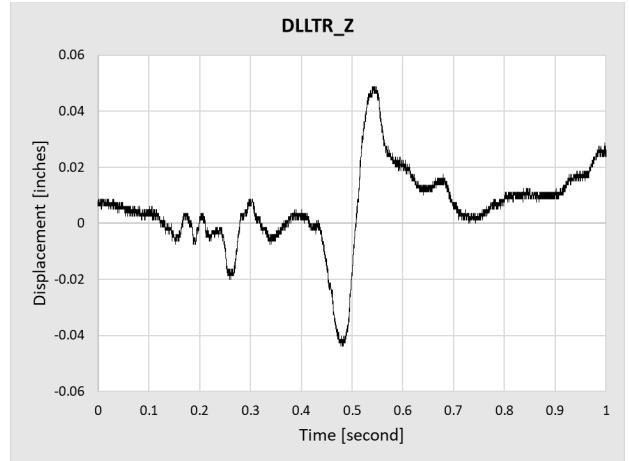

Figure C48. DLLTR_Z Displacement Data

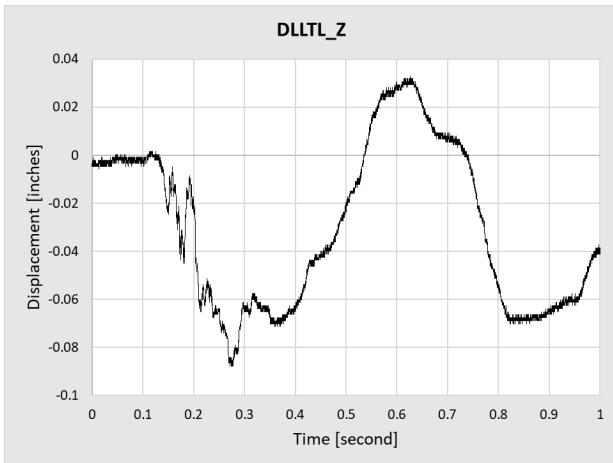

Figure C49. DLLTL_Z Displacement Data

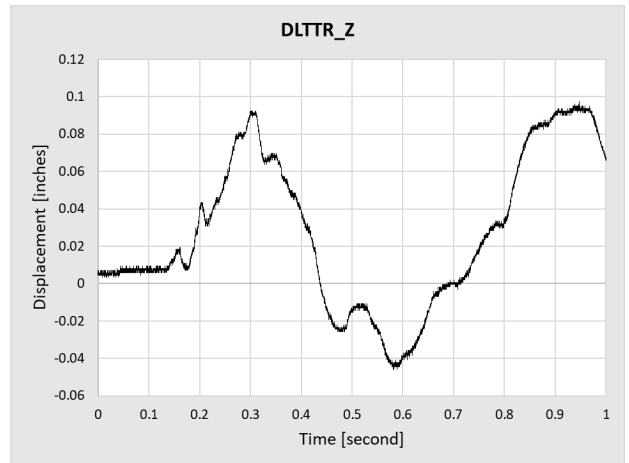

Figure C50. DLTTR_Z Displacement Data

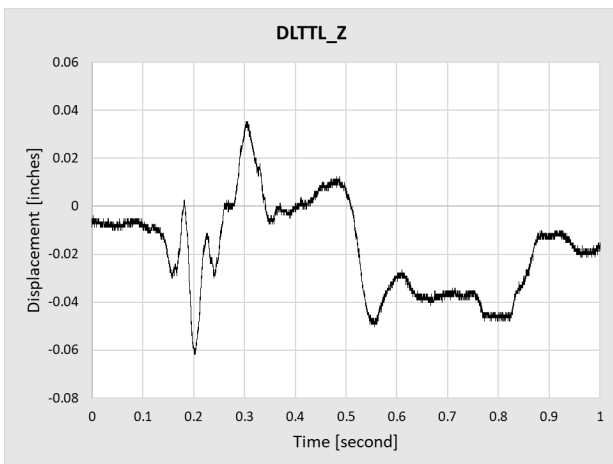

Figure C51. DLTTL_Z Displacement Data

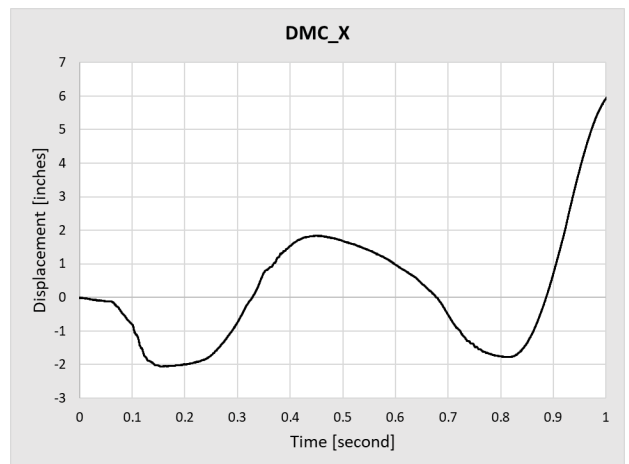

Figure C52. DMC_X Displacement Data

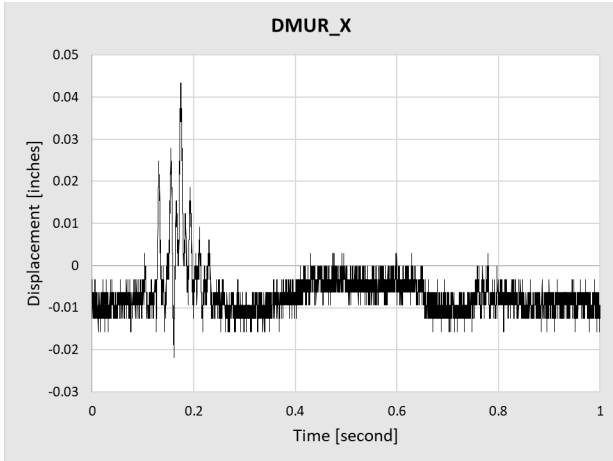

Figure C53. DMUR_X Displacement Data

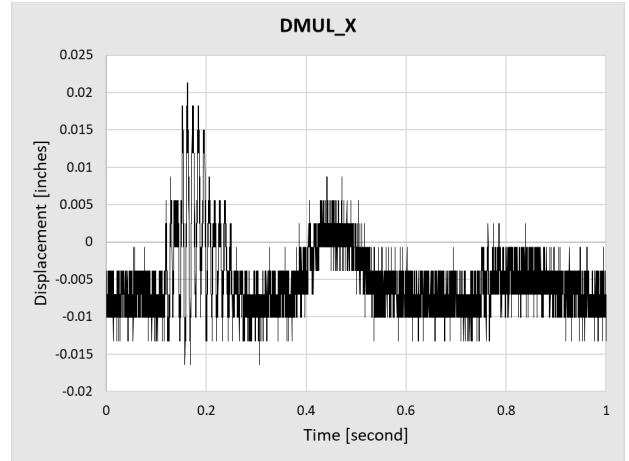

Figure C54. DMUL_X Displacement Data

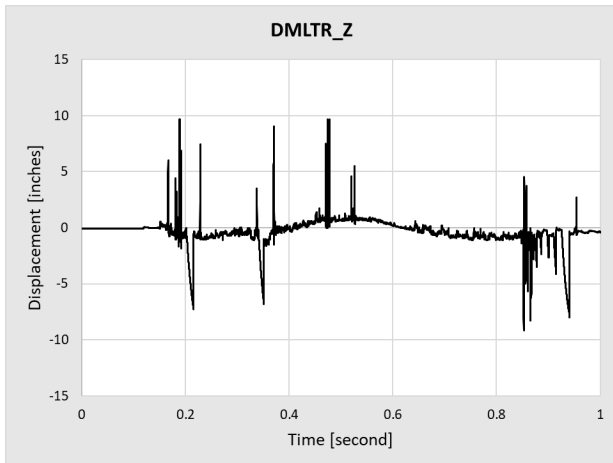

Figure C55. DMLTR_Z Displacement Data

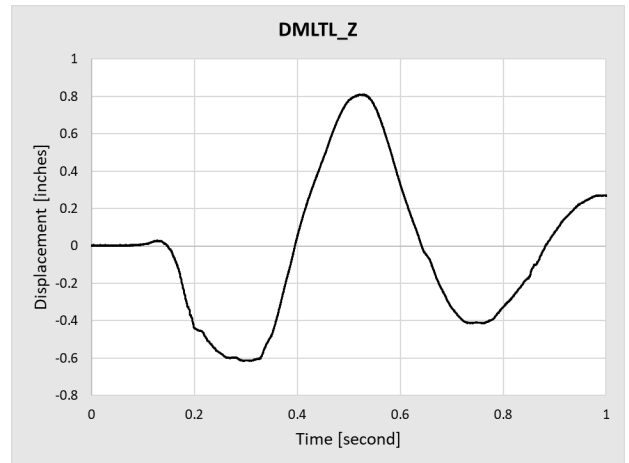

Figure C56. DMLTL_Z Displacement Data

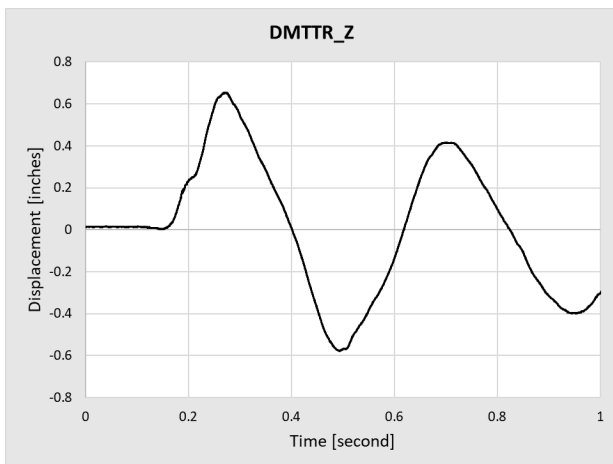

Figure C57. DMTTR_Z Displacement Data

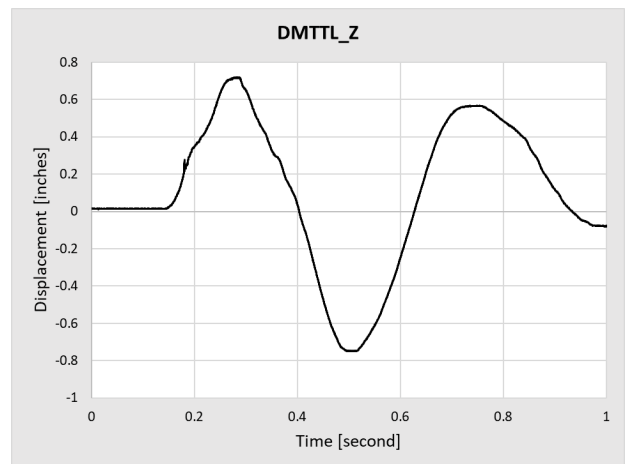

Figure C58. DMTTL_Z Displacement Data

Appendix D. 6 mph Test Data

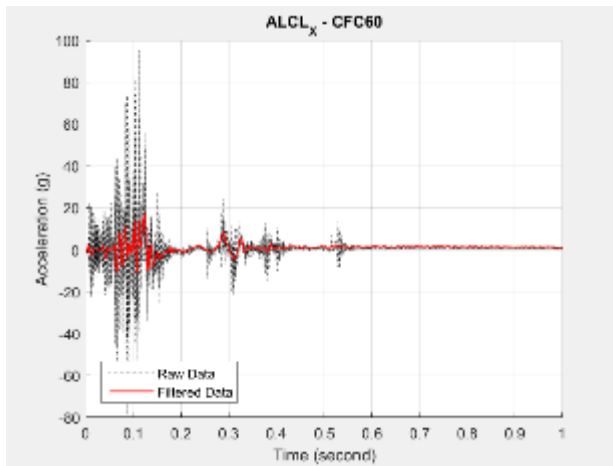

Figure D1. ALCL_X Accelerometer Data

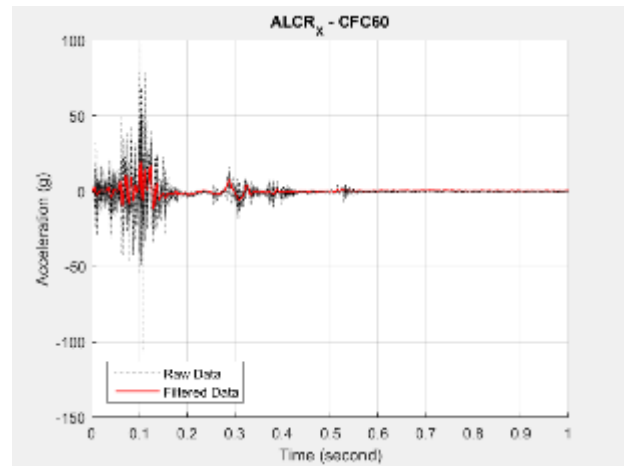

Figure D2. ALCR_X Accelerometer Data

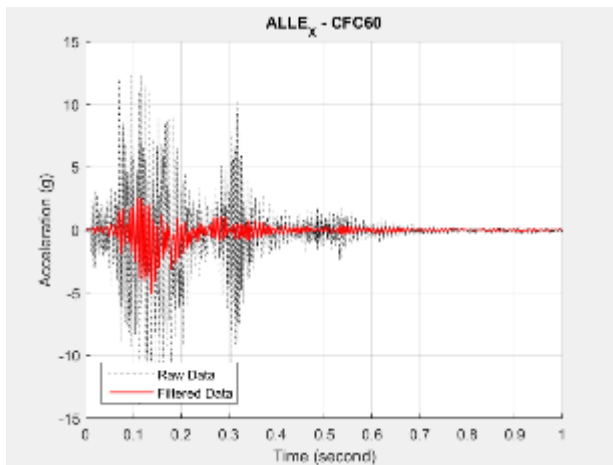

Figure D3. ALLE_X Accelerometer Data

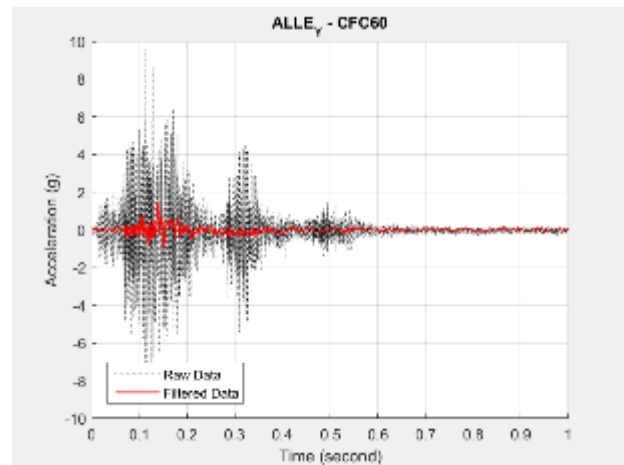

Figure D4. ALLE_Y Accelerometer Data

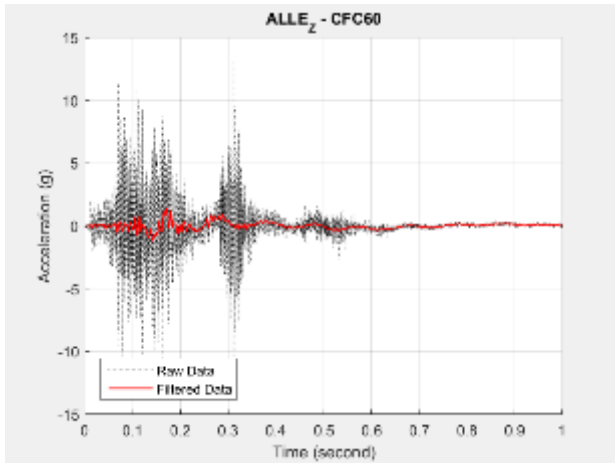

Figure D5. ALLE_Z Accelerometer Data

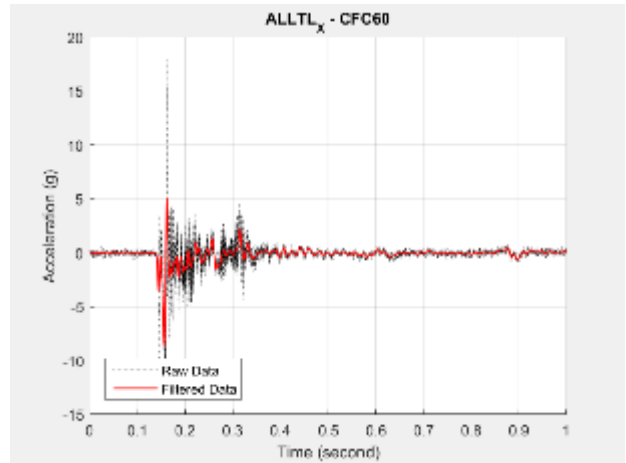

Figure D6. ALLTL_X Accelerometer Data

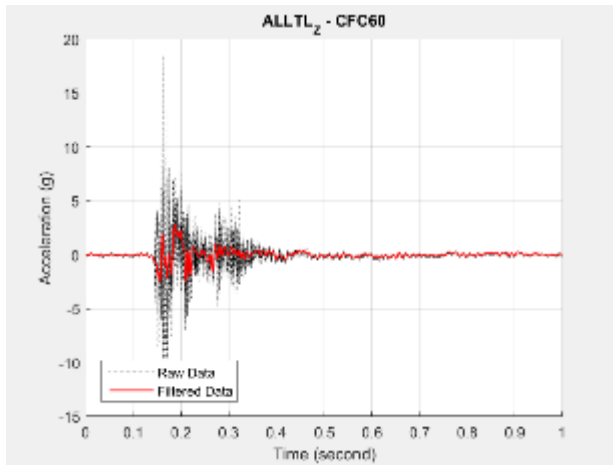

Figure D7. ALLTL_Z Accelerometer Data

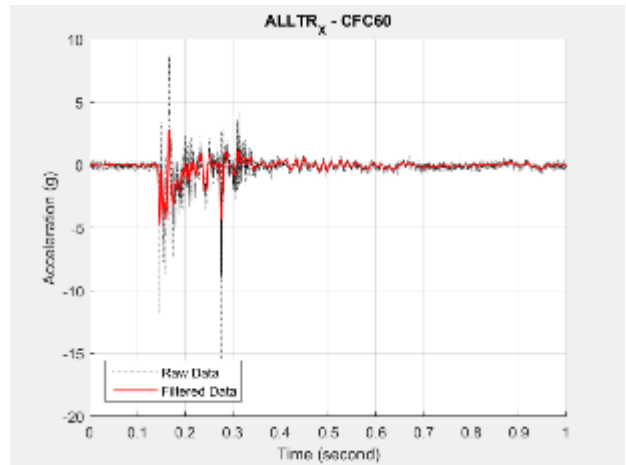

Figure D8. ALLTR_X Accelerometer Data

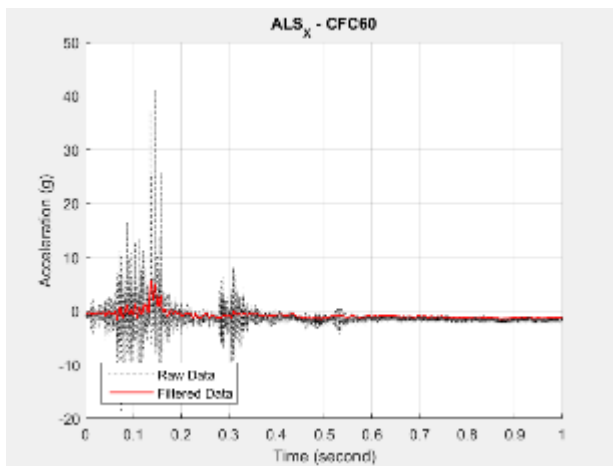

Figure D9. ALS_X Accelerometer Data

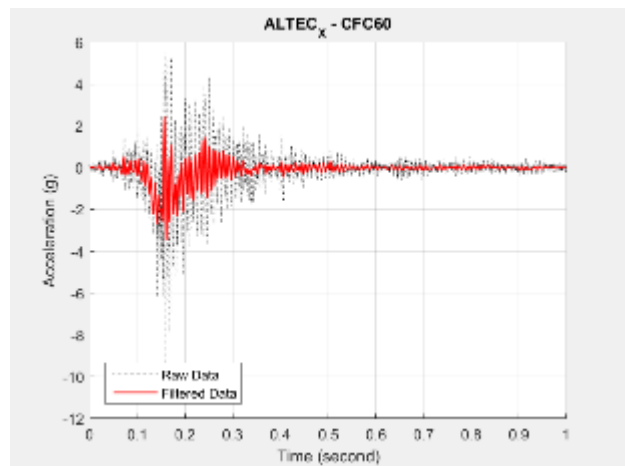

Figure D10. ALTEC_X Accelerometer Data

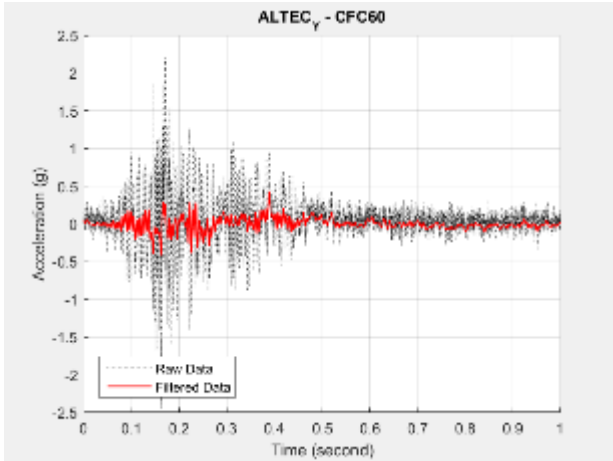

Figure D11. ALTEC_Y Accelerometer Data

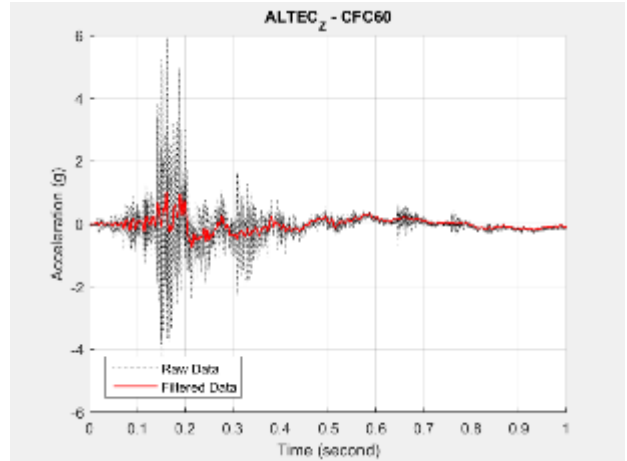

Figure D12. ALTEC_Z Accelerometer Data

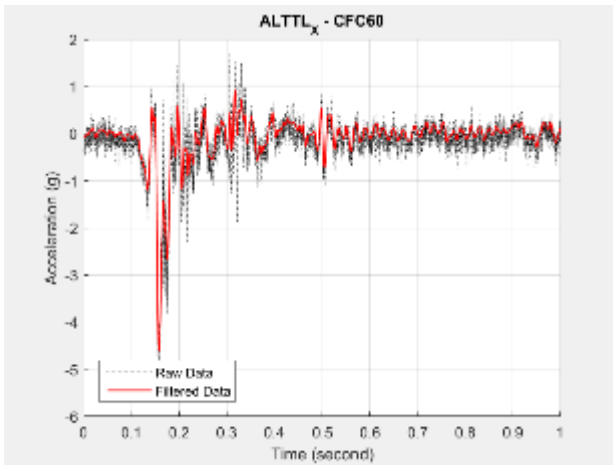

Figure D13. ALTTL_X Accelerometer Data

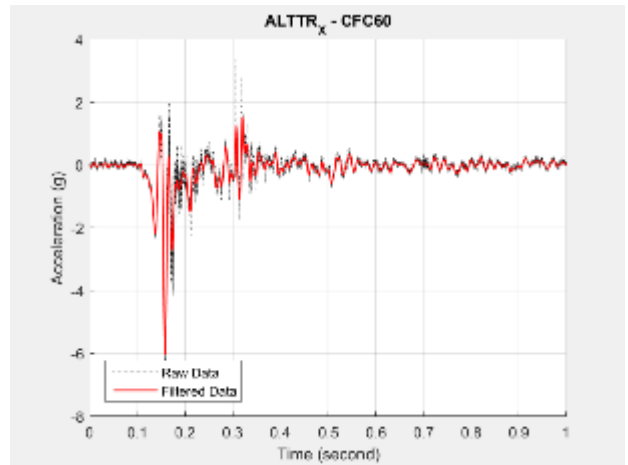

Figure D14. ALTTR_X Accelerometer Data

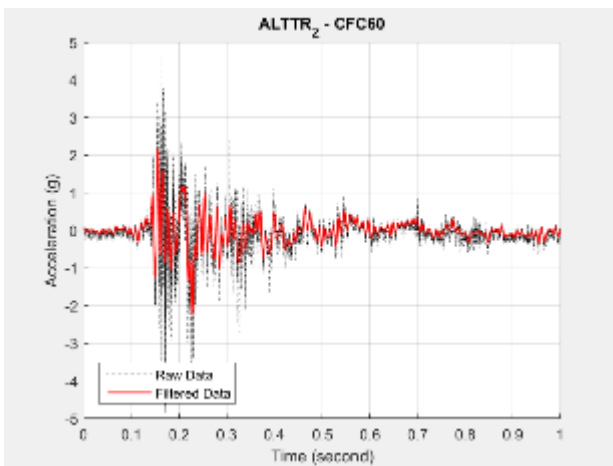

Figure D15. ALTTR_Z Accelerometer Data

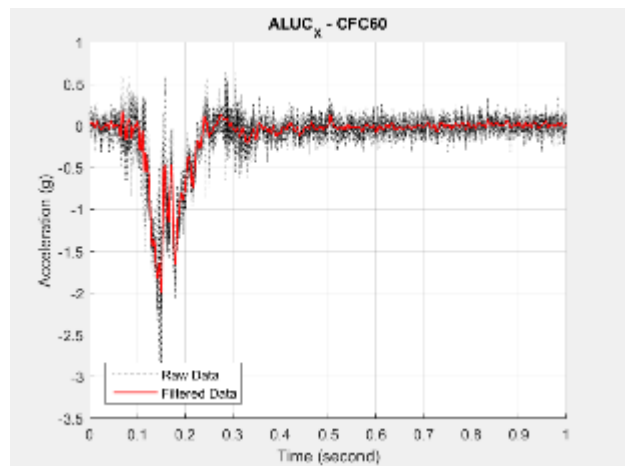

Figure D16. ALUC_X Accelerometer Data

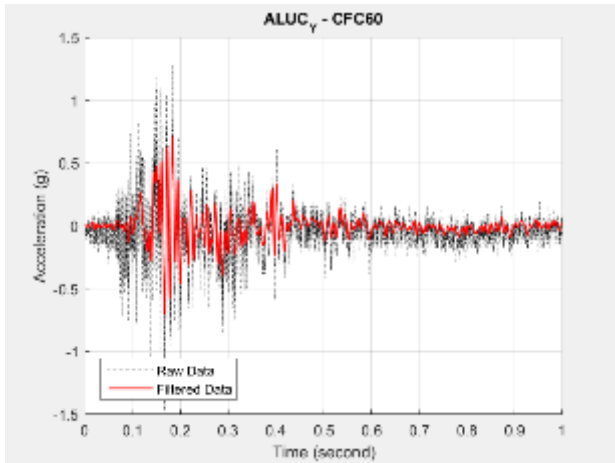

Figure D17. ALUC_Y Accelerometer Data

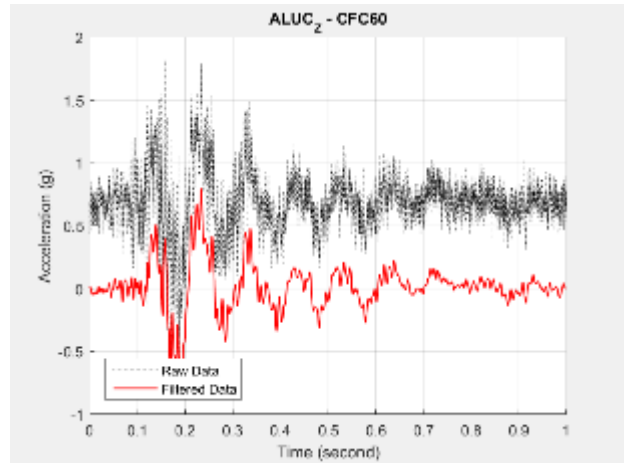

Figure D18. ALUC_Z Accelerometer Data

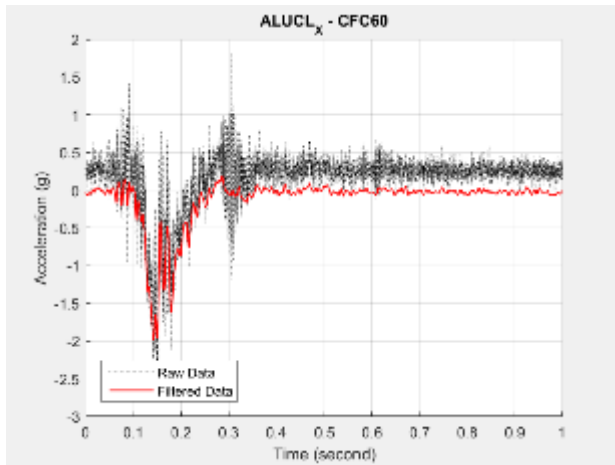

Figure D19. ALUCL_X Accelerometer Data

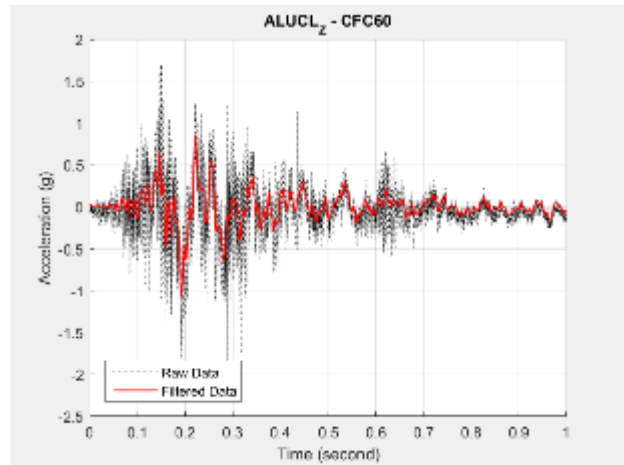

Figure D20. ALUCL_Z Accelerometer Data

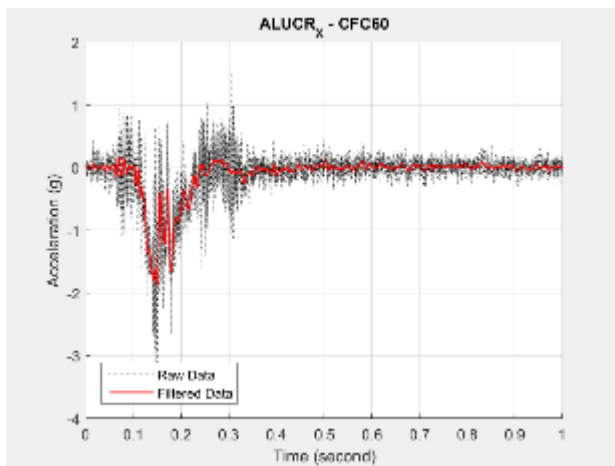

Figure D21. ALUCR_X Accelerometer Data

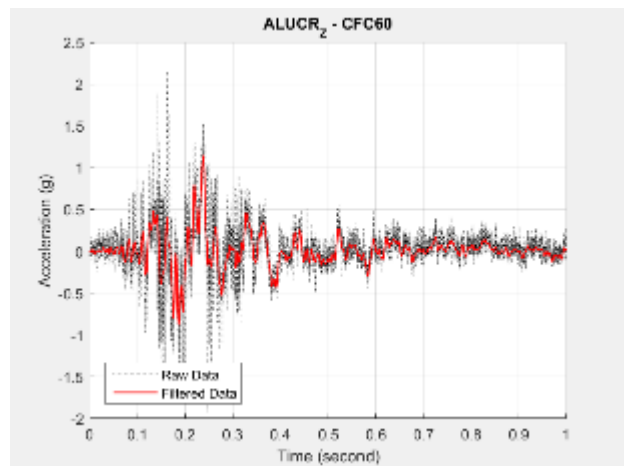

Figure D22. ALUCR_Z Accelerometer Data

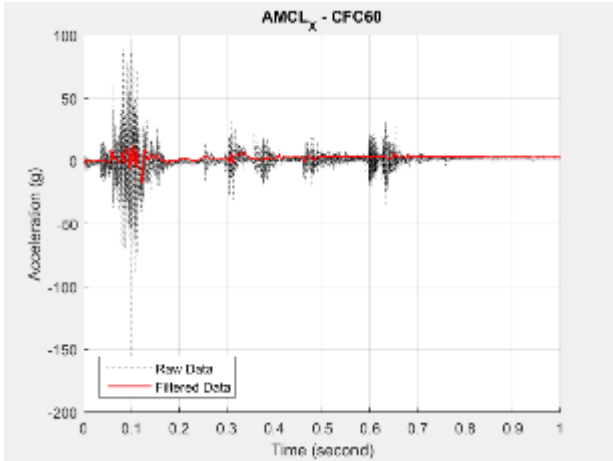

Figure D23. AMCL_X Accelerometer Data

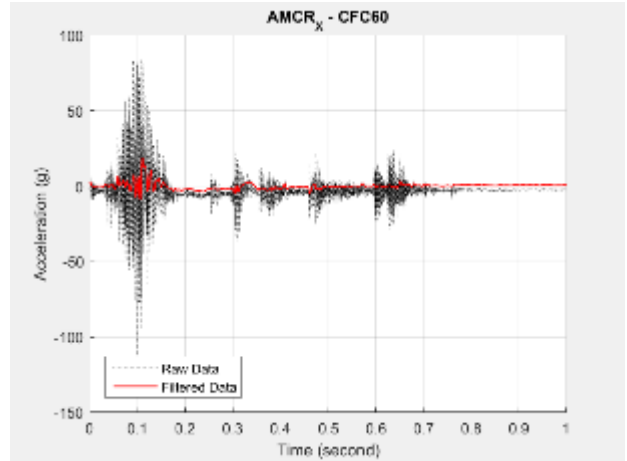

Figure D24. AMCR_X Accelerometer Data

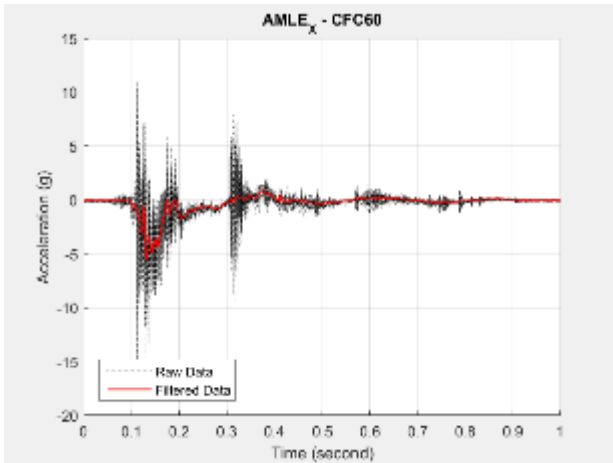

Figure D25. AMLE_X Accelerometer Data

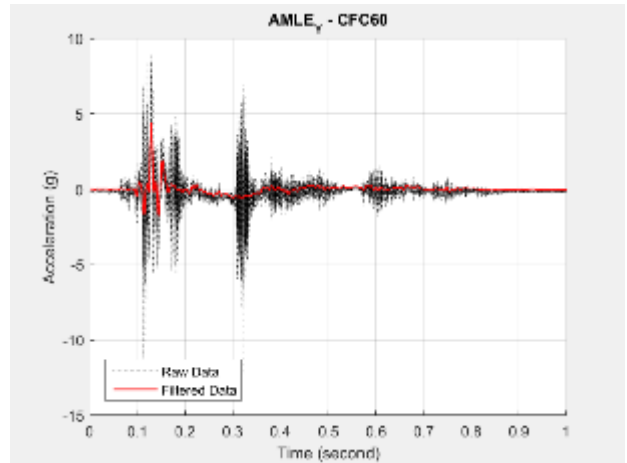

Figure D26. AMLE_Y Accelerometer Data

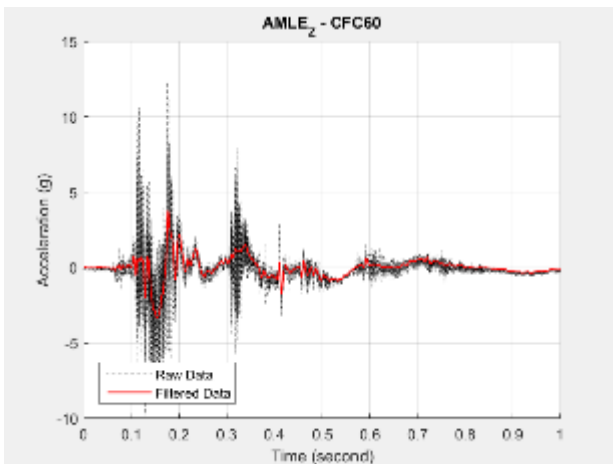

Figure D27. AMLE_Z Accelerometer Data

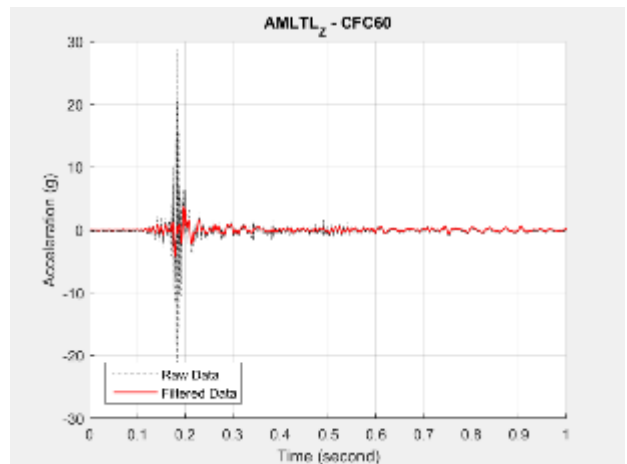

Figure D28. AMLTL_Z Accelerometer Data

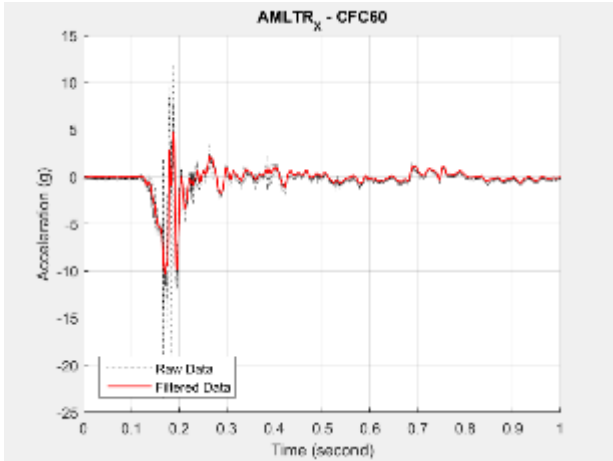

Figure D29. AMLTR_X Accelerometer Data

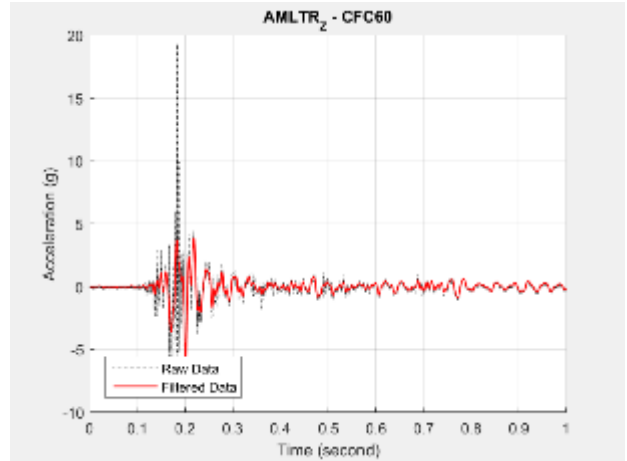

Figure D30. AMLTR_Z Accelerometer Data

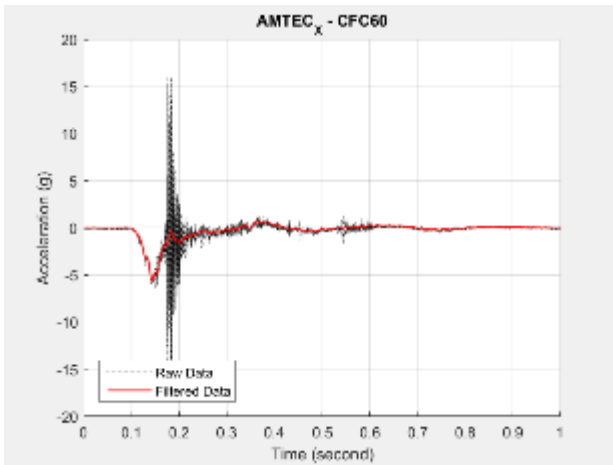

Figure D31. AMTEC_X Accelerometer Data

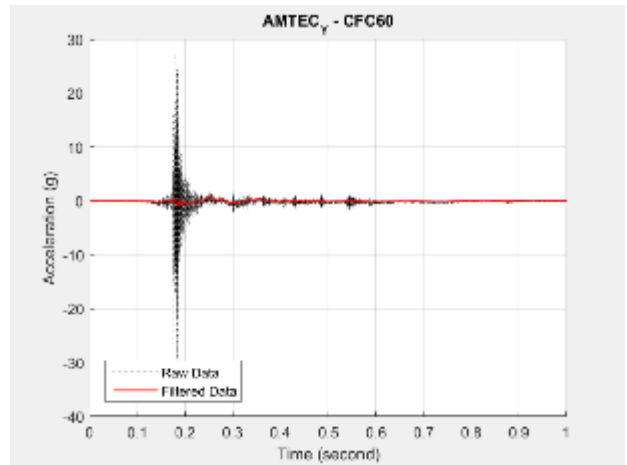

Figure D32. AMTEC_Y Accelerometer Data

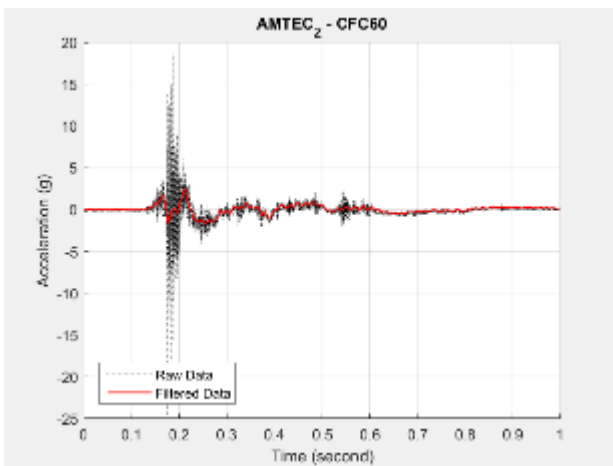

Figure D33. AMTEC_Z Accelerometer Data

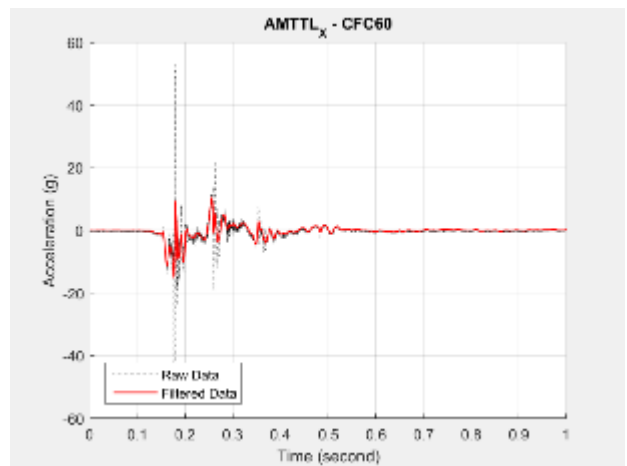

Figure D34. AMTTL_X Accelerometer Data

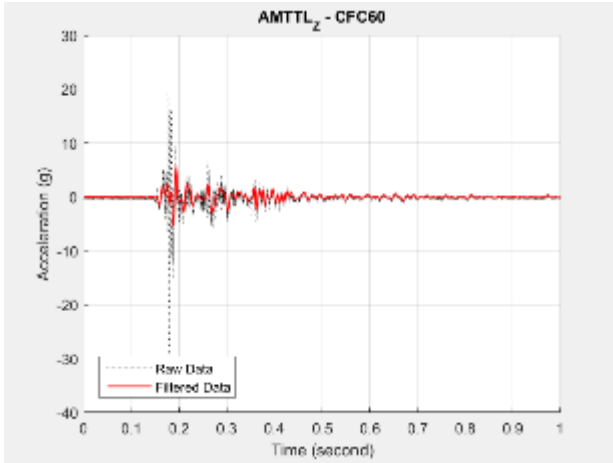

Figure D35. AMTTL_Z Accelerometer Data

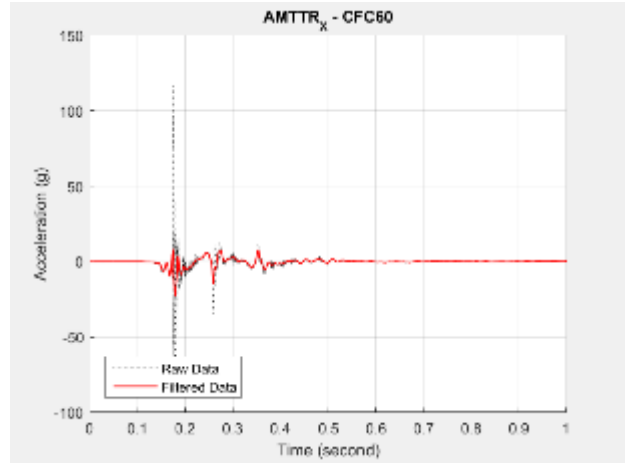

Figure D36. AMTTR_X Accelerometer Data

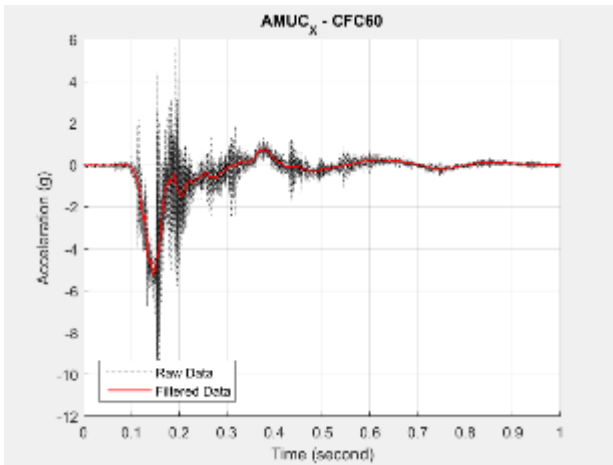

Figure D37. AMUC_X Accelerometer Data

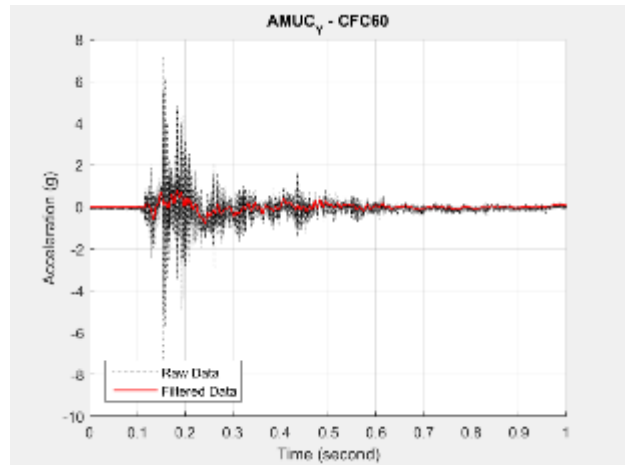

Figure D38. AMUC_Y Accelerometer Data

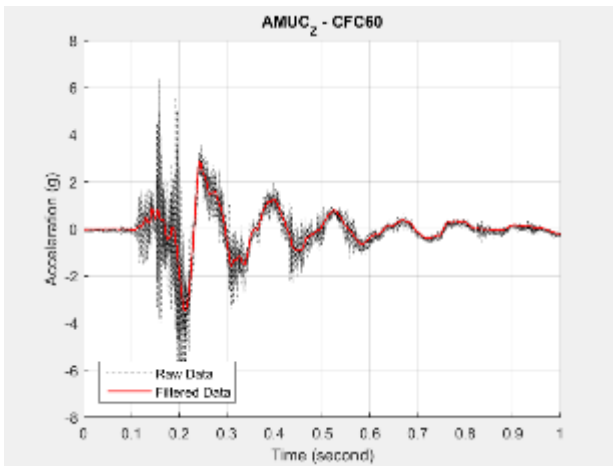

Figure D39. AMUC_Z Accelerometer Data

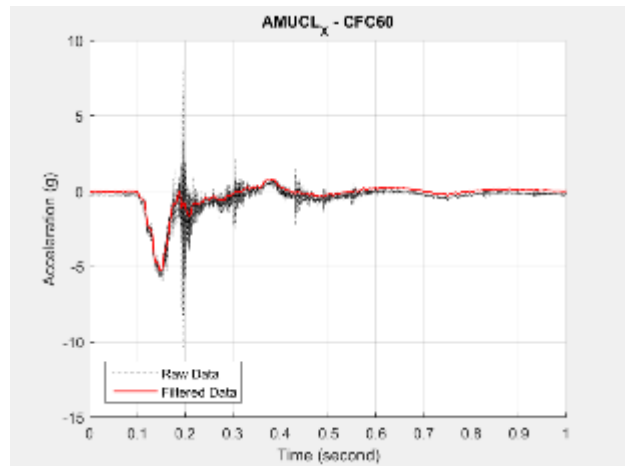

Figure D40. AMUCL_X Accelerometer Data

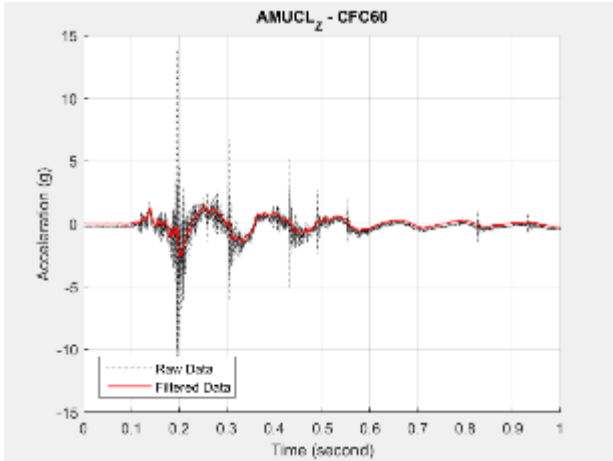

Figure D41. AMUCL_Z Accelerometer Data

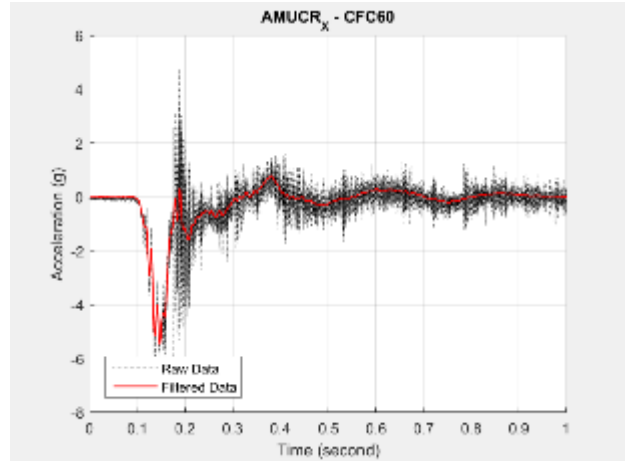

Figure D42. AMUCR_X Accelerometer Data

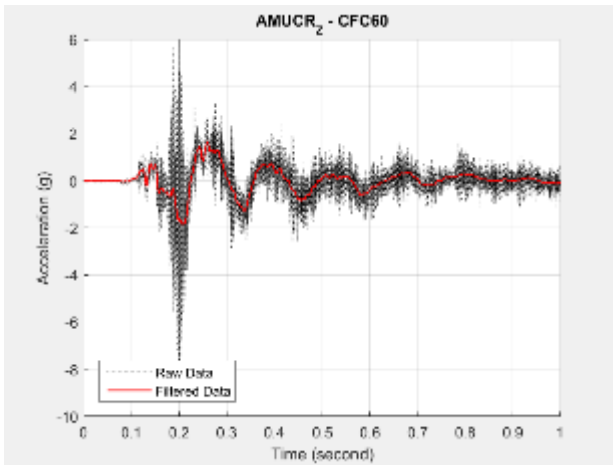

Figure D43. AMUCR_Z Accelerometer Data

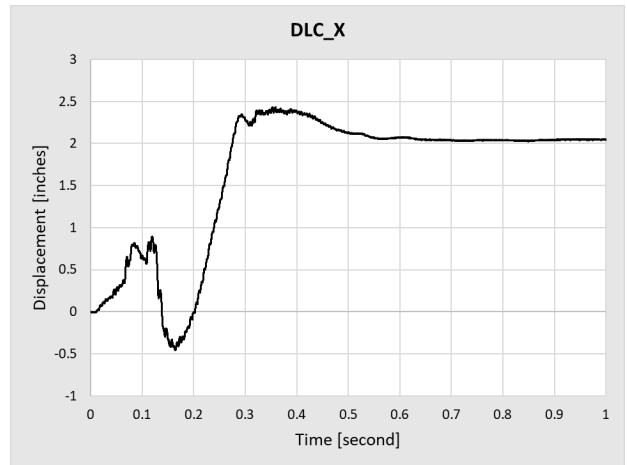

Figure D44. DLC_X Displacement Data

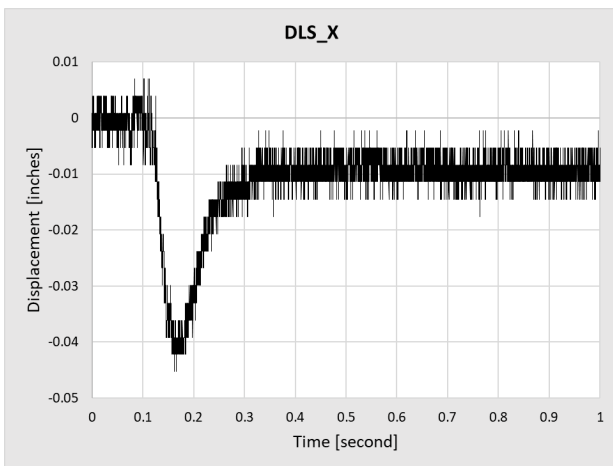

Figure D45. DLS_X Displacement Data

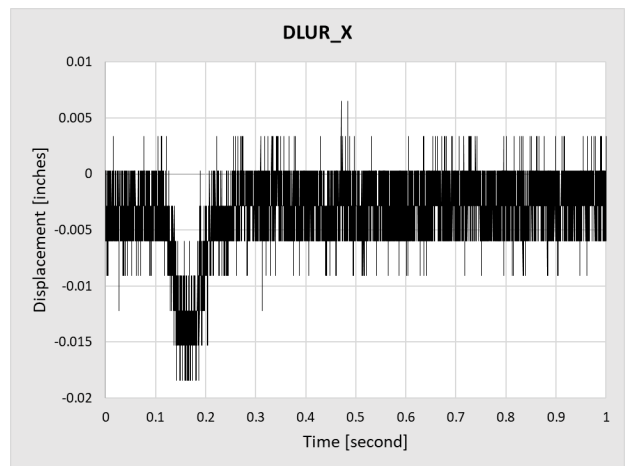

Figure D46. DLUR_X Displacement Data

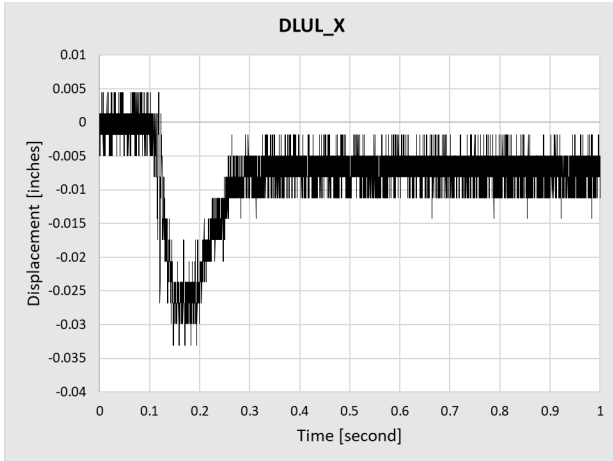

Figure D47. DLUL_X Displacement Data

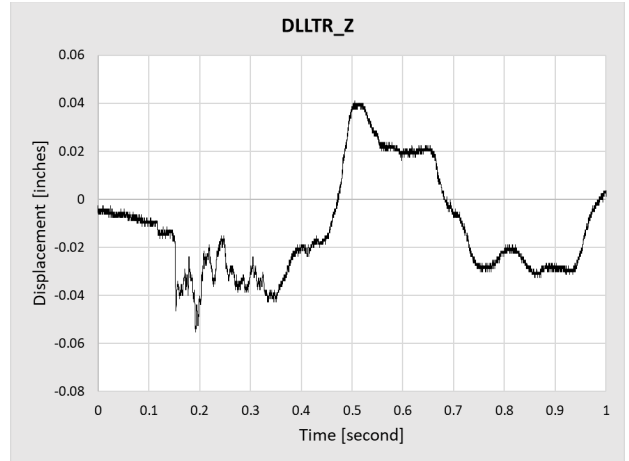

Figure D48. DLLTR_Z Displacement Data

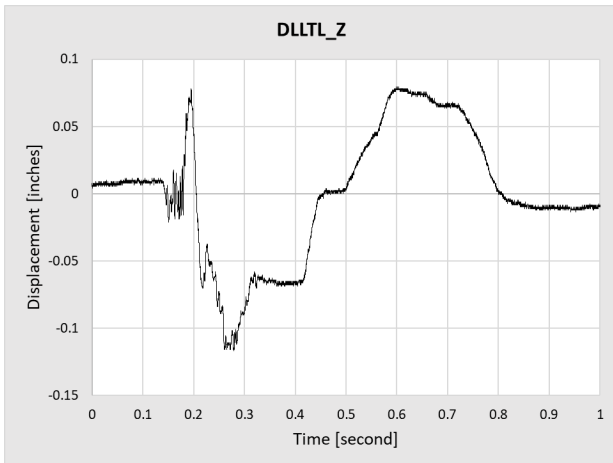

Figure D49. DLLTL_Z Displacement Data

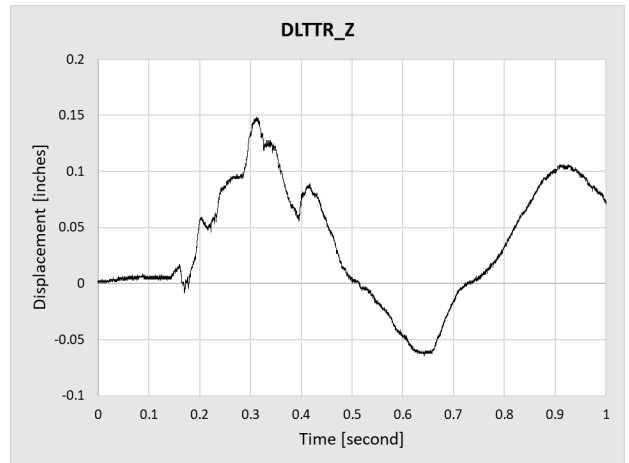

Figure D50. DLTTR_Z Displacement Data

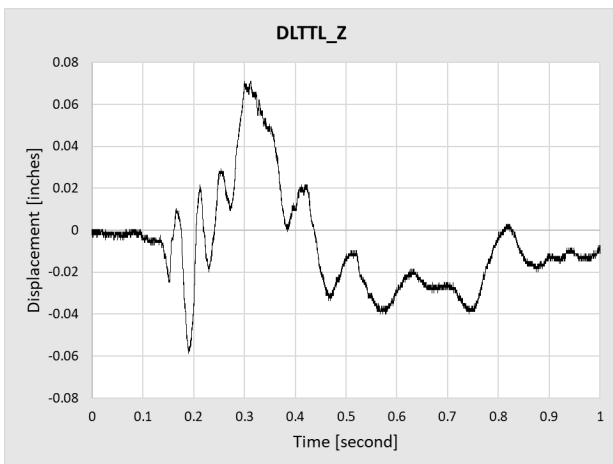

Figure D51. DLTTL_Z Displacement Data

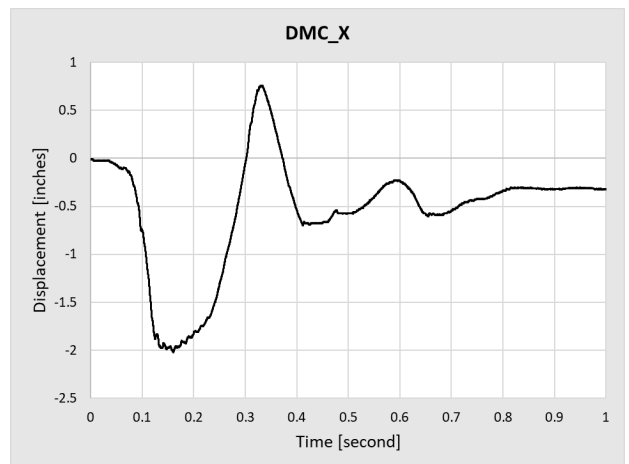

Figure D52. DMC_X Displacement Data

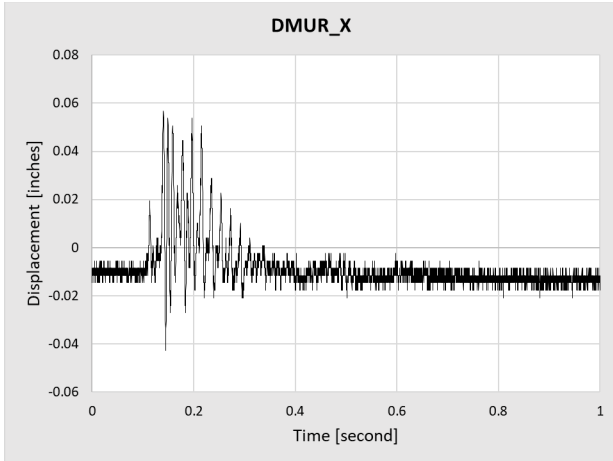

Figure D53. DMUR_X Displacement Data

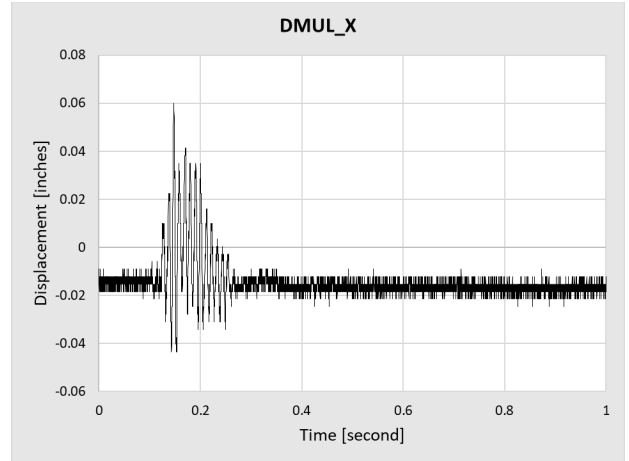

Figure D54. DMUL_X Displacement Data

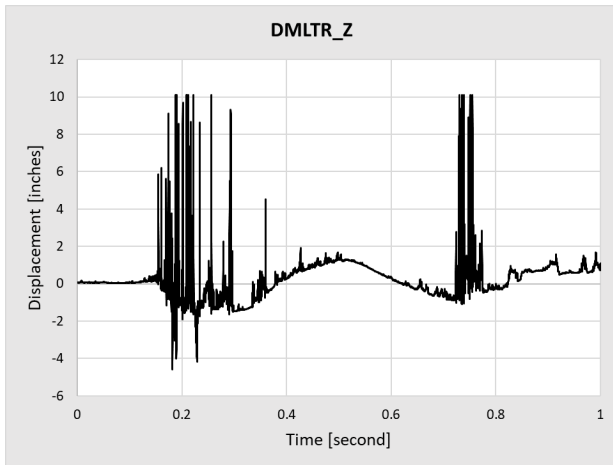

Figure D55. DMLTR_Z Displacement Data

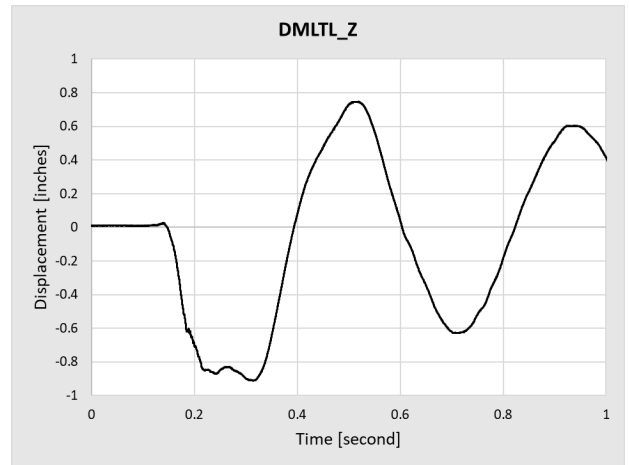

Figure D56. DMLTL_Z Displacement Data

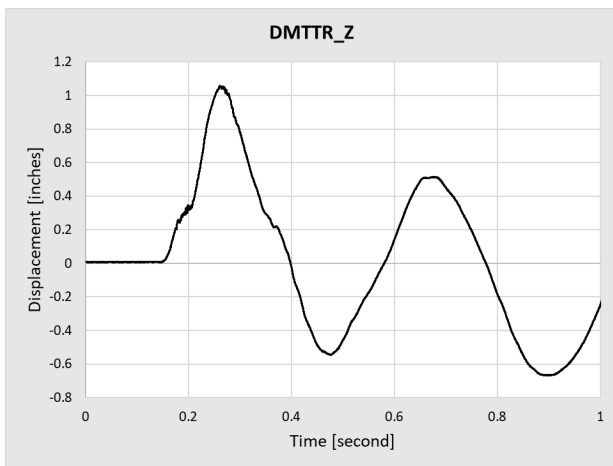

Figure D57. DMTTR_Z Displacement Data

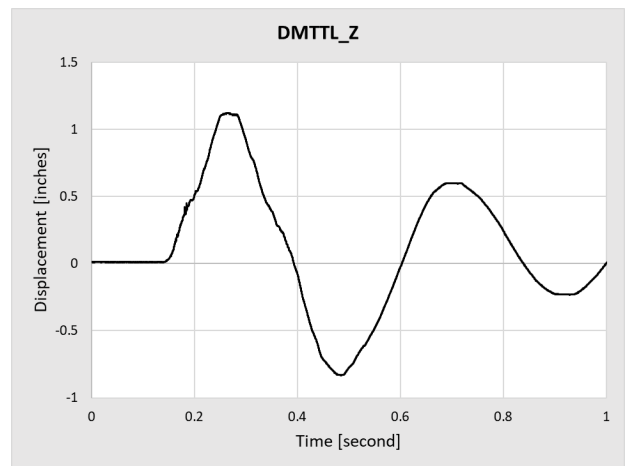

Figure D58. DMTTL_Z Displacement Data

Appendix E. 7 mph Test Data

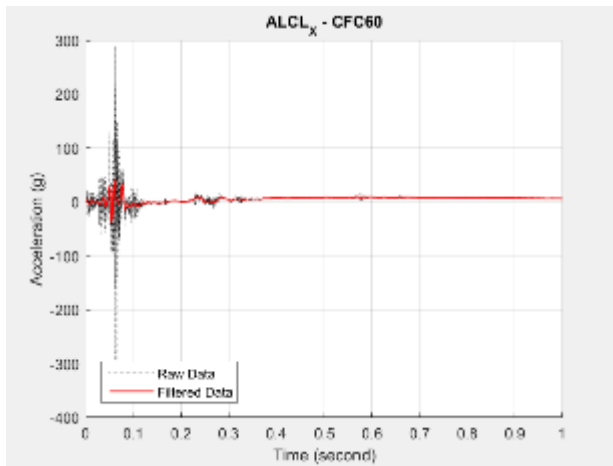

Figure E1. ALCL_X Accelerometer Data

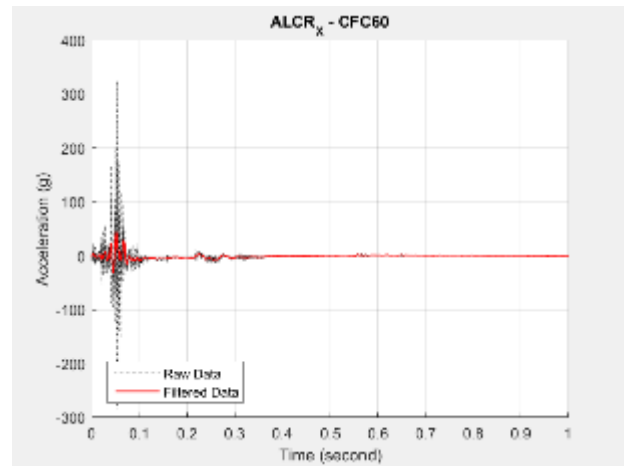

Figure E2. ALCR_X Accelerometer Data

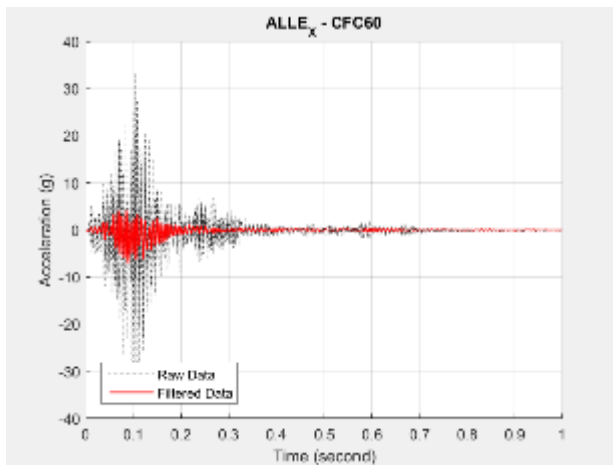

Figure E3. ALLE_X Accelerometer Data

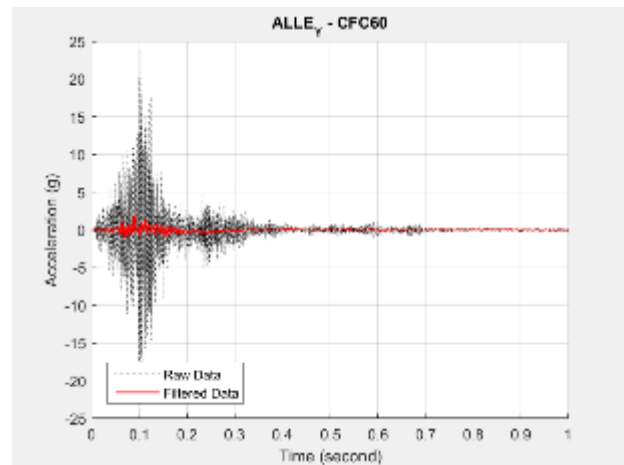

Figure E4. ALLE_Y Accelerometer Data

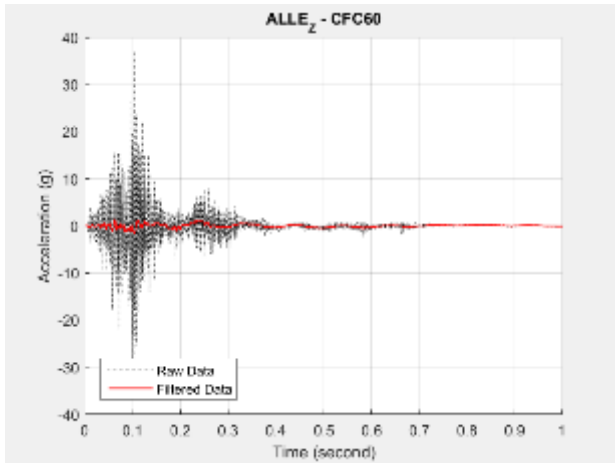

Figure E5. ALLE_Z Accelerometer Data

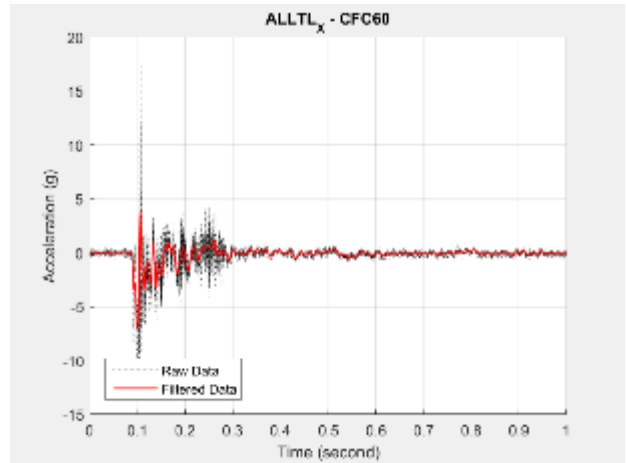

Figure E6. ALLTL_X Accelerometer Data

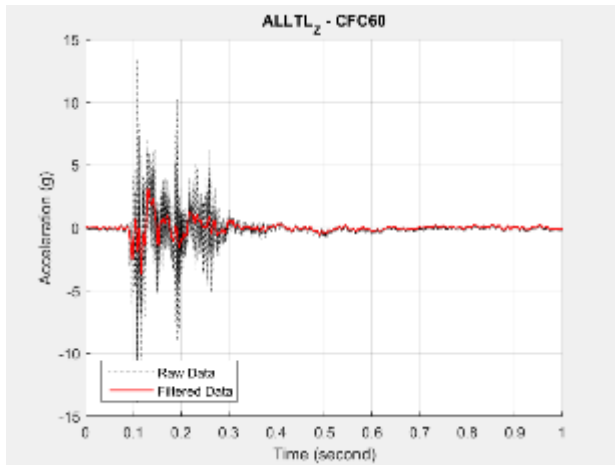

Figure E7. ALLTL_Z Accelerometer Data

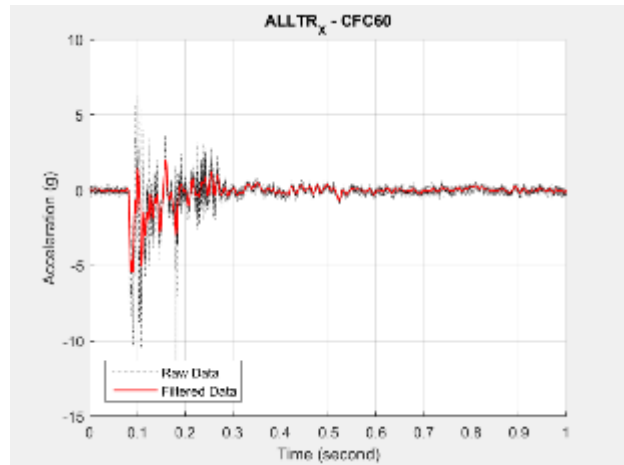

Figure E8. ALLTR_X Accelerometer Data

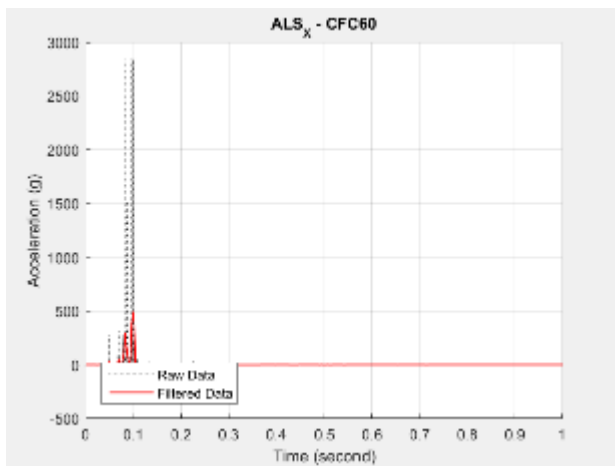

Figure E9. ALS_X Accelerometer Data

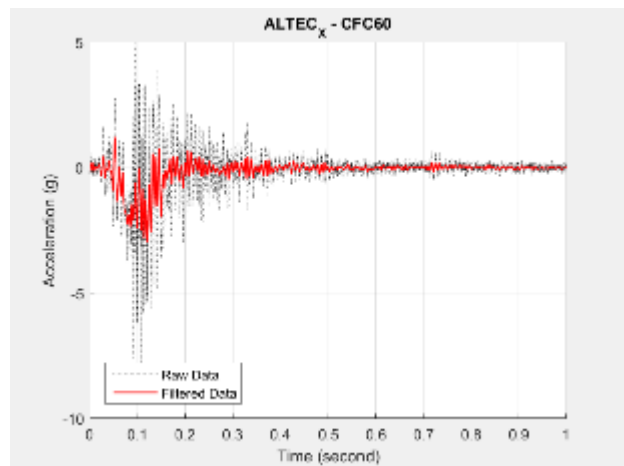

Figure E10. ALTEC_X Accelerometer Data

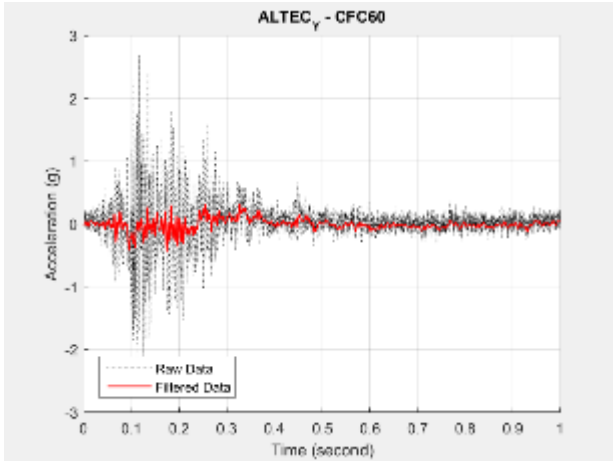

Figure E11. ALTEC_Y Accelerometer Data

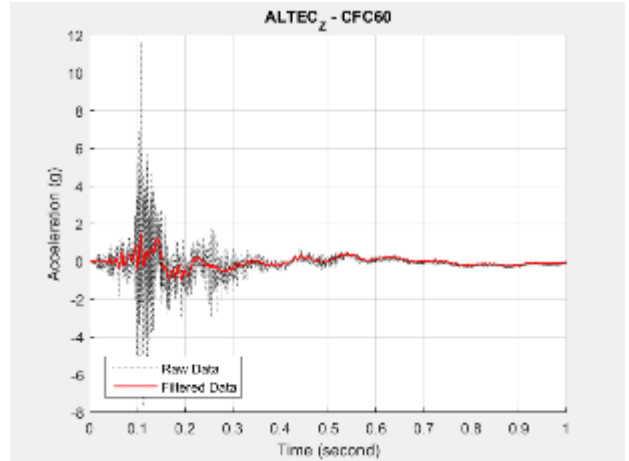

Figure E12. ALTEC_Z Accelerometer Data

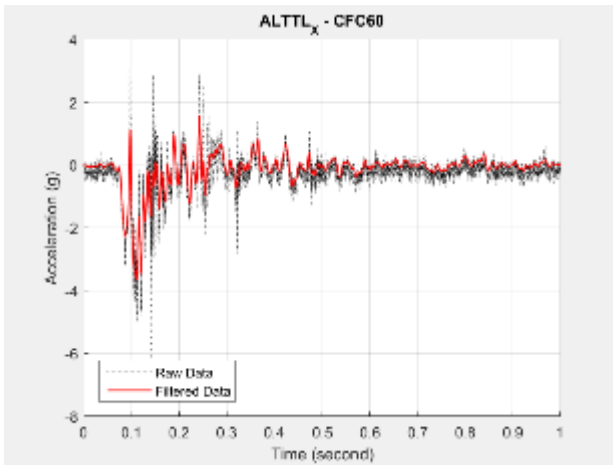

Figure E13. ALTTL_X Accelerometer Data

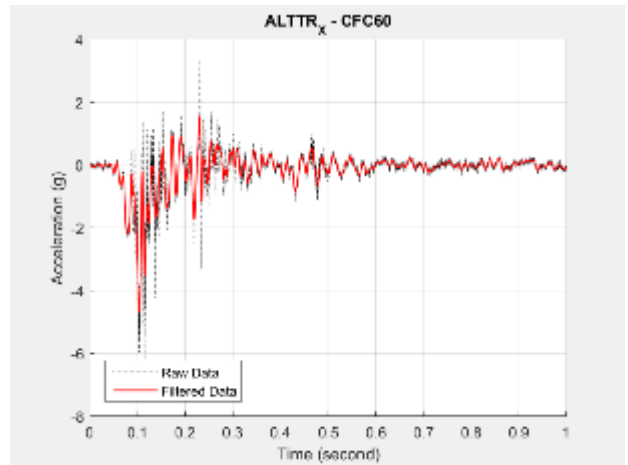

Figure E14. ALTRR_X Accelerometer Data

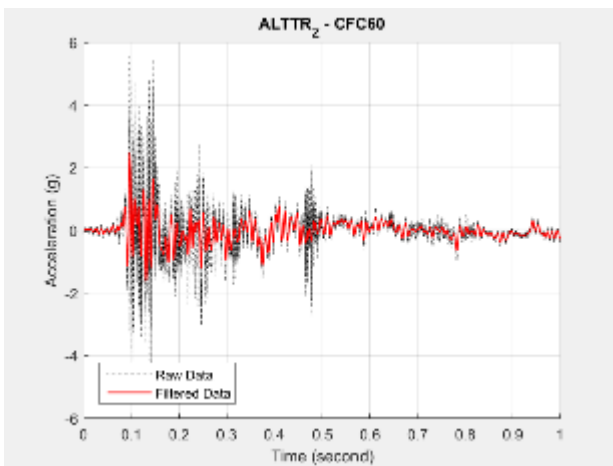

Figure E15. ALTRR_Z Accelerometer Data

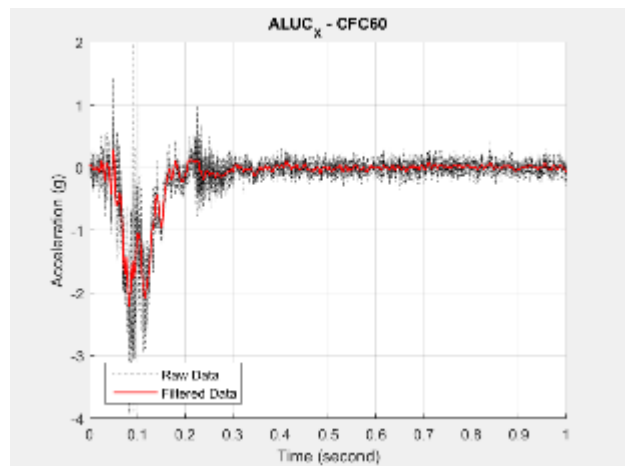

Figure E16. ALUC_X Accelerometer Data

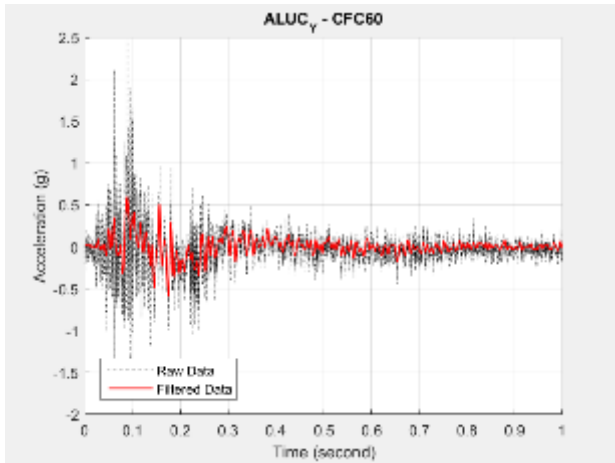

Figure E17. ALUC_Y Accelerometer Data

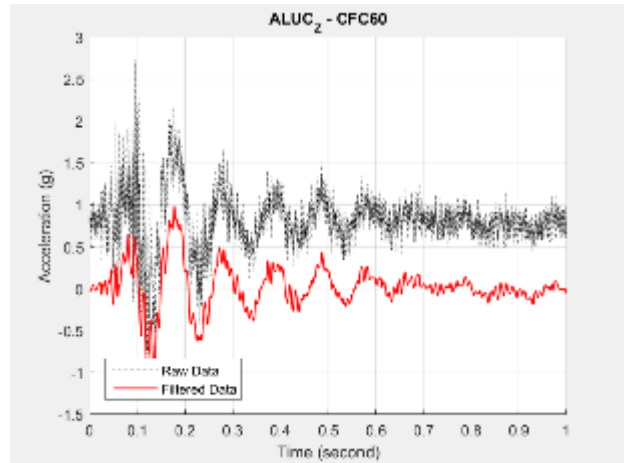

Figure E18. ALUC_Z Accelerometer Data

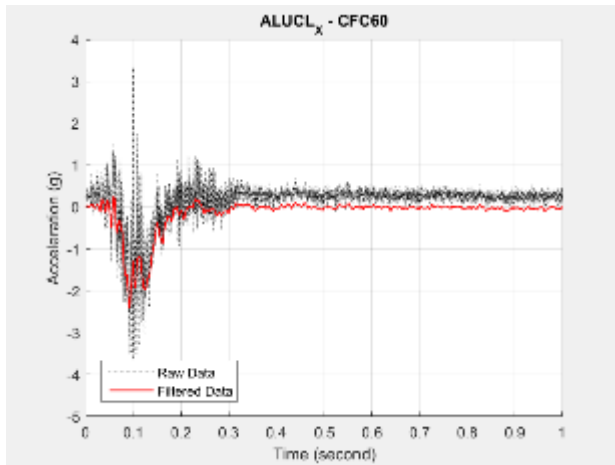

Figure E19. ALUCL_X Accelerometer Data

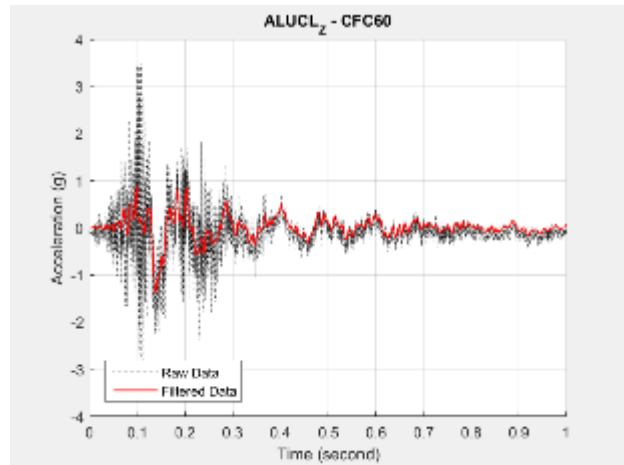

Figure E20. ALUCL_Z Accelerometer Data

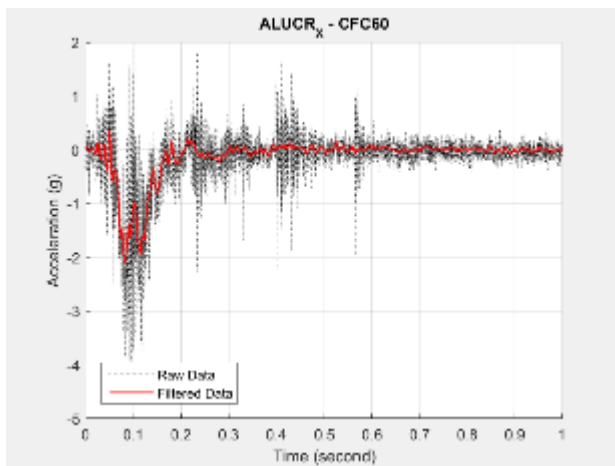

Figure E21. ALUCR_X Accelerometer Data

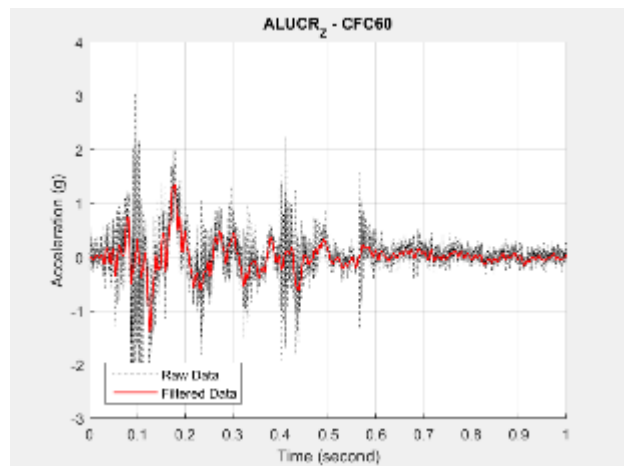

Figure E22. ALUCR_Z Accelerometer Data

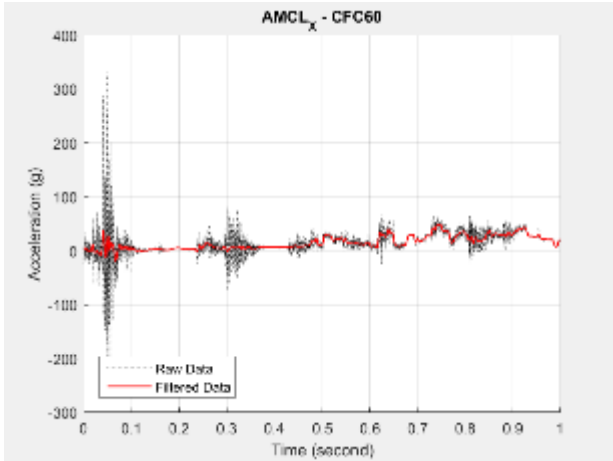

Figure E23. AMCL_X Accelerometer Data

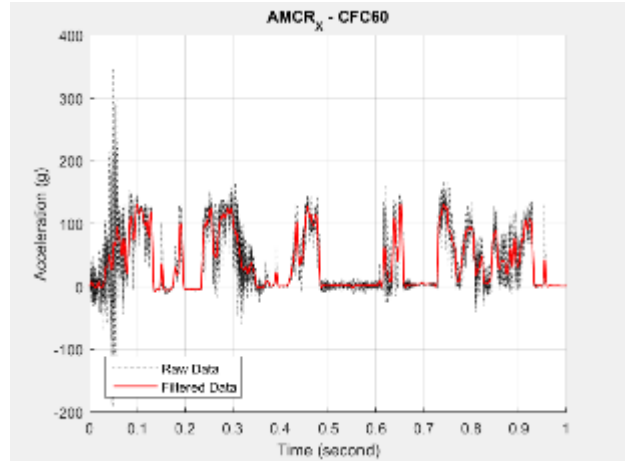

Figure E24. AMCR_X Accelerometer Data

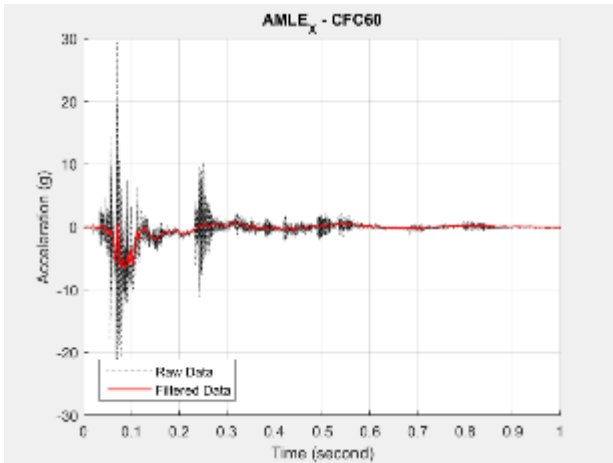

Figure E25. AMLE_X Accelerometer Data

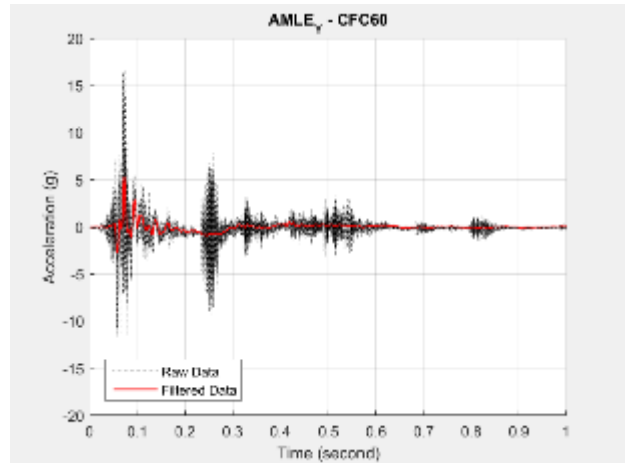

Figure E26. AMLE_Y Accelerometer Data

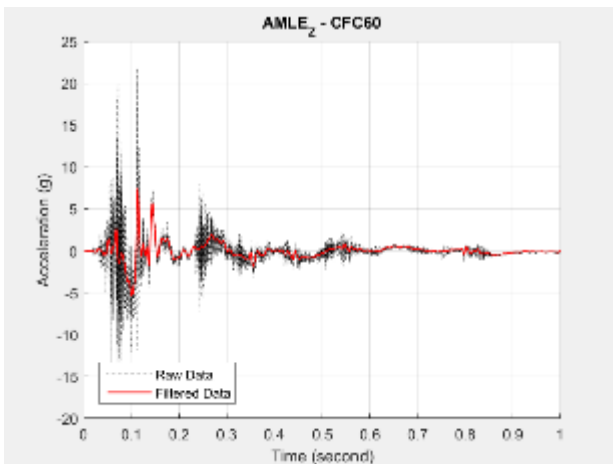

Figure E27. AMLE_Z Accelerometer Data

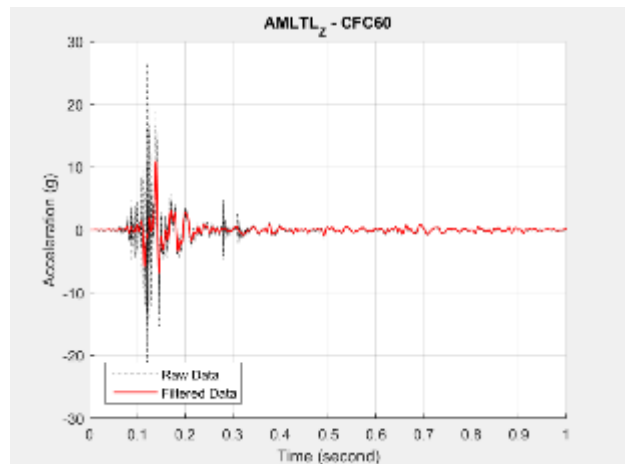

Figure E28. AMLTL_Z Accelerometer Data

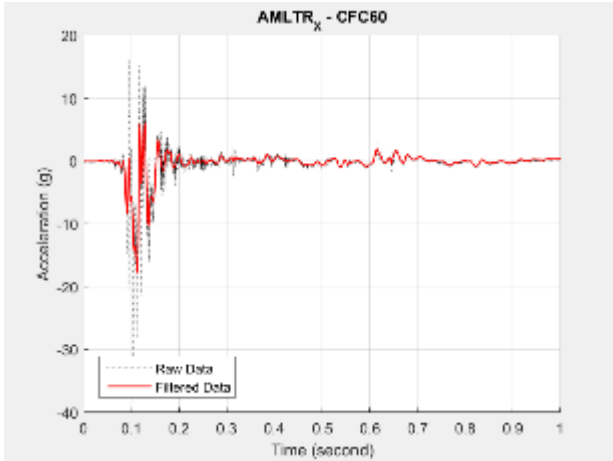

Figure E29. AMLTR_X Accelerometer Data

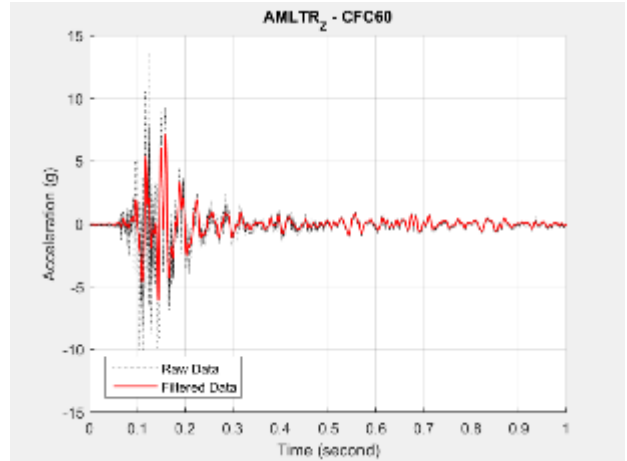

Figure E30. AMLTR_Z Accelerometer Data

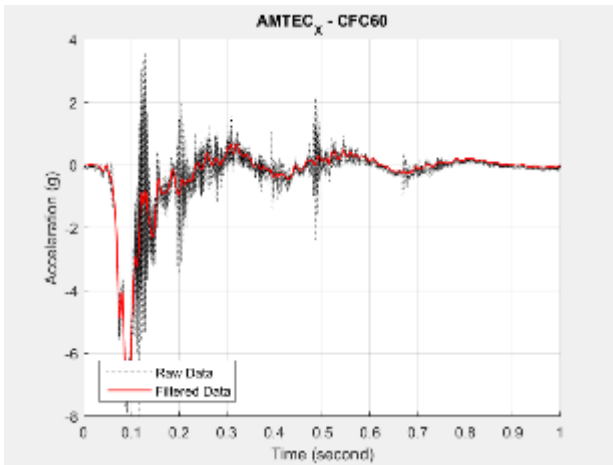

Figure E31. AMTEC_X Accelerometer Data

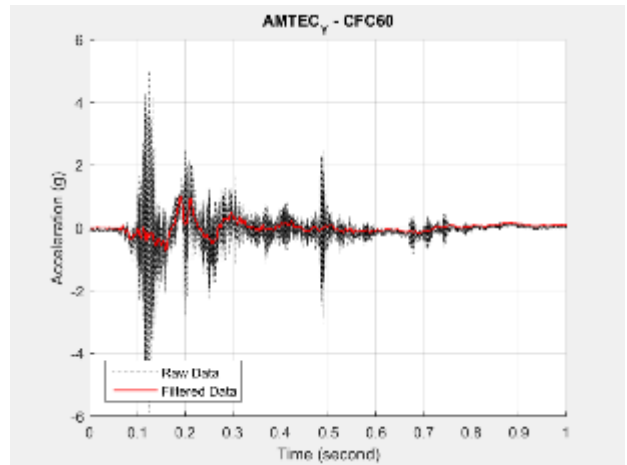

Figure E32. AMTEC_Y Accelerometer Data

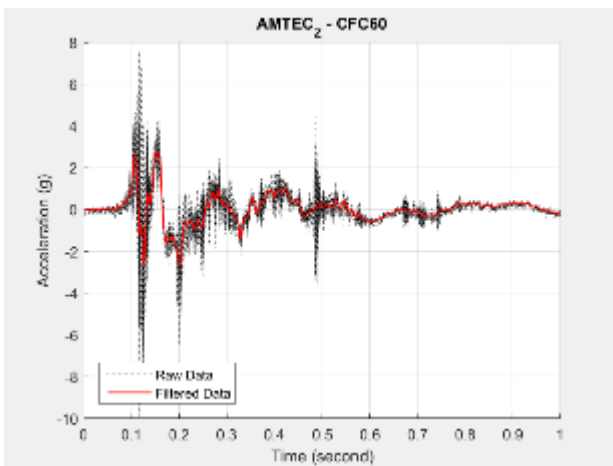

Figure E33. AMTEC_Z Accelerometer Data

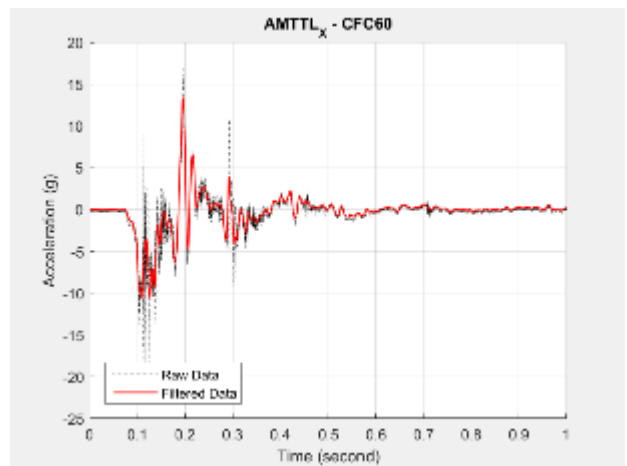

Figure E34. AMTTL_X Accelerometer Data

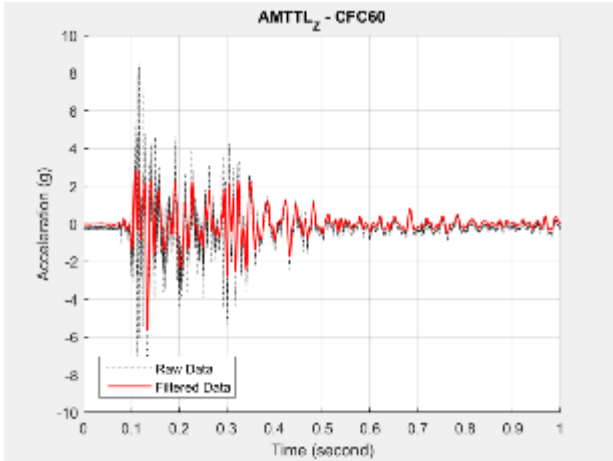

Figure E35. AMTTL_Z Accelerometer Data

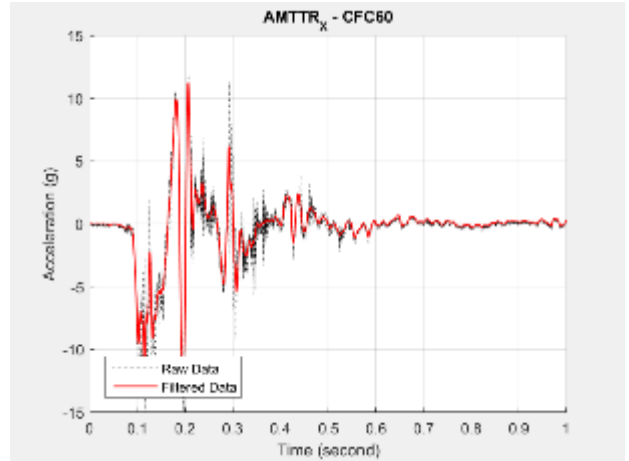

Figure E36. AMTTR_X Accelerometer Data

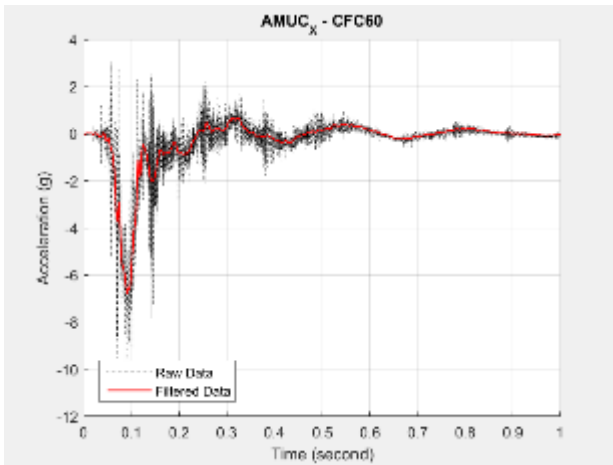

Figure E37. AMUC_X Accelerometer Data

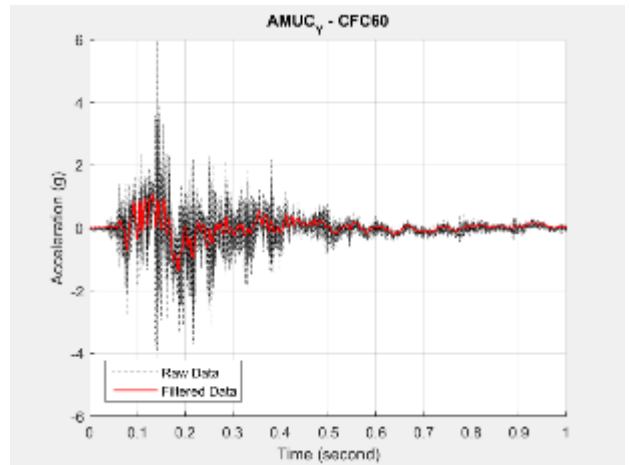

Figure E38. AMUC_Y Accelerometer Data

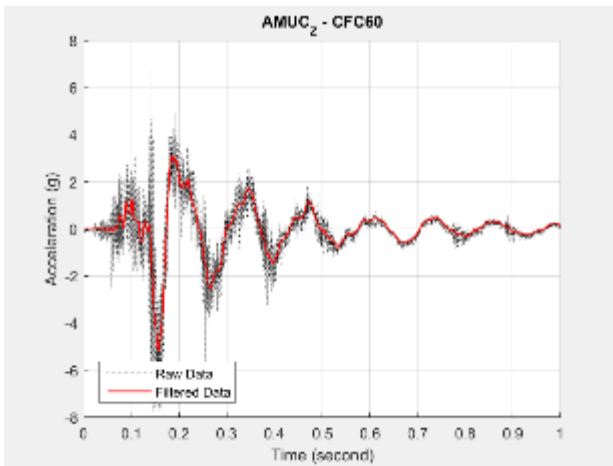

Figure E39. AMUC_Z Accelerometer Data

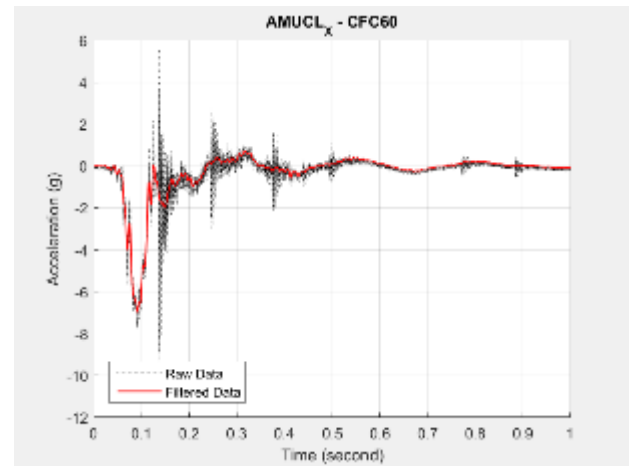

Figure E40. AMUCL_X Accelerometer Data

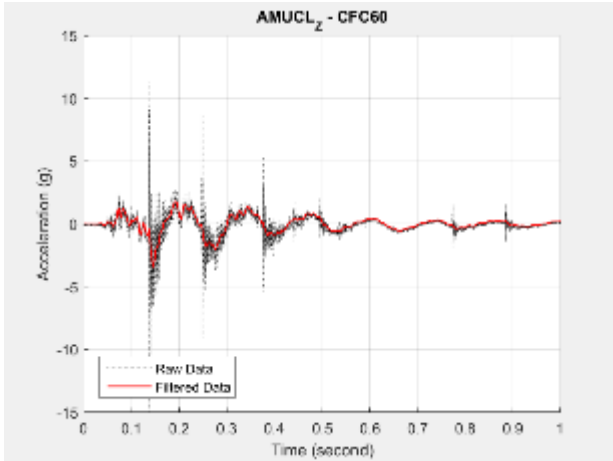

Figure E41. AMUCL_Z Accelerometer Data

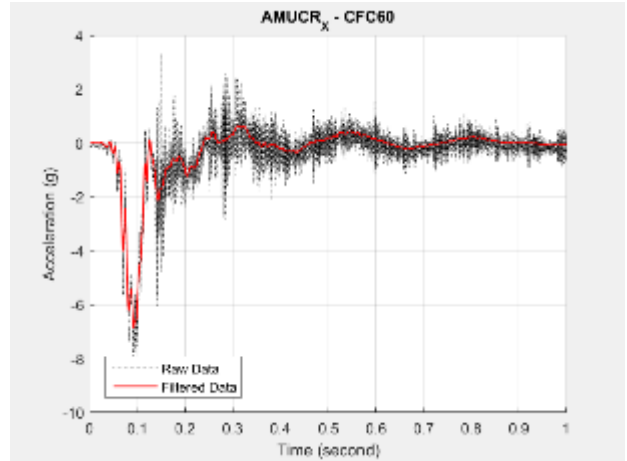

Figure E42. AMUCR_X Accelerometer Data

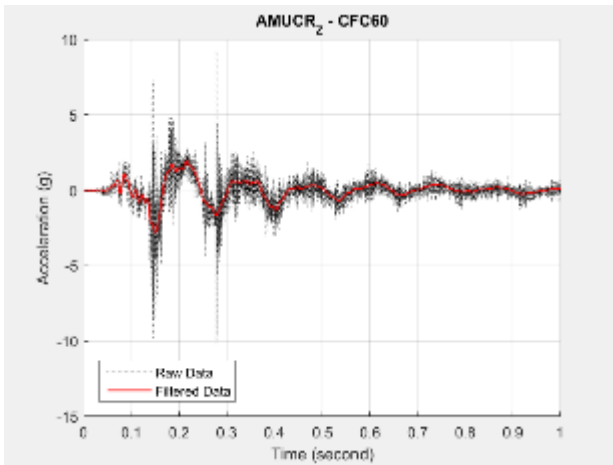

Figure E43. AMUCR_Z Accelerometer Data

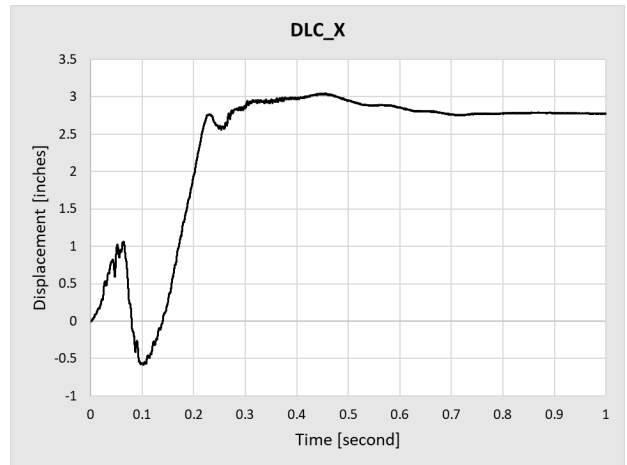

Figure E44. DLS_X Displacement Data

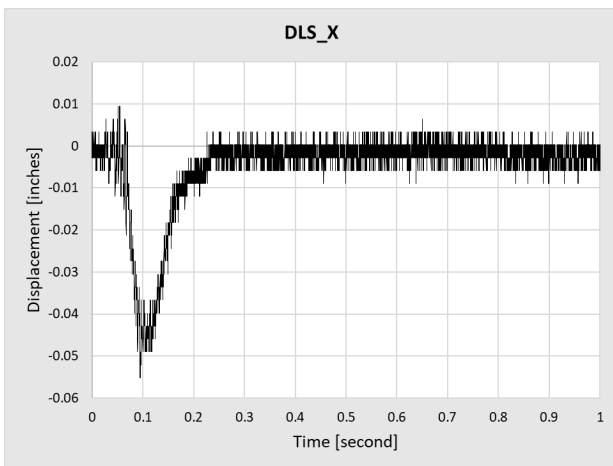

Figure E45. DLS_X Displacement Data

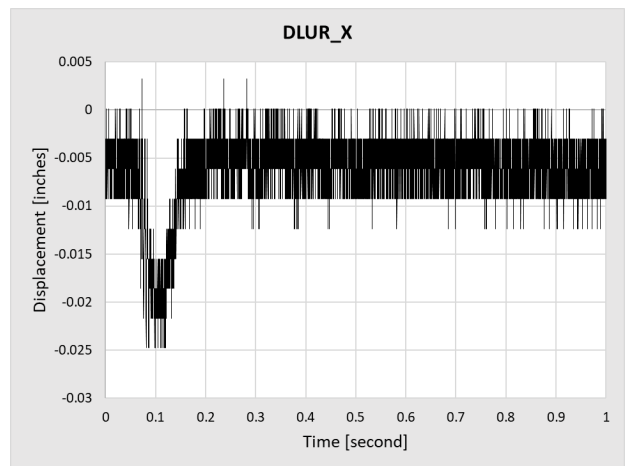

Figure E46. DLUR_X Displacement Data

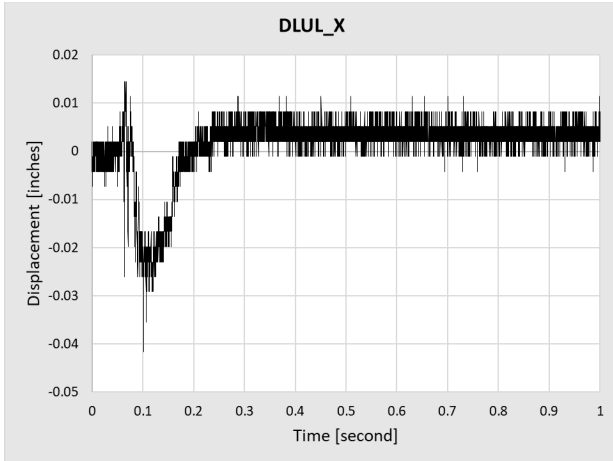

Figure E47. DLUL_X Displacement Data

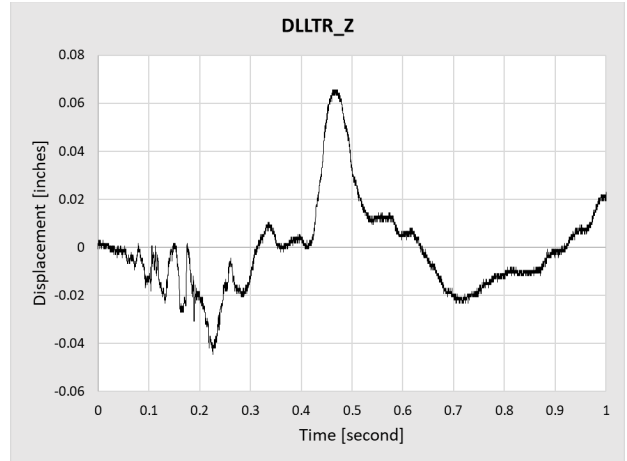

Figure E48. DLLTR_Z Displacement Data

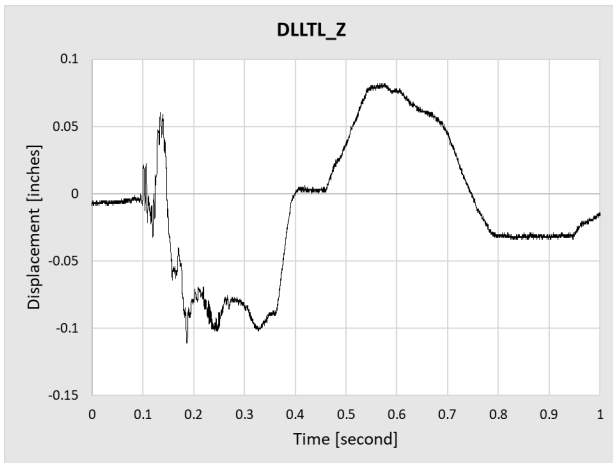

Figure E49. DLLTL_Z Displacement Data

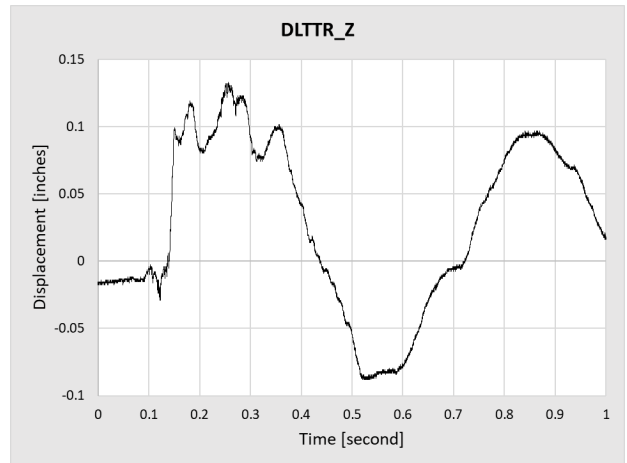

Figure E50. DLTTR_Z Displacement Data

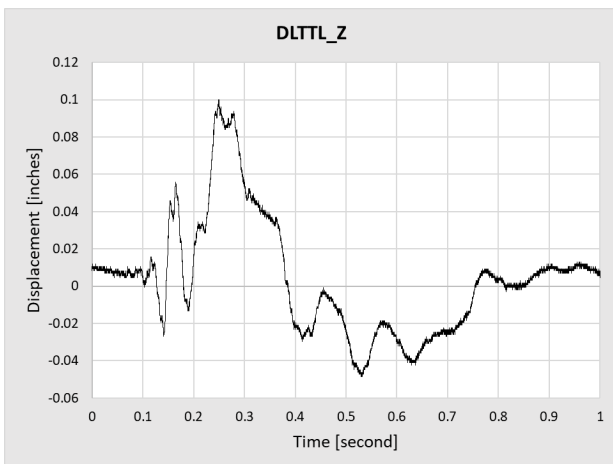

Figure E51. DLTTL_Z Displacement Data

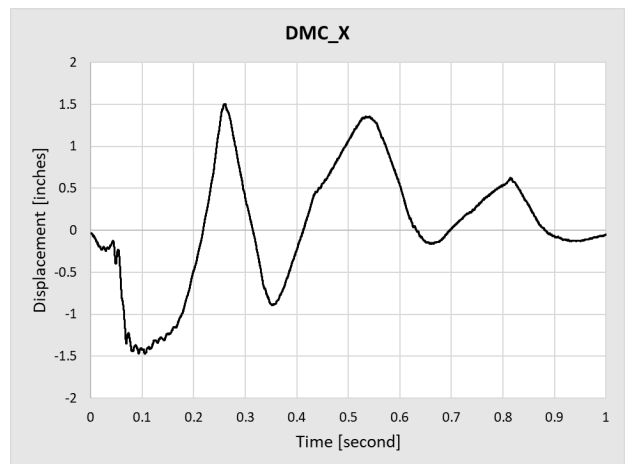

Figure E52. DMC_X Displacement Data

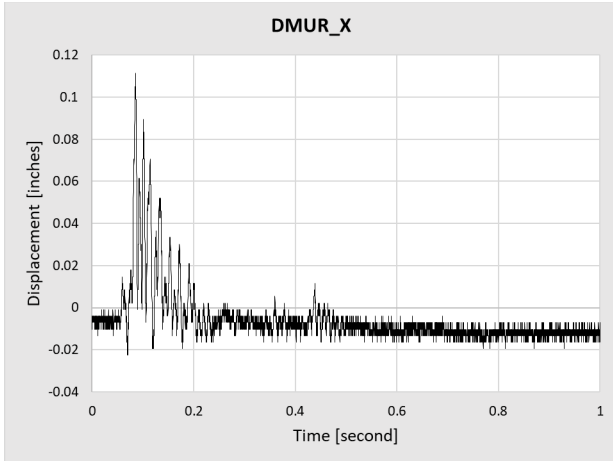

Figure E53. DMUR_X Displacement Data

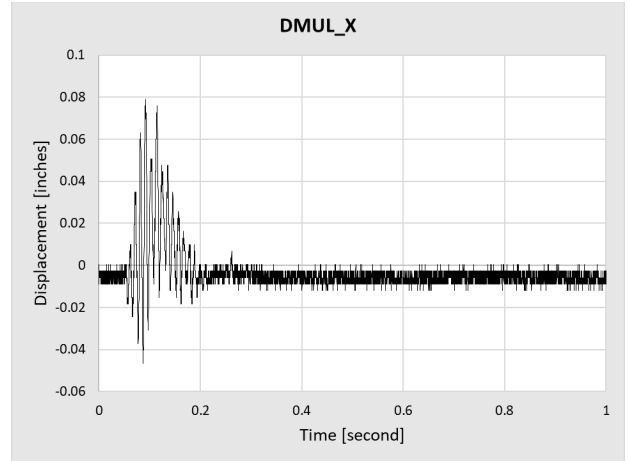

Figure E54. DMUL_X Displacement Data

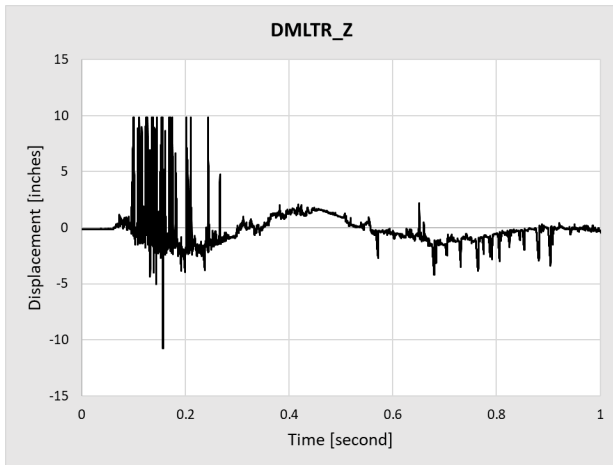

Figure E55. DMLTR_Z Displacement Data

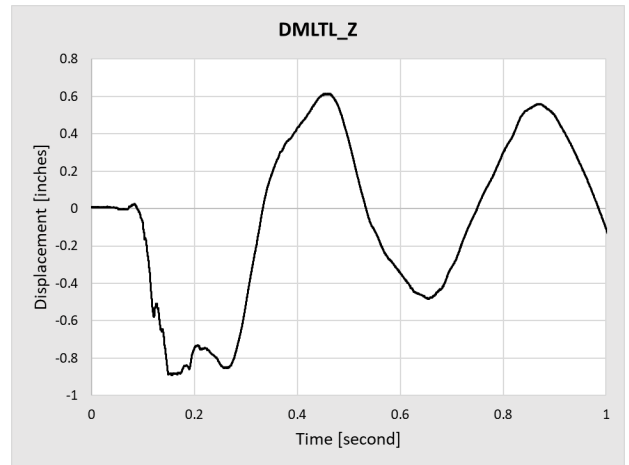

Figure E56. DMLTL_Z Displacement Data

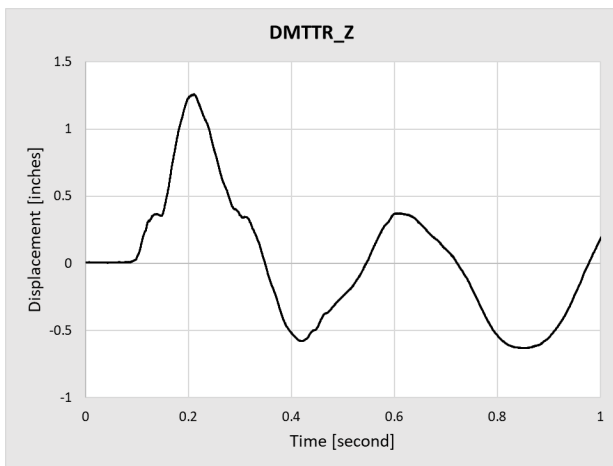

Figure E57. DMTTR_Z Displacement Data

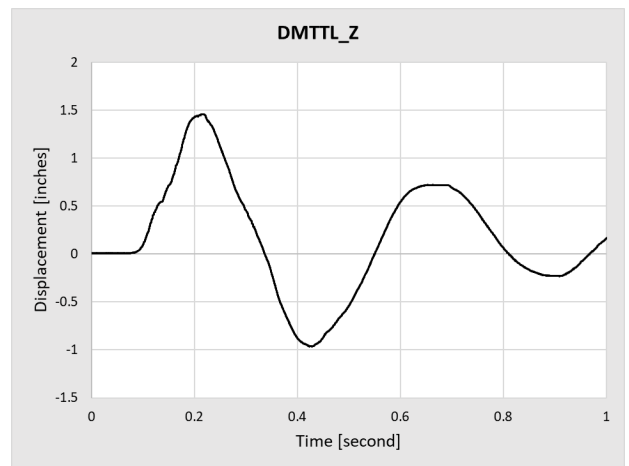

Figure E58. DMTTL_Z Displacement Data

Appendix F. 8 mph Test Data

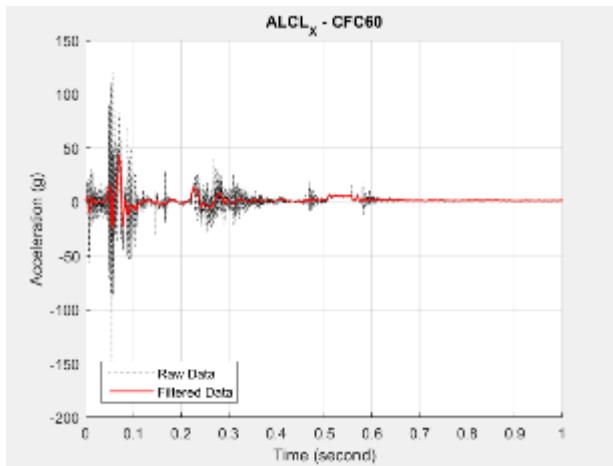

Figure F1. ALCL_X Accelerometer Data

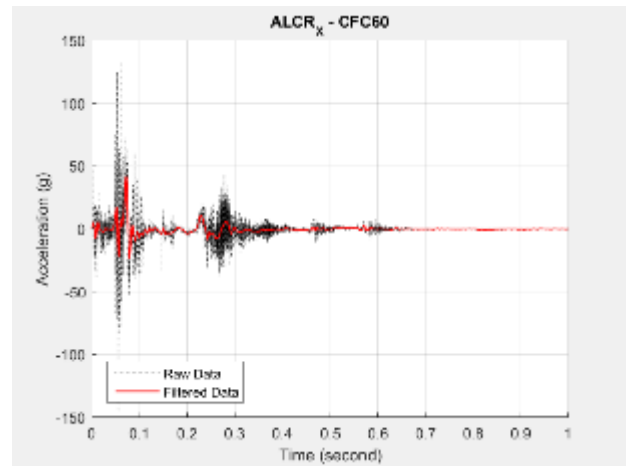

Figure F2. ALCR_X Accelerometer Data

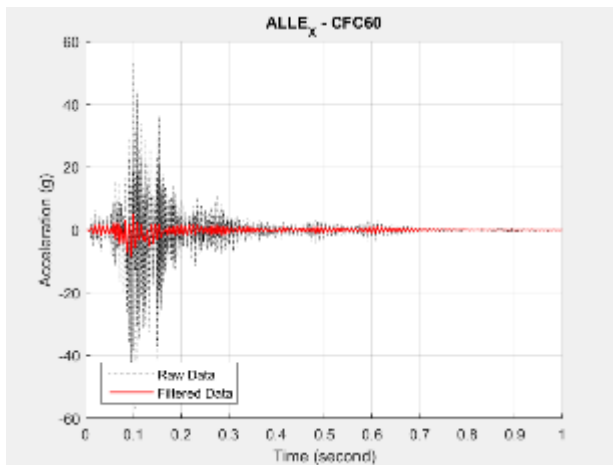

Figure F3. ALLE_X Accelerometer Data

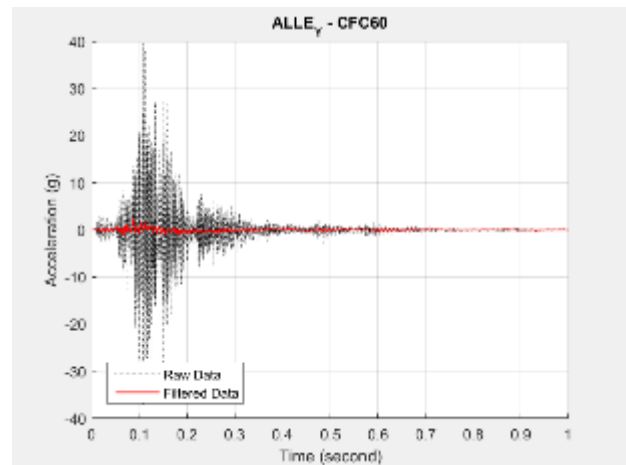

Figure F4. ALLE_Y Accelerometer Data

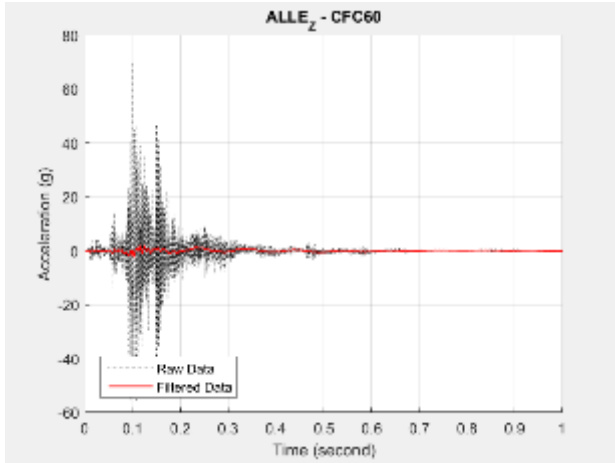

Figure F5. ALLE_Z Accelerometer Data

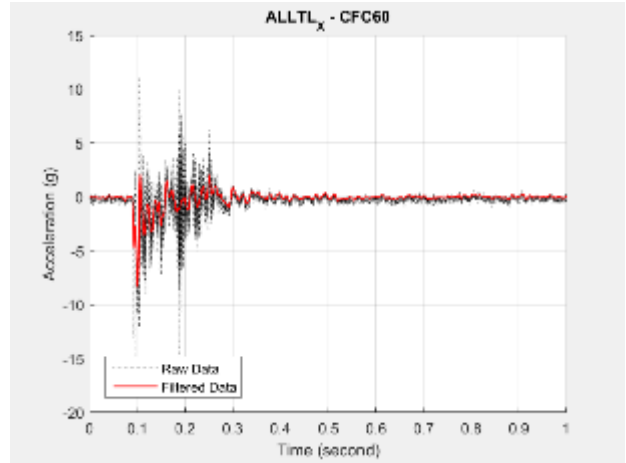

Figure F6. ALLTL_X Accelerometer Data

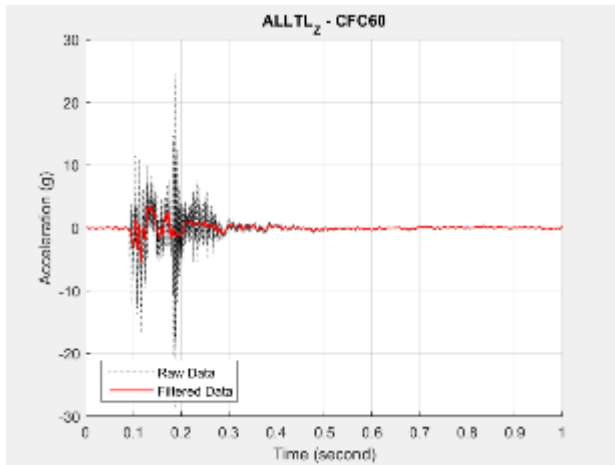

Figure F7. ALLTL_Z Accelerometer Data

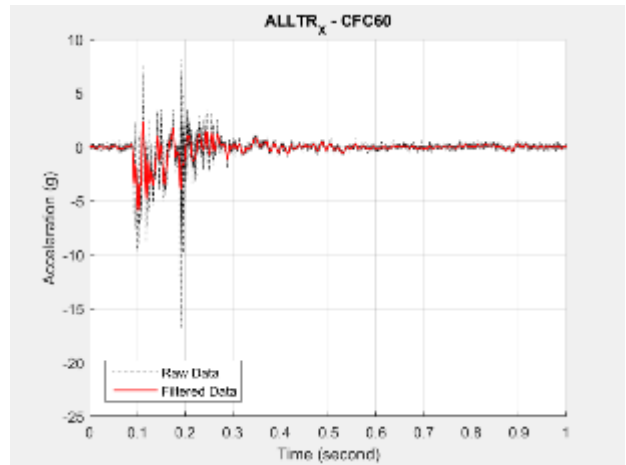

Figure F8. ALLTR_X Accelerometer Data

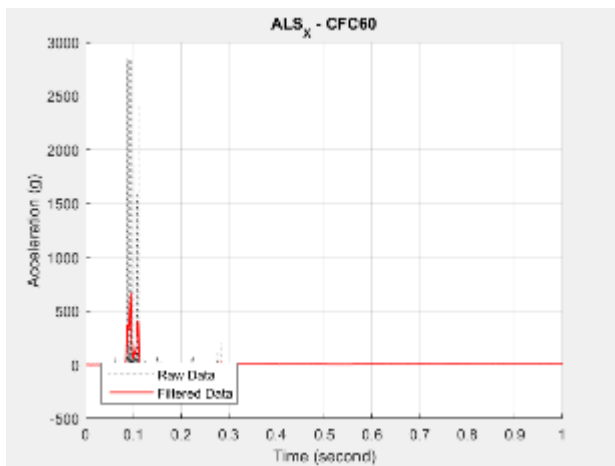

Figure F9. ALS_X Accelerometer Data

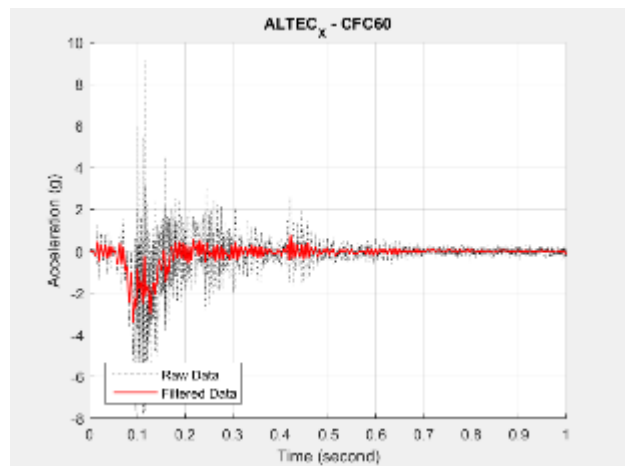

Figure F10. ALTEC_X Accelerometer Data

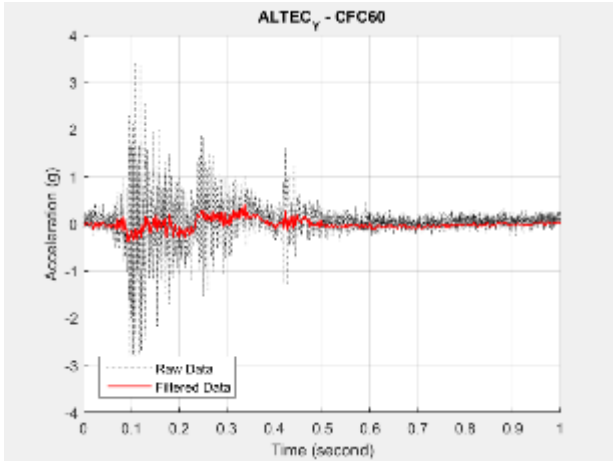

Figure F11. ALTEC_Y Accelerometer Data

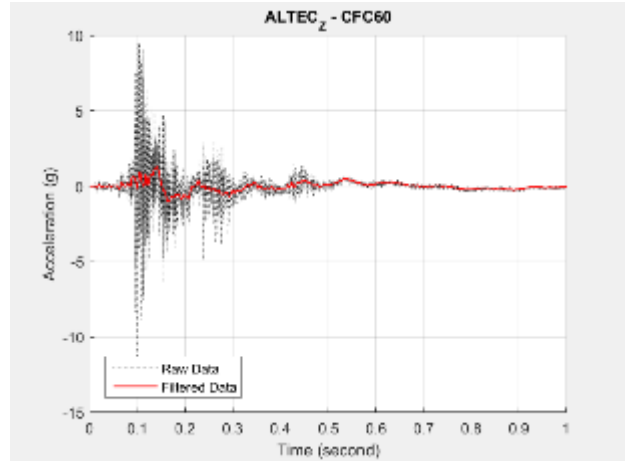

Figure F12. ALTEC_Z Accelerometer Data

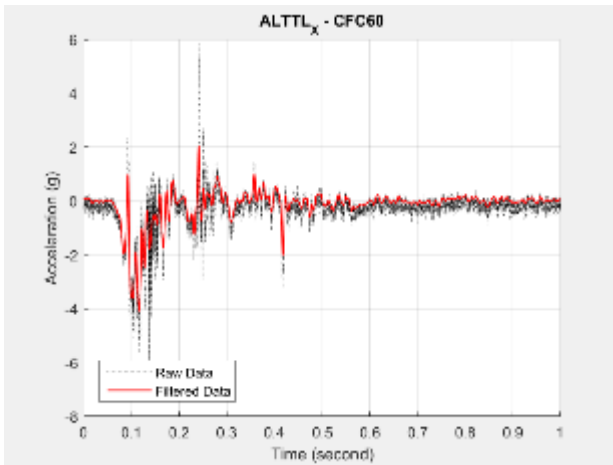

Figure F13. ALTTL_X Accelerometer Data

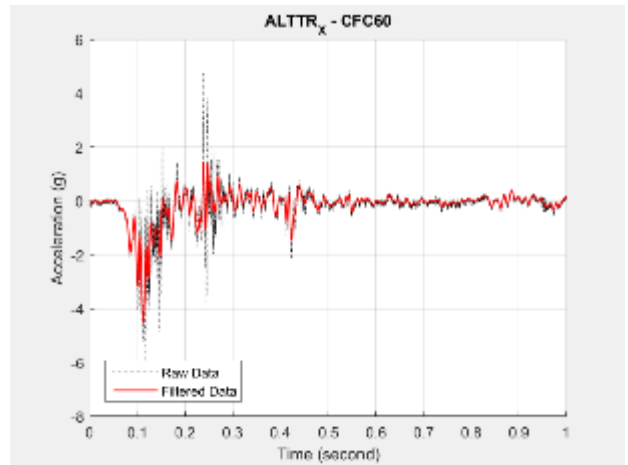

Figure F14. ALTRR_X Accelerometer Data

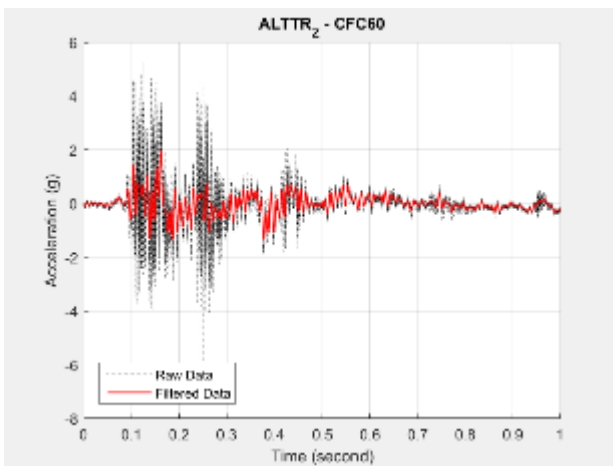

Figure F15. ALTRR_Z Accelerometer Data

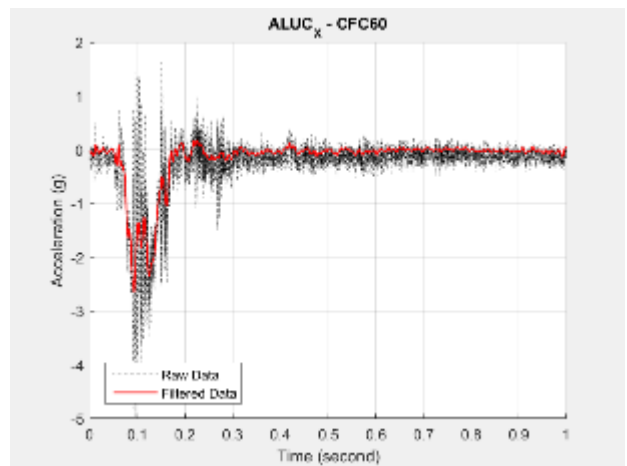

Figure F16. ALUC_X Accelerometer Data

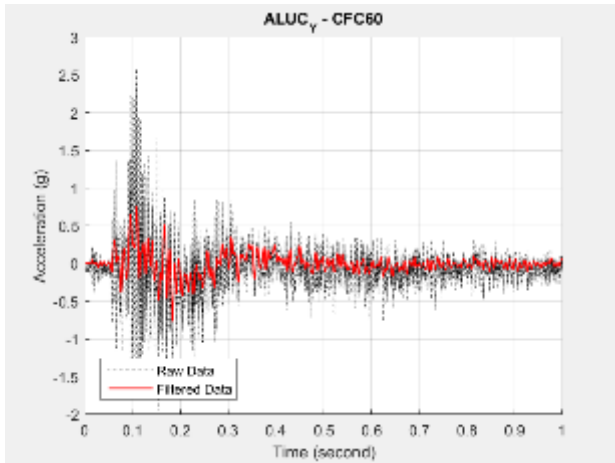

Figure F17. ALUC_Y Accelerometer Data

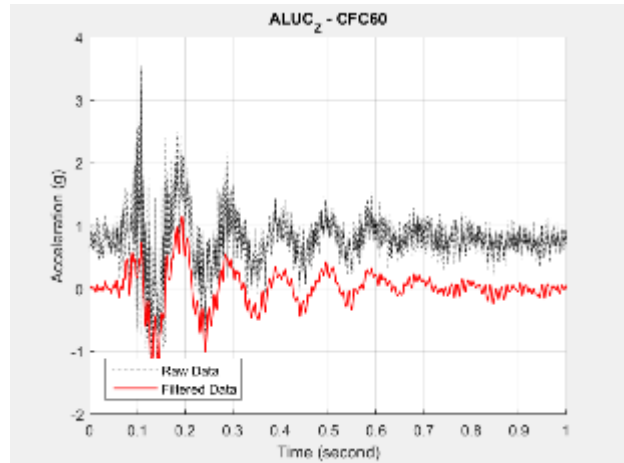

Figure F18. ALUC_Z Accelerometer Data

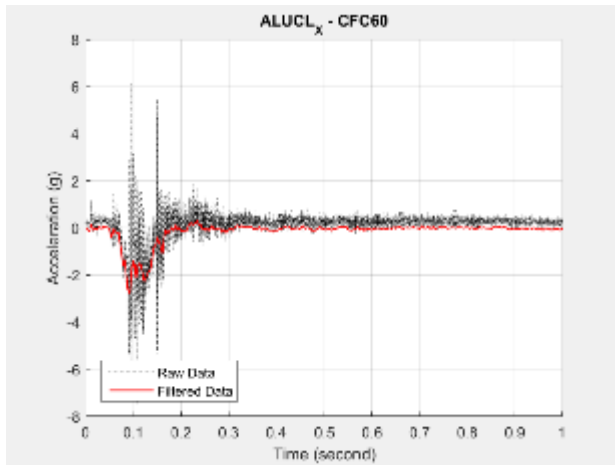

Figure F19. ALUCL_X Accelerometer Data

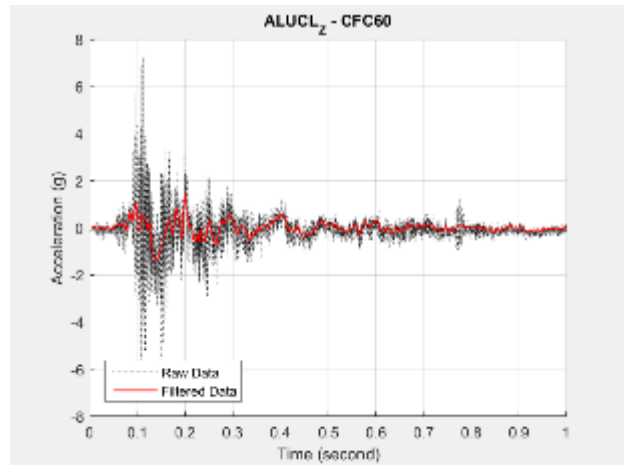

Figure F20. ALUCL_Z Accelerometer Data

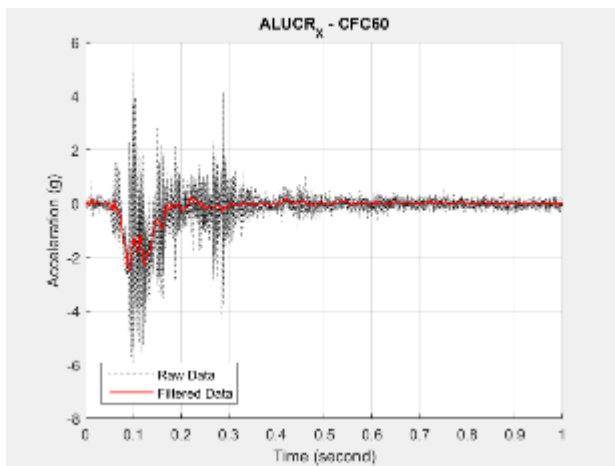

Figure F21. ALUCR_X Accelerometer Data

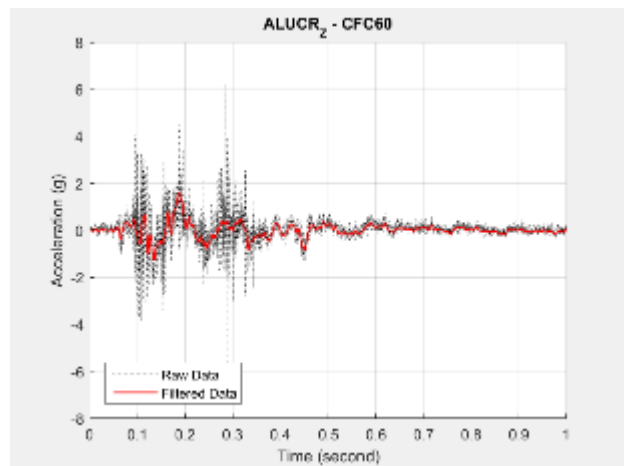

Figure F22. ALUCR_Z Accelerometer Data

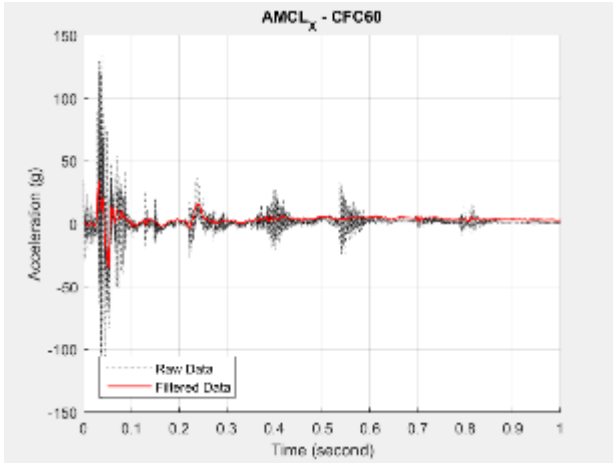

Figure F23. AMCL_X Accelerometer Data

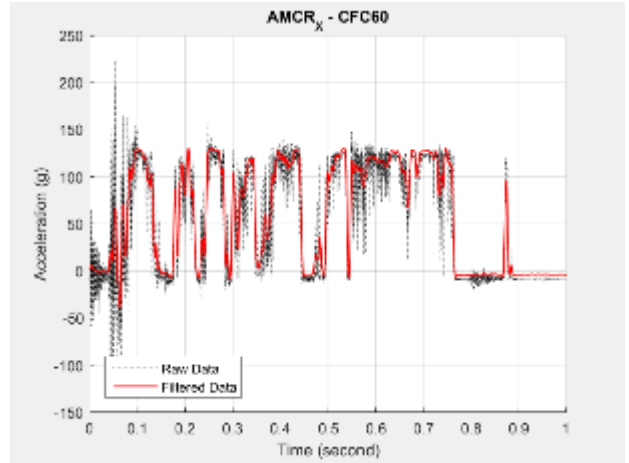

Figure F24. AMCR_X Accelerometer Data

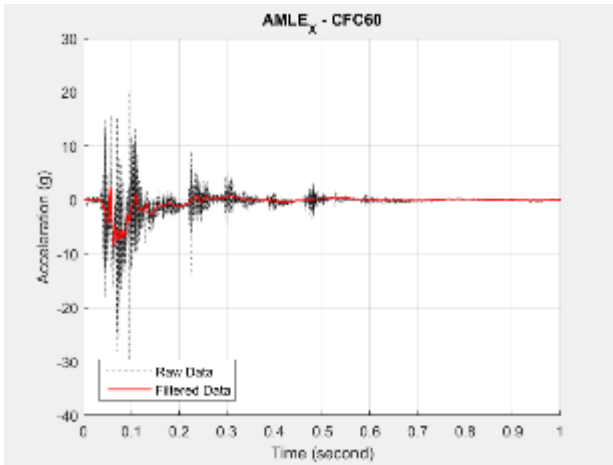

Figure F25. AMLE_X Accelerometer Data

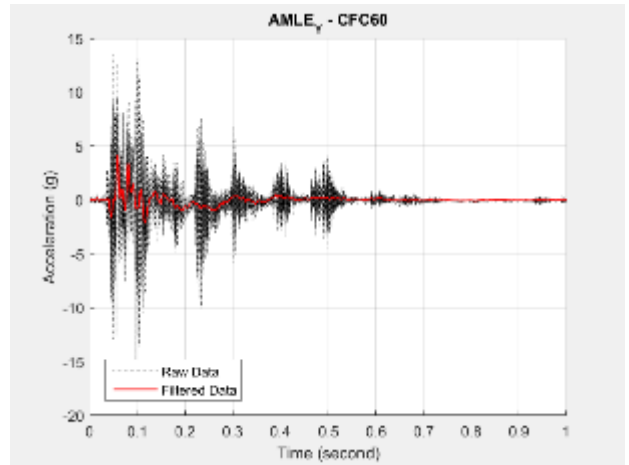

Figure F26. AMLE_Y Accelerometer Data

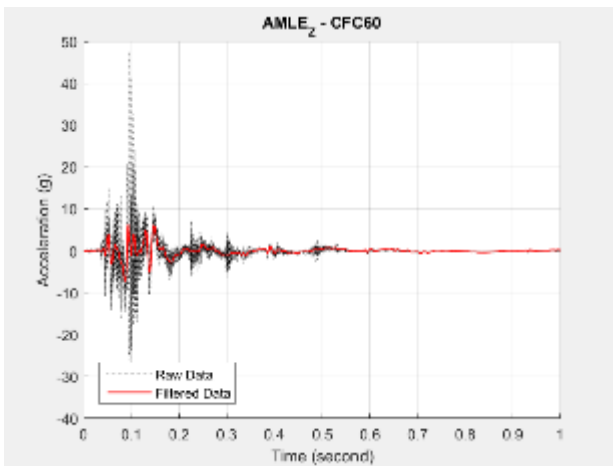

Figure F27. AMLE_Z Accelerometer Data

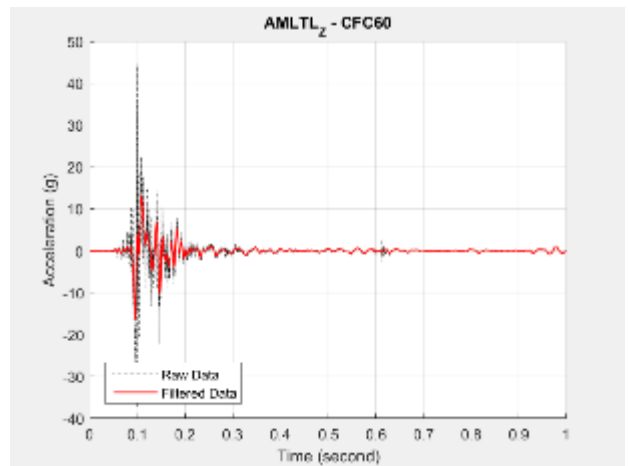

Figure F28. AMLTL_Z Accelerometer Data

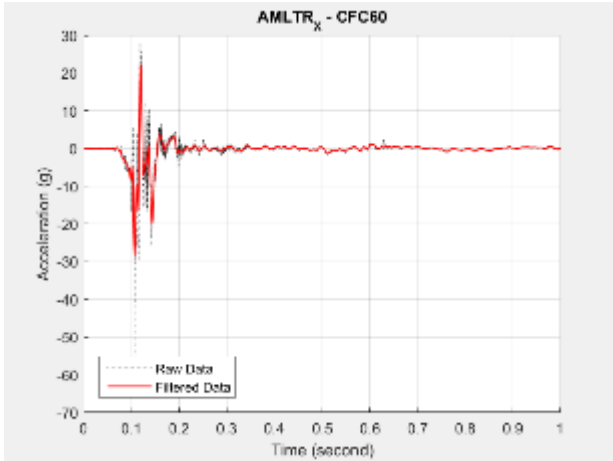

Figure F29. AMLTR_X Accelerometer Data

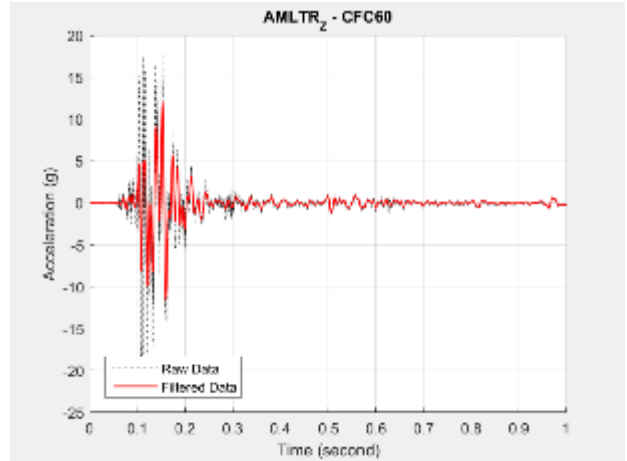

Figure F30. AMLTR_Z Accelerometer Data

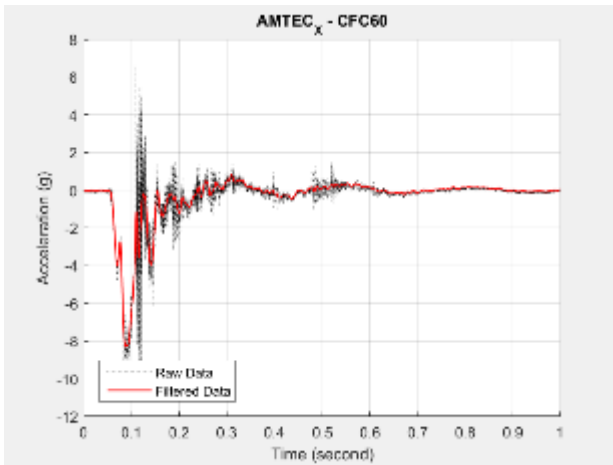

Figure F31. AMTEC_X Accelerometer Data

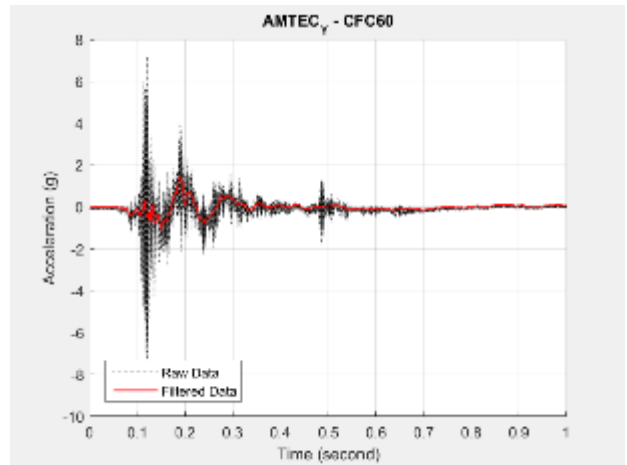

Figure F32. AMTEC_Y Accelerometer Data

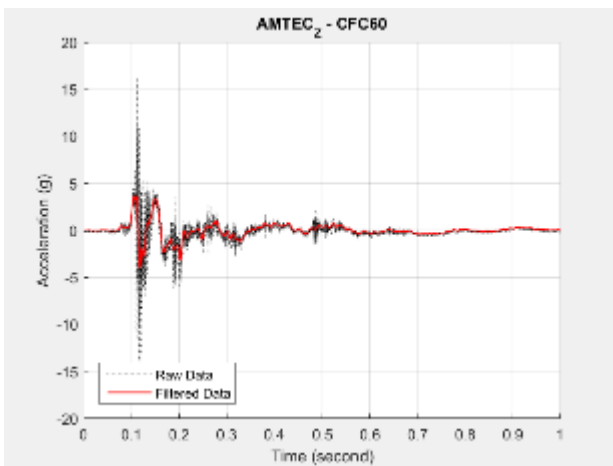

Figure F33. AMTEC_Z Accelerometer Data

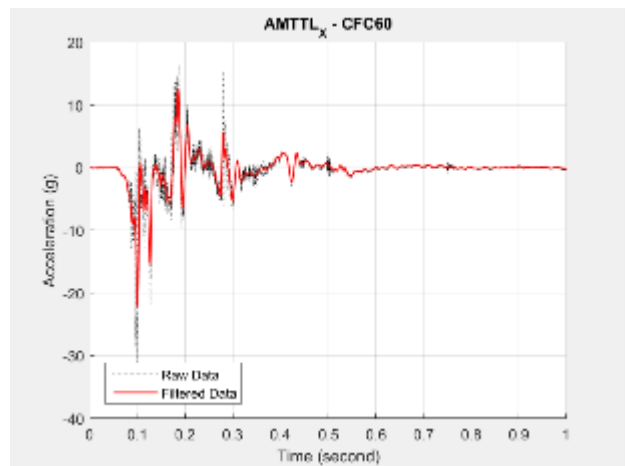

Figure F34. AMTTL_X Accelerometer Data

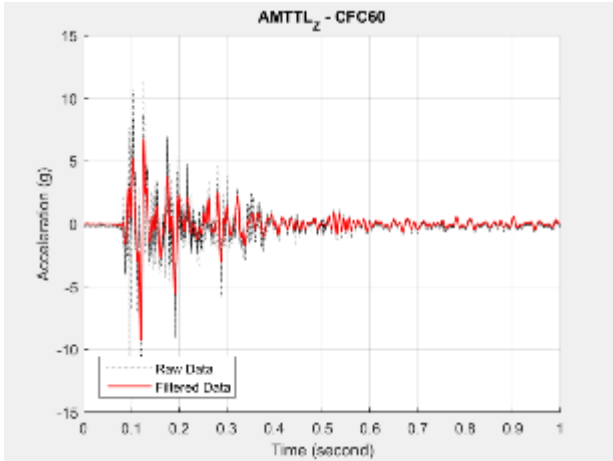

Figure F35. AMTTL_Z Accelerometer Data

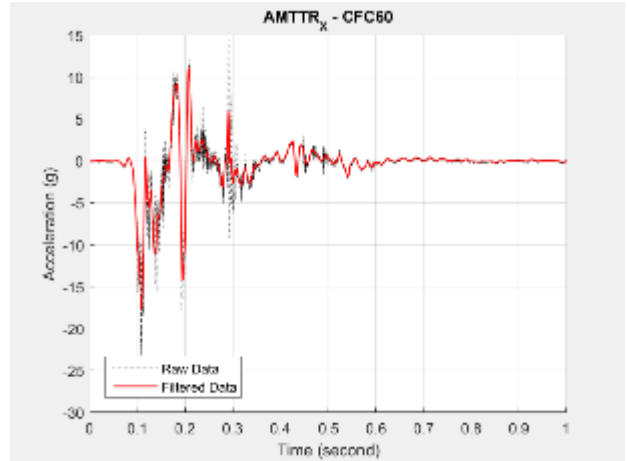

Figure F36. AMTTR_X Accelerometer Data

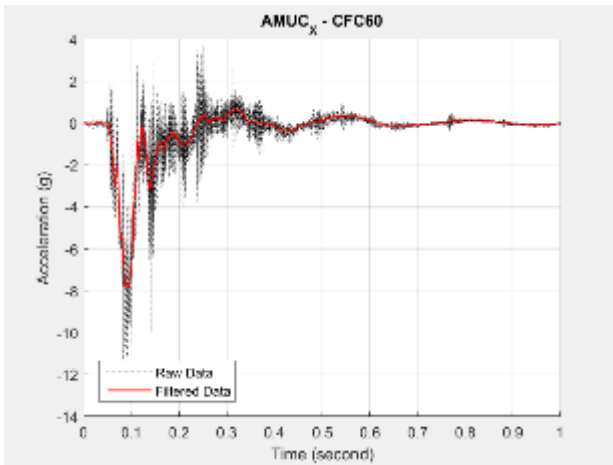

Figure F37. AMUC_X Accelerometer Data

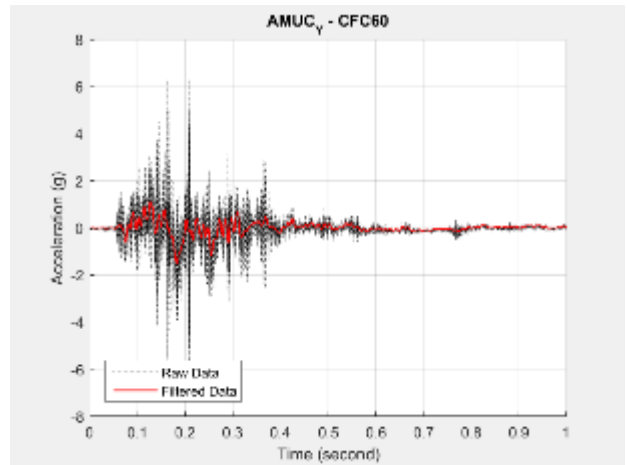

Figure F38. AMUC_Y Accelerometer Data

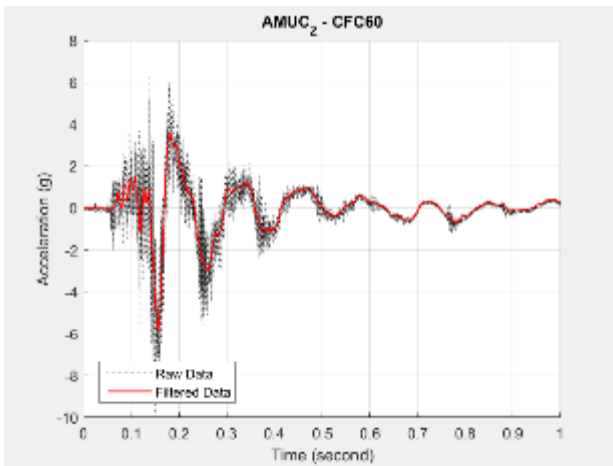

Figure F39. AMUC_Z Accelerometer Data

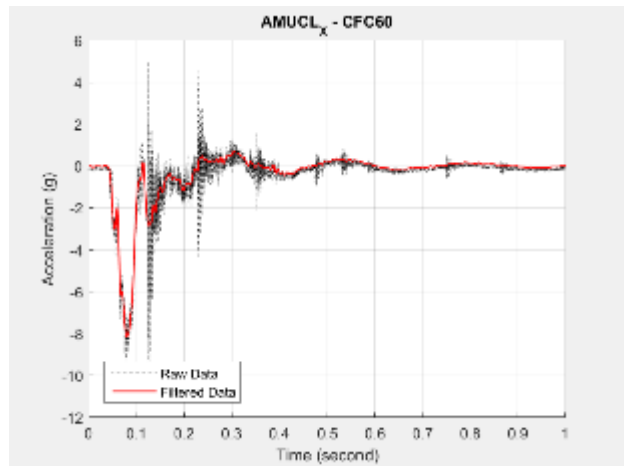

Figure F40. AMUCL_X Accelerometer Data

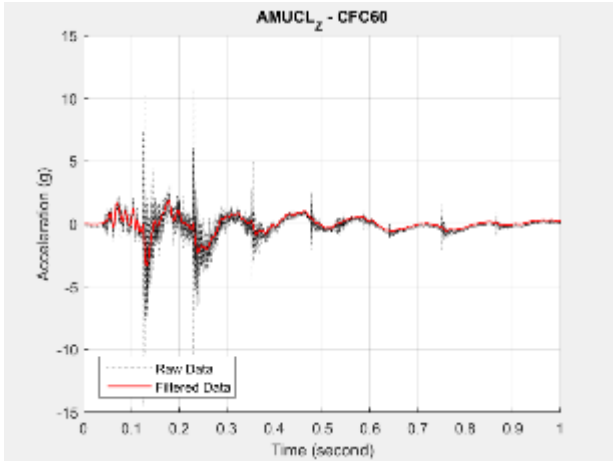

Figure F41. AMUCL_Z Accelerometer Data

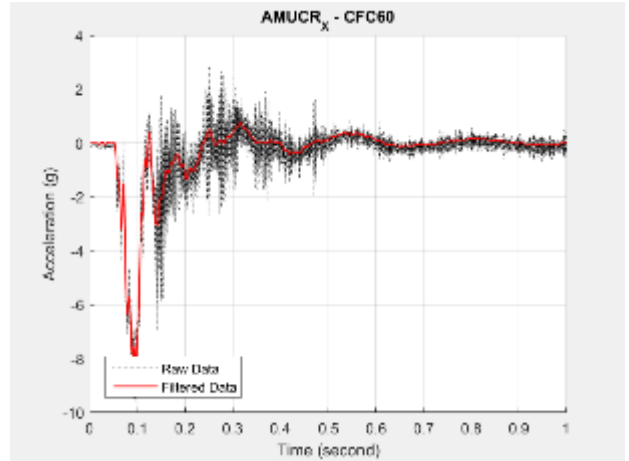

Figure F42. AMUCR_X Accelerometer Data

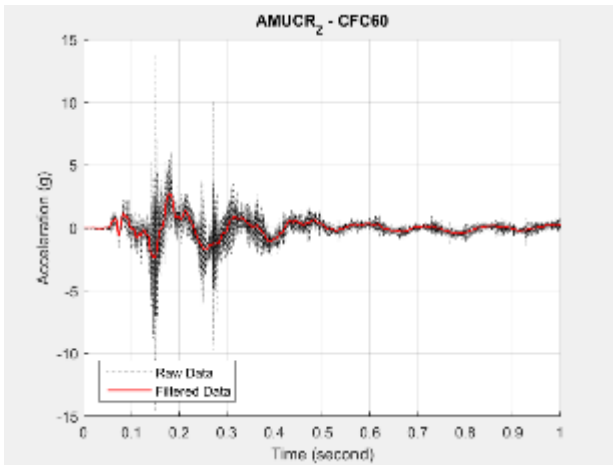

Figure F43. AMUCR_Z Accelerometer Data

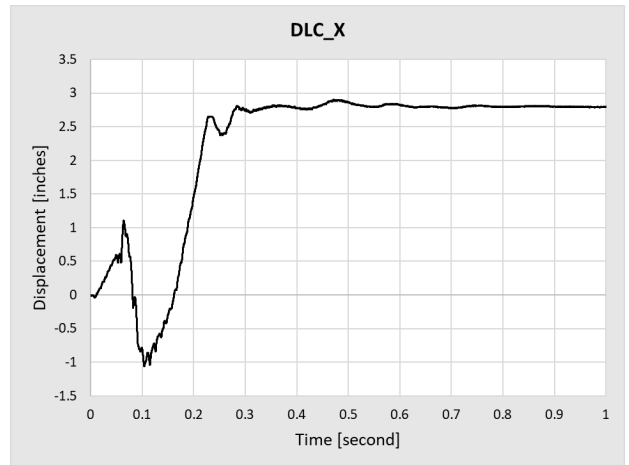

Figure F44. DLC_X Displacement Data

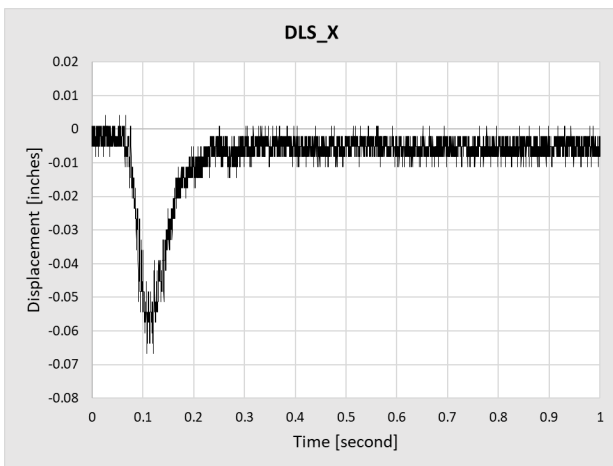

Figure F45. DLS_X Displacement Data

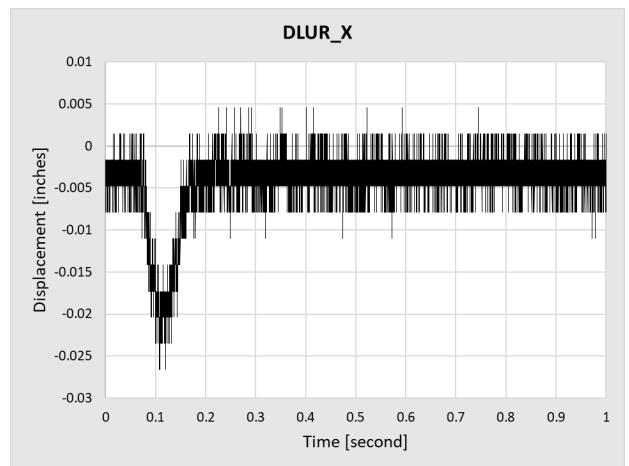

Figure F46. DLUR_X Displacement Data

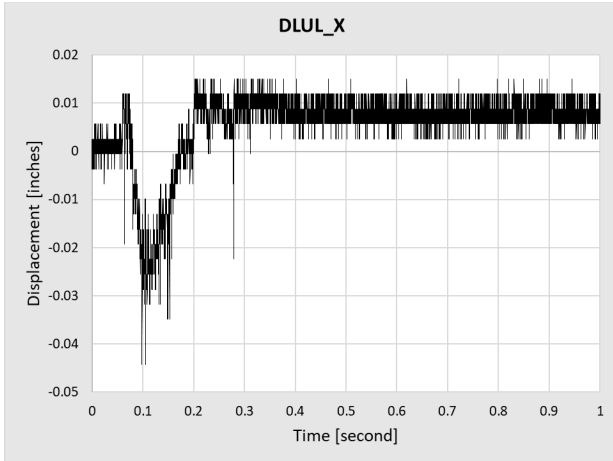

Figure F47. DLUL_X Displacement Data

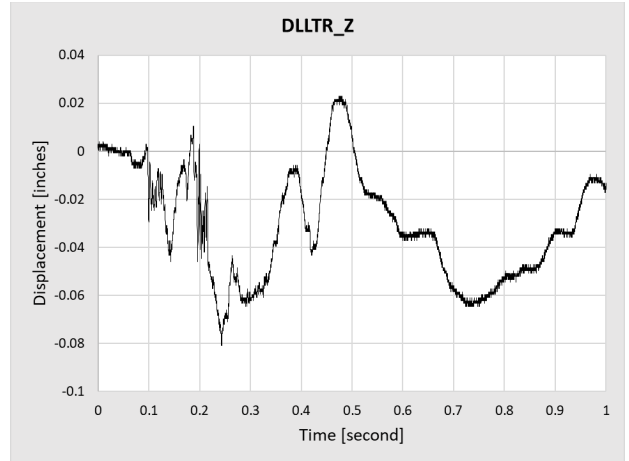

Figure F48. DLLTR_Z Displacement Data

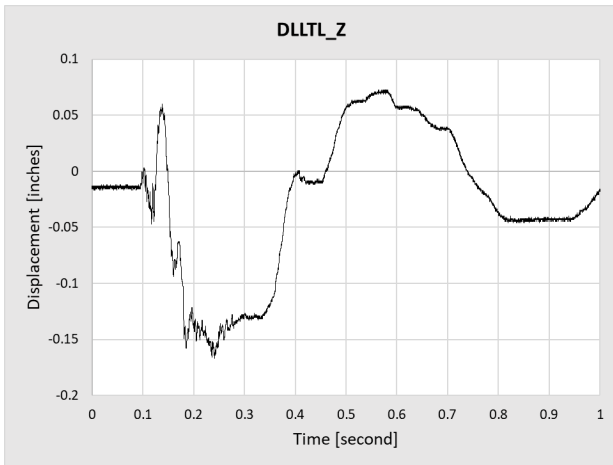

Figure F49. DLLTL_Z Displacement Data

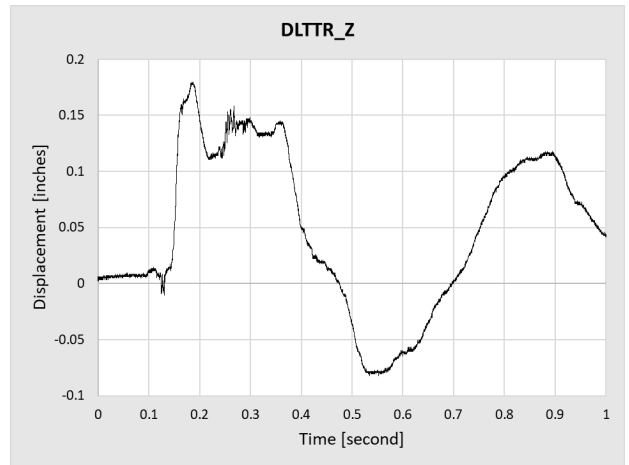

Figure F50. DLTTR_Z Displacement Data

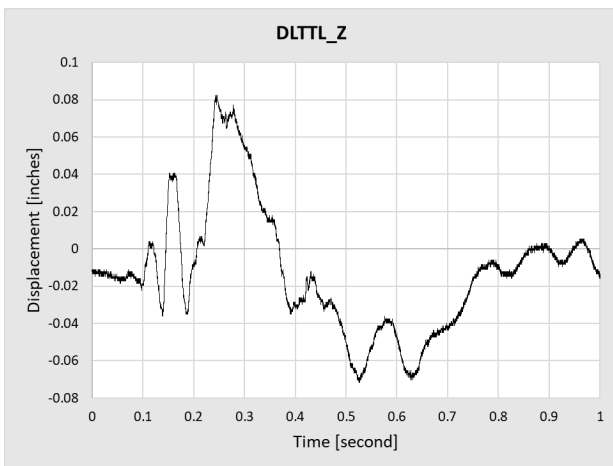

Figure F51. DLTTL_Z Displacement Data

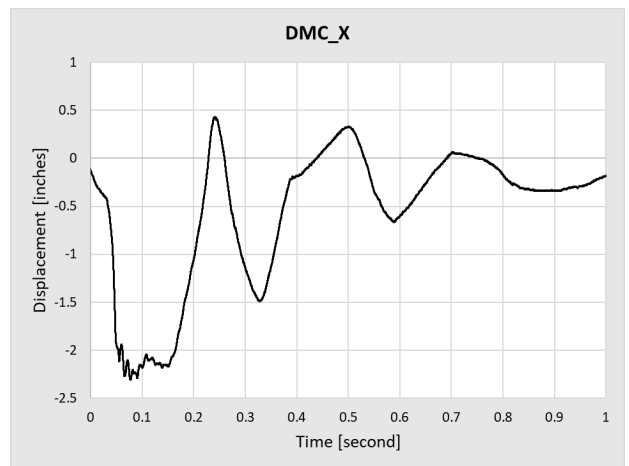

Figure F52. DMC_X Displacement Data

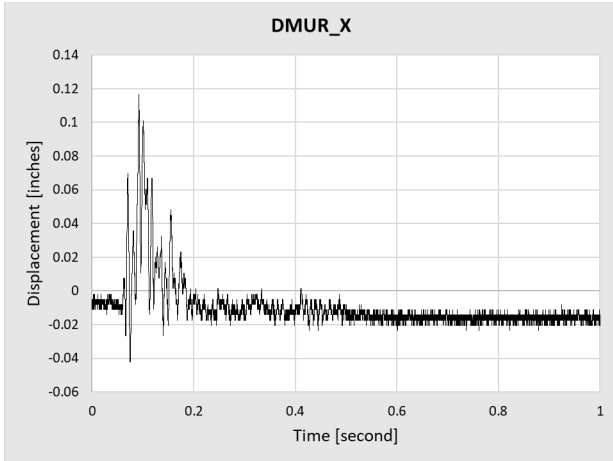

Figure F53. DMUR_X Displacement Data

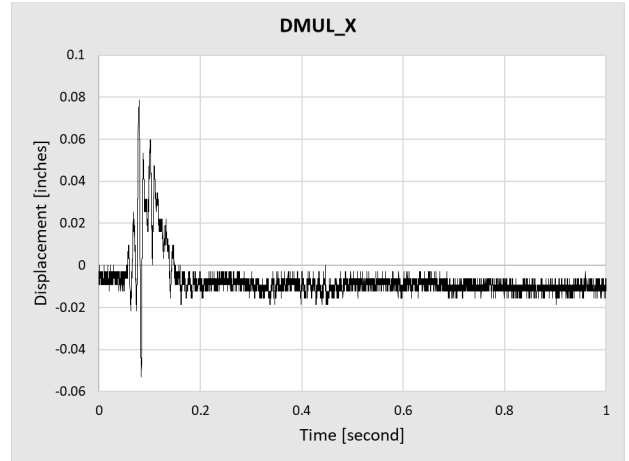

Figure F54. DMUL_X Displacement Data

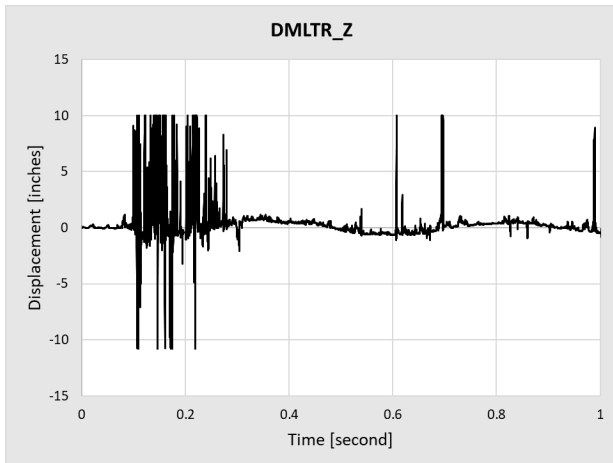

Figure F55. DMLTR_Z Displacement Data

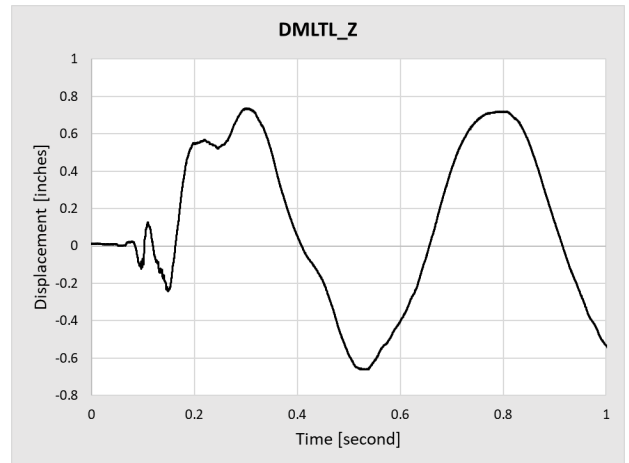

Figure F56. DMLTL_Z Displacement Data

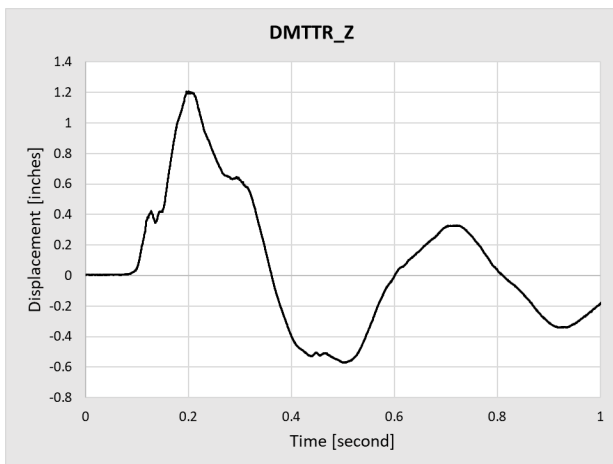

Figure F57. DMTTR_Z Displacement Data

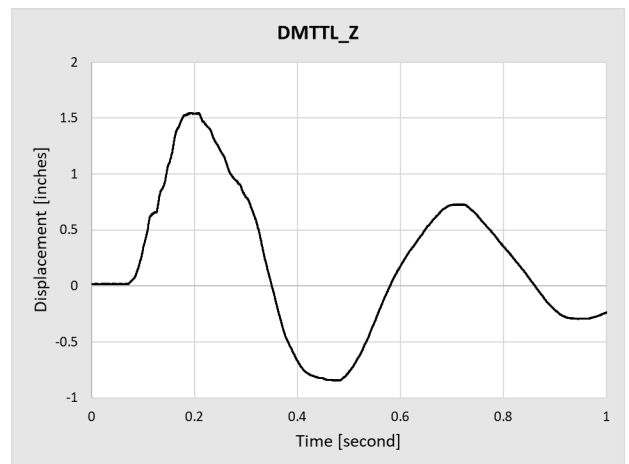

Figure F58. DMTTL_Z Displacement Data

Appendix G. 9 mph Test Data

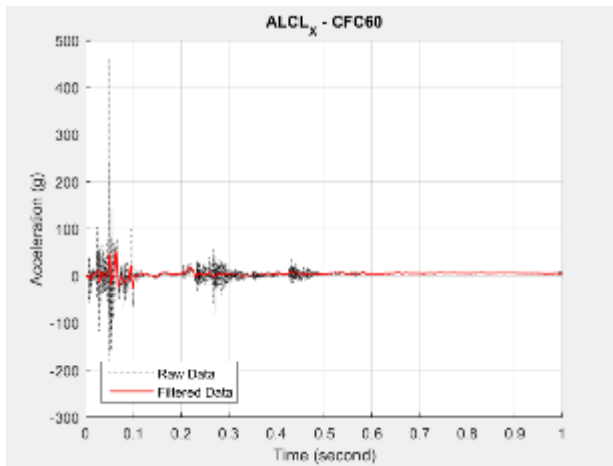

Figure G1. ALCL_X Accelerometer Data

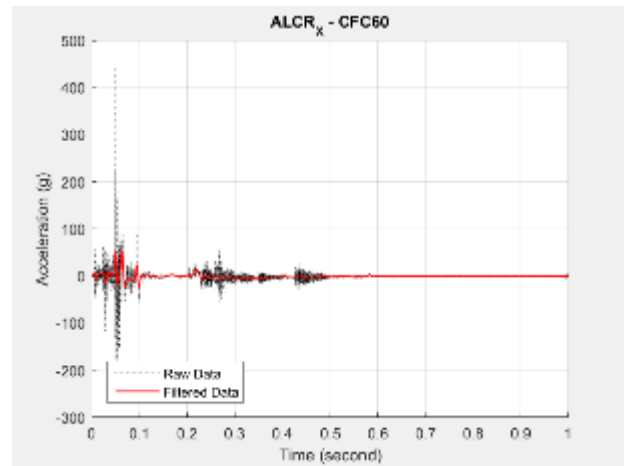

Figure G2. ALCR_X Accelerometer Data

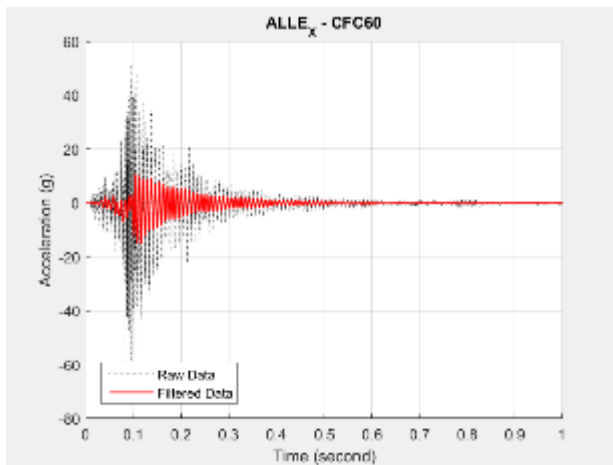

Figure G3. ALLE_X Accelerometer Data

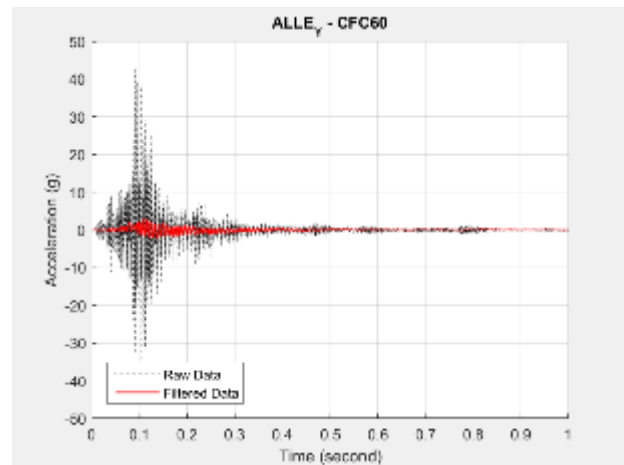

Figure G4. ALLE_Y Accelerometer Data

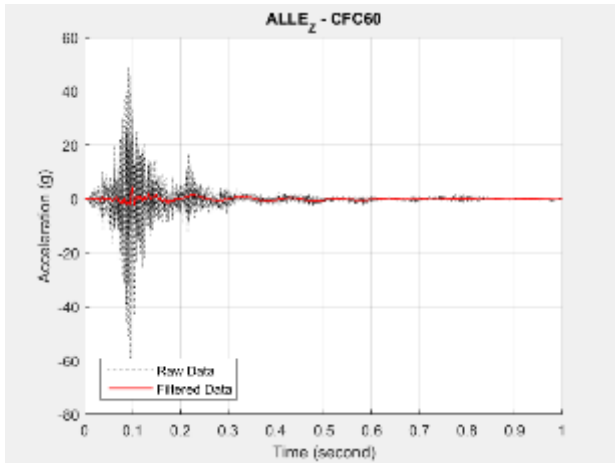

Figure G5. ALLE_Z Accelerometer Data

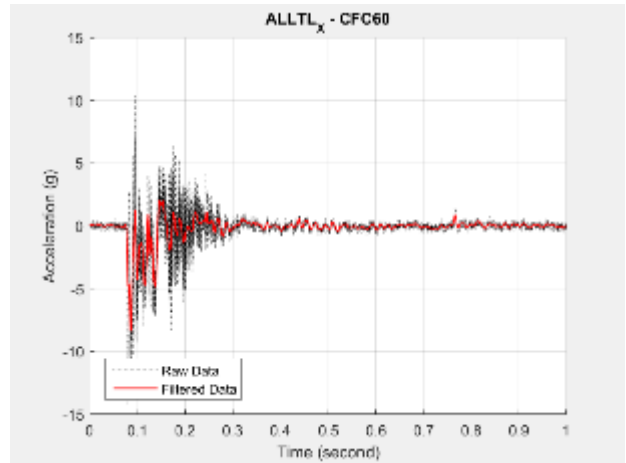

Figure G6. ALLTL_X Accelerometer Data

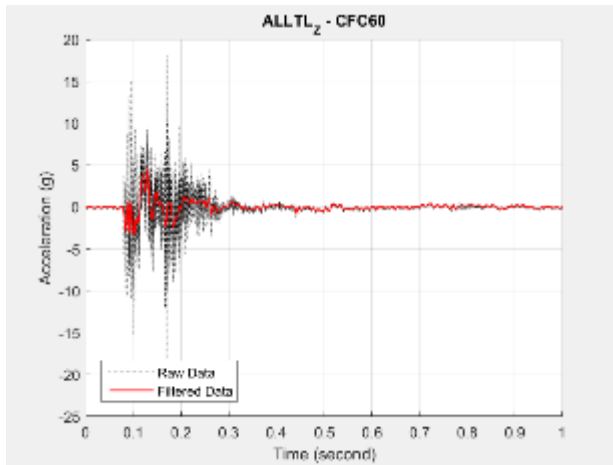

Figure G7. ALLTL_Z Accelerometer Data

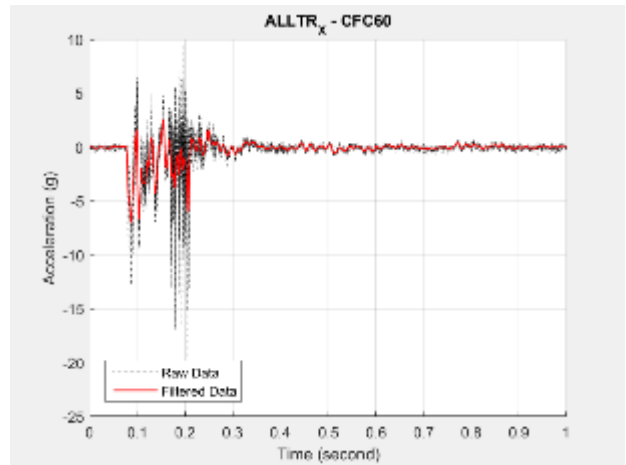

Figure G8. ALLTR_X Accelerometer Data

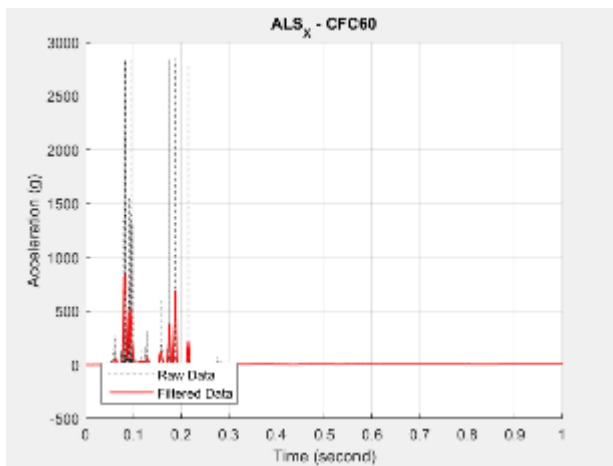

Figure G9. ALS_X Accelerometer Data

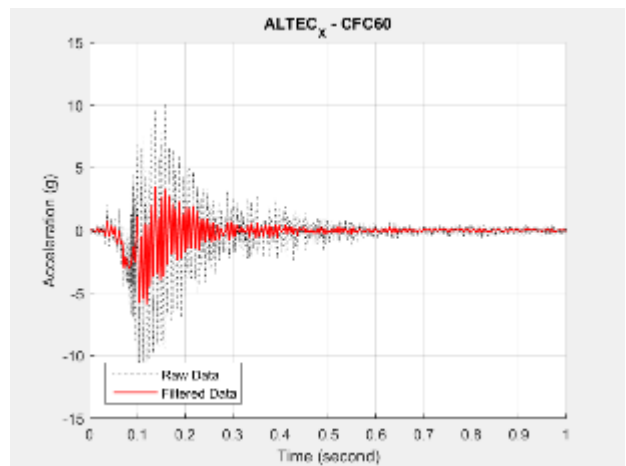

Figure G10. ALTEC_X Accelerometer Data

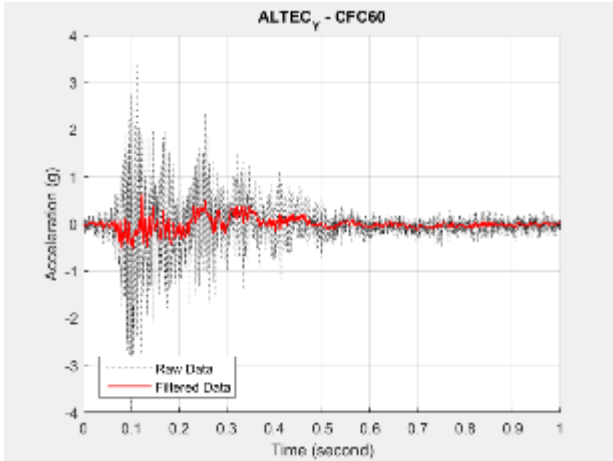

Figure G11. ALTEC_Y Accelerometer Data

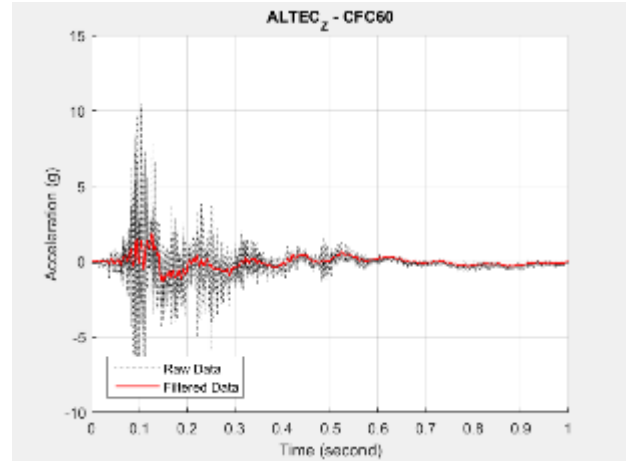

Figure G12. ALTEC_Z Accelerometer Data

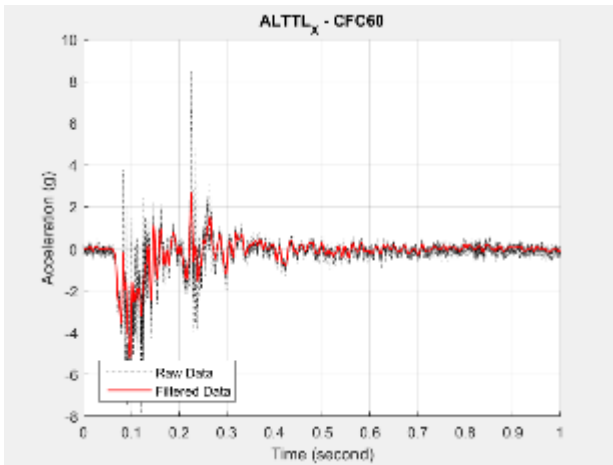

Figure G13. ALTTL_X Accelerometer Data

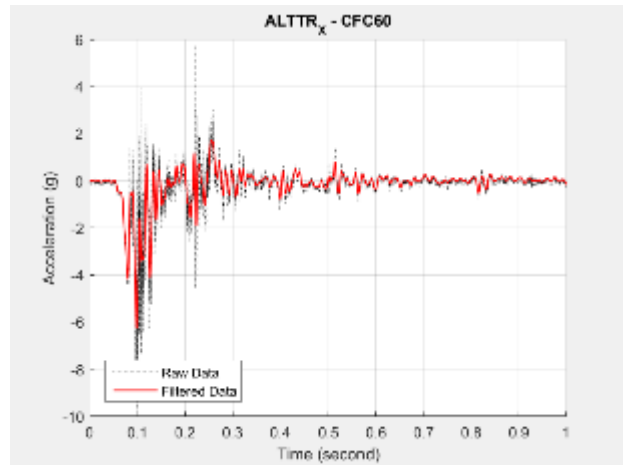

Figure G14. ALTTR_X Accelerometer Data

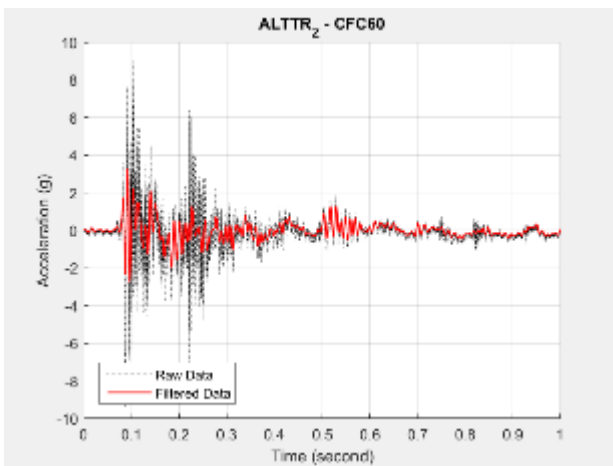

Figure G15. ALTTR_Z Accelerometer Data

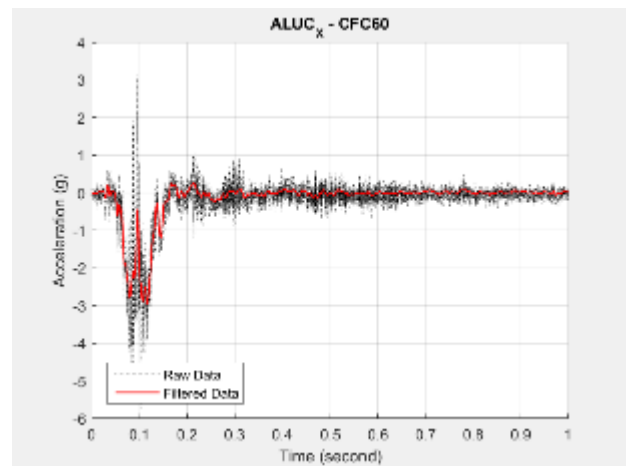

Figure G16. ALUC_X Accelerometer Data

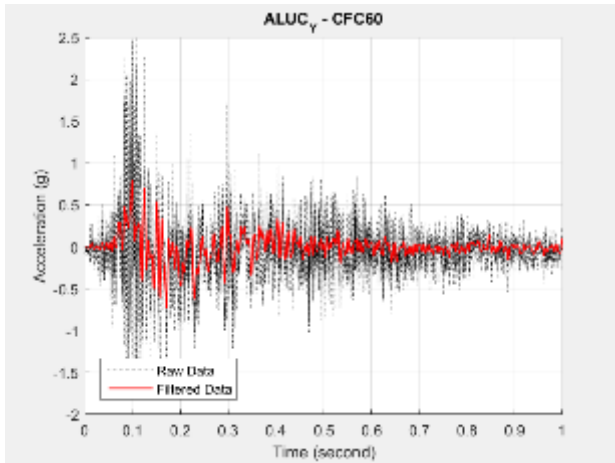

Figure G17. ALUC_Y Accelerometer Data

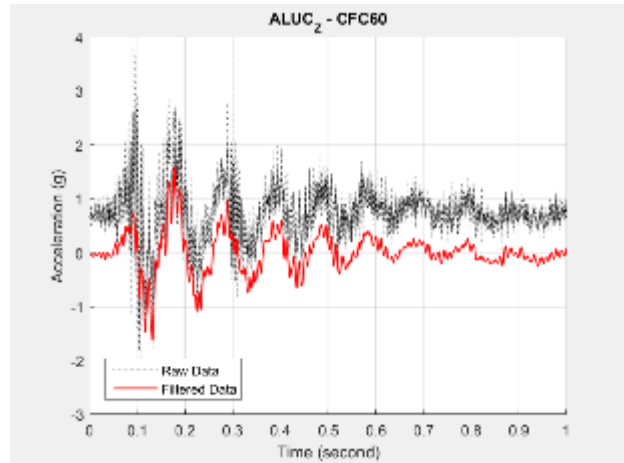

Figure G18. ALUC_Z Accelerometer Data

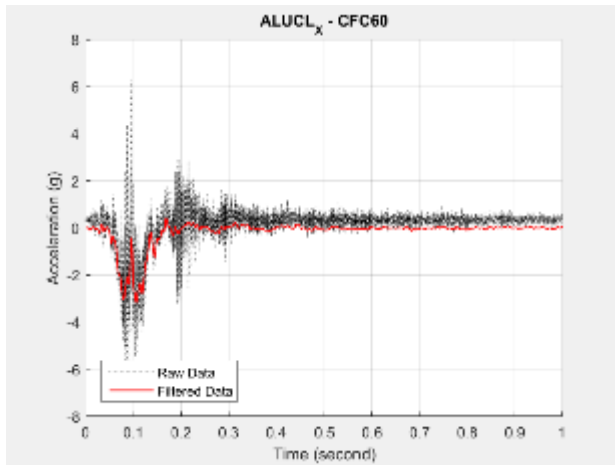

Figure G19. ALUCL_X Accelerometer Data

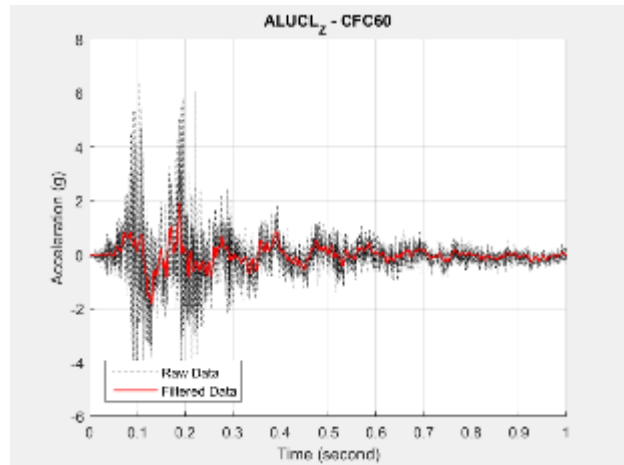

Figure G20. ALUCL_Z Accelerometer Data

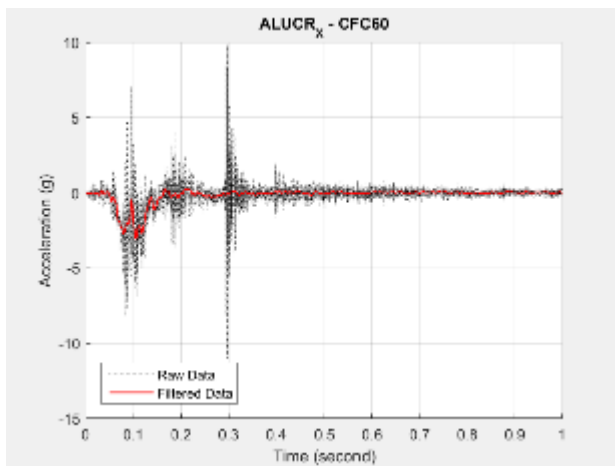

Figure G21. ALUCR_X Accelerometer Data

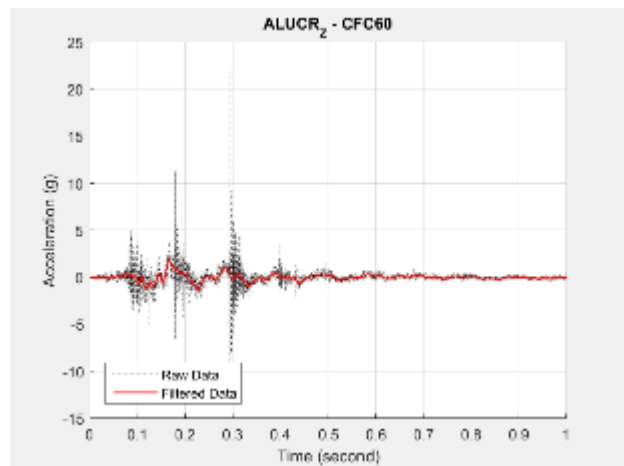

Figure G22. ALUCR_Z Accelerometer Data

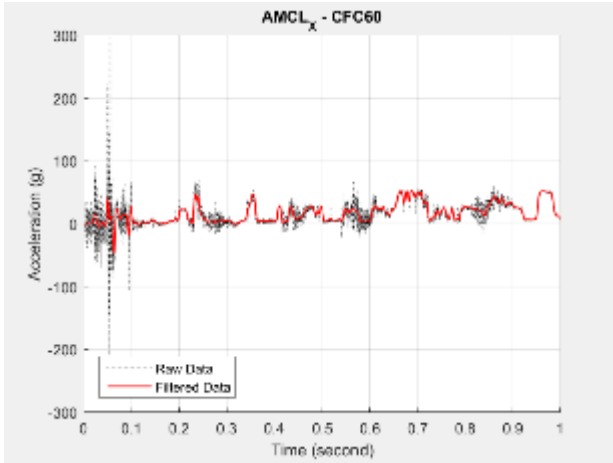

Figure G23. AMCL_X Accelerometer Data

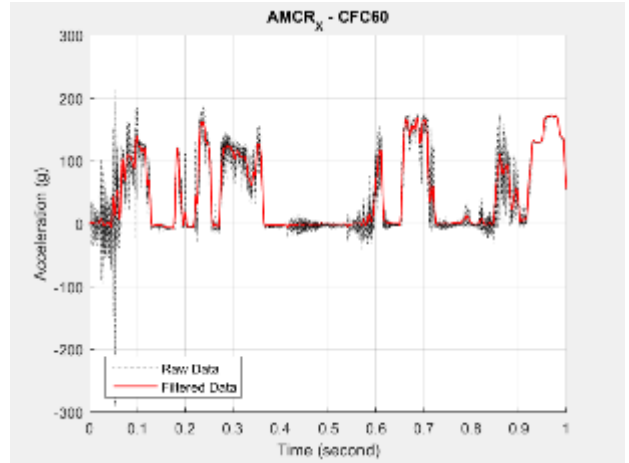

Figure G24. AMCR_X Accelerometer Data

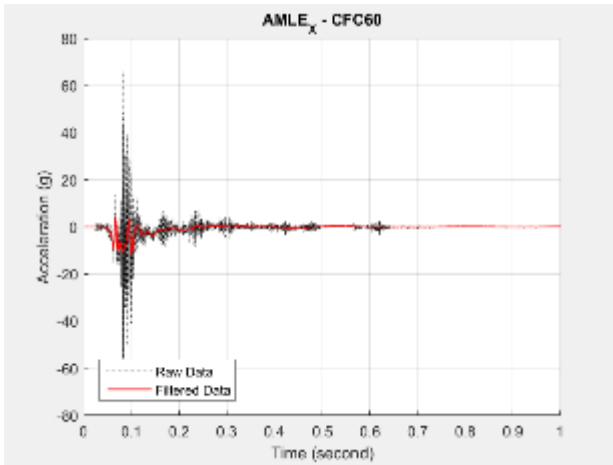

Figure G25. AMLE_X Accelerometer Data

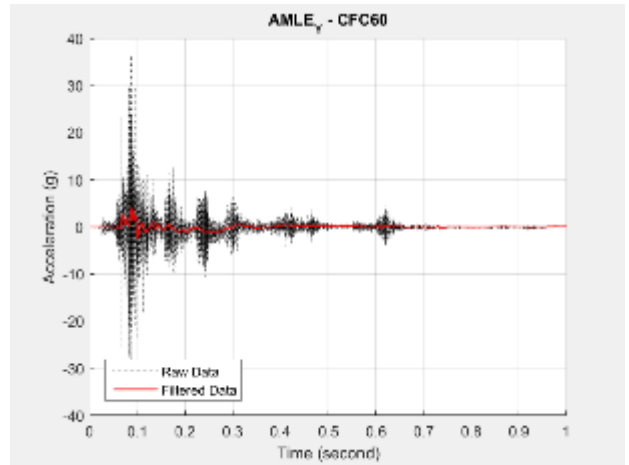

Figure G26. AMLE_Y Accelerometer Data

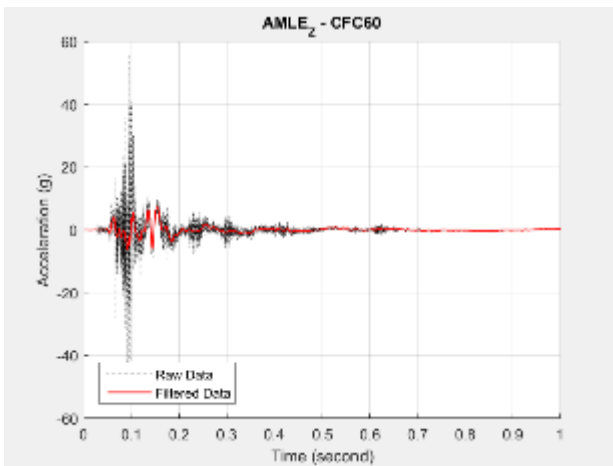

Figure G27. AMLE_Z Accelerometer Data

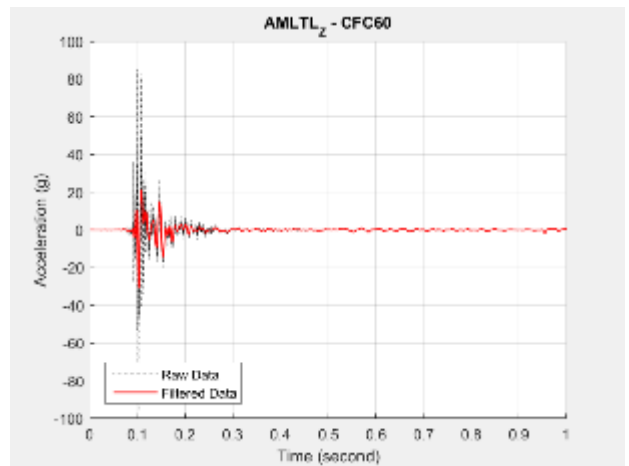

Figure G28. AMLTL_Z Accelerometer Data

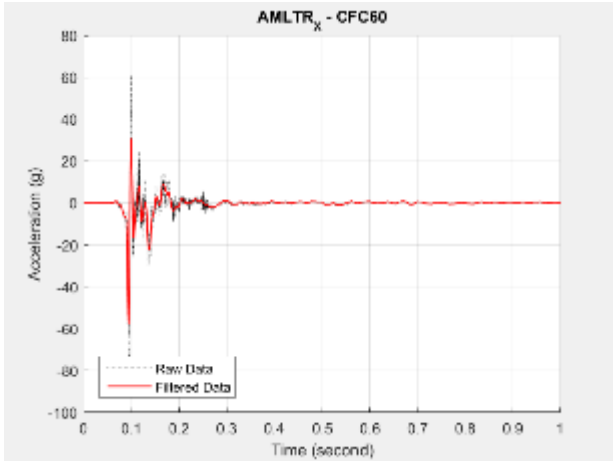

Figure G29. AMLTR_X Accelerometer Data

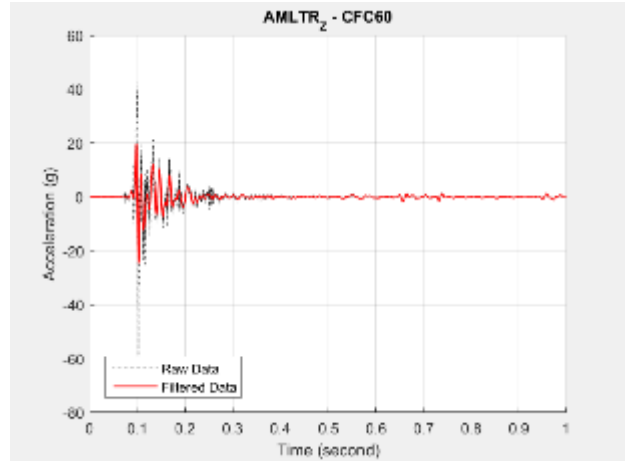

Figure G30. AMLTR_Z Accelerometer Data

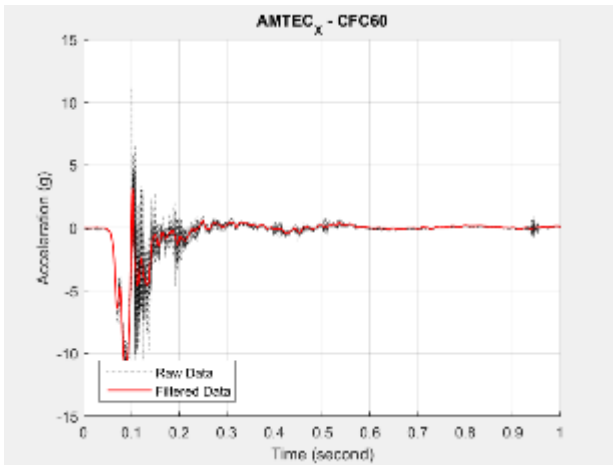

Figure G31. AMTEC_X Accelerometer Data

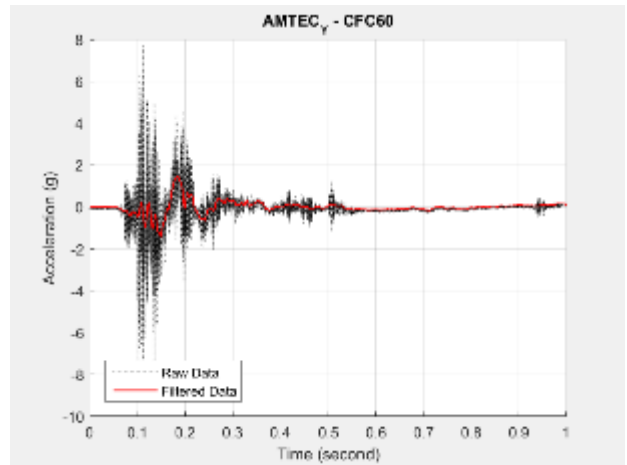

Figure G32. AMTEC_Y Accelerometer Data

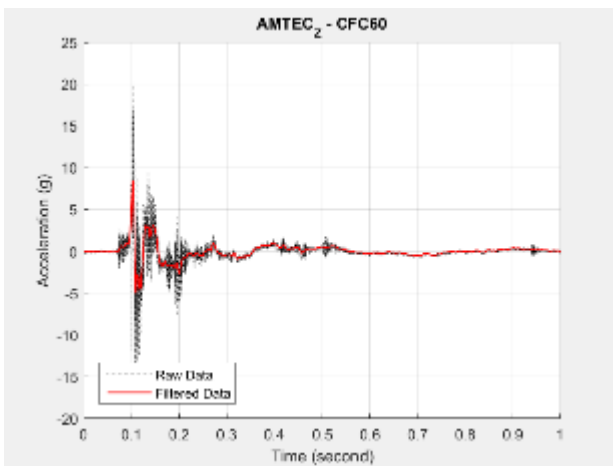

Figure G33. AMTEC_Z Accelerometer Data

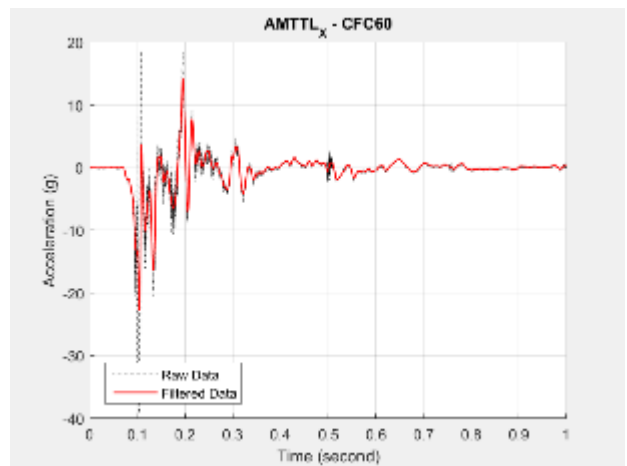

Figure G34. AMTTL_X Accelerometer Data

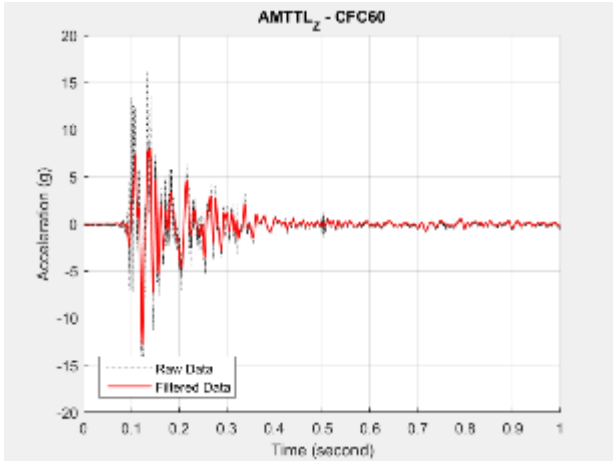

Figure G35. AMTTL_Z Accelerometer Data

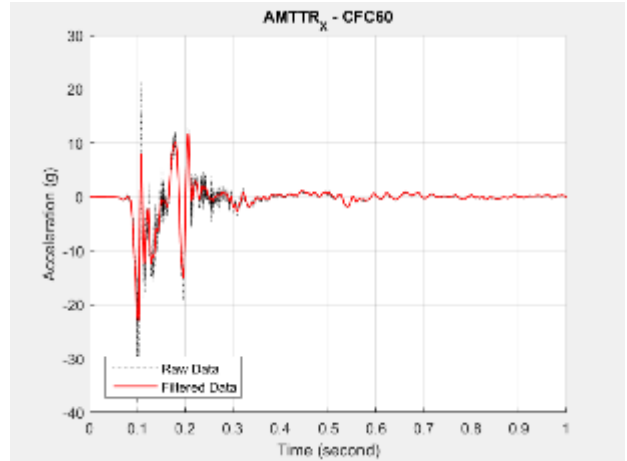

Figure G36. AMTTR_X Accelerometer Data

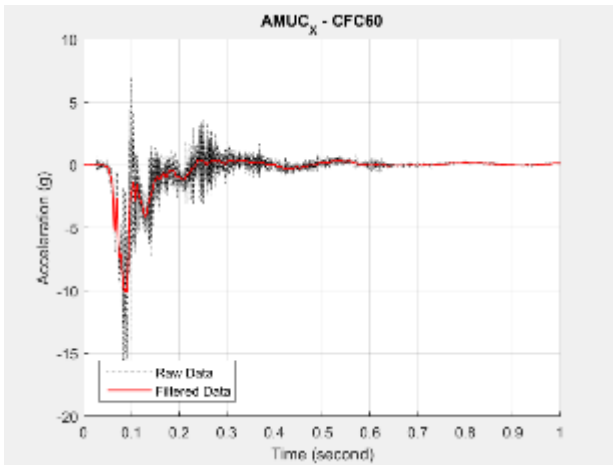

Figure G37. AMUC_X Accelerometer Data

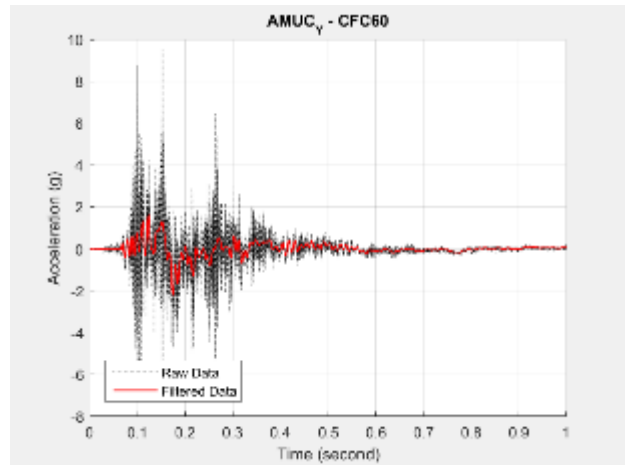

Figure G38. AMUC_Y Accelerometer Data

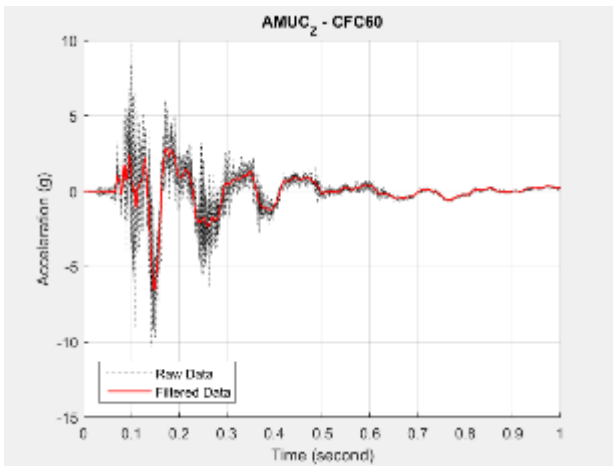

Figure G39. AMUC_Z Accelerometer Data

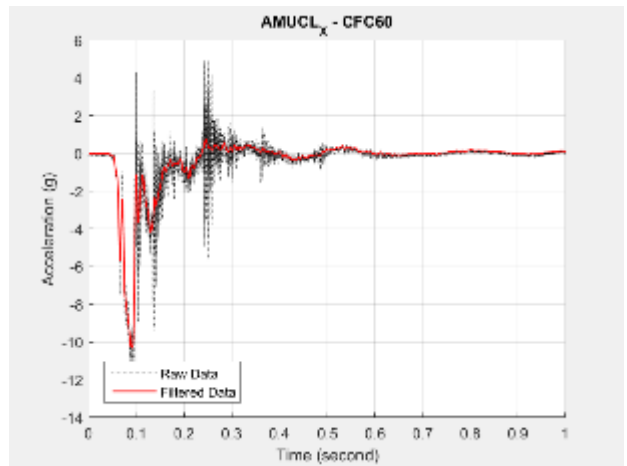

Figure G40. AMUCL_X Accelerometer Data

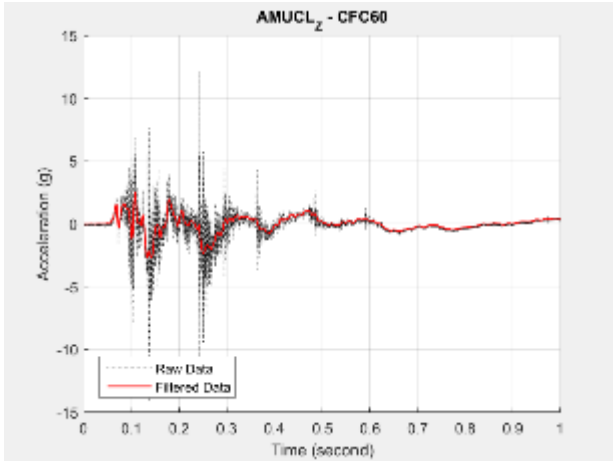

Figure G41. AMUCL_Z Accelerometer Data

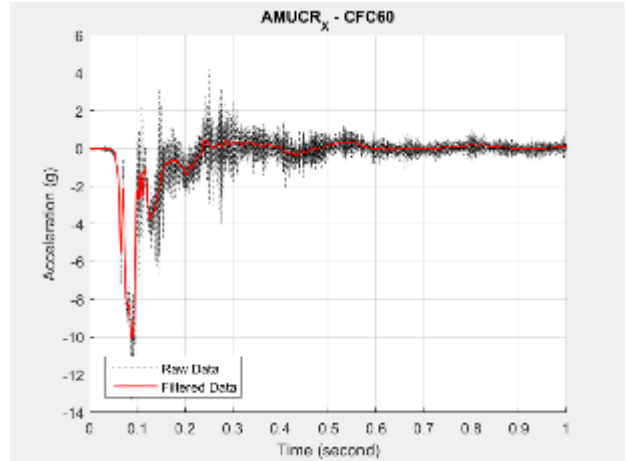

Figure G42. AMUCR_X Accelerometer Data

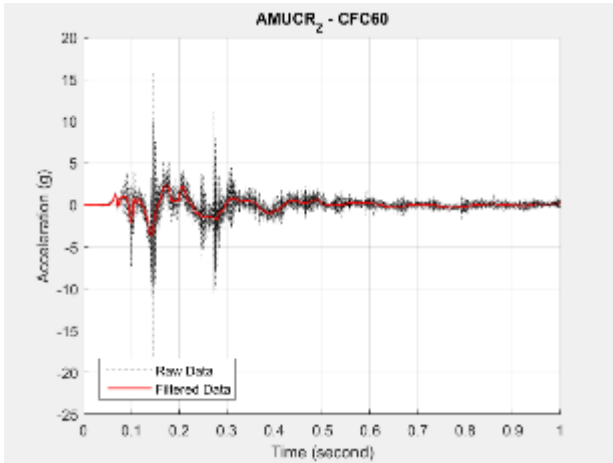

Figure G43. AMUCR_Z Accelerometer Data

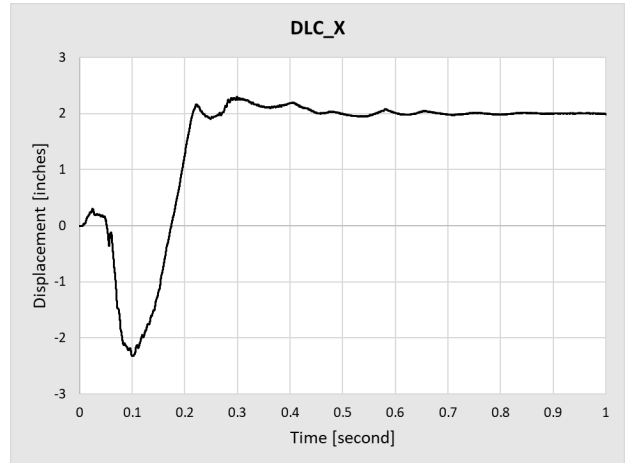

Figure G44. DLC_X Displacement Data

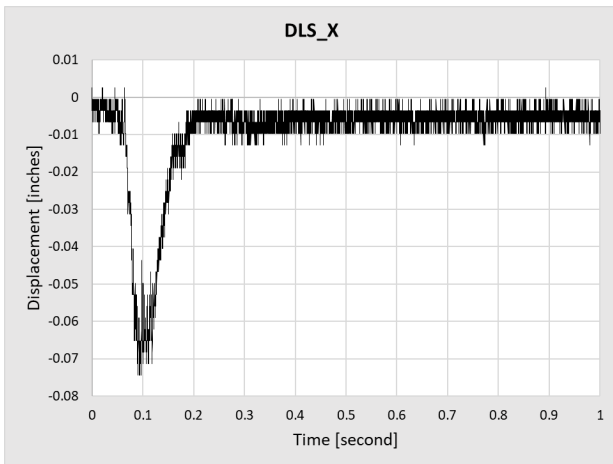

Figure G45. DLS_X Displacement Data

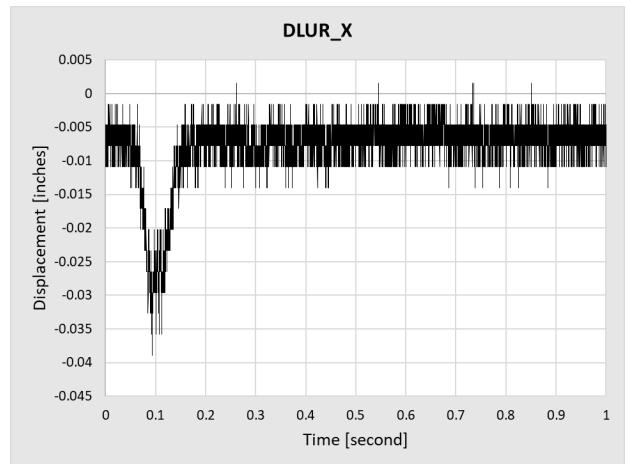

Figure G46. DLUR_X Displacement Data

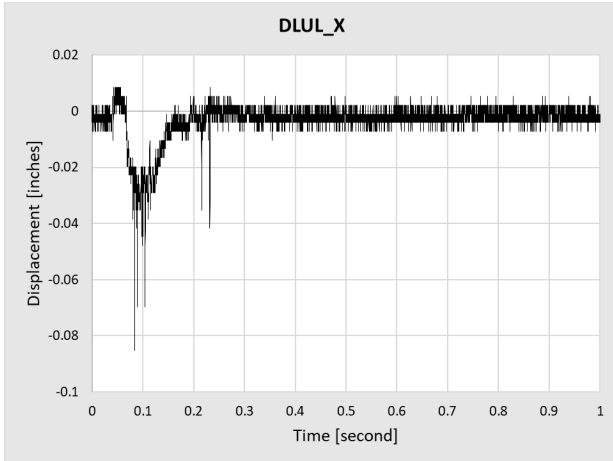

Figure G47. DLUL_X Displacement Data

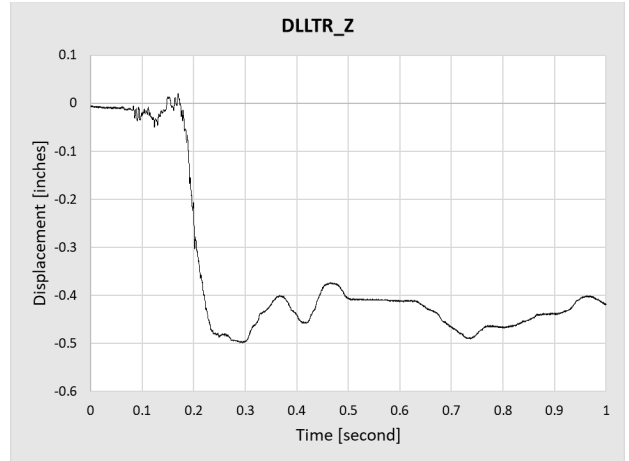

Figure G48. DLLTR_Z Displacement Data

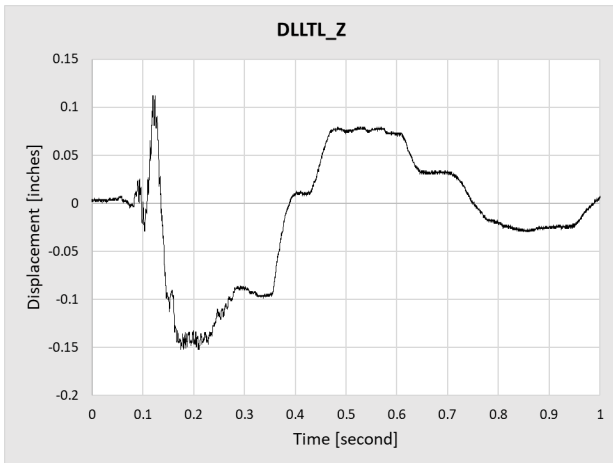

Figure G49. DLLTL_Z Displacement Data

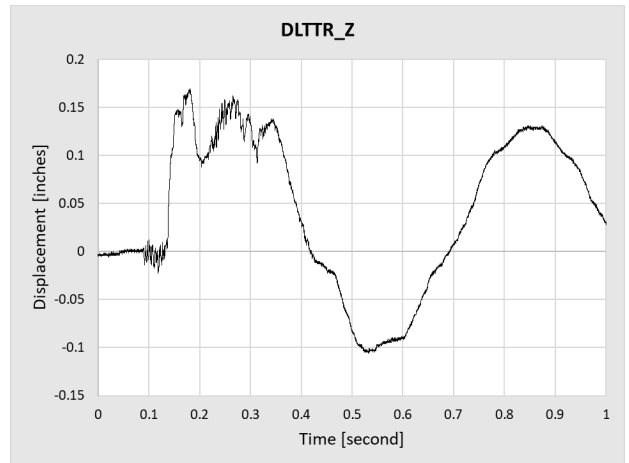

Figure G50. DLTTR_Z Displacement Data

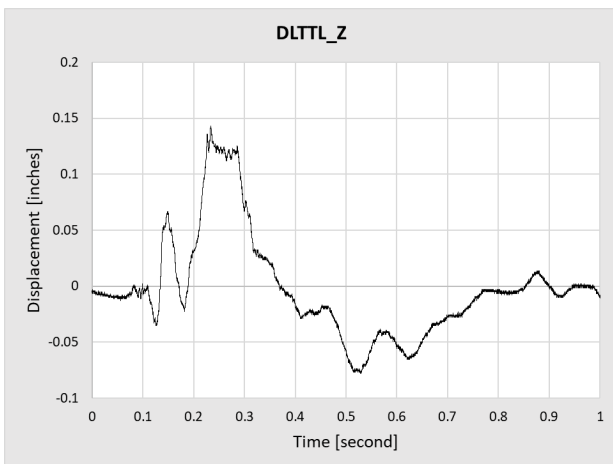

Figure G51. DLTTL_Z Displacement Data

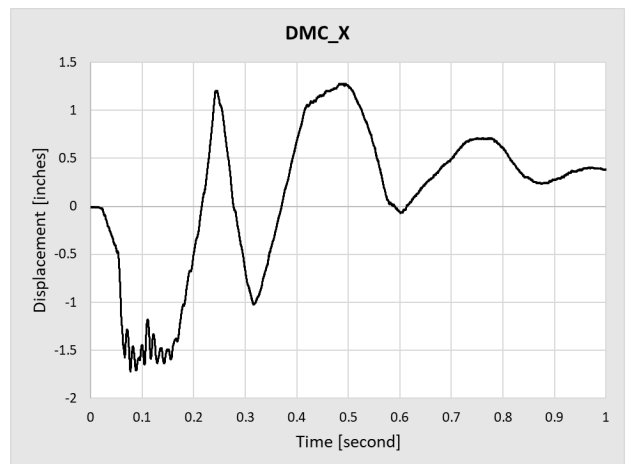

Figure G52. DMC_X Displacement Data

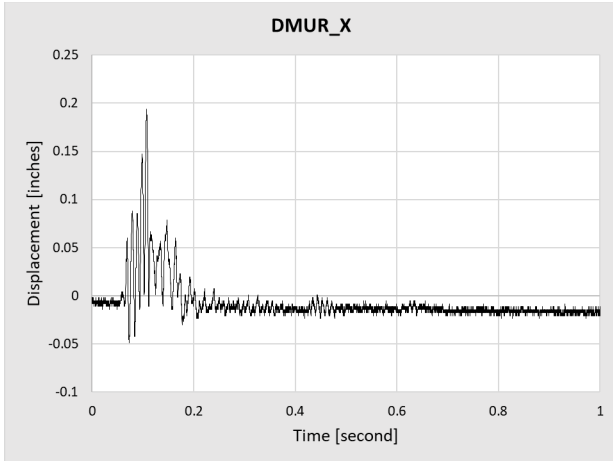

Figure G53. DMUR_X Displacement Data

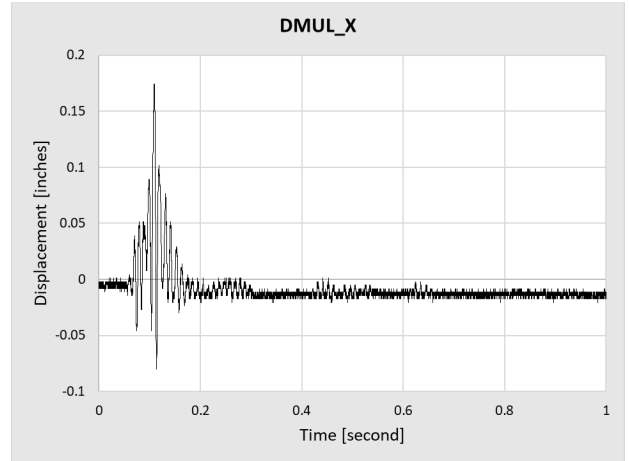

Figure G54. DMUL_X Displacement Data

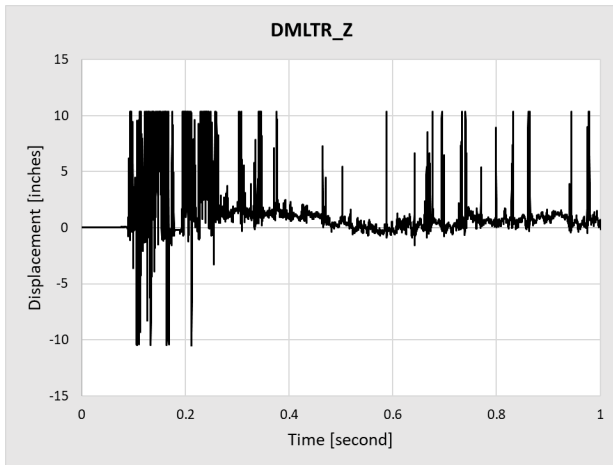

Figure G55. DMLTR_Z Displacement Data

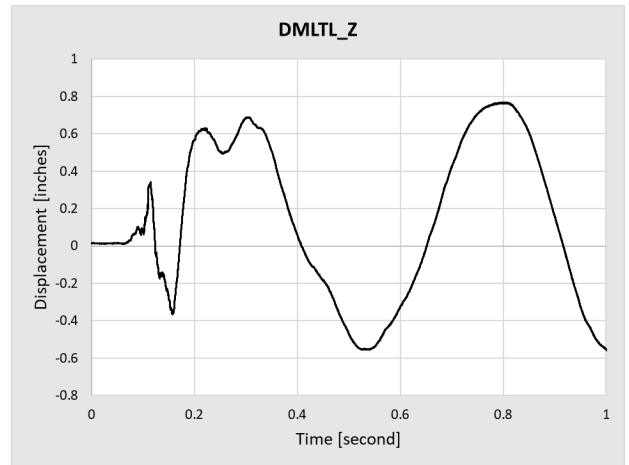

Figure G56. DMLTL_Z Displacement Data

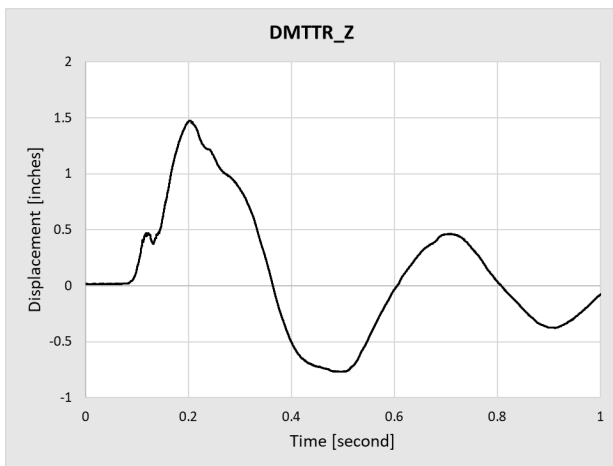

Figure G57. DMTTR_Z Displacement Data

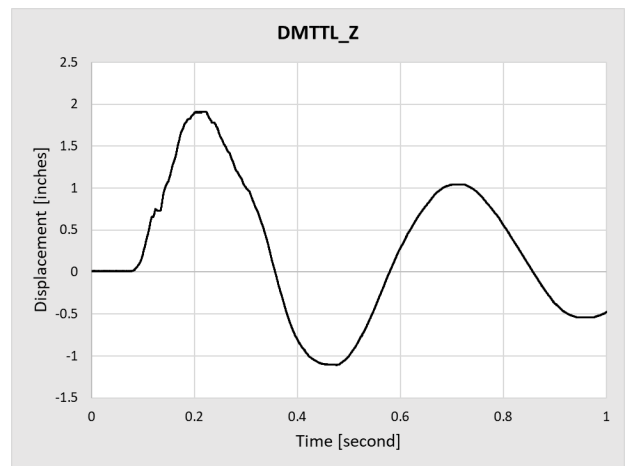

Figure G58. DMTTL_Z Displacement Data