



U.S. Department
of Transportation
Federal Railroad
Administration

Office of Research,
Development and Technology
Washington, DC 20590

LED-Enhanced Sign Research to Reduce Vehicle Queuing at Highway-Rail Grade Crossings



NOTICE

This document is disseminated under the sponsorship of the Department of Transportation in the interest of information exchange. The United States Government assumes no liability for its contents or use thereof. Any opinions, findings and conclusions, or recommendations expressed in this material do not necessarily reflect the views or policies of the United States Government, nor does mention of trade names, commercial products, or organizations imply endorsement by the United States Government. The United States Government assumes no liability for the content or use of the material contained in this document.

NOTICE

The United States Government does not endorse products or manufacturers. Trade or manufacturers' names appear herein solely because they are considered essential to the objective of this report.

REPORT DOCUMENTATION PAGE

*Form Approved
OMB No. 0704-0188*

The public reporting burden for this collection of information is estimated to average 1 hour per response, including the time for reviewing instructions, searching existing data sources, gathering and maintaining the data needed, and completing and reviewing the collection of information. Send comments regarding this burden estimate or any other aspect of this collection of information, including suggestions for reducing the burden, to Department of Defense, Washington Headquarters Services, Directorate for Information Operations and Reports (0704-0188), 1215 Jefferson Davis Highway, Suite 1204, Arlington, VA 22202-4302. Respondents should be aware that notwithstanding any other provision of law, no person shall be subject to any penalty for failing to comply with a collection of information if it does not display a currently valid OMB control number.
PLEASE DO NOT RETURN YOUR FORM TO THE ABOVE ADDRESS.

1. REPORT DATE (DD-MM-YYYY) 31/08/2020		2. REPORT TYPE Technical Report		3. DATES COVERED (From - To) July 2016 – August 2020	
4. TITLE AND SUBTITLE LED-Enhanced Sign Research to Reduce Vehicle Queuing at Highway-Rail Grade Crossings				5a. CONTRACT NUMBER	
				5b. GRANT NUMBER	
				5c. PROGRAM ELEMENT NUMBER	
6. AUTHOR(S) Adrian Hellman (ORCID 0000-0003-2350-6736)				5d. PROJECT NUMBER RR97A8	
				5e. TASK NUMBER TD867	
				5f. WORK UNIT NUMBER	
7. PERFORMING ORGANIZATION NAME(S) AND ADDRESS(ES) U.S. Department of Transportation Office of the Assistant Secretary for Research and Technology John A. Volpe National Transportation Systems Center 55 Broadway, Cambridge, MA 02142				8. PERFORMING ORGANIZATION REPORT NUMBER DOT-VNTSC-FRA-20-12	
9. SPONSORING/MONITORING AGENCY NAME(S) AND ADDRESS(ES) U.S. Department of Transportation Federal Railroad Administration Office of Railroad Policy and Development Office of Research, Development, and Technology Washington, DC 20590				10. SPONSOR/MONITOR'S ACRONYM(S)	
				11. SPONSOR/MONITOR'S REPORT NUMBER(S) DOT/FRA/ORD-21/07	
12. DISTRIBUTION/AVAILABILITY STATEMENT This document is available to the public through the FRA eLibrary .					
13. SUPPLEMENTARY NOTES Safety of Highway-Rail Grade Crossing series FRA COR: Francesco Bedini Jacobini					
14. ABSTRACT Researchers studied the effectiveness of an integrated laser-triggered queue detection system/light-emitting-diode (LED)-enhanced “DO NOT STOP ON TRACKS” sign as compared to a baseline version with no lights. Testing was conducted at the Jay Street grade crossing on the Metro-North Railroad in the Village of Katonah, NY. The results of a before-and-after study showed that the number of vehicles stopped in the zonal area of the grade crossing decreased by 26.6 percent from the baseline to the post-installation configurations. A controlled testing program is recommended before a recommendation for wider use can be made.					
15. SUBJECT TERMS Highway-rail, grade crossing, driver behavior, safety, signage, LED-enhanced signs, violations, traffic queue detection					
16. SECURITY CLASSIFICATION OF:			17. LIMITATION OF ABSTRACT	18. NUMBER OF PAGES	19a. NAME OF RESPONSIBLE PERSON
a. REPORT	b. ABSTRACT	c. THIS PAGE			Adrian Hellman
U	U	U		42	19b. TELEPHONE NUMBER (Include area code) (617) 494-2171

METRIC/ENGLISH CONVERSION FACTORS

ENGLISH TO METRIC

LENGTH (APPROXIMATE)

- 1 inch (in) = 2.5 centimeters (cm)
- 1 foot (ft) = 30 centimeters (cm)
- 1 yard (yd) = 0.9 meter (m)
- 1 mile (mi) = 1.6 kilometers (km)

AREA (APPROXIMATE)

- 1 square inch (sq in, in²) = 6.5 square centimeters (cm²)
- 1 square foot (sq ft, ft²) = 0.09 square meter (m²)
- 1 square yard (sq yd, yd²) = 0.8 square meter (m²)
- 1 square mile (sq mi, mi²) = 2.6 square kilometers (km²)
- 1 acre = 0.4 hectare (ha) = 4,000 square meters (m²)

MASS - WEIGHT (APPROXIMATE)

- 1 ounce (oz) = 28 grams (gm)
- 1 pound (lb) = 0.45 kilogram (kg)
- 1 short ton = 2,000 pounds (lb) = 0.9 tonne (t)

VOLUME (APPROXIMATE)

- 1 teaspoon (tsp) = 5 milliliters (ml)
- 1 tablespoon (tbsp) = 15 milliliters (ml)
- 1 fluid ounce (fl oz) = 30 milliliters (ml)
- 1 cup (c) = 0.24 liter (l)
- 1 pint (pt) = 0.47 liter (l)
- 1 quart (qt) = 0.96 liter (l)
- 1 gallon (gal) = 3.8 liters (l)
- 1 cubic foot (cu ft, ft³) = 0.03 cubic meter (m³)
- 1 cubic yard (cu yd, yd³) = 0.76 cubic meter (m³)

TEMPERATURE (EXACT)

$$[(x-32)(5/9)] \text{ }^\circ\text{F} = y \text{ }^\circ\text{C}$$

METRIC TO ENGLISH

LENGTH (APPROXIMATE)

- 1 millimeter (mm) = 0.04 inch (in)
- 1 centimeter (cm) = 0.4 inch (in)
- 1 meter (m) = 3.3 feet (ft)
- 1 meter (m) = 1.1 yards (yd)
- 1 kilometer (km) = 0.6 mile (mi)

AREA (APPROXIMATE)

- 1 square centimeter (cm²) = 0.16 square inch (sq in, in²)
- 1 square meter (m²) = 1.2 square yards (sq yd, yd²)
- 1 square kilometer (km²) = 0.4 square mile (sq mi, mi²)
- 10,000 square meters (m²) = 1 hectare (ha) = 2.5 acres

MASS - WEIGHT (APPROXIMATE)

- 1 gram (gm) = 0.036 ounce (oz)
- 1 kilogram (kg) = 2.2 pounds (lb)
- 1 tonne (t) = 1,000 kilograms (kg)
- = 1.1 short tons

VOLUME (APPROXIMATE)

- 1 milliliter (ml) = 0.03 fluid ounce (fl oz)
- 1 liter (l) = 2.1 pints (pt)
- 1 liter (l) = 1.06 quarts (qt)
- 1 liter (l) = 0.26 gallon (gal)
- 1 cubic meter (m³) = 36 cubic feet (cu ft, ft³)
- 1 cubic meter (m³) = 1.3 cubic yards (cu yd, yd³)

TEMPERATURE (EXACT)

$$[(9/5) y + 32] \text{ }^\circ\text{C} = x \text{ }^\circ\text{F}$$

QUICK INCH - CENTIMETER LENGTH CONVERSION

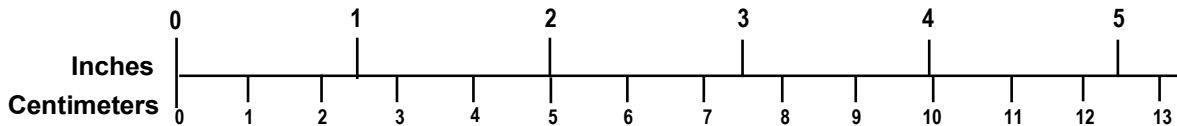

QUICK FAHRENHEIT - CELSIUS TEMPERATURE CONVERSION

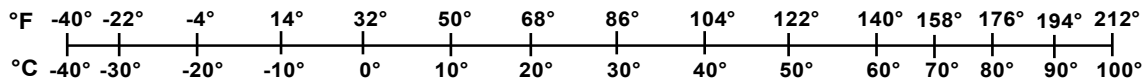

For more exact and or other conversion factors, see NIST Miscellaneous Publication 286, Units of Weights and Measures. Price \$2.50 SD Catalog No. C13 10286

Updated 6/17/98

Acknowledgements

The U.S. Department of Transportation (DOT) Federal Railroad Administration (FRA) Office of Research, Development, and Technology (RD&T) sponsored the work leading to this report. The author thanks Sam Alibrahim, Chief, FRA RD&T Train Control and Communication Division and Francesco Bedini Jacobini, Program Manager, FRA RD&T Train Control and Communication Division.

The author gratefully acknowledges the overall direction provided by Marco daSilva, Program Manager of Highway-Rail Grade Crossing Safety Research at the John A. Volpe National Transportation Systems Center (Volpe). The author also acknowledges Bill Baron and Ryan Brown of the Systems Safety and Engineering Division, Volpe, for their support with system design, installation, and data analyses.

The author also thanks the town of Bedford, New York, and the Metropolitan Transportation Authority Metro-North Railroad for their cooperation.

Cover photo is of a crossing violation at the Jay Street grade crossing in Katonah, New York. (Source: Volpe Center)

Contents

Executive Summary	1
1. Introduction	2
1.1 Background	2
1.2 FRA Research Effort	4
1.3 Objectives	4
1.4 Overall Approach	5
1.5 Scope	5
1.6 Organization of the Report	2
2. Past Research	3
3. Test Site Location and Data Collection	4
3.1 Test Site Location	5
4. Data Acquisition System and Collection Methodology	12
4.1 Data Collection Methodology	14
5. LED-Enhanced Sign Technology	17
5.1 System Cost	19
6. Results and Analysis	20
6.1 Baseline	20
6.2 Post-Installation	22
6.3 Analysis Approach	23
6.4 Results and Discussion	25
6.5 Reliability	26
7. Lessons Learned and Conclusion	28
8. References	31
Abbreviations and Acronyms	32

Illustrations

Figure 1. Aftermath of collision between Metro-North Railroad commuter train and sport-utility vehicle in Valhalla, NY, on February 3, 2015	3
Figure 2. Diagram of Commerce Street grade crossing.....	3
Figure 3. Existing standard NYR9-5 sign at Jay Street.	5
Figure 4. Rendering of an LED-enhanced version of NYR9-5 sign.....	5
Figure 5. Brentwood denoted by a star on the LIRR route map	4
Figure 6. Southbound approach to Wicks Road grade crossing.....	5
Figure 7. Portion of Metro-North Railroad System Map showing Katonah, NY (star)	6
Figure 8. Approach to Jay Street grade crossing from the east	7
Figure 9. Jay Street grade crossing from east (bottom) to west (top).....	9
Figure 10. Westbound approach to the Jay Street grade crossing	10
Figure 11. Eastbound approach to the Jay Street grade crossing.....	11
Figure 12. Baseline Volpe camera system at Jay Street	12
Figure 13. Westbound view from baseline Volpe camera system at Jay Street	13
Figure 14. Definition of grade crossing zones	15
Figure 15. Typical example of vehicle movements on the westbound approach to Jay Street	16
Figure 16. Laser-triggered, LED-enhanced, NYR9-5 sign.....	18
Figure 17. Circuit diagram for laser-triggered LED sign system	19
Figure 18. Vehicles queued on the Jay Street crossing during baseline data collection.....	21
Figure 19. Vehicles queued on the westbound approach to Jay Street. Inset shows LED-enhanced NYR9-5 sign is activated.	22

Tables

Table 1. Baseline Driver Stopping Behavior by Zone	21
Table 2. Post-Installation Driver Stopping Behavior by Zone	23
Table 3. Results of Standard Deviation Tests for Eastbound Direction	25
Table 4. Results of Standard Deviation Tests for Westbound Direction	26
Table 5. Eastbound Baseline and Post-Installation Significance Testing Results	26
Table 6. Westbound Baseline and Post-Installation Significance Testing Results.....	26
Table 7. Activation Reliability Data	27

Executive Summary

The Federal Railroad Administration (FRA) is involved with numerous wide-ranging engineering, education, and enforcement efforts to increase highway-rail grade crossing safety by reducing the number, frequency, and severity of incidents that occur each year. In 2019, there were 2,225 incidents resulting in 297 fatalities and 815 injuries at one of the more than 206,000 at-grade highway-rail crossings in the U.S. These values represent increases of 4.9, 16.5, and 11 percent, respectively, from the 10-year trend. Although many factors were associated with these incidents, a potentially significant number involved vehicles stopping on the tracks, usually in heavy traffic.

Researchers at the John A. Volpe National Transportation Systems Center (Volpe) studied the effectiveness of an integrated laser-triggered queue detection system/light-emitting-diode (LED)-enhanced “DO NOT STOP ON TRACKS” sign in reducing the number of vehicles stopping on the tracks during heavy traffic conditions. Testing of this experimental technology was conducted at the Jay Street grade crossing on the Metro-North Railroad in the Village of Katonah, New York. The FRA Office of Research, Development, and Technology funded and directed this research.

Volpe researchers performed a “before” and “after” video analysis of highway-vehicle stopping patterns at the grade crossing. They collected the before, or baseline, data from April through June 2018. In October 2018, the laser-triggered queue detection system/LED-enhanced sign was installed in the westbound direction of travel. This sign replaced the pre-existing standard NYR9-5 sign. The researchers then captured post-installation video data in May 2019. A statistical analysis showed that the number of vehicles stopped in the zonal area of the grade crossing decreased by 26.6 percent from the baseline to the post-installation configurations.

While the results of this research appear promising, this potential safety improvement has only been studied at one crossing. A controlled testing program is recommended to definitively characterize the effectiveness of this experimental technology before a recommendation for wider use can be made.

1. Introduction

The John A. Volpe National Transportation Systems Center (Volpe) provides technical support to the Federal Railroad Administration (FRA) on grade crossing safety and trespass prevention research. This support includes key research associated with railroad rights-of-way (ROW), including highway-rail intersections and trespass issues.

In calendar year 2019, there were 2,225 incidents resulting in 297 fatalities and 815 injuries at one of the more than 206,000 at-grade highway-rail crossings in the United States (FRA Office of Safety, 2019). These values represent increases of 4.9, 16.5, and 11 percent, respectively, from the 10-year trend. Although many factors were associated with these incidents, approximately one-quarter of these involved vehicles stopping on the tracks (Hellman and Poirier, 2019).

1.1 Background

In the early evening of February 3, 2015, a Metro-North Railroad (MNR) commuter train traveling northbound on the Harlem Subdivision (Line), collided with a 2011 Mercedes Benz ML 350 sport-utility vehicle (SUV) that was stopped on the highway-railroad grade crossing (grade crossing) located at Commerce Street in the Village of Valhalla, New York (crossing 529-902V). As a result of the collision, the SUV was pushed 665 feet north on the tracks (see [Figure 1](#)). The electrified third rail on the west side of the track was damaged and became detached from its mounting assembly. The third rail pierced the sport-utility vehicle, and an estimated 343 feet of rail penetrated the first passenger railcar (National Transportation Safety Board, 2017).

In addition to the driver of the SUV, five passengers onboard the first car of the train were killed and nine were injured. According to the National Transportation Safety Board (NTSB),

“Contributing to the accident was the driver of the sport-utility vehicle: (1) stopping beyond the stop line, within the boundary of the highway-railroad grade crossing, despite warning signs indicating the approach to the grade crossing....”

A unique feature of the Commerce Street grade crossing is the relatively short storage space of approximately 109 feet (roughly 5½ car lengths) from the closest end of the crossing to the far end of an upstream signalized intersection with the Taconic Parkway (see [Figure 2](#)). During periods of heavy highway traffic, the storage space may be easily exceeded, resulting in traffic queueing over the grade crossing. The regulatory signage consisted of an Advance Warning Sign (W10-1), Grade Crossing Crossbuck (R15-1), Number of Tracks (R15-2), and “STATE LAW DO NOT STOP ON TRACKS” (NYR9-5). Even though the NTSB report (2017) identified that the signage was compliant with the Manual of Uniform Traffic Control Devices (MUTCD), there existed a high likelihood that highway traffic queueing over the grade crossing was a contributing factor to the collision.



(Source: NTSB, 2017)

Figure 1. Aftermath of collision between Metro-North Railroad commuter train and sport-utility vehicle in Valhalla, NY, on February 3, 2015

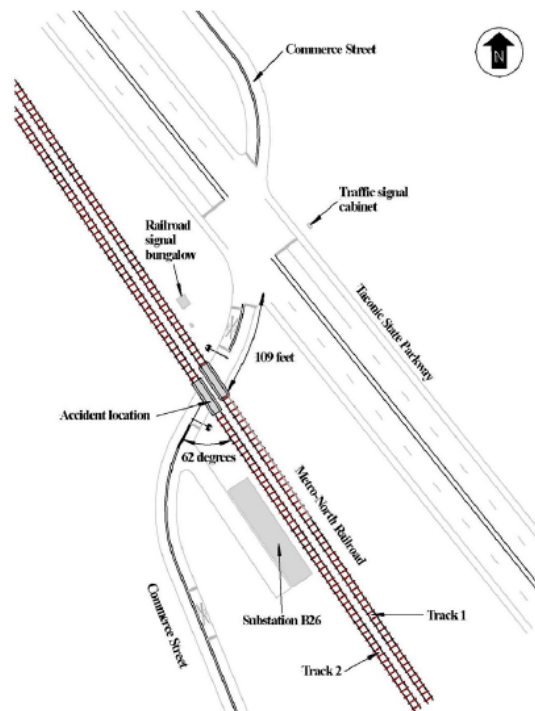

(Source: NTSB, 2017)

Figure 2. Diagram of Commerce Street grade crossing

Following this action, the Metropolitan Transportation Authority (MTA) of New York acquired the services of a grade communications and signaling consulting firm to perform safety assessments of grade crossings with similar queueing characteristics on both Metro-North and the Long Island Rail Road (LIRR). The firm was also tasked to coordinate with State and local department of transportation officials to develop action plans to improve site conditions and interaction with traffic control devices. The action plans included testing to evaluate the effectiveness on highway-vehicle driver behavior of new road markings, signage, and lighting at grade crossings (MTA, 2015).

To support the evaluation effort, in September 2016, FRA, under the Railroad Safety Infrastructure Improvement Grant program, awarded several grants to the New York State Department of Transportation (NYSDOT) to improve safety at multiple MNR grade crossings. One grant, for \$1.34 million, funded the addition of highway traffic signal preemption technology to MNR grade crossings. Another grant totaling \$1.91 million funded the installation of video recording technology for data collection of movements at 43 MNR grade crossings (MTA, 2016).

1.2 FRA Research Effort

Following the 2015 Valhalla crash, FRA reached out to MTA about how its research resources could support MTA in reducing the probability of grade crossing accidents resulting from highway vehicles stopped on grade crossing tracks. In May 2016, the FRA Office of Research, Development, and Technology (RD&T), tasked Volpe to explore the feasibility of non-intrusive, low-cost technologies that may reduce incidents of vehicle queueing on grade crossings. Volpe produced a technical memorandum that outlined multiple options that involved the installation of light-emitting diode (LED) technology as in-pavement lights or an enhancement to regulatory “DO NOT STOP ON TRACKS” R8-8 signs. The options included interconnecting the in-pavement lights with grade crossing controller preemption output, employing continuously flashing R8-8 signs, and employing flashing R8-8 lights triggered by highway traffic queueing (Hellman, 2016).

After consulting with MTA, a laser-triggered, LED-enhanced R8-8 solution was selected for test and evaluation. Since the Commerce Street grade cross was the scene of an active NTSB investigation, it was unavailable for testing and evaluation. Consequently, the technology was tested at the Jay Street grade crossing in the Village of Katonah, New York (crossing 529896U).

1.3 Objectives

The objectives of this research included:

- Test the effectiveness of a laser-triggered, LED-enhanced R8-8 sign in reducing highway traffic queuing that may cause cars to stop on grade crossing railroad tracks.
- Evaluate the ability of a solar-based battery charging system to provide continuous power to the laser/LED-enhanced R8-8 sign system.
- Improve traffic performance at grade crossings.

1.4 Overall Approach

To evaluate the effectiveness of the laser-triggered LED-enhanced R8-8 sign, Volpe collected pre-installation video of vehicular traffic in spring 2018 and post-installation video in spring 2019.

New York State law requires employment of a modified version of the R8-8, known as the NYR9-5 sign. The primary difference between the two versions is that the New York version includes text that explicitly informs motorists that it is a State law not to stop on railroad tracks. An image of the standard NYR9-5 version installed at Jay Street is found in [Figure 3](#) and a rendering of an LED-enhanced NYR9-5 is shown in [Figure 4](#).



(Source: Volpe)

Figure 3. Existing standard NYR9-5 sign at Jay Street.



(Source: Volpe)

Figure 4. Rendering of an LED-enhanced version of NYR9-5 sign

1.5 Scope

Researchers investigated the effectiveness of an LED-enhanced regulatory-compliant sign that warns motorists not to stop on railroad tracks at grade crossings. The sign is integrated with a laser-triggered queue detection system and is activated only when a highway vehicle is stopped in the queuing zone.

The MUTCD-compliant R8-8 “DO NOT STOP ON TRACKS” sign is modified by the New York State Supplement (NYS Supplement) to the 2009 MUTCD. The modified sign, NYR9-5, reads “STATE LAW DO NOT STOP ON TRACKS.”

Volpe designed the study to measure the effectiveness, if any, of the LED-enhanced sign in reducing queueing activity.¹ This study was limited to a single crossing in the Village of Katonah, New York.

¹ Queueing activity is defined as incidents of vehicles stopped on the tracks because of traffic backing up from a nearby intersection.

1.6 Organization of the Report

This report is organized as follows:

- Section [2](#) presents a review of the relevant literature.
- Section [3](#) presents an overview of the test site location and data collection activities.
- Section [4](#) presents a description of the data acquisition system and collection method
- Section [5](#) presents a description of the LED-enhanced signs.
- Section [6](#) presents the results of the evaluation.
- Section [7](#) presents the lessons learned and conclusions of the study.

2. Past Research

The Volpe Center conducted a research study that evaluated the effectiveness of LED-enhanced regulatory signs at a passive highway-rail grade crossing in 2013. In that study, existing Grade Crossing Crossbuck (R15-1) signs and Advance Warning Signs (W10-1) were replaced with flashing LED-equipped versions at a grade crossing in Swanton, Vermont. The objective was to assess the impact of two LED-enhanced passive warning device configurations on the speed profiles of motor vehicles as they approached a passive grade crossing. After the LED signs were installed, test results showed a statistically significant decrease in mean vehicle speed at night and improvements in the rate of mean vehicle speed decrease (Hellman and Lamplugh, 2016).

Volpe has also supported FRA in testing the effectiveness of enhancing standard “DO NOT STOP ON TRACKS” (R8-8) signs with flashing LEDs. A research study performed in Belmont, Massachusetts measured the impact of a continuously flashing LED-enhanced R8-8 sign on driver compliance (Baron and DaSilva, 2019). The goal of that study was to measure driver compliance with the standard signs, then replace the signs with LED-enhanced signs and re-measure compliance rates. Results showed the signs produced a 41 percent reduction in frequency of vehicles stopping on the tracks (Baron and daSilva, 2019).

3. Test Site Location and Data Collection

In June 2017, Volpe and MTA conducted site visits of several potential grade crossing locations on the MNR and LIRR. The purpose was to identify the salient features of the crossings that may be favorable for a before-and-after study of highway vehicle queuing patterns. The two most promising crossings were Wicks Road in Brentwood, New York, on the LIRR and Jay Street in the Village of Katonah, New York, on the MNR. Wicks Road (40.7771576N -73.2598643W) (crossing 338166S), located on the Ronkonkoma branch (Figure 5), presented several favorable attributes for this type of analysis.



(Source: Metropolitan Transportation Authority)

Figure 5. Brentwood denoted by a star on the LIRR route map

First, Wicks Road is a multi-lane highway-rail grade crossing (see Figure 6) with significant average annual daily traffic (AADT) and commuter rail traffic. According to the latest FRA grade crossing inventory report, the crossing experiences an AADT of over 37,000 vehicles in both directions and roughly 75 daily inbound and outbound train movements on two tracks.² Second, the FRA accident history report included an accident in January 2011 in which a vehicle stopped on the grade crossing, became trapped when the gates descended, and was subsequently hit by an oncoming train.³

These favorable characteristics were offset by the fact that the grade crossing is interconnected with traffic signals on both approaches to the crossing. This provides for an advance preemption time of 18 seconds at each approach that clears most of the traffic between the traffic signals prior to the arrival of a train. This phenomenon was observed during the site visit in June 2017 and essentially precluded Wicks Road as a viable candidate for this study.

² Retrieved from <https://safetydata.fra.dot.gov/> on October 10, 2019.

³ Retrieved from <https://safetydata.fra.dot.gov/> on October 10, 2019.



(Source: Volpe)

Figure 6. Southbound approach to Wicks Road grade crossing

Since the MNR Harlem Line was involved in the 2015 Valhalla accident, three grade crossings on that line were then considered. The first grade crossing, located at Roaring Brook Road in Chappaqua, New York, was at the subject of a separate MTA test program to prevent vehicle queuing on grade crossing tracks, and was ruled out. A second grade crossing, located at Green Lane in Bedford, New York, was also ruled out, since it did not involve a high roadway traffic environment. The third grade crossing is located at Jay Street in the Village of Katonah, New York.

Jay Street is only one of three active at-grade crossings north of Commerce Street and presented several strategic advantages. First, the complex geometry of the roadway presented an opportunity to identify highway-vehicle traffic patterns that exist immediately prior to queuing activity. Second, as indicated, the Jay Street grade crossing is situated on the same MNR line as the Commerce Street grade crossing in Valhalla. Finally, Jay Street is within a 3-hour drive of the Volpe Center, making it convenient to service the LED-enhanced R8-8 signs and the video storage equipment employed to capture vehicle queuing on the grade crossing.

3.1 Test Site Location

The selected crossing is located on Jay Street (41.258802N, -73.683792W) in the Village of Katonah, New York (crossing 529896U). Katonah, a hamlet within the Town of Bedford, in Westchester County, New York, is located on the MNR Harlem Line. Katonah Station is equidistant (41 miles) from the southern terminus of Grand Central Station in New York City and the line's northern terminus at Wassaic, New York (see map in [Figure 7](#)).

There is train station in the village center with a platform that accommodates 8-car trains. The southern edge of the station platform is situated 57 feet north of the center of the grade crossing.

The grade crossing is intersected by two tracks, with trains operating in both directions on either track. Dual-quad active warning lights and gates are installed at each entrance to the crossing.

Given the proximity of the station platform to the grade crossing, all southbound station stops result in the activation of the warning system while a train is stopped at the station. According to the latest MNR schedule, on weekdays, 86 trains pass through the Jay Street grade crossing, with 40 northbound trains and 38 southbound trains stopping at the Katonah station. On weekends, 26 northbound trains and 25 southbound trains pass through the grade crossing, with all the trains stopping at the station. The maximum train speed over the crossing is 60 mph.



(Source: Metropolitan Transportation Authority)

Figure 7. Portion of Metro-North Railroad System Map showing Katonah, NY (star)

Jay Street intersects the grade crossing in the center of Katonah, as shown in Figure 8. It is a two-lane road with a maximum speed limit of 30 mph. The latest NYSDOT AADT records show 5,328 vehicles for 2015 and an estimated 5,293 vehicles for 2016.⁴ The FRA grade crossing inventory file shows an AADT of 6,232 vehicles, although this dates back to 2012.⁵ Since FRA recordkeeping began in 1975, only a single accident was reported, in 1997, in which a northbound MNR train struck a vehicle that was stopped on the crossing.⁶

While there are no traffic light-controlled intersections within the vicinity of the grade crossing, there is a three-way stop sign-controlled intersection where Jay Street intersects Katonah Avenue, just west of the crossing. The only direction not controlled by the STOP SIGN is the

⁴ Retrieved from <https://gis.dot.ny.gov/> on August 9, 2019.

⁵ Retrieved from <https://safetydata.fra.dot.gov/> on August 24, 2020.

⁶ Retrieved from <https://safetydata.fra.dot.gov/> on August 24, 2020.

intersection of Jay Street with Katonah Avenue in the westbound traffic direction. The eastern edge line of the intersection and the farthest western rail of the intersection are separated by approximately 75 feet. This is equivalent to a storage area for nearly four passenger vehicles, using the AASHTO length of 19 feet for a typical passenger car.



(Source: Volpe)

Figure 8. Approach to Jay Street grade crossing from the east

The distance across the grade crossing from outer rail-to-outer rail is 30 feet. The entrance gates are located 10 feet and 9 feet from the outer rails of the westbound and eastbound approaches, respectively. Warning signs include two sets of NYR9-5 “STATE LAW DO NOT STOP ON TRACKS” signs on the far side of each of the approaches and a Grade Crossing Advance Warning (W10-1) sign installed on each of the approach routes. The W10-1 sign in the westbound direction is located 150 feet east of the outermost rail, while the eastbound counterpart is located 250 feet west of the outermost rail on the far side of Katonah Avenue.

There are two additional W10-1 signs installed to warn drivers entering the grade crossing from adjacent parking lots. One is installed perpendicular to the crossing, approximately 20 feet west of the outermost rail on the eastbound approach, facing the parking lot on Katonah Avenue. The other is located 26 feet east of the outermost rail on the westbound approach at the exit of the parking lot on Jay Street. There are also grade crossing pavement marking symbols on both Jay Street approaches extending 50 feet out from the stop bar.

Katonah Avenue is the main north-south route through the central business district of Katonah. The road is lined with numerous restaurants, banks, art galleries, boutiques and salons. One of the larger businesses is the Charles Department store. There is also a large hardware store less than a block west of Katonah Avenue on the Taconic Parkway.

There are two commuter rail parking lots within a 5-minute walk of the train station. Lot 1, shown in the bottom right quadrant of [Figure 9](#), is located at 2 Jay Street directly adjacent to the train station and has a maximum capacity of 280 vehicles. Lot 2, located at 190 Katonah Avenue,

has a maximum capacity of 178 vehicles. Both lots are crowded with cars during the morning and evening rush hours.



(Source: Westchester GIS)

**Figure 9. Jay Street grade crossing from east (bottom) to west (top)
(Note: Lot 1 is located at the bottom of the picture.)**

3.1.1 Westbound

There is one lane of traffic in the westbound direction, as shown in Figure 10. The entrance to the Jay Street commuter rail parking lot is located immediately prior to the grade crossing. The intersection with Katonah Avenue is 75 feet west of the crossing.

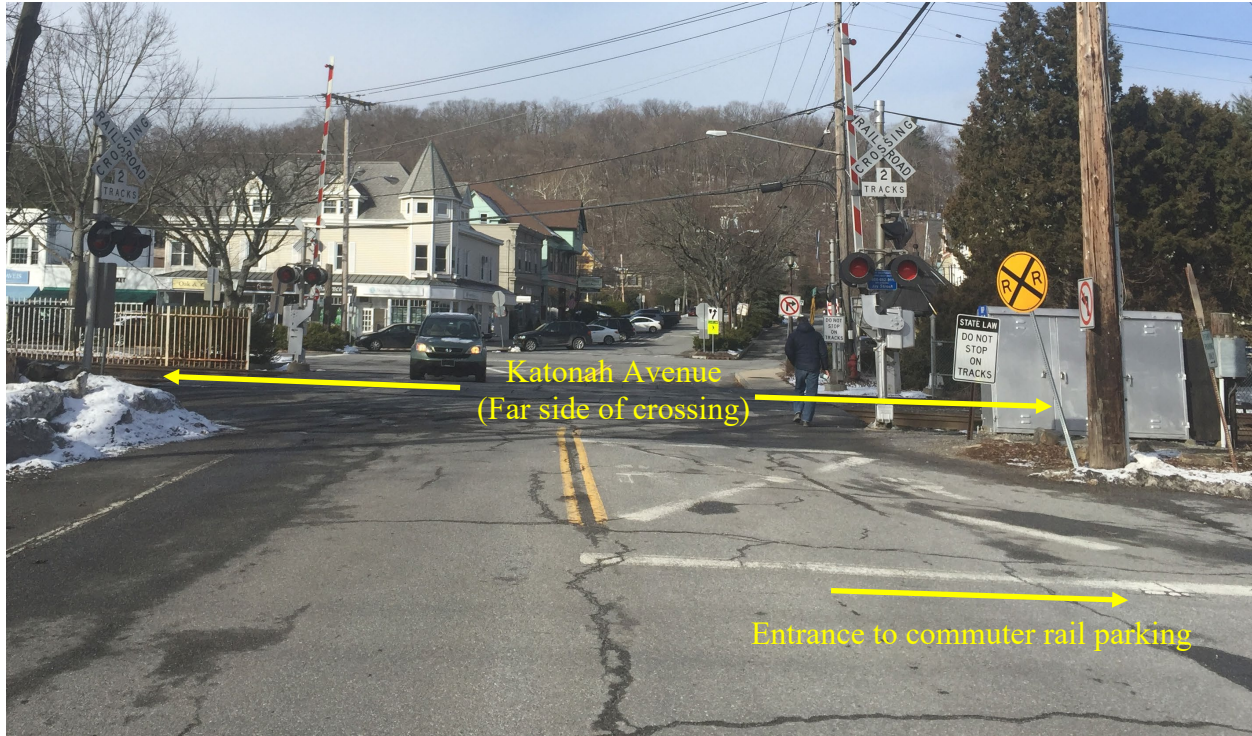

(Source: Volpe)

Figure 10. Westbound approach to the Jay Street grade crossing

3.1.2 Eastbound

There is also one lane of traffic in the eastbound direction, as shown in [Figure 11](#). On the eastbound approach to the grade crossing, a stop sign is at the intersection of Jay Street and Katonah Avenue.



(Source: Volpe)

Figure 11. Eastbound approach to the Jay Street grade crossing

4. Data Acquisition System and Collection Methodology

The results of a site survey showed that the optimal location for the data collection system to be on MNR property. Despite several inquiries by the Volpe team, the logistical requirements to receive authorization to install the data collection system on MNR property proved challenging. Without approval from MNR, the data acquisition systems was sited less optimally, as described below.

Two versions of the data acquisition system were employed during the baseline and post-installation phases. For each version, the video camera was installed on the same utility pole approximately 60 feet east of the of the westbound approach stop bar at the corner of Jay Street and Lakeside Road, as shown in [Figure 12](#). The baseline version was installed on November 1, 2017 by Volpe. Video data was collected using a 0.5 megapixel analog camera (BPRO-316VF) equipped with a 3.5–16 mm varifocal lens and recorded on a 500-gigabyte digital video recorder (DVR) (Lawmate PV-1000) set to 5 frames per second (fps). This provided for a minimum of 2 months continuous recording storage capacity.

The system was powered by two 12-volt, 12-amp-hour, sealed, lead acid batteries (Yuasa NP12-12) connected to a single solar 55-watt panel (Solartech SPM055P-N) /10-amp, 12-volt solar charge controller charging system (Morningstar SS-10-12V SunSaver). The solar panel was aimed south to optimize charging availability. After multiple failures of the battery charging system, a second solar panel was added. The panels were directed southeast and southwest, respectively, to maximize charging capability. [Figure 13](#) is a screenshot from the video collection system looking westbound toward the center of Katonah.



(Source: Volpe Center)

Figure 12. Baseline Volpe camera system at Jay Street



(Source: Volpe)

Figure 13. Westbound view from baseline Volpe camera system at Jay Street

Volpe researchers installed the post-installation version of the data acquisition system in October 2018. The recording system was anchored by a 3-megapixel IP video camera (Speco Technologies O3VFBM) equipped with a 2.7–12 mm lens. Video data was recorded with a network video recorder (SunEyes N6200-8E) in conjunction with a 4-terabyte USB external hard drive (Western Digital My Passport) set to 30 fps. As with the system deployed during the baseline period, this setup provided for a storage capacity roughly equivalent to about 2 months of continuous recording. The system was powered by two of the same 55-watt solar panels used in the baseline (Solartech SPM055P-N) integrated with the 10-amp, 12-volt solar charge controller (Morningstar SS-10-12V SunSaver).

Initially, the two 12-volt batteries from the baseline version of the data acquisition system were retained. However, these batteries were unable to handle the load demand of the post-installation data acquisition hardware. As a result, a new battery bank consisting of five 12-volt, 35-amp-hour, deep-cycle, sealed, lead acid batteries (Duracell DURDC12-35).

4.1 Data Collection Methodology

The goal of this research study was to measure the effectiveness, if any, of the queue detection system/LED-enhanced NYR9-5 sign on vehicle stopping patterns. To understand the effect of the LED enhancement, vehicle movement profiles were coded prior to and after the installation of the sign. The goal was to identify and measure roadway vehicle movements or “events” that result in traffic queuing on the grade crossing or events that are precursors to queuing activity. Vehicle movement profiles were captured during both the baseline and post-data collection phases in both directions at the Jay Street grade crossing.

The video data collection system was not connected to a commercial power source, and derived all of its power from a solar panel-based battery charging system. While the Volpe digital video recording system has been deployed in multiple environments within the U.S., most of them rely on commercially available power. Installations that employ a solar/battery power source are deployed in southern regions of the country, with consistent sunlight and reliable solar power.

The installation in Katonah was the first application of a solar-based system in the Northeast, in months when the sun is low in the sky.

Although this was the most significant challenge, other reliability issues associated with the video recording equipment contributed to a general degradation in the data-collection system performance that precluded baseline data collection until spring 2018. A more detailed discussion of this issue is presented in further detail in the lessons learned section of this report.

Volpe personnel installed the LED-enhanced NYR9-5 sign and laser detection system on October 9–10, 2018. The Town of Bedford supported this effort by installing the sign foundation and pole.

Driver stopping patterns were coded based on three possible zones in each direction in which a motorist could come to a complete stop. These zones are shown in [Figure 14](#).

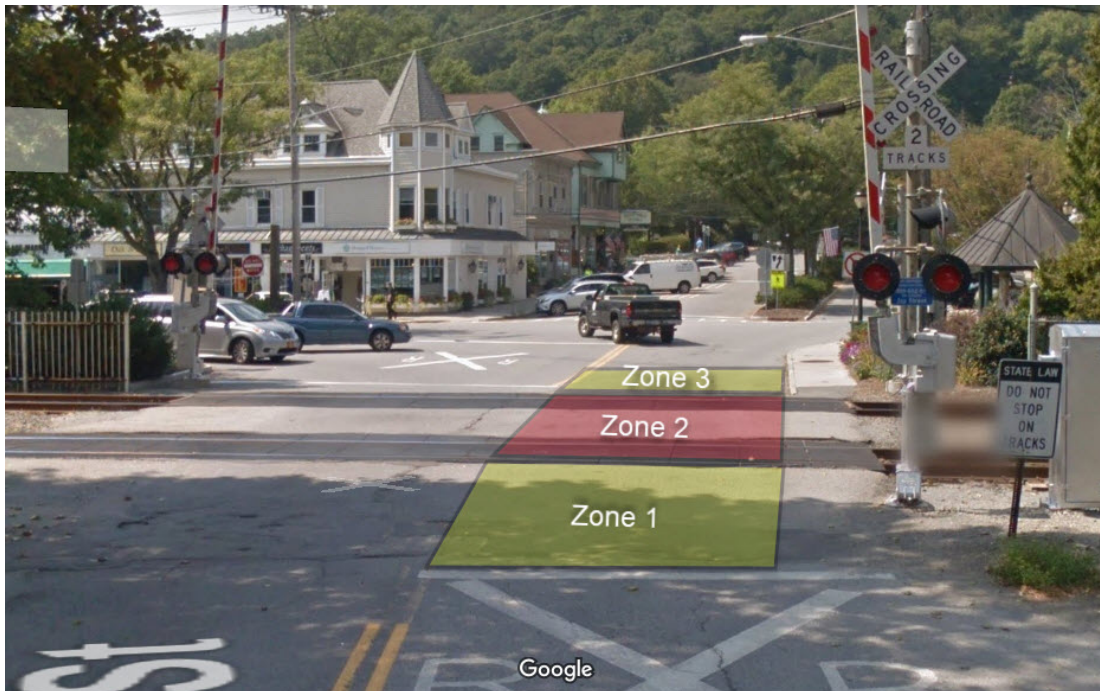

(Source: Google Maps)

Figure 14. Definition of grade crossing zones

The three zones over the crossing represent different levels of danger if the motorist comes to a full stop in that zone:

- Zone 1 (moderately dangerous): From the edge of the grade crossing pavement marking to the tracks on the grade crossing entrance zone. Vehicles stopped in this zone may be stopped because of vehicle queuing in Zones 2 or 3, warning device activation at the crossing, or non-specific vehicle activity in Zone 3 and beyond. A vehicle stopped in this zone is not at risk of colliding with a train but is at risk of being hit by a descending gate arm.
- Zone 2 (extremely dangerous) on the grade crossing. Vehicles stopped on the grade crossing itself are not expected to trigger the activation of the LED-enhanced NYR9-5 sign. In this event, we assume that a vehicle stopped in Zone 3 has triggered the sign and that a vehicle stopped in Zone 2. A vehicle stopped in this zone is at risk of colliding with a train.
- Zone 3 (moderately dangerous): From the grade crossing tracks to the edge of the grade crossing exit zone – roughly parallel to the edge of the grade crossing pavement marking on the westbound approach to the grade crossing. A vehicle stopped in this zone is not at risk of colliding with a train or being struck by a gate, since the only gate arm is in Zone 1. A vehicle stopped in this zone is stopped due to traffic queuing on Jay Street or vehicles turning left from Jay Street into the commuter rail parking lot. This type of event is expected to trigger the LED-enhanced NYR9-5 sign on the exit zone of the westbound direction of traffic movement.

Only vehicles that stopped in one of these three zones were coded, and vehicles that passed through the crossing without stopping were not included in the analysis. In Zone 1, a vehicle was

coded if the driver stopped in Zone 1 without any vehicles immediately in front of it in Zone 2. This coding scheme ensured that the driver stopping in Zone 1 was conducting a safe action and not simply stopping because of traffic. Vehicles stopped in Zone 2 were already in an unsafe situation so a similar caveat was unnecessary. For example, if a vehicle stopped in Zone 2 as a result of traffic queuing, then that vehicle had entered the grade crossing during an unsafe situation.

Generally, coding for each zone was based on where the front bumper of the vehicle was located when the vehicle came to a complete stop. However, if any part of the vehicle was in Zone 2, it was recorded as Zone 2.

The same process for data collection and processing was used in the post-installation coding. Vehicles stopped in any one of the zones were recorded. Vehicles stopped in more than one zone were recorded as having stopped in the zone of highest hazard.

This ranking is consistent with that used in two prior Volpe Center studies: one performed in Belmont, Massachusetts that measured the impact of a continuously flashing LED-enhanced R8-8 sign on driver compliance (Baron and daSilva, 2019), and a second on the effect of continuous pavement markings on driver behavior at grade crossings (Gabree, Chase, and daSilva, 2014). The second study made use of video data that captured vehicle stopping patterns before and after implementation of a safety enhancement. This methodology was also employed in a separate Volpe study of the effectiveness of in-pavement lights (Baron and daSilva, 2019).

Figure 15 shows a typical example of vehicle movements on the westbound approach to Jay Street. The car on the far side of the grade crossing is straddling Zones 2 and 3, while a car on the near side of the grade crossing is traversing Zone 1.

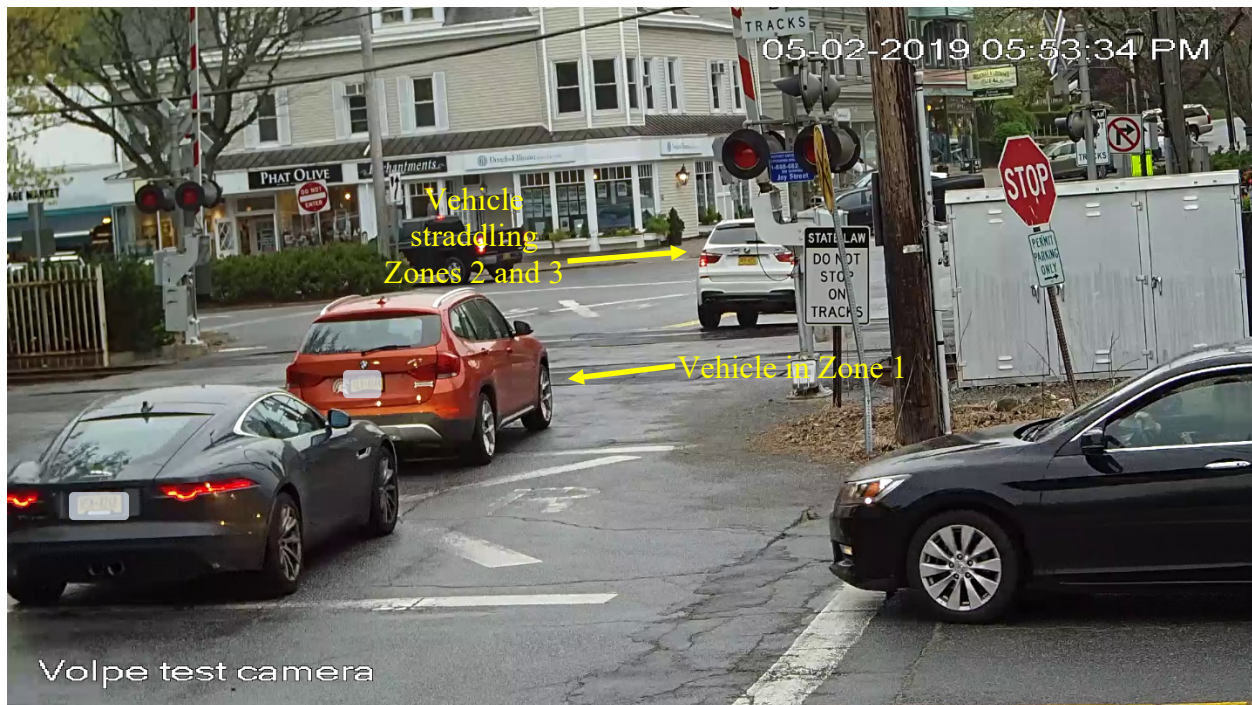

(Source: Volpe Center)

Figure 15. Typical example of vehicle movements on the westbound approach to Jay Street

5. LED-Enhanced Sign Technology

For several years, vendors have been offering standard MUTCD-compliant signs enhanced with flashing LEDs that are intended to capture drivers' attention in particularly dangerous conditions. Stops signs, speed limit signs, and crosswalk signs are among those popular with municipalities trying to improve safe driving behavior.

The sign used in this study were MUTCD-compliant R8-8 signs modified per the NYS Supplement to the MUTCD that read "STATE LAW DO NOT STOP ON TRACKS" (NYR9-5). The MUTCD guidance (Federal Highway Administration, 2009) states that the sign "should be located on the right-hand side of the highway on either the near or far side of the grade crossing, depending upon which position provides better visibility to approaching drivers." The Jay Street grade crossing had existing NYR9-5 signs on the near side and far side of the crossing in each direction, as previously shown in [Figure 10](#) and [Figure 11](#). The signs were 36 inches by 48 inches – an oversized sign typically used on highways and larger than the minimum size (24 inches by 30 inches) required for a single-lane, conventional road.

The LED-enhanced version of this sign, shown in [Figure 16](#), was purchased from Campbell Technology Corporation (CTC), a reseller of Traffic and Parking Control Co. signs. The sign is 24 inches by 30 inches in area with eight 1-watt LED lights along the perimeter that are powered by a 13-watt, 6-volt solar panel, nickel-metal hydride battery combination. The lights are programmed to flash 50 times per minute. The sign can only be disabled by disconnecting the power cable from the battery, which is enclosed inside a separate aluminum tube.



(Source: Volpe)

Figure 16. Laser-triggered, LED-enhanced, NYR9-5 sign

The LED-enhanced sign, which replaced the pre-existing NYR9-5 sign, was installed by the Volpe crew on the far side of the crossing in the westbound direction. The sign was mounted high enough to provide good visibility on both sides of the crossing. All other existing signs were left intact.

As seen from the schematic shown in [Figure 17](#), the laser-triggered LED-enhanced sign is composed of two subsystems: the laser sensor (Laser Technology Inc. TrueSense[®] S210), and the LED-enhanced NYR9-5 sign (CTC Inc. E*Sign). The laser is designated as a Class I emitter, the lowest hazard classification level defined by the Federal Laser Product Performance Standard published by the Food and Drug Administration's Center for Devices and Radiological Health. The S210 operates at a wavelength of 905 nanometers (nm), just outside the visible light spectrum, with a maximum transmit power of 0.39 microwatts. It transmits a continuous train of 200 pulses per second and is powered by the 12-volt solar panel and battery charging system.

The S210 is equipped with separate transmit and receive apertures and is configured to continuously monitor the power levels of the transmitted and reflected beams. The beam is aimed at a region of the road just beyond Zone 3, known as the "detection zone." Under normal operating conditions, no reflected energy would be detected at the receive aperture. When a reflective surface, such as an automobile, occupies the detection zone, the return energy will be detected at the receive aperture. The presence of the return energy activates the S210 5-volt trigger that is provided as input to the multifunction timer relay (Timers Shop multifunction relay). If the return beam is present for longer than 5 seconds, the multifunction timer outputs a 5-volt trigger to the relay (Altronix RB5) that is responsible for closing the LED sign circuit.

This sequence, shown in Figure 17, is governed by a multifunction timer relay configured for an on/off delay cycle. The timer requires a continuous trigger input for a minimum of duration of 5 seconds before its trigger output is activated. Once the timer relay is activated, it will provide an output to the RB5 relay for 20 seconds, causing the LED sign to flash for a concomitant amount of time. If, during this sequence, the S210 trigger output is again activated by a reflected signal for five continuous seconds, the cycle begins anew.

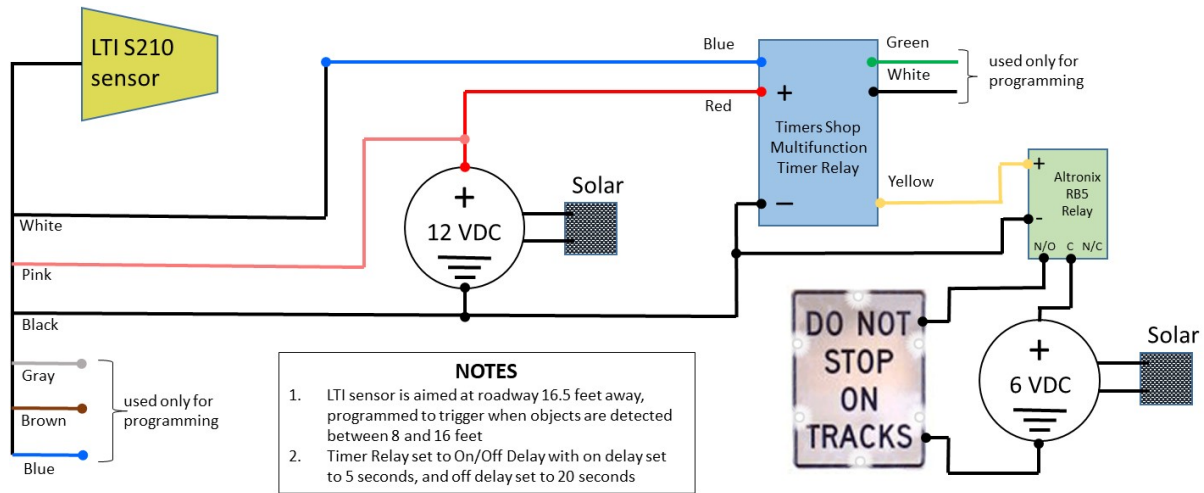

(Source: Volpe)

Figure 17. Circuit diagram for laser-triggered LED sign system

5.1 System Cost

The Volpe Center purchased the LED-enhanced NYR9-5 sign assembly directly from CTC Inc. for \$3,300. This included a 14-foot, pre-drilled, 27/8-inch diameter, Schedule 80 pole with a breakaway triangular slip base fitting. The TrueSense S210 was purchased directly from LTI for \$1,715 and included a sunshade, mounting plate, and download cable. The combined cost of the multifunction timer and the 6-volt relay was approximately \$40. Not including non-recurring engineering and technical support for the data acquisition system, the total cost for the laser-triggered LED-enhanced NYR9-5 sign system was around \$5,055.

6. Results and Analysis

The direction of travel, time of day, and day of the week were recorded for each stopped vehicle. Other factors such as type of vehicle, weather, and the presence of pedestrians or cyclists in the crosswalk were also recorded. It was also noted if the grade crossing safety signals were activated while the vehicle was stopped and what action the vehicle took (if any). Vehicles that stopped at the crossing due to regulatory compliance, but not due to congestion, were not included in this study. Public transit buses, school buses, fuel trucks and others carrying hazmat cargo are examples of vehicles required to stop at all railroad crossings to check for trains.

Two time spans were sampled, encompassing a total of 228 hours: Saturday and Sunday from 9 a.m.–1 p.m. and weekdays from 4 p.m.–8 p.m. These time spans were selected based on observation of daily traffic patterns at the grade crossing. The sample included 519 vehicles coded as stopping in one of the three zones.

6.1 Baseline

The researchers analyzed baseline video of vehicular traffic over the course of 46 days from April 30–June 17, 2018. The sample encompassed a total of 184 hours – 44 weekend hours and 140 weekday hours. A total of 376 vehicles were found to have stopped in one of the three violation zones during this baseline period. After accounting for 24 vehicles legally required to stop in Zone 1, 136 vehicles were recorded in the eastbound direction and 216 in the westbound direction.

A typical example of vehicle queueing is shown in [Figure 18](#), below. In the photograph, the minivan in the foreground is in the approach zone and safely outside any of the zones of interest. The white car in front of the minivan is straddling Zones 1 and 2, while the truck is stopped in Zone 3. There is also a car stopped beyond the truck in the “detection zone” that would trigger the LED-enhanced sign if it were installed.



(Source: Volpe)

Figure 18. Vehicles queued on the Jay Street crossing during baseline data collection

The number and percentages of vehicles that stopped in each of the three zones in each direction are shown in [Table 1](#). The Volpe team could make a few observations from this data. First, only drivers in vehicles stopped in Zone 2, which accounted for 50 percent of all measurements, were committing actual violations. Second, a similar percentage of vehicles was stopped in Zone 2 in each direction: 54.4 percent in the eastbound direction and 47.2 percent in the westbound direction. Third, 61.4 percent of the stopping events were recorded in the westbound direction. Finally, more stopping events were recorded in the westbound direction of Jay Street, as this was the direction of traffic flow toward the Katonah business district. This pattern was the impetus for installation of the modified NYR9-5 sign in the westbound direction.

Table 1. Baseline Driver Stopping Behavior by Zone

Eastbound				Westbound		
Zone 1	22	16.2%		Zone 1	77	35.6%
Zone 2	74	54.4%		Zone 2	102	47.2%
Zone 3	40	29.4%		Zone 3	37	17.1%
Total	136	100.0%		Total	216	100.0%

6.2 Post-Installation

The photograph in [Figure 19](#) is an example of the LED sign being triggered. In the photograph, a car just beyond the field of vision is stopped in the detection zone for a duration longer than 5 seconds. This has resulted in the activation of the LED-enhanced NYR9-5 as shown in the inset. In addition, there is a vehicle stopped in Zone 3 on the far side of the crossing and another vehicle stopped in Zone 1 prior to the grade crossing.



(Source: Volpe)

Figure 19. Vehicles queued on the westbound approach to Jay Street. Inset shows LED-enhanced NYR9-5 sign is activated.

Post-installation data was evaluated for two non-continuous weeks in May 2019; May 1–8 and May 15–17, for a total of 44 hours over 11 days. During this time span, 143 vehicles were recorded in one of the three violation zones. After accounting for vehicles that were legally required to stop in Zone 1, this metric decreased to 129 vehicles, with 54 in the eastbound direction and 75 in the westbound direction. The number and percentages of vehicles that stopped in each of the three zones in each direction are shown in [Table 2](#). The results in the table mirror those found in the baseline testing. First of all, the percentages of vehicles stopped in Zone 2 were extremely close – 33.3 percent in the eastbound direction and 34.7 percent in the westbound direction. The trend shows a significant decrease in both directions, albeit the decrease was larger in the eastbound direction. In addition, approximately 58.1 percent of the stopped vehicles were recorded in the westbound direction, which is extremely close to the 61.4 percent found in [Table 1](#).

Table 2. Post-Installation Driver Stopping Behavior by Zone

Eastbound			Change from Baseline (%)	Westbound			Change from Baseline (%)
Zone 1	28	51.9%	220.5%	Zone 1	38	50.7%	42.1%
Zone 2	18	33.3%	-38.7%	Zone 2	26	34.7%	-26.6%
Zone 3	8	14.8%	-49.6%	Zone 3	11	14.7%	-14.4%
Total	54	100.0%	-	Total	75	100.0%	-

6.3 Analysis Approach

The probability that a vehicle will stop in a zone can be considered a random variable with exactly two possible outcomes: success and failure. The population, N , of these vehicle stopping events is said to be binomially distributed. If a large enough sample size, n , is drawn from this population, we can say that this sample is representative of N .

In before-and-after experiments, it is common to compare the proportion of events, or the binomial proportions, occurring in the before-and-after conditions rather than the absolute number of events. The binomial test of significance is a statistical test for comparing two binomial proportions can be used to compare before-and-after performance. This test determines whether the proportion of occurrence in one sample (the before period) differs significantly from the proportion of occurrence in a second sample (the after period).

Gattis and Iqbal (1994) employed the binomial test of significance to test the effectiveness of the R10-7 “Do Not Block Intersection” sign in reducing intersection blockages. A before-and-after study was performed at four highway intersections in Norman, Oklahoma. The proportion of the intersection blockages at each site in the before period was compared with the proportion in the after period, and the statistical significance of the differences was computed.

In the binomial test of significance, the sample sizes n_1 (before) and n_2 (after) must be sufficiently large to ensure that the sample distributions of proportions

$$p_1 = \frac{x_1}{n_1} \text{ and } p_2 = \frac{x_2}{n_2} \quad (1)$$

where

x_1 and x_2 are the number of successes from the sample of n_1 and n_2 , and the difference of the proportions ($p_1 - p_2$), approximate a standard normal distribution. As shown by Gattis and Iqbal (1994), if n_1 and n_2 are large enough, then the sample proportions p_1 and p_2 are representative of the population means. Under this construct, the normal approximation is applicable if the intervals on either side of the means equivalent to twice the sample standard deviation do not contain zero or one (Mendenhall and Sinchich, 1988), as shown by

$$p_1 \pm 2 \sqrt{\frac{p_1 q_1}{n_1}} \text{ and } p_2 \pm 2 \sqrt{\frac{p_2 q_2}{n_2}} \quad (2)$$

where $2 \sqrt{\frac{p_1 q_1}{n_1}}$ and $2 \sqrt{\frac{p_2 q_2}{n_2}}$ are the sample standard deviations, S_1 and S_2 .

The proportion of successes for the combined sample is $p = \frac{x_1 + x_2}{n_1 + n_2}$ (3)

and, likewise, the proportion of failures for the combined sample q is represented by $q = (1-p)$. Under these conditions, the z -value from the standard normal distribution can be applied to determine if the difference in proportions is statistically significant. The z -value test statistic is expressed as:

$$Z = \frac{p_1 - p_2}{\sqrt{p * q \left(\frac{1}{n_1} + \frac{1}{n_2} \right)}} \quad (4)$$

If the calculated value of $|z| \geq z_{\alpha/2}$, where $z_{\alpha/2}$ is the α -level critical value from the standard normal distribution, the difference in the proportions is statistically significant. If the difference is not significant, then the null hypothesis

$$H_0: p_1 - p_2 = 0 \quad (5)$$

is accepted. If the difference is significant, the null hypothesis is rejected, and the alternative hypothesis

$$H_{alt}: p_1 - p_2 \neq 0 \quad (6)$$

is assumed to be true.

6.4 Results and Discussion

The results of the sample standard deviation tests for approximating a normal distribution are found in Table 3 and Table 4 for the eastbound and westbound directions, respectively. As shown in the tables, all of the ranges for $p1 \pm 2s_{p1}$ and $p2 \pm 2s_{p2}$ do not contain zero or one, thereby satisfying the criteria for using the z-statistic as described in Section 6.3. With the appropriateness of employing the z-value test statistic established, the binomial test of proportions were performed, the results of which are shown in Table 5 and Table 6. All of the tests were conducted at the 90 percent significance level ($\alpha = 0.10$), equating to an α -level critical value from the standard normal distribution of $z_{\alpha/2} = 1.645$.

The tests of significance results are shown in the last columns of Table 5 and Table 6. Since stopping in Zone 3 is a legal traffic maneuver, it is difficult to reach any affirmative conclusions regarding the significance of the calculated values of $|z|$. However, the results are interesting in that both eastbound and westbound directions indicate a trend of more vehicles stopping in Zone 1 and fewer vehicles stopping in Zone 2 and 3. As shown in Table 2, the increase in the number of vehicles stopped in Zone 1 in the eastbound direction is approximately four times larger than in the westbound direction – the location of the LED-enhanced NYR9-5.

The trend towards more vehicles stopping in Zone 1 and fewer stopping in Zone 3 is indicative of a trend toward less vehicle queuing in Zone 3. It is tempting to conclude that traffic movements in the eastbound direction were more impacted by a sign installed in the westbound direction than traffic in the westbound direction. However, the magnitude of the calculated value of $|z|$ is not an indicator of the merit for rejecting or accepting the null hypothesis. The $|z|$ -values for Zone 2 indicate a reduction of vehicles stopping both approaches to the grade crossing. While the $|z|$ -value is larger in the eastbound direction, the results in both directions show a clear rejection of the null hypothesis, meaning that the decrease in proportions between baseline and post-installation is real. To be clear, vehicles stopped in Zones 1 or 2 are committing a traffic violation. However, a vehicle stopped in Zone 2 on the grade crossing is inherently at a higher risk of colliding with a train than a vehicle stopped in Zone 1. Therefore, the results show that the presence of the LED-enhanced sign may be positively influencing vehicle stopping patterns.

An unexpected, but curious, phenomenon that merits discussion relates to the strong uniformity between the eastbound and westbound post-installation measured proportions. A zone-by-zone comparison of the measured proportions of vehicles stopped showed an extremely small (less than 5 percent) difference between both directions of traffic. These values are highlighted in yellow in the fifth column of Table 5 and Table 6. While the basis for this result is not readily apparent, the data are strongly suggestive of an impact from the presence of the LED-enhanced sign.

Table 3. Results of Standard Deviation Tests for Eastbound Direction

Eastbound Test Statistics						
Zone	$2s_{p1}$	$2s_{p2}$	$p1+2s_{p1}$	$p1-2s_{p1}$	$p2+2s_{p2}$	$p2-2s_{p2}$
Zone 1	0.06315	0.13599	0.22492	0.09861	0.65451	0.38253
Zone 2	0.08541	0.12830	0.62953	0.45870	0.46163	0.20503
Zone 3	0.07814	0.09669	0.37226	0.21598	0.24483	0.05146

Table 4. Results of Standard Deviation Tests for Westbound Direction

Westbound Test Statistics						
Zone	$2\sigma_{p1}$	$2\sigma_{p2}$	$p1+2\sigma_{p1}$	$p1-2\sigma_{p1}$	$p2+2\sigma_{p2}$	$p2-2\sigma_{p2}$
Zone 1	0.06518	0.11546	0.42166	0.29130	0.62213	0.39121
Zone 2	0.06794	0.10991	0.54016	0.40429	0.45657	0.23676
Zone 3	0.05127	0.08170	0.22257	0.12002	0.22837	0.06497

Table 5. Eastbound Baseline and Post-Installation Significance Testing Results

Eastbound			Proportions		z
Zone	Baseline	Post	p_1	p_2	
Zone 1	22	28	0.1618	0.5185	5.0369
Zone 2	74	18	0.5441	0.3333	2.6223
Zone 3	40	8	0.2941	0.1481	2.0885
Total	136	54			

Table 6. Westbound Baseline and Post-Installation Significance Testing Results

Westbound			Proportions		z
Zone	Baseline	Post	p_1	p_2	
Zone 1	77	38	0.3565	0.5067	2.2921
Zone 2	102	26	0.4722	0.3467	1.8873
Zone 3	37	11	0.1713	0.1467	0.4952
Total	216	75			

These results are consistent with the research of (Hellman and Lamplugh, 2016) that showed a statistically significant decrease in the speeds of highway vehicles as they approach continuously flashing LED-enhanced Advance Warning and Crossbuck signs. While this research effort focused on highway vehicle queueing patterns, both studies showed a positive response to the enhanced signage. A 2019 report by Baron and DaSilva that documented driver response to continuously flashing “DO NOT STOP ON TRACKS” signs showed a 41 percent reduction in vehicles stopped on the tracks. This result compares favorably with the 26.6 percent decrease found in this research.

6.5 Reliability

A total of 10 Zone 3-related vehicle-stopping events were recorded in the westbound direction that required further analysis. The roadway vehicle detection system was designed such that a vehicle was required to be stopped in the detection zone for a minimum of 5 seconds in order to

trigger the LED-enhanced lights. Table 7 shows the date/day/time fields, along with more pertinent data relating to the operation of the laser detection and sign. Note that some of the values in the Time Stopped in Detection Zone field are less than the 5-second requirement. These measurements were initially identified as being at least 5 seconds, but upon further review, were found to be less. They remain in the table as empirical evidence that the vehicle detection system was able to correctly “filter-out” stopping events that were shorter in duration than the 5-second requirement.

The only anomalous event occurred on May 15, 2019, in which a vehicle stopped in the detection zone for 10 seconds without triggering the LED lights. There can only be two explanations for this occurrence. First, the vehicle detection system may not have been functioning properly. Since the system is “experimental,” no event-recording device was present and therefore there was no means to review the system performance. The other explanation is that although the vehicle appeared to be in the detection zone from the vantage point of the camera, in actuality it was not.

Column 6 in Table 7 show the measurements for Zone 3 vehicle stopping events that triggered the flashing LED lights on the NYR9-5 sign. Of the four events in which the LED lights were triggered, three constituted the minimum required duration of 5 seconds, only two of which were close to the LED activation setting of 30 seconds. The third stopping event resulted in an LED activation of 53 seconds. Further review of the video data for this event showed no other vehicles that may have caused the sign to continue flashing for an excess duration of 23 seconds. For the fourth vehicle stopping event, the vehicle was stopped in Zone 3 for a total of 16 seconds, resulting in a 50 second LED activation duration. This is an unexpected result, as the timer relay is configured to continue adding 30-second flashing times for every five seconds that a vehicle is stopped within the detection zone.

Table 7. Activation Reliability Data

Date	Day of Week	Time	Did LED Lights Activate?	Time Stopped in Detection Zone	Duration of LED Activation
5/2/2019	Thursday	5:27:18 p.m.	Yes	5 seconds	53 seconds
5/3/2019	Friday	5:14:38 p.m.	Yes	5 seconds	28 seconds
5/3/2019	Friday	6:36:24 p.m.	No	4 seconds	
5/5/2019	Sunday	9:57:53 a.m.	Yes	16 seconds	50 seconds
5/6/2019	Monday	5:06:15 p.m.	Yes	5 seconds	26 seconds
5/8/2019	Wednesday	4:26:40 p.m.	No	4 seconds	
5/15/2019	Wednesday	6:37:01 p.m.	No	4 seconds	
5/16/2019	Thursday	4:25:31 p.m.	No	3 seconds	
5/16/2019	Thursday	5:00:46 p.m.	No	4 seconds	
5/16/2019	Thursday	7:40:53 p.m.	No	10 seconds	

7. Lessons Learned and Conclusion

The laser-triggered queue detection system with LED-enhanced NYR9-5 signage exhibited some promising data trends, but more research would be necessary to verify and validate the efficacy of the technology. The post-installation results for the direction of travel in which the detection system/LED-enhanced sign was installed showed, as compared to the baseline data, a 26.6 percent decrease in the number of vehicles stopped in the zonal area of the railroad grade crossing and a concomitant 14.4 percent decrease of vehicles stopped in the queuing area directly downstream from the grade crossing. Even more assuring was the 42.1 percent increase in the number of vehicles that stopped in the approach zone to the grade crossing.

To distinguish if these results were significant or simply a consequence of the reversion to mean phenomenon, the binomial test of significance was performed on the proportion of vehicles stopped in each zone. The 90 percent significance interval results substantiated the general trend of fewer vehicles stopped in the grade crossing zone with more vehicles stopped in the grade crossing approach. A major stipulation to these results is that a vehicle stopped in the zone on either side of the grade crossing itself is not actually involved in an illegal action.

From the limited data available, the reliability of the detection system appeared to exhibit some unexpected anomalies. On two occasions, the LED-enhanced sign was activated for 50 seconds, significantly greater than the 30-second design limit. While it is possible for the sign to flash for longer than 30 seconds, the condition of a second vehicle in the queue detection zone – needed to reset the activation timer during the flashing cycle – was not present. The data also showed a 10-second event in which a vehicle appeared to be stopped in the queue detection zone and the LED lights did not flash. Further analysis of the technology is necessary to establish the root causes of these phenomena.

To definitively measure the beneficial effect, if any exists, of this experimental technology, a research program should be implemented at grade crossings with higher AADT and more lanes of traffic. This could be accomplished through a series of controlled field experiments involving two similar grade crossings, preferably in close proximity to each other. In these types of experiments, the “experimental” crossing receives the detection and LED-enhanced sign technology, while the “control” crossing remains unchanged. This approach is more expensive than the before-and-after testing program documented in this report. However, controlled testing eliminates the additional complexity associated with the reversion to mean phenomenon as well as the complicated statistical analysis needed to evaluate the effectiveness of the technology.

This project yielded several valuable lessons learned that should be considered in any future evaluation of the same or similar technologies.

- Camera power supply reliability. When the DVR system was installed in November 2017, it was the first time the Volpe system employed a solar-powered battery charging system in the northern U.S. The initial design for the baseline data collection phase consisted of a single solar panel and two 12-volt, 12-amp-hour, sealed lead acid batteries. Although the solar panel was aimed at the southern sky to optimally capture the available sunlight, several factors impeded proper operation of the charging system from the beginning.

First, the long hours of darkness during the fall and winters months precluded the charging system from ever entering a virtuous charging cycle. This was compounded by the dense foliage blockage in the immediate area. Finally, an IP camera/network video recording system was initially installed and powered by the power source. However, the team found that the recording system placed an excessive load on the charging system. The system was modified with an analog camera that drew less current, though it recorded at a reduced frame rate. Unfortunately, this charging configuration did not provide the necessary reliability, so a second solar panel was installed and the two panels were aimed in the southeast and southwest directions.

Prior to the post-installation data collection phase, the two 12-volt, 12-amp-hour, sealed lead acid batteries were replaced by a bank of five 12-volt, 35-amp hour deep-cycle sealed lead acid batteries. This final configuration proved sufficiently reliable to allow for the use of the higher frame rate (resolution) IP camera/network. Despite the improvements, both the baseline and post-installation phase video were recorded during the spring and summer to maximize the reliability of the charging system.

- Low vehicle counts/low frequency of vehicle queuing. The Jay Street grade crossing satisfied several of the requirements for evaluation of the proof-of-concept the laser-triggered LED-enhanced NYR9-5 sign. One was the need for a two-lane roadway. The laser detector can only detect a stopped vehicle in a single lane of traffic. A roadway with multiple lanes of traffic in the same direction would necessitate a dedicated laser for each lane. Another requirement, which was satisfied by the Jay Street location, was the absence of a highway traffic light interconnected with the grade crossing.

These positive attributes, indicative of a grade crossing with low AADT, may not necessarily be optimal for either frequent or long-duration queuing events. Since vehicle queuing was a relatively rare event, it was also rare for the laser to detect vehicles stopped in the detection zone for more than 5 seconds.

- Relative subjectivity of Volpe data reductionist. Volpe maintains a team of experienced data reductionists. For this effort, the same reductionist reviewed the baseline and post-installation video and was involved in the reduction of vehicular traffic patterns at a continuously flashing LED-enhanced R8-8 sign in Belmont, Massachusetts (Baron and DaSilva, 2019). Volpe does not have a formal data reduction quality control program and has not characterized how the repetitive nature of video reduction impacts the consistency and quality of the data reduction process.
- Power of binomial test of proportions. As is the case with most before-and-after highway traffic studies, it is unlikely that the two sample populations are independent and distributed normally. The before-and-after sample populations are only truly independent if each one is composed of two different groups of randomly selected drivers. The Jay Street grade crossing is co-located with a commuter rail station, with parking lots on both sides of the crossing. The crossing is also the gateway to the Katonah central business district. In light of the these two facts, it is reasonable to expect that the grade crossing user population consists of many drivers who encounter the grade crossing on a daily basis. This precludes any semblance of independence between the before and after datasets and increases the likelihood that some of the drivers may have developed some type of bias towards the LED-enhanced sign. This may partially account for the positive

changes in vehicular driving patterns that occurred in the eastbound direction, even though no changes were made to the physical layout of the crossing in that direction.

One of the key predicates of the binomial test of proportions is that each of the datasets being compared approximates a normal distribution. If normality can be shown, then the normal curve z -test works fairly well as a way to test the significance of the results. As discussed in Section 6.3, the normal approximation is applicable if the intervals on either side of the means equivalent to twice the sample standard deviation do not contain zero or one. The closer these values are to 0.5, the stronger the normality, with the reverse being true as well. As shown in Tables 3 and 4, some of the standard deviation pairs are symmetrical around 0.5, while others are not. This points to a general lack of normality for the datasets in both directions and a decrease in the strength of the z -test values.

8. References

- Baron, W., & daSilva, M. (2019). Effectiveness of LED-Enhanced Signs in Reducing Incidents of Vehicles Stopping on Tracks [DOT/FRA/ORD-19/21]. Washington, DC: U.S. Department of Transportation, Federal Railroad Administration.
- Baron, W., & daSilva, M. (2019). Effects of In-Pavement Lights on Driver Compliance with Grade Crossing Safety Equipment [DOT/FRA/ORD-19/10]. Washington, DC: U.S. Department of Transportation, Federal Railroad Administration.
- Federal Highway Administration. (2009). Manual on Uniform Traffic Control Devices. Washington, DC: U.S. Department of Transportation.
- Federal Railroad Administration. Office of Safety Analysis web site.
- Gabree, S., Chase, S., & daSilva, M. (2014). Effect of Dynamic Envelope Pavement Markings on Vehicle Driver Behavior at a Highway-Rail Grade Crossing [DOT/FRA/ORD-14/04]. Washington, DC: U.S. Department of Transportation, Federal Railroad Administration.
- Gattis, J., & Iqbal, Z. (1994). Effectiveness of Do Not Block Intersection Signs. *Transportation Research Record*, 1456, 27-33.
- Hellman, A. (2016, May 16). Memorandum. LED Research Ideas. U.S. DOT Volpe Center.
- Hellman, A., & Lamplugh, A. (2016). Evaluation of LED Sign Technology at a Passive Highway-Rail Grade Crossing [DOT/FRA/ORD-16/01]. U.S. Department of Transportation, Federal Railroad Administration.
- Hellman, A., & Poirier, P. (2019). Highway-Rail Intersection Crash Taxonomy for Connected Vehicle Safety Research – Ten Year Trend [DOT/FRA/ORD-19/25]. Washington, DC: U.S. Department of Transportation, Federal Railroad Administration.
- Mendenhall, W., & Sinchich, T. (1988). Statistics for the Engineering and Computer Sciences. San Francisco, California: Dellen Publishing Company.
- Metropolitan Transportation Authority. (2015, September 22). MTABoard-24Sep2015-Meeting-v1. Retrieved August 2, 2019, from Metropolitan Transportation Authority website: http://web.mta.info/mta/news/books/archive/150924_1000_Board.pdf
- Metropolitan Transportation Authority. (2016, September 12). MTA I news I FRA Awards \$5 Million to Improve Metro-North and Long Island Rail Road Crossings. Retrieved from Metropolitan Transportation Authority website: <http://www.mta.info/news-metro-north-grade-crossings-fra/2016/09/12/fra-awarded-about-5m-improve-metro-north-and-long>
- National Transportation Safety Board. (2017). Highway-Railroad Grade Crossing Collision, Commerce Street, Valhalla, NY, February 3, 2015. NTSB/RAR-17/01. Washington, DC: NTSB.

Abbreviations and Acronyms

Abbreviation or Acronym	Name
AADT	Average Annual Daily Traffic
AASHTO	American Association of State Highway Transportation Officials
CTC	Campbell Technology Corporation
LIRR	Long Island Rail Road
MNR	Metro-North Railroad
MTA	Metropolitan Transportation Authority
MUTCD	Manual on Uniform Traffic Control Devices
NTSB	National Transportation Safety Board
NYSDOT	New York State Department of Transportation
TAPCO	Traffic and Parking Control Company
Volpe Center	John A. Volpe National Transportation Systems Center