

RAIL

MOVING AMERICA FORWARD



FRA Office of Research, Development, and Technology

Current Research Projects



U.S. Department of Transportation
Federal Railroad Administration



SECTION ONE

TRACK

Automated Track Change Detection (ATCD) – Phase 3

PROJECT DESCRIPTION

This project develops and demonstrates new technology to augment human track inspection activities. The research adapts commercially available 3D scanning sensors and artificial intelligence technologies to identify and classify track features and to compare the changes in these features over time. Understanding how track conditions change in response to loads provides valuable insight into track degradation rates and maintenance effectiveness.

RAILROAD IMPACT

- Comprehensive track feature detection and classification employing 3D laser/camera system
- Automated track inspection technology at a high detail level, suitable for component inventory, change detection, and higher analytics
- Technology to augment human inspection requirements producing highly reliable safety information with actionable resolution
- Advances technology-augmented human inspection capabilities to yield improved track condition awareness and safety.

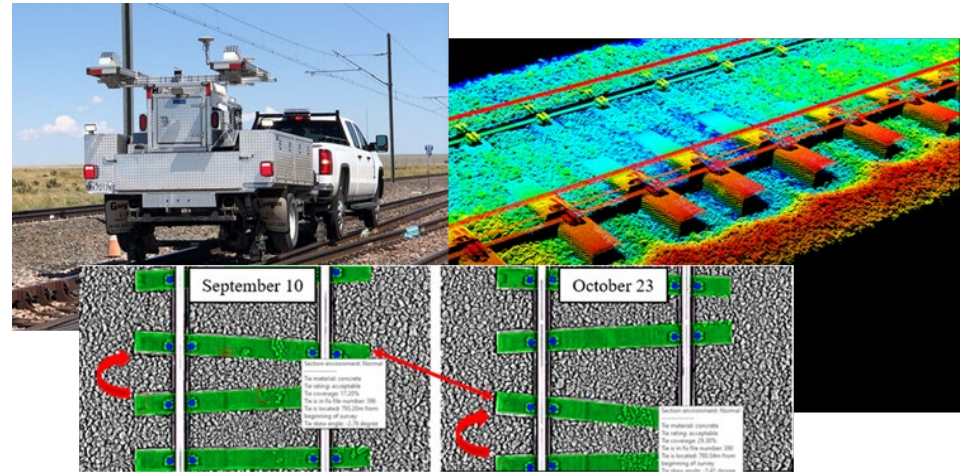

PROJECT PARTNERS

- University of Illinois at Urbana-Champaign
- Railmetrics
- CSX
- Florida East Coast Railway
- Volpe National Transportation Systems Center

COST & SCHEDULE

- Funding: \$425,000
- Project Duration: September 2023 – May 2025

Spike Failure Mitigation

PROJECT DESCRIPTION

Spike failures are identified as the root causes of recent derailments. FRA research has identified spike failures in wood ties with elastic fastening systems resulting from overloading conditions. Additional research has demonstrated the critical role that friction plays in the load path. This project will identify, test, and recommend methods to provide and maintain plate-to-tie friction in elastic fastening systems installed on wood ties.

RAILROAD IMPACT

- Methods and technology to mitigate spike failures in wood tie track.
- Tested solutions to reduce spike stress in track
- Improved rail safety through reduction of spike failures and associated derailments
- Improved system safety and reliability and reduced life cycle infrastructure costs

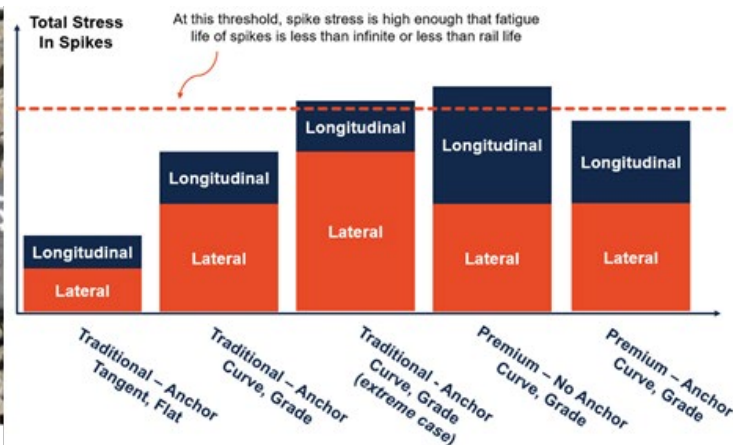
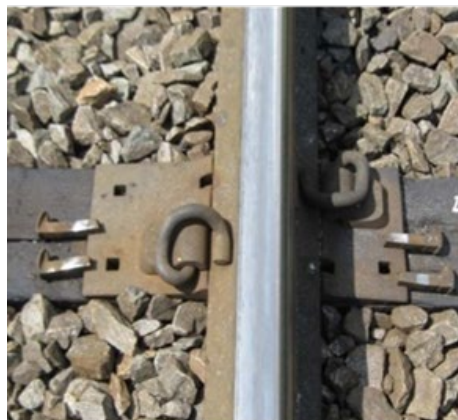

PROJECT PARTNERS

- University of Illinois at Urbana-Champaign
- Advanced Rail Management Corp.
- Norfolk Southern Railway
- Lewis Nut & Bolt Co.
- Pandrol
- Progress Rail Services
- voestalpine Railway Systems Nortrak
- Vossloh AG

COST & SCHEDULE

- Funding: \$859,000
- Project Duration: April 2018 – September 2024

Advancing Concrete Crosstie Design

PROJECT DESCRIPTION

This project collects and summarizes industry research on concrete tie design and performance over the past decade into a single report. This report will serve as an educational tool for future academics, students, practitioners, and regulators.

RAILROAD IMPACT

- Collected key research findings from recent concrete tie research into a single, easy to access report for use by students and industry personnel
- Synopsis of concrete tie design and manufacturing research results from recent (post-2010) FRA research
- Quick reference document containing lessons learned and best practices for design and manufacturing of concrete ties
- Improved industry access to recent science
- Encourages improvement in safety and state of good repair in railroads

COST & SCHEDULE

- Funding: \$125,000
- Project Duration: May 2021 – November 2023

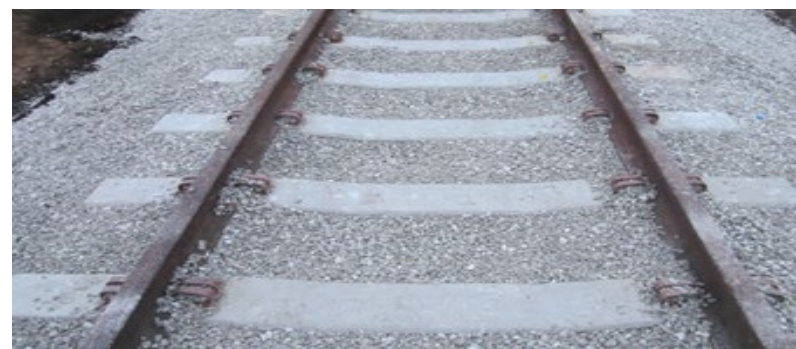
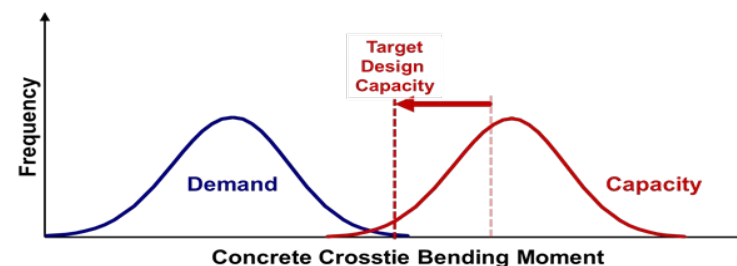

PROJECT PARTNERS

- University of Illinois at Urbana-Champaign
- Kansas State University
- University of South Carolina
- voestalpine Railway Systems Nortrak
- Vossloh AG

Autonomous Power-efficient Track Inspection System (APTIS)

PROJECT DESCRIPTION

Machine vision and artificial intelligence technologies are maturing rapidly in many industries. This project conducts research to adapt these technologies for use as an efficient, effective method to inspect track conditions. The project goal is to develop and test a modular, field-deployable system combining edge computing with advanced artificial intelligence processing to detect and classify track features from a moving platform in near real-time.



RAILROAD IMPACT

- Low cost, low power, machine vision/AI -based optical track feature detection and inspection technology
- Highly accessible and precise track inspection technology
- Encourages wide-spread adoption of automated technologies for augmenting human track inspection
- Improves rail safety through improved inspection methods

PROJECT PARTNERS

- University of South Carolina
- CFD Research Corp.
- CSX
- Florida East Coast Railway

COST & SCHEDULE

- Funding: \$599,782
- Project Duration: September 2021 – March 2026

Determining the Health of Prestressed Concrete Ties

PROJECT DESCRIPTION

- Establish a systematic evaluation process to determine if pre-tensioned concrete ties are close to reaching a failure limit state or still have a significant remaining service life.
- Focus on evaluating post-tensioned concrete ties to determine their likely failure modes and associate inspection requirements.
- Evaluate the true health of ties that have been in service for over 45 years and still appear to be in good condition.
- Document the failure modes of post-tensioned concrete ties.
- Determine the ability of post-tensioned concrete ties to withstand occasional water submersion.

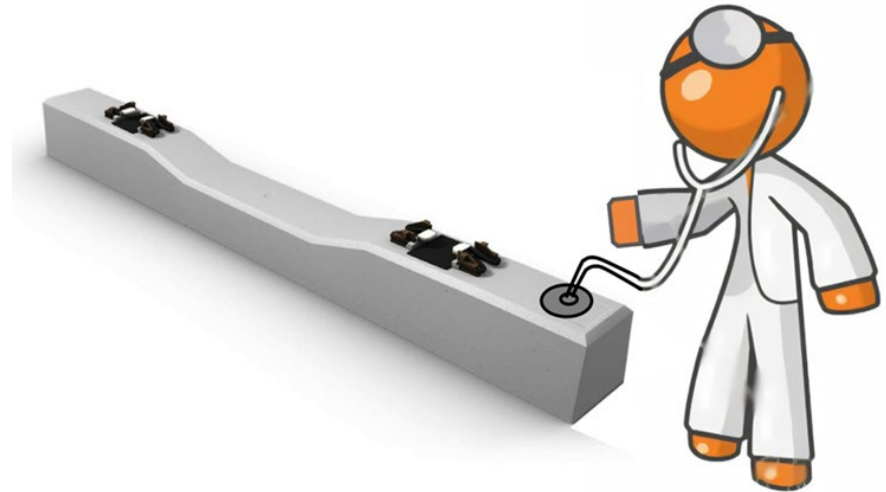

RAILROAD IMPACT

- Assessment of reserve capacity and failure modes of long service ties and new post-tensioned ties
- Increased knowledge of the remaining service life of older ties and the unique failure modes of post-tensioned tie designs
- Improved engineering and inspection methods that support rail safety and an improved state of good repair

PROJECT PARTNERS

- Kansas State University
- Amtrak
- Florida East Coast Railway

COST & SCHEDULE

- Funding: \$129,467 (Phase 1)
- Project Duration: August 2023 – August 2025

Intelligent Track Transitions Using Optical Fiber Sensors

PROJECT DESCRIPTION

- Optical fiber technologies are finding new applications in many industries for presence detection and load measurements. This project researches optical fiber sensors for continuous, automated monitoring of track, especially track transitions. This technology development effort focuses on measuring the load distribution characteristics and load-deflection behavior of track.
- Three different optical fiber sensor technologies will be implemented (FBG, LPG, and IF-P).
- Field testing at will be conducted at the FRA Transportation Technology Center.
- Data will include wheel counts, wheel load magnitudes, tie reaction forces, rail temperatures, rail deflections.

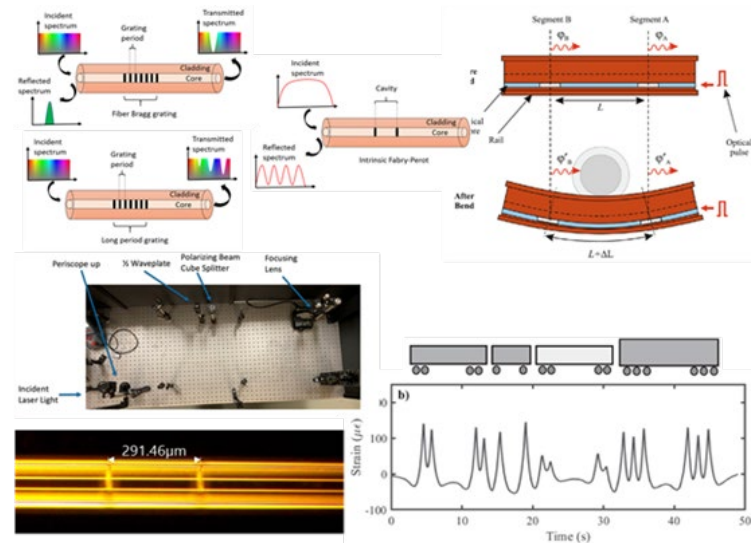

RAILROAD IMPACT

- The objective of this research is to explore the utility of fiber optic sensing technologies towards continuous monitoring of the track structure.
- Advances industry knowledge of the capabilities of new technology for track monitoring
- Encourages use of advanced technologies for long term, automated monitoring of track conditions
- Research findings will advance utilization of existing fiber-optic cable network for railroad track condition monitoring (distributed sensing).

PROJECT PARTNERS

- Oklahoma State University
- HNTB Corp.
- ENSCO, Inc.
- Amtrak
- U.S. Army COE ERDC

COST & SCHEDULE

- Funding: \$438,311 (Phases 1 and 2)
- Project Duration: September 2022 – September 2025

Impact of Type 1L Cement on Concrete Tie Properties

PROJECT DESCRIPTION

- This research aims to determine the modifications that need to be made during concrete railroad tie production when using Type 1L cement to ensure safe tie designs.
- The increased focus on sustainability and its cost effectiveness are why Type 1L has grown in popularity and is approved for use by many states.
- Laboratory tests will be conducted to evaluate changes in bond performance, splitting potential, moment capacity, and failure modes when using Type 1L cement for tie production.

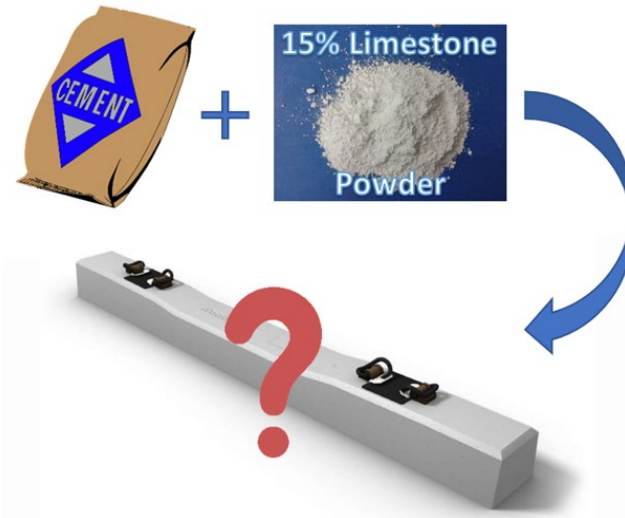

RAILROAD IMPACT

- Comparison of performance between Type 3 and Type 1L cements for concrete railroad ties
- Data documenting the bond performance of new, Type 1L cement, and mitigation measures to ensure concrete tie performance standards
- Advances state of knowledge with respect to potentially deleterious effects of Type 1L cement on concrete tie performance

PROJECT PARTNERS

- RJ Peterman and Associates
- voestalpine Railway Systems Nortrak

COST & SCHEDULE

- Funding: \$149,069
- Project Duration: August 2023 – August 2025

Fiber Optics Technology for Transportation Safety: TTC Assessment

PROJECT DESCRIPTION

- The objective of this project is to assess how the facilities and systems at the FRA Transportation Technology Center (TTC) can support the development of fiber optics systems for rail safety applications.
- Locate, identify, and assess fiber optics technology resources that currently exist within the track systems at TTC.

RAILROAD IMPACT

- Assessment of TTC fiber optics facilities for research
- Quantitative assessment of presence and condition of fiber optic cables in track sections of TTC
- Information to assess the suitability of TTC facilities to support fiber optic- based research in the track system

PROJECT PARTNERS

- ENSCO, Inc.
- AP Sensing Americas

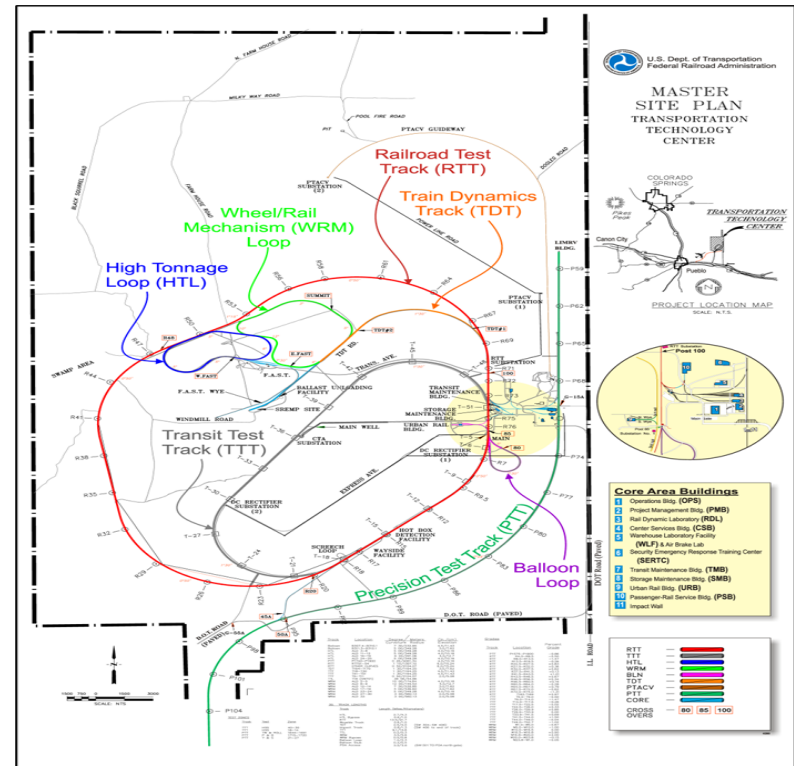

COST & SCHEDULE

- Funding: \$199,933
- Project Duration: August 2023 – August 2024

VTI Testing, Modeling, and Analyses: Development of Model Parameters

PROJECT DESCRIPTION

- Develop a general procedure for gathering parameters for the vehicles and trucks to create validated simulation models.
- Perform tests and evaluation to measure parameters needed for modeling the selected railroad vehicles.
- The first vehicle to be modeled and evaluated under this effort is a tank car.
- Utilize Rail Dynamic Lab (RDL) and different tracks at TTC to perform characterization tests and develop tank car vehicle model in VAMPIRE.

RAILROAD IMPACT

- Improve the understanding and modeling of the dynamic interaction between the train and the railroad track.
- Provide validated models of different equipment or components being used in railroad operations.
- Enable simulations to establish geometry standards, assess vehicle responses to different situations, perform derailment investigations or evaluate performance-based track geometry standards.
- Mitigate potential for derailment risk or other vehicle dynamic issues that compromise railroad safety.



PROJECT PARTNERS

- ENSCO, Inc.

COST & SCHEDULE

- Funding, FY23: Phase I – \$691,889 (Funded \$600,000)
- Funding, FY24: Phase II – \$975,083 (Option)
- Project Duration: July 2023 – June 2024

Ground Hazard Database and Warning System

PROJECT DESCRIPTION

- Create an advanced ground hazard database.
- Populate the database using trackbed surveys, remote sensing data, and various imagery, e.g., LiDAR, thermal, optical, moisture, etc.
- Real-time hazard warning system for settlement
- Final deliverables: user-friendly ground hazard database and real-time Change Detection System for ground hazards with traffic light alert levels to categorize changes on revenue service corridors

RAILROAD IMPACT

- Easier, quicker, and more reliable means for assessing ground hazards, such as slides or washouts, instead of human inspection to remote areas
- Increased safety, reliability, and revenue due to less disruption of service
- New ground hazard database to allow real-time monitoring

PROJECT PARTNERS

- University of Illinois at Urbana- Champaign
- Sixense, Inc.
- BNSF



COST & SCHEDULE

- Funding, FY21: \$485,336
- Project Duration: September 2021 – September 2024

An In-Track Apparatus to Improve Thermite Weld and Rail Integrity

PROJECT DESCRIPTION

- Extend rail life and reduce weld failures through improvements of thermite welds with higher strength and fatigue performance.
- Minimize thermite weld porosity and refine grains by mechanical vibration during weld casting.
- Develop a prototype instrumented thermite weld treatment device for in-track use.
- Perform full-scale AREMA bend weld test and tensile test.
- Determine tensile, fatigue, fracture toughness, and wear properties under laboratory conditions.
- Test in-track at Union Pacific.

RAILROAD IMPACT

- Extend rail life and improve track safety through significant enhancement of thermite weld strength and fatigue life.
- Decrease track delays and labor costs with new methods to cast thermite welds.
- Develop an FRA/AREMA suitable device for easy in-track implementation.

COST & SCHEDULE

- Funding, FY22–23: \$385,047
- Funding, FY24: \$153,405 – option
- Project Duration: September 2022 – September 2024

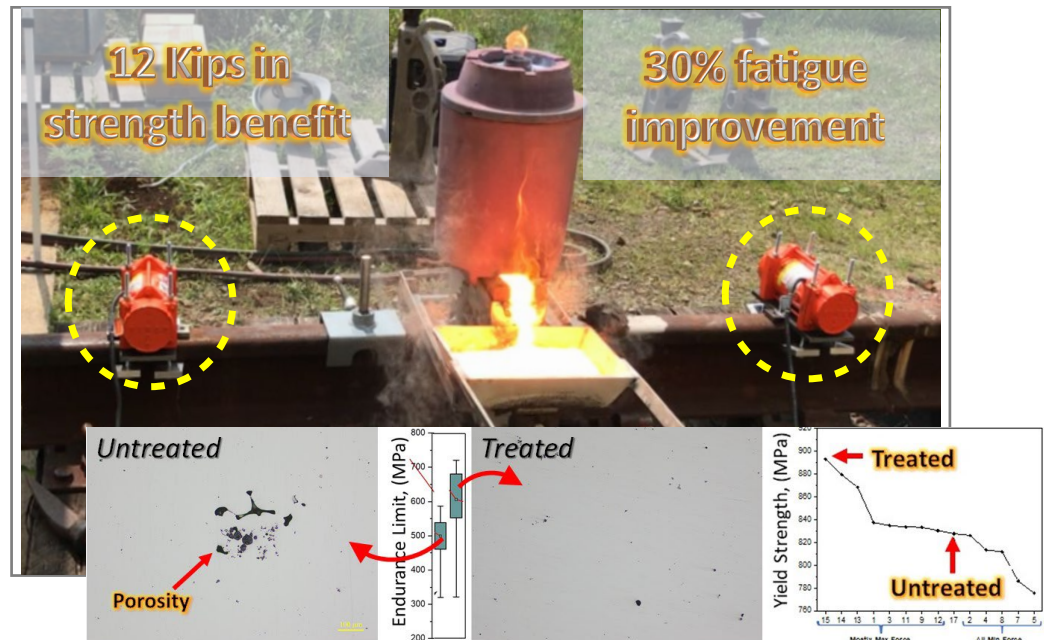

PROJECT PARTNERS

- University of Houston
- Orgo-Thermit, Inc.
- Union Pacific Railroad
- A & K Railroad Materials, Inc.

Radiographic Inspection of Rail Welds

PROJECT DESCRIPTION

- Detect and locate both voids and solid impurity defect nucleation sites within rail welds.
- Apply cutting-edge x-ray source and detector technologies.
- Research high resolution, high dynamic range, and dual energy X-ray inspection capabilities.
- Create a database of rail weld images for data-driven regulatory guidance of weld inspection.
- Create a reference design for a radiographic rail weld inspection system.

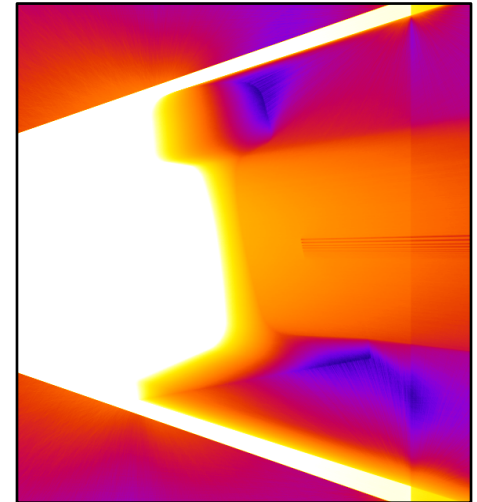

RAILROAD IMPACT

- Create a path for radiographic inspection of rail welds.
- Reduce rail weld failures and improve infrastructure by performing robust radiographic non-destructive testing on rail welds.

PROJECT PARTNERS

- University of Tennessee, Knoxville Nuclear and Radiological Engineering Department

COST & SCHEDULE

- Funding, FY22–23: \$384,816
- Project Duration: September 2022 – September 2024

Satellite Radar Imagery for Ground Hazard Risk Monitoring in Railway Track and Slopes

PROJECT DESCRIPTION

- Develop, qualify and implement an intelligent monitoring system that uses satellite radar images and AI to detect precursors to events that trigger ground hazards in the railway ROW by quantifying and monitoring soil moisture content changes and slow rate ground surface mobilization.
- Phase 1: System validation and qualification
- Phase 2: Automation and Implementation

RAILROAD

IMPACT

- Improve rail safety through the timely automated detection of failure conditions.
- Facilitate the mitigation of the ground hazard risk.
- Network-wide real-time monitoring and detection
- On-demand real-time monitoring of high-risk areas
- Accident investigation to identify possible contributing track condition changes
- Ability to integrate data with information acquired by other track sensing technologies

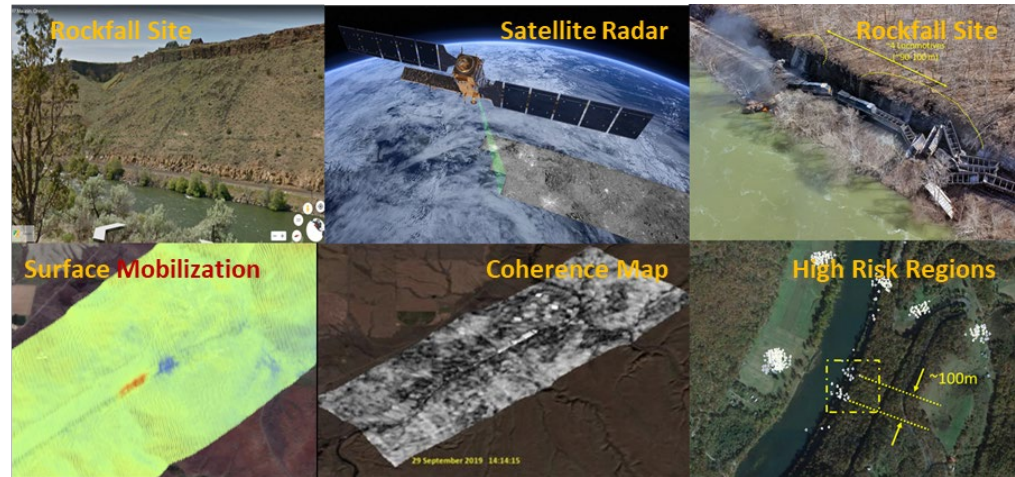

PROJECT PARTNERS

- University of South Carolina
- CSX
- BNSF

COST & SCHEDULE

- Funding, FY21: \$310, 819
- Project Duration: June 2021 – June 2024

Non-contact Detection and Evaluation of Rail Gage-face Lubricant Using Optical Sensing Methods

PROJECT DESCRIPTION

- Design and develop non-contact sensing devices that use laser-induced fluorescence to identify the state of gage-face lubrication.
- Develop an easily-deployable onboard optical system for use in revenue service.
- Determine the efficacy of the system through extensive testing, first in the lab and then in the field.
- Provide recommendations on whether the sensing devices can effectively be deployed in revenue service for gage-face lubrication detection.

RAILROAD IMPACT

- Provide a reliable solution for effectively detecting the presence and adequacy of gage-face lubricants.
- Advance maintenance of way practices and improve rail operation safety and efficiency.
- Provide cost saving by reducing wheel/rail wear and reducing derailments in curves.

Optical sensing device development

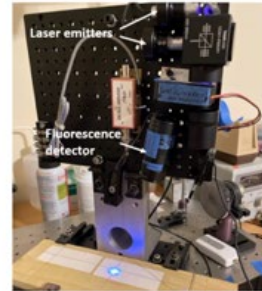

Optical sensing system in Field testing

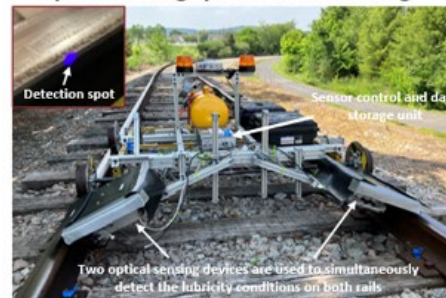

Rail-cart-mounted grease detection system

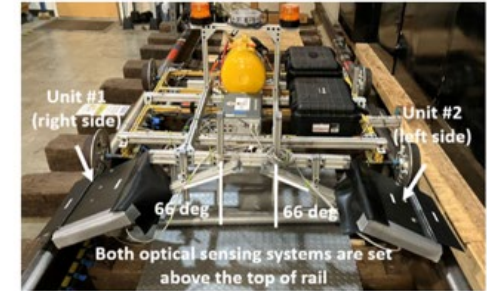

Intensity signal increases when detecting

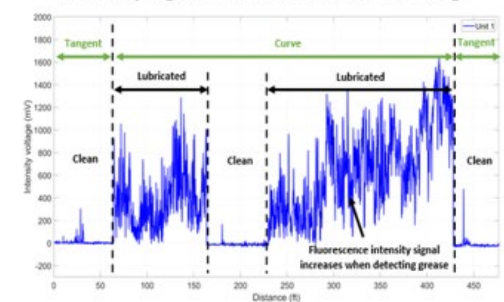

PROJECT PARTNERS

- Virginia Tech
- Norfolk Southern Railway

COST & SCHEDULE

- Funding, FY22–23: \$373,186
- Project Duration: September 2022 – September 2024

Experimental Evaluation of Wheel/Rail Contact, Third Body Layer, and Surface Finish on Risk of Derailment (Phase III)

PROJECT DESCRIPTION

- Extend the studies performed by VT/FRA in Phase I and II to provide a better understanding of the fundamentals of wheel-rail contact mechanics and dynamics.
- Evaluate additive agents that influence the wheel-rail traction by either decreasing (e.g., leaf residue and flange grease) or increasing (e.g., aluminum and iron oxides) traction for better on-demand management of motive and braking power.
- Evaluate the effect of wheel flanging on wheel-rail contact profile and pressure distribution.
- Evaluate the effect of wheel flange contact on longitudinal and lateral traction under various two-point and conformal contact conditions.

RAILROAD IMPACT

- Understanding the complex mechanics and dynamics that occur at the wheel-rail interface is critical for improving railway operational safety and efficiency.
- Scientifically evaluate additive agents that affect contact forces, traction, and wheel-rail wear, but cannot be evaluated accurately in the field due to the naturally-varied conditions.
- Provide a better understanding of wheel-rail flange contact that can significantly increase wheel-rail wear and affect railroad safety.
- Use the roller rig's test results to provide a guideline to industry practitioners for improving rail safety and cost efficiency.



PROJECT PARTNERS

- Virginia Tech
- Standard Steel, LLC

COST & SCHEDULE

- Funding FY22–23: \$499,518
- Project Duration: September 2022 – December 2024

Rolling Load Machine Research and Design

PROJECT DESCRIPTION

- Perform a literature review on best practices for rolling load machine design, both in the U.S. and abroad.
- Determine the advantages and disadvantages of the designs used and recommend the best solution for FRA.
- Provide a conceptual design for a rolling load machine to be installed at the Transportation Technology Center (TTC).
- Produce high-level drawings and a 3D CAD model to illustrate the conceptual design.
- Provide an engineering estimate for producing the final design.

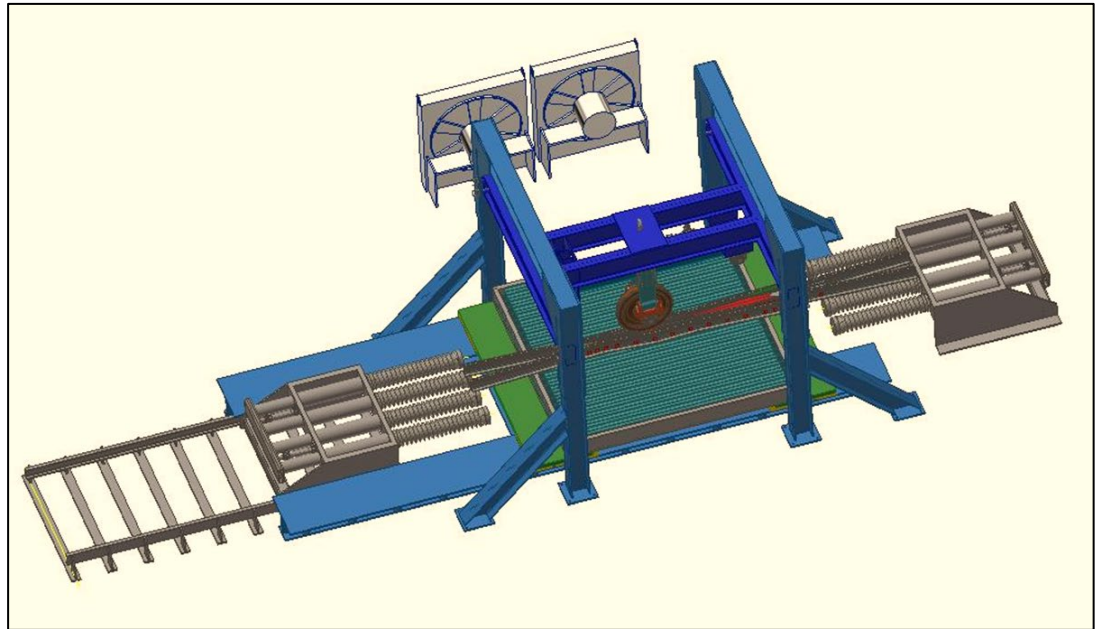

RAILROAD IMPACT

- Provide a concept design for a rolling load machine to study the degradation of special trackwork in a controlled environment with a controlled load.
- Improve track component degradation research capabilities at TTC, including testing up to 10' track sections, varying rail sizes, varying track and turnout components, and welds with adjustable loading.

PROJECT PARTNERS

- ENSCO, Inc.
- Sharma & Associates, Inc.

COST & SCHEDULE

- Funding, FY22: \$139,078
- Funding, FY24: \$750,000 (option)
- Project Duration: October 2022 – October 2025

Development of a Multi-Dimensional Track Quality Index (TQI) and Defect Risk Model in Support of Autonomous Track Geometry Inspection

PROJECT DESCRIPTION

- Develop a 3D track geometry running surface growth model based on densely gathered inspection data.
- Develop an artificial intelligence (AI) model to determine growth rate probabilities and projected time to defect development.
- Develop an AI model to determine probability of defect/exception development.
- Provide for the identification of track locations with potential for track geometry defect development with a focus on safety-related defects that could result in geometry-related derailments.
- Develop analysis algorithm(s) to create multi-dimensional TQI with time/MGT component.
- Validate the algorithms.

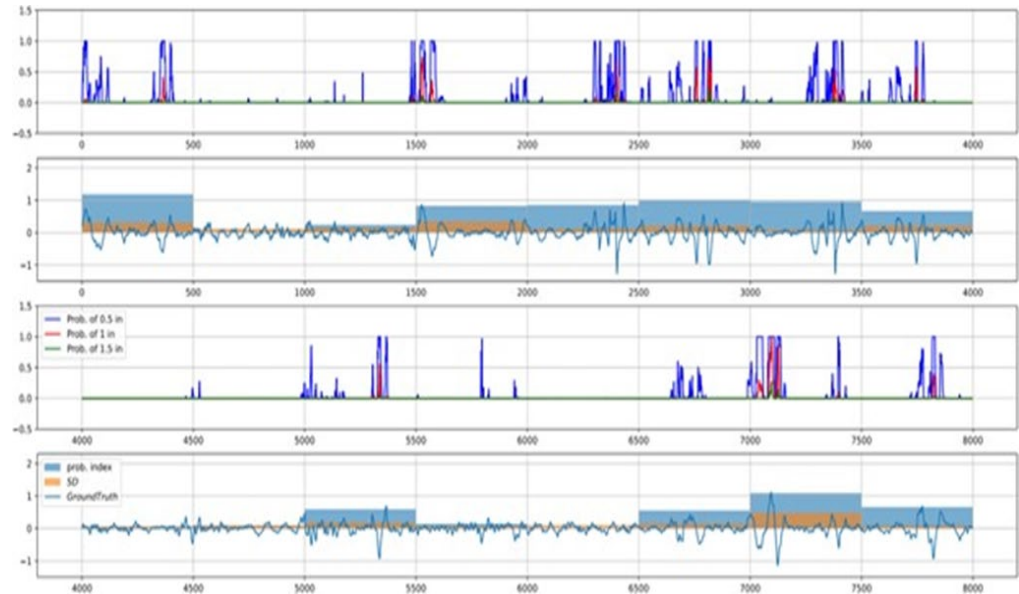

RAILROAD IMPACT

- Increased inspection car frequency and autonomous inspection vehicle data provide additional information about condition and adequacy of the track geometry.
- The ability to use this additional data to better understand degradation and defect occurrence is a valuable tool for railroads and FRA.
- Provide additional information on where high-risk track geometry defects could develop.
- Provide prioritized maintenance through new TQI.
- This work will result in the reduction of severe geometry defects and associated derailments.

PROJECT PARTNERS

- University of Delaware's Railroad Engineering and Safety Program
- Amtrak

COST & SCHEDULE

- Funding, FY20: \$238,551
- Project Duration: September 2020 – December 2023

Quantitative Assessment of the Influence of Drainage on Track Support

PROJECT DESCRIPTION

- Quantitatively study the ballast drainage characteristics under different fouling levels and fouling materials.
- Establish accurate correlations between ballast fouling conditions, drainage characteristics, and track performance.
- Examine the effectiveness of popular track maintenance methods, such as shoulder cleaning, track lifting, and undercutting.
- Develop a practical predictive model to assist in field track maintenance decision making.

RAILROAD IMPACT

- Use a practical, numerical predictive model to assist field track maintenance decision making.
- Provide guidelines for selecting the best maintenance method according to specific track conditions.
- Provide reference information to help to make cost-effective maintenance schedules.
- Assist condition-based track maintenance and improve track safety and operation efficiency.

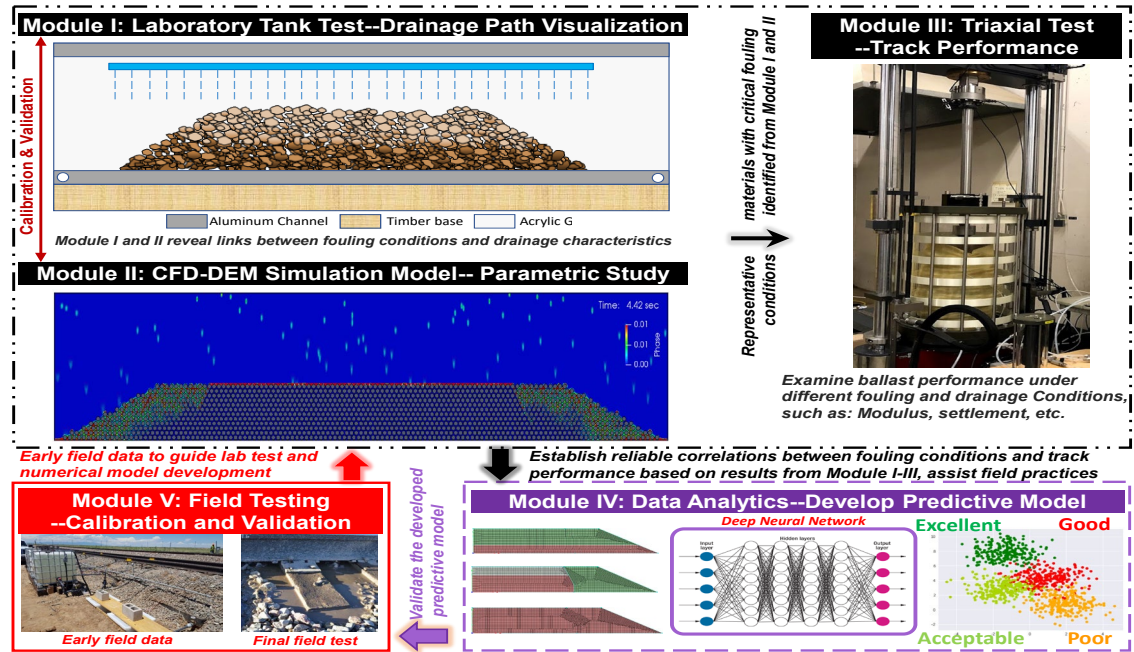

PROJECT PARTNERS

- University of South Carolina
- CSX
- TTCI
- BNSF
- Loram
- RTS Rail Transport Service GmbH
- HNTB Corp.

COST & SCHEDULE

- Funding: \$385,000
- Project Duration: August 2021 – August 2024

AI Measurements for Railroad Ballast (AIM Rail)

PROJECT DESCRIPTION

- Research and develop a low-cost, portable technology to characterize ballast fouling.
- The technology uses a smartphone app and subsurface imaging probe; ballast penetration is achieved with battery-powered rotary hammer.
- A machine learning model determines the aggregate particle size distribution and discriminates large particles, fines, and voids.

RAILROAD IMPACT

- Produce a smartphone-based, AI-powered handheld tool that can quickly, accurately, and reliably analyze and grade railway ballast aggregate in the field and is a powerful tool to increase overall safety.
- Improve the speed, accuracy and consistency of ballast assessment while eliminating the need for sieving and other processing.
- Provide a calibration and ground-truthing complement to GPR measurements.
- This work may influence industry best practices by changing the method for determining fouling and helping set thresholds, which would inform decisions on operations and the fouled ballast waiver.

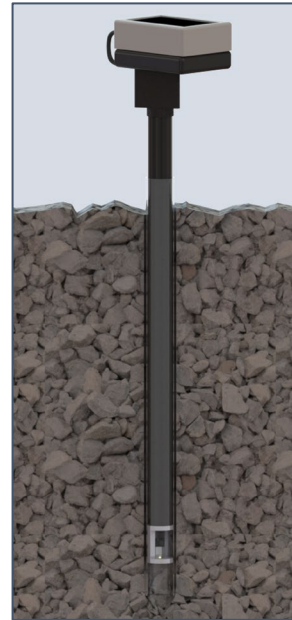

PROJECT PARTNERS

- ENSCO, Inc.
- BNSF

COST & SCHEDULE

- Funding: \$300,000
- Project Duration: July 2021 – June 2023

Development and Assessment of a Pore Water Pressure and Matric Suction Sensor: Laboratory Strength Testing and Field Substructure Monitoring

PROJECT DESCRIPTION

- Trapped and retained moisture can have varying effects on ballast strength and track deformation.
- This project will develop a system of sensors capable of measuring localized pore water pressure and matric suction to better describe the overall behavior of fouled ballast. To accomplish this, the project will:
 - Develop a laboratory pore pressure and matric suction sensor system capable of localized measurements within the specimen;
 - Modify the laboratory system for field implementation;
 - Develop a particle-based wireless sensor system capable of localized measurements of strain, particle motion, pore pressure, suction, temperature, barometric pressure, and humidity.

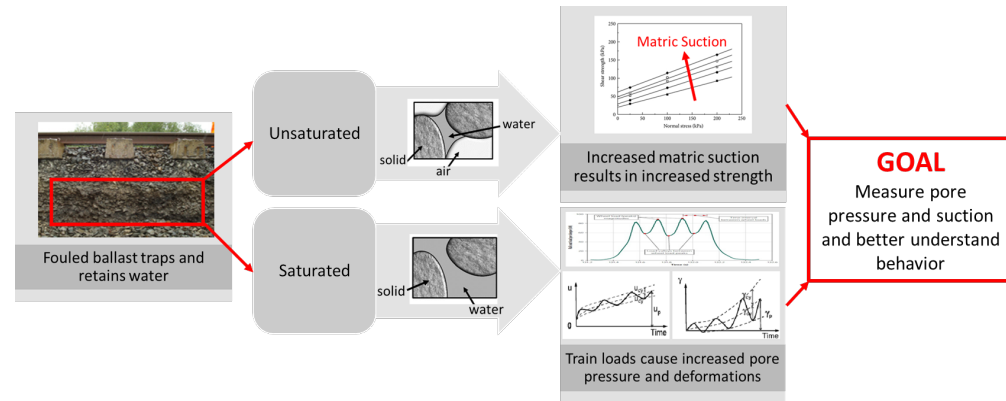

RAILROAD IMPACT

- Improves understanding of the role of pore water pressure and suction in laboratory and field conditions
- Improves understanding of ballast strength degradation with increased fouling and moisture
- Improves understanding of overall ballast behavior (i.e., strength and deformation) under train-induced loads
- Increases safety and efficiency for rail industry
- Improves nondestructive detection of fouled ballast using traditional and novel technologies

PROJECT PARTNER

- BNSF

COST & SCHEDULE

- Funding, FY22: \$104,576
 - Estimated spent to date: \$80,850
- Funding, FY23: \$100,280
- Project Duration: September 2022 – September 2024

A Mechanistic-Phenomenological Investigation of Fouled Ballast to Support In-situ Identification of Fouling

PROJECT DESCRIPTION

- Cyclic loading, wetting, and drying impact unsaturated, fouled ballast behavior in the field, yet quantification of the strength/deformation/electromagnetic response is limited. This work will:
 - Measure inter-particle friction and examine surface properties.
 - Measure cyclic mechanical response of unsaturated fouled ballast.
 - Measure hysteretic suction coupled with complex dielectric permittivity.
 - Generate a phenomenological model that couples the mechanical and electromagnetic mechanisms with the overall response.

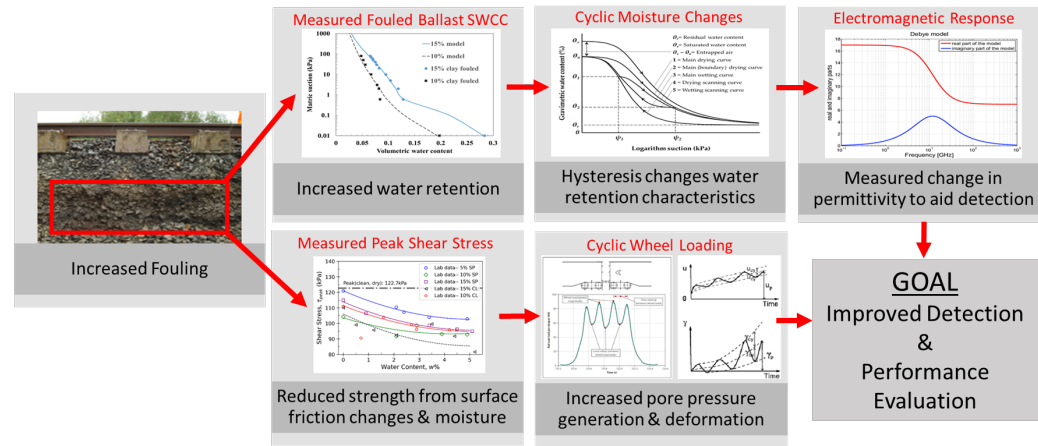

RAILROAD IMPACT

- Improves understanding of unsaturated and electromagnetic characteristics of fouled ballast, including the role of different fouling materials, water content, density, and shear strength
- Improves understanding of the cyclic response and the role of pore water pressure in the laboratory and field
- Increases safety and efficiency for the rail industry
- Improves nondestructive detection of fouled ballast using technology used by the rail industry

PROJECT PARTNERS

- BNSF
- Texas State University

COST & SCHEDULE

- Funding, FY22: \$156,686
 - Estimated spent to date: \$123,308
- Funding, FY23: \$142,888
- Project Duration: September 2022 – September 2024

Vertical Rail Deflection Measurement System Soft Spot Risk Model Applications and General System Development

PROJECT DESCRIPTION

- Expand and add functionality to the DOTX-218 MRail system.
- System software upgrades to include near real-time exceedance output.
- Investigations into alternate hardware solutions with potential implementations
- Refinements to mud spot/soft track risk model using continuously collected data and feedback

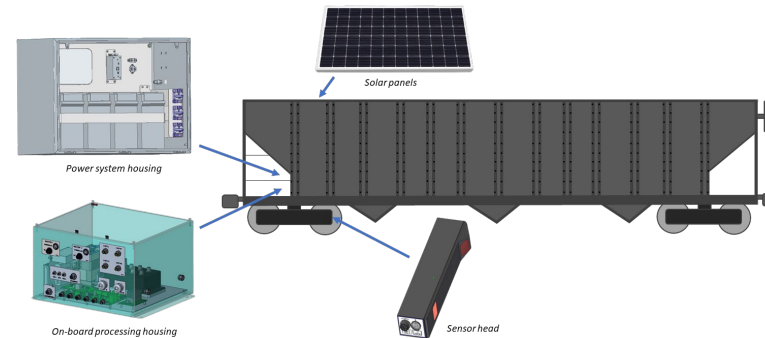

Site 2



Site 5



Site 6



Site 7

RAILROAD IMPACT

- Ability to quantify risk related to soft locations in track
- Increased safety and improved maintenance philosophies with significant economic impact
- Using risk evaluations to target maintenance at locations with more urgent vertical rail deflection profiles
- Availability of a more robust and useful inspection system

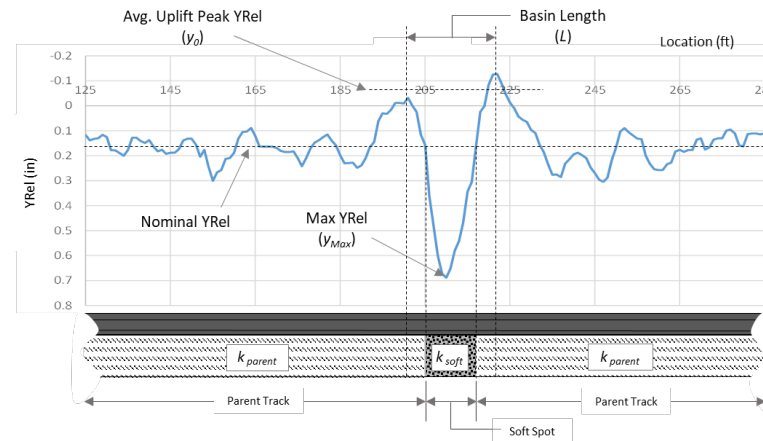

PROJECT PARTNERS

- Harsco Rail/Protran Technology
- University of Delaware
- Genesee & Wyoming, Inc.

COST & SCHEDULE

- Funding: \$150,000
- Project Duration: September 2021 — January 2023

An Integrated and Automated Decision Support System for Ground Hazard Risk Mitigation for Railways Using Remote Sensing and Traditional Condition Monitoring Data

PROJECT DESCRIPTION

- Establish a geospatial database and decision support system for railway ground hazard locations and failures.
- Develop and monitor high ground hazard segments of the rail corridor by integrating real-time environmental data, satellite, unmanned aerial vehicle (UAV), and railcar-mounted remote sensing technologies with traditional condition monitoring data.
- Use automated change detection and a smartphone-based data entry portal as a tool for incident reporting using field photographs to validate remote sensing-based ground hazards, the condition of the rail infrastructure, and the right-of-way (RoW) in high ground hazard zones.
- Ground truth the automated change detection and develop a decision support system (DSS) based on the triggering levels of ground hazard obtained from historic data.

RAILROAD IMPACT

- Geospatial database and DSS for integrating ground hazard information with traditional condition monitoring data
- Proactively locate, monitor, and mitigate ground hazard risks along the RoW.
- Enhance the safety and reliability along corridors prone to ground hazard risks.
- Reduce geohazard-based operational disruptions and safety risks through predictive evaluation and monitoring.



Decision support system currently under development

PROJECT PARTNERS

- Loram Maintenance of Way, Inc.
- BNSF
- Michigan DOT
- Wisconsin & Southern Railroad
- Michigan Technological University's Research Institute
- University of Mississippi

COST & SCHEDULE

- Funding: \$606,922 (+\$88,000 cost share)
- Project Duration: October 2021 – 2024
- Milestone 7: Mobile app for field data input (\$28,000)
- Milestone 8: Refined DSS (\$29,000)
- Milestone 9: Available ground hazard analysis system (\$96,000)

Rail Safety Improvement through Enhanced Understanding Of Ballast and Subgrade Interactions

PROJECT DESCRIPTION

- Investigate the impact of tamping on the improvement of track stability by employing SmartRocks, together with Plasser American's latest Smart Tamping Tool.
- Quantify the track stability at ballast particle level by analyzing particle movement and residual stress during and after tamping.
- Identify the effectiveness of tamping parameter in various site conditions (e.g., clean ballast condition and fouled ballast condition).
- The results of this research are expected to greatly improve rail safety by optimizing tamping strategies based on existing ballast conditions

RAILROAD IMPACT

- Optimize tamping parameters for existing ballast conditions.
- Lessen damage to the ballast particles, resulting in slower ballast degradation.
- Better compacted ballast during tamping and better ballast stability after tamping, making longer ballast service life and service interval

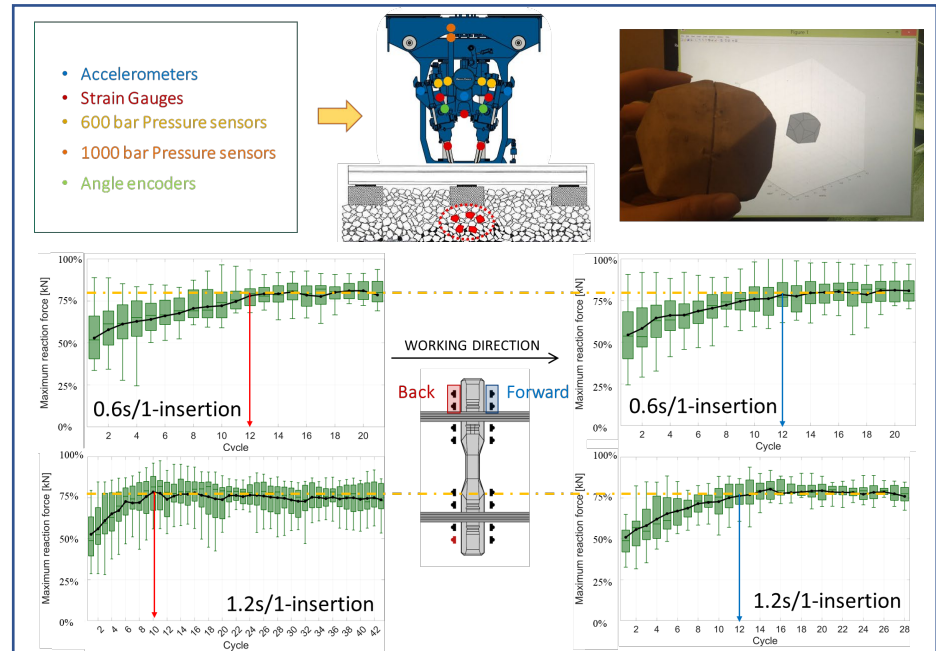

PROJECT PARTNERS

- Pennsylvania State University
- Norfolk Southern Railway
- Plasser American Corp.

COST & SCHEDULE

- Funding: \$349,538
- Project Duration: April 2021 – April 2024

Rail Bridge Strike Characterization and Evaluation Using Artificial Neural Networks

PROJECT DESCRIPTION

- Develop a system that detects rail bridge strikes, assesses their severity, and communicates information to bridge managers.
- Train machine learning algorithms to interrogate heterogeneous data streams (e.g., time histories, images/video) collected from proven instrumentation systems.
- Augment real-world datasets with finite element simulation data to increase the system's ability to localize strikes and estimate strike severity.

RAILROAD IMPACT

- Effective bridge strike detection and post-strike evaluations are critical to maximizing safe service of rail infrastructure.
- Light vehicle-bridge strikes often cause no structural damage, but still require bridge closure and inspection.
- A system that automatically assesses strike severity and provides actionable condition information promotes safe service operation on and around a bridge and increases the efficiency with which bridge managers make decisions.

COST & SCHEDULE

- Funding, FY23: \$121,347
- Project Duration: May 2020 – July 2023

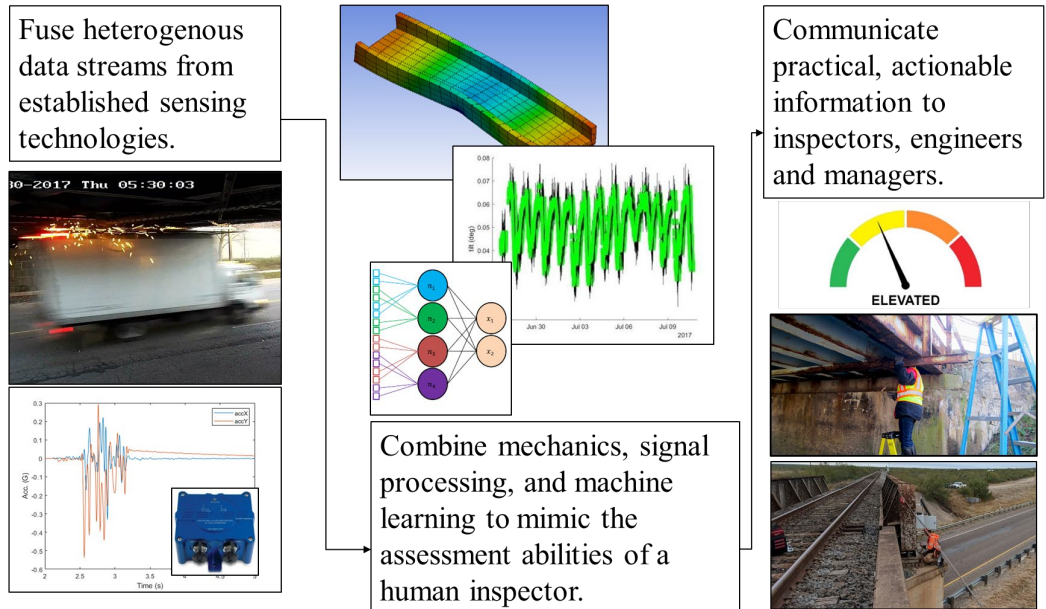

PROJECT PARTNERS

- Southern Methodist University
- SENSR Structural Monitoring Solutions
- Long Island Railroad
- Volpe National Transportation Systems Center

Ongoing Support, Improvements, and Development for the GPR System Deployed on DOTX 220

PROJECT DESCRIPTION

- Provide ongoing support and further improvement of the autonomous GPR system deployed on DOTX 220.
- Undertake a proof-of-concept study on implementing a method of identifying and reporting changes in trackbed condition at previously identified exception locations or at pre-determined waypoint triggers.
- Conduct further work on the refinement of the automatic layer picking algorithm demonstrated during the 2020-2022 contract.
- Undertake ongoing enhancements to the RASC Manager client portal, including improvements to the events map introduced in Period 1 of the 2022–2023 contract.
- Provide detailed trackbed inspection reports (TBIRs) for requested locations of interest.



RAILROAD IMPACT

- Broaden the application of GPR to characterize trackbed conditions associated with track geometry defects to contribute to quicker root cause assessment.
- Automatically monitor problem areas to assist with tracking trackbed condition change.
- Provide practical uses of technology to improve railroad safety and maintenance practices.

PROJECT PARTNERS

- Rhomberg Sersa USA, Inc.
- Zetica Rail

COST & SCHEDULE

- Funding, FY24: \$249,992
- Project Duration: July 2022 – June 2024

Support for Testing with FRA's Inspection Fleet

PROJECT DESCRIPTION

- FRA owns several inspection vehicles used for rail safety assurance and improvement under the Automated Track Inspection Program (ATIP). The Office of Research, Development, and Technology (RDT) has several systems installed on the inspection fleet vehicles used for R&D efforts.
- Efforts under this task focus on supporting the operations, maintenance, repairs, and upgrades to the RDT systems installed on the DOTX 218/DOTX 220 consist, including Vertical Rail Deflection Measurement System (VRDMS) and GPR.
- Provide engineering support for FRA RDT test efforts and new technologies with the FRA inspection fleet.
- Support the installation of FRA's new upgraded VRDMS.



RAILROAD IMPACT

- Provide research platforms to develop, improve and demonstrate track inspection technologies.
- Allow for the expansion of current track inspection capabilities throughout the railroad industry.
- Improve railroad safety and maintenance practices.

PROJECT PARTNERS

- ENSCO, Inc.
- Harsco Rail
- Zetica Rail

COST & SCHEDULE

- Funding, FY25: \$329,604
- Project Duration: August 2023 – August 2024

Innovative Track Inspection Technologies

PROJECT DESCRIPTION

- Provide support for the introduction of new track inspection approaches and the advancement of existing track inspection technologies, with a focus on data interpretation and analysis.
- Support assessment of FRA's Vertical Rail Deflection Measurement System (VRDMS).
- Develop alternative approaches to directly measure absolute vertical deflection under load.
- Provide engineering and data analysis support for the Gage Restraint Measurement System (GRMS), ground penetrating radar (GPR), VRDMS and similar track evaluation technologies.
- Investigate alternative methods to assess the tie support conditions using fiber optics and fiber Bragg grating (FBG) sensors or other means to provide an indication of non-uniform support conditions over longer segments of track.
- Support field activities for FRA track research.

RAILROAD IMPACT

- Broaden the application of innovative technologies to detect degraded track conditions.
- Improve the understanding of track behavior through characterization of various track components and parameters.
- Provide practical uses of technology to improve railroad safety and maintenance practices.



PROJECT PARTNERS

- ENSCO, Inc.
- Oklahoma State University

COST & SCHEDULE

- Funding, FY24–25: \$249,969
- Project Duration: September 2023 – September 2024

Detection of Large-scale Soil Moisture Content, Pore Water Pressure, and Matric Suction Using Electrical Resistivity Imaging Technique

PROJECT DESCRIPTION

- The project aims to improve subsurface investigation techniques by developing models that use electrical resistivity imaging (ERI) to determine the large-scale soil moisture content, pore water pressure, and matric suction of the railroad subgrade.
- The model will be developed based on lab testing and field evaluation with different moisture content and pore water pressure variation.
- The study will develop an SOP and application that use ERI to non-invasively investigate water behavior in track for railroad track maintenance professionals.
- The developed SOP will be useful for targeted track maintenance, which reduces track downtime and maintenance costs by remediating the problem at the source.

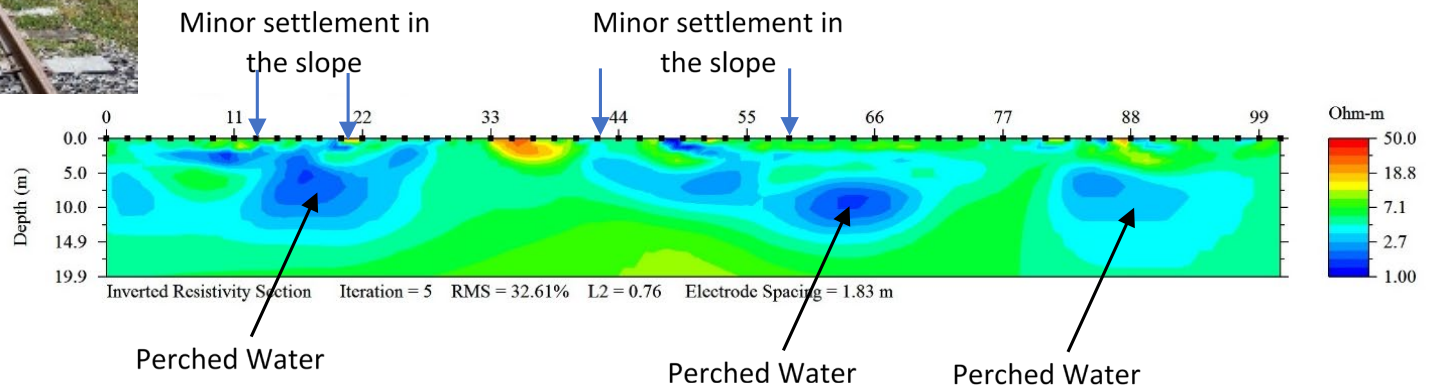

RAILROAD IMPACT

- Improve the site investigation technique for identifying large-scale moisture variability and pore water pressure within the subgrade soil.
- Possible identification of ballast pocket location and size
- Investigate a large area of the railroad embankment to identify the potential hotspots for future washout or slope failure.
- Increase track safety, improve drainage, and reduce settlement and derailment.

PROJECT PARTNERS

- Jackson State University
- USACE Engineering Research and Development Center

COST & SCHEDULE

- Funding, FY 2023: \$172,777
- Project Duration: August 2023 – August 2026

Railroad Substructure Moisture Measurement and Monitoring Using Hyperspectral Imaging

PROJECT DESCRIPTION

- Noncontact evaluation of railroad ballast to detect and measure moisture content, fouling contamination, and both aspects simultaneously.
- Hypothesis: The presence of water and contamination in a granular medium (i.e., ballast) changes its light reflectance.
- Hyperspectral sensors are used to prove the concept and to measure light reflectance in the relevant environment.
- Develop and commercialize noncontact platforms to detect and measure moisture content and fouling in ballast.

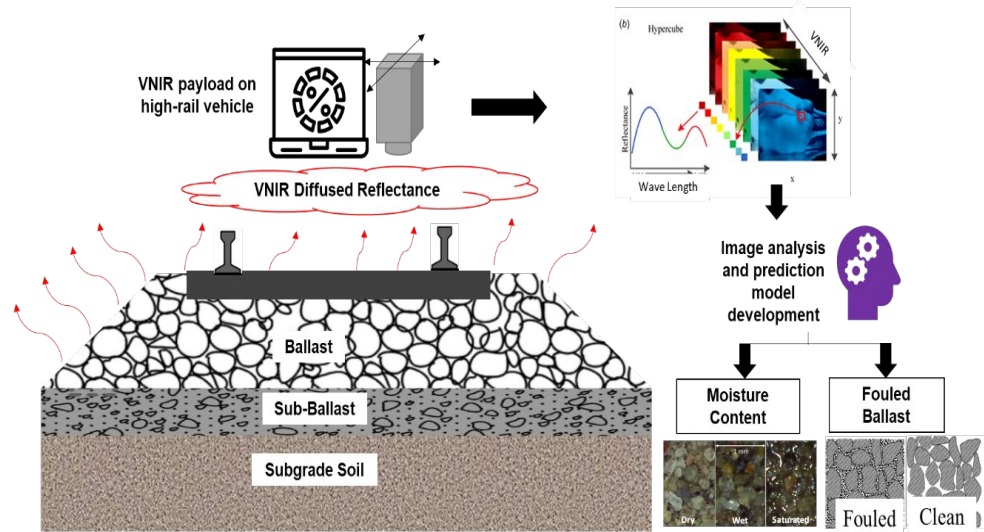

RAILROAD IMPACT

- Immediate Increased safety:
 - Noncontact sensing is safer for inspectors.
 - Increase the ability to quantify the ballast health, which will lead to increased safety of railroad operators and passengers.
- Increased efficiency and sustainability
 - Reduce the required resources.
 - Prolong the life of ballast (potentially).

PROJECT PARTNERS

- University of North Dakota (lead)
- North Dakota State University
- Red River Valley and Western Railroad

COST & SCHEDULE

- Funding, FY23: \$147,163
- Project Duration: September 2022 – September 2025

Advanced Imaging for Roadbed Condition Monitoring and Assessment

PROJECT DESCRIPTION

- Unsatisfactory tie conditions can cause track locations to become weak. Methods are needed to detect weak locations, and this equipment should be affordable, time-saving, and accurate.
- Noncontact, vision-based measurement technologies are used for rapid deployment for real-time monitoring and assessment of roadbed conditions, vertical track deflections, and rail components.
- Objective: Develop a framework that links target detectors with digital image measurement technologies for roadbed condition monitoring and assessment.

RAILROAD IMPACT

- Ability to monitor roadbed conditions in real-time
- Digital image and videos can be archived for performance history to inform digital databases for “digital twins.”
- Advanced imaging can be used to make data-driven decisions for track safety, repair, and maintenance.
- Discuss the impact of the research on rail safety, efficiency, sustainability, etc.



Source: <http://imetrum.com>



Source: https://www.up.com/media/media_kit/track-inspection/index.htm

PROJECT PARTNERS

- University of Delaware
- Amtrak

COST & SCHEDULE

- Funding, FY24: \$164,000
- Project Duration: September 2023 – August 2025

Automated Machine Vision-Based Ballast Scanning System

PROJECT DESCRIPTION

- Develop and demonstrate an implementation of a computer vision-based ballast inspection system mounted on an automated rail vehicle.
- Propose a portable and efficient method for acquiring continuous longitudinal scans and depth profiles for ballast shoulder and crib sections.
- Provide a rapid and automated inspection approach, capable of quantifying ballast condition along the track without sampling.
- Calculate percent degraded segments (PDS) from ballast field images and link these values to Selig's Fouling Index (FI).
- Determine particle size distribution (PSD) from ballast field images.
- Develop I-BALLAST software to perform data pre-processing, image segmentation, and visualization.
- Years 1 & 2: Design and test mobile ballast scanning vehicle (BSV).
- Year 3: Final development and validation of the BSV on railroad partner tracks.
- Deliverables: (1) Final Report; (2) analysis algorithm; (3) BSV with all accessories

RAILROAD IMPACT

- Real-time (or near real-time) detection and/or prediction of track-related issues using innovative Artificial Intelligence (AI) technologies (user-independent)
- Automated, consistent, and objective imaging-based evaluation of ballast condition
- Inspection results can be paired with GPR and track settlement data to establish correlations and provide ground truth.
- Effective ballast management strategies can be developed based on results.
- Rail network safety and reliability will be improved.

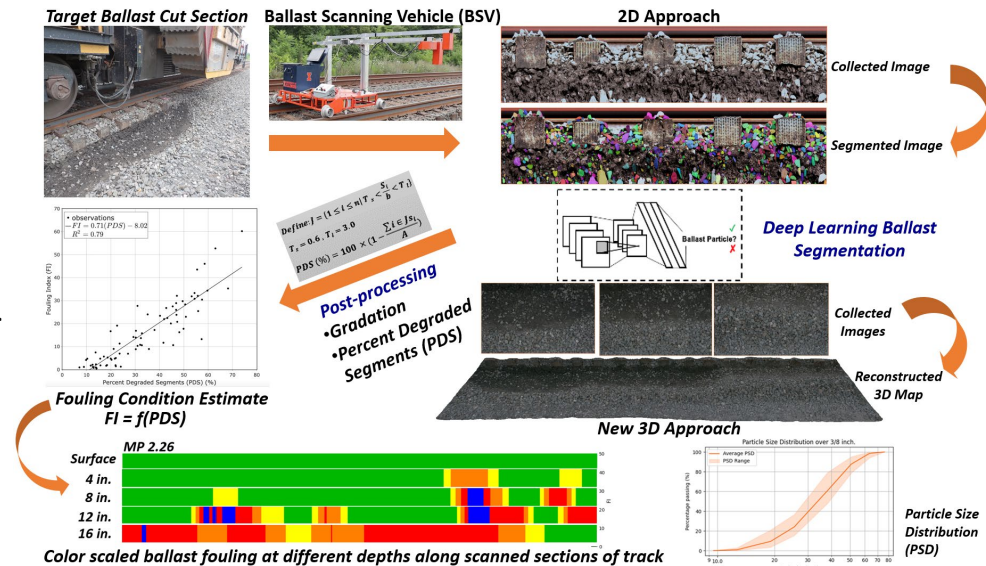

PROJECT PARTNERS

- Loram Maintenance of Way, Inc.
- BNSF
- Canadian National Railway
- Amtrak

COST & SCHEDULE

- Funding: \$398,694
- Project Duration: Sept. 2020 – June 2023

Machine Learning-based Analysis of the Need for Railway Track Maintenance

PROJECT DESCRIPTION

- The effect of drainage quality, ballast fouling index, previous geometry data, and MGT on track degradation rate will be investigated using large datasets.
- Four machine learning-based methods, namely, Random Forest (RF), XGBoost, Artificial Neural Network (ANN), and Support Vector Machine (SVM) will be employed to predict the mileage of geometry defects.
- A test dataset from track will be used to check the accuracy of proposed models.

RAILROAD IMPACT

- Improve the track performance as geometry defects are predicted and maintained before they surpass certain thresholds.
- Valuable information regarding effect of drainage quality on track degradation rate will be provided, which helps in making key decisions regarding maintaining or improving the drainage to decrease track degradation rate.
- The carbon footprint associated with track maintenance operations will be reduced, as maintenance is only conducted on sections that have high-risk derailment and require maintenance operation.

COST & SCHEDULE

- Funding, FY22–24: \$315,623
- Project Duration: July 2022 – July 2024

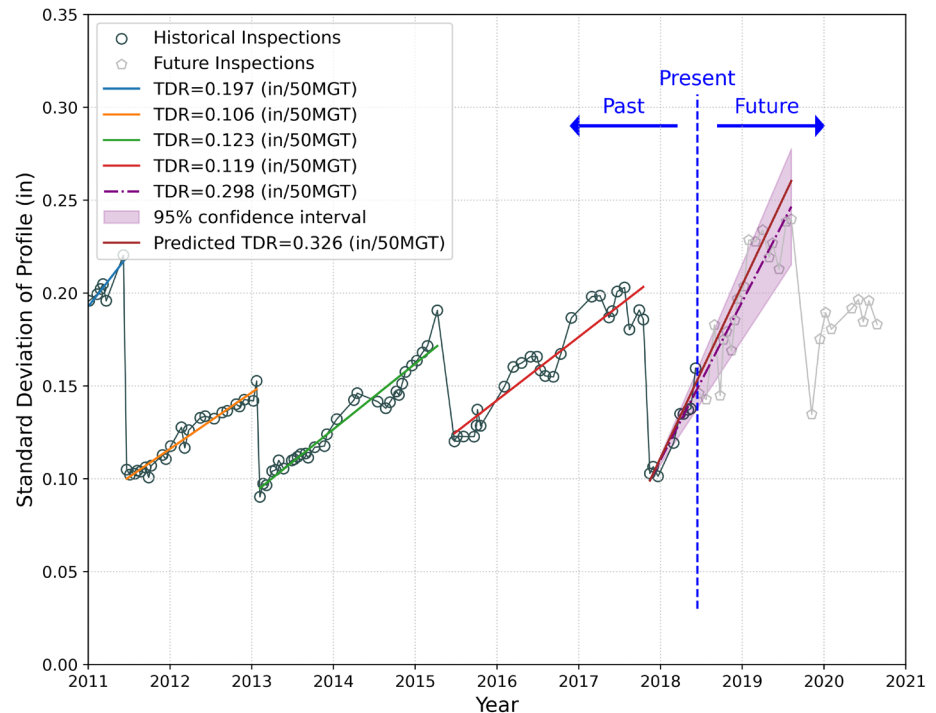

PROJECT PARTNERS

- UMass-Amherst
- Loram Technologies, Inc. HNTB Corp

Physics-based Predictive Modeling of Rail Failures Due to Internal Defects

PROJECT DESCRIPTION

- Develop an artificial intelligence-based predictive model of rail failures based on internal defect growth to enhance proactive maintenance strategies.
- Apply fracture mechanics modeling to determine regressor strengths.
- Integrate both physical contributors and external factors to forecast time to rail failure for a known defect size.
- Develop a plan for implementing the resulting predictive model as an additional component within the FRA's CWR-Risk software application.

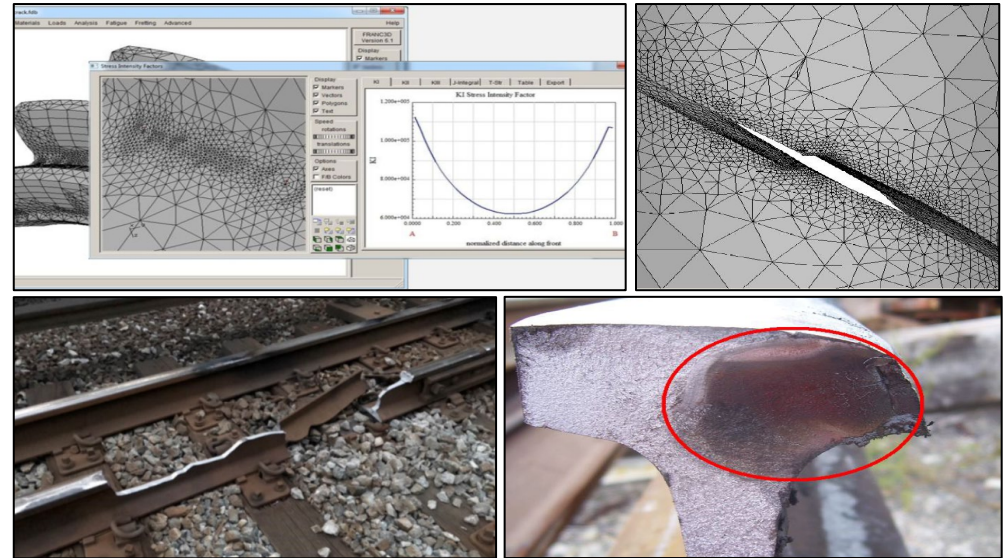

RAILROAD IMPACT

- Effectively minimize the occurrence of service failures on the nation's rail network.
- Improve continuously welded rail management practices and enable more effective maintenance and capital planning.
- Provide a valuable tool to aid in future rail integrity rulemaking processes.

PROJECT PARTNERS

- ENSCO, Inc.
- Canadian Pacific Railway

COST & SCHEDULE

- Funding: \$354,531
- Project Duration: September 2022 – March 2024

Real-time Defect Characterization and Physics-based Remaining Life Prediction

PROJECT DESCRIPTION

- Develop a framework for real-time rail internal defect characterization and prediction of the remaining useful life of the rail. This entails:
 - Machine learning-based algorithms to automatically process ultrasonic A-scan data from inspection vehicles
 - A physics-based (i.e., fracture mechanics) analysis for the remaining useful life of the rail based on the current state of the internal defect
- Build upon previous FRA-funded efforts in rail internal defect modeling and simulation.
- Focus on transverse rail defects, which account for a large percentage of defects found in revenue service.

RAILROAD IMPACT

- Detect transverse defects in real time and characterize at track inspection speeds.
- Reduce human intervention and, in turn, improve overall efficiency and accuracy of transverse defect detection and characterization.
- Identify and prioritize repair of safety-critical defects to prevent rail-related failures and, in turn, derailments on the nation's railways.

Phased Array Ultrasonic Testing:
A-scan data generation



AI-based A-scan data processing: defect
detection and characterization

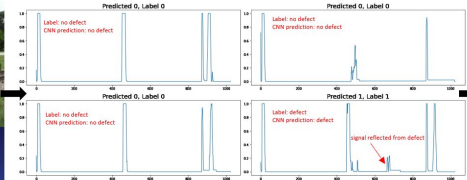

Physics-Based
Predictive Analytics

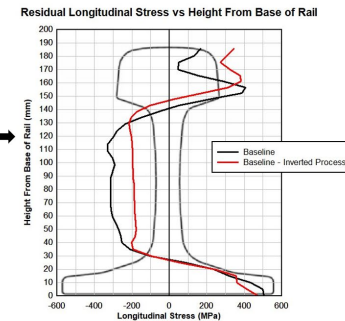

PROJECT PARTNERS

- Thornton Tomasetti
- Sperry Rail Service
- David Jeong, Ph.D. (Independent Consultant)
- University of Utah

COST & SCHEDULE

- Funding: \$475,003
- Project Duration: September 2022 – September 2024

Deep Learning for Large-scale Rail Defect Inspection

PROJECT DESCRIPTION

- Develop a fully automated framework for rail surface defect classification based on deep-learning techniques.
- Use existing rail imagery to build a generative model to synthesize realistic surface defects in the absence of sufficient training images.
- Evaluate the resultant framework in a large-scale field evaluation in conjunction with industry partners.
- Develop a proof-of-concept application for railroad truck-scanning defects to demonstrate generality of resultant methodology.

RAILROAD IMPACT

- Reduce surface-generated rail failures, thereby increasing overall safety for both passenger and freight systems.
- Support unbiased and more comprehensive rail maintenance planning programs, leading to improved rail life and reduction in network disruptions due to maintenance.
- Reduce data annotation costs (up to 5 percent of manual annotation) for novel intelligence-based monitoring applications.
- Translate the framework for other railway component monitoring, both in track and on rolling stock.

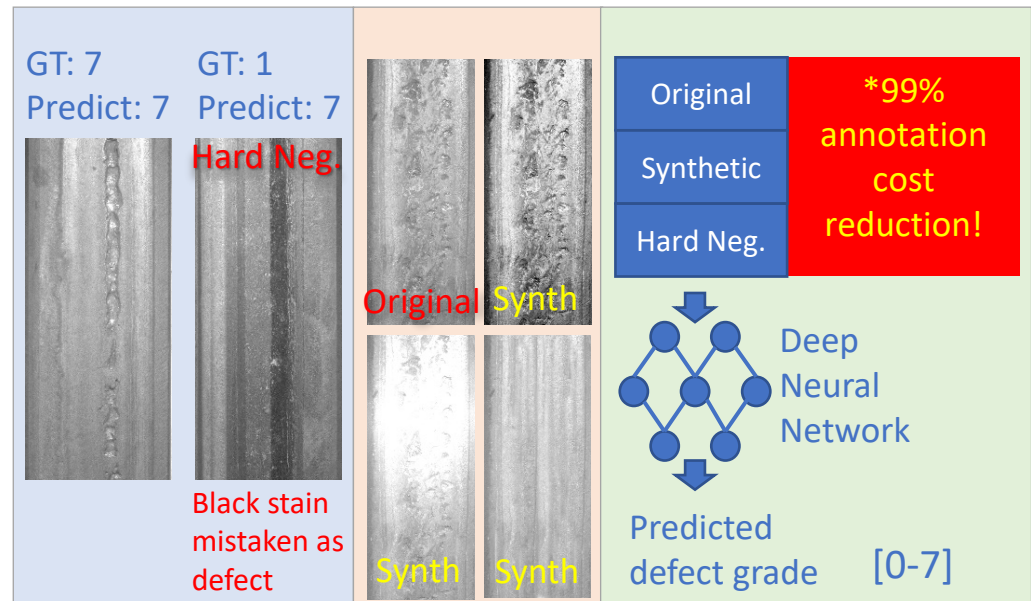

PROJECT PARTNERS

- SUNY at Stony Brook
- KLD Labs, Inc.
- CSX

COST & SCHEDULE

- Funding: \$458,824
- Project Duration: September 2021 – September 2024

Implementation of Advanced Track Geometry Forecasting Models

PROJECT DESCRIPTION

- Implement advanced analytical approaches for forecasting foot-by-foot track geometry in a revenue service environment.
- Improve the effectiveness and applicability of the previously-developed track geometry filtering algorithms for use in real-time predictive analytics applications.
- Improve and adapt previously researched foot-by-foot track geometry forecasting methods for deployment in a real-world operational application.
- Deploy the advanced forecasting methods in an automated fashion with the operating railroad's autonomous track geometry measurement fleet.

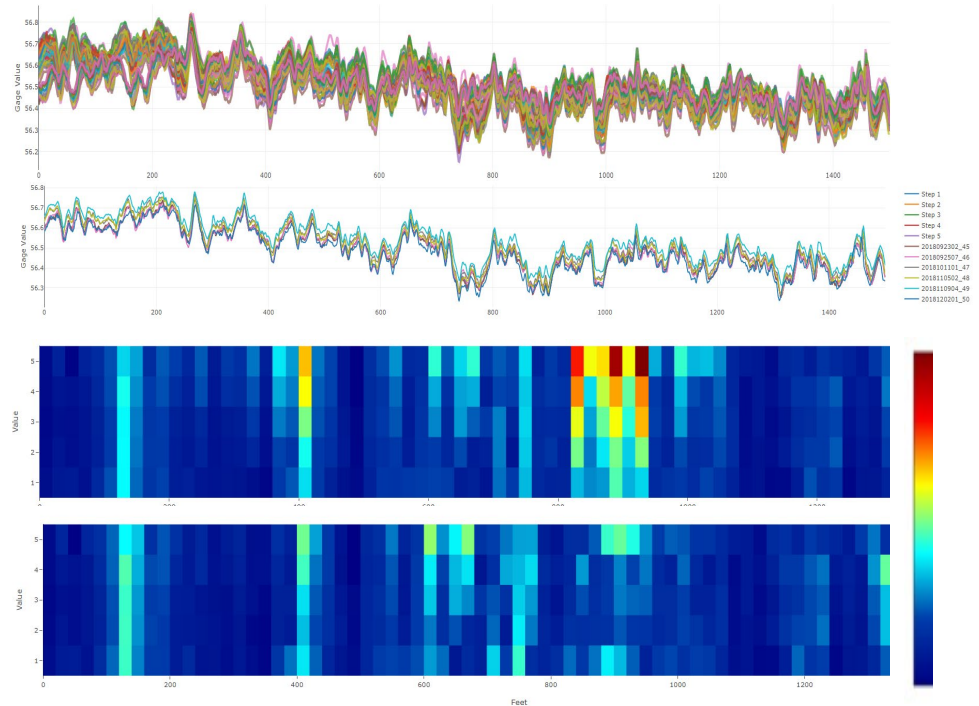

RAILROAD IMPACT

- Provide the industry with tools for long-term insight into the future behavior of track geometry to facilitate effective preventive maintenance.
- Improve the data quality of track geometry measurements used for predictive analytics.
- Further advance the application of autonomous track geometry measurement systems through integration with advanced predictive analytics applications.

PROJECT PARTNERS

- ENSCO, Inc.
- Canadian Pacific Railway

COST & SCHEDULE

- Funding: \$365,825
- Project Duration: July 2022 – July 2024

Field Testing Support at FRA's Transportation Technology Center (TTC)

PROJECT DESCRIPTION

- Provide multiple university- and third party-led research initiatives with on-site testing services and equipment at TTC to support technology evaluation in a real-world setting.
- Recent activities under this task include:
 - Field evaluation of new ballast fouling measurement methods
 - Field validation of machine-vision algorithms designed to detect defective or missing track fasteners.
 - Support instrumented testing of rolling stock to investigate in-train forces of very long trains in revenue service.
- Upcoming testing activities include:
 - In-track testing of a new and innovative system to detect air leaks in a passing train's braking system
 - Laboratory characterization of primary and secondary spring sets for vehicle-qualification modeling



RAILROAD IMPACT

- Provide support for controlled testing of new and emerging technologies at TTC, including opportunities for evaluation in a real-world environment.
- Develop critical prototype hardware/software for advanced rail inspection technology.
- Focus on developing and evaluating advanced inspection technologies under revenue service-like conditions.
- Support field testing efforts for FRA R&D tasks.

PROJECT PARTNERS

- ENSCO, Inc.
- Northern Plains Railroad Services
- Volpe National Transportation Systems Center

COST & SCHEDULE

- Funding: \$298,924
- Project Duration: October 2022 – September 2025

Intelligent Risk Assessment and Prediction System (i-RAPS)

PROJECT DESCRIPTION

- Develop an intelligent Risk Assessment and Prediction System (i-RAPS) framework that will integrate adaptive sampling and data-driven modeling for derailment risk prediction.
- Process large volumes of track inspection data to parameterize the condition of the track system.
- Develop and utilize finite element modeling for parametrized tracks to extract track signatures.
- Simulate complex vehicle/truck interactions using fast-coupling algorithms for different combinations of track signatures and rail vehicles.

RAILROAD IMPACT

- Revolutionize the inspection and risk assessment of North American railway track by proposing the “track genome” method.
- Quantify the track conditions with a single overall risk index to unify risk management and decision making.
- Effectively utilize the vast amount of track inspection data and identify the sensitive and critical track components state changes.
- Quantify the deterioration rate and “limit state” of track components for different track sections to facilitate condition-based and “track-dependent” maintenance.

COST & SCHEDULE

- Funding: \$395,000
- Project Duration: June 2020 – December 2023

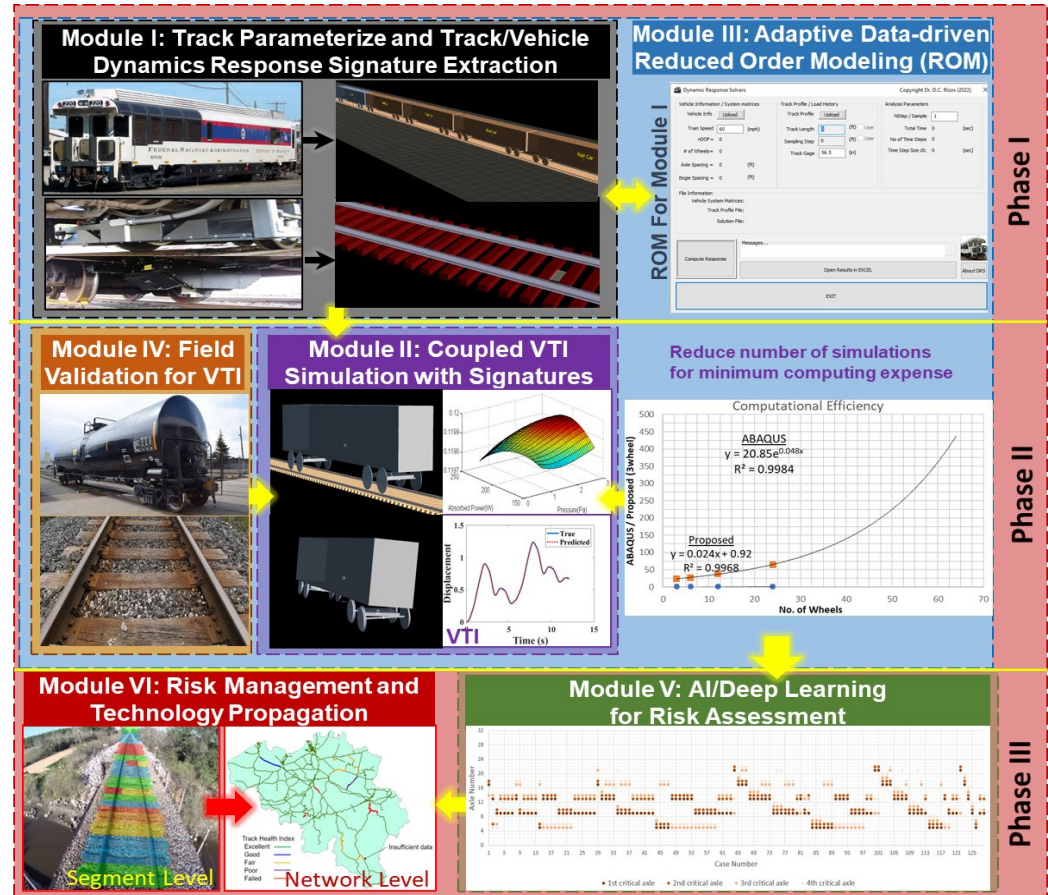

PROJECT PARTNERS

- University of South Carolina
- CSX Transportation
- ENSCO, Inc.

Advancement of Continuous Welded Rail Management

PROJECT DESCRIPTION

- Provide world-class track buckling research facilities to support FRA's Office of Railroad Safety and industry researchers.
- Provide a well-diversified research portfolio to advance longitudinal rail force technologies and their management.
- Develop a conceptual plan for a realistic rail neutral temperature (RNT) test bed to facilitate all types of RNT testing at FRA's Transportation Technology Center (TTC).
- Provide continuous in-situ RNT monitoring at selected locations at TTC.
- Support third-party RNT-related testing at TTC.
- Investigate rail break mechanics in sharp curves and the effect of curve movement on RNT.



RAILROAD IMPACT

- Increase track buckling safety through improved CWR management practices.
- Provide more accurate input and parameters for rail break theory implementations.
- Provide RNT testing capabilities to attract researchers, industry professionals, and universities nationwide.
- Support the development of measurement equipment for rail longitudinal force in a realistic environment.

PROJECT PARTNERS

- ENSCO, Inc.
- Kandrew, Inc.

COST & SCHEDULE

- Funding: \$353,705
- Project Duration: October 2022 – December 2024

Development of Low-Cost Rail Stress and Rail Neutral Temperature Management Technology

PROJECT DESCRIPTION

- Develop a prototype low-cost rail stress and rail neutral temperature (RNT) management technology (RSMT) consisting of a disposable measurement coupon bonded to the rail and a hand-held data reader.
- Design a low-power circuit board for sensor integration and communication.
- Perform testing in a laboratory setting.
- Develop improved bonding methods.
- Fabricate prototype and conduct long-term field testing under controlled conditions.

RAILROAD IMPACT

- Develop a new technology to monitor critical locations for excessive rail force and improve safety by preventing track buckle derailments.
- Provides direct knowledge of RNT profiles, enabling maintainers to perform and document rail adjustments in all scenarios.
- Improves the accuracy of rail destressing and RNT management.
- Enhances quality control for panel installations, joint removals, and crossing renewals.
- Allows monitoring of RNT changes in curves.
- Supports research and advancement of rail break theory by enabling feasible field experiments in revenue service.

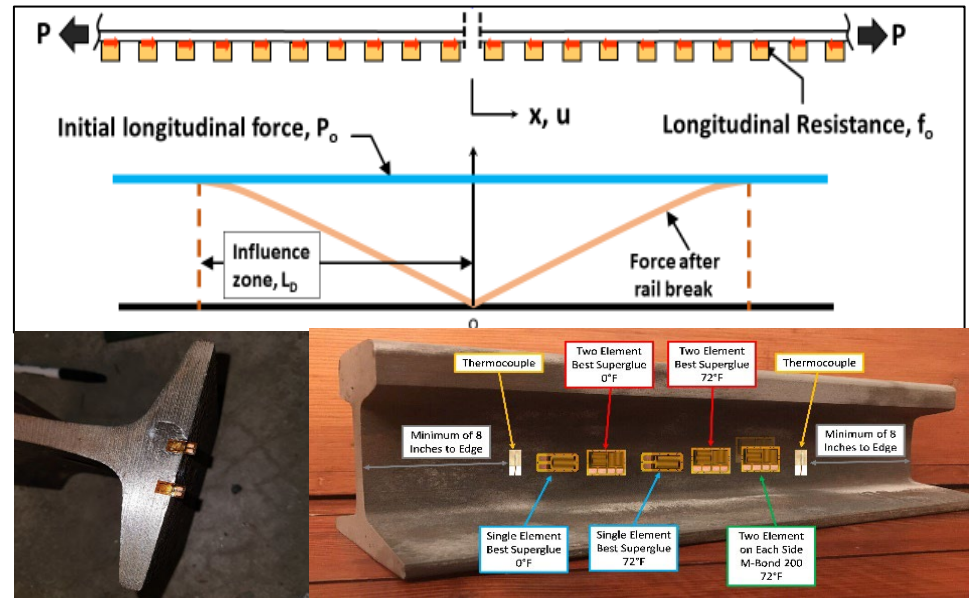

PROJECT PARTNERS

- ENSCO, Inc.
- Kandrew, Inc.
- Instrumentation Services, Inc.

COST & SCHEDULE

- Funding: \$386,467
- Project Duration: August 2022 – February 2025

Rail Force Management Technology Implementation and Transfer

PROJECT DESCRIPTION

- Consolidate current understandings of track buckle prevention into accessible software.
- Host, maintain, and improve rail force management software packages (CWR SAFE, RNT Restore, Rail Temperature and Buckling Application)
- Implement rail stress adjustment methodology for special cases into RNT Restore.
- Develop and implement a roadmap for rail force management software transfer to hosting by FRA.
- Convert CWR-SAFE core modules from FORTRAN to modern programming language.
- Support for rail force management software applications, including user documentation and training webinars.

RAILROAD IMPACT

- Improve safety through the prevention of track buckle derailments.
- Provide the industry and academia with a set of new and upgraded rail force management applications on a centralized platform that can assist with CWR management, guidance development, and future research.
- Establish better awareness of proper rail stress management methodologies and tools for field personnel.
- Create a platform to disseminate FRA research results in longitudinal rail stress and CWR management to industry, academia, and regulators.



PROJECT PARTNERS

- ENSCO, Inc.
- Kandrew, Inc.

COST & SCHEDULE

- Funding: \$819,967
- Project Duration: September 2020 – December 2024

Technical Support for FRA Office of Railroad Safety

PROJECT DESCRIPTION

- Assist the FRA Office of Research, Development, and Technology in conducting tests, detailed analyses, and technical reviews on behalf of the Office of Railroad Safety (RRS) to ensure the safety of the U.S. railroad network.
- Efforts include analyses to ensure appropriate and justifiable regulations and support for improvements in railway infrastructure, passenger safety, and freight accident prevention.
- Provide support and training for safety-related issues, including continuous welded rail (CWR) maintenance practices.

RAILROAD IMPACT

- Improve safety by providing RRS with the required technical support.
- The task provides for quick response instrumentation, testing, and analysis support to resolve safety-related problems and emergencies, determine causal factors, and reduce future problems.
- Support data gathering for high speed/high cant deficiency qualification and revise safety standards reflecting sound science and engineering expertise.
- Facilitate ongoing technical evaluation required to demonstrate and deploy new technologies for improved safety and operational efficiency.
- Training material for CWR management developed under this task will serve as a resource for the rail industry.



PROJECT PARTNERS

- ENSCO, Inc.
- Kandrew Inc.

COST & SCHEDULE

- Funding: \$299,946
- Project Duration: March 2023 – December 2024

Investigation of the Effects of Frozen Ballast on Rail Neutral Temperature Loss and Remediation

PROJECT DESCRIPTION

- Investigate rail neutral temperature (RNT) behavior in frozen ballast conditions.
- Broaden the applicability of current rail break mechanics by determining the values of longitudinal rail restraint in frozen ballast conditions.
- Conduct laboratory testing to determine parameters that quantify the capacity for frozen ballast.
- Update previously developed FRA 3D track model to account for frozen ballast conditions.
- Propose new recommended practices aimed at improving RNT management.

RAILROAD IMPACT

- Decrease the risk of track buckle derailments caused by improper RNT adjustments where frozen ballast is present.
- Properly consider frozen ballast conditions to further develop countermeasures to prevent and mitigate the potential for derailments in cold-weather regions.
- Implement new remediation strategies and RNT adjustment recommendations that account for the effects of frozen ballast and that can be incorporated into existing RNT management plans.
- Improve understating of rail break mechanics in cold weather conditions.

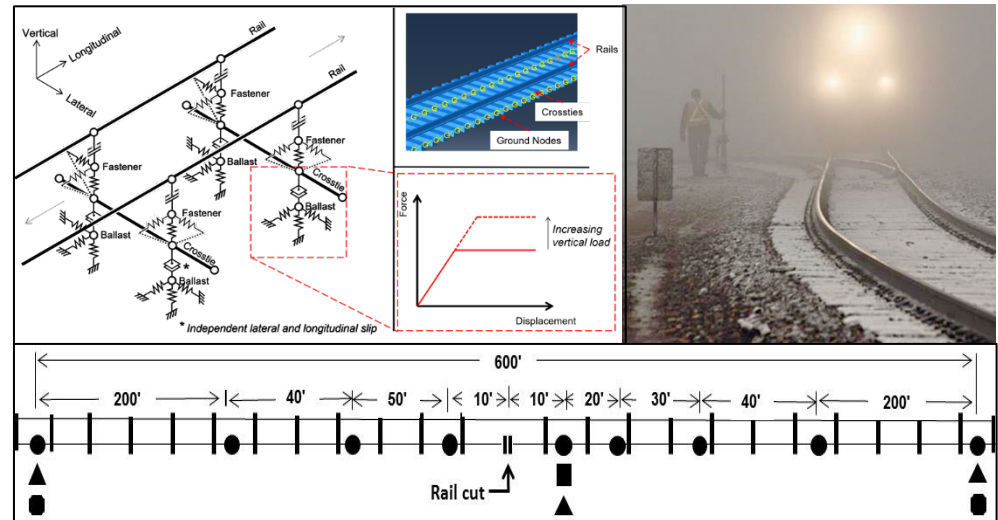

PROJECT PARTNERS

- ENSCO, Inc.
- University of Illinois at Urbana-Champaign
- Kandrew, Inc.
- National Research Council Canada

COST & SCHEDULE

- Funding, FY24 – Phase I: \$249,960
 - Phase I Duration: August 2023 – June 2024
- Funding, FY25 – Phase II: \$249,998 (Optional)

Parameters Influencing Track Longitudinal Stiffness and Its Implications for Rail Adjustment Procedures

PROJECT DESCRIPTION

- Provide a quantitative assessment of variables influencing axial stress influence zones and guide future rail stress adjustment practices.
- Laboratory Experimentation: Quantify and control fastener and ballast stiffness (to be conducted at University of Illinois.)
- Finite Element Modeling: Develop and advance model that is properly validated based on lab and field data collected in this project.
- Field Experimentation: Quantify the impact of various parameters on longitudinal resistance to augment existing research on partner railroads.

Phase 1
Phases 2 & 3

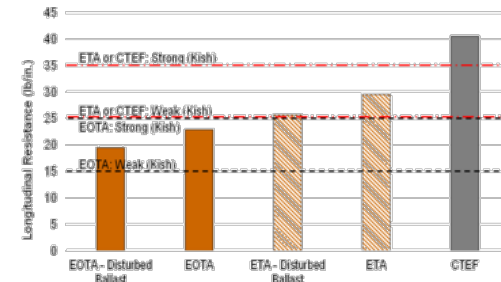
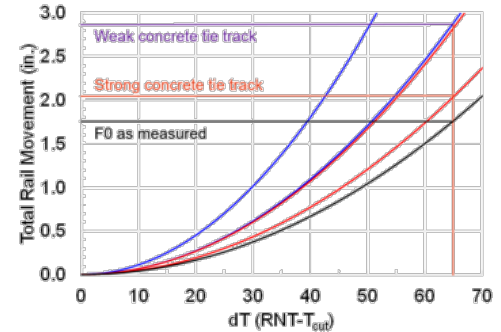
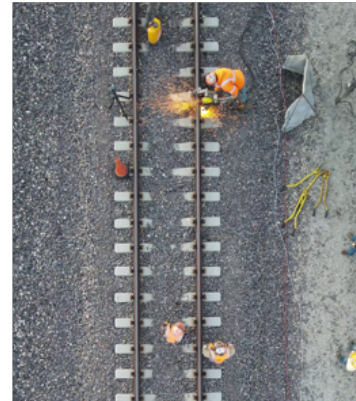

RAILROAD IMPACT

- Improve safety through the prevention of track buckle derailments.
- Improve rail integrity and maintenance guidance for unclipping rail during rail destressing.
- Improve understanding of long rail stress transfer and its influence on changes in rail neutral temperature (RNT) as a function of time/tonnage.
- Improved quantification of how rail gap size and influence zone are influenced by:
 - Fastening system characteristics
 - Rail tension/compression
 - Ballast (track) longitudinal stiffness

PROJECT PARTNERS

- University of Illinois at Urbana-Champaign
- Amtrak
- BNSF
- Union Pacific Railroad
- Kandre Consulting, Inc.

COST & SCHEDULE

- Funding: \$610,000
- Project Duration: September 2020 – September 2024

Rail Neutral Temperature Estimation Using Local Rail Vibration Measurements and Machine Learning

PROJECT DESCRIPTION

- Develop and evaluate a system to measure (non-destructively) rail neutral temperature (RNT) of in-place continuous welded rail (CWR) to an accuracy of $\pm 10^{\circ}\text{F}$.
- Collect local rail vibration data from two different instrumented revenue-service rail test sites.
- Study fundamental relationships between local rail vibration data and RNT, rail temperature, longitudinal load, rail structure, and support conditions.
- Develop data-driven and machine learning algorithms to determine RNT in situ without reference measurements, disruption to traffic, or modification to track structure.
- Perform technology evaluation with unfamiliar data.

RAILROAD IMPACT

- Improve track safety and reliability by minimizing the risks of track buckling through technology that:
- Predicts in-place RNT with an accuracy of $\pm 10^{\circ}\text{F}$
- Does not disrupt or modify track structure
- Does not require baseline reference data
- Is insensitive to support condition, temperature, and residual stress variations
- Is applicable to all rail and train traffic conditions

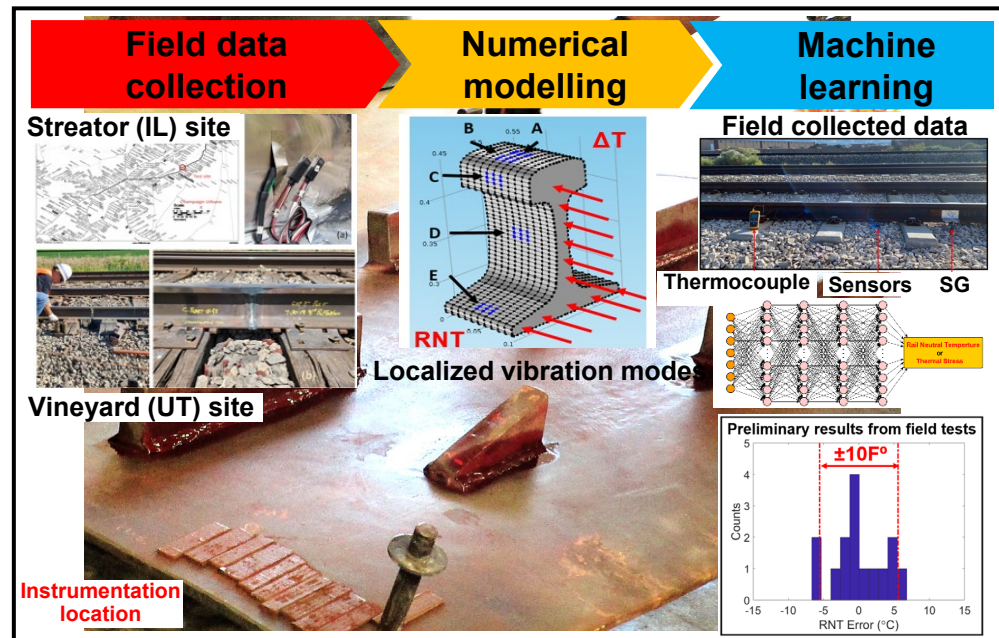

PROJECT PARTNERS

- University of Illinois Urbana-Champaign
- University of Utah
- BNSF
- Utah Transit Authority

COST & SCHEDULE

- Funding to date: \$209,377
- Project Duration: September 2021 – March 2024

Non-contacting System for Longitudinal Rail Stress Measurements: Field Deployment and Validation

PROJECT DESCRIPTION

- Continue the development, field deployment, optimization, testing, and qualification of the next-generation system for measuring RNT and rail longitudinal stress.
- The system hardware is a portable, non-contacting system based on stereo-vision and/or 3D laser scanner technology for full-field deformation measurements of rail.
- The system software implements a novel reference-free algorithm for data processing a series of measured rail deformation measurements within a thermal cycle.
- The next-generation system will be deployed, tested, validated, and demonstrated in the field under various track and operating conditions and acquisition modes.

PROJECT PARTNERS

- University of South Carolina
- Correlated Solutions, Inc.
- CSX Transportation

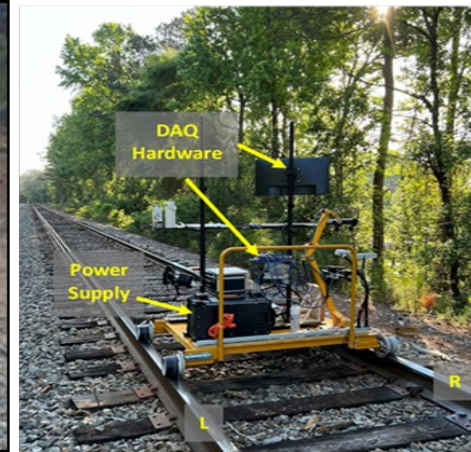
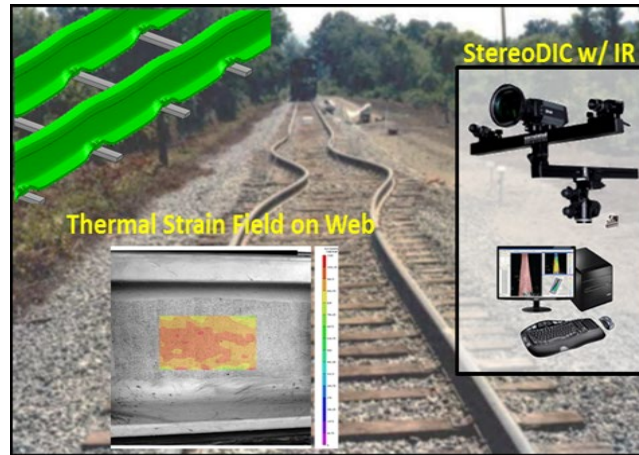

RAILROAD IMPACT

- Improve safety through early detection of potential track buckling.
- Facilitate effective management of thermal stresses.
- In-situ, non-destructive, reference-free testing does not disrupt service.
- The simple, easy-to-use, accurate, and cost-effective technology can be deployed routinely or on demand.
- Data can be integrated with information acquired by other track-sensing technologies.

COST & SCHEDULE

- Funding, FY21: \$164,077
- Funding, FY22: \$166,170
- Funding, FY23: \$122,961
- Project Duration: September 2021 – September 2024

Advanced Non-contact Detection of Lateral Track Strength

PROJECT DESCRIPTION

- Develop a proxy measurement for track lateral strength.
- Evaluate the applicability of noncontact Doppler LiDAR sensors for the detection of lateral track and cross-tie motions/ vibrations as they relate to rail movement and buckling under rolling wheel loads.
- Evaluate the applicability of noncontact sensors for in situ detection of lateral track strength.
- Determine the effectiveness of Doppler LiDAR systems or similar noncontact sensors (eddy current, etc.)
- Develop advanced data analytics methods that can provide efficient, accurate, and autonomous post-processing means for the large volume of data resulting from revenue service and test track testing.
- Provide recommendations for the use of noncontact sensors for detecting weak or “soft” track.

RAILROAD IMPACT

- Improve safety through the prevention of track buckle derailments.
- Provide improved systems for rail stability detection with significantly better timeliness than currently possible.
- Develop data analytics methods for semi/fully-automated processing of a large volume of data.
- Advance railroad operational safety and maintenance efficiency.
- Advance FRA and Class I railroads' abilities to perform autonomous track inspection to determine lateral track strength beyond available methods.

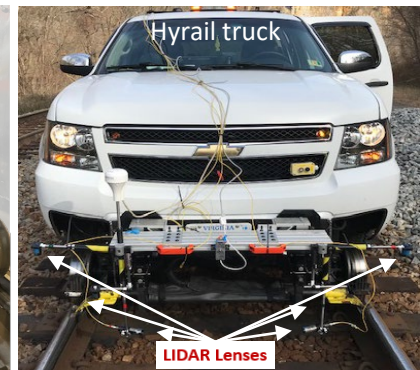
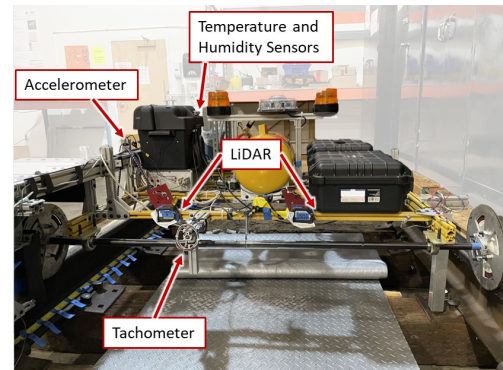

PROJECT PARTNERS

- Virginia Tech
- Norfolk Southern Railway

COST & SCHEDULE

- Funding, Year 1: \$195,496
- Funding, Year 2: \$204,495
- Project Duration: August 2022 – December 2024

Fatigue Crack Growth Rate Characterization in Rail Welds

PROJECT DESCRIPTION

- Investigate the integrity of welded joints, with a specific focus on thermite and flash-butt welding of rails.
- Provide a detailed characterization of the weld material, including material properties, microstructural analysis, and fracture toughness.
- Calibrate the parameters of the fatigue crack growth relationship and determine the fatigue life of rail welds.
- Conduct a fatigue behavior comparative study between thermite and flash-butt welded joints, in reference to the parent metal.

RAILROAD IMPACT

- Improved understanding of how defects grow in welds to reduce broken weld derailments
- Increased accuracy of inspection interval and replacement schedule for welded joints in rail

PROJECT PARTNERS

- Tuskegee University
- EWI
- Thornton Tomasetti
- Steel Dynamics, Inc.
- Nucor Corp.

Thermite Weld HAZ Fatigue Crack Growth Rate

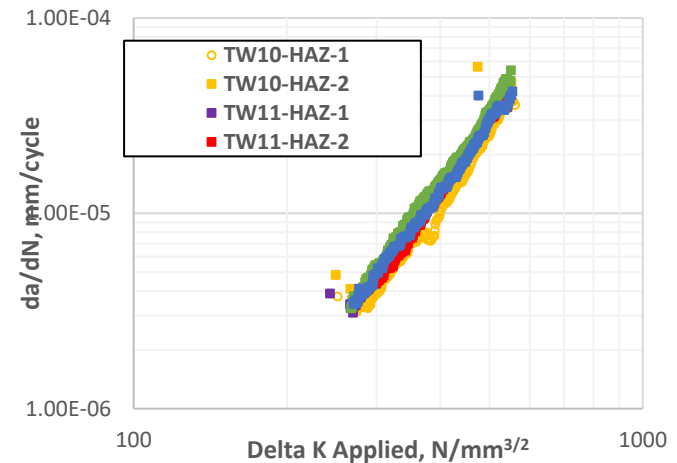

COST & SCHEDULE

- Funding, FY21: \$179,613
- Funding, FY22: \$173,834
- Funding, FY24: \$146,553 (pending)
- Project Duration: September 2021 – September 2024

Advances in Rail Integrity Inspection

PROJECT DESCRIPTION

- Evaluate, maintain, and support activities related to rail integrity efforts at FRA's Transportation Technology Center (TTC).
- Collect and add naturally occurring rail flaws (unbroken) to FRA's Rail Flaw Library and Rail Defect Testing Facility (RDTF) at TTC.
- Support lending of samples from Rail Flaw Library to requestors for the advancement of rail-flaw inspection technologies.
- Develop a new high-speed RDTF at TTC capable of supporting testing of new rail-flaw inspection technologies up to 90 mph.
- Build and maintain a world-class metallurgical laboratory at TTC.
- Support third-party rail integrity testing at TTC.

RAILROAD IMPACT

- Improve the reliability of non-destructive evaluation techniques for complete rail-flaw detection and characterization.
- Provide the industry with a safe, controlled, and realistic environment for developing and evaluating new and innovative rail-flaw inspection technologies.
- Support ground-breaking research aimed at improving rail-flaw inspection.
- Advance rail integrity research and metallurgical testing capabilities at TTC.
- Reduced broken rail derailments through better rail performance, defect detection, and operating practices.

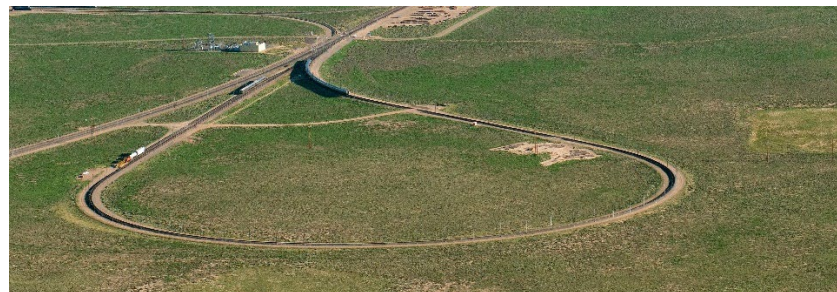

PROJECT PARTNERS

- ENSCO, Inc.
- North American Class I and Shortline/Regional Railroads

COST & SCHEDULE

- Funding: \$ 394,310
- Project Duration: October 2022 – October 2024

Detailed Wheel-Rail Contact Geometry for 3D Special Trackwork

PROJECT DESCRIPTION

- Simulate vehicle-track interaction (VTI) on rails with longitudinal profile variation: switches and crossings (S&C), turnouts, and guard rails.
- Develop smooth interpolation and 3D analysis of the contact location, including near-vertical contacts.
- Demonstrate the technique for the recent S&C benchmark problem.
- Make open-source plug-in accessible to stakeholders.

RAILROAD IMPACT

- Demonstrate VTI with a detailed, 3D contact solution for special trackwork.
- Aid derailment investigations for varying configurations of special trackwork.
- Improve S&C design using detailed numerical simulation.

PROJECT PARTNERS

- Vtech CMCC
- Vehicle Dynamics Group LLC
- SNC-Lavalin Group Inc.
- TTCI

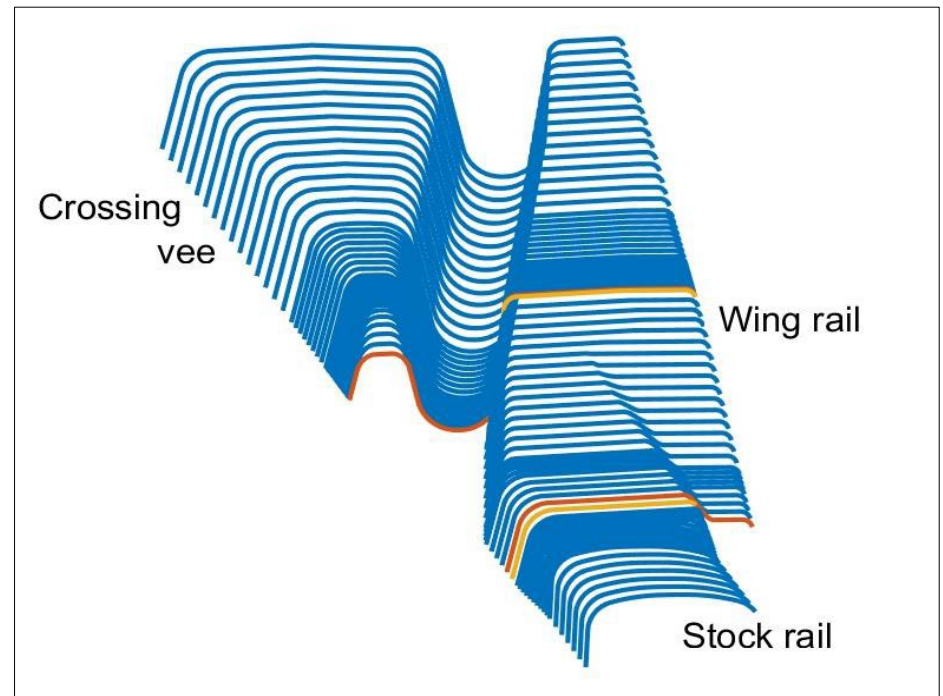

COST & SCHEDULE

- Funding: \$198,300
- Project Duration: August 2022 – March 2024

Detailed Wheel-Rail Contact Geometry for 3D Profile Deviations

PROJECT DESCRIPTION

- Simulate effects of wheel and rail defects: flats, out-of-roundness, corrugation.
- Develop detailed 3D analysis of contact stresses, including transient rolling.
- Demonstrate cases with wheel flat and short-pitch corrugation.
- Open-source plug-in accessible to stakeholders

RAILROAD IMPACT

- Investigate peak stresses associated with damaged wheels and rails.
- Enhance vehicle-track interaction (VTI) standard software codes such as NUCARS, VAMPIRE and SIMPACK.
- Mitigate safety concerns and understand economic consequences.

PROJECT PARTNERS

- Vtech CMCC
- Vehicle Dynamics Group, LLC
- SNC-Lavalin Group, Inc.
- TTCI

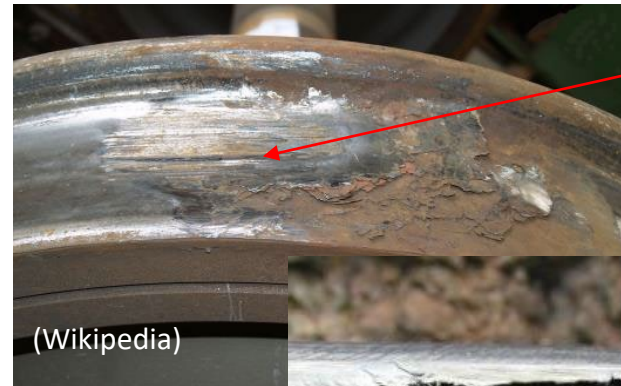

Extreme Wheel Flat

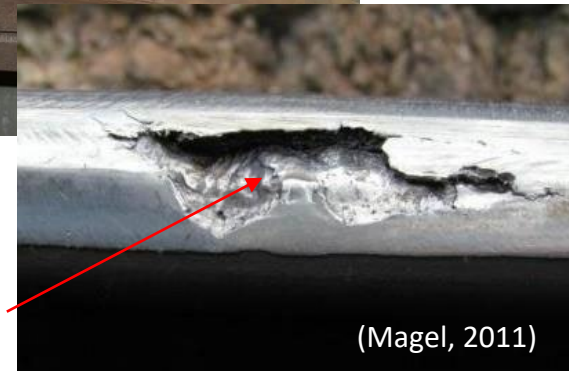

Extreme Shelling

COST & SCHEDULE

- Funding: \$199,100
- Project duration: August 2022 – July 2024



SECTION TWO

ROLLING STOCK

Tank Car Impact and Puncture Analysis

PROJECT DESCRIPTION

- Evaluate puncture resistance of tank cars with various specifications in standardized shell impact scenarios.
- Validate computational models so they can reliably be used to study service conditions with hazmat.
- Study effects of cryogenic temperature on puncture behavior of DOT 113 tank cars.
- Develop computational models of tank car designs under impact conditions, including cryogenic conditions.
- Compare test data with model results to validate models and improve modeling techniques.
- Analyze effectiveness of “breakaway” tank car stub sill attachment design practice.

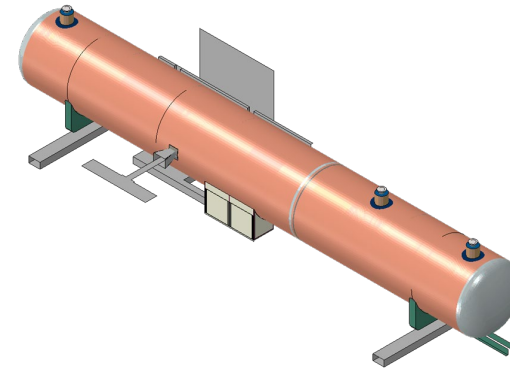

RAILROAD IMPACT

- Develop methods to evaluate and compare the crashworthiness and structural integrity of different tank car design features (e.g., different materials and material thicknesses).
- Evaluate crashworthiness performance of tank cars used in the transportation of hazardous materials.
- Develop objective methods for demonstrating the validation of computational models.



COST & SCHEDULE

- Funding, FY23: \$250,000
- Project Duration: May 2020 – May 2024

PROJECT PARTNERS

- Volpe National Transportation Systems Center
- EnSCO, Inc.
- TTCI
- U.S. Pipeline and Hazardous Materials Safety Administration
- Tank Car Manufacturers

Behavior of Tank Car Construction Materials

PROJECT DESCRIPTION

- Conduct material testing to determine mechanical properties and fracture behavior of tank car steels.
- Examine properties of and develop computation models for stainless steel(s) used in cryogenic DOT 113 tank cars.
- Examine properties of and develop computational models for TC128-B tank car steel in different welded conditions.

RAILROAD IMPACT

- Understand the range of material behaviors in tank car fleet needed to determine baseline tank car fleet structural performance.
- Developing computational models of these materials supports parametric studies of material variations.
- Previous research has focused on mechanical properties of carbon steels (e.g., TC128).
- Cryogenic tank cars (DOT 113) use a carbon steel outer tank/stainless steel inner tank at cryogenic temperature.
- Understanding stainless steel behaviors under cryogenic operating conditions is necessary to determine baseline DOT 113 structural performance; examine alternative designs.
- Understanding the performance of unique TC128-B welds found on DOT-113 tank cars improves puncture models over a range of scenarios.

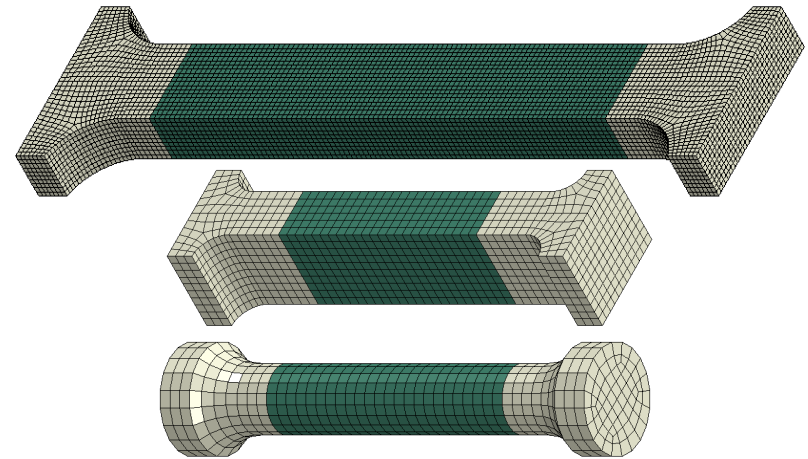

PROJECT PARTNERS

- Volpe National Transportation Systems Center
- ENSCO, Inc.
- TTCI
- Tank Car Manufacturers
- Sharma & Associates
- National Institute of Standards & Technology

COST & SCHEDULE

- Funding, FY23: \$200,000
- Project Duration: May 2020 – May 2024

Puncture Resistance Evaluation of the DOT-113C120W9 LNG Tank Car

PROJECT DESCRIPTION

- A recent FRA ruling allows transport of LNG by rail, but the puncture resistance of the DOT-113C120W9 design has not been fully established.
- Apply existing modeling techniques for tank car puncture assessment under various impact conditions to the DOT-113C120W9. Evaluate relative performance to other designs in a revision to report DOT/FRA/ORD-13/17. Complement the test program.
- Refine the constitutive model for cryogenic ASTM A240 304 stainless steel and simulate the material testing:
 - Generate LS-DYNA models for puncture analysis and incorporate cryogenic inner tank material constitutive model.
 - Perform a series of impact/puncture analyses for a variety of additional impact conditions and compare the performance to other tank car designs.
 - Evaluate designs with increased inner and outer tank thicknesses to assess optimum design for increased puncture resistance.

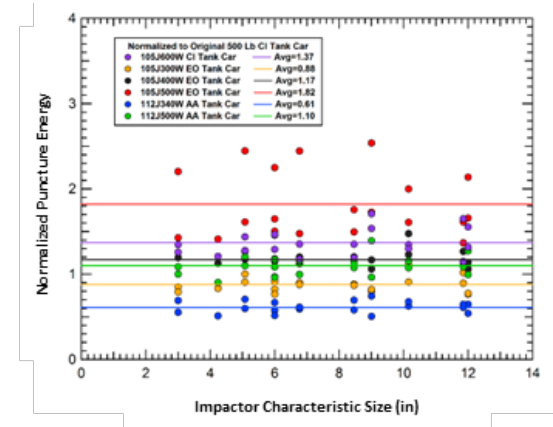
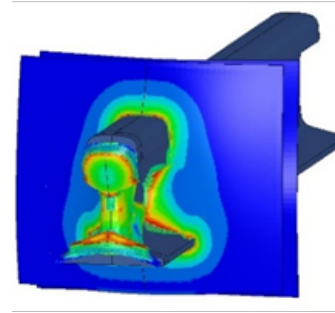

Relative Puncture Resistance of Various Tank Designs

RAILROAD IMPACT

- Reduce risk of building a fleet of LNG tank cars with insufficient puncture resistance requiring future rulemaking and obsolescence.
- Reduce the number of HazMat releases.
- Prevent potential casualties from derailments.
- Reduce liability costs for railroads.

PROJECT PARTNERS

- Applied Research Associates, Inc.
- Volpe National Transportation Systems Center

COST & SCHEDULE

- Funding, FY22: \$750,000
- Project Duration: September 2022 – September 2023

Tank Car Impact Tests

PROJECT DESCRIPTION

- This project is a continuation of FRA and industry tank car impact research programs:
 - Develop and improve test methods.
 - Provide data for improving modeling methods.
 - Design and construct test fixtures.
- Prepare and test various tank car designs:
 - DOT 105 – April 27, 2016
 - DOT 117 – September 28, 2016
 - DOT 105 – July 26, 2017
 - DOT 105 – August 1, 2018
 - DOT 111 – October 30, 2018
 - DOT 113C120W – November 19, 2019
 - DOT 113 Surrogate – June 11, 2020
 - DOT 113 Surrogate w/LN2 – 2021
 - DOT 113C120W9 w/LN2 – 2022
- Analyze and provide the data for validation of finite element models.
- Report on test and model results



PROJECT PARTNERS

- ENSCO, Inc.
- U.S. Pipeline and Hazardous Materials Safety Administration
- Volpe National Transportation Systems Center
- Tank car manufacturers

RAILROAD IMPACT

- Develop performance-based testing requirements.
- Develop methods to evaluate the crashworthiness and structural integrity of different tank car designs.
- Evaluate crashworthiness performance of tank cars used in the transportation of hazardous materials.

COST & SCHEDULE

- Funding, FY23: \$1,000,000
- Project Duration: July 2015 – September 2024

Acquisition, Transportation, and Storage of Failed or Damaged Rail Tank Cars and/or Components

PROJECT DESCRIPTION

- Acquire, transport, and store failed or damaged railroad tank cars and components.
- This will enable FRA and stakeholder communities to better understand how failures occur and how best to prevent and manage the consequences of such failures through improved equipment designs and protection.
- Maintain an inventory of all documentation data and all specimens in a secure area.

RAILROAD IMPACT

- Inventory damaged tanks involved in derailments.
- The project will provide an opportunity to observe and inspect tank cars with failures and learn how they failed and were punctured.
- Display tank cars used on FRA's side impact tests.

COST & SCHEDULE

- Funding, FY23: \$80,000
- Project Duration: July 2015 – September 2024



PROJECT PARTNERS

- ENSCO, Inc.
- Volpe National Transportation Systems Center
- Ambipar Group
- Tank car manufacturers
- Railroads

Tank Car Research

PROJECT DESCRIPTION

- FRA has shown that high-magnitude coupling forces that occur in yard operations have the potential to exceed yield limits of mild steel.
- FRA, Union Tank Car, and Amsted Rail recently completed a comprehensive test program to characterize tank carload environments at Amsted Rail's test facility in Camp Hill, PA.
- This task is focused on comprehensive analysis of the collected impact test data to arrive at limiting conditions for coupling speed and impacting mass.
- Additional testing will focus on brake system performance in revenue service operations.

RAILROAD IMPACT

- Create better understanding of the operational environment and root cause of fractures on tank cars.
- Develop speed and mass combination curves to mitigate tank car stub sill failures.
- Conduct over-the-road brake testing to target a variety of issues faced by the industry.

PROJECT PARTNERS

- ENSCO, Inc.
- Union Tank Car Co.
- Amsted Rail Company, Inc.



COST & SCHEDULE

- Funding, FY23: \$450,000
- Project Duration: September 2018 – September 2025

Protecting Hazardous Material Tank Cars from Heat

PROJECT DESCRIPTION

- Evaluate DOT 105, DOT 112, and DOT 117 thermal protection performance during a fire produced by a derailment.
- Use Fire Dynamic Simulator as fire simulation and evaluate heat transfer to determine time to internal critical temperature.
- Phases:
 - Research and data collection
 - Fire and heat transfer simulation
 - Effects on cooling water
- Evaluate a particular derailment case to understand cooling delay times.



RAILROAD IMPACT

- Understand required cooling time during a derailment event.
- Consider the results regarding emergency response tactics.

PROJECT PARTNER

- Engineering Systems, Inc.

COST & SCHEDULE

- Funding, FY22: \$196,800
- Project Duration: April 2022 – September 2023

Improving Thermal Protection of Cryogenic Tank Cars through Testing, Analysis, and Evaluation of Pressure Relief Valve System Performance

PROJECT DESCRIPTION

- Characterize pressure relief valve (PRV) system performance in off-nominal (inverted, liquid flow, damaged pipes) conditions through physical testing.
- Apply PRV performance under atypical conditions to full tank finite element model and evaluate risk of tank failure due to reduce pressure relief.
- Characterize PRV performance and response to ignition of liquefied natural gas exhaust gas.
- Use M&S to apply exhaust gas jet conditions to neighboring tanks to evaluate their response.
- Identify and evaluate potential solutions to the problems observed.
- Suggest test and/or design criteria to mitigate foreseen deficiencies in PRV performance.

RAILROAD IMPACT

- Quantify PRV performance under real-world conditions.
- Characterize the effect of reduced PRV performance on the likelihood of tank failure.
- Develop improved test/design criteria to mitigate foreseen performance deficiencies.
- Improve the safety of cryogenic tanks in derailment events.
- Improve state-of-the-art knowledge on the safety and performance of PRV systems for hazardous material transport by rail.
- Update emergency response protocols according to observed tank orientation and PRV function.

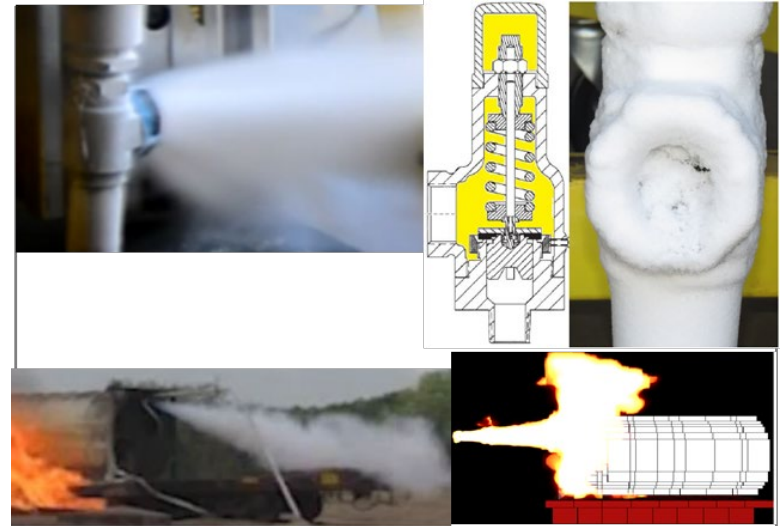

PROJECT PARTNERS

- Friedman Research Corp.
- Southwest Research Institute
- Taylor Wharton (Industry Partner)
- CIRCOR International, Inc.
- Lawrence Livermore National Laboratory

COST & SCHEDULE

- Funding, FY22: \$260,000
- Project Duration: September 2022– September 2023

Review of Very Long Train Operations

PROJECT DESCRIPTION

- Review and understand train performance and accepted practices for Very Long Train (VLT; 200+ cars) operations.
- Confirm the safe performance of the air brake system and resulting train dynamics for VLTs through testing and simulations.
- Collaborate with industry stakeholders, including the Association of American Railroads (AAR), air brake system vendors, and labor unions.
- Phase III testing, with a 200-car stationary train in multiple conventional and distributed power (DP) configurations, was completed in 2022.
- Phase IV over-the-road testing, with 228 cars and up to 7 locomotives in a front-mid-rear DP configuration, was completed in 2023, over a 1,300-mile trip.

RAILROAD IMPACT

- Improve and demonstrate operational safety by improving understanding of brake system performance.
- Potentially document safety benefits of using technologies such as distributed power.
- Simulation tools will have been validated under these newer operating regimes, allowing better customization of operating protocols.

COST & SCHEDULE

- Funding, FY23: \$ 200,000
- Project Duration: September 2020 – January 2024



PROJECT PARTNERS

- AAR
- Union Pacific Railroad
- BNSF
- Norfolk Southern Railway
- CSX
- Kansas City Southern Railway
- Canadian National Railway
- Canadian Pacific Railway
- Rail labor unions
- Wabtec Corp.
- New York Air Brake Corp.
- Sharma & Associates, Inc.

Freight Train Rapid Airbrake Propagation Device (RAPiD)

PROJECT DESCRIPTION

- The project team developed methods that can accelerate the propagation of the air brake signal along the length of the train, short of an ECP-style implementation on every car.
- The team has conceptualized, developed, and lab tested a system that uses rapid airbrake propagation devices (RAPiD) placed along a train to improve stopping distances when the brakes are activated by a locomotive engineer.
- Current efforts are focused on ruggedizing the prototypes, completing a field implementation, and testing the system in the field to measure its effectiveness.

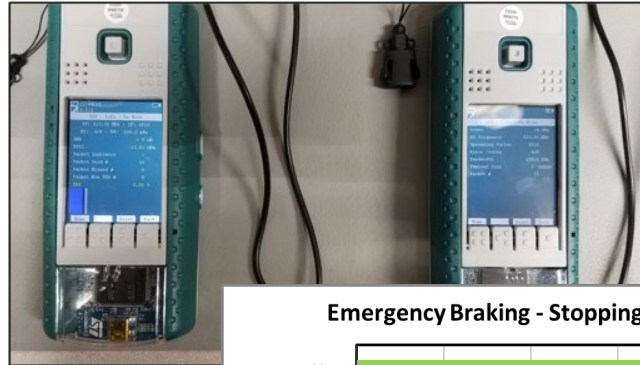

RAILROAD IMPACT

- RAPiD is envisioned to improve the safety of freight train operations by creating a method by which air brake signal propagation speeds are increased.
- This should result in reduced stopping distances, improved slack action, and better train handling.

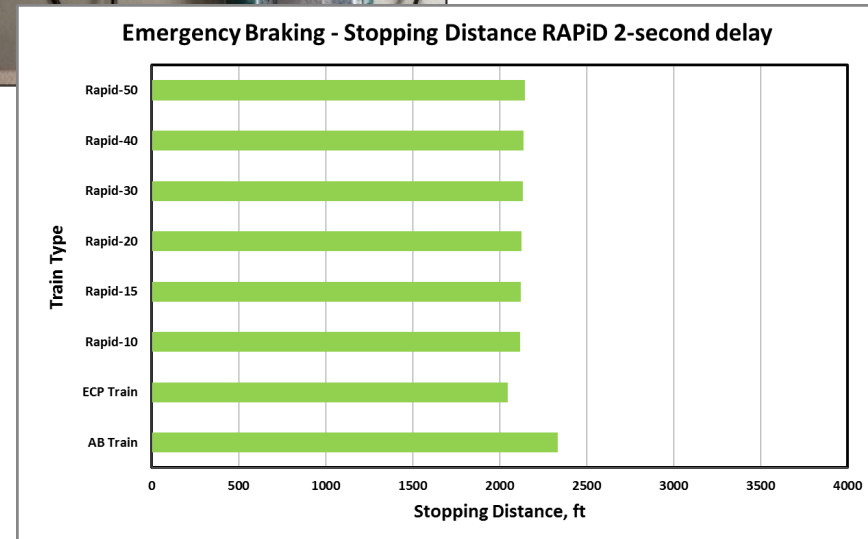

PROJECT PARTNER

- Sharma & Associates, Inc.

COST & SCHEDULE

- Funding: \$395,000
- Project Duration: August 2023 – August 2025

Pendulum-based Puncture Testing of Tank Shells

PROJECT DESCRIPTION

- Develop methods that allow detailed observations of tank puncture performance, including puncture initiation and propagation, performance of welds, and cold weather performance, using repeatable test methods.
- A pendulum-based test setup was conceptualized and implemented with small-scale test specimens.
- Planned tests include sections of the outer shells of DOT-113 tanks (LNG) and consider:
 - Parent material
 - Double-sided seam welds
 - Single-sided closure welds
- Calibrate analytical models to test results.

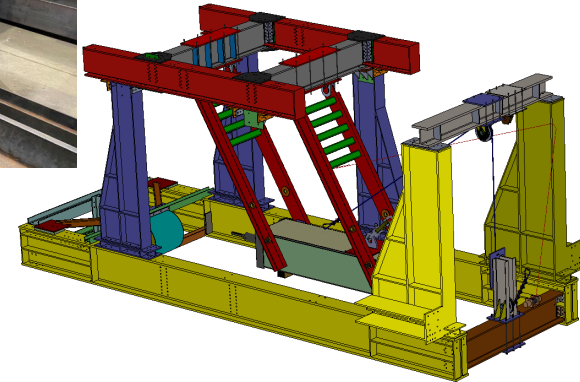

RAILROAD IMPACT

- Improve overall safety of tank car operations by better understanding puncture performance, thereby mitigating the release of hazardous material in tank car derailments.
- Develop performance information that can be used by the industry for standards development.
- Develop recommendations for future design and testing of tank shells for industry use.

PROJECT PARTNERS

- Sharma & Associates, Inc.
- Volpe National Transportation Systems Center
- ENSCO, Inc.

COST & SCHEDULE

- Funding, FY20: \$654,000
- Project Duration: September 2022 – March 2024

Locomotive Structural Crashworthiness

PROJECT DESCRIPTION

- Demonstrate effectiveness of crashworthy components in preventing override in collisions involving locomotives.
- Evaluate performance of combination of a push-back coupler and deformable anti-climber under full-scale dynamic impact scenarios.
- Design crashworthy components as a retrofit to existing locomotives.
- Perform individual component testing to demonstrate performance and develop technical information to inform finite element modeling.
- Perform routine coupling tests to develop range of expected impact forces and to demonstrate designed behavior.
- A full-scale vehicle-to-vehicle (V2V) impact test was performed in January 2019 and a second test was performed in November 2021, to assess the performance of the retrofit components in a moderate-speed collision for a range of impacted equipment.
- A full-scale train-to-train test to assess the performance of the integrated system was performed in August 2022.
- Development of locomotive crashworthiness standards

COST & SCHEDULE

- Funding: \$1,109,326
- Project Duration: August 2018 – August 2022
 - FRA report on conventional coupling tests, Sept. 2019
 - Presentation on V2V test #1 results, February 2019
 - Joint Rail Conference paper on coupling tests evaluation, April 2019
 - FRA report on F40 locomotive retrofit, Sept. 2019
 - FRA report on the conventional and CEM coupling tests, Sept. 2019
 - Joint Rail Conference paper on V2V test #1 results, April 2022
 - V2V test #2, November 2021
 - Full-scale train-to-train test, August 2022



RAILROAD IMPACT

- Locomotives, because of their longitudinal strength and stiffness, are particularly susceptible to override when they collide with another vehicle, and the consequences can be catastrophic.
- Research has shown that conventional anti-climbing structures can deform on impact and form a ramp, increasing the likelihood of override.
- Such behavior was exhibited in a 32-mph collision that occurred in Georgetown, KY, in March 2018 (see photo).
- Research has also shown that the addition of modest structural features to the forward end of a locomotive can greatly reduce the propensity for override.

PROJECT PARTNERS

- Volpe National Transportation Systems Center
- CAMX Power, LLC
- CANARAIL Consultants, Inc.
- TTCI

Interior Occupant Protection

PROJECT DESCRIPTION

- The Volpe Center is supporting FRA on research testing of passenger seats and workstation tables to evaluate compliance with revised American Public Transportation Association (APTA) seat and table safety standards.
- This includes support for occupant experiments using wheelchair/ anthropomorphic test device (ATD) containment devices.
- The APTA safety standards address crashworthiness of passenger seats, cab seats, and workstation tables in passenger railcars.
- Volpe research assists FRA in the evaluation of the crashworthiness of seats, tables, and interior fixtures for new equipment procurements (Siemens/PRIIA CALIDOT, Siemens/Brightline, Stadler/Caltrain, and Alstom/Amtrak).

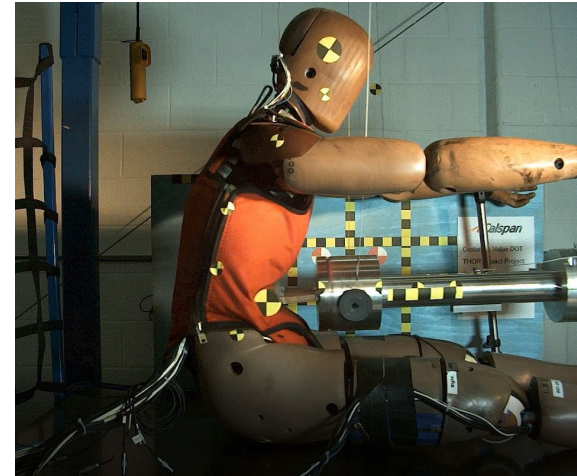

COST & SCHEDULE

- Funding, Occupant Protection: \$360,000
- Funding, Standards Support and Equipment Evaluation: \$75,000
- Project Duration: May 2020 – May 2024
 - Volpe/Calpsan THOR-50M abdomen impact test report, Sept. 2020
 - Volpe THOR-50M FE model validation paper, Jan. 2021
 - Volpe finite element analyses to evaluate attachment strength requirements for wheelchair restraint devices in locomotive train test, May 2021
 - Final APTA Workstation Table Standard, Rev. 2, Dec. 2021
 - Final APTA Seat Standard, Rev. 3, March 2021
 - MGA/Volpe table test report, May 2021
 - Draft APTA Cab Seat Standard, Dec. 2021
 - MGA/Volpe seat test report, June 2022

RAILROAD IMPACT

- Working with seat and table manufacturers and the rail industry to define safety-equivalent options in APTA seat and table standards.
- Disseminate research findings to the rail industry on advanced ATDs to evaluate abdomen injuries specific to workstation tables impacts in passenger train accidents.
- Working with the Rail Vehicles Access Advisory Committee to identify and evaluate crashworthiness protection strategies for passengers in wheeled mobility devices.

PROJECT PARTNERS

- Volpe National Transportation Systems Center
- Passenger equipment manufacturers, operators, suppliers, and consultants

Field Investigations

PROJECT DESCRIPTION

- Derive passenger equipment safety research program areas from information gleaned from real-world conditions.
- Identify deficiencies related to equipment performance and operating practices and inform changes to regulations and industry standards.
- Tune program direction based on the findings of the field investigations to ensure maximum application and effectiveness of research results.

COST & SCHEDULE

- Funding: \$110,000
- Project Duration: May 2023 – May 2024
- Accident investigations have been performed for: Lake City, SC, in August 2000; Nodaway, IA, in March 2001; Crescent City, FL, in April 2002; Placentia, CA, in April 2002; Kensington, MD, in July 2002; Flora, MS, in April 2004; Glendale, CA, in January 2005; Chicago, IL, in September 2005; Chicago, IL, in November 2007; Chatsworth, CA, in 2008; Red Oak, IA, in April 2011; Lovelock, NV, in 2011; Goodwell, OK, in June 2012; Bridgeport, CT, in May 2013; Spuyten Duyvil, NY, in December 2013; Philadelphia, PA, in 2015; Hoboken, NJ, in September, 2016; Dupont, WA, in December 2017; Cayce, SC, in February, 2018; Joplin, MT in September, 2021; Clarendon Hills, IL and Mendon, MO in 2022



RAILROAD IMPACT

- Activities include documenting the damage to the equipment (both interior and exterior), reconstructing the sequence of events, and identifying causal mechanisms for injury and fatality.
- Findings serve to assess the current performance of rail equipment, interiors, emergency egress/access, fuel tank integrity, and other safety features.
- Produce technical presentation of the field investigation from the preliminary findings.
- Issue a report or paper describing the findings from the field investigations and the accident reconstruction.

PROJECT PARTNERS

- Volpe National Transportation Systems Center
- Owners/operators of equipment involved in investigated accidents

Passenger Equipment Glazing Integrity

PROJECT DESCRIPTION

- Develop engineering strategies for improved occupant containment by glazing systems, while meeting all other existing safety, service, and manufacturing requirements.
- The glazing system functions as windows and is expected to be impact resistant, provide emergency egress, provide emergency access, be fire resistant, and provide occupant containment.
- Develop detailed plans for drafting, analyzing, and testing engineering strategies for glazing systems.
- Define all safety and operational requirements placed on glazing systems; assess the performance of current glazing systems in meeting those requirements; develop modifications for improving occupant containment; and conduct analysis and testing to compare the performance of conventional and modified glazing systems.
- Test plans have been developed to evaluate glazing retention system performance under prying, pressure, and simulated dragging conditions.
- Phase I testing completed March 2021.
- Phase II launched September 2022 to include testing of glazing systems designs not considered in Phase I.

COST & SCHEDULE

- Funding: Phase I, \$130,528; Phase II, \$263,099; Phase III \$191,875
- Project Duration: September 2022 – September 2024
 - Present research findings to APTA, December 2021.
 - Issue report describing Phase I project and results May 2022.



RAILROAD IMPACT

- There have been at least 25 fatalities attributed to glazing malfunction in the last 44 years.
- After the commuter train derailment in Spuyten Duyvil, NY, on December 1, 2013, the National Transportation Safety Board (NTSB) issued a recommendation for more effective passenger containment by glazing systems in derailments.
- NTSB reiterated its recommendation after the derailment in Philadelphia, PA, on May 12, 2015.
- Currently, no FRA regulations exist related to passenger containment by glazing systems.
- Outcomes of this research include strategies for improving the survivability of glazing in rollover accidents to improve occupant containment.

PROJECT PARTNERS

- Volpe National Transportation Systems Center
- Sharma & Associates, Inc.

Regulatory Development, Waiver Support, and Technology Transfer

PROJECT DESCRIPTION

- Support development and revision of regulations and safety standards for:
 - High-speed passenger trains
 - Conventional speed passenger trains
 - High-speed passenger trains in mixed service
- Activities include:
 - Definition of accident scenarios of concern and assessment of likelihood and loss from accidents
 - Identification of technologies for improved occupied volume protection, injury prevention, fuel containment, and glazing impact resistance
 - Application of information derived to support policy decisions, regulations, and standards development, and verification of required performance

RAILROAD IMPACT

- FRA support for rail equipment standards development since the advancement of Amtrak's technical specification for the Acela in 1993, which evolved into FRA's Tier II equipment standards, the first national standards requiring crash energy management.
- Publication of first rule addressing crashworthiness and other features of Tier III passenger equipment on November 21, 2018.
- Additional standards supported include the Passenger Equipment Safety Standards, Locomotive Crashworthiness Standards, and Cab Car End Frame Standards.



COST & SCHEDULE

- Funding: \$200,000
- Project Duration: May 2023 – May 2024
 - Present briefings to the National Transportation Safety Board, American Public Transportation Association, and the Railroad Safety Advisory Committee (and its task forces), TBD.
 - Review technical documentation submitted by railroads to demonstrate compliance with FRA regulations as requested, TBD.

PROJECT PARTNERS

- Volpe National Transportation Systems Center
- Passenger equipment manufacturers, operators, suppliers, and consultants

Extended Development of FRA Safety Risk Model

PROJECT DESCRIPTION

- FRA's Office of Research, Development, and Technology (RD&T) manages a large portfolio of research projects focused on improving railroad safety. Rational project selection and scoping strategies maximize the effectiveness of the RD&T program.
- RD&T has developed a means of assessing safety risk broadly across the railroad industry, reflected in its Safety Risk Model (SRM), similar to the U.K. Railway Safety Standards Board.
- The SRM provides a means for quantitative risk-ranking to facilitate project selection. Knowledge of the characteristics of the distribution of risk will allow FRA to make strategic project investments for maximum safety benefit and allow for future assessments of risk reduction resulting from implementing the products of RD&T efforts.
- Future updates to the model will include the means to assess risk based on regional population density (rural, urban, superurban) to derive "state level" safety risks for the purpose of guiding safety inspections.

COST & SCHEDULE

- Funding: \$75,356
- Project Duration: September 2018 – September 2024

Safety Risk by hazard category and train type

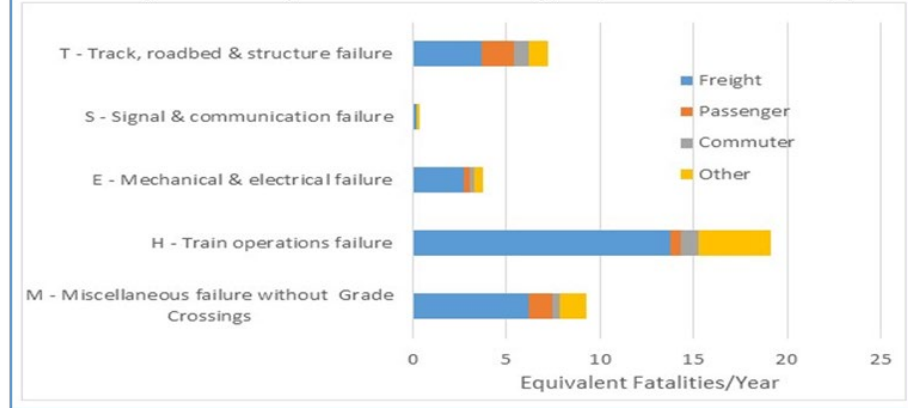

RAILROAD IMPACT

- The application of the results derived from the SRM will enable FRA to focus R&D efforts (and limited available resources) on topics which cause the greatest amount of harm (fatalities, injuries, property damage) in the railroad industry.
- This should result in RD&T research products which are of the greatest benefit to the railroad industry in improving safety performance.

PROJECT PARTNER

- Sharma & Associates, Inc.

Passenger Train Exterior Side Door Safety – Phase II

PROJECT DESCRIPTION

- According to the FRA Final Rule on Passenger Train Exterior Side Door Safety, “passenger trains should have their exterior side doors closed when they are moving between stations.” However, many older (legacy) trains do not possess a door safety system to ensure compliance.
- This leads to the risk of a passenger or an object becoming entangled in the door, preventing it from closing when the train departs a station.
- Failure in the door control system could also cause the exterior side door to accidentally open during train movement or not close when departing a station, leading to the risk of passenger ejection.
- Phase II of this project seeks to develop a cost-effective solution to this door safety problem associated with legacy trains.
- This project is being performed under the Small Business Innovation Research Program.

COST & SCHEDULE

- Funding: \$300,000
- Project Duration: May 2022 – May 2024



RAILROAD IMPACT

- Successful development of this novel door safety technology will result in reduced passenger injuries caused by entrapment in passenger train doors or possible ejection should doors open unexpectedly.
- One railroad partner has been identified to provide support and assistance for field testing of the sensor prototype.

PROJECT PARTNER

- Newport Sensors, Inc.

Wheel Measuring Device – Phase II

PROJECT DESCRIPTION

- Federal regulations and industry standards set requirements on railroad wheel geometry to improve safety and avoid derailments. To ensure compliance, railroads periodically take measurements to determine whether wheels and wheelsets remain fit for service:
 - Wheel diameter
 - Wheel back-to-back spacing (the distance between the back-face of wheels on an axle)
 - Wheel profile (the shape of the portion of the wheel that contacts the rail from back-face to field-side rim)
 - Out of roundness (deviations from uniform wheel diameter)
 - Length and width of wheel defects (e.g., flat spots)
- Other attributes are derived from these measurements, such as wheel flange angle (see APTA PR-M-S-015-06, Rev. 1, Wheel Flange Angle for Passenger Equipment.)
- FRA seeks development of a portable wheel geometry measuring device that can be used in the shop and the field by a single operator.
- This project is being performed under the Small Business Innovative Research Program.

RAILROAD IMPACT

- Current manually operated devices used to measure wheel profiles have limited functionality for taking these measurements and can be subject to operator error.
- Improved techniques for measuring railroad wheel geometry will contribute to railway safety by reducing the occurrence of derailments caused by wheel/rail interface geometry.



PROJECT PARTNERS

- ADA Technologies, Inc.
- Synetics Systems Engineering Corp.

COST & SCHEDULE

- Funding: \$400,000 (ADA); \$400,000 (Synetics)
- Project Duration: September 2022 – September 2024

Quantifying Uncertainty to Enhance Railroad Safety Risk and Decision Models

PROJECT DESCRIPTION

- Current safety risk analysis techniques in the railroad industry have been developed based on probabilistic risk analysis, such as fault and event tree analyses.
- These approaches do not address the uncertainty involved in the data and produce another level of uncertainty in the risk results.
- An Improved Railroad Safety Risk Model (IRSRM) and Risk-Based Multi-Dimensional Decision-Making Model (RMDDMM) will be developed to consider uncertainty to meet the needs of the railroad industry.
- Fuzzy regression analysis will be used to evaluate the relationship between variables and will allow prediction of potential risk in the near future based on evaluating historical risk data as a risk range over an interval (with lower and upper bounds) from the fuzzy output.

RAILROAD IMPACT

- Improve understanding of the history and trends of accident/incident data and safety risk in the railroad system.
- Improve modeling of safety risk estimation and prediction in railroad operations.
- Reduced public risk through improved risk prediction research.
- Improve railroad operational safety against risks to the public, equipment, and property.
- Improve strategic decision-making in railroad operations.

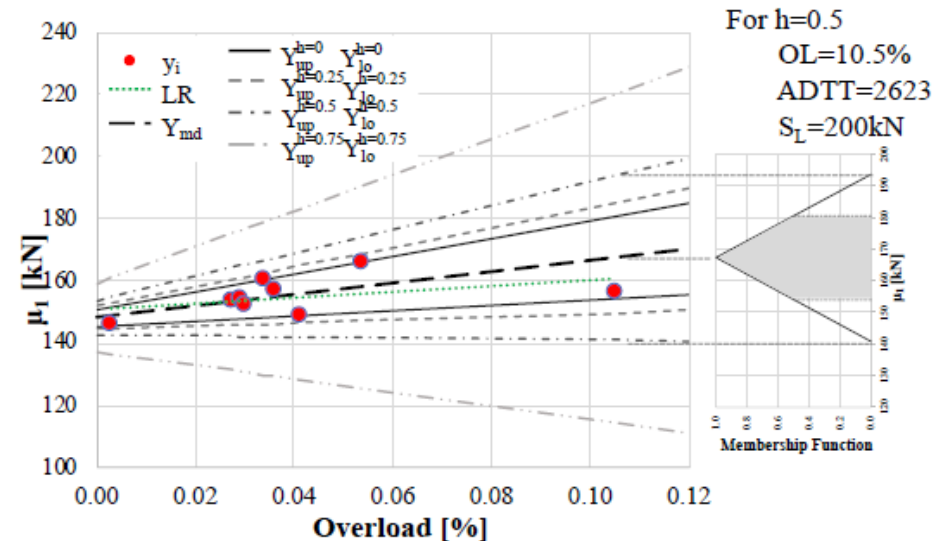

Fuzzy regression model example

PROJECT PARTNER

- Sharma & Associates, Inc.

COST & SCHEDULE

- Funding, FY23: \$294,455
- Project Duration: September 2023 – September 2025

Wheel Failure Research Program

PROJECT DESCRIPTION

- Collaborate with industry to reduce wheel failures, including vertical split rims and shattered rims.
- An industry-wide stakeholder working group (SWG) evaluated current failure modes/characteristics and future steps to minimize contributions to failures.
- The SWG developed research strategies, including analysis of historical data, testing failed wheels, and modeling studies to mitigate failures, reduce risk, and improve safety.
- Previous phases identified future research topics and conducted metallurgical testing of failed wheels.
- Phase III focuses on an FEA-based investigation of factors contributing to crack propagation within wheels.



RAILROAD IMPACT

- Increase understanding of current wheel failure mechanisms and facilitate mitigation.
- Reduce derailments causing severe equipment and track damage.
- Reduce public safety risks and costs associated with such incidents.

PROJECT PARTNER

- ENSCO, Inc.
- Engineering Systems, Inc.
- Association of American Railroads
- Wheel suppliers
- SimuTech Group

COST & SCHEDULE

- Funding, Phase III: \$574,127
- Project Duration: September 2020 – December 2023

Quantifying the Resilience of Freight Railroad Networks (Phase 2)

PROJECT DESCRIPTION

- Use the technology developed in Phase 1 to analyze the topology of Class I railroad networks. Assess the impacts of disruptions on the technology's performance, including network connectedness efficiency and other network attributes using waybill information.
- Implement novel models developed in Phase 1 and develop a tool for assessing connectedness efficiency for intelligent rail network infrastructure using attribute weights from waybill information.
- Enable the use of connectedness efficiency as a performance measure in risk and asset management practices and for enhancing railroad resilience.

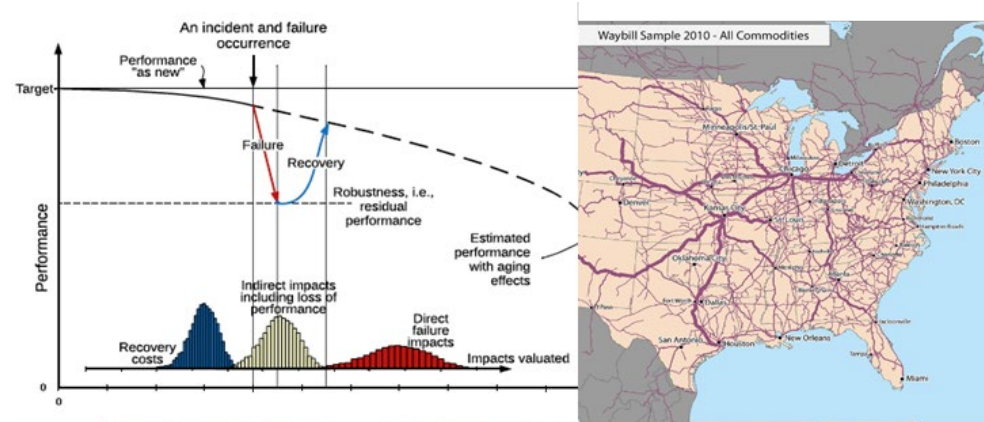

RAILROAD IMPACT

- Enhance topology for increased network robustness and resilience in cost-effective terms.
- Inform policy and decision-making practices.
- Increase economic efficiency.
- Enhance planning and design methods at the network level.
- Plan for and improve on capital spending.

PROJECT PARTNER

- University of Maryland Center for Technology and Systems Management

COST & SCHEDULE

- Funding: \$560,000
- Project Duration: September 23 – August 2026

Wireless Digital Train Line for Passenger Trains (Phase IV)

PROJECT DESCRIPTION

- The RF spectrum is nearly saturated, causing problems for many rail applications (e.g., PTC, WiDTL), especially in high-density areas.
- Realize a full prototype of the transceiver design using a software radio platform, with cognitive radio capabilities and spectrum sensing and a component-driven modular design process.
- Initiate development of the universal radio platform – a single radio across applications, RF bands, environments, and form factors (handheld, WiDTL, wayside, etc.)
- Conduct extensive field test evaluations of the prototype to demonstrate the merits of 160 MHz as a viable band for modern rail applications.

RAILROAD IMPACT

- Establishes path toward a Universal Radio Platform, integrating a modular design, cognitive radio capabilities, and wide-range frequency agility
- Transitions research into the 160MHz RF band from computer simulation to a full prototype platform
- Advances readiness for use by railroads in applications such as extending the 220MHz PTC into the 160MHz band to relief congestion in high-density areas
- WiDTL onboard signaling and long-range wayside communications
- All developed software radio code, design documents, and performance results are available to the rail industry for adoption into rail applications, further evaluation, or customization.

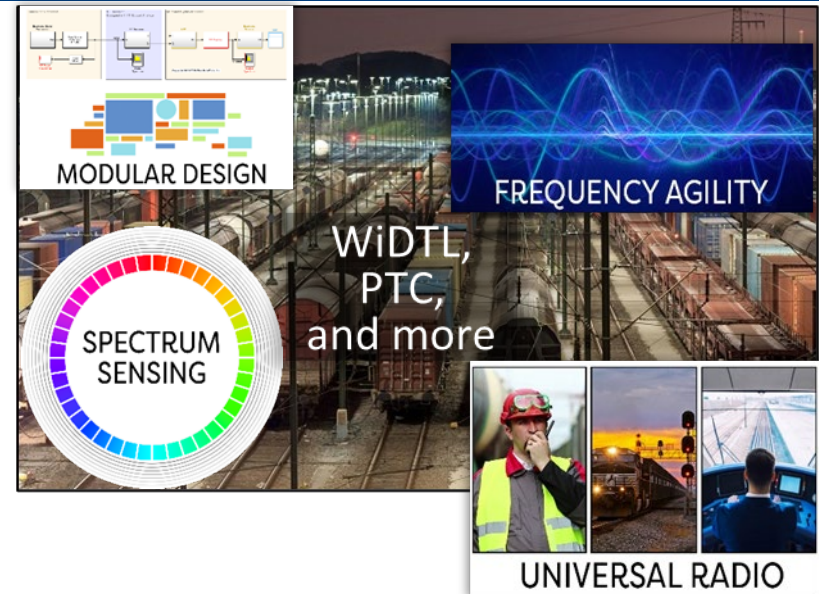

PROJECT PARTNER

- University of Nebraska-Lincoln – Advanced Telecommunications Engineering Laboratory

COST & SCHEDULE

- Funding: \$178,000
- Project Duration: January – December 2023

WAAM for Weld-Enhanced Cast Steel Couplers

PROJECT DESCRIPTION

- **Objective:** Increase coupler safety and reliability by weld-enhancing knuckles locally in high-stress areas through wire-arc additive manufacturing (WAAM).
- Coupler knuckles fail in high-stress regions by corrosion fatigue accelerated by casting defects, surface decarburization during heat treatment, and their environment (e.g., salt).
- WAAM is a weld repair process for high-stress regions that can improve fatigue strength and corrosion resistance by removing casting and heat treatment defects by:
 - Process development with standard AWS wire grades
 - High-cycle fatigue on weld material and weld-substrate in air and salt environments
 - Prototype production knuckle and perform M-216 knuckle testing

RAILROAD IMPACT

- Safer coupler system that is less likely to fail due to fatigue or corrosion
- More reliable coupler system with consistent load capacity over its lifetime
- Will not change geometry of coupler
- Will build on current weld repair procedures
- High-volume production strategy with limited cost implications

Equivalent Stress
Type: Equivalent (von-Mises) Stress
Unit: MPa
Time: 1
2/25/2010 3:09 PM

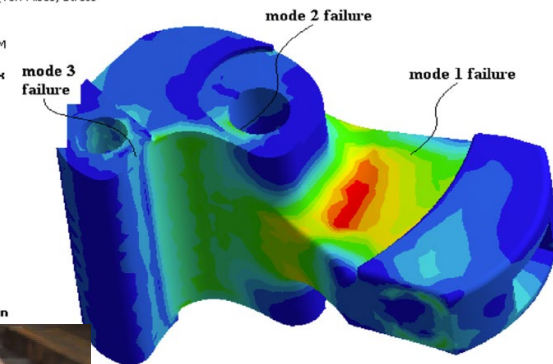
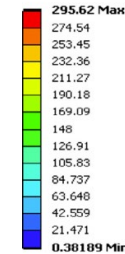

Knuckle FEA showing high stress in pulling lug (Chundururu, 2011) and knuckle failure in similar region

PROJECT PARTNERS

- Michigan Technological University
- Amsted Rail

COST & SCHEDULE

- Funding: \$500,00
- Project Duration: April 2022 – December 2024

Intelligent Wireless Power Transfer (IWPT) for Safe Electric Power Charging

PROJECT DESCRIPTION

- To improve the safety of the electric power charging system for rolling stock, this proposal suggests the use of IWPT technology for power charging.
- IWPT technology completely removes humans from the hazardous environments of wired high-voltage power charging operations and improves the safety of the railroad environment from electric fire.
- The integrated 1-2-Cut technology determines receiver and transmitter impedance, detects correlation to charging position, arc fault, and fire risk potentials and automatically cut off power to eliminate fire risk.

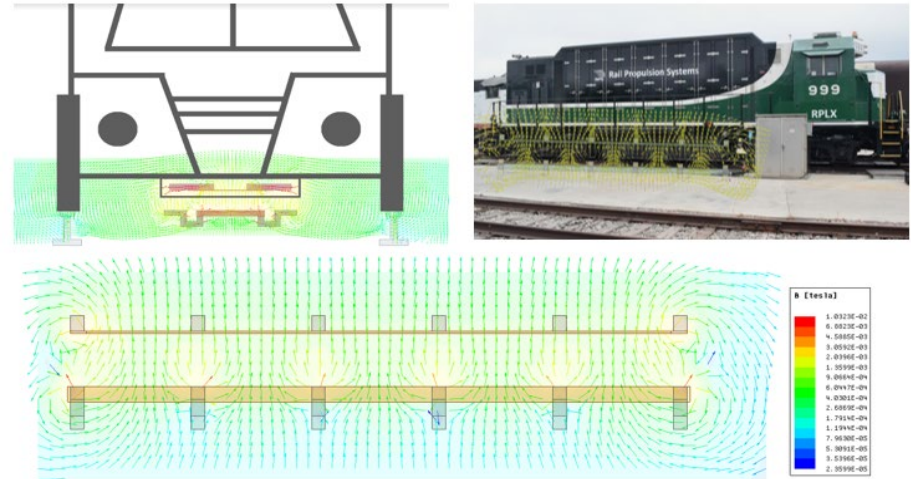

IWPT system magnetic flux distribution

RAILROAD IMPACT

- Increased worker safety: IWPT can minimize human contact with high voltage/ampereage electricity.
- Time savings: IWPT charging stations would simply require a locomotive to be parked at the designated location above the charging mat, thus lower plug-in operation.
- A technological step forward for the passenger rail industry: IWPT represents a progressive mentality toward new technologies.
- Safety inspection: Fire safety, arc fault, and damaged or deteriorating component information are provided by the intelligent detection algorithm and the automatic shutoff function.

PROJECT PARTNER

- University of North Carolina at Charlotte

COST & SCHEDULE

- Funding: \$435,548
- Project Duration: June 2021 – May 2024

Rail Research and Development Center of Excellence (CoE) Program

PROJECT DESCRIPTION

- Establish and maintain a shared Center of Excellence to advance research and development that improves the safety, efficiency, and reliability of passenger and freight rail transportation.
- Conduct advanced rail research to understand the needs and implications of emerging transportation technologies such as automation and unmanned aerial systems, transportation system use and operations, and infrastructure design.
- Research topics will include train control, human factors, rail infrastructure, shared corridors, grade crossings, inspection technology, remote sensing, rail systems maintenance, network resiliency, operational reliability, energy efficiency, and other advanced technology.
- Develop partnerships to expand rail training.
- Develop rail-focused curricula and programs.
- Build STEM competencies of local and future rail workforce.



RAILROAD IMPACT

- Consortium of universities to advance rail research and innovation
- Increased university participation and partnership
- Expanded talent pool of rail professionals
- Increased technology transfer of prioritized research

PROJECT PARTNERS

- National University Rail Center of Excellence (NURail CoE)
- Lead University: University of Illinois at Urbana-Champaign

COST & SCHEDULE

- Funding: \$2.5M per year; \$7.5M total
- Project Duration: 36 months

Rail Safety Innovations Deserving Exploratory Analysis (IDEA) Program

PROJECT DESCRIPTION

- IDEA programs differ from traditional research programs in that they are initiated by researchers, inventors, universities, or companies (both within and outside the usual transportation research community) rather than by a request for proposals.
- Each year, three proposals are selected and funded for up to \$100,000 each.
- The National Academy of Sciences carries out the Rail Safety IDEA program through the Transportation Research Board.
- Rail Safety IDEA 52, 53, and 54 will be funded in the FY23 program.

RAILROAD IMPACT

- Capture the unexpected concepts that challenge conventional thinking.
- Explore promising but unproven concepts with the potential to advance railroad safety and performance.
- Support university research centers and small companies to improve their railroad research capabilities and expertise.

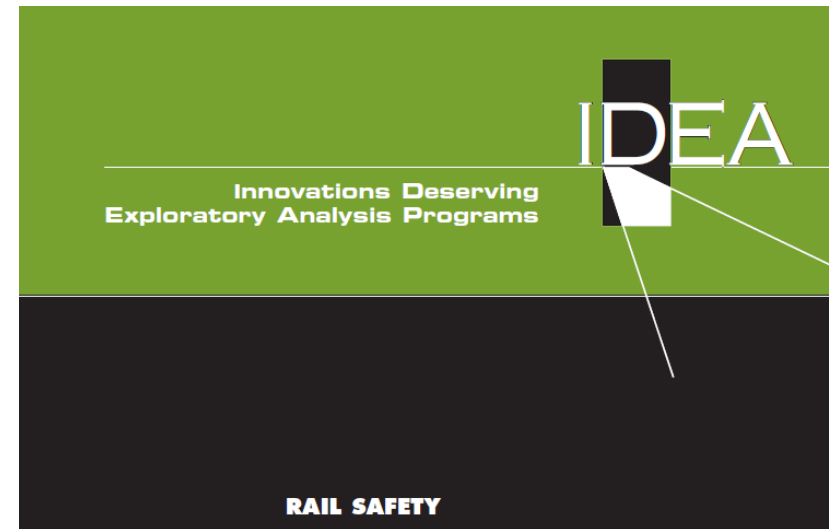

PROJECT PARTNER

- Transportation Research Board

COST & SCHEDULE

- Funding, FY22: \$400,000
- Project Duration: July 2023 – December 2026

Train Energy and Dynamics Simulator (TEDS)

PROJECT DESCRIPTION

- TEDS is a computer program developed by FRA for conducting longitudinal train dynamics simulations.
- It can assist in developing recommendations to improve train operating safety.
- TEDS can simulate train handling, train makeup, head-end and distributed power, electronically controlled pneumatic and automatic brake applications for speed control, stopping distances, and emergency stops.
- Validation details are published in FRA reports: DOT/FRA/ORD-15/01, DOT/FRA/ORD-20/24, and DOT/FRA/ORD-20/26.
- TEDS has been used successfully for several simulations to assist FRA's Office of Railroad Safety in investigations and policy studies.
- It is available for public use under a service agreement with FRA and Sharma & Associates, Inc.

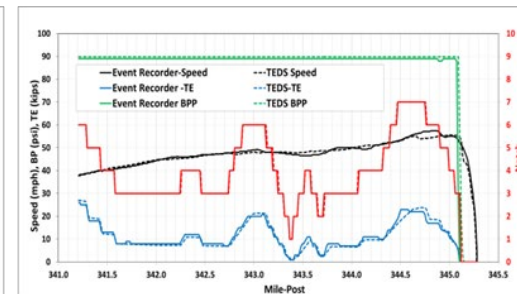
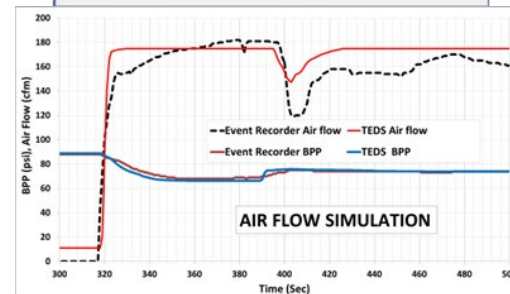
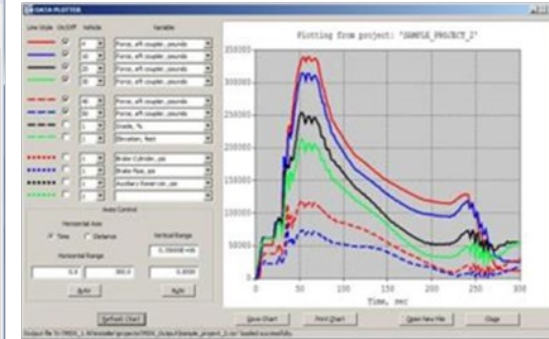
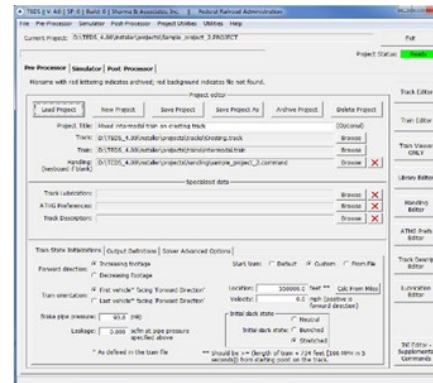

RAILROAD IMPACT

- TEDS facilitates identification and quantification of safety risks in train operations regarding:
- Equipment
 - Train makeup, including free slack between couplers
 - Train handling
 - Track conditions, including presence of lubricators
 - Operating practices
 - Environmental conditions
 - Certain types of malfunctioning equipment, such as locomotive power drops, leaking air brakes, etc.

PROJECT PARTNER

- Sharma & Associates, Inc.

COST & SCHEDULE

- Funding, FY22: \$220,000
- Project Duration: September 2020 – March 2024

Effects of Technology Implementations on Network Operations

PROJECT DESCRIPTION

- Develop a methodology to quantify network-level benefits to train operations from implementing new technologies.
- Use the network simulations software OpenTrack® for various network operational characteristics as follows:
 - Different types of corridors: single-track, double-track, and multiple-track corridors
 - Types of traffic: dedicated vs. shared-use corridors
 - New technology implementation
 - 4,900 miles of main tracks have been developed with 256 daily trains operating along different sections of the network, and a variety of signaling and braking characteristics.

RAILROAD IMPACT

- Improve traffic congestion analysis.
- Objective evaluation of operating with new technologies
- Capabilities to analyze the network-related parameters of operating trains under PTC systems.
- Quantify network benefits due to new technologies.

PROJECT PARTNER

- Sharma & Associates, Inc.

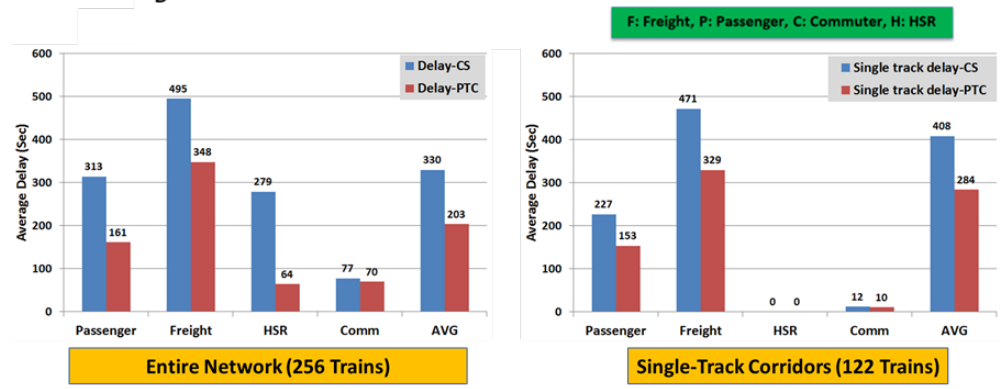
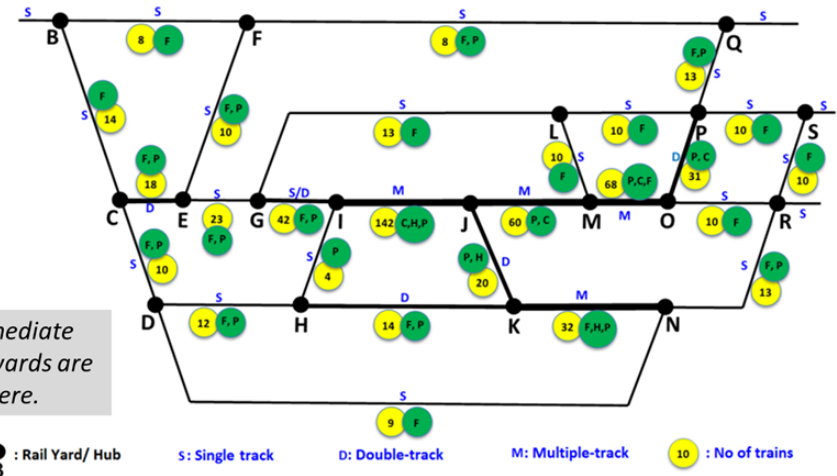

COST & SCHEDULE

- Funding, FY22: \$149,000
- Project Duration: September 2018 – September 2021

Wayside Advanced Technology Systems (WATS)

PROJECT DESCRIPTION

- Partner with Metro-North Railroad (MNR), Long Island Rail Road (LIRR) and New York Atlantic Railway (NYA) to assist with pilot demonstrations of new wayside technology systems to detect defects and precursors to safety-critical defects in rolling stock.
- Document new installation at MNR, LIRR, and NYA.
- Conduct detection threshold analysis to help railroads establish detection thresholds for inspection, alarm, and emergency level actions balanced against their shop capacity and commuter service demands for passenger coaches.
- Identify best practices for implementation and revise the Wayside Implementation Guide.

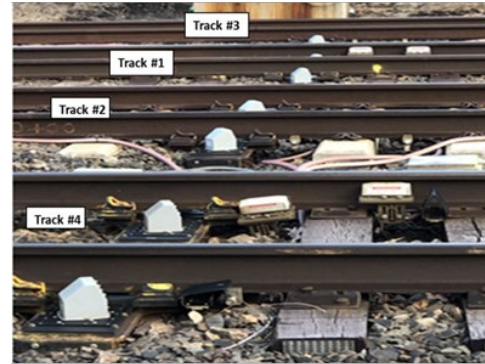

RAILROAD IMPACT

- Improve the process for demonstrating and implementing new technology.
- Establish a standard process for wayside technology pilot demonstrations.
- Wayside technology systems will reduce the number of incidents and accidents through proactive maintenance, driven by monitored performance of rolling stock equipment and components.

PROJECT PARTNERS

- Sharma & Associates, Inc.
- LIRR
- MNR
- NYA

COST & SCHEDULE

- Funding: \$449,324
- Project Duration: September 2018 – December 2023

Advanced Technology Integration – Ecosystem Platform

PROJECT DESCRIPTION

- Develop and integrate a modern, powered communications and control ecosystem for freight vehicles:
 - Research available communication and control platforms that might be applicable for railroad use.
 - Design and build a three-car test rack for studying the selected prototype ecosystem platform.
 - Use the test rack for in-lab testing/development.
 - Initiate the development and acceptance of AAR interchange specifications/standards for an electrical power supply system, an electronically driven hand brake, and the subject ecosystem platform.

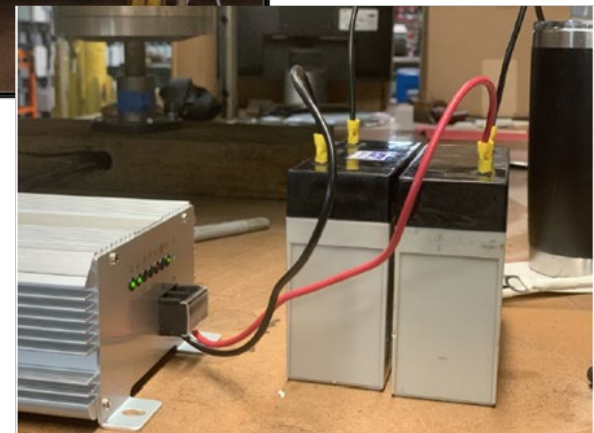

RAILROAD IMPACT

- Improve freight railroad operations safety and security.
- A power, communications, and controls platform will make it easier for adoption of various safety and security monitoring device applications.
- Written and adopted standards and recommended practices, by AAR, will open the door for safety and security device implementation that will be allowed for interchange.

PROJECT PARTNER

- Sharma & Associates, Inc.

COST & SCHEDULE

- Funding, FY19–23: \$371,000
- Project Duration: September 2019 – June 2023

Rail Dynamics Laboratory (RDL) Test System Restoration at TTC

PROJECT DESCRIPTION

- Restore non-functional RDL Mini-Shaker Unit (MSU), Simuloader Unit (SMU), Squeeze Test Fixture, and Vibration Test Unit (VTU) to functional capabilities:
 - MSU: Acquire air tables, servo valves, load bars, and various peripherals.
 - SMU: Acquire hydraulic pumps, I-beams, bearings, and fixturing.
 - Squeeze Test Fixture: Restore structural frame, upgrade control room.
 - VTU: Repair instrumentation, acquire controller.
 - These test systems were left in non-functional states by the previous FRA Transportation Technology Center (TTC) contractor.

RAILROAD IMPACT

- Restore and improve TTC's transportation research and testing capabilities for the improvement of safety, security, and efficiency in transportation operations.

PROJECT PARTNER

- ENSCO, Inc.

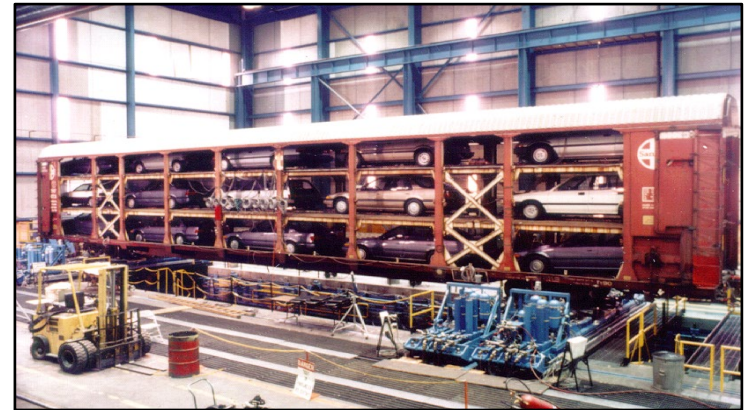

COST & SCHEDULE

- Funding, FY23–25: \$741,369
- Project Duration: September 2023 – March 2025

Autonomous Detection of Train Air Leaks

PROJECT DESCRIPTION

- Field development of a wayside autonomous air leak detection system
 - Continuation of work completed for TRB IDEA program (SAFETY 48)
- Design and fabricate system hardware for wayside application.
- Refine detection and identification capabilities through data collection, software modification, and machine learning.
- Conduct a feasibility study to identify the capabilities and limitations of acoustic sensors in real world rail environment.
- Determine track speed limits of detection system.
- Two Phases:
 - Phase I: Shorter duration, more hands on
 - Phase II: Longer duration, larger population



RAILROAD IMPACT

- Greatly reduces labor and cost associated with finding air leaks
- Increases safety through increased air brake reliability and reduces the time employees spend on, under, or between rolling stock when finding leaks
- Potential for large reductions in criteria and GHG emissions and fuel consumption industry-wide
- Large reductions in AESS restart events, prolonging component life and further reducing criteria and GHG emissions and fuel consumption

PROJECT PARTNERS

- Phase I: ENSCO, Inc., shortline/Class I railroads with captive fleet (testing at TTC dependent on availability of a train, funding)
- Phase II: Class I railroads; interest and agreement in principle

COST & SCHEDULE

- Funding, FY24: \$450,000–\$500,000
- Project Duration: October 2023 – September 2025

Electrical Power System for Individual Freight Car Application

PROJECT DESCRIPTION

- Develop a solar-charged electrical power system for freight car applications.
- Recent innovations in flexible solar panels allow for faster installation on the exterior of railcars, including tank cars.
- The system will be compact, allowing for greater flexibility in installation location.
- The prefabricated, modular design will expedite installation and minimize cost.



RAILROAD IMPACT

- Facilitate low-cost instrumentation of unpowered rail vehicles.
- Enable a wide range of safety, security, and measurement systems to be deployed on revenue service vehicles.
- Reduce the cost of evaluating new technologies and encourage adoption of existing communications and measurement systems.

PROJECT PARTNER

- ENSCO, Inc.

COST & SCHEDULE

- Funding, FY24: \$132,000
- Project Duration: August 2023 – September 2025

Alternative Propulsion Research – Safety Analyses

PROJECT DESCRIPTION

- Update crashworthiness standards to apply to new alternative propulsion rail equipment, e.g., hydrogen fuel cells, battery, liquefied natural gas (LNG), etc.
- Identify and evaluate critical impact scenarios, based on accident history, using a combination of testing and computer simulations.
- Conduct tests to evaluate safety performance issues of new alternative propulsion rail equipment, i.e. structural crashworthiness, component and fitting structural integrity, fire, etc.
- Evaluate the merit of using hydrogen fuel cells in a railroad application.



RAILROAD IMPACT

- Provide science-based data in support of decisions for use of alternative fuels by U.S. railroads.
- Improve state-of-the-art knowledge on safety and efficiency of alternative fuels, such as hydrogen and fuel cell systems, for rail applications.
- Collaborate with the railroad industry in the development of specifications for the next generation of alternative propulsion tenders and railcars.

PROJECT PARTNER

- Volpe National Transportation Systems Center

COST & SCHEDULE

- Funding, FY20 – FY23: \$865,000
- Project Duration: May 2020 – Present

Safety Testing of Advanced Clean Energy Technology for Rail

PROJECT DESCRIPTION

- Assemble a team of subject matter experts to develop a feasible and safe testing and simulation research program to evaluate the performance of Hydrogen and Battery Energy Storage Systems (BESS) under derailment and crash conditions.
- Determine the safety needs for hydrogen and BESS use in the railroad industry and develop testing requirements and assess capabilities at the Transportation Technology Center.
- Develop test and implementation plans for both hydrogen and BESS testing for future FRA research.

RAILROAD IMPACT

- Generate information and roadmap to define safety requirements for future hydrogen and BESS systems.
- Lay the foundation for safe rail operations with hydrogen and BESS for propulsion.
- Enable the expansion of hydrogen and BESS use in rail transport in the U.S. This expansion will increase the efficiency and sustainability of rail transport by reducing the use of fossil fuels.



PROJECT PARTNERS

- ENSCO, Inc.
- Volpe National Transportation Systems Center
- Ambipar Emergency Response

COST & SCHEDULE

- Funding, FY23: \$99,846
- Project Duration: March 2023 – March 2024

Hydrogen Safety Research for Rail Applications

PROJECT DESCRIPTION

- Hydrogen is a more efficient and environmentally friendly fuel, but there are many unknown risks surrounding the use of this technology in the rail environment.
- Sandia will use cutting-edge technology, such as computer simulations, risk assessments, literature searches, small scale laboratory testing, etc. to assess the risks of hydrogen fuel.
- The research will examine crashworthiness, fire safety, human interaction, and materials compatibility with hydrogen.

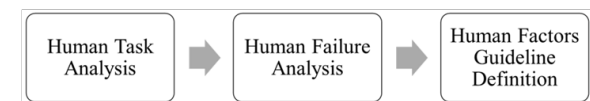
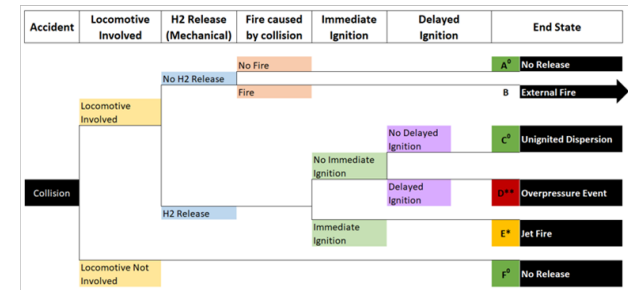
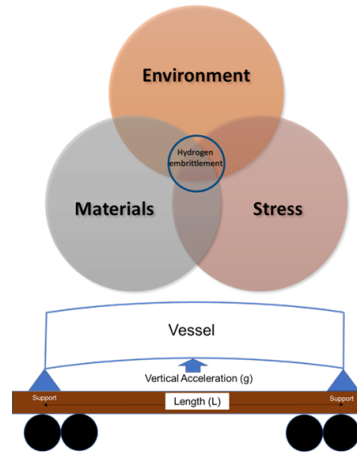

RAILROAD IMPACT

- Alternative fuels such as hydrogen provide clean and efficient propulsion for rail transportation
- In rail, hydrogen will likely be stored either as a gas or liquid. Research is needed to identify potential safety issues regarding the use of such fuel, and to develop safety recommendations.
- The project will review relevant domestic and global standards, lessons learned, and best practices for using hydrogen fuel and requirements for its use in the railroad environment.

PROJECT PARTNER

- Sandia National Laboratory

COST & SCHEDULE

- Funding, FY 2023: \$625,000
- Project Duration: September 2020 – September 2026

Hydrogen Dual Fuel Engine Development for Greenhouse Gas Emissions Reduction

PROJECT DESCRIPTION

- Direct-injected hydrogen dual-fuel concept
- Single-cylinder engine testing to demonstrate 70% hydrogen substitution
- Knock boundaries identified at high substitution rates.
- Identify safety risks, so they can be addressed.
- Determine design requirements for the safe introduction of hydrogen.

RAILROAD IMPACT

- Demonstrate at least 70% reduction in CO₂ emissions.
- Path to safely introduce hydrogen into rail industry
- Fuel flexible concept to enable phased introduction of hydrogen infrastructure
- Retrofittable technology to accelerate adoption to new and existing fleet

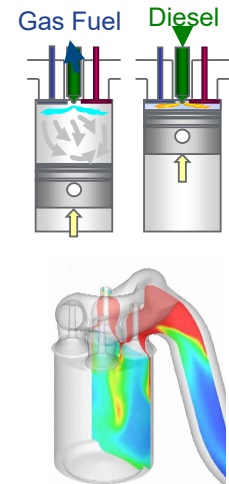
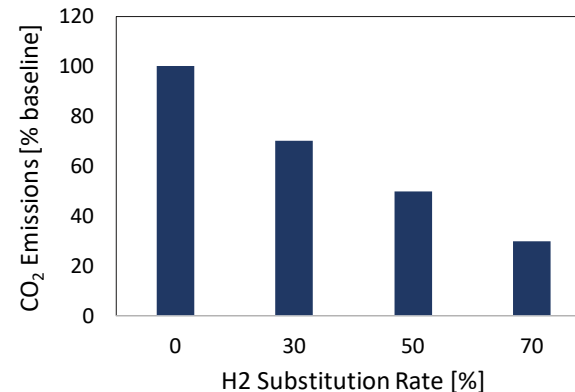

PROJECT PARTNERS

- Wabtec Corp.
- U.S. Department of Energy
- Oak Ridge National Laboratory

COST & SCHEDULE

- Funding, FY23: \$300,000
- Project Duration: September 2022 – September 2024

Biofuels for Advanced Locomotive Engines

PROJECT DESCRIPTION

- Perform scoping exercises with combustion simulation and spray visualization for different types of biofuels and renewable diesel fuel.
- Develop engine hardware and calibrate to operate with select biodiesel fuels.
- Demonstrate engine operation and responses with select alternative fuels.
- Showcase combustion engine ability to operate with reduced carbon footprint and efficient resource utilization.

RAILROAD IMPACT

- Highlight flexibility of operation with unconventional fuel sources
- Adoption of carbon neutral fuel concept
- Reduced reliance and stress on oil-based supply chain

PROJECT PARTNERS

- Argonne National Laboratory
- U.S. DOE Vehicle Technologies Office
- Progress Rail
- Convergent Science
- Chevron REG

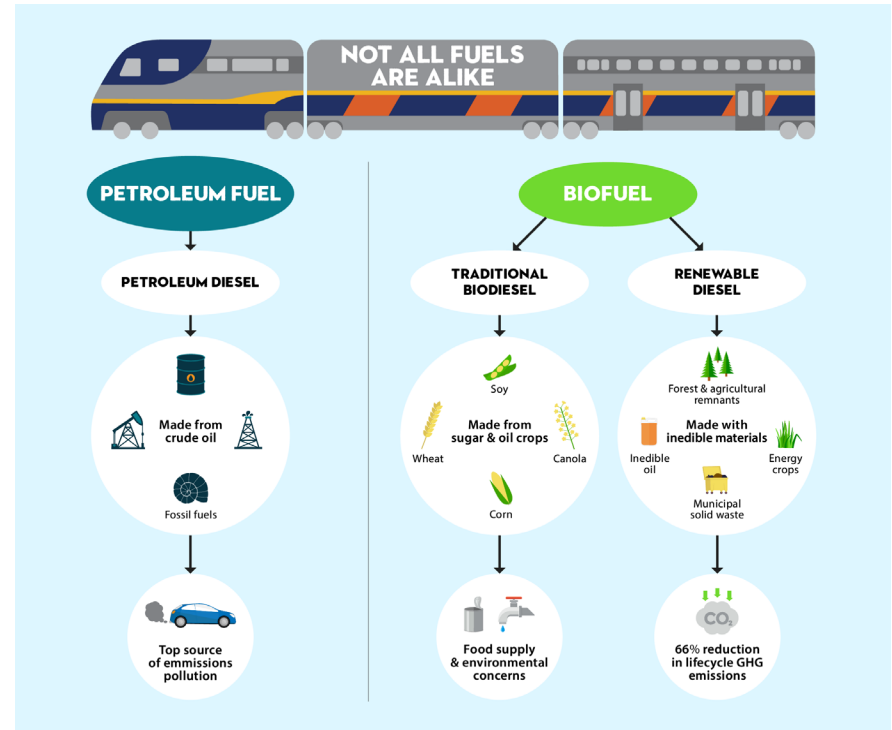

COST & SCHEDULE

- Funding: \$500,000
- Project Duration: September 2022 – August 2025

Cost and Benefit Risk Framework for Modern Railway Electrification Options

PROJECT DESCRIPTION

- Develop an updated costs-benefit framework for modern, innovative approaches to railway electrification.
- Review previous electrification studies to identify critical technical and economic barriers.
- Scan alternative technologies and operation and implementation approaches to identify solutions.
- Develop an updated cost-benefit framework that considers a carbon-focused decision environment plus uncertainty and risk in return on investment.
- Conduct a case study to show benefit and cost sensitivities.

RAILROAD IMPACT

- Holistic understanding of primary technical and economic barriers to railway electrification
- Comprehensive evaluation of new approaches to operations and implementation that improve benefits and reduce costs, timelines, and risk will also guide future research and development.
- Novel Monte Carlo framework for analyzing updated electrification benefits/costs will yield a return on investment distribution to quantify risk.
- More informed technology decisions and greater certainty in feasibility of new options to electrify.

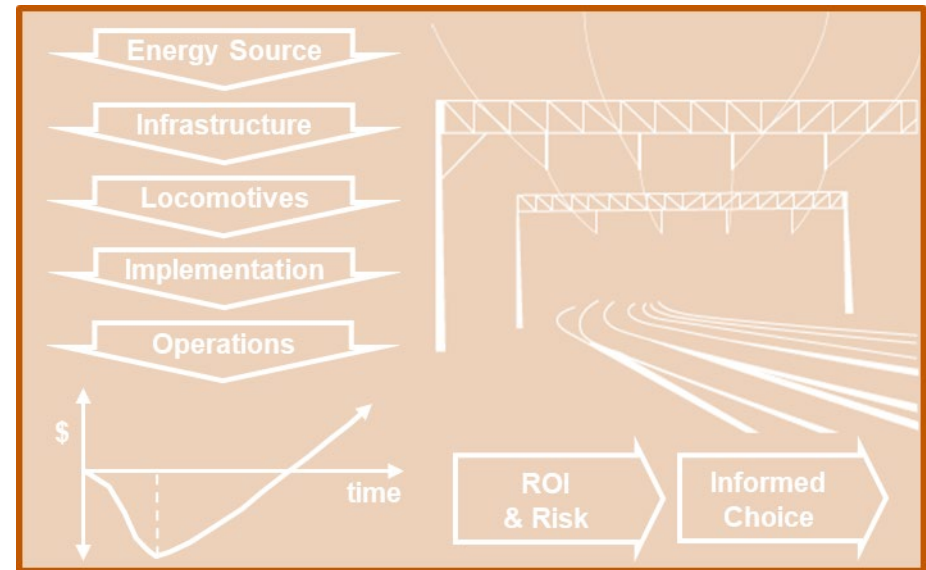

PROJECT PARTNERS

- University of Texas at Austin
- Tier 5 Locomotive LLC
- Jim Blaze, Railroad Economist

COST & SCHEDULE

- Funding, FY23: \$200,000
- Project Duration: September 2023 – August 2024

Locomotive-Waste Heat Recovery System (L-WHRS) Development

PROJECT DESCRIPTION

- Validate technical, safety and reliability performance of L-WHRS.
- Quantify the ability of L-WHRS to generate pollution-free electric power from locomotive exhaust gases under different operating conditions.
- Universalize the L-WHRS components for Wabtec locomotives and identify the Wabtec L-WHRS components that can support components retrofitting of EMD type locomotives.
- Verify the feasibility of advanced manufacturing approaches for design optimization of heat exchanger and turbo-generator components to lower production, operational, and maintenance costs.
- Optimize L-WHRS control interfaces with Siemens state-of-the-art controller.
- Quantify the energy savings and emissions reductions.
- Deliver the optimized L-WHRS design for Wabtec installations.

RAILROAD IMPACT

- Retrofitting locomotives with L-WHRS results in reduced fuel consumption and pollutant emissions by tapping otherwise wasted locomotive thermal energy and converting it to electricity distributed to supply hotel loads.
- L-WHRS represents a “free,” independent source of pollutant-free electric power that can augment locomotive electric supply availability.
- Non-invasive retrofitting of current fleet provides low-cost opportunity to lower carbon emissions from ageing fleets.
- Available power can eliminate the need to idle the locomotive engine or require a shore power connection for maintaining a climate-controlled cab.

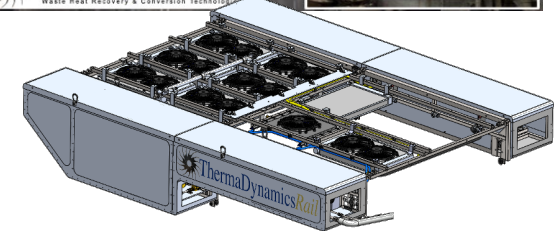
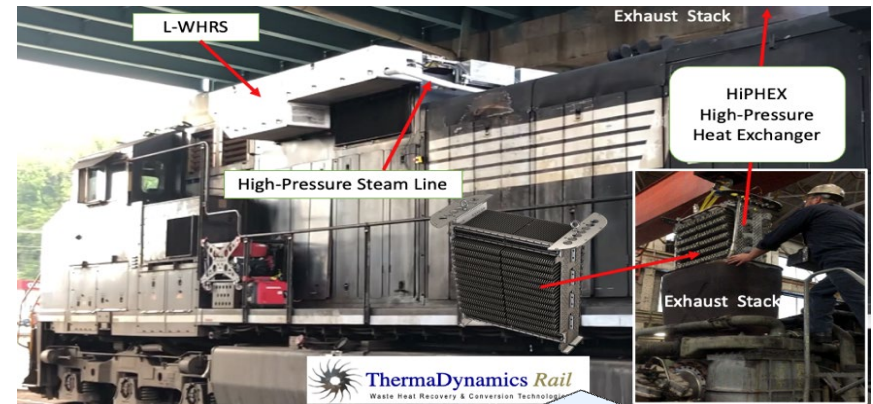

L-WHRS

PROJECT PARTNERS

- ThermoDynamics Rail LLC
- Siemens Corp.
- In-service testing railroad

COST & SCHEDULE

- Phase I Funding: \$500,000
- Project Duration: September 2023 – December 2025

Evaluation of Non-Traditional Methods of Reducing Locomotive Emissions for Shortline Railroads

PROJECT DESCRIPTION

- The project will develop an inventory of the shortline locomotive fleet, and a methodology to evaluate shortline railroad emissions.
- Phase 1: Field test non-traditional fuel technologies, including additives and injectors.
- Phase 2: Conduct follow-up testing of the same technologies in a controlled environment to enhance the certainty of the results.
- Develop and implement field and shop testing protocols to measure the exhaust emission profiles of common diesel-electric switcher and line-haul locomotives.
- CO₂, NO_x, and PM_{10/2.5} will be compared against exhaust emissions profiles of locomotives not employing the technologies using the testing protocols developed in this project.



RAILROAD IMPACT

- A greater understanding of the efficacy of the alternative technologies will encourage short line railroads to employ these alternative methods, thereby improving locomotive fuel economy and reducing locomotive emissions.
- Provide project results for discussions with the U.S. Environmental Protection Agency SmartWay program for potential integration into the Rail Carrier Tool Kit.

PROJECT PARTNERS

- American Short Line and Regional Railroad Association
- Michigan Technological University
- Chicago South Shore and South Bend Railroad
- Lake State Railway Company
- Indiana Northeastern Railroad Company
- Escanaba & Lake Superior Railroad

COST & SCHEDULE

- Funding, FY21–24: \$766,432
- Project Duration: September 2022 – December 2024

Alternative Fuels Research – Efficiency and Emissions

PROJECT DESCRIPTION

- Evaluate emissions and energy utilization of alternative fuels in freight and passenger equipment.
- Update and maintenance of rail module in Greenhouse Gases, Regulated Emissions, and Energy Use in Technologies (GREET) model.
- Review and update the energy intensity of diesel locomotives using publicly available data to develop the baseline energy use in GREET.
- Calculation of the well-to-pump fuel production and transportation energy use (by primary resource type, e.g., petroleum and hydrogen, etc.) and emissions (by category, e.g., greenhouse gases and air pollutants).
- Evaluate carbon intensity of alternative fuels and locomotive powertrain technologies (e.g., hybrid, fuel cell, and battery powertrain technologies).

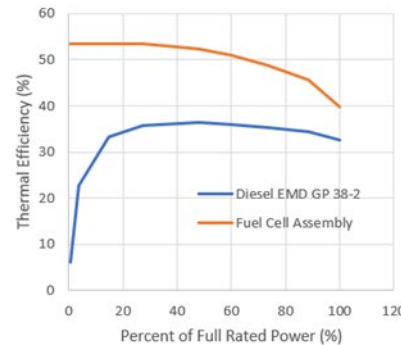

RAILROAD IMPACT

- Improve the state-of-the-art knowledge on emissions and efficiency of conventional and alternative fuels and powertrains such as hydrogen fuel cells, battery electric locomotives, and hybrid powertrains.
- Provide public tool tailored to rail applications for assessment of emissions and engine efficiency based on fuel type and powertrain selection.

PROJECT PARTNER

- Argonne National Laboratory

COST & SCHEDULE

- Funding: \$800,000
- Project Duration: August 2020 – Present

Rail Corridor Life Cycle Assessment (LCA) Framework, Factors and Models to Support Project Evaluation and Multi-Modal Comparisons

PROJECT DESCRIPTION

- Railroad corridor LCA framework of passenger and freight railway corridors
- Includes cradle to grave analysis, concentrating on track maintenance activities
- Develop protocols for data collection, impact allocation, and assessment of total CO₂ emissions impact.
- Create preliminary rail corridor LCA tools and guidance documents.
- Apply the methodology for selected passenger and freight rail corridor case studies.

RAILROAD IMPACT

- Expands benefit-cost analysis to include construction and maintenance phases through the LCA
- Provides framework for systematic and integrated application of LCA in railway environment
- Enhances capabilities to compare the environmental impact of railroad vs. other modes of transport
- Brings together railroad stakeholders to direct the process and contribute data for the LCA analysis
- Develops first generation of inventory data and preliminary tools for conducting the LCA

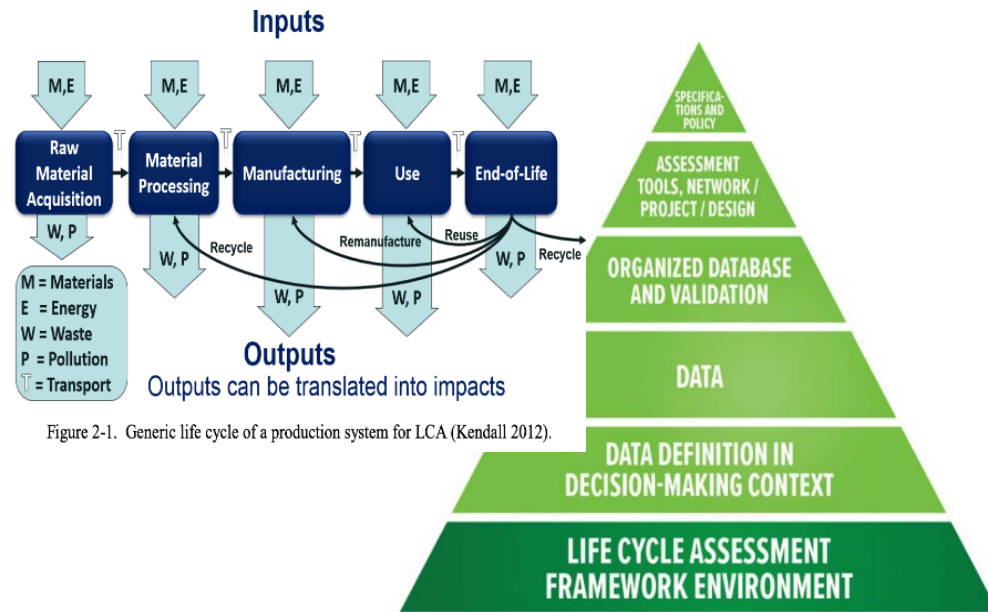

Figure 2-1. Generic life cycle of a production system for LCA (Kendall 2012).

PROJECT PARTNERS

- Michigan Tech University
- University of Texas at Austin
- Quandel Consultants
- AAR and AREMA Committees

COST & SCHEDULE

- Funding: \$611,964
- Project Duration: August 2022 – July 2025

A Risk-Informed, Decision-Making Framework for a Coastal Railroad System Subjected to Storm Hazards and Sea Level Rise

PROJECT DESCRIPTION

- Probabilistic storm simulations were developed based on synthetic hurricane data to estimate annual surge and wave values (accomplished in Year 1).
- Identify vulnerable segments of railway system (rail tracks and bridges) subjected to storm hazards (planned for Year 2).
- Provide short-term retrofit solutions to mitigate vulnerabilities in the coastal rail system (planned for Year 2).
- Integrate wind speed and sea level projections to estimate future inundated rail tracks, water levels, and wave heights.
- Provide long-term retrofit solutions to mitigate the vulnerabilities in the coastal rail system subjected to climate change and sea level rise (planned for Year 3).

RAILROAD IMPACT

- Develop an integrated, Python-based Jupyter Notebook for the railroad company to use in short-term and long-term risk-based decision-making.
- High-fidelity evaluation of storm impacts on coastal railroad with consideration of uncertainties
- More reliable coastal railroad system in upcoming storm hazards

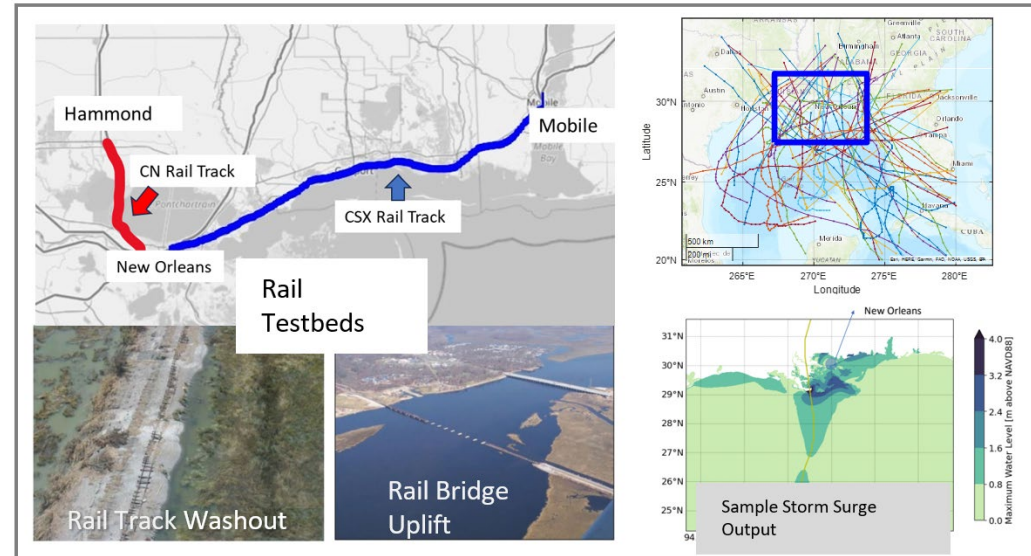

PROJECT PARTNERS

- Michigan Technological University
- Argonne National Laboratory
- Canadian National Railroad
- CSX Transportation

COST & SCHEDULE

- Funding: \$440,000
- Project Duration: May 2022 – May 2025

Passenger Fuel Tank Structural Integrity Research

PROJECT DESCRIPTION

- Identify dynamic impact loading of fuel tanks from accident investigations.
- Develop passenger fuel tank computer models.
- Evaluate conventional and alternative fuel tank designs (i.e., diesel multiple unit [DMU]) under blunt impact and raking loads.
- Conduct parametric studies.
- Present to industry stakeholders.

RAILROAD IMPACT

- The development of performance-based scenarios is intended to be used to evaluate the puncture resistance of modern fuel tank designs, such as those on DMU locomotives.
- Evaluate the structural performance of passenger fuel tank designs in accident conditions.
- Support the FRA Office of Railroad Safety in accident investigations and regulatory development efforts.
- Collaborate with the American Public Transportation Association's PRESS C&S Fuel Tank Working Group to support standard development and revision.



PROJECT PARTNER

- Volpe National Transportation Systems Center

COST & SCHEDULE

- Funding: \$430,000
- Project Duration: May 2020 – May 2023

Fire Safety and Emergency Egress Research

PROJECT DESCRIPTION

- Evaluate alternative fire performance criteria for passenger railcars and floor fire test alternatives.
- Use egress model software to analyze the alignment of egress modeling when coupled with fire prediction models.
- Participate in meetings of the National Fire Protection Association's 130 Committee to develop and maintain industry standards for fire safety in passenger railcars.

RAILROAD IMPACT

- Increase knowledge to better quantify rapid and easy egress from passenger railcars.
- Support the advancement of fire safety policies and standards for passenger railcars.

PROJECT PARTNER

- Volpe National Transportation Systems Center

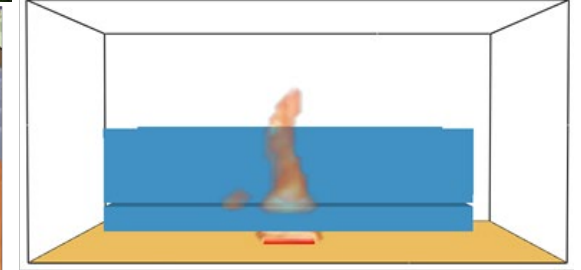
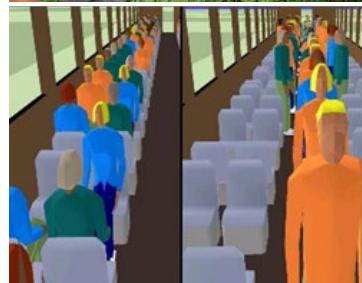

COST & SCHEDULE

- Funding: \$410,000
- Project Duration: September 2019 – August 2024

Material Fire Performance Longevity

PROJECT DESCRIPTION

- Investigate potential decay in the fire performance of passenger railcar materials over time.
- Assess the performance of older, in-use materials and identify possible methods to ensure materials have not degraded in performance.
- The first funding increment includes identifying materials sourcing and documenting preliminary test specifications.

RAILROAD IMPACT

- Increase knowledge on the expected longevity of material fire performance.
- Gain understanding on the difference in fire test results from the actual materials present in the passenger railcars and the original material composition.

PROJECT PARTNER

- Volpe National Transportation Systems Center



COST & SCHEDULE

- Funding: \$55,000
- Project Duration: October 2023 – August 2024

Scaling Model Validation for Rail Car Geometries

PROJECT DESCRIPTION

- Analyze the scaled railcar heat release rate (HRR) test data to assess the validation of scaling laws for rail car type geometries.
- Validate the Fire Dynamics Simulator (FDS), a computational fluid dynamics (CFD) model, using the experimental data created during scaled rail car testing.
- Predict the HRR for a full railcar using the validated FDS model.
- Publish a technical report documenting the findings of this research.
- Disseminate research findings to industry stakeholders, design engineers, and the National Fire Protection Association.



RAILROAD IMPACT

- The scaling laws validated in this research reduce the size of the experiment while preserving the key physics behind it, providing a means to cost-effective testing without compromising the safety of rail vehicles.
- The validated model can be used to evaluate “what-if” scenarios involving geometric and combustible material variations, increasing the overall understanding of fire hazards.
- Research will significantly improve safety, as the design engineers will have the right tools to quantify the hazard and design mitigation measures.

PROJECT PARTNER

- Jensen Hughes

COST & SCHEDULE

- Funding FY23: \$205,217
- Project Duration: June 2023 – December 2024

Floor Fire Resistance Qualification Testing

PROJECT DESCRIPTION

- Perform large-scale floor fire tests and computer modeling using designs from industry to develop the boundary conditions for NFPA 130 fire testing that represent the end-use conditions.
- Validate thermal and structural finite element models using large-scale test data.
- Explore the alternative testing option based on a temperature-based failure threshold.
- Publish a technical report documenting the findings of this research.
- Disseminate research findings to industry stakeholders, design engineers, and the National Fire Protection Association.

RAILROAD IMPACT

- Research findings will highlight the safety concerns of having a partial wall buildup along the floor.
- The temperature-based approach proposed in this research will reduce the test-to-test variability and provide feasibility for using a smaller furnace to evaluate the floors.
- The validated model can be used to evaluate “what-if” scenarios and explore other testing alternatives.
- Research will significantly improve safety as it will highlight the shortcomings of existing qualification testing methodology and provide guidance to improve the test method, increasing the overall safety of railcar floors.

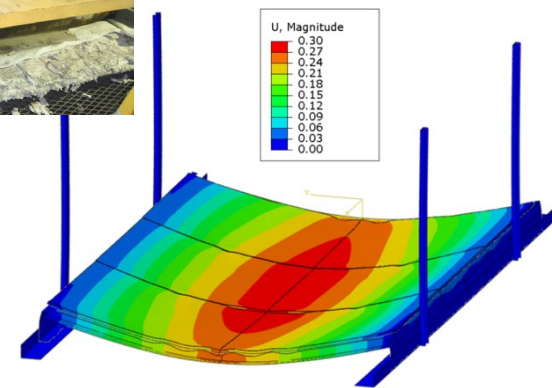
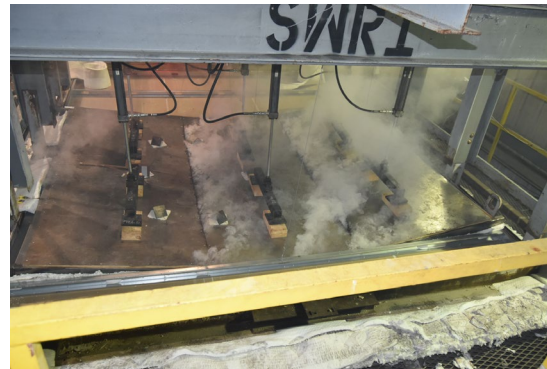

PROJECT PARTNERS

- Jensen Hughes

COST & SCHEDULE

- Funding FY23: 193,430
- Project Duration: June 2023 – December 2024

PROJECT DESCRIPTION

- Construct a probabilistic framework to quantify egress time distribution.
- Assess the impact of the operating environment on egress out of the railcar to the point of safety.
- Assess the egress time involving a railcar with sleeping accommodation.
- Publish a technical report documenting the findings of this research.
- Disseminate research findings to industry stakeholders, design engineers, and the National Fire Protection Association.



RAILROAD IMPACT

- Research findings will highlight what data is available to validate egress models for rail-specific applications.
- Research will identify features that are required for egress through rail cars in an egress model.
- Assessing the impact of the operational environment, such as tunnels, on egress to a safe location will provide a methodology to quantify the hazard and design mitigation measures.
- Probabilistic framework will help understand model input parameter sensitivities and provide guidance on designing future egress trials.

PROJECT PARTNERS

- Jensen Hughes

COST & SCHEDULE

- Funding FY23: 105,593
- Project Duration: June 2023 – December 2024

Collision Safety and Wheeled Mobility Devices (WhMDs)

PROJECT DESCRIPTION

- The objective of this project is to evaluate the effectiveness of strategies to protect train passengers seated in wheeled mobility devices (WhMDs) and nearby passengers during train accidents.
- Three strategies (two rear-facing and one forward-facing) were successfully tested in the 2022 locomotive train-to-train impact test.
- Sled tests are planned to evaluate autonomous WhMD protection system(s) for forward-facing occupants, using the 8g crash pulse specified in 49 CFR 238.233 and APTA PR-CS-S-016 for passenger seats.
- The anticipated outcome is a demonstration of the safety benefits of autonomous WhMD securement during an 8g simulated train accident.



RAILROAD IMPACT

- Previous research demonstrated improved safety when WhMDs and occupants were compartmentalized (rear-facing) and restrained (rear- and forward-facing) but using the forward-facing restraint system required assistance.
- Feedback from the user community made it clear that strategies that could be used independently would be more readily adopted.
- The goal of the planned work is to demonstrate the need for, and ease of use of, a forward-facing occupant protection strategy.

PROJECT PARTNERS

- Volpe National Transportation Systems Center
- Oregon State University
- Q'STRAIT, Inc.

COST & SCHEDULE

- Funding, FY23: \$200,000
- Project Duration: May 2023 – Oct 2024



SECTION THREE

TRAIN CONTROL & COMMUNICATION

TTC Signaling and PTC Systems Rehabilitation and Configuration Management

PROJECT DESCRIPTION

- Survey and inventory existing signaling and Positive Train Control (PTC) systems on the Railroad Test Track (RTT) and Transit Test Track (TTT) at the Transportation Technology Center (TTC).
- Develop signaling and PTC systems upgraded designs to accurately represent rail revenue service environments.
- Implement the upgraded designs and recommission the signaling and PTC systems at the TTC.
- Develop a configuration management plan for the systems to support operation and testing.
- Develop a long-term maintenance plan of the infrastructure.

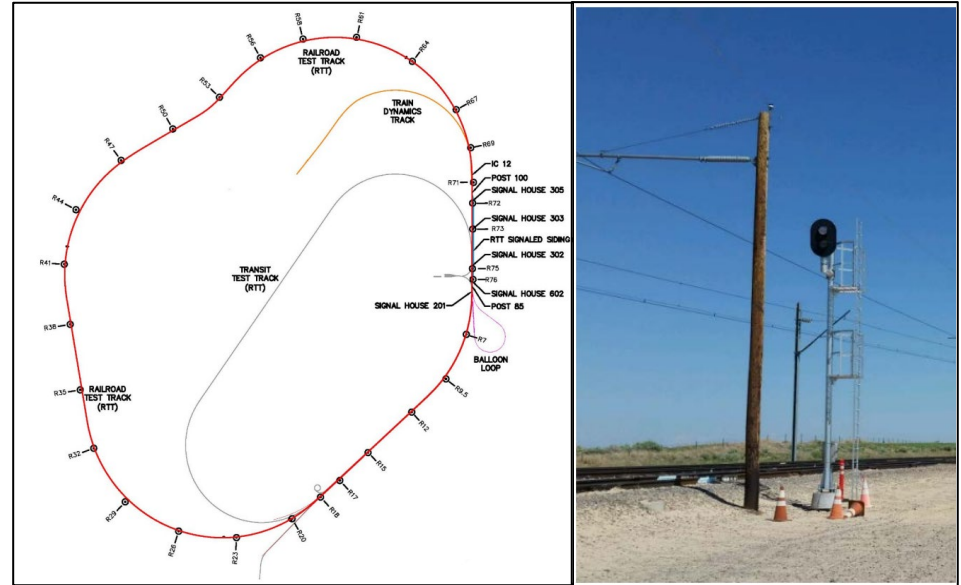

RAILROAD IMPACT

- Enhance testing capabilities of TTC.
- Provide safety to operations and testing on the RTT and TTT tracks at TTC.
- Provide a modern platform to support testing of new signaling and PTC equipment.

PROJECT PARTNER

- ENSCO, Inc.

COST & SCHEDULE

- Funding: \$5,023,697
- Project Duration: August 2023 – February 2025

TTC Grade Crossing Protection System Upgrade

PROJECT DESCRIPTION

- Survey and inventory existing active grade crossing protection systems at Post 100 and Post 85 of the Transportation Technology Center (TTC).
- Develop active grade crossing protection systems designs to accurately represent the current state of the technology.
- Implement the designs and recommission the active grade crossing protection systems at Post 100 and Post 85 of TTC.
- Develop a configuration management plan for the systems to support operation and testing.
- Develop a long-term maintenance plan of the infrastructure.

RAILROAD IMPACT

- Improve safety to railway and road operations during testing on the railroad tracks that cross Post 85 and Post 100 at TTC.
- Provide a modern platform to support testing of new grade crossing protection systems.
- Enhance grade crossing capabilities to support potential testing of the other transportation modes involved in the grade crossing safety.



PROJECT PARTNER

- ENSCO, Inc.

COST & SCHEDULE

- Funding: \$1,587,684
- Project Duration: August 2023 – August 2024

C-V2X Train Arrival and Departure Information at Grade Crossings – Assessment

PROJECT DESCRIPTION

- Evaluate the performance and analyze the feasibility of C-V2X (Cellular–Vehicle-to-Everything) communication to provide real-time train status (i.e., position, speed, and heading information) and predicted train approaching and departure information to connected vehicles at grade crossings via field testing.
- Design, build, and test C-V2X 4G/5G-based rail crossing violation warning (RCVW) architecture to support passive grade crossing warning.
- Evaluate a cloud-based solution for predicted signal, phase, and timing (SPAT) for grade crossings.
- Develop train-specific messaging requirements and advocate for their inclusion in SAE/IEEE communication standards.

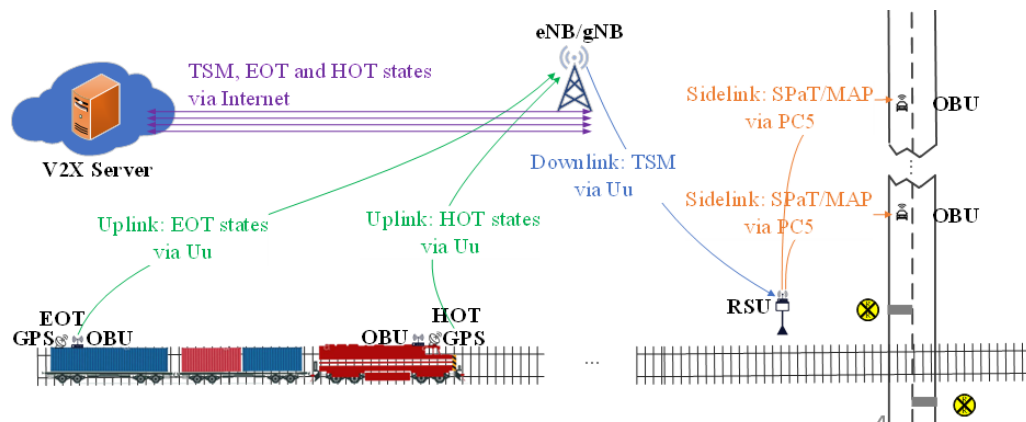

RAILROAD IMPACT

- Propose and analyze a solution to expand the RCVW architecture to support passive grade crossings which enhances the applicability of the architecture.
- The proposed solution and feasibility assessment will provide guidance on future research needs and/or prototypes that improve safety of connected vehicles at grade crossings.
- Improve grade crossing safety.

PROJECT PARTNERS

- ENSCO, Inc.
- Michigan Technological University

COST & SCHEDULE

- Funding: \$1,258,514
- Project Duration: August 2023 – August 2025

Grade Crossing Toolkit

PROJECT DESCRIPTION

- Support the development of a highway-rail grade crossing safety measures toolkit, like the rail ROW trespass mitigation measures toolkit currently under development by FRA.
- This toolkit will contain guides, noteworthy practices, and research results on implementing a wide range of grade crossing safety treatments.
- Such a resource has been developed in Europe and is widely used (SAFER-LC Toolbox [<https://safer-lc.eu/>]).
- FRA has developed a toolkit for rail trespass and suicide treatments (<https://trespasstoolkit.fra.dot.gov/>) and has identified the need for a similar resource repository for grade crossing safety countermeasures for US stakeholders.

RAILROAD IMPACT

- Provides FRA's partners with information on cutting edge technologies and/or strategies for grade crossing safety.
- Foster an exchange of information on grade crossing safety countermeasures between all stakeholders.
- Facilitate the implementation and evaluation of innovative safety technologies.
- Facilitate the development of site-specific strategies for grade crossings, thereby improving rail safety.

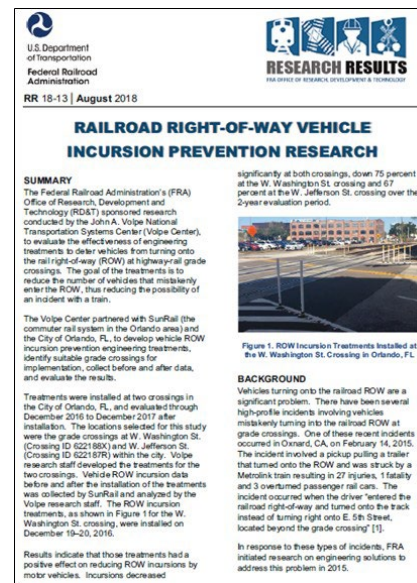
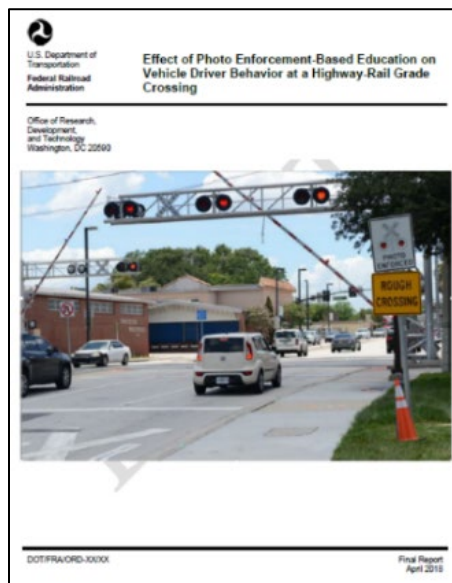

PROJECT PARTNER

- Volpe National Transportation Systems Center

COST & SCHEDULE

- Funding: \$225,000
- Project Duration: July 2021 – March 2024

Grade Crossing and Trespass Research Program Support

PROJECT DESCRIPTION

- Provide program management, quick response, conduct special studies not covered in any existing task, and support other requests requiring immediate attention.
- Participate in professional activities within the scope of research topic which are not specifically funded under another task (e.g., TRB AHB60 Committee, AREMA, ITE, technical papers).
- Exchange information on cutting edge technologies and/or strategies for grade crossing safety and trespass prevention.
- Provide reports to define and track key activities on a periodic basis in support of the research program.

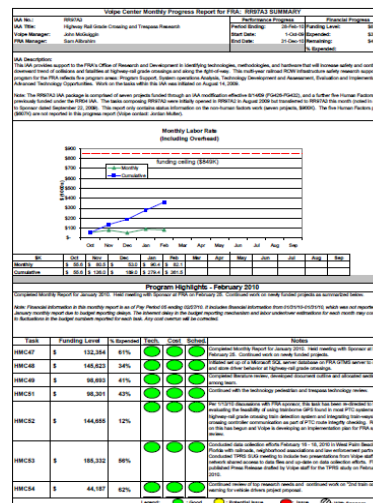

RESEARCH RESULTS
FRA OFFICE OF RAILROAD POLICY & DEVELOPMENT

Proceedings of the 4th Joint Rail Conference
April 24, 2016, Concord Springs, Concord, NH

JRC2014-3744

EFFECT OF DYNAMIC DEVELOPE PAVEMENT MARKINGS ON VEHICLE DRIVER BEHAVIOR AT A HIGHWAY/RAIL GRADE CROSSING

8401 Gates Blvd.
US DOT VDOT Center
College Park, MD, USA

8401 Gates Blvd.
US DOT VDOT Center
College Park, MD, USA

Mario Bedini
US DOT VDOT Center
College Park, MD, USA

ABSTRACT
The U.S. Department of Transportation (DOT) and the U.S. Department of Transportation (DOT) have a long history of research on the safety of grade crossings. This research was conducted as part of the U.S. Department of Transportation's (DOT) research on the safety of grade crossings. The research was conducted as part of the U.S. Department of Transportation's (DOT) research on the safety of grade crossings. The research was conducted as part of the U.S. Department of Transportation's (DOT) research on the safety of grade crossings.

RAILROAD IMPACT

- Provide for information exchange with State DOTs and railroads on cutting edge technologies and/or strategies for grade crossing safety and trespass prevention.
- Provide quick response.
- Provide support on studies requiring immediate action not covered in any existing task.



PROJECT PARTNER

- Volpe National Transportation Systems Center

COST & SCHEDULE

- Funding: \$314,945
- Project Duration: July 2021 – July 2026

Enhanced Emergency Notification System (ENS) Signage Research

PROJECT DESCRIPTION

- Evaluate the effectiveness of adding a “NOTICE” sign (MUTCD W16-18P) to the existing ENS sign at highway-rail grade crossings.
- Adding the NOTICE sign may increase ENS sign visibility to the public. To this end, Volpe is supporting FRA in partnering with a transit agency to evaluate the impact of adding these signs on ENS sign visibility.
- The Massachusetts Department of Transportation (MassDOT), in collaboration with FRA’s Office of Railroad Safety, have submitted a request for experimentation to the FHWA for this signage combination.
- The following research activities are anticipated: site selection, baseline data collection, installation, post data collection, and analysis/reporting.



RAILROAD IMPACT

- Identify and evaluate potential location and enhancements of current ENS signs to increase visibility/conspicuity to the public.
- Potentially provide incident-preventing warnings to the operating railroad ahead of a potential crash at a crossing due to a stalled or stuck vehicle.
- Provide supported analysis for potential legislative processes.
- Provide partnerships with State DOTs and railroads.

PROJECT PARTNERS

- Volpe National Transportation Systems Center
- MassDOT
- Massachusetts Bay Transportation Authority
- Metra (anticipated)

COST & SCHEDULE

- Funding: \$100,000
- Project Duration: March 2023 – September 2024

Grade Crossing Lights Flash Rate Research

PROJECT DESCRIPTION

- Research the effectiveness of changing the flash rate of grade crossing flashers on driver compliance with grade crossing warning devices.
- The Massachusetts Department of Transportation (MassDOT), in collaboration with FRA's Office of Railroad Safety (RRS), have submitted a request for experimentation to the FHWA for this technology.
- RRS requested support from FRA's Office of Research, Development, and Technology with evaluation of the technology and effect on driver compliance at a grade crossing (Crossing ID 546729P) on the Massachusetts Bay Transportation Authority (MBTA) system in Canton, MA.
- Volpe researchers will collect data at the crossing before and after the installation of rapid flashing LED flashers and evaluate driver compliance.

RAILROAD IMPACT

- Develop, implement, and evaluate techniques or technologies that reduce violations of grade crossing traffic control devices that may lead to incidents and casualties. (There were 2,197 incidents and 274 fatalities at crossings in 2022.)
- Facilitate the implementation and evaluation of innovative safety technologies.
- Provide FRA's partners with information on cutting edge technologies and/or strategies for grade crossing safety.
- Strengthen partnerships with State DOTs and railroads.



PROJECT PARTNERS

- Volpe National Transportation Systems Center
- MassDOT
- MBTA
- Keolis America, Inc.

COST & SCHEDULE

- Funding: \$200,000
- Project Duration: February 2023 – December 2024

Innovative Pedestrian Treatments

PROJECT DESCRIPTION

- Review, select, and evaluate emerging technologies and their applications for detecting and warning pedestrians violating grade crossing protection devices.
- New technologies or approaches to mitigate this problem, such as pedestrian warning boxes currently operational in Belgium, will be investigated for possible demonstration at high-risk locations.
- Further development and evaluation of Artificial Intelligence (AI) tools for pedestrian trespass detection will also be investigated.

RAILROAD IMPACT

- Demonstrate and evaluate new technologies and strategies that increase pedestrian safety at grade crossings. (There were 163 pedestrian incidents at grade crossings in 2022 – about 7% of the total crossing incidents.)
- Strengthen partnerships with State DOTs and railroads.
- Facilitate implementation and evaluation of innovative safety technologies.
- Provide information exchange with rail safety partners on cutting edge technologies and/or strategies.

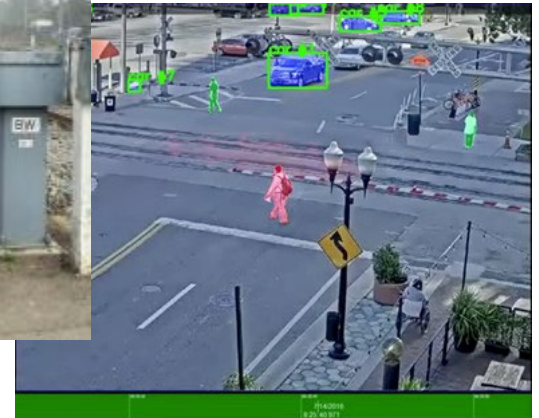

PROJECT PARTNER

- Volpe National Transportation Systems Center

COST & SCHEDULE

- Funding: \$200,000
- Project Duration: March 2023 – March 2024

SSM/ASM Effectiveness in Quiet Zones

PROJECT DESCRIPTION

- Study the effectiveness of Supplementary Safety Measures (SSMs) and Alternative Safety Measures (ASMs) when implemented in quiet zones by collecting incident data at grade crossing before and after the installation of SSMs and ASMs.
- Localities desiring to establish a quiet zone are first required to mitigate the increased risk at grade crossings caused by the absence of a horn, typically with SSMSs, such as gates with channelization or medians, four-quadrant gates, one-way streets with gates, or crossing closures.
- SSMs are engineering improvements which, when installed at highway-rail grade crossings within a quiet zone, reduce the risk of a collision at the crossing.



RAILROAD IMPACT

- Provide updated safety measure effectiveness ratings. Current effectiveness ratings were developed 15+ years ago and need updating.
- Provide supported analysis for potential legislative processes.

PROJECT PARTNERS

- Volpe National Transportation Systems Center

COST & SCHEDULE

- Funding: \$250,000
- Project Duration: March 2023 – March 2024

Grade Crossing Safety and Railroad Trespass Prevention Workshops Support

PROJECT DESCRIPTION

- Support planning and running the grade crossing safety and railroad trespass prevention workshops in FY23–24.
- Coordinate, facilitate, and document the workshops.
- The workshops focus on raising awareness of the dangers and effects of grade crossing and trespass incidents, to seek out low-cost solutions, and to discuss practical ideas for technological improvements for vehicular and pedestrian safety at highway-rail grade crossings.
- These summits are one of the action items listed in FRA's National Strategy.
- <https://www.fra.dot.gov/conference/2022/GXTP/>



RAILROAD IMPACT

- Provide partnerships with State DOTs, railroads, and other stakeholders.
- Provide for information exchange with rail safety partners on cutting edge technologies and/or strategies.
- Reduce the number of grade crossing and rail right-of-way trespass incidents.
- Increase public safety.

PROJECT PARTNERS

- Volpe National Transportation Systems Center
- State DOTs
- Railroads
- Academia
- Industry

COST & SCHEDULE

- Funding: \$50,000
- Project Duration: March 2023 – March 2024



SECTION FOUR

HUMAN FACTORS

Ensuring the Safe Operation of Automated or Partially Automated Locomotives: The Role of Driver-State Monitoring (DSM) Systems

PROJECT DESCRIPTION

- Use a locomotive simulator to set up and validate two automotive DSM systems.
- Determine roles and requirements for DSM systems by monitoring alertness and developing criteria for human intervention when automation fails.

RAILROAD IMPACT

- Successful completion of this project will offer an alternative to the current alerter-system found in locomotives to affect operator alertness.
- Help determine whether automobile driver state monitoring systems can be used effectively in locomotives.
- Help determine design requirements for vehicle operator alerter systems.

PROJECT PARTNERS

- Virginia Tech Transportation Institute
- TrueSafety Evaluation, LLC



COST & SCHEDULE

- Funding, FY24: \$338,290
- Project Duration: June 2022 – June 2024

Assessments for Better Operator Artificial Intelligence-Centered Research and Development

PROJECT DESCRIPTION

- Develop a test and evaluation (T&E) framework for assessing human-autonomy/AI interactions in intelligent rail software applications.
- Determine requirements for a T&E software architecture for assessing human-autonomy/AI performance issues when introducing new AI in rail operations.
- Demonstrate and evaluate human-AI T&E capability.

RAILROAD IMPACT

- T&E requirements for intelligent rail applications in actual, simulated, or real-world settings
- Provides methodology and scientifically principled basis to anticipate human role changes with the introduction of intelligent rail systems
- Helps develop safer rail systems that use AI by addressing potential human-AI interaction operational risks

PROJECT PARTNERS

- Charles River Analytics, Inc.
- SA Technologies
- Roth Cognitive Engineering
- Wabtec Corp.

COST & SCHEDULE

- Funding: FY24
- Phase I: \$424,977
 - POP 1–12 months
- Phase II: \$199,961
 - POP 13–24 months

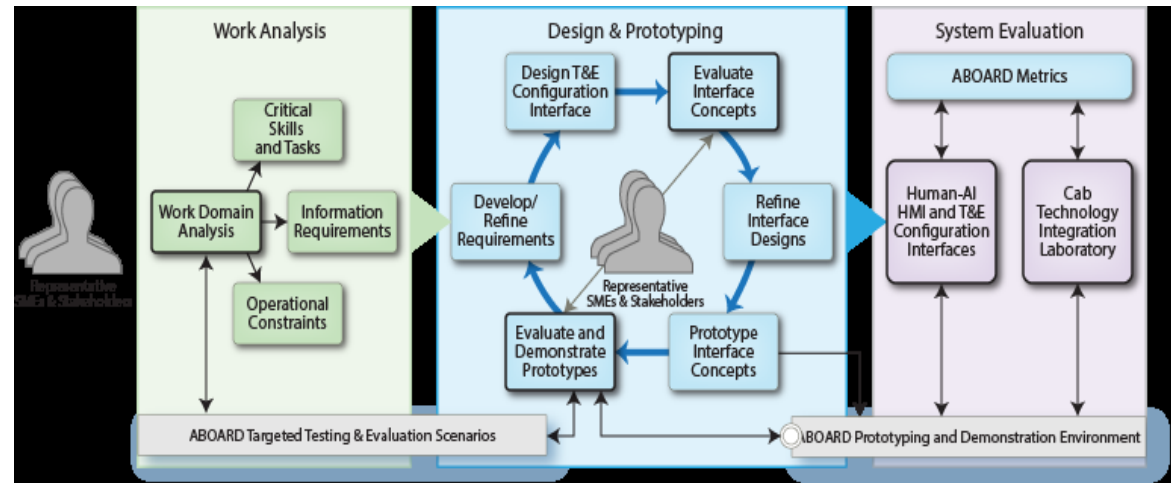

Multi-Disciplinary Approach to Developing and Evaluating the Human Factors in an AI-Powered Rail Crossing Infotainment System

PROJECT DESCRIPTION

- Conduct literature review to identify development and testing considerations for AI systems for human interaction through vehicle infotainment systems.
- Develop infotainment systems using Apple CarPlay and Android Auto to reduce the exposure of vehicle interactions with active crossings.
- Conduct lab and field tests to evaluate systems' ability to reduce the exposure of vehicles with active grade crossings, while evolving the best practices in human factors research to provide guidance for AI systems that interact with people to provide traveler routing information.

RAILROAD IMPACT

- Address public and railroad demand to reduce the exposure of vehicles interacting with the railroad network.
- Evaluate new approaches to providing active crossing warnings to motorists.
- Identify considerations for autonomous vehicles to avoid interactions with active crossings.

COST & SCHEDULE

- Funding, FY24: \$329,600
- Project Duration: January 2024 – March 2025

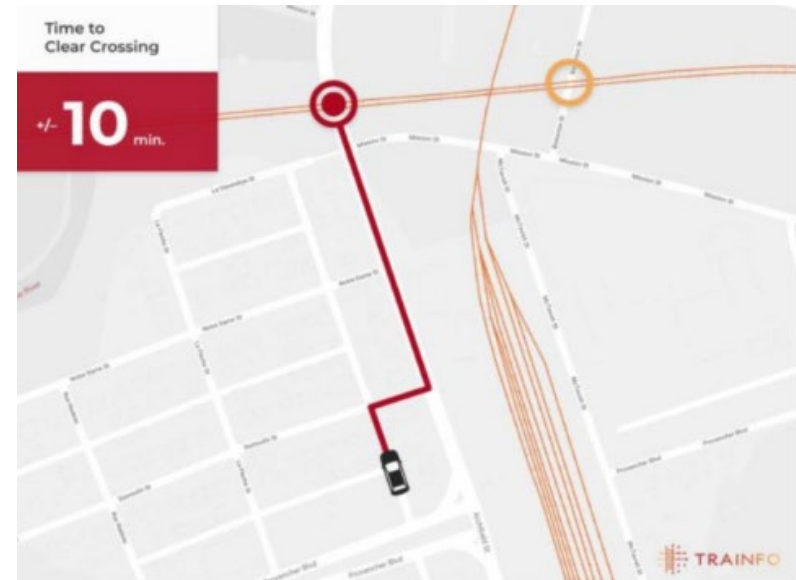

PROJECT PARTNERS

- TRAINFO Corp.
- KEA Technologies
- City of Houston
- Florida DOT

Lightweight Evaluation, Training, and User Collaboration for Human-AI Work Systems in Rail Operations

PROJECT DESCRIPTION

- Provide recommendations and guidelines for improving human use of intelligent systems in rail operations.
- Make recommendations on using existing human-centered approaches and assessing and improving intelligent systems/AI.
- Provide lightweight evaluation methods and support both early human-centered development and later assessments of effectiveness.
- Provide user training and support with complementary approaches (e.g., tutorials, user guides, and collaborative explanations).
- Human subjects/user studies to help tailor, adapt, and validate these systems for FRA contexts.

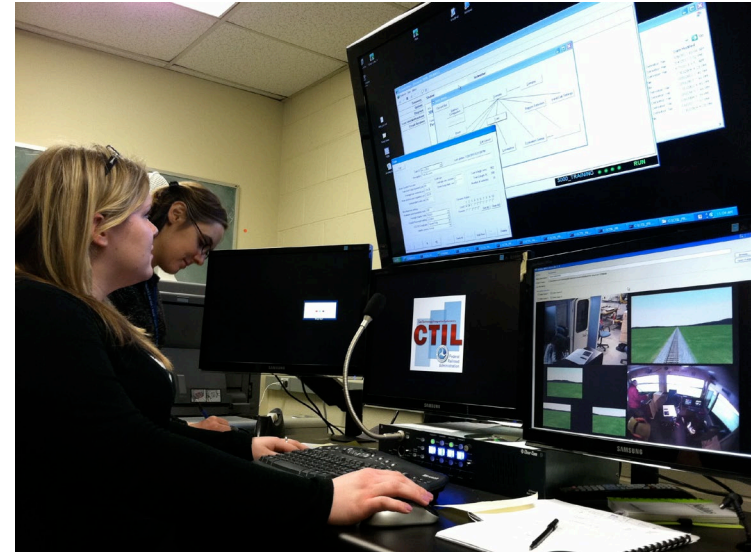

RAILROAD IMPACT

- Provide lightweight evaluation methods and tools to enable a human-centered design focus for rail vendors, developers, and other stakeholders of systems employing artificial intelligence.

PROJECT PARTNERS

- Michigan Tech Rail Transportation Program
- Michigan Tech Department of Cognitive and Learning Sciences

COST & SCHEDULE

- Funding, FY24: \$326,237
- Project Duration: 24 months

User Centered Design (UCD) for User Research

PROJECT DESCRIPTION

- Improve understanding of human risk behavior with focus on contributing social factors.
- Identify human error and risk as cause for potential improvement.
- Improve rail safety when rail crossing system function is inconsistent with user interaction.
- Apply proven UCD process to demonstrate modeling of risk behaviors.
- Define information and functionality for the railroad systems to mitigate trespass behavior.

RAILROAD IMPACT

- Improve safety by reducing risk behaviors.
- Knowledge base for social and community factors for stakeholders to access for functional requirements
- Behavioral understanding of trespass social factors and community-based factor to improve future designs
- Robust statistical models to focus useful data across industry and to drive FRA strategic goals
- System models for stakeholder alignment, qualitative values and behavioral designs

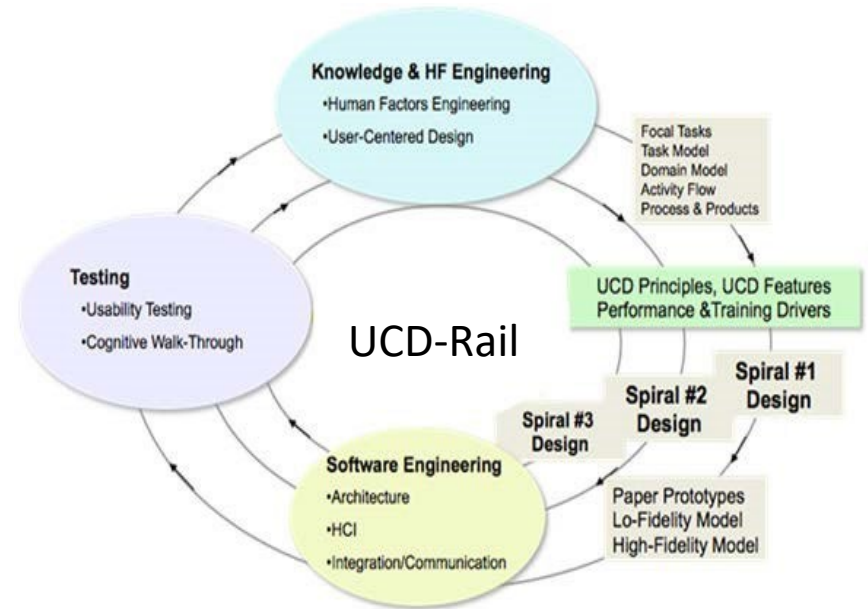

PROJECT PARTNER

- Monterey Technologies, Inc.

COST & SCHEDULE

- Funding, FY24: \$360,000
- Project Duration: October 2023 – October 2024

Designing Crew Resource Management (CRM) Training to Improve Communication and Reduce Human Error Potential in the Locomotive Cab

PROJECT DESCRIPTION

- Develop and evaluate a CRM learning experience with high operational relevance and utility to improve rail operator team interactions and detection of potential errors.
- Design an integration strategy to facilitate adoption.
- CRM is a human factors training process to help crews reduce and recover from errors resulting from poor team communication, leadership, and decision making.
- While CRM has been recommended for use in the rail industry, it has not been broadly integrated.



RAILROAD IMPACT

- CRM leverages concepts and approaches that are well-established and validated through extensive application in civilian and military aviation and other safety-critical industries.
- Prototyped and evaluated CRM learning experience, with high operational relevance and utility, could substantially improve team communication and coordination practices of rail operators thereby enhancing operator ability to anticipate, reduce, and/or recover from errors.

PROJECT PARTNERS

- TiER1 Performance Solutions
- Locomotive Engineers
- Rail Subject Matter Experts

COST & SCHEDULE

- Funding, FY24: \$585,736
- Project Duration: September 2022 – September 2024

CRISI Grant: Iowa Northern Railway (IANR) Education and Training Program

PROJECT DESCRIPTION

- The Human Factors Division provides subject matter expertise to support a CRISI grant to IANR.
- Under the CRISI grant, IANR is developing in-person and simulator training curricula for shortline railroads.
- The Human Factors Division provides conceptual and practical guidance for grantees to develop:
 1. Virtual and in-person technical training courses related to safety regulations and practices and compliance with them;
 2. A customized learning management system (LMS) to deliver the technical courses, track participation, and deliver assessments; and
 3. In-person locomotive simulator education and training.



RAILROAD IMPACT

- This project will provide short line railroads (largely located in rural areas) with the opportunity to participate in a broad range of industry-specific technical training via an online training platform and/or in-person seminars.

PROJECT PARTNERS

- Iowa Northern Railway
- American Short Line and Regional Railroad Association

COST & SCHEDULE

- Funding: CRISI Grant
- Project Duration: July 2021 – July 2027

Fatality Analyses of Maintenance-of-Way Employees and Signalmen (FAMES)

PROJECT DESCRIPTION

- FRA's Human Factors Division assists the Fatality Analysis of Maintenance-of-Way Employees and Signalmen (FAMES) stakeholder committee by supporting the creation of committee charters, communication and outreach, and database maintenance and analysis.
- The FAMES Committee analyzes fatalities and other incidents, focusing on identifying risks, trends, and factors affecting roadway worker safety.

RAILROAD IMPACT

- With support from the Human Factors Division, the FAMES Committee issues findings and recommendations to reduce the risk of future occurrences and eliminate fatalities to roadway workers.

PROJECT PARTNERS

- FRA Office of Railroad Safety
- Labor Unions
- Association of American Railroads
- American Short Line and Regional Railroad Association

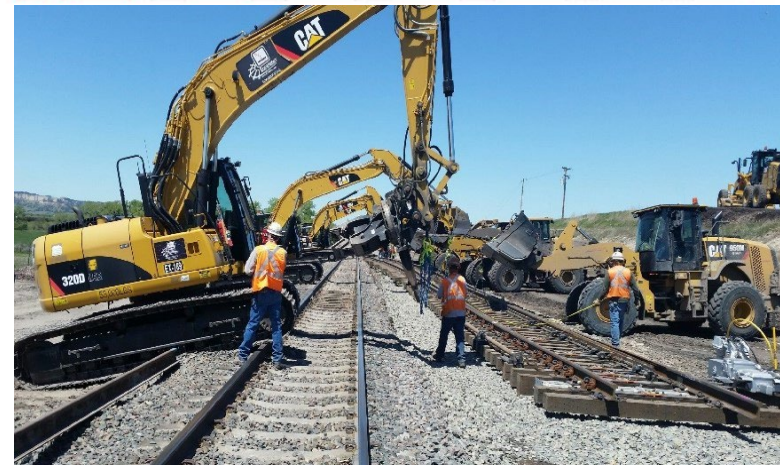

COST & SCHEDULE

- Funding: N/A
- Project Duration: FY09 – present

Human Factors Assessment of the Dispatcher Role to Develop Requirements for Artificial Intelligence (AI) Use

PROJECT DESCRIPTION

- The research team will conduct in-depth human factors analyses of the dispatcher role, including cognitive work and workflow, tools and technology used, and areas of inefficiency and error vulnerability.
- The analysis will identify requirements for AI tools to enhance efficiency and reduce human error potential in rail operations.



RAILROAD IMPACT

- This work provides a research foundation for integrating AI to support dispatcher assessments, planning, and decision making.
- It also provides direction for dispatcher role design, work processes, and dispatcher training.

PROJECT PARTNER

- TiER1 Performance Solutions

COST & SCHEDULE

- Funding, FY24: \$297,699
- Project Duration: 18 months

Switching Operations Fatalities Analysis (SOFA)

PROJECT DESCRIPTION

- FRA's Human Factors Division provides ongoing support for the FRA SOFA stakeholder committee by supporting the creation of committee charters, communication and outreach, and database maintenance and analysis.
- The SOFA Committee analyzes fatalities and other incidents, focusing on identifying risks, trends, and factors affecting switching fatalities.

RAILROAD IMPACT

- With support from the Human Factors Division, the SOFA Committee can issue findings and recommendations to reduce the risk of future occurrences and eliminate switching-related fatalities.

PROJECT PARTNERS

- FRA Office of Railroad Safety
- Labor Unions
- Association of American Railroads
- American Short Line and Regional Railroad Association



COST & SCHEDULE

- Funding: N/A
- Project Duration: 1998 – present

Railroad Information Sharing Environment (RISE)

PROJECT DESCRIPTION

- RISE is a data trust, a voluntary, non-regulatory, evidence-driven safety partnership between FRA and railroad industry stakeholders.
- Railroad stakeholders voluntarily share data and work collaboratively to address complex railroad safety challenges.
- The goal of this public-private partnership is to use data for safety improvements that would be difficult for individual railroads to achieve on their own.
- University of Maryland's Center for Advanced Transportation Technology Laboratory (CATT Lab) serves as the third-party vendor and manages the data.
- CATT Lab and Volpe are developing the RISE program and testing the program's feasibility.

RAILROAD IMPACT

- Participation in RISE provides stakeholders with the ability to collaboratively address safety-critical topics.
- RISE is an opportunity for railroad stakeholders to bring multiple sources of data and expertise to solve complex railroad issues.
- By combining data across multiple sources, stakeholders can identify trends that are difficult to detect in the data from any single stakeholder.
- Data aggregation makes it possible to identify emerging issues and propose solutions to those problems earlier.



Railroad Information Sharing Environment

PROJECT PARTNERS

- University of Maryland's CATT Lab
- Volpe National Transportation Systems Center
- FRA Office of Railroad Safety
- Railroad Stakeholders:
 - Labor Unions
 - Association of American Railroads
- American Short Line and Regional Railroad Association
- American Public Transportation Association
- Class I Railroads
- Commuter Railroads
- Shortline Railroads
- State DOTs

COST & SCHEDULE

- Funding, FY24: \$150,000
- Project Duration: May 2020 – May 2025

Confidential Close Call Reporting System (C³RS) Evaluation

PROJECT DESCRIPTION

- The Volpe Center is conducting a process and outcome evaluation of the C³RS program's effectiveness. The evaluation will also assess the efficiency and sustainability of the program's processes.
- The evaluation will quantify program benefits and identify potential process improvements to support a sustainable, successful program.
- The evaluation will employ a mixed-methods approach, including literature and document reviews, stakeholder interviews and focus groups, workshops, case studies, surveys, and analysis of quantitative data.

RAILROAD IMPACT

- C³RS is an FRA-funded, voluntary, confidential reporting program that enables railroad carriers and their employees to report "close calls" with the goal of learning about safety risks and implementing corrective actions before incidents or accidents occur.
- Evaluation findings can be used to:
 - Identify program process improvements.
 - Support programmatic decision-making and accountability reporting to oversight organizations.



PROJECT PARTNERS

- FRA Office of Railroad Safety
- NASA
- C³RS Participating Railroads
- Labor Unions

COST & SCHEDULE

- Funding, FY24: \$150,000
- Project Duration: February 2020 – May 2025

Operator Safety and Well-Being Related to Critical Incidents and Close Calls

PROJECT DESCRIPTION

- Many railroaders are likely to experience a “critical incident” (per 49 CFR § 272.9) at least once during their job tenure. “Close calls” are even more prevalent.
- This work explores and documents the ways in which critical incidents and close calls experienced by railroaders are related to operator safety, fatigue, and well-being.
- Mixed-methods research efforts include a literature scan across domains regarding the nature of potentially traumatic events, stress responses, and promising mitigations; and a qualitative and quantitative review, inventory, and categorization of 41 FRA-approved Critical Incident Stress Plans (CISP) from passenger and freight railroads.



RAILROAD IMPACT

- Providing science-based information that helps railroads improve their CISPs, and/or critical incident stress program content, processes, and implementation will allow railroads to make positive changes in their CISPs and employee programs.
- The health and wellbeing of employees affected by critical incidents is expected to improve through industry adopting better CISPs and critical incident stress programs.

PROJECT PARTNERS

- FRA Office of Railroad Safety
- Partner Railroads

COST & SCHEDULE

- Funding: \$248,450
- Project Duration: April 2022 - September 2024

Short Line Safety Institute (SLSI): Annual Grant Program Oversight

PROJECT DESCRIPTION

- FRA's Human Factors Division provides program monitoring and support for SLSI.
- Officially established as a non-profit organization in 2016, SLSI conducts voluntary, non-punitive, confidential Safety Culture Assessments (SCAs) for shortline and regional railroads across the U.S.
- SCAs provide a diagnostic appraisal of a railroad's safety culture at a given point in time, with documented Opportunities for Improvement across the USDOT Safety Council's *Ten Core Elements of a Strong Safety Culture* (adapted for a railroad setting).
- SLSI funding is an earmark grant provided annually by Congress.



RAILROAD IMPACT

- SLSI enhances the safety culture and safety performance of railroads through meaningful and productive partnerships.
- Impacts include:
 - Conducting safety culture assessments and providing recommendations on how to improve safety culture
 - Serving as a research center that compiles and disseminates information on safety needs and trends
 - Communicating research findings to stakeholders about safety culture improvement efforts

PROJECT PARTNERS

- Short Line Safety Institute
- ASLRRRA

COST & SCHEDULE

- Funding, FY24: \$2,425,000
- Project Duration: Ongoing

Short Line Safety Institute (SLSI): Demonstration of C³RS with SLSI

PROJECT DESCRIPTION

- C³RS is a voluntary, confidential reporting system for learning about events or conditions that affect railroad safety.
- FRA's Human Factors Division is sponsoring a pilot project that allows small railroads to participate in C³RS.
- Some railroads are too small to have their own peer review teams. In this pilot project, SLSI assessors serve as the peer review team for very small railroads.
 - SLSI receives reports from NASA and identifies corrective actions that may prevent re-occurrence of the close call.

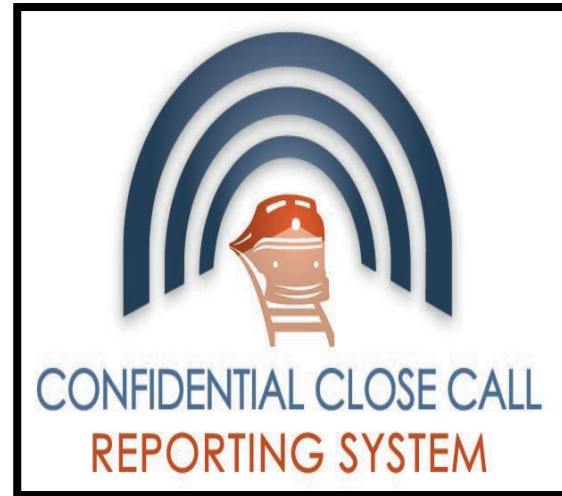

RAILROAD IMPACT

- This pilot project allows very small railroads to participate in C³RS, benefiting from program benefits without compromising employee confidentiality.
- Employees may be more likely to share safety sensitive information in the C³RS program than outside the program, which enables the railroad to learn from close calls that otherwise would be undisclosed.
- Close call reporting helps railroads learn about safety issues before they result in harm or unsafe conditions.

PROJECT PARTNERS

- SLSI
- NASA
- FRA Office of Railroad Safety
- Very Small Shortline Railroads

COST & SCHEDULE

- Total Funding: \$200,000
- Project Duration: May 2020 – May 2025

Short Line Safety Institute (SLSI): Program Evaluation

PROJECT DESCRIPTION

- The Volpe Center conducts a program evaluation of the effectiveness and fidelity of SLSI's program and outreach activities.
 - SLSI activities include Safety Culture Assessments (SCAs) and Leadership Development Trainings (LDTs).
- This evaluation:
 - Identifies strengths and opportunities for improvement in SLSI processes (e.g., developing SCA reports)
 - Provides tools (e.g., fidelity assessment tool)
 - Helps ensure effective and consistent delivery of SLSI services to short line and regional railroads



RAILROAD IMPACT

- SLSI provides free training and SCAs to interested railroads. The evaluation of SLSI's safety outreach activities provides them with opportunities to improve the effectiveness and fidelity of their processes, tools, and SCA and training delivery.
- Providing objective, third-party, evaluative feedback allows SLSI to grow and improve its offerings to the industry, which is intended to strengthen safety culture and improve safety outcomes.

PROJECT PARTNERS

- Short Line Safety Institute
- Volpe National Transportation Systems Center

COST & SCHEDULE

- Funding, FY24: \$150,000
- Project Duration: May 2020 - September 2024

Railroad Safety Advisory Committee (RSAC) Support

PROJECT DESCRIPTION

- RSAC is a forum for railroad stakeholders and the public to discuss railroad safety issues.
- FRA's Human Factors Division and the Volpe Center are assisting FRA's Office of Railroad Safety with the following RSAC working groups:
 - C³RS
 - Hours of Service
 - Critical Incident Stress Plans
- FRA Human Factors and Volpe's participation in RSAC working groups provides subject matter expertise and contributes institutional knowledge to these discussions.



RAILROAD IMPACT

- RSAC provides railroad stakeholders with different interests an opportunity to address complex safety issues.

COST & SCHEDULE

- Funding, FY24: \$69,000
- Project Duration: September 2023 – September 2024

PROJECT PARTNERS

- FRA Office of Railroad Safety
- Association of American Railroads
- American Short Line and Regional Railroad Association
- American Public Transportation Association
- Class I Railroads
- NASA
- Labor Unions:
 - BLET
 - SMART
 - ATDA
 - BRS
 - BMWE

Comparison of Class I Brake Test Procedures

PROJECT DESCRIPTION

- FRA currently issues waivers to industry on a case-by-case basis to permit virtual simulator brake refresher training to satisfy the hands-on training required by 49 CFR § 232.203(b)(8).
- FRA's Human Factors Division will conduct a literature review to assess the impact of virtual and/or simulator-based refresher trainings on skill acquisition and training transfer.
- This project aims to identify a set of criteria for a data-based safety case that objectively demonstrates an equivalent (or improved) level of safety through use of the simulation during training.

RAILROAD IMPACT

- Aid industry in identifying data-based safety cases to enhance virtual and simulator-based refresher trainings.
- Provide FRA literature that aids in decision-making for waivers.
- Enhance training for already skilled employees and provide guidance for simulator training developers.

PROJECT PARTNERS

- Transportation Technology Center
- ENSCO, Inc.
- FRA Office of Railroad Safety



COST & SCHEDULE

- Funding, FY24: \$200,000
- Project Duration: October 2023 – September 2024

Expertise Management (EM) for Safety Leadership Positions in U.S. Railroads

PROJECT DESCRIPTION

- Demonstrate and evaluate an EM Framework for safety critical leadership positions in the U.S. rail industry to help mitigate the loss of essential expertise and institutional knowledge from job transfers, retirements, and reductions in workforce.
- Three elements of the EM Framework will be demonstrated:
 1. Knowledge identification
 2. Knowledge capture
 3. Knowledge transfer
- The project's end deliverable is a good practices guide for railroads.

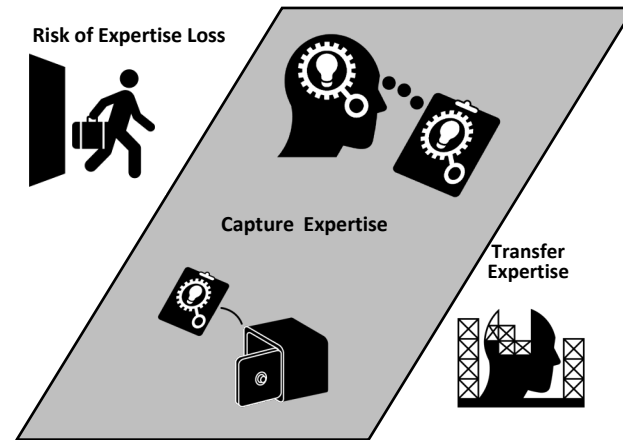

RAILROAD IMPACT

- Develop a suite of EM tools that railroads can use to tailor organizational changes that will mitigate their knowledge loss and accelerate expertise achievement for new and existing personnel.
- Implement specific strategies deployed at railroad organizations to capture and mitigate the potential loss of expertise in key safety positions.

PROJECT PARTNERS

- TrueSafety Evaluation, LLC.
- Perigeon Technologies, LLC.

COST & SCHEDULE

- Funding, FY24: \$471,246
- Project Duration: Sept. 2022 – February 2024

Railway Worker and Operator Performance Program Development

PROJECT DESCRIPTION

- Provide railroad domain and work scheduling/operator fatigue subject matter expertise.
- Work with FRA's Office of Railroad Safety and industry stakeholders to better understand human factors issues around safety, safety programs, safety culture, industry regulations (i.e., Fatigue Risk Management Program rule, technology, and assessing related operator/railway worker needs, gaps, and sensitivities).
- Review and communicating research needs.
- Facilitate discussions with other researchers.

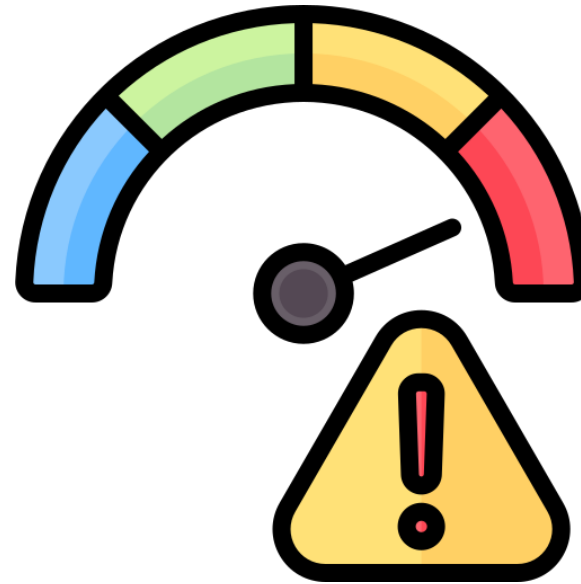

RAILROAD IMPACT

- FRA is identifying research needs in railroad worker and operator performance.
- Facilitating the relaunch of *Railroaders' Guide to Healthy Sleep* will sooner connect the target audience to valuable and tailored educational information around obtaining sufficient and adequate sleep, as well as sleep disorders, health and well-being.

PROJECT PARTNERS

- FRA Office of Railroad Safety
- Care Systems, Inc.

COST & SCHEDULE

- Funding Total: \$298,450
- Project Duration: May 2020 - September 2024

Tools Supporting BIL Crew Training Programs

PROJECT DESCRIPTION

- The Bipartisan Infrastructure Law (BIL) mandates that FRA audit Class I railroad training for train crews (locomotive engineers and conductors).
- The objective of this research is to develop tools for this effort according to the requirements in 49 CFR Part 240 and 242 for locomotive engineers and conductors.
- FRA is:
 - Developing tools (e.g., surveys, checklists) for FRA auditors to use in evaluating training for new employees in the classroom and on the job
 - Analyzing the responses FRA receives from FRA auditors
 - Identifying good practices for evaluating training programs

RAILROAD IMPACT

- This will evaluate the impacts of current training programs and the extent to which those programs comply with 49 C.F.R. § 240 and 242.
- Findings will identify where training programs may need revision to improve effectiveness in the classroom and on the job.



PROJECT PARTNERS

- FRA Office of Railroad Safety
- Volpe National Transportation Systems Center

COST & SCHEDULE

- Funding, FY23: \$50,000; FY24: \$50,000
- Project Duration: January 2023 – September 2024

Understanding Railroad Trespassing Social and Community Factors from Trespassing Behavioral Data at Grade Crossings and on Right-of-Way

PROJECT DESCRIPTION

- Develop a methodological framework for understanding social and community factors contributing to pedestrian trespass behaviors and motorist incursions on railroad systems.
- Develop a repeatable process for collecting, analyzing, and understanding social and community factors from a railroad trespassing behavioral database.
- A case study application of this framework will be applied to several locations in the U.S.
- Interview DOTs, railroad police, Operation Lifesaver volunteers, and academics to understand the state of practice for using contextual information for trespassing mitigation.

RAILROAD IMPACT

- Provide a repeatable framework for analyzing social and community factor data and trespassing data to develop better trespassing prevention strategies.
- Increase safety through targeted and informed trespassing prevention strategies.
- Specific case studies will provide actionable insights to railroads that have trespassing data in a database.
- The analysis could inform more effective trespassing mitigation education, enforcement, and engineering solutions.

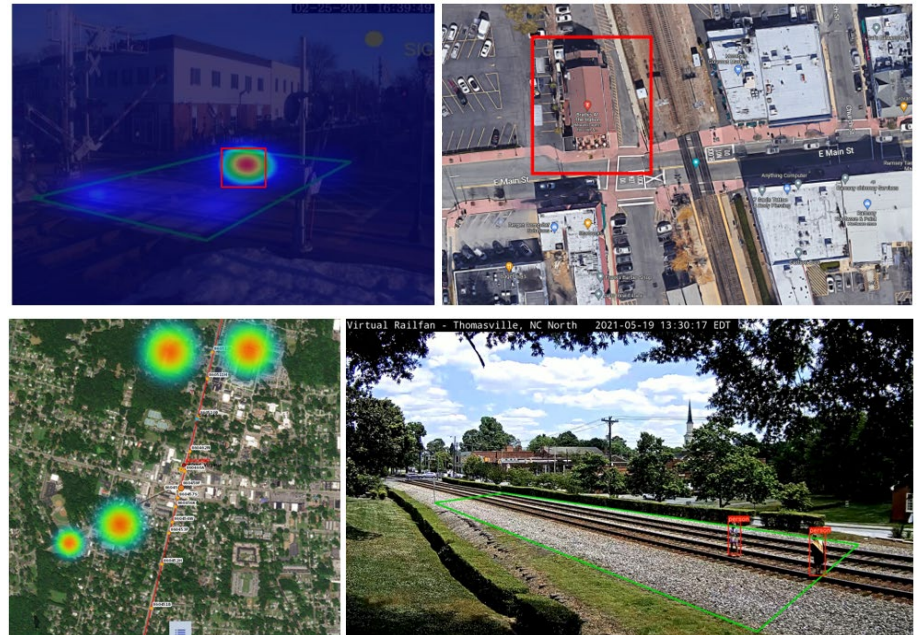

PROJECT PARTNERS

- Redstone Technologies LLC
- Departments of Transportation: NJDOT, LADOTD, FDOT
- Freight Railroads: C&D Railroad, Conrail, Norfolk Southern
- Passenger Rail: SunRail, Metra, Metro-North, NJ Transit

COST & SCHEDULE

- Funding Total: \$250,000
- Project Duration: January 2024 – December 2025

Railroaders' Guide to Healthy Sleep: Website Update

PROJECT DESCRIPTION

- FRA is working with Harvard Medical School to update the content on the *Railroaders' Guide to Healthy Sleep* (RGHS) website.
- The RGHS website was developed in 2012 and refreshed in 2016.
- The RGHS website is a non-regulatory educational resource that provides scientifically valid information on sleep and sleep hygiene for railroad workers.

RAILROAD IMPACT

- Facilitating the relaunch of RGHS means that valuable and tailored educational information around obtaining sufficient and adequate sleep, as well as sleep disorders, health and wellbeing reaches a railroader target audience sooner.

PROJECT PARTNERS

- Volpe National Transportation Systems Center
- Harvard Medical School
- FRA IT
- Labor Unions

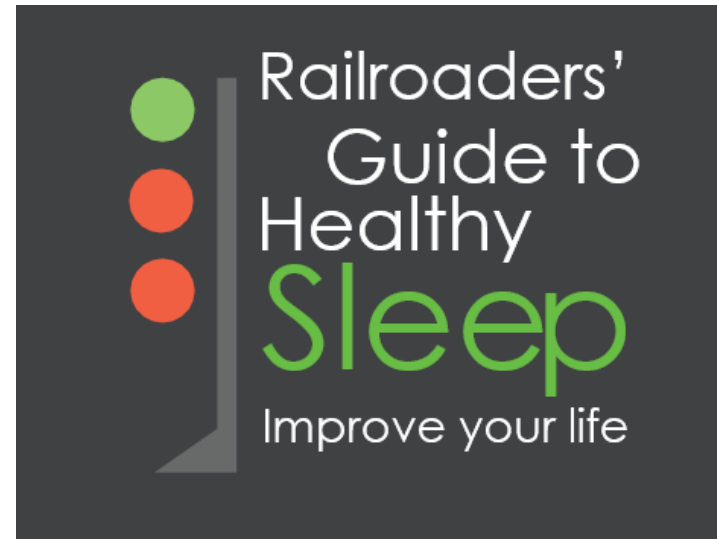

COST & SCHEDULE

- Funding Total: \$500,000
- Project Duration: September 2021 – September 2024

Rail Crossing Violation Warning and In-Vehicle Auditory/Visual Alert

PROJECT DESCRIPTION

- Using driving simulators, examine the effects of intelligent audio-visual grade crossing warnings on driver behavior at different highway-rail grade crossings.
- In-vehicle warnings will be created by integrating the Rail Crossing Violation Warning system with audiovisual warnings developed and tested at Virginia Tech and Michigan Tech.



RAILROAD IMPACT

- Provide a data-based approach to designing in-vehicle audiovisual alerts for highway-rail grade crossings.
- Implementation of the standardized in-vehicle audiovisual grade crossing alerts will help FRA in its goal toward zero grade crossing accidents.

PROJECT PARTNERS

- Virginia Tech
- Michigan Tech

COST & SCHEDULE

- Funding, FY24: \$550,000
- Project Duration: August 2022 – February 2025

Suicide Prevention for U.S. Rail (SPUR)

PROJECT DESCRIPTION

- Collaboration and communication are critical to ensuring that emerging and proven trespass and suicide prevention practices are identified and shared with stakeholders.
- This project area aims to gather information from experts and disseminate best practices.
- Coordinate, host, and document quarterly meetings of the SPUR working group.
- Maintain shared space for meeting notes and documents.
- Meeting topics include:
 - Training employees to recognize warning signs of suicide and intervene
 - Establishing effective partnerships with outside groups
 - Public messaging and the 988 Suicide and Crisis Lifeline
 - Mobile Crisis Units/Quality of Life Teams

RAILROAD IMPACT

- SPUR is a forum for U.S. railroads to discuss successes and challenges and to encourage action.
- This collaboration helps to reduce barriers to implementation and aid knowledge transfer.

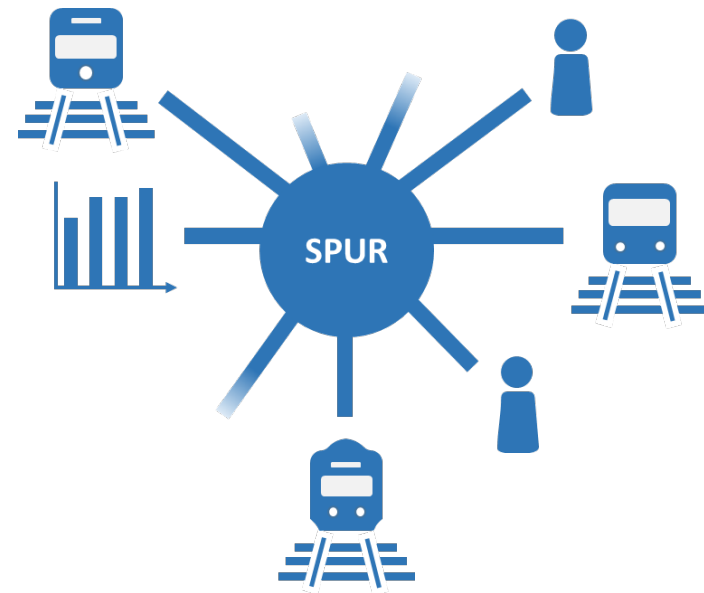

PROJECT PARTNERS

- FRA Office of Railroad Safety
- Volpe National Transportation Systems Center
- Commuter Railroads

COST & SCHEDULE

- Project Duration: May 2021 – Sept 2024

Trespass and Suicide Prevention: Countermeasure Evaluation

PROJECT DESCRIPTION

- Trespass and suicide are the two leading causes of rail-related death in the U.S.
- FRA seeks to add to the body of evidence-based best practices and document how stakeholders can adopt these practices to meet their needs.
- Coordinate with railroad partners around the country to identify opportunities to evaluate novel countermeasure implementations.

RAILROAD IMPACT

- This research seeks to identify emerging practices that lack empirical evidence and to identify railroad partners to help study these implementations.
- Provide subject matter expertise within FRA and across industry for suicide prevention and related concerns.

COST & SCHEDULE

- Funding, FY20–24: \$790,000
- Project Duration: May 2020 – September 2024



[Adobe Stock Images - Diane](#)

PROJECT PARTNERS

- FRA Office of Railroad Safety
- FRA Office of Public Affairs
- Volpe National Transportation Systems Center
- Railroad Stakeholders

Trespass and Suicide Prevention Collaborative Support

PROJECT DESCRIPTION

- The Volpe Center will collaborate with railroad stakeholders and Palm Beach County, Florida, community members (e.g., railroads, law enforcement, social services, and local government) to develop a good practices guide that will help communities address rail trespass and suicide risks.
- Efforts to better understand the root causes of trespassing, including acts of suicide, are critical and are largely intended to support the development of strategies to prevent future incidents or mitigate their consequences.
- Community engagement is critical, though the specifics of who should be involved in this coordination and how these groups may complement one another remains unclear.



RAILROAD IMPACT

- U.S. communities will be able to use the comprehensive, community-based good practices guide to help understand railroad trespass and suicide incidents and reduce their occurrences.

PROJECT PARTNERS

- Volpe National Transportation Systems Center
- FRA Office of Railroad Safety
- Palm Beach County, Florida

COST & SCHEDULE

- Funding, FY24: \$150,000
- Project Duration: August 2023 – September 2024

Trespass and Suicide Prevention: Trespass Prevention Toolkit

PROJECT DESCRIPTION

- Trespass and suicide on railroad property are the two leading causes of rail-related deaths in the U.S.
- In spring 2022, FRA launched the [Trespass & Suicide Prevention \(TSP\) Toolkit](#), an interactive resource to identify effective railroad trespass prevention strategies and suicide prevention measures.
- The TSP Toolkit is useful for individuals who work in railroad safety and for researchers, community members, suicide prevention groups, or other individuals or organizations with an interest in preventing trespassing and suicide.
- The TSP Toolkit was developed to help share railroad trespass and suicide prevention strategies.
- The TSP Toolkit is a user-friendly repository of mitigation strategies and data to help railroad stakeholders identify effective solutions.

RAILROAD IMPACT

- The TSP Toolkit is a resource for railroads and other stakeholders to identify strategies to prevent trespass and suicide.
- The TSP Toolkit empowers railroads to make safety decisions based on their specific challenges.

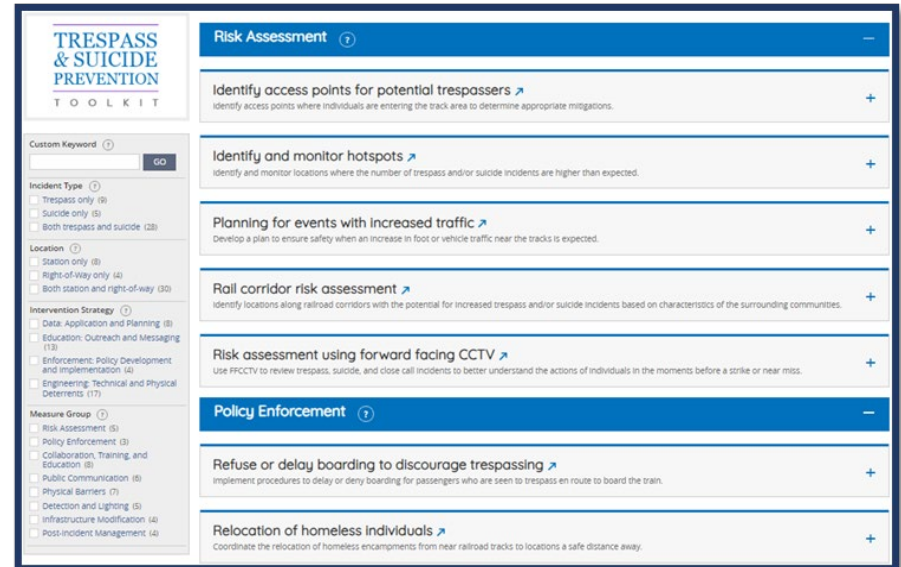

PROJECT PARTNERS

- FRA Office of Railroad Safety
- FRA Office of Public Affairs
- Volpe National Transportation Systems Center
- Railroad Stakeholders

COST & SCHEDULE

- Funding, FY24: \$100,000
- Project Duration: May 2020 – September 2024

Social and Community Factors Contributing to Pedestrian Trespass Behaviors and Motorist Incursions on Railroad Systems

PROJECT DESCRIPTION

- Assess the state of the practice (literature review).
- Develop advanced AI tools for trespassing detection.
- Develop a trespass prevention interactive tool.
- Prototype tool development and validation at test sites.

RAILROAD IMPACT

- Improve safety at highway-rail grade crossings.
- More timely identification of causation factors and data-driven decision making
- Identify locations of interests and apply treatments based on the interactive tool analysis.

PROJECT PARTNERS

- Texas State University
- Texas A&M Transportation Institute



COST & SCHEDULE

- Funding FY24: \$264,000
- Project Duration: 18 months

Discover Influential Geosocial Factors Aggravating Crossing Trespassing (DIGFACT)

PROJECT DESCRIPTION

- Identify and understand the geosocial factors that influence both pedestrian and motorist incursions on railroad tracks.
- Reconstruct Geographic Characteristics:
 - Where does trespassing happen?
 - What geographic factors contribute?
- Portray Social and Community Profile:
 - Who is willing to trespassing?
 - What social factors contribute?
- Decipher Correlations of Trespassing:
 - How does each geosocial factor contribute?
 - What is the sensitivity of each factor?
 - What is the weight of each factor?
 - How do trespassers make decisions to risk their lives?

RAILROAD IMPACT

- Quantify the factors that influence trespassing decisions and their weights and sensitivities.
- Assist in classifying the risk level of different crossings.
- Better allocate resources to monitor risky crossings.
- Optimize crossing configurations to reduce risk.
- Connect communities with railroads.
- Benefit all stakeholders in industry and railroad, and in local, State, and Federal governments.

PROJECT PARTNERS

- University of South Carolina
- TRAINFO Corp.
- Brightline

COST & SCHEDULE

- Funding: \$455,000
- Project Duration: 36 months

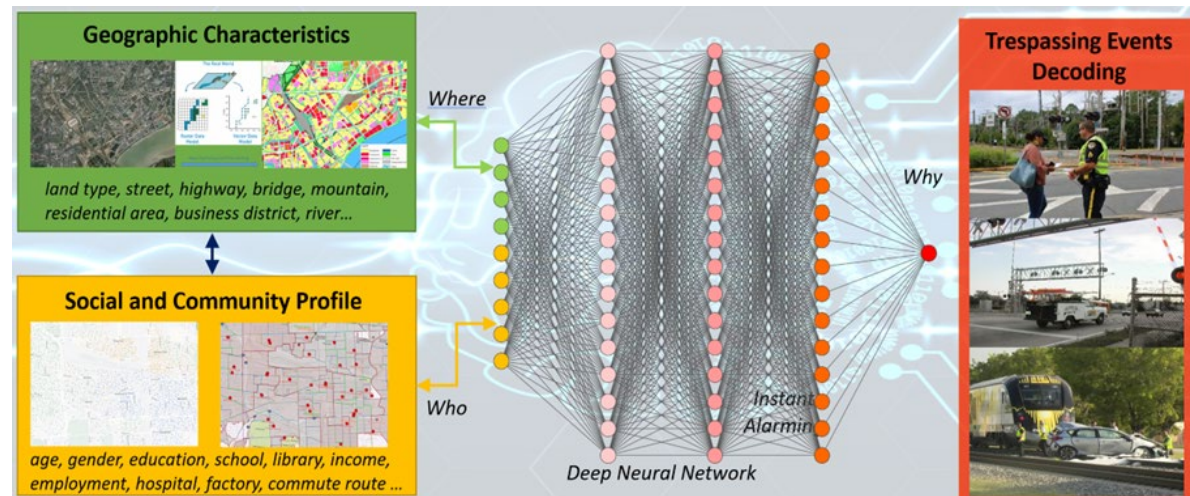

Trespass and Suicide Prevention: Data Quality

PROJECT DESCRIPTION

- To effectively understand trespass, suicide, and grade crossing issues, it is critical to review and analyze data from past incidents. This includes two key aspects: identifying what post-incident information may be best used to develop effective mitigation strategies and improving the reliability and validity of the data being collected.
- This project involves the coordination and collection of data to identify who is at risk for rail trespass and suicide to assist stakeholders in mitigation efforts.
- Through an equity lens this project highlights the importance of data quality, its limitations, and gaps in data collection relating to railroad trespass and suicide.
- Maintain continuous contact with railroad carriers and develop new relationships with others to identify new data sources of railroad trespass and suicide incidents.

RAILROAD IMPACT

- Through an equity lens, this research seeks to understand where data gaps exist to better support railroads in understanding who their vulnerable population is, including their employees.
- Disseminate findings on suicide and trespass incidents and the data quality limitations as a resource for railroads and other stakeholders to identify strategies to prevent railroad trespass and suicide.
- Provide subject matter expertise within FRA and across industry for equity in trespass and suicide prevention and mitigation on the railroad.

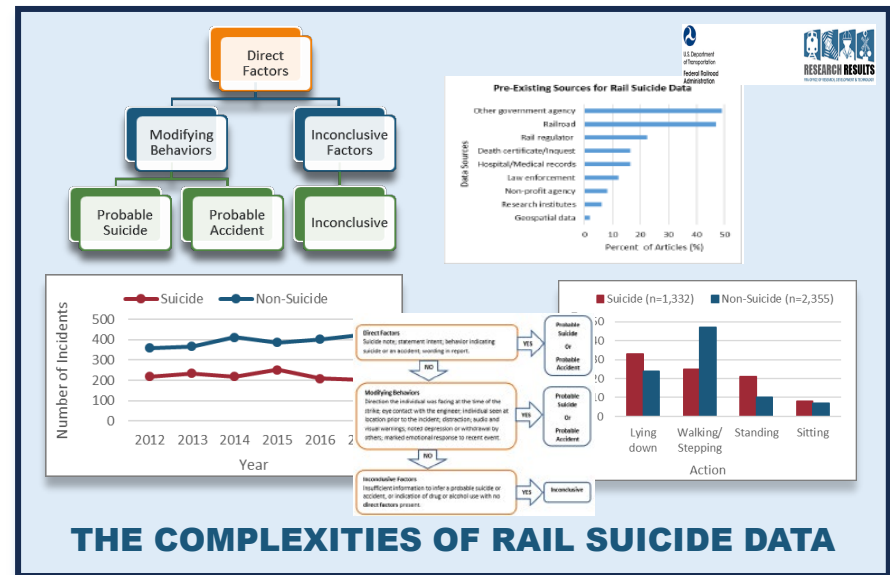

PROJECT PARTNERS

- FRA Office of Railroad Safety
- FRA Office of Public Affairs
- Volpe National Transportation Systems Center
- Railroad Partners
- Centers for Disease Control and Prevention

COST & SCHEDULE

- Funding, FY20–24: \$545,000
- Project Duration: May 2020 – Sept 2024

Operation Lifesaver, Inc. (OLI) Program Evaluation

PROJECT DESCRIPTION

- The Volpe Center is conducting a program evaluation to assess how the OLI program executes its mission, whether the tasks in the FRA grant agreement are being implemented as intended, and what improvements can be made to OLI's operations.
- The evaluation team will describe and document existing processes, activities, goals, and intended outcomes; document barriers and challenges encountered during implementation; identify program strengths; and provide recommendations for process improvements.
- The evaluation team will employ a mixed-methods approach to include document reviews (e.g., grant agreement and closeout documents, OLI annual reports), stakeholder interviews, and data analysis.

RAILROAD IMPACT

- OLI is a non-profit organization that partners with Federal, State, and local government agencies, railroads, and highway safety organizations to create public awareness campaigns to increase safety and save lives on or near railroad tracks.
- Findings from this evaluation can be used to:
 - Support OLI and FRA grant agreements and increase the effectiveness of OLI's operations.
 - Support programmatic decision-making and accountability reporting.



PROJECT PARTNERS

- Volpe National Transportation Systems Center
- FRA Office of Railroad Safety
- Operation Lifesaver, Inc.

COST & SCHEDULE

- Funding, FY24: \$150,000
- Project Duration: October 2022 – April 2024

Impact of System Driven Workload on Rail Vehicle Operator Glance Times

PROJECT DESCRIPTION

- Develop recommendations on tolerable glance duration during rail vehicle operation to inform safety plans and research. The recommendations will focus on:
 - Tolerable limits of train operator's attention focused away from track monitoring
 - Tolerable limits of the impact of new Intelligent Rail System technologies on glance duration
- Generate a track monitoring performance test protocol to assess the impact of new Intelligent Rail System technologies on glance duration and determine their acceptability.

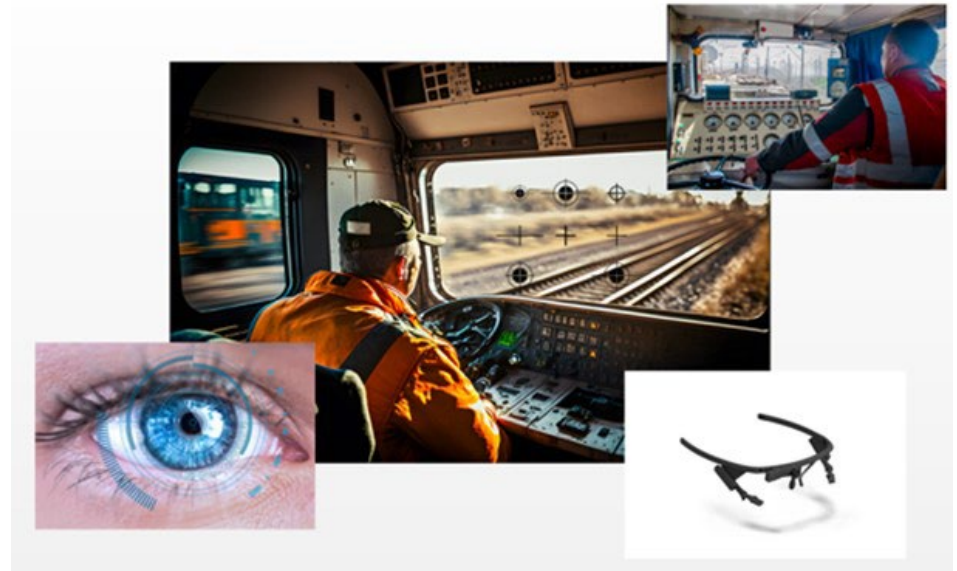

RAILROAD IMPACT

This project guides industry for the safe integration of new in-cab technology into rail vehicle operations by:

- Introducing a standardized testing protocol to assess system-driven workload and its impact on engineer performance, especially in track monitoring
- Establishing workload thresholds to ensure new technologies enhance engineer performance and rail safety

PROJECT PARTNER

- Atkins North America, Inc.

COST & SCHEDULE

- Funding, FY24: \$164,410
- Project Duration: 5 months

Trespass and Suicide Prevention: Global Railway Alliance for Suicide Prevention (GRASP)

PROJECT DESCRIPTION

- GRASP is an international working group of subject matter experts who specialize in suicide prevention on rail systems.
- Since 2013, GRASP has met at least twice per year to share best practices and research.
- During GRASP meetings, participants learn about how different railroads around the world prevent railroad trespassing and suicide.

RAILROAD IMPACT

- Sharing railroad suicide information with international stakeholders allows the identification and implementation of effective strategies and countermeasures.
- Countries participating include the U.S., Canada, Australia, New Zealand, Japan, Norway, Sweden, Finland, the United Kingdom, France, and the Netherlands.

COST & SCHEDULE

- Funding, FY24: \$20,000
- Project Duration: May 2020 – September 2024

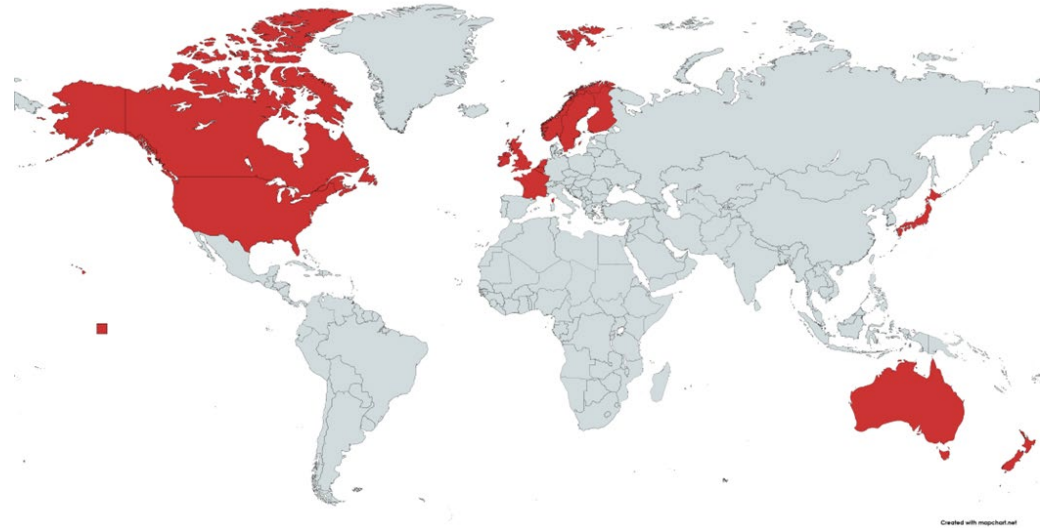

PROJECT PARTNERS

- FRA Office of Railroad Safety
- Volpe National Transportation Systems Center
- Railroad Stakeholders
- International Stakeholders



RAILROAD SYSTEMS ISSUES

WORKFORCE DEVELOPMENT

Enhancing Railroad Workforce Training through Equitable Smart Infrastructure Experiences

PROJECT DESCRIPTION

- Discover evolving technical needs of the rail industry and establish effective training practices.
- Collect student data to determine technical proficiencies and identify barriers resulting from inequity or lack of resources.
- Expand on proven educational frameworks to reach a broader spectrum of future railroaders, including those from minority-serving institutions.

RAILROAD IMPACT

- Reconcile emerging industry needs with evolving training and education practices bridging high school and university programs.
- Streamline training programs to include essential skill sets for specific pathways to industry.
- Close gaps in equity and access for diverse students with trajectories toward engineering and vocational careers within the rail industry.

COST & SCHEDULE

- Funding, FY23: \$154,636
- Project Duration: June 1, 2022 – May 31, 2025



PROJECT PARTNERS

- Southern Methodist University
- Texas State University
- BNSF
- Garland ISD

The Railroader of the Mid-Century

PROJECT DESCRIPTION

- The railroad industry faces low diversity and needs skilled workers, driving efforts to attract and educate the next generation of talent.
- The **Smart Railroads Project** engages pre-K–12th grade students in the rail industry with technology-focused educational activities.
- The program facilitates hands-on learning with interactive technology (AR/VR, drones, 3D printers).
- The focus is to attract candidates in the southern U.S., who typically need more recruitment activities, with a preference for minorities (Native American, Hispanic, female, African American students).
- Project outcomes include increasing interests, training a skilled workforce, generating technological advancements, and collaboration with rail industries.

RAILROAD IMPACT

- Boosting students' enthusiasm in the field of railroads
- Nurturing a diverse talent pool for the rail industry
- Outreach 2022–2023: 200+ students (elementary – high school) participated in outreach activities, workshops, and field trips.
 - Rail Runner, Tramway, workshops at UNM, open house, science fair, and more
- Year 1 Products: educational modules, website (<https://www.smartrailroads.org/>), YouTube videos, and a railroad drawing competition

COST & SCHEDULE

- Funding, FY22: \$475,375 (\$176,011 obligated to date)
- Project Duration: September 2021 – August 2024



PROJECT PARTNERS

- Stanford University
- Florida A&M University
- Michigan Tech
- University of Illinois at Urbana-Champaign
- University of Nebraska
- University of Tennessee Knoxville
- Albuquerque Rocket Society
- Sandia Peak Tramway
- High Water Mark LLC
- CN Railway
- New Mexico Rail Runner
- TTCI
- Sandia National Laboratories
- Air Force Research Laboratory
- NASA
- New Mexico Space Grant Consortium
- Explora!
- Los Alamos County

Train Research and Contemporary Knowledge (TRACK) training

PROJECT DESCRIPTION

- This project will introduce students to railroad careers and internship opportunities.
- Create opportunities that begin in the classroom and take students on transportation and rail-related field trips.
- This project will provide an opportunity for students to present research at the Transportation Research Board Annual Meeting.



RAILROAD IMPACT

- Graduating students who have participated in the TRACK project will be better prepared to seek and obtain employment in the rail sector.
- These students will provide the rail industry with a more qualified pool of applicants interested in a railroad career.

PROJECT PARTNERS

- North Carolina Central University
- University of North Carolina at Charlotte (partner but not a subcontractor)
- North Carolina DOT

COST & SCHEDULE

- Funding, FY24 – Year 1: \$157,922
- Total cost of the 3-year project: \$478,093

Guidebook for Railway-Themed K–12 STEM Distance Learning Activities

PROJECT DESCRIPTION

- Develop new rail-themed K–12 STEM (science, technology, engineering, and mathematics) distance learning activities.
- Adapt in-person activities used by the project partners and other collaborating railway academic programs for remote use.
- Document existing online activities in a distance learning guidebook.

RAILROAD IMPACT

- Document existing and new rail-focused K–12 STEM distance learning activities.
- Improve the ability to supply educators and railway industry volunteers with materials for rail-focused STEM outreach via distance learning.
- Enhance the ability to reach diverse student groups across large geographic areas via synchronous and asynchronous online and desktop activities.
- Increase awareness of railway industry careers among K–12 students.



PROJECT PARTNERS

- University of Texas at Austin
- Michigan Technological University

COST & SCHEDULE

- Funding, FY24: \$95,000
- Project Duration: Sept 2023 – August 2024

Evaluating Current Knowledge of Equity in Passenger Rail Utilization

PROJECT DESCRIPTION

- Evaluate existing research and data on equity in Amtrak and private intercity passenger rail utilization, station location, and access barriers along racial and socio-economic lines.
- Review other modal frameworks (e.g., transit) for defining and measuring transportation equity.
- Develop a core framework of data analysis and metrics to qualitatively and quantitatively highlight equity issues in intercity passenger rail.
- Identify knowledge/data gaps for future research.



RAILROAD IMPACT

- Identify holistic understanding of current knowledge of equity in intercity passenger rail use according to racial, ethnic, spatial, and socio-economic divides.
- Develop a custom framework for evaluating equity in intercity passenger rail services informed from broader transportation equity best practices.
- Design roadmap for future research and data collection to address gaps in knowledge of service equity.
- Guide intercity passenger rail planning and operating decisions to serve diverse groups.

PROJECT PARTNERS

- University of Illinois Urban Transportation Center
- University of Illinois Rail Transportation and Engineering Center
- Amtrak
- Illinois DOT

COST & SCHEDULE

- Funding, FY24: \$100,000
- Project Duration: September 2023 – August 2024

Workforce Recruitment: Attracting and Retaining Women in Rail

PROJECT DESCRIPTION

- The purpose of the project is to understand what barriers women face working in the rail industry and how that may affect attraction to and retention of jobs in rail.
- Research will identify recommendations to guide FRA in further methods of improving the experience of women in rail, recruit quality female talent, and retain and promote that talent through long careers in the industry.
- The project aims to offer actionable solutions to ensure the rail sector is an equitable and attractive place for women to work.



RAILROAD IMPACT

- Provide ethnographic analysis to provide a baseline and context for efforts to improve the experience of women working in rail, recruit a larger cohort of women to the industry, and long-term retention.
- Develop examination previous culture change initiatives in other industries to leverage best practices and lessons learned.
- Build coalitions with stakeholders in effort to initiate improvements to workplace culture for women.

PROJECT PARTNERS

- KEA Technologies, Inc.
- HILE Group

COST & SCHEDULE

- Funding, FY24: \$192,938
- Project Duration: September 2023 – June 2024 (Phase I)

Women of Rail: The Path to Gender Diversity

PROJECT DESCRIPTION

- A robust and innovative rail workforce is necessary to develop solutions to complex challenges related to rail safety and efficiency.
- This project will comprehensively study inhibitors and accelerators for improving gender diversity in the rail industry.
- Mixed-methods methodology, including literature review, data gathering, surveys and interviews of multiple stakeholder groups, and qualitative and quantitative analyses will be used.

RAILROAD IMPACT

- Design and provide comprehensive, data-driven and implementable tools for the rail industry to positively impact gender diversity.
- The project has a large-scale impact (target 50 % rail company adoption) and is intended to positively impact gender diversity in rail industry
- The project's products help FRA achieve goals for attracting and retaining women in rail.

COST & SCHEDULE

- Total Funding: \$578,842 (\$478K FRA/\$109K SETWC)
- Project Duration: September 2022 – February 2028



PROJECT PARTNERS

- University of Memphis Southeast Transportation Workforce Center (SETWC)
- Fairpointe Planning, LLC
- Tennessee State University
- Vanderbilt University

Preparing Minority Scholars for Railroad-Highway Safety Workforce

PROJECT DESCRIPTION

- This project aims to benefit primarily minority students with a safety operation-oriented workforce training to develop an educational and research program focused on the application of statistical modeling, microsimulation, and artificial intelligence (AI)/machine learning (ML) in evaluating and improving Railroad-Highway Grade Crossing (RHGC).
- Identify key concepts related to AI/ML applications including automation, communication, prediction, pattern recognition, clustering, optimization, sensors, and signals.
- Evaluate and solve railroad safety and operational needs through simulation.

RAILROAD IMPACT

- The developed AI/ML applications and microsimulations will aid in estimates of queues, the time RHGCs will be blocked, traffic blocked crossing travel time. They will aid in traffic delay mitigation and use interactive dashboards with detection sensors.
- The program will produce a diverse and talented cohort of railroad transportation systems scholars.
- The program will aid in student skill acquisition, knowledge, and workforce development.



[Adobe Stock Images - amorn](#)

PROJECT PARTNERS

- Tennessee State University
- Tennessee DOT
- Oak Ridge National Laboratory

COST & SCHEDULE

- Total Funding: \$499,935
- Project Duration: September 2022 – September 2026

How Restructuring Performance Management Systems Can Increase Diversity in Rail

PROJECT DESCRIPTION

- This project aims to understand how certain factors (e.g., performance management systems, organizational culture) contribute to workforce development issues.
- The findings of the research will:
 - Expand on disparity research completed to date.
 - Supplement existing impact studies with data and stories from lived experiences of underrepresented individuals working in rail.
 - Collect best practices from the effective use of performance management systems as a tool for diversification.
 - Learn from organizations who set gold standards for equitable and diverse recruitment, development, retention, and promotion.



[Adobe Stock Image - Chalermphon](#)

RAILROAD IMPACT

- Develop a landscape analysis to provide a better picture of the current work ecosystem and barriers for underrepresented individuals in the rail industry as a baseline against which to measure other programs.
- Provide a better understanding of how employees at various levels are impacted by performance management systems and organizational culture.
- Documented case studies on diverse organizations enable the identification of best practices used in different industries on recruiting and retaining diverse talent and identify the role leadership plays in success.

PROJECT PARTNERS

- KEA Technologies
- HILE Group

COST & SCHEDULE

- Total Funding: \$199,728
- Project Duration: 18 months

Expanding Summer Youth Programs in Rail through Virtual Learning and a National Campus Network

PROJECT DESCRIPTION

- Create a nationwide network of hybrid, rail-focused summer programs for high school students.
 - Expand from 20 to 80 students in the first year, to 120 students in the second year, and over 200 in the third year.
- Develop a standardized curriculum of online resources and hands-on activities to expand interest in rail industry careers.
- Emphasize the variety and breadth of opportunities in the industry and the high-tech nature of many positions.
- Engage several minority-serving institutions.

RAILROAD IMPACT

- Increase outreach of current high school outreach programs by factor of 10 – over 200 youths in year 3 (total of over 400).
- Engage students from underserved communities with the vibrant and exciting careers available in rail.
- Create a new pipeline of talent prepared to enter rail industry careers.

COST & SCHEDULE

- Funding, FY24 – Phase III: \$297,526
- Project Duration: September 2020 – August 2024



PROJECT PARTNERS

- Michigan Tech (Lead)
- University of Illinois
- Penn State Altoona
- University of New Mexico
- University of South Carolina
- California State University, Fresno
- American Railway Engineering and Maintenance-of-Way Association
- National Railroad Contractors and Maintenance Association

Developing a Job Compatibility Questionnaire (JCQ) for the Rail Industry

PROJECT DESCRIPTION

- The goal of this research is to increase employee retention in the rail industry. Increasing retention will strengthen the effectiveness of succession planning.
- A primary challenge is to identify “workarounds” that rail organizations can use to increase retention, given the unchangeable conditions of working in the industry.
- This can be done through a JCQ which has been shown to reduce turnover in several industries.
- Colorado State University Pueblo will develop a JCQ that identifies the values that tenured railroad employees possess and match them to the general, non-railroad workforce.



RAILROAD IMPACT

- This tool will identify and retain women whose values match with the positive elements of a railroad career.
- This tool will enable FRA and railroads to identify new hires and increase pools of diverse candidates for future leaders in the industry.

PROJECT PARTNERS

- Colorado State University Pueblo
- Rail operators who face challenges in hiring

COST & SCHEDULE

- Funding, FY24: \$97,216.30
- Project Duration: Jan 2024 – Dec 2024

Railroading Education: On Track to a Great Career

PROJECT DESCRIPTION

- This research examines employee recruitment and retention in the railroad industry.
- The goal is to formulate a unified and sustainable approach to recruitment and retention.
- The project team will develop methods and techniques to promote partnerships and collaborations for recruitment and retention across the railroad industry and with schools and colleges for student outreach.

RAILROAD IMPACT

- Measure the effectiveness of various outreach strategies, such as use of social media.
- Measure the absorption and retention of the positive railroading careers messaging directed towards students from local underrepresented communities' schools.
- Determine, through in-person visits to selected schools, which aspects of railroading careers are considered the most positive by the students.
- Produce a toolbox of recommendations to be used by FRA for recruiting.

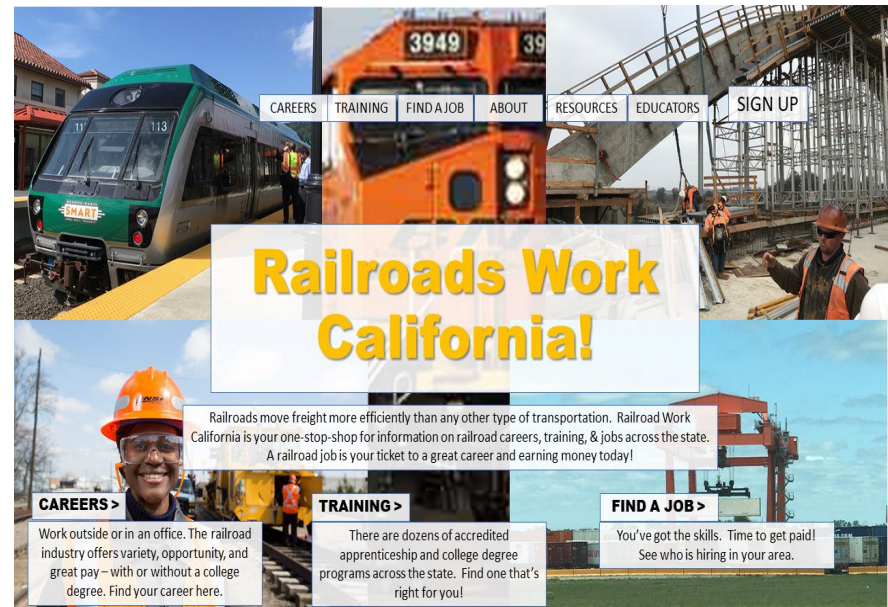

PROJECT PARTNER

- California State University, Fresno

COST & SCHEDULE

- Funding: \$203,798
- Project Duration: July 2021 – September 2023