



U.S. Department  
of Transportation  
Federal Railroad  
Administration

## **CONTROLLED TANK CAR IMPACT TESTS**

---

Office of Research and  
Development  
Washington D.C. 20590

**Robert K. Larson, Jr.  
Britto R. Rajkumar**

**Association of American Railroads  
Transportation Test Center  
Pueblo, Co 81001**

---

DOT/FRA/ORD-92/28

August 1992  
Final Report

This document is available to the  
U.S. public through the National  
Technical Information Service  
Springfield, Virginia 22161

## DISCLAIMER

This document is disseminated under the sponsorship of the Department of Transportation in the interest of information exchange. The United States Government assumes no liability for the contents or use thereof. The United States Government does not endorse products or manufacturers. Trade or manufacturers' names appear herein solely because they are considered essential to the object of this report.

1. Report No. DOT/FRA/ORD-92/28		2. Government Accession No.		3. Recipient's Catalog No.	
4. Title and Subtitle CONTROLLED TANK CAR IMPACT TESTS				5. Report Date August 1992	
				6. Performing Organization Code	
7. Author(s) R. K. Larson, Jr. B. R. Rajkumar				8. Performing Organization Report No.	
				10. Work Unit No. (TRAIS)	
9. Performing Organization Name and Address  Association of American Railroads Transportation Test Center P.O. Box 11130 Pueblo, CO 81001				11. Contract or Grant No. TO 31, Task F DTFR53-82-C-00282	
				13. Type of Report or Period Covered  Final Test Report February '90 - February '91	
12. Sponsoring Agency Name and Address  U.S. Department of Transportation Federal Railroad Administration Office of Research and Development 400 Seventh Street SW Washington, D.C. 20590				14. Sponsoring Agency Code RDV 32	
				15. Supplementary Notes	
16. Abstract  A series of controlled tank car impact tests were performed by the Association of American Railroads as part of a Federal Railroad Administration Task Order entitled "Hazardous Materials Transportation Safety Research Test Program." The objective of these tests, in which a weighted locomotive was coupled to a stationary DOT 111A100W2 tank car at different speeds, was to determine the magnitude of surge pressures that the safety vent is exposed to and to test devices that are designed to reduce these surge pressures and prevent the premature rupture of frangible discs.  Test results support the following conclusions:  - When loaded to a shell full condition, a tank car of the design tested will develop safety vent nozzle surge pressures sufficient to rupture 60 and 100 psi frangible discs during impacts that produce coupler forces of 800 kips and 1100 kips, respectively.  - A large decrease in safety vent nozzle surge pressures results when lading outage is changed from 0 percent to 1 percent.  - For impact speeds between 5 and 7 mph, substantially higher coupler forces were developed for a test car which was loaded to a shell full condition as compared to a 1 percent outage condition.  - When installed, two baffle-type safety vent nozzle surge pressure reducers (SPR's) effectively reduced surge pressures acting on frangible discs installed in 2 1/2 inch and 6 1/2 inch diameter nozzle safety vents. The SPR's prevented the discs from rupturing during coupling impacts involving forces up to 1200 kips.					
17. Key Words Tank Car Impact Safety Vent Nozzle Surge Pressures During Impacts Impact Conditions Resulting in Frangible Disc Rupture Safety Vent Nozzle Surge Pressure Reducer Devices			18. Distribution Statement  This document is available through National Technical Information Service Springfield, VA 22161		
19. Security Classification (of the report) Unclassified		20. Security Classification (of this page) Unclassified		21. No. of Pages 80	22. Price

## METRIC CONVERSION FACTORS

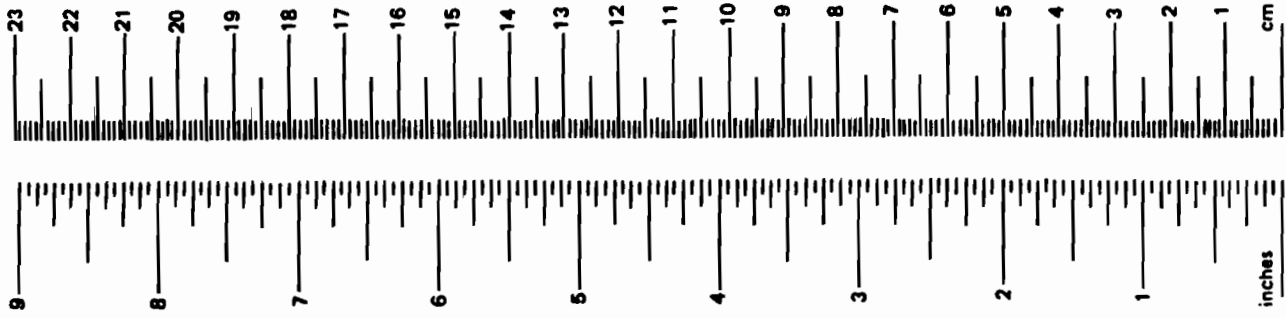

## Approximate Conversions to Metric Measures

Symbol	When You Know	Multiply by	To Find	Symbol
<b>LENGTH</b>				
in	inches	*2.50	centimeters	cm
ft	feet	30.00	centimeters	cm
yd	yards	0.90	meters	m
mi	miles	1.60	kilometers	km
<b>AREA</b>				
in <sup>2</sup>	square inches	6.50	square centimeters	cm <sup>2</sup>
ft <sup>2</sup>	square feet	0.09	square meters	m <sup>2</sup>
yd <sup>2</sup>	square yards	0.80	square meters	m <sup>2</sup>
mi <sup>2</sup>	square miles	2.60	square kilometers	km <sup>2</sup>
	acres	0.40	hectares	ha
<b>MASS (weight)</b>				
oz	ounces	28.00	grams	g
lb	pounds	0.45	kilograms	kg
	short tons (2000 lb)	0.90	tonnes	t
<b>VOLUME</b>				
tsp	teaspoons	5.00	milliliters	ml
Tbsp	tablespoons	15.00	milliliters	ml
fl oz	fluid ounces	30.00	milliliters	ml
c	cups	0.24	liters	l
pt	pints	0.47	liters	l
qt	quarts	0.95	liters	l
gal	gallons	3.80	liters	l
ft <sup>3</sup>	cubic feet	0.03	cubic meters	m <sup>3</sup>
yd <sup>3</sup>	cubic yards	0.76	cubic meters	m <sup>3</sup>
<b>TEMPERATURE (exact)</b>				
'F	Fahrenheit temperature	5/9 (after subtracting 32)	Celsius temperature	'C

## Approximate Conversions from Metric Measures

Symbol	When You Know	Multiply by	To Find	Symbol
<b>LENGTH</b>				
mm	millimeters	0.04	inches	in
cm	centimeters	0.40	inches	in
m	meters	3.30	feet	ft
m	meters	1.10	yards	yd
km	kilometers	0.60	miles	mi
<b>AREA</b>				
cm <sup>2</sup>	square centim.	0.16	square inches	in <sup>2</sup>
m <sup>2</sup>	square meters	1.20	square yards	yd <sup>2</sup>
km <sup>2</sup>	square kilom.	0.40	square miles	mi <sup>2</sup>
ha	hectares (10,000 m <sup>2</sup> )	2.50	acres	
<b>MASS (weight)</b>				
g	grams	0.035	ounces	oz
kg	kilograms	2.2	pounds	lb
t	tonnes (1000 kg)	1.1	short tons	
<b>VOLUME</b>				
ml	milliliters	0.03	fluid ounces	fl oz
l	liters	2.10	pints	pt
l	liters	1.06	quarts	qt
l	liters	0.26	gallons	gal
m <sup>3</sup>	cubic meters	36.00	cubic feet	ft <sup>3</sup>
m <sup>3</sup>	cubic meters	1.30	cubic yards	yd <sup>3</sup>
<b>TEMPERATURE (exact)</b>				
'C	Celsius temperature	9/5 (then add 32)	Fahrenheit temperature	'F

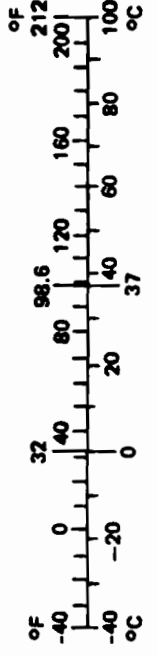

\* 1 in. = 2.54 cm (exactly)

## Table of Contents

1.0 INTRODUCTION .....	1
2.0 OBJECTIVE .....	2
3.0 METHODOLOGY .....	2
3.1 TEST CAR .....	3
4.0 TEST MATRIX .....	5
4.1 TEST SERIES 1: TANK CAR IMPACTS WITH BLIND FLANGES INSTALLED ON SAFETY VENT NOZZLES .....	5
4.1.1 Car Preparation .....	5
4.1.2 Test Procedures .....	8
4.2 TEST SERIES 2: TANK CAR IMPACTS WITH SAFETY VENTS INSTALLED .....	8
4.2.1 Car Preparation .....	8
4.2.2 Test Procedures .....	8
4.3 TEST SERIES 3: TANK CAR IMPACTS WITH SURGE PRESSURE REDUCERS INSTALLED IN SAFETY VENT NOZZLES .....	11
4.3.1 Car Preparation .....	11
4.3.2 Test Procedures .....	13
4.4 TEST SERIES 4: TANK CAR IMPACTS WITH SURGE PRESSURE REDUCERS AND SAFETY VENTS INSTALLED .....	13
4.4.1 Car Preparation .....	13
4.4.2 Test Procedures .....	17
4.5 TEST MATRIX .....	17
5.0 MATERIALS .....	20
5.1 TEST VEHICLES .....	20
6.0 MEASUREMENTS AND INSTRUMENTATION .....	21

<b>7.0 RESULTS .....</b>	<b>23</b>
<b>7.1 SAFETY VENT NOZZLE SURGE PRESSURE AND COUPLER FORCE .....</b>	<b>23</b>
<b>7.2 SUMMARY PLOTS OF SURGE PRESSURES .....</b>	<b>23</b>
<b>7.3 IMPACT CONDITIONS CAUSING DISC RUPTURE .....</b>	<b>23</b>
<b>7.4 VENT SURGE PRESSURES BEFORE AND AFTER INSTALLATION OF SPR'S .....</b>	<b>23</b>
<b>7.5 COUPLER FORCE VS IMPACT SPEED AND OUTAGE .....</b>	<b>23</b>
<b>7.6 B-END TANK SHELL STRAIN VS COUPLER FORCE AND IMPACT SPEED .....</b>	<b>23</b>
<b>7.7 VIDEO RECORDS .....</b>	<b>23</b>
<b>8.0 DISCUSSION .....</b>	<b>38</b>
<b>9.0 CONCLUSIONS .....</b>	<b>43</b>
<b>APPENDIX A: SAFETY VENT NOZZLE AND SURGE PRESSURE REDUCER DIMENSIONS .....</b>	<b>45</b>
<b>APPENDIX B: IMPACT TEST DATA - SAFETY VENT NOZZLE SURGE PRESSURES AND COUPLER FORCES MEASURED DURING TEST SERIES 1A - 4F .....</b>	<b>53</b>
<b>APPENDIX C: VIDEO LOG - LIST OF VIDEO RECORDINGS SHOWING DISC RUPTURES .....</b>	<b>77</b>

## Table of Figures

Figure 1. DOT 111A-100w2 Tank Car .....	4
Figure 2. View of Instrumented Coupler .....	6
Figure 3. View of Strain Gage Rosette (9' 3/8" from B-end) .....	6
Figure 4. View of Strain Gage Rosette 2 (Location is on Middle Cross Section of Car) .....	7
Figure 5. View of the Weighted Locomotive Used as Hammer Car .....	9
Figure 6. View of Test Car and Three Backstop Cars .....	9
Figure 7. Surge Chamber, Physical Test Setups .....	10
Figure 8. View of Surge Pressure Reducers .....	12
Figure 9. View of Safety Vent/Baffle Type SPR for 6 1/2" Safety Vent .....	14
Figure 10. View of Safety Vent/Mesh Type SPR for 6 1/2" Safety Vent .....	15
Figure 11. View of Safety Vent/Pipe Type SPR for 4 1/2" Safety Vent .....	16
Figure 12. Instrumentation Layout .....	21
Figure 13. Surge Pressure vs Distance From Struck End & Impact Speed -- 0% outage, B-end Impacted, Blind Flanges Installed .....	24
Figure 14. Surge Pressure vs Distance From Struck End & Impact Speed -- 1% outage, B-end Impacted, Blind Flanges Installed .....	25
Figure 15. Surge Pressure vs Distance From Struck End & Impact Speed -- 2% outage, B-end Impacted, Blind Flanges Installed .....	26
Figure 16. Surge Pressure vs Distance From Struck End & Impact Speed -- 4% outage, B-end Impacted, Blind Flanges Installed .....	27
Figure 17. Surge Pressure vs Distance From Struck End & Impact Speed -- 0% outage, A-end Impacted, Blind Flanges Installed .....	28
Figure 18. Surge Pressure vs Distance From Struck End & Impact Speed -- 2% outage, A-end Impacted, Blind Flanges Installed .....	29
Figure 19. Surge Pressure in 2 1/2" Nozzle 0% outage, B-end Impacted .....	30
Figure 20. Surge Pressure in 2 1/2" Nozzle 0% outage, A-end Impacted .....	30
Figure 21. Surge Pressure in 4 1/2" Nozzle 0% outage, B-end Impacted .....	31
Figure 22. Surge Pressure in 4 1/2" Nozzle 0% outage, A-end Impacted .....	31
Figure 23. Surge Pressure in 6 1/2" Nozzle 0% outage, B-end Impacted .....	32
Figure 24. Surge Pressure in 6 1/2" Nozzle 0% outage, A-end Impacted .....	32

Figure 25. Surge Pressure in 2 1/2" Nozzle Without SPR, 0% outage, B-end Impacted at 5 mph .....	34
Figure 26. Surge Pressure in 2 1/2" Nozzle With SPR, 0% outage, B-end Impacted at 5 mph .....	34
Figure 27. Surge Pressure in 6 1/2" Nozzle Without SPR, 0% outage, A-end Impacted at 5 mph .....	35
Figure 28. Surge Pressure in 6 1/2" Nozzle With SPR, 0% outage, A-end Impacted at 5 mph .....	35
Figure 29. Coupler Force vs Impact Speed, 0% Outage, B-end Impacted .....	36
Figure 30. Coupler Force vs Impact Speed, 0% Outage, A-end Impacted .....	36
Figure 31. Longitudinal and Lateral Strains vs Coupler Force .....	37
Figure 32. Longitudinal and Lateral Strains vs Impact Speed .....	37
Figure 33. Percent Reduction in Surge Pressure For Three SPR Designs (0% Outage, 5 mph Impact Speed) .....	41



## Tables

Table 1. General Test Matrix for Characterization of Impact Surge Pressures .....	18-19
Table 2. Test Conditions Which Resulted in the Rupture of 60 psi Discs .....	33
Table 3. Test Conditions Which Resulted in the Rupture of 100 psi Discs .....	33
Table 4. Conditions Leading to Disc Rupture .....	39

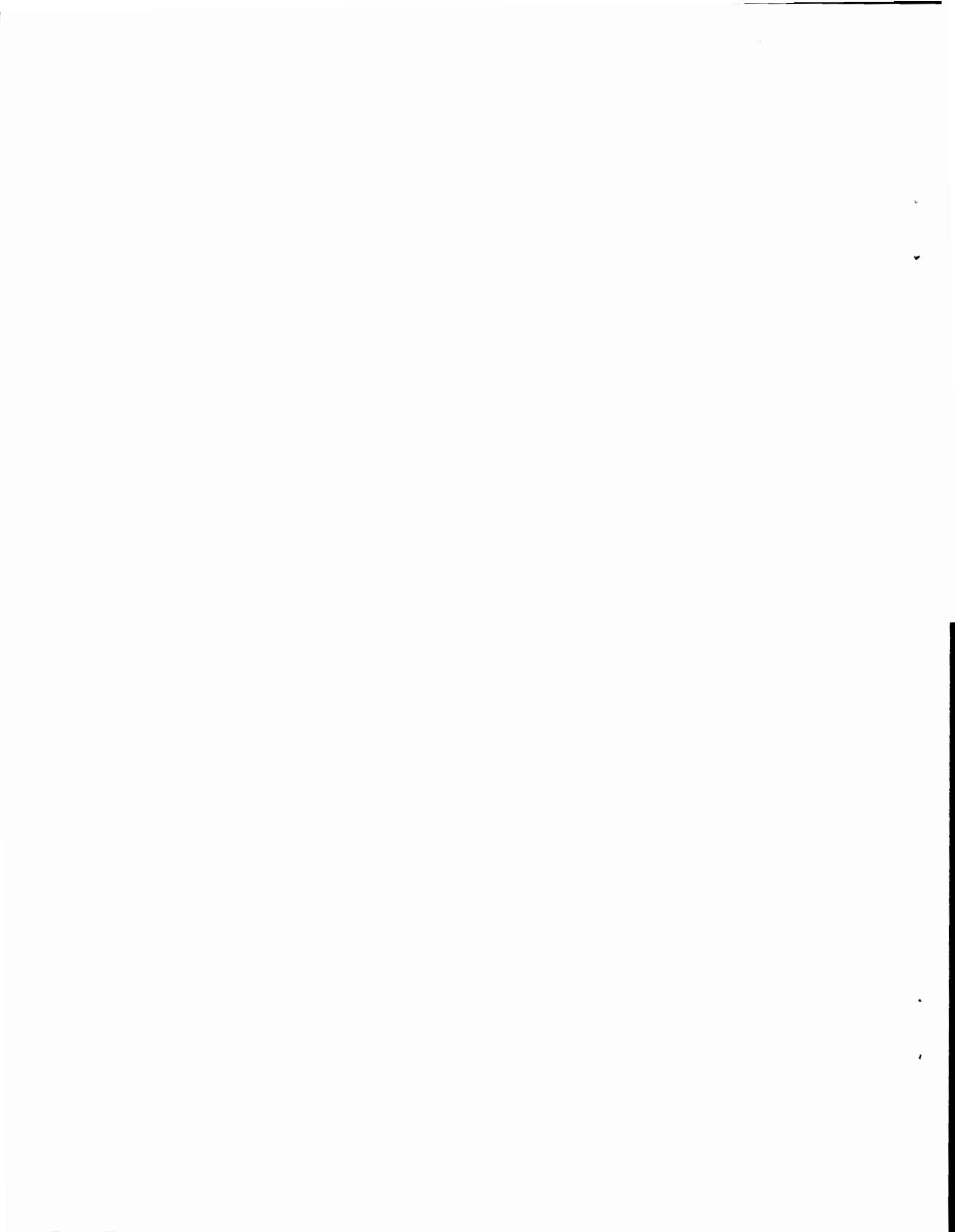

## 1.0 INTRODUCTION

Tank cars transporting corrosive liquids are often equipped with safety vents which employ frangible discs to protect the tank from over-pressurization during fires.

Premature failure of the frangible disc occasionally occurs during switching operations. The failure is caused by surge pressures resulting from liquid movement inside the tank car during switching speeds above 4 mph. These surge pressures can exceed the rated pressure of the disc, causing it to break. Once the disc is broken, product can repeatedly discharge through the safety vent during routine car handling. If railroad personnel are exposed to the discharged product, serious injury can result.

This study was funded by the Federal Railroad Administration (FRA) to determine the magnitude of surge pressures that the safety vent is exposed to at various speeds and to test devices that are designed to reduce these surge pressures. The effect of lading outage on surge pressure and the variation of surge pressures along the length of the car was also examined (outage is defined in the Code of Federal Regulations, Title 49 as "the amount by which a packaging falls short of being liquid full, usually expressed in percent by volume").

The study was performed under a research program entitled "Hazardous Materials Transportation Safety Research." Under the same program, the Association of American Railroads (AAR) had previously conducted a series of tests to evaluate the performance of various frangible disc designs under laboratory conditions. Tests were performed to determine the range of burst pressures for five types of discs by subjecting them to test pressures as specified by the *AAR Manual of Standards and Recommended Practices (A5.03)*. The effect of temperature, creep, pressure surge, and exposure to corrosive materials on the burst pressures of frangible discs was also examined. <sup>1</sup>

<sup>1</sup> DiBrito, D. A. and B. R. Rajkumar. "Tank Car Frangible Disc Test," April 89 Final Report to FRA, AAR, 1989.

The present report documents results from a series of tests in which a weighted locomotive was coupled to a stationary DOT 111A100W2 tank car at different speeds. Pressure surge and coupler force data are presented for a matrix of test conditions which include impact speed, lading outage, and type of equipment installed on safety vent nozzles placed at three locations along the length of the car.

## **2.0 OBJECTIVE**

The objective of these tests was to provide an understanding of coupler forces and internal pressures developed during controlled impacts with tank cars. It was projected that this information could be used for the future qualification of surge pressure reducer and vent spill trap devices.

## **3.0 METHODOLOGY**

Four types of tests were performed to investigate the influence of typical switch-yard type impacts on tank car surge pressure. The four types of tests were:

- Series 1 - Tank Car Impacts With Blind Flanges Installed On Safety Vent Nozzles
- Series 2 - Tank Car Impacts With Safety Vents Installed
- Series 3 - Tank Car Impacts With Surge Pressure Reducers Installed In Safety Vent Nozzles
- Series 4 - Tank Car Impacts With Surge Pressure Reducers And Safety Vents Installed

The objective of the Test Series 1 was to measure surge pressures inside safety vent nozzles. Since safety vent design could influence surge pressures at the safety vent nozzle, it was determined that this test series should be performed with the safety vent nozzle sealed with a blind flange to eliminate safety vent design as a test variable.

The objective of Test Series 2 was to measure surge pressures which occur inside safety vents with frangible discs installed. One type of safety vent design was used in the test series.

The objective of Test Series 3 and 4 was to measure the reduction in safety vent surge pressure produced by several prototype surge pressure reducers. In Test Series 3, the end of the surge pressure reducer was sealed off with a blind flange; in Test Series 4, the same safety vents used during test series 2 were installed outboard of each surge pressure reducer.

For each of the above test series, impact tests were conducted for lading outages of 0 percent, 1 percent, 2 percent and 4 percent and test speeds ranging from 3 to 8 mph. A fifth test series, tank car impacts with vent spill traps installed, was planned but could not be conducted since the required vent spill traps were not available during testing.

### 3.1 TEST CAR

A DOT 111A100W2 tank car was used for the impact tests. The car was equipped with a 6 1/2 inch safety vent nozzle, a 4 1/2 inch sump nozzle on the manway, a 2 1/2 inch safety vent nozzle, and 2-inch pipe fittings on each end of the tank (Figure 1). The car, which was provided by Union Tank Car, had previously been used for transporting phosphoric acid. Prior to the test, a rubber lining was removed from the inside of the car and the acid residue was flushed out.

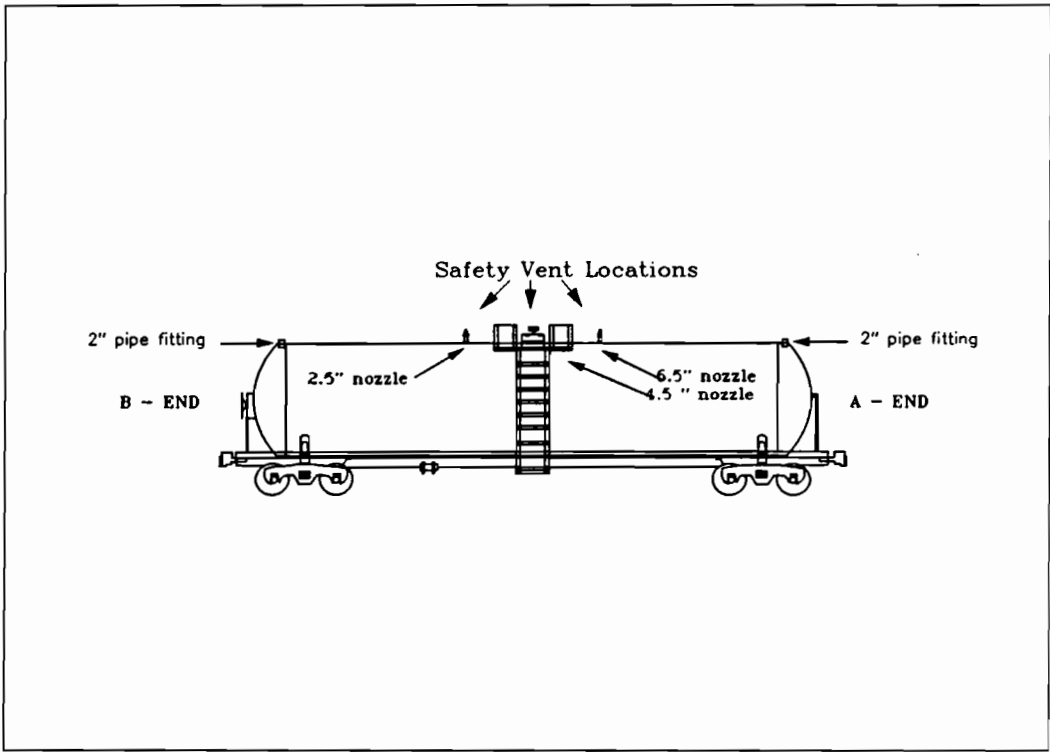

Figure 1. DOT 111A100W2 Tank Car

## **4.0 TEST MATRIX**

The controlled tank car impact test series were conducted to determine the magnitude of surge pressures that develop at various speeds and to test devices that were designed to reduce the surge pressure that the safety vent is exposed to. The effect of lading outage on surge pressures and the variation of surge pressures along the length of the car was also examined. The manner in which the test car was prepared and the test procedures that were used are described below for each of the test series.

### **4.1 TEST SERIES 1: TANK CAR IMPACTS WITH BLIND FLANGES INSTALLED ON SAFETY VENT NOZZLES**

#### **4.1.1 Car Preparation**

Pressure transducers were mounted on the side of both safety vent nozzle locations, on the side of the 4 1/2 inch sump nozzle on the manway, and on each end of the car on the top of the tank. The safety vents were replaced with blind flanges and a blind flange was mounted on the end of the 4 1/2 inch sump nozzle (the sump pipe assembly was removed and was not in place during Test Series 1 and following test series). An instrumented coupler (Figure 2) was installed to allow measurement of impact forces. An accelerometer was mounted 9 feet 3/8 inches from the B-end of the tank on the underside of the car on the center line. Two strain gages (Figures 3,4) were also mounted on the underbelly of the car to allow the detection of possible structural yielding as a result of impacts sustained during the test series. The first gage was located on the tank shell 12 inches to the side of the accelerometer. The second gage was located in the middle of the car, on the underside, 8 inches to the side of the center line on the tank shell. The signals from the above instrumentation were recorded on data acquisition computers. Velocity was calculated based on timing measurements made with two automatic locating device reflectors on the impact car.

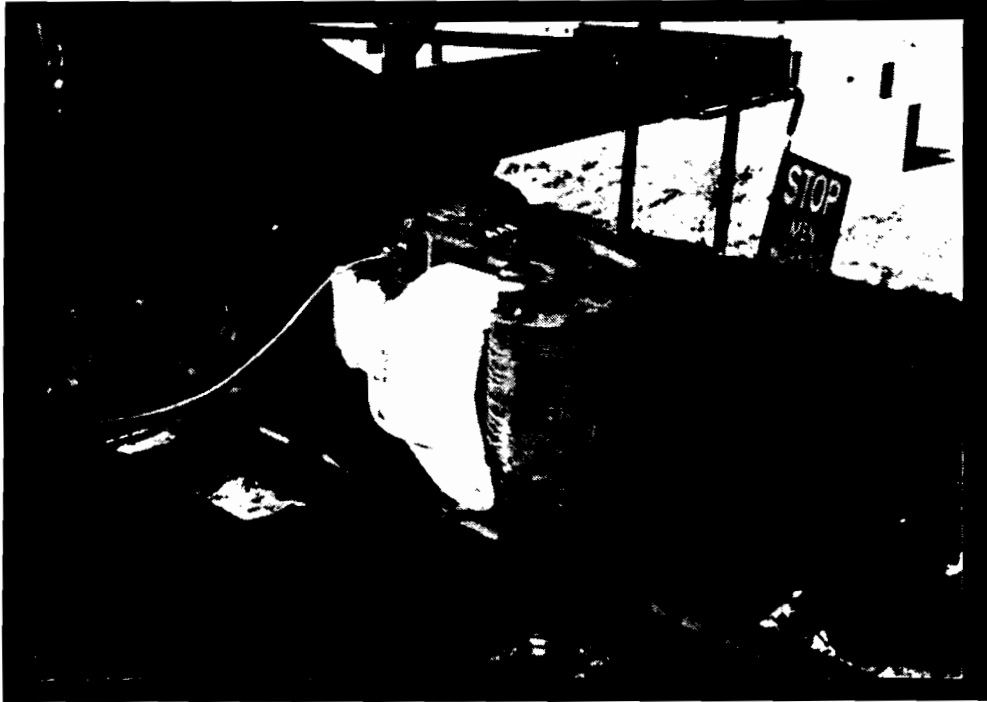

Figure 2. View of Instrumented Coupler

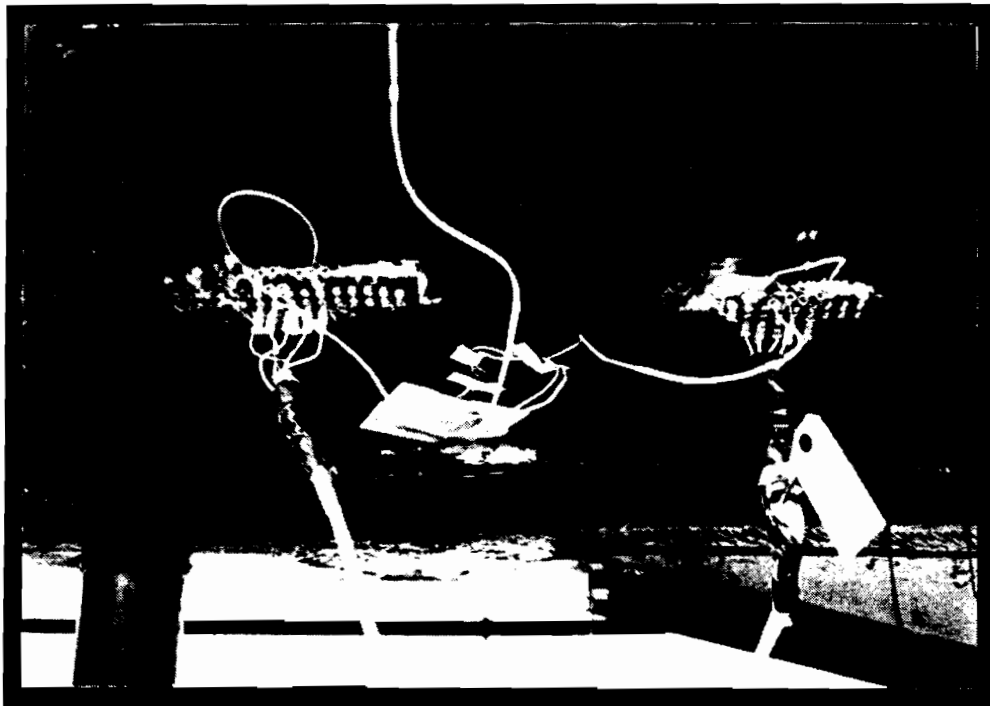

Figure 3. View of Strain Gage Rosette  
(9' 3/8" from B-end)



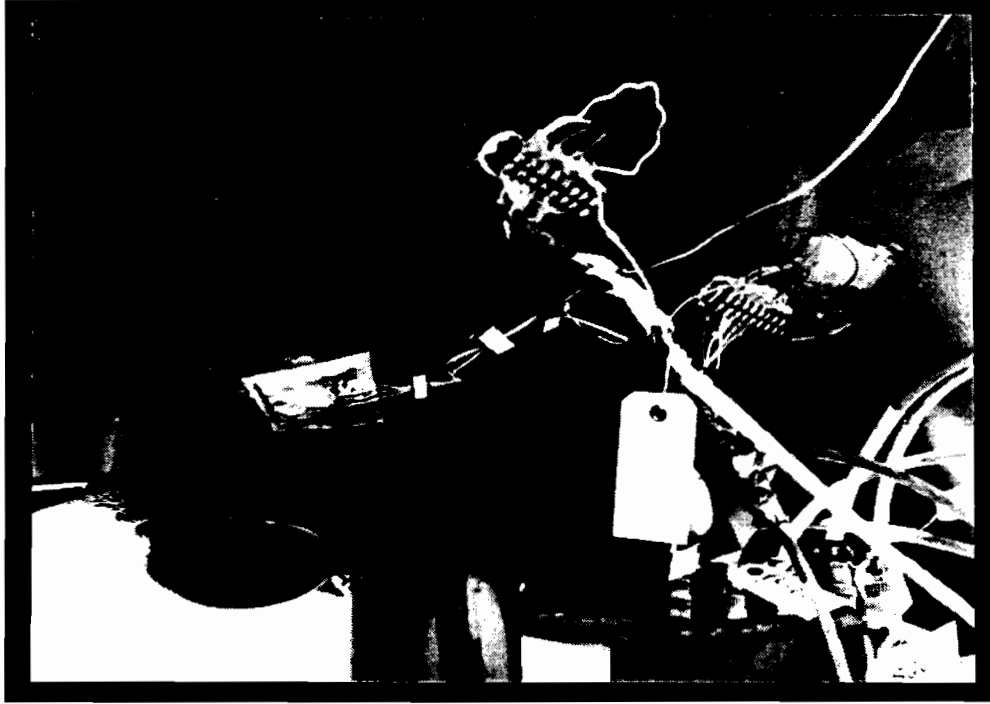

Figure 4. View of Strain Gage Rosette 2  
(Location is on Middle Cross  
Section of Car)

#### 4.1.2 Test Procedures

A weighted locomotive (Figure 5) was used to impact the stationary test car at various speeds to simulate yard switching. The speed of the locomotive at impact was controlled by placing the locomotive a predetermined distance uphill from the test car on a constant grade track. Three loaded hopper cars, placed downhill of the test car, were used as a backstop. Figure 6 shows the test car and three hopper cars. Impacts were initiated at 3 mph and increased in 1 mph increments until a 1,250 kip coupler force was achieved (at approximately 8 mph). Speed, coupler force, and pressure at each transducer location were recorded. Tests were conducted at outages of 0 percent, 1 percent, 2 percent, and 4 percent. Water level was checked periodically to assure that the outages were at the desired level. Surge chamber volumes and inlet areas were recorded for each safety vent nozzle (see Figure 7).

### 4.2 TEST SERIES 2: TANK CAR IMPACTS WITH SAFETY VENTS INSTALLED

#### 4.2.1 Car Preparation

The same instrumentation was used as in Test Series 1. Safety vents were installed on the safety vent nozzles and fitted initially with 60 pounds per square inch (psi) pressure rating frangible discs. In the event of a disc rupture during an impact, the test was repeated with a 100 psi disc in place of the 60 psi frangible disc.

#### 4.2.2 Test Procedures

Test procedures were the same as were used in Test Series 1 except that impacts were initiated at a speed 1 mph less than the minimum speed required to produce a disk rupture (based on Test Series 1 measurements) and increased in 1 mph increments until all three discs failed or until a 1,250 kip coupler force was achieved.



Figure 5. View of the Weighted Locomotive Used as Hammer Car



Figure 6. View of Test Car and Three Backstop Cars

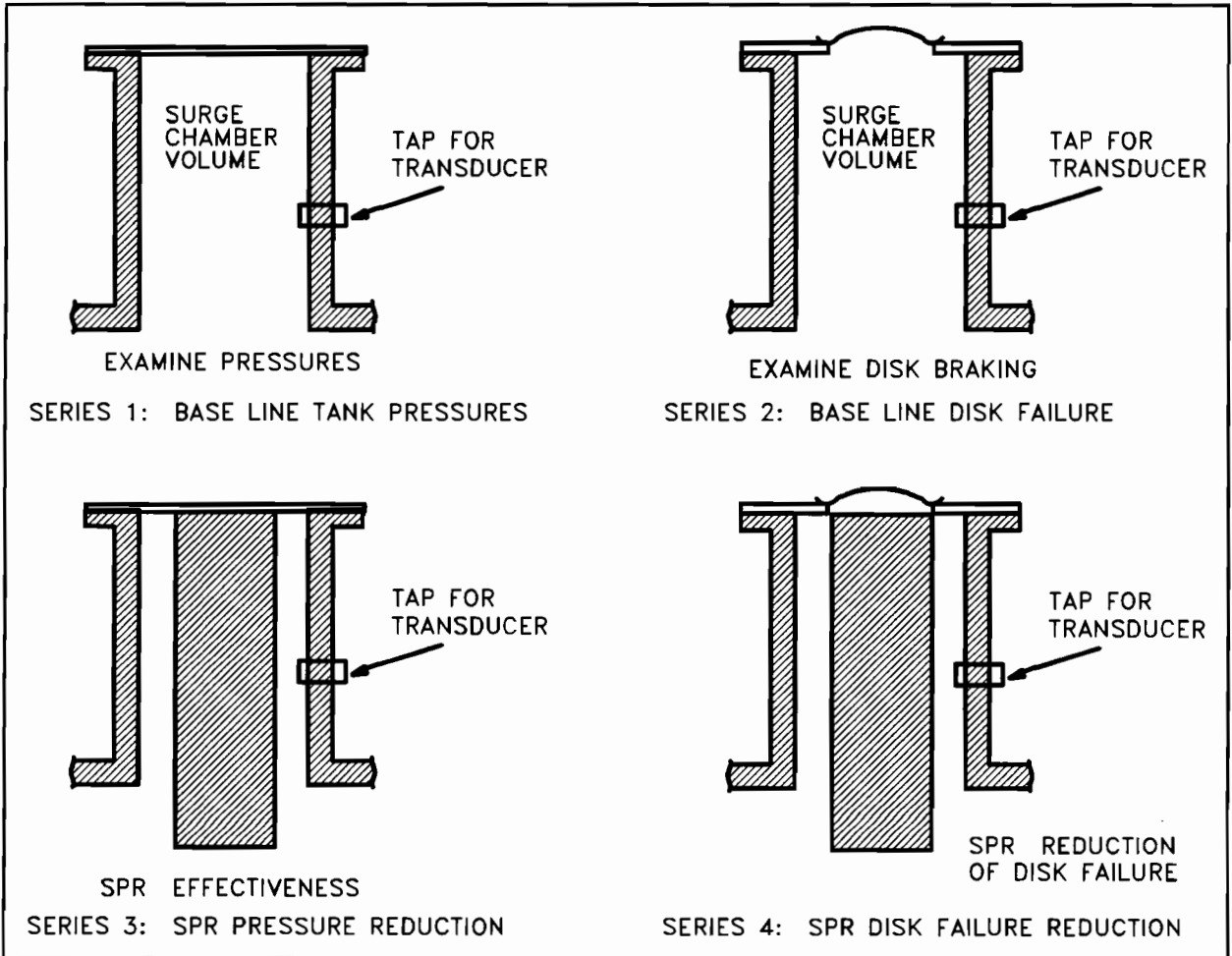

Figure 7. Display of the Four Set-ups Used in this Test

### 4.3 TEST SERIES 3: TANK CAR IMPACTS WITH SURGE PRESSURE REDUCERS INSTALLED IN SAFETY VENT NOZZLES

#### 4.3.1 Car Preparation

The same instrumentation was used as in Test Series 1 except that the pressure transducer which was normally on the end of the tank car was moved to the side of one of the pipe-type surge pressure reducers (SPR's) on either the 2 1/2 inch nozzle or 4 1/2 inch nozzle. Candidate SPR's were placed in each safety vent. Drawings of each of the SPR's and their respective safety vents are given in Appendix A.

Three general types of SPR's were tested. The "baffle" type SPR incorporates an annular-shaped flow restriction and was designed for installation in a standard safety vent nozzle.

The "pipe" type SPR utilizes a pipe with a hole on the end that serves to restrict the flow. This type of SPR was designed for installation in either the manway sump nozzle or in a safety vent nozzle.

The "mesh" type SPR utilizes a steel mesh to create the desired flow restriction. The mesh type SPR was designed for use in a safety vent nozzle.

Each of the SPR prototypes was designed to reduce surge pressures impinging on a frangible disc while allowing adequate venting in circumstances where a sustained pressure exceeds the rated pressure of the installed disc.

Figure 8 shows three of the SPR's used during testing.

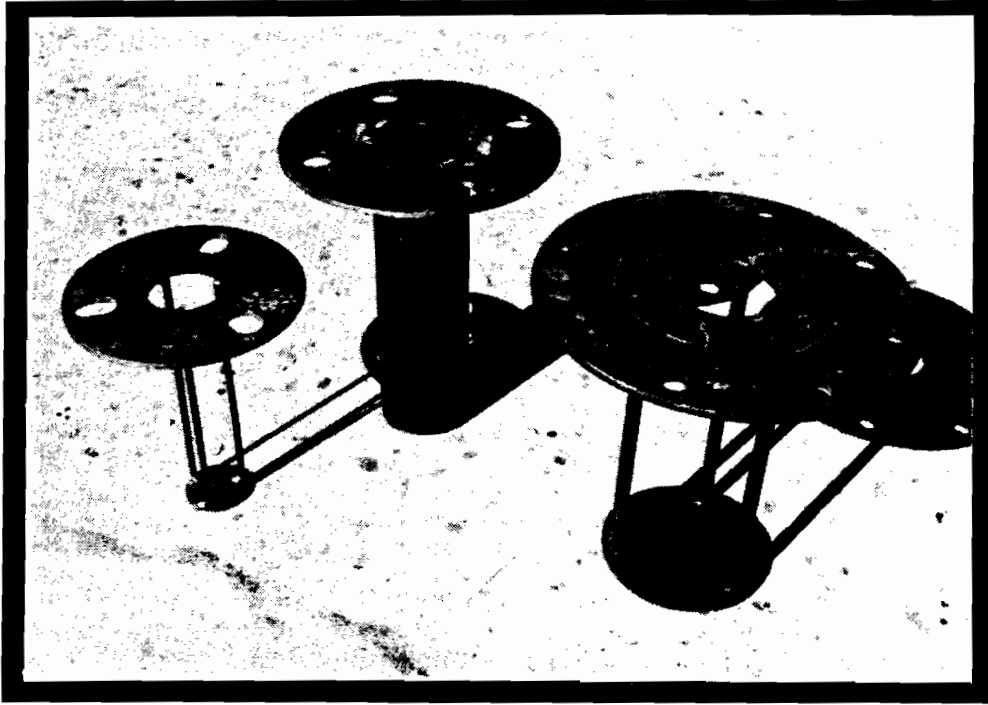

Figure 8. View of Surge Pressure Reducers  
(left to right):  
Baffle Type SPR for 2 1/2" Safety Vent,  
Pipe Type SPR for 4 1/2" Sump Nozzle,  
Baffle Type SPR for 6 1/2" Safety Vent

#### 4.3.2 Test Procedures

Test procedures were the same as was used in Test Series 1 except that the impacts were initiated at the approximate speed which resulted in dis ruptures in Test Series 2. Tests were conducted with all candidate SPR's.

#### 4.4 TEST SERIES 4: TANK CAR IMPACTS WITH SURGE PRESSURE REDUCERS AND SAFETY VENTS INSTALLED

##### 4.4.1 Car Preparation

The same instrumentation was used as in Test Series 2. The surge pressure reducers were placed in each safety vent nozzle and the safety vents were installed. The three tested safety vent and SPR assemblies are shown in Figures 9, 10, and 11.

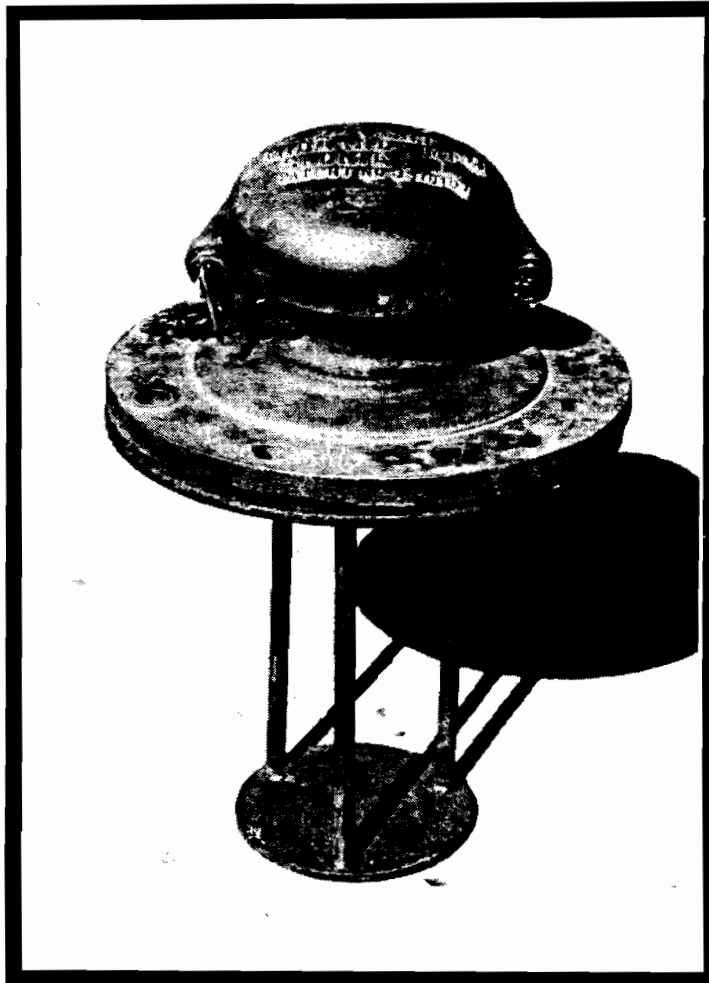

Figure 9. View of Safety Vent/Baffle Type SPR for 6 1/2" Safety Vent





Figure 10. View of Safety Vent/Mesh Type SPR for 6 1/2" Safety Vent



Figure 11. View of Safety Vent/Pipe Type SPR  
for 4 1/2" Safety Vent

#### **4.4.2 Test Procedures**

Test procedures were the same as were used in Test Series 3.

#### **4.5 TEST MATRIX**

The general test matrix for the controlled tank car impact test series is given in Table 1.

**TABLE 1.**  
**GENERAL TEST MATRIX FOR CHARACTERIZATION**  
**OF IMPACT SURGE PRESSURES.**

**B - END IMPACTS**

<b>TEST SERIES</b>	<b>VENT NOZZLE</b>	<b>OUTAGE</b>	<b>IMPACT SPEED</b>	<b>COUPLER FORCE</b>
1A	blind flange	0%	3 mph 4 mph 5 mph  (speed increased until max. coupler force attained)	Up to 1250 kips
2A	60 psi or 100 psi frangible discs at all vent locations (depending on pressures measured in the previous test)	0%	1 mph below predicted initial rupture speed (determined from Series 1A) and increased in 1 mph increments until all 3 discs ruptured	Up to 1250 kips
3A	candidate Surge Pressure Reducers (SPR's) with blind flanges	0%	at the speed where discs ruptured in Series 2A and increased in 1 mph increments until max. coupler force attained	Up to 1250 kips
4A	candidate SPR's with safety vents	0%	at the speed where discs ruptured in Series 2A and increased until all 3 discs ruptured	Up to 1250 kips

Series one through four repeated for the following outages:

1B, 2B, 3B, 4B      FOR 1% OUTAGE

1C, 2C, 3C, 4C      FOR 2% OUTAGE

1D, 2D, 3D, 4D      FOR 4% OUTAGE

**TABLE 1.**  
**GENERAL TEST MATRIX FOR CHARACTERIZATION**  
**OF IMPACT SURGE PRESSURES -- (continued)**

**A - END IMPACTS\***

<b>TEST SERIES</b>	<b>VENT NOZZLE</b>	<b>OUTAGE</b>	<b>IMPACT SPEED</b>	<b>COUPLER FORCE</b>
1E	blind flange	0%	3 mph 4 mph 5 mph . (speed increased untill max. coupler force attained)	Up to 1250 kips
3E	candidate SPR's with blind flanges	0%	1 mph below predicted initial rupture speed (determined from Series 1E) and increased in 1 mph increments until max. coupler force attained	Up to 1250 kips
1F	blind flange	2%	3 mph 4 mph 5 mph . (speed increased untill max. coupler force attained)	Up to 1250 kips
3F	candidate SPR's with blind flanges	2%	1 mph below predicted rupture speed (determined from Series 1F) and increased in 1 mph increments until max. coupler force attained	Up to 1250 kips

\* The A-end Impact Test Series was added to the test matrix approved by FRA in the original Test Implementation Plan.

## **5.0 MATERIALS**

### **5.1 TEST VEHICLES**

The following cars were required for this program:

- Hammer Car:** Modified locomotive (weight: 237,050 lbs) used in puncture tests with MS 488 draft gear (nose assembly was removed)
- Freight Cars:** Three loaded freight cars (total weight: 400,450 lbs) to backstop for the impacted tank car.
- Tank Car:** 15,000 gallon - non-coiled, non-insulated, 111A100W2 car. The car had provisions for mounting safety vents on two separate nozzles (one a 6 1/2 inch diameter and the other a 2 1/2 inch diameter nozzle on each side of the manway), and also on the top unload assembly (4 1/2 inch sump nozzle) located on the manway. The car was equipped with an instrumented coupler.

## 6.0 MEASUREMENTS AND INSTRUMENTATION

The instrumentation layout for the impact test series is shown below.

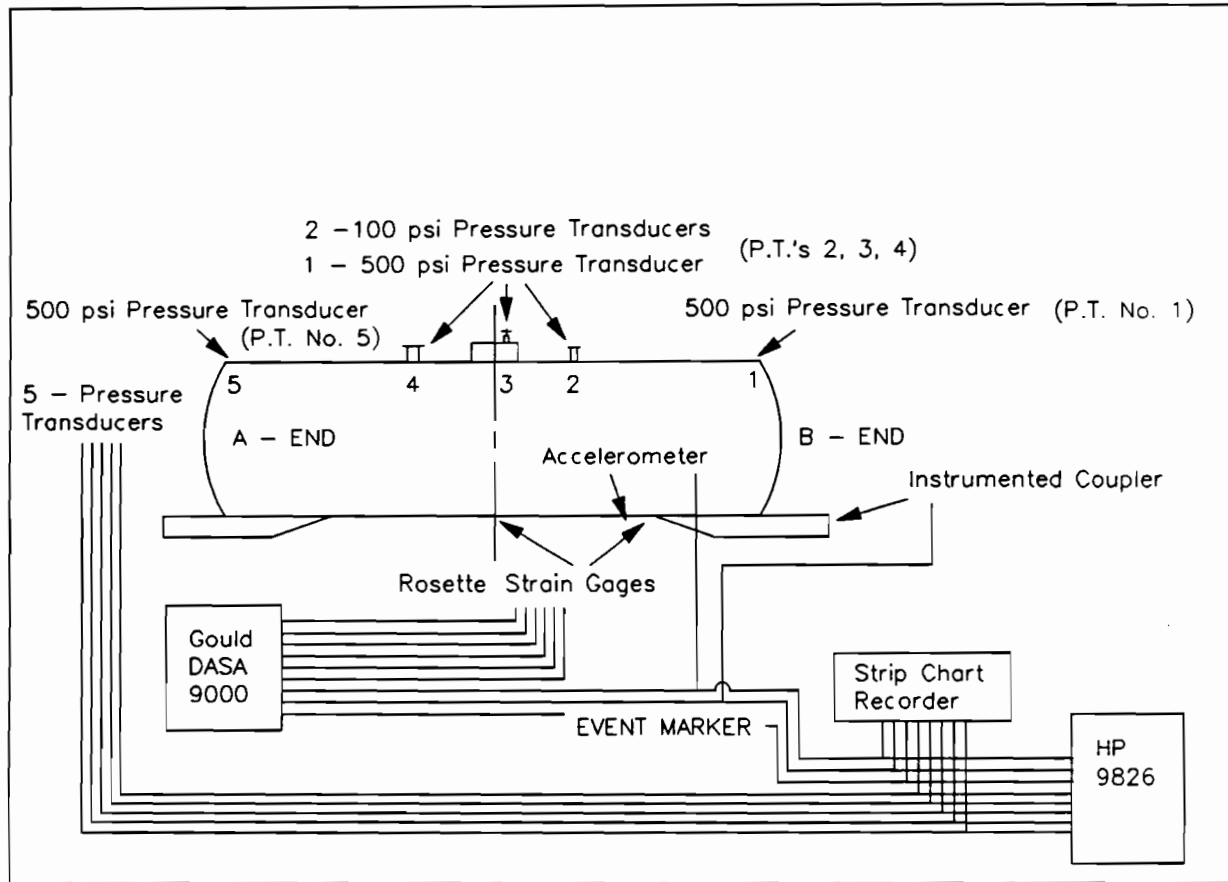

Figure 12. Instrumentation Layout

Two pressure transducers rated at 100 psi and three pressure transducers rated at 500 psi were used to measure the peak pressures at the five designated locations of the tank car during impact. The 100 psi transducers were installed at the two safety vent nozzles nearest to the impacted end of the car and the 500 psi transducers were installed at the other locations.

An instrumented coupler mounted on the tank car was used to measure the impact force.

A 0 - 100 g (1g equals 32.17 feet per second per second) accelerometer was used to measure the impact velocity. The accelerometer frequency response was 0.2 - 6 khz (1khz equals 1000 cycles per second).

Two strain gage rosettes were mounted on the tank car underbelly at the locations described in Section 4.3.1.

A Hewlett-Packard 9826 data acquisition system with a Bernoulli drive and a Gould DASA 9000 with a personal computer were used to acquire and store data.

A video camera was used to record splashes resulting from ruptured discs in Test Series 2.



## **7.0 RESULTS**

Time history plots of pressure and coupler force test data were provided to the Transportation Systems Center (TSC). The test data was also converted to ASCII format on 3.5 inch floppy discs and shipped to TSC after the completion of the test series for detailed analysis. Following are highlights of the test results.

### **7.1 SAFETY VENT NOZZLE SURGE PRESSURE AND COUPLER FORCE**

Safety vent nozzle surge pressures and coupler force for each of the impact tests are provided in Appendix B. The data is arranged by test series (1A through 4F).

### **7.2 SUMMARY PLOTS OF SURGE PRESSURES**

Plots of safety vent nozzle surge pressures for different outages and test speeds are given in Figures 13 through 24.

During certain tests, the surge pressure exceeded the maximum range of the data collection system for one or more of the instrumentation channels. In those cases, the surge pressure for a given channel was taken to be equal to the maximum recorded pressure even though the true value could be assumed to be somewhat higher. The affected data points are denoted with an asterisk in Figures 13 through 24.

### **7.3 IMPACT CONDITIONS CAUSING DISC RUPTURE**

Tables 2 and 3 list the test conditions that caused the installed frangible discs to fail.

### **7.4 VENT SURGE PRESSURES BEFORE AND AFTER INSTALLATION OF SPR'S**

Figures 25-28 show time histories of safety vent nozzle surge pressures before and after installation of two baffle type SPR's.

### **7.5 COUPLER FORCE VS IMPACT SPEED AND OUTAGE**

Coupler force is plotted for various impact speeds and outages in Figures 29 and 30.

### **7.6 B-END TANK SHELL STRAIN VS COUPLER FORCE AND IMPACT SPEED**

B-end tank shell longitudinal and lateral strain data for impacts with 0 percent lading outage is plotted in Figures 31 and 32.

### **7.7 VIDEO RECORDS**

A listing of video log times corresponding to disc ruptures is provided in Appendix C.

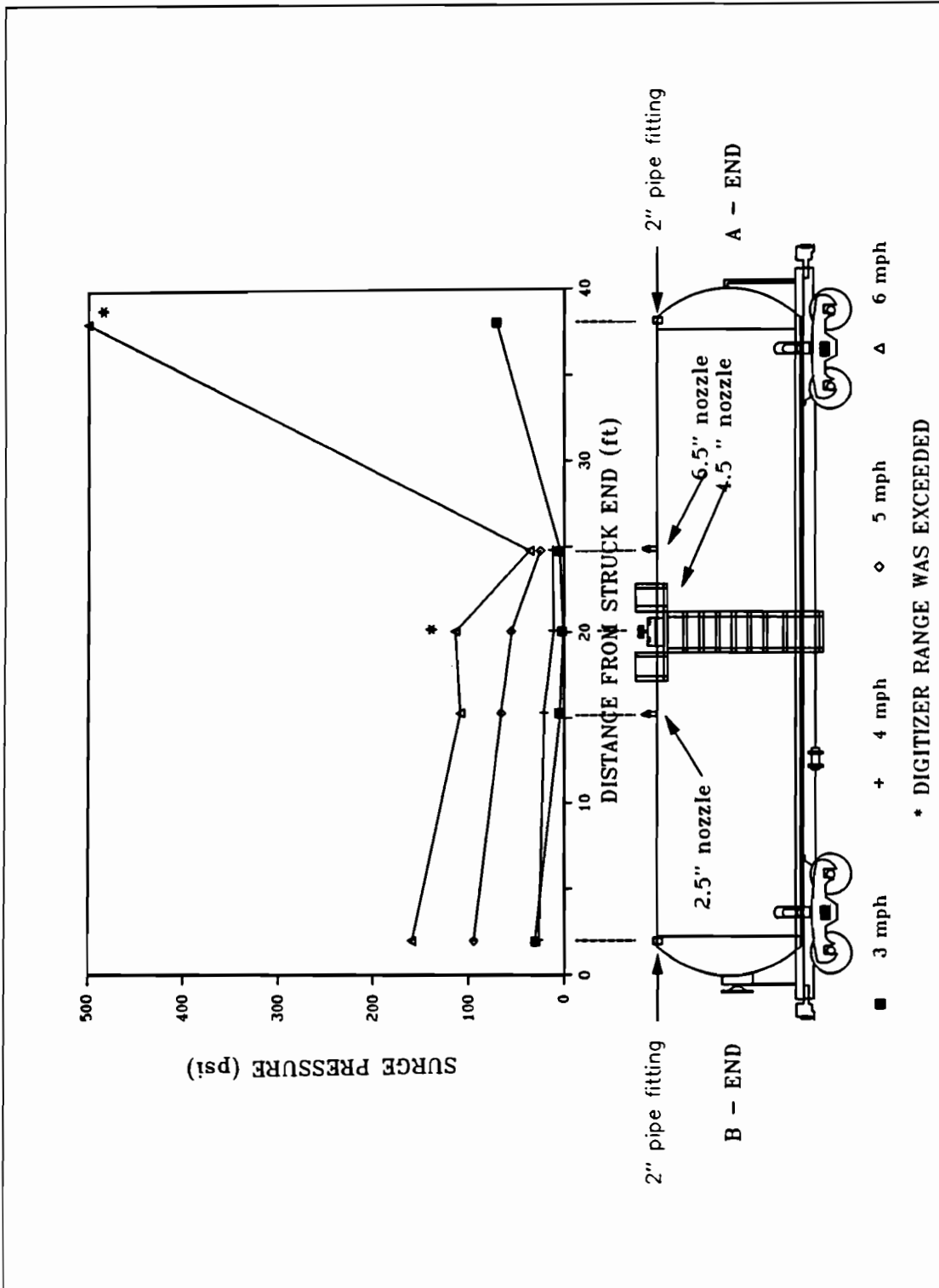

Figure 13. Surge Pressure vs Distance from Struck End & Impact Speed -- 0% Outage, B-end Impacted, Blind Flanges Installed

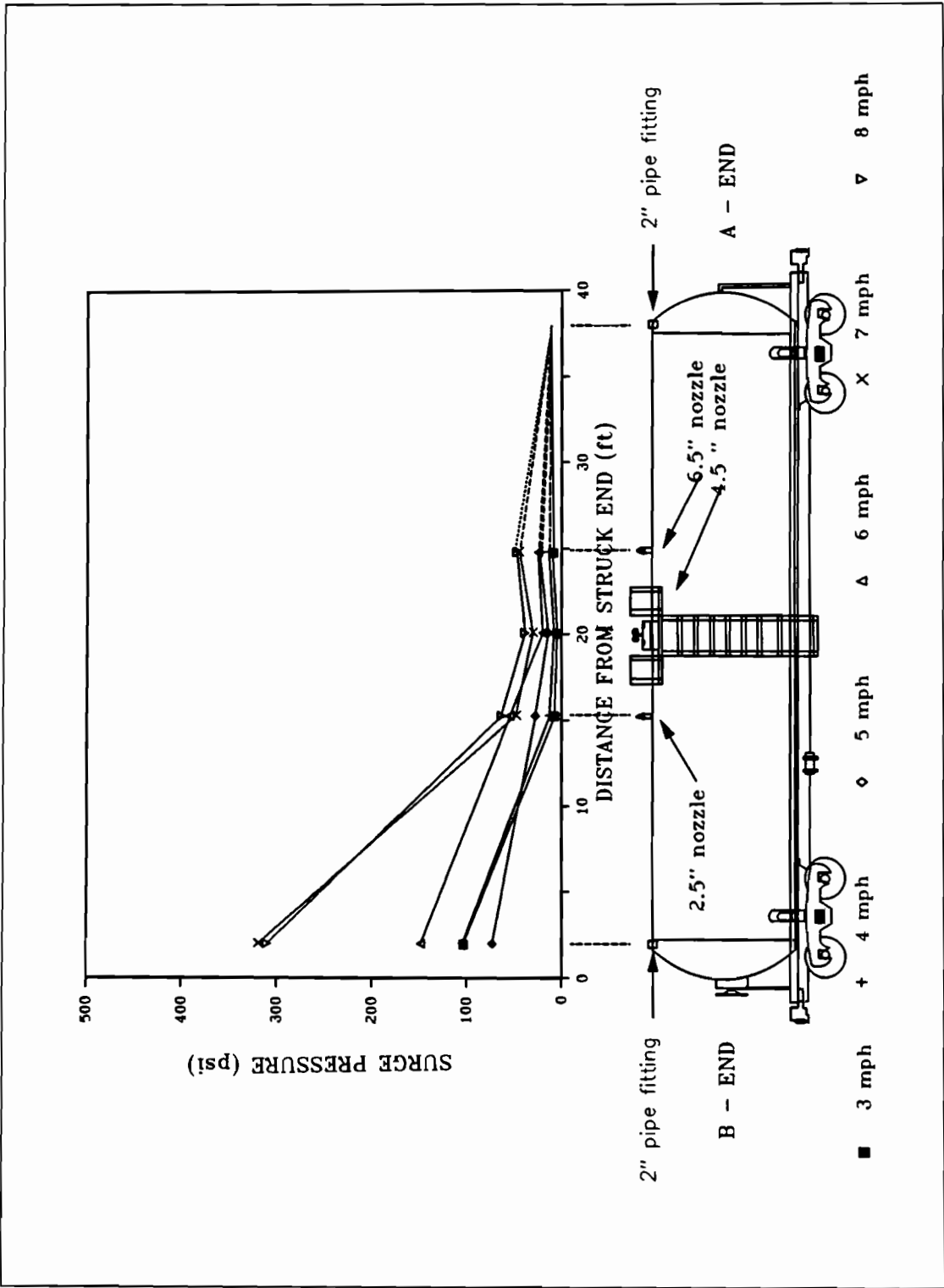

Figure 14. Surge Pressure vs Distance from Struck End & Impact Speed -- 1% Outage, B-end Impacted, Blind Flanges Installed

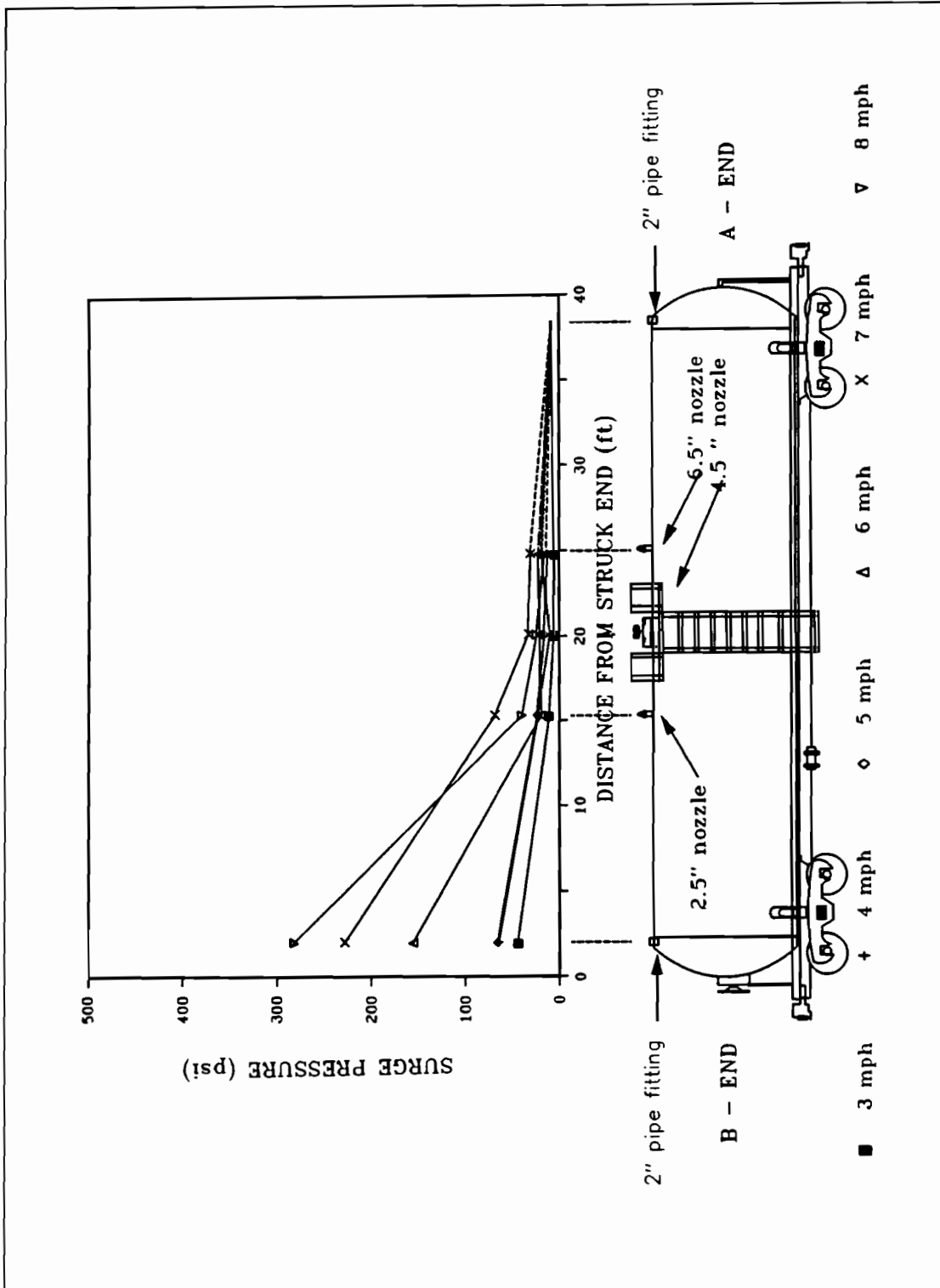

Figure 15. Surge Pressure vs Distance from Struck End & Impact Speed -- 2% Outage, B-end Impacted, Blind Flanges Installed

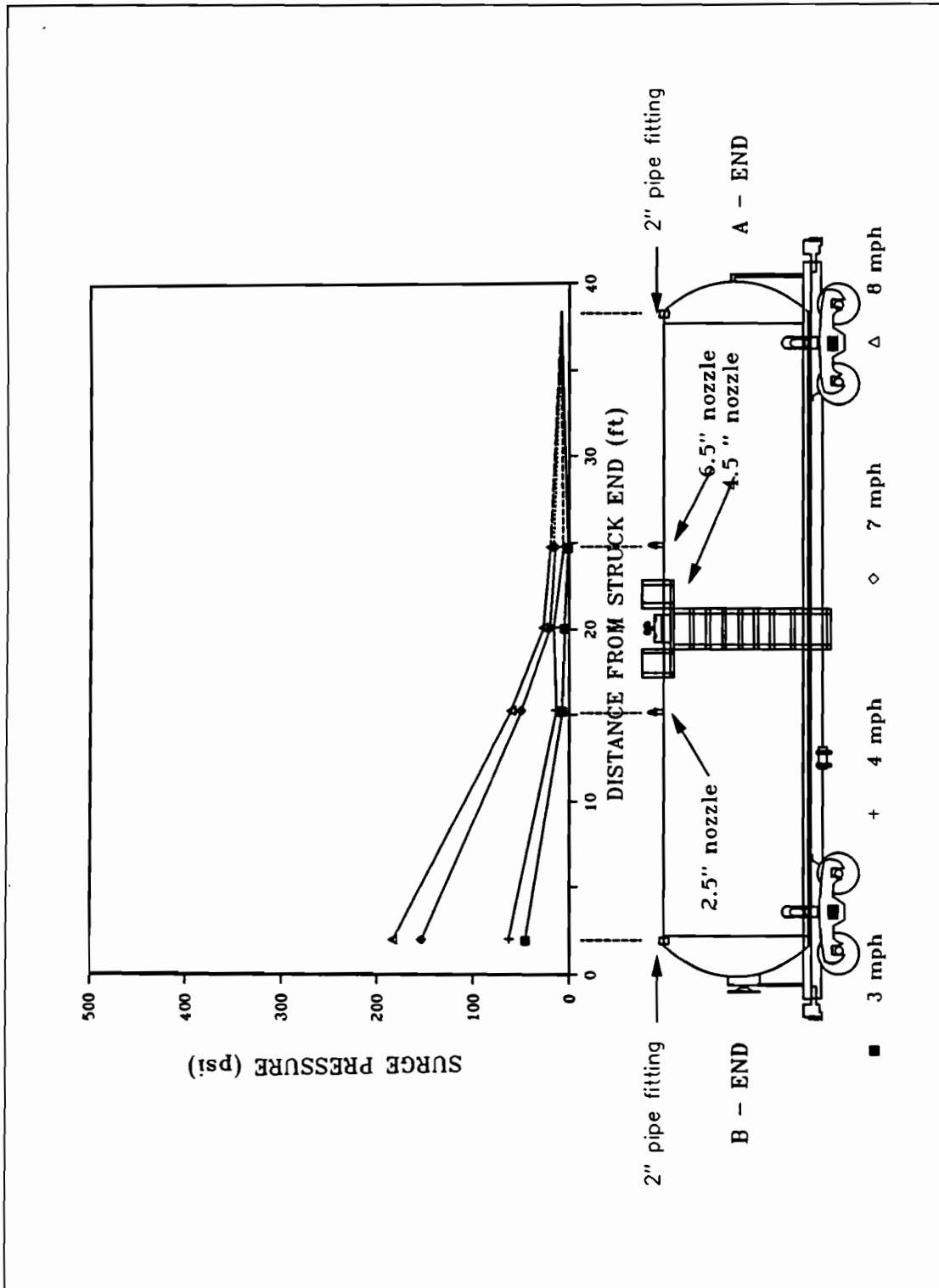

Figure 16. Surge Pressure vs Distance from Struck End & Impact Speed -- 4% Outage, B-end Impacted, Blind Flanges Installed

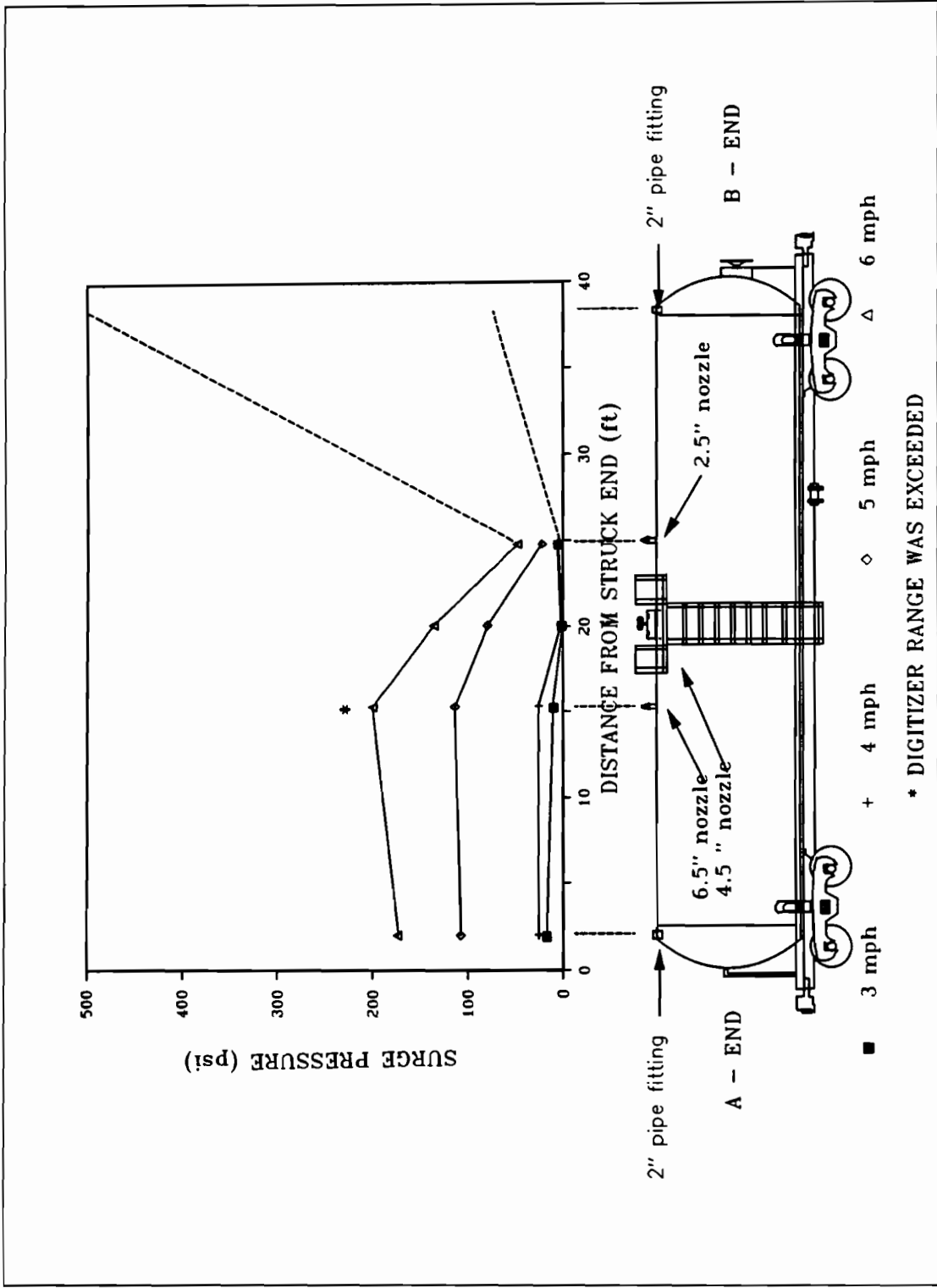

Figure 17. Surge Pressure vs Distance from Struck End & Impact Speed -- 0% Outage, A-end Impacted, Blind Flanges Installed

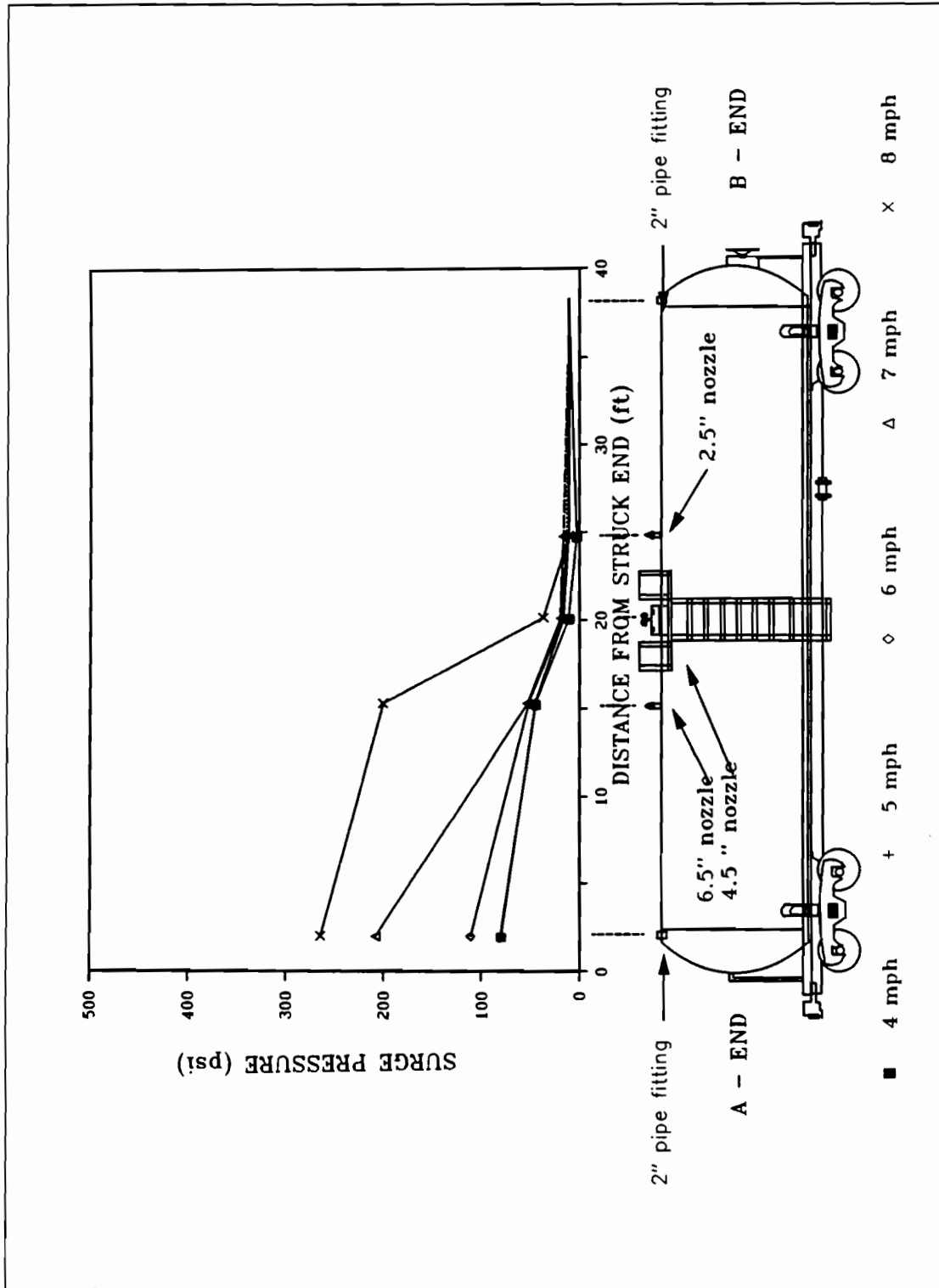

Figure 18. Surge Pressure vs Distance from Struck End & Impact Speed -- 2% Outage, A-end Impacted, Blind Flanges Installed

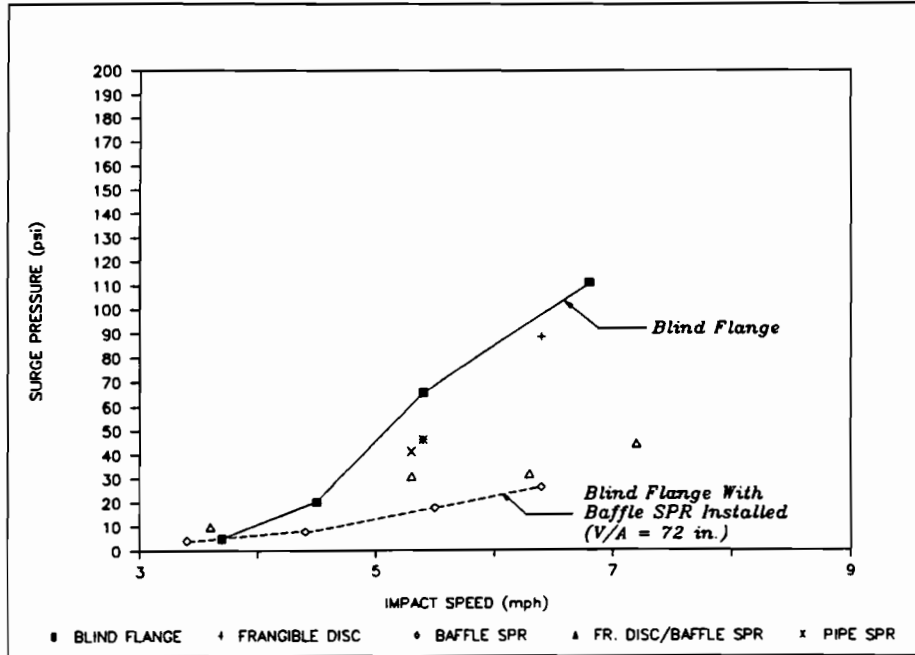

Figure 19. Surge Pressure in 2 1/2" Nozzle  
0% Outage, B-end Impacted

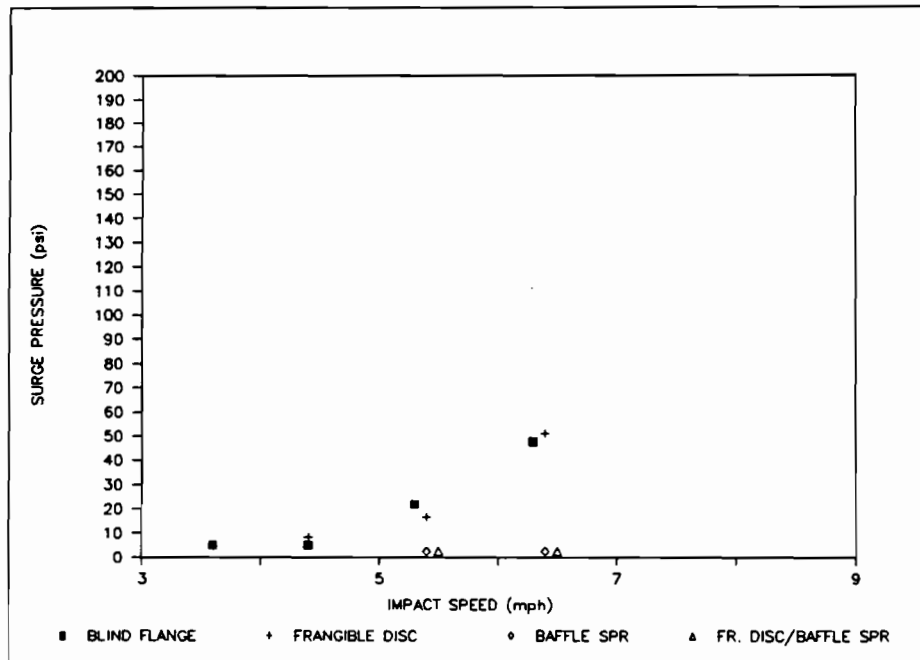

Figure 20. Surge Pressure in 2 1/2" Nozzle  
0% Outage, A-end Impacted



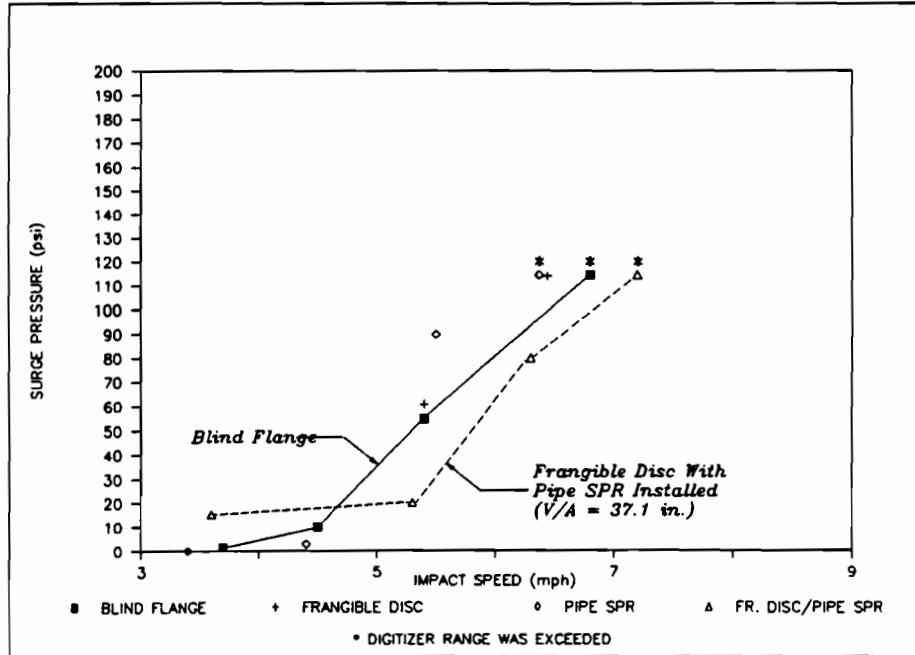

Figure 21. Surge Pressure in 4 1/2" Nozzle  
0% Outage, B-end Impacted

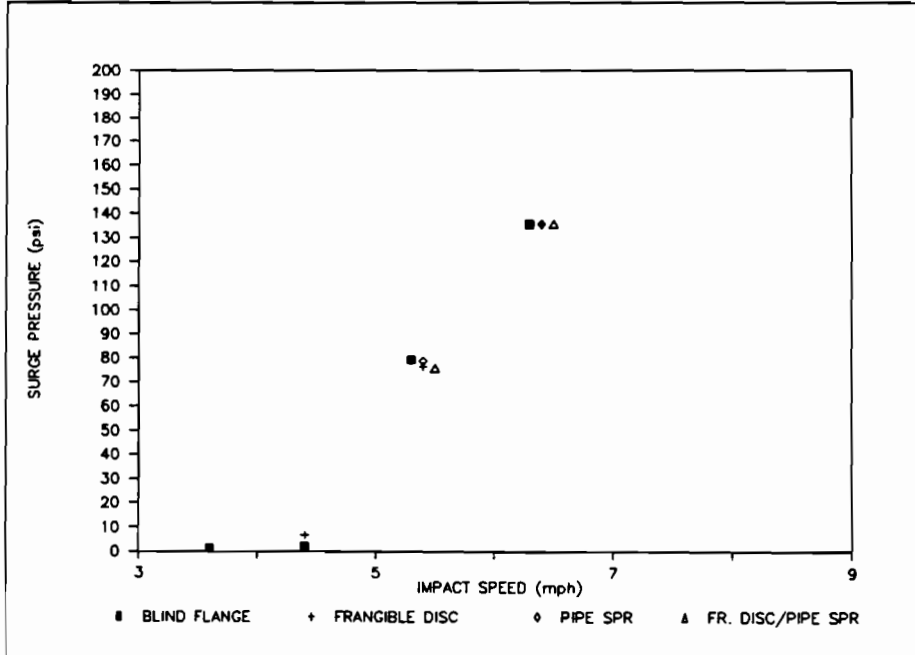

Figure 22. Surge Pressure in 4 1/2" Nozzle  
0% Outage, A-end Impacted

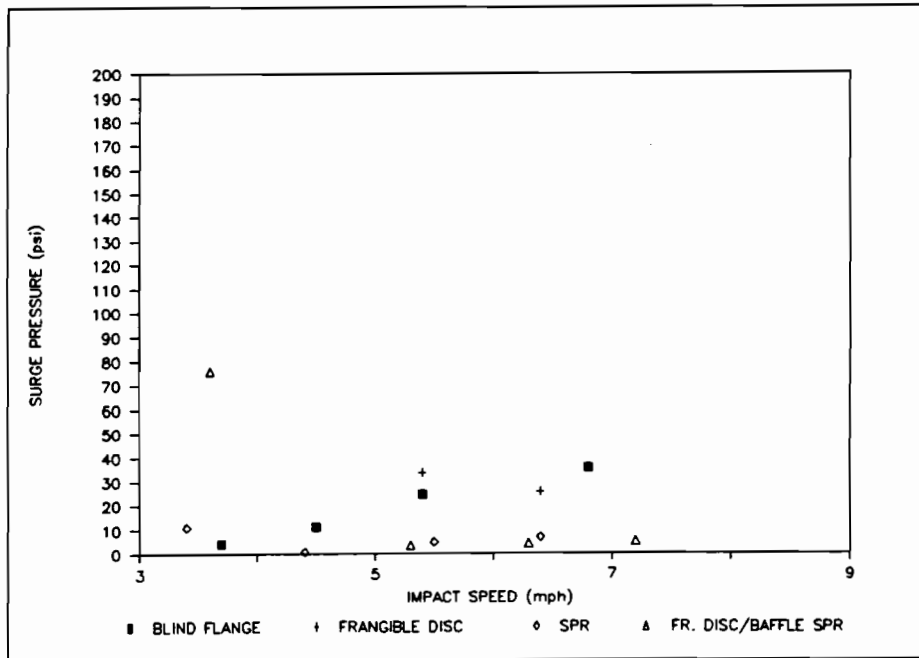

Figure 23. Surge Pressure in 6 1/2" Nozzle  
0% Outage, B-end Impacted

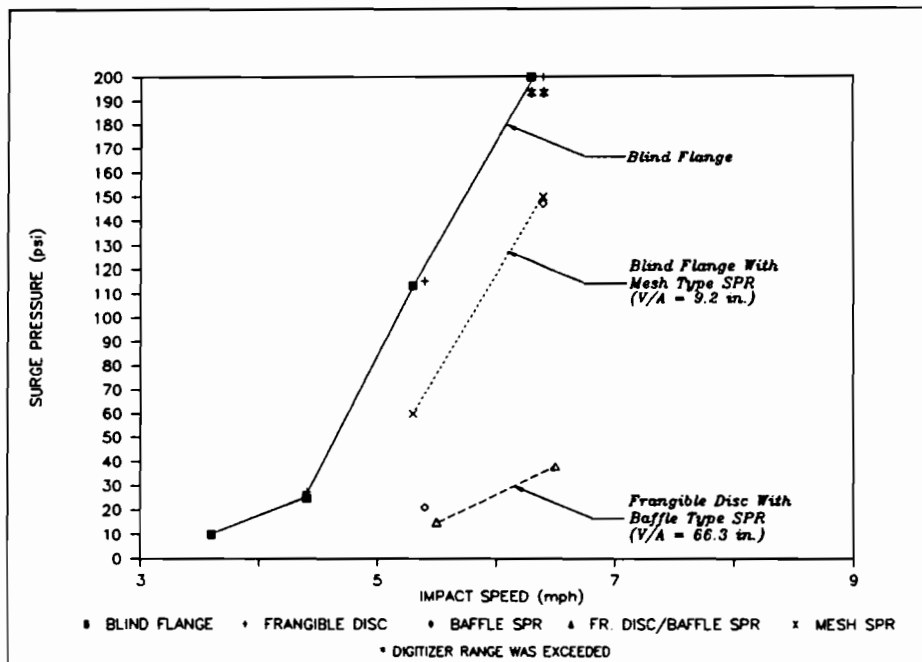

Figure 24. Surge Pressure in 6 1/2" Nozzle  
0% Outage, A-end Impacted

**TABLE 2.**  
**TEST CONDITIONS WHICH RESULTED IN THE RUPTURE OF 60 PSI DISCS.**

OUTAGE (%)	IMPACTED END	RUN NO.	SPEED (mph)	COUPLER FORCE (kips)	RUPTURED DISCS		
					2 1/2" Nozzle	4 1/2" Nozzle	6 1/2" Nozzle
0	B	9	5.4	888	X	X	
0	B	24	6.3	992	(Pipe SPR)	X	X
0	B	26	6.4	1047	X	X	X
1	B	42	8.3	1174	X		
4	B	63	8.2	1055	X		
0	A	73	5.4	814		X	X
0	A	74	6.4	1167	X	X	X
0	A	80	6.5	1206	(Baffle SPR)	X (Pipe SPR)	(Baffle SPR)
0	A	100	6.4	1037	(Blind Flange)	(Blind Flange)	X (Mesh SPR)

**TABLE 3.**  
**TEST CONDITIONS WHICH RESULTED IN THE RUPTURE OF 100 PSI DISCS.**

OUTAGE (%)	IMPACTED END	RUN NO.	SPEED (mph)	COUPLER FORCE (kips)	RUPTURED DISCS		
					(2 1/2" Nozzle)	(4 1/2" Nozzle)	(6 1/2" Nozzle)
0	B	91	6.3			X	
0	A	76	6.4	1143		X	X

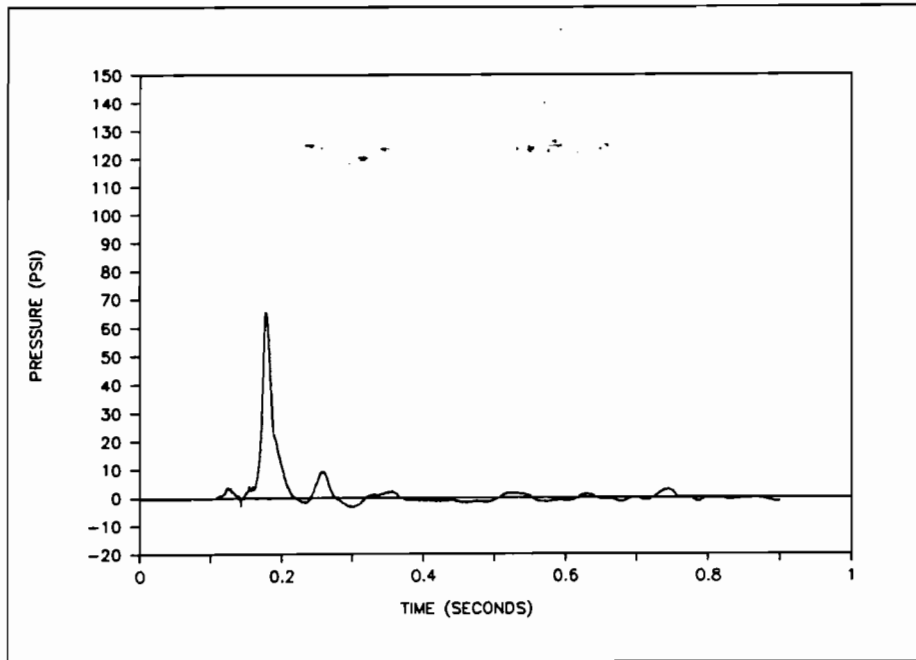

**Figure 25. Surge Pressure in 2 1/2" Nozzle without SPR, 0% Outage, B-end Impacted at 5 mph**

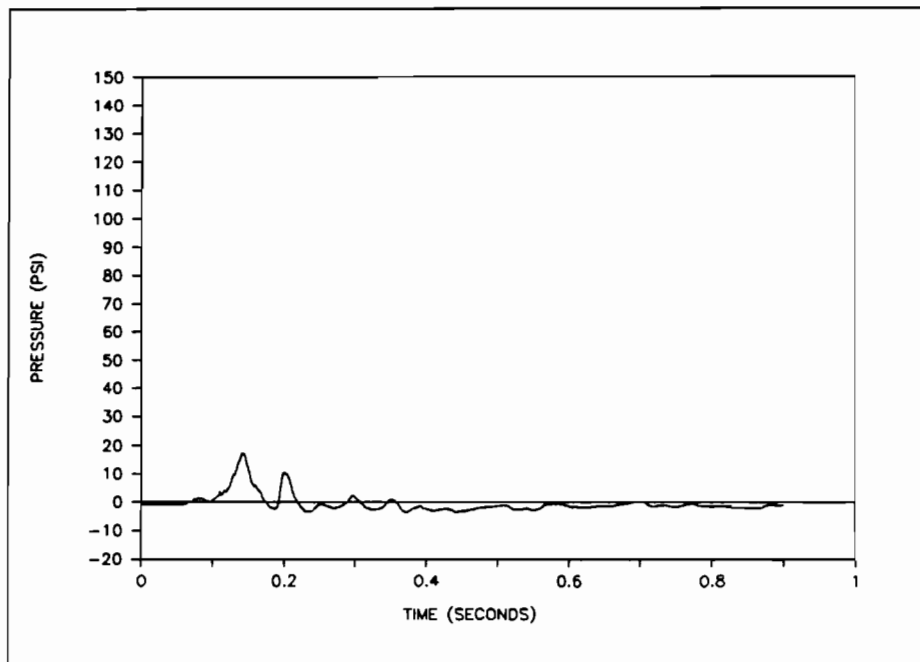

**Figure 26. Surge Pressure in 2 1/2" Nozzle with SPR, 0% Outage, B-end Impacted at 5 mph**

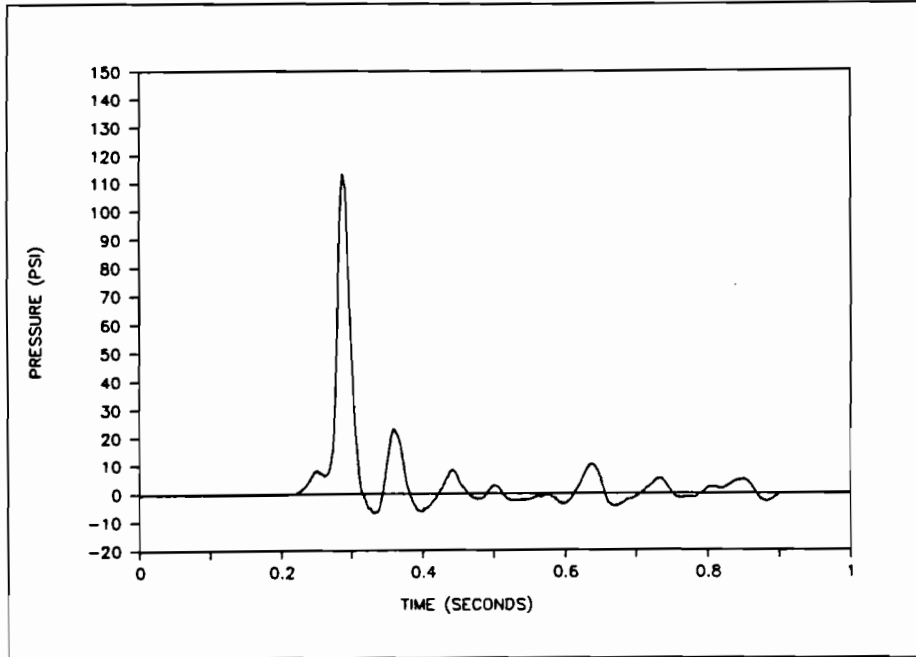

**Figure 27. Surge Pressure in 6 1/2" Nozzle without SPR, 0% Outage, A-end Impacted at 5 mph**

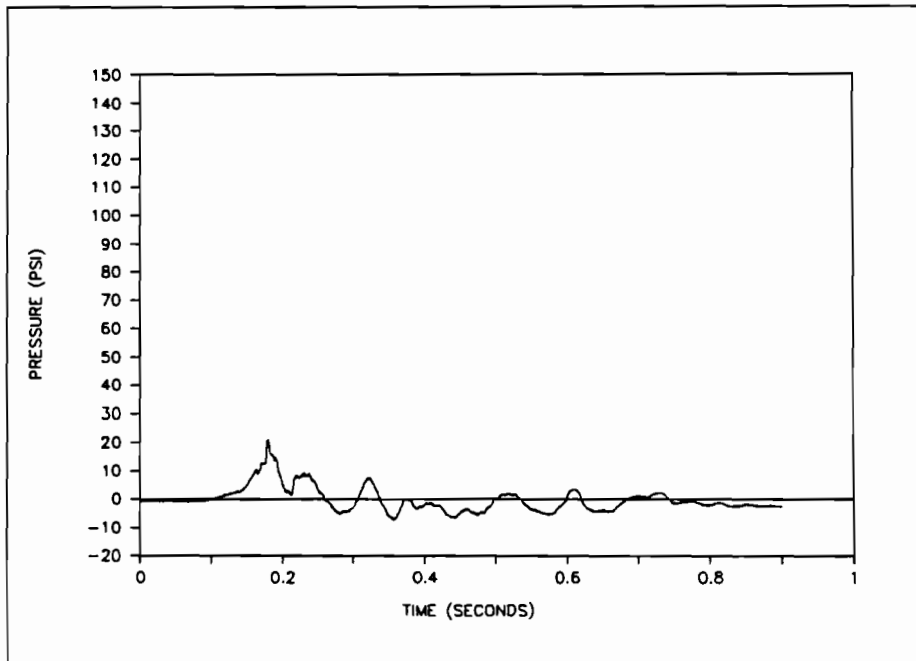

**Figure 28. Surge Pressure in 6 1/2" Nozzle with SPR, 0% Outage, A-end Impacted at 5 mph**

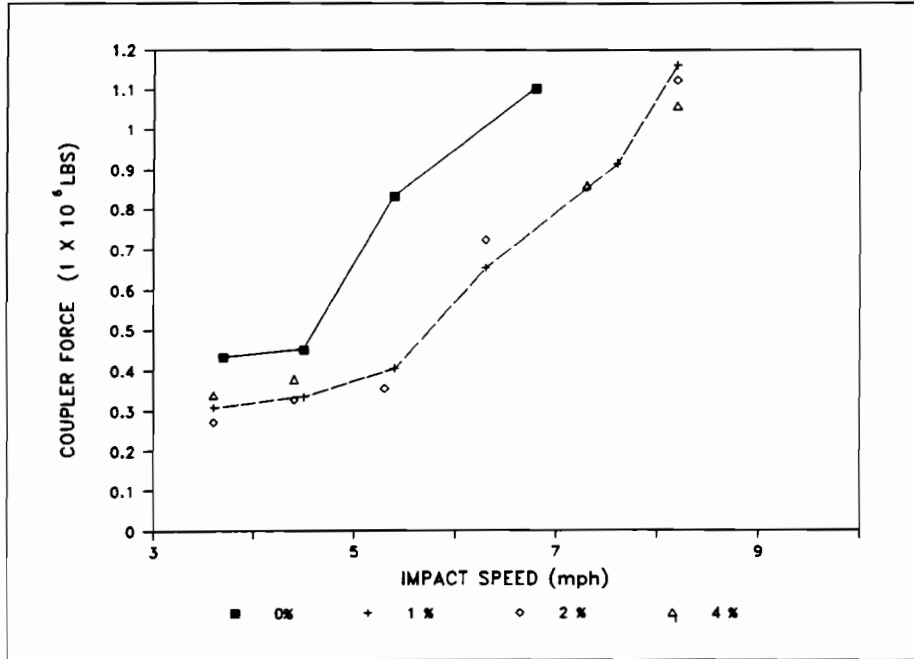

Figure 29. Coupler Force vs Impact Speed, 0% Outage, B-end Impacted

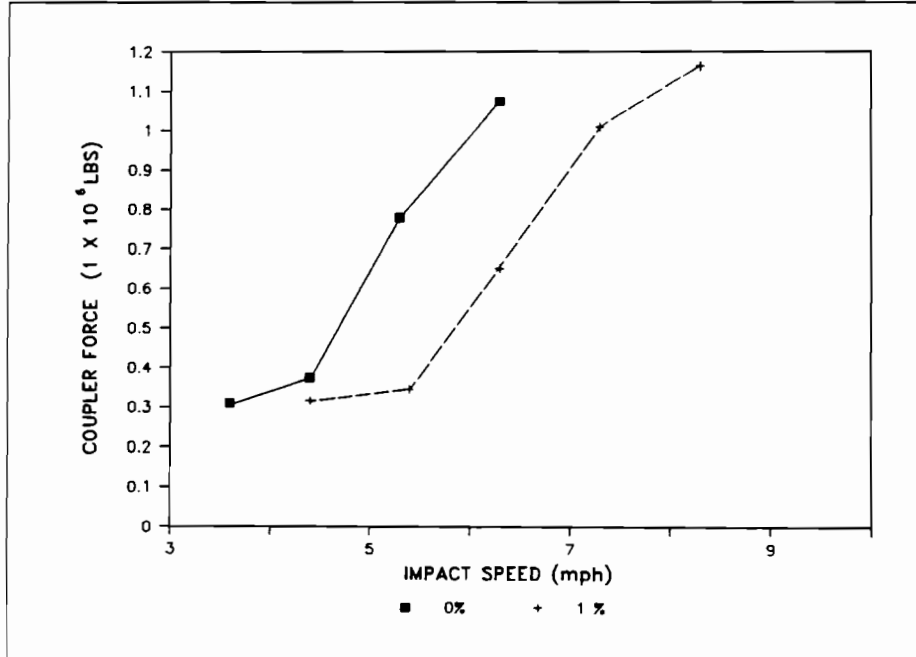

Figure 30. Coupler Force vs Impact Speed, 0% Outage, A-end Impacted

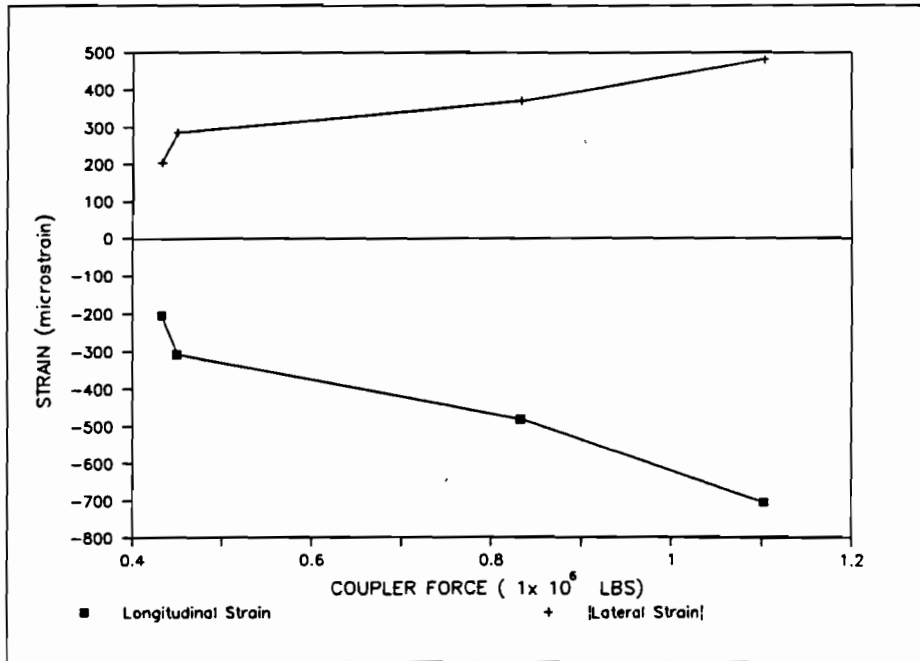

Figure 31. Longitudinal and Lateral Strains vs Coupler Force

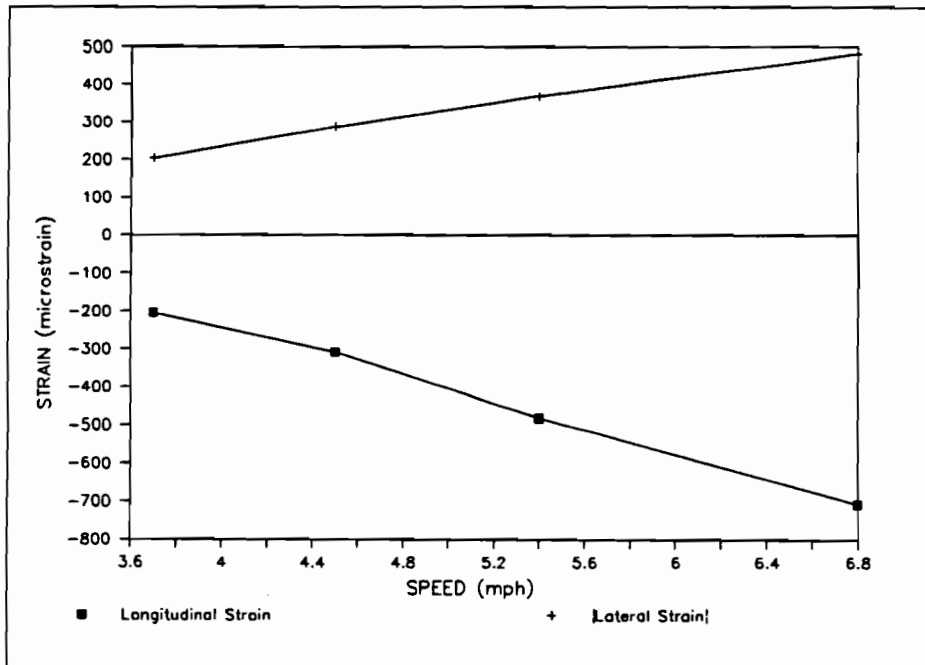

Figure 32. Longitudinal and Lateral Strains vs Impact Speed

## **8.0 DISCUSSION**

### **EFFECT OF FILLING TANK CAR TO 0 PERCENT OUTAGE**

The results confirm that over-filling a tank car will substantially increase safety vent nozzle surge pressures which occur during coupling impacts. Measurements of safety vent nozzle surge pressures and physical observation of frangible discs after coupling indicate that vent pressures caused by coupling exceed the design rating of 60 and 100 psi frangible discs when the test car was filled to a shell full condition. The coupler forces which ruptured the 60 and 100 psi discs were approximately 800 kips and 1100 kips respectively.

### **PRESSURE PROFILE WITHIN TANK CAR**

During a given impact, the largest surge pressures (on the order of 300 psi) were measured at the impacted end; lower pressures were measured with increased distance from the impacted end. An important exception to this is noted for the 0 percent outage condition for which the pressure profile described above was augmented with a sharp increase in pressure at the end of the tank opposite from the impacted end. During Test Series 3A, run 11, a very short duration (approximately 3 milliseconds) pressure pulse of at least 1500 psi was produced in the pipe fitting located on the A-end of the tank. This pressure pulse was sufficient to damage a pressure transducer that was rated for pressures up to 3000 psi (previously, a pressure transducer that was rated for 500 psi was destroyed during run 4 at the same location). It may be noted that the design burst pressure of the test car was 500 psi. It would be worthwhile to conduct additional tests with higher capacity pressure transducers to confirm this measurement.

Subsequent to test run 11, a second 3000 psi transducer (with a resolution of approximately 15 psi) was used to measure pressure surges occurring in the opposite end of the tank from the struck end for outages of 1 percent, 2 percent and 4 percent. For these conditions, no response was measured, indicating that the pressures were no greater than 15 psi.



**CONDITIONS LEADING TO DISC RUPTURE**

The minimum coupler forces and impact speeds which produced ruptured discs are summarized in Table 4.

**TABLE 4.  
CONDITIONS LEADING TO DISC RUPTURE.**

Outage	Speed (mph)	Coupler Force (kips)
0%	5.4	814
1%	8.3	1174
2%	No Rupture Observed	
4%	8.2	1055

Test results show that approximately 50 percent higher coupler forces are required to rupture the frangible discs at a lading outage of 1 percent as compared to 0 percent; a coupler force of 1174 kips is needed to rupture the frangible disc at a lading outage of 1 percent. It may be noted that, in six cases where discs were ruptured, the measured vent pressure was less than the design burst pressure (60 psi) of the affected discs. It is thought that there was a pressure differential between the pressure transducer location (on the side of the 2 1/2 inch and 6 1/2 inch safety vent nozzles) and the location of the frangible disc (on top of the safety vent, which is attached to the top of the safety vent nozzle). Since the pressure transducer diaphragm was mounted tangential to the direction of travel of a given pressure pulse (assumed to be along the length of the vent), the measured pressure may have been lower than the pressure developed at the face of the frangible disc (which was oriented perpendicular to the direction of the pressure pulse). A complicating factor is that the safety vent itself contains an orifice which would tend to produce a pressure drop between the safety vent and the frangible disc. For these reasons, it would be desirable in future tests to construct a fixture

to hold the pressure transducer diaphragm flush with the surface where the frangible disc would normally be placed. This would ensure that the measured pressure pulse is the pulse which actually impinges on the frangible disc.

#### EFFECTIVENESS OF INSTALLED SPR'S

Examination of Figures 25 - 28 and Appendix B reveals that installation of the baffle type SPR'S in the 2 1/2 inch and 6 1/2 inch safety vent nozzles effectively lowered the safety vent surge pressures and prevented disc ruptures during coupling impacts. The pipe type SPR (installed in the 2 1/2 inch safety vent nozzle) and the mesh type SPR (installed in the 6 1/2 inch safety vent nozzle) also lowered peak vent pressures, albeit to a lesser extent. Figure 33 shows the percentage reduction in nozzle surge pressure which was measured after installation of the above four SPR's. The values shown are for a test condition of 0 percent outage and 5 mph impact speed. Values shown for the 2 1/2 inch safety vent nozzle were measured during tests in which the B-end (the end closest to the nozzle) was impacted; values shown for the 6 1/2 inch safety vent nozzle were measured during tests in which the A-end was impacted. Although the 2 1/2 inch pipe type SPR and the 6 1/2 inch mesh type SPR produced less of a reduction in surge pressure than the two baffle type SPR's, the former two designs were still effective in that they prevented the rupture of 60 psi composite discs for test conditions of 0 percent and 5 mph impact speed (see Appendix B, Test Series 2A, 4A, 2E, and 4E). In addition, although the 4 1/2 inch pipe type SPR did not appear to reduce measured surge pressures, it did prevent the rupture of 100 psi discs for those same test conditions. By adjusting the dimensions of the mesh and pipe type SPR's, it should be possible to achieve a larger reduction in surge pressures. Thus, any of the general SPR types could be used to prevent the rupture of 60 psi discs during coupling impacts.

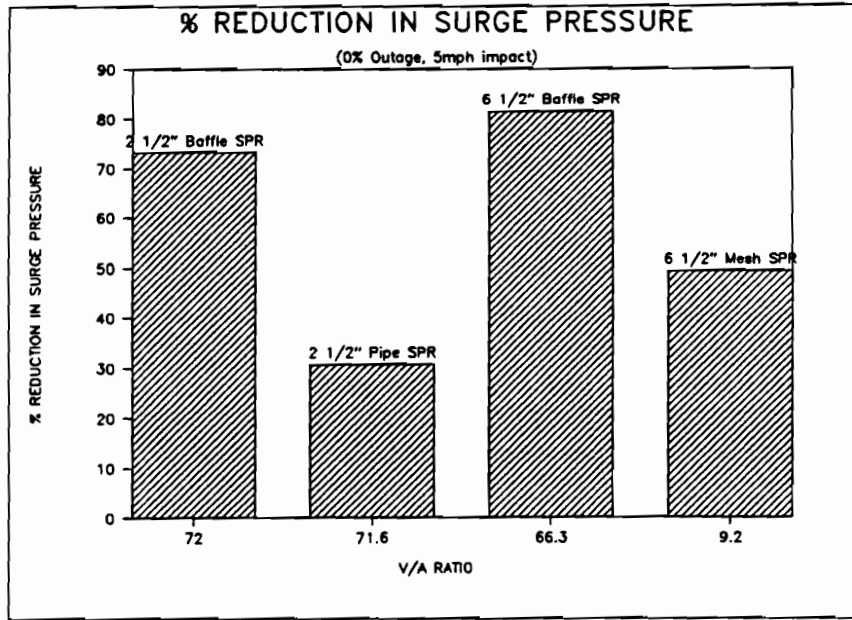

Figure 33. Percent Reduction in Surge Pressure For Four SPR Designs (0% Outage, 5 mph Impact Speed)

**COUPLER FORCE VS SPEED**

Examination of Figures 29 and 30 reveals that, for impact speeds between 5 and 7 mph, substantially higher coupler forces were developed for a lading outage of 0 percent as compared to coupler forces developed for outages of 1 percent, 2 percent, and 4 percent. Furthermore, there was little difference between coupler forces for outages of 1 percent, 2 percent, and 4 percent. It is also seen that, for lower impact speeds (3 mph) and higher impact speeds (8 mph), the coupler forces for different outages converge to the same value.

**ROSETTE STRAIN VS COUPLER FORCE AND IMPACT SPEED**

Longitudinal and lateral strains measured on the tank shell near the B-end of the test car (rosette #1) were approximately proportional to coupler force and impact speed (see Figures 31 and 32). A coupler force of 1100 kips produced a longitudinal strain of  $-700 \times 10^{-6}$ . This is close to the value of  $-748 \times 10^{-6}$  computed from strength of materials for a beam subjected to a combined end load and bending.

## 9.0 CONCLUSIONS

A series of impact tests were performed to characterize the internal pressures which occur in a filled, non-pressure tank car during a coupling impact.

Analysis of the test data leads to the following conclusions:

- When loaded to a shell-full condition, a tank car of the design tested will develop safety vent nozzle surge pressures sufficient to rupture 60 and 100 psi frangible discs during impacts which produce coupler forces of 800 kips and 1100 kips, respectively.
- For outages of 1 percent and higher, the highest measured impact surge pressure (approximately 300 psi) occurs at the top of the tank at the struck end of the car.
- For an outage of 0 percent, the highest measured impact surge pressure (approximately 1500 psi) occurs at the opposite end of the tank from the struck end of the car.
- A large decrease in safety vent surge pressures results when outage is changed from 0 percent to 1 percent.
- For impact speeds between 5 and 7 mph, substantially higher coupler forces are developed for a tank car loaded to a shell-full condition as compared to a 1 percent outage condition.
- When installed, two baffle-type safety vent nozzle SPR's effectively reduced surge pressures acting on frangible discs installed in 2 1/2 inch and 6 1/2 inch diameter nozzle safety vents. The SPR's prevented the discs from rupturing during coupling impacts involving forces up to 1200 kips.

- Each of the SPR designs tested provided some degree of protection from disc rupture. It is likely that, once suitable alterations are made to the dimensions of each design, any of the general designs could be successfully used to prevent frangible discs from rupturing during coupling impacts.

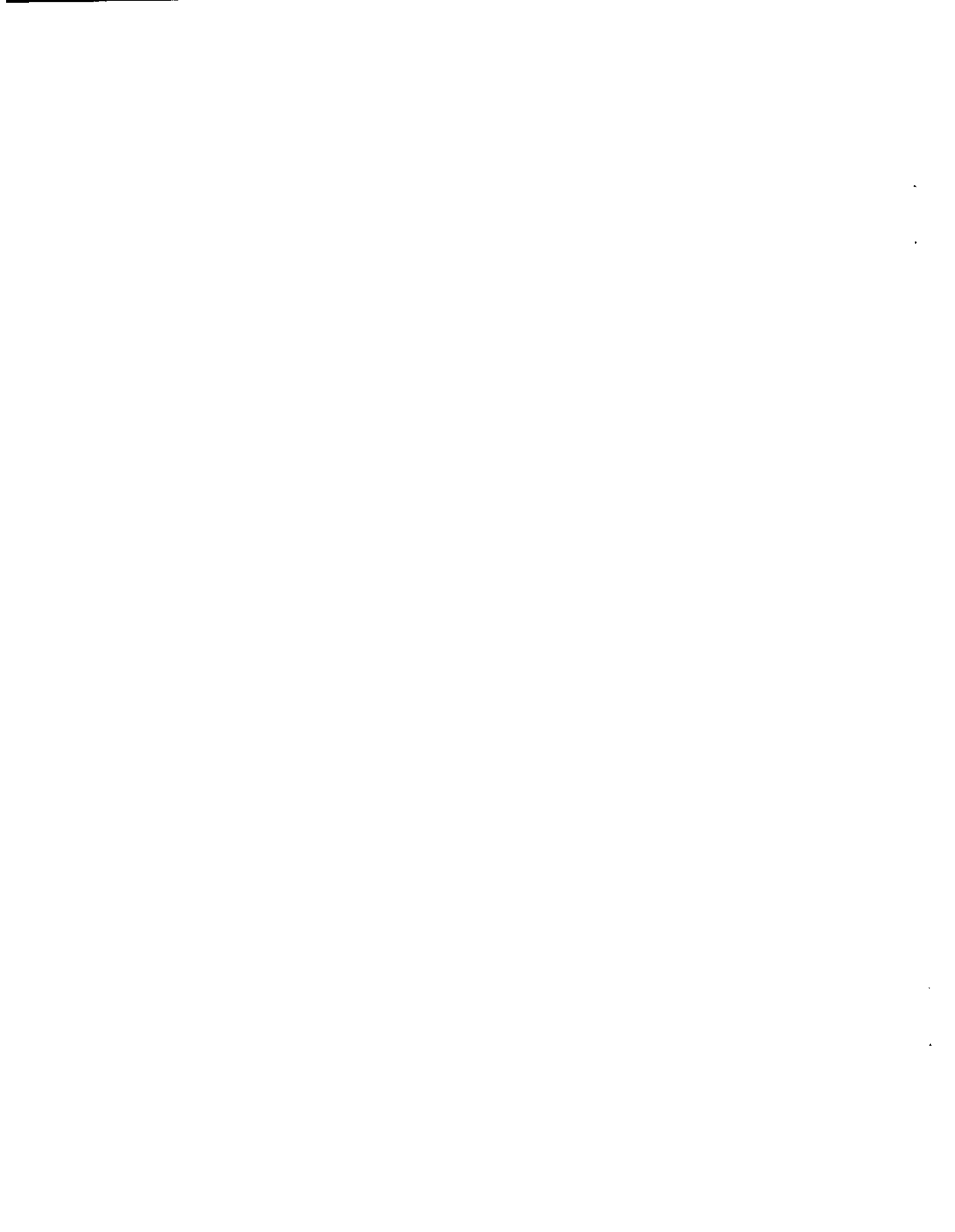

**APPENDIX A**

**SAFETY VENT NOZZLE AND SURGE  
PRESSURE REDUCER DIMENSIONS**





DIMENSIONS OF 2 1/2" SAFETY VENT NOZZLE WITH  
BAFFLE TYPE SURGE PRESSURE REDUCER

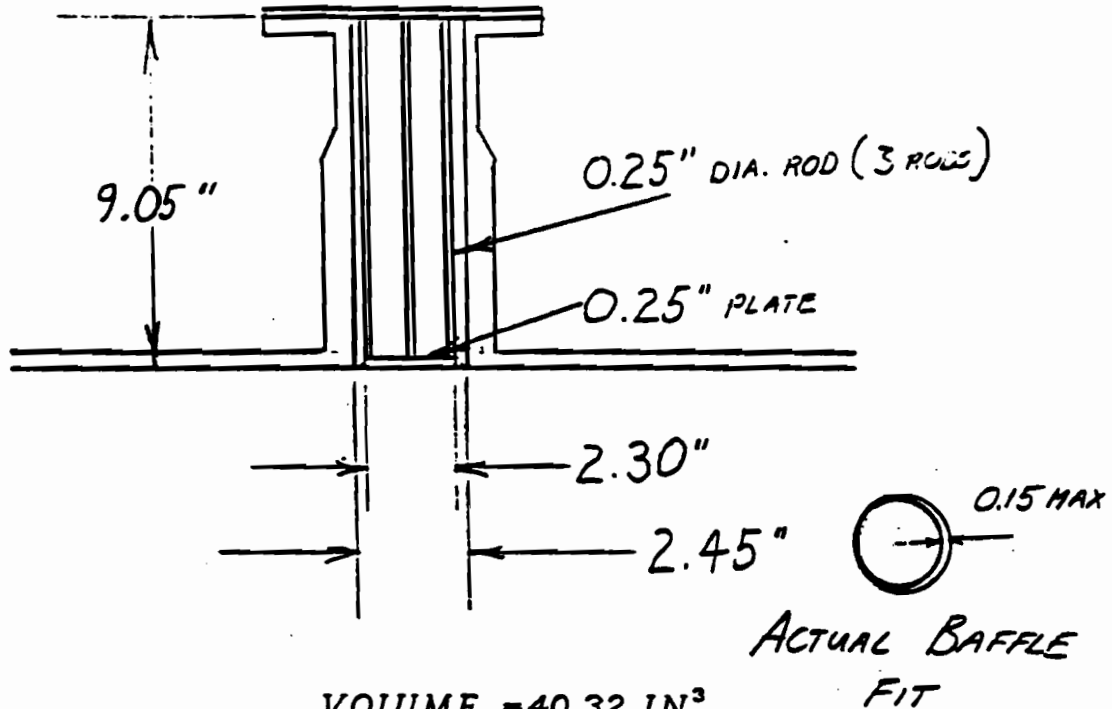

DIMENSIONS OF 2 1/2" SAFETY VENT NOZZLE WITH  
PIPE TYPE SURGE PRESSURE REDUCER

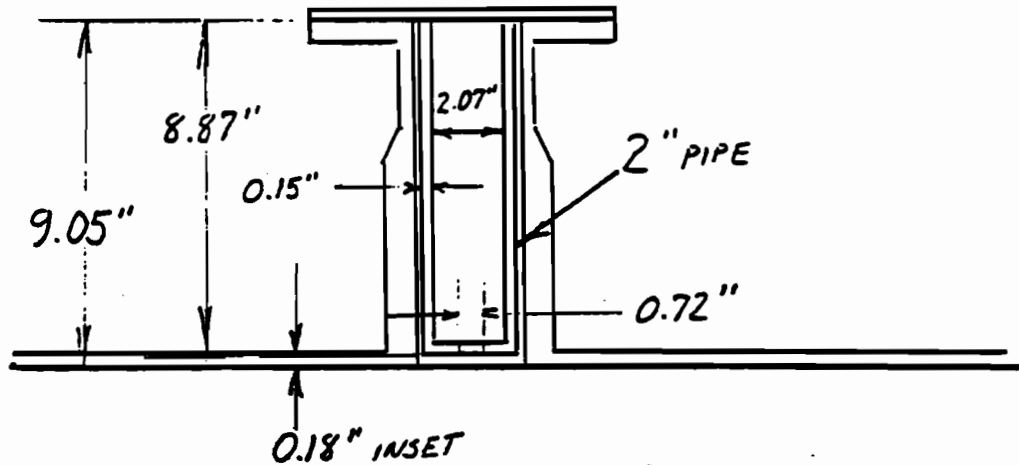

VOLUME = 29.35 IN<sup>3</sup>

ORIFICE AREA = .41 IN<sup>2</sup>

V/A RATIO = 71.6 IN

DIMENSIONS OF 4 1/2" SAFETY VENT NOZZLE WITH  
PIPE TYPE SURGE PRESSURE REDUCER

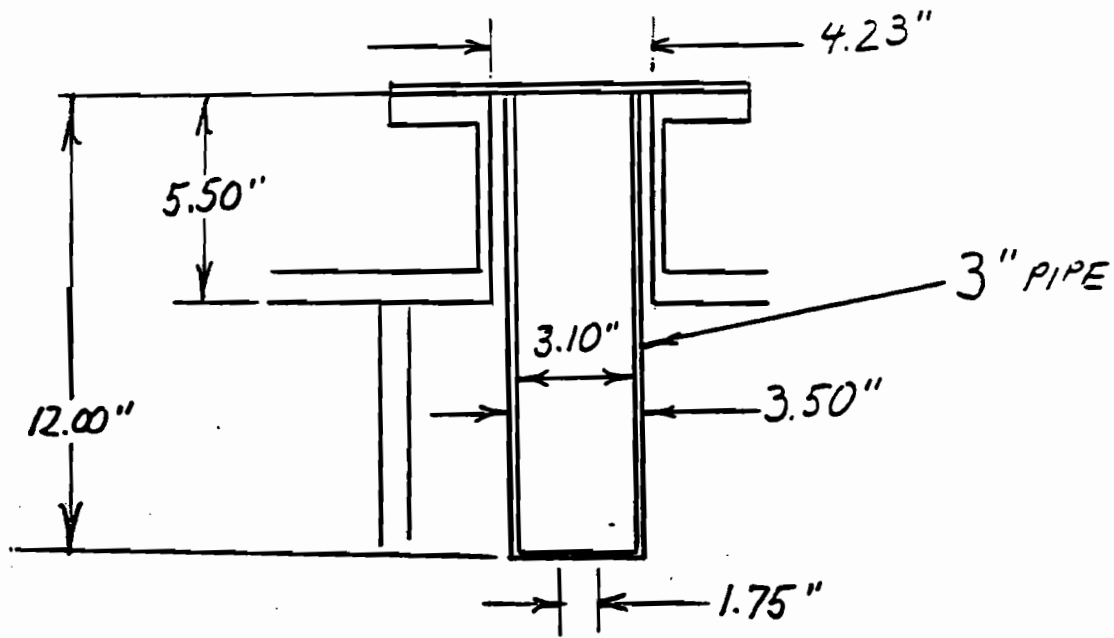

VOLUME = 89.06 IN<sup>3</sup>

ORIFICE AREA = 2.40 IN<sup>2</sup>

V/A RATIO = 37.1 IN

DIMENSIONS OF 6 1/2" SAFETY VENT NOZZLE WITH  
BAFFLE TYPE SURGE PRESSURE REDUCER

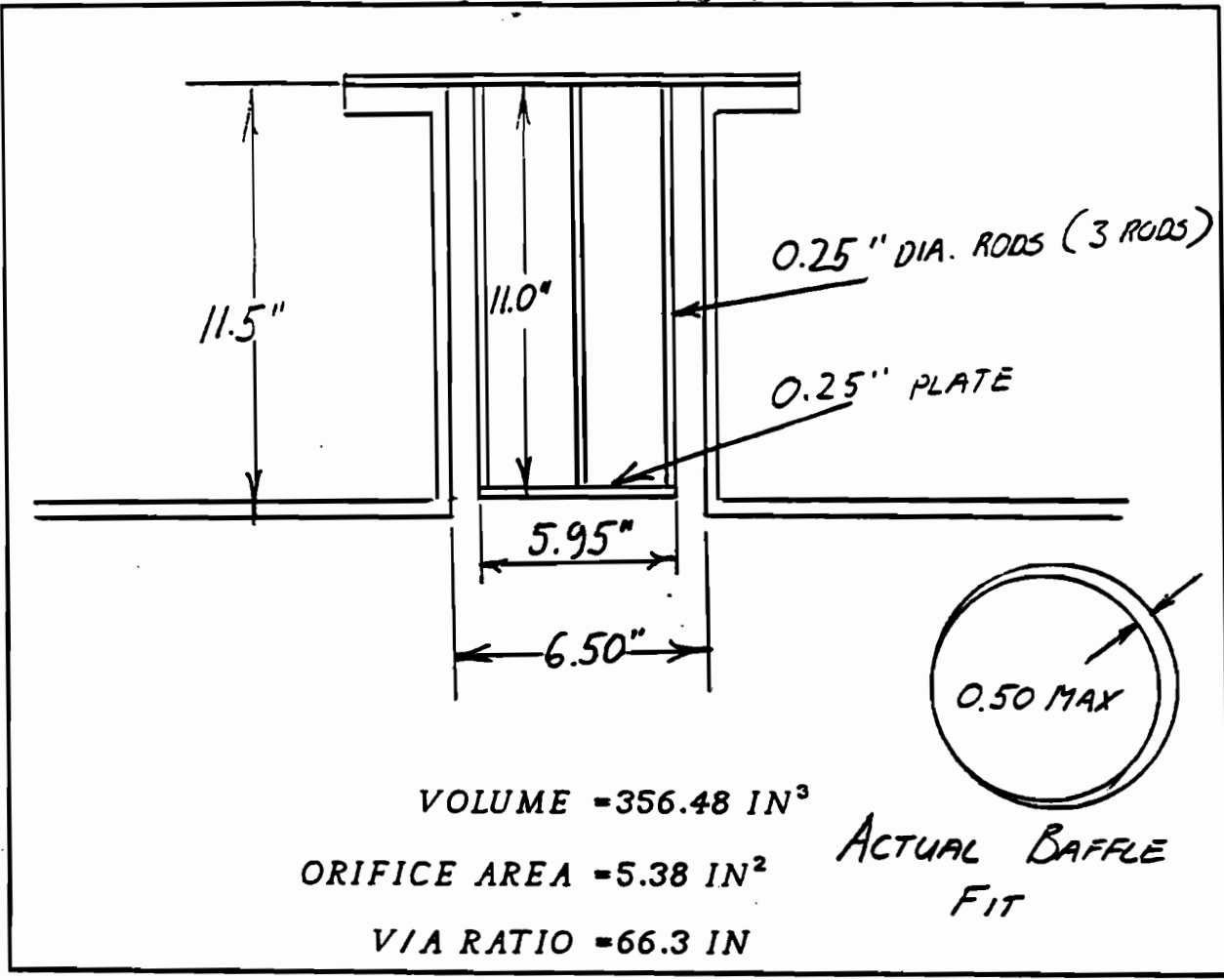

DIMENSIONS OF 6 1/2" SAFETY VENT NOZZLE WITH  
MESH TYPE SURGE PRESSURE REDUCER

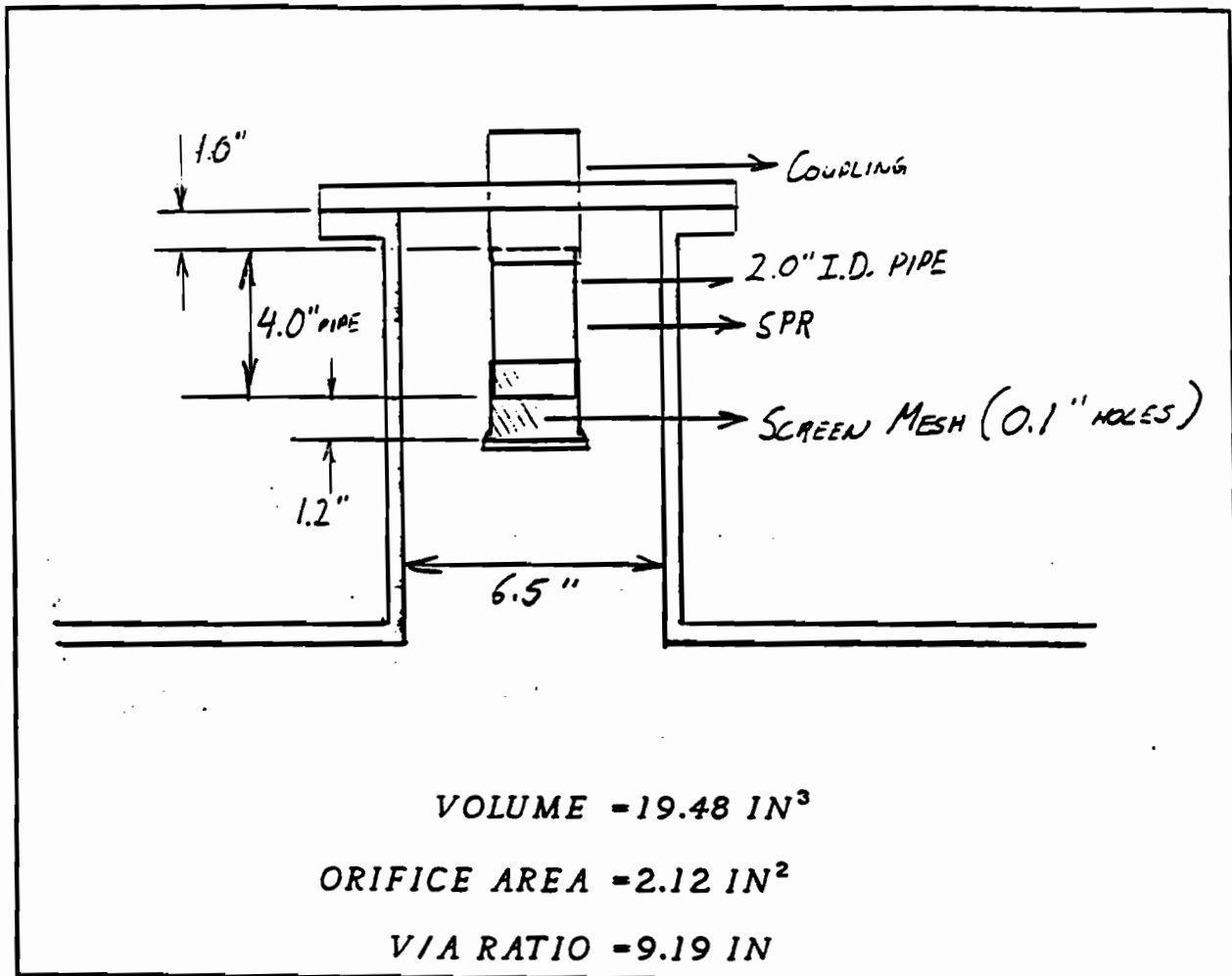



**APPENDIX B**

**IMPACT TEST DATA  
SAFETY VENT NOZZLE SURGE PRESSURES  
AND COUPLER FORCES MEASURED  
DURING TEST SERIES 1A - 4F**





TEST SERIES: 1A OUTAGE: 0% IMPACTED END: B-END

TEST #	IMPACT SPEED (mph)	COUPLER FORCE (kips)	2" B-END		PEAK SURGE PRESSURE (psi)				2" A-END	
			PIPE FITTING	PIPE FITTING	2 1/2" NOZZLE	4 1/2" NOZZLE	6 1/2" NOZZLE	PIPE FITTING		
			SIDE	TOP	SIDE	TOP	SIDE	TOP	SIDE	TOP
1	3.7	433	29.5	4.8	1.6	4.0	4.0	70.4		
2	3.7	381	19.3	4.6	2.0	3.1	3.1	67.1		
3	3.8	363	21.9	7.1	1.0	4.0	4.0	187.2		
4	6.8	1103	159.2	109.1	114.1	35.4	35.4	>500		
5	4.5	450	25.0	20.0	10.0	11.0	11.0			
6	4.5	450	40.0	16.0	8.0	8.0	8.0			
7	5.4	833	94.8	65.4	54.7	24.4	24.4			
8	5.4	888	127.9	75.6	65.7	37.3	37.3			
27	5.3	699	106.7	46.3	18.7	18.1	18.1			
28	5.4	751	108.6	39.5	18.7	18.2	18.2			
29	5.4	751	104.5	41.3	18.2	14.9	14.9			
30	5.4	750	100.0	52.0	19.0	12.0	12.0			
31	5.4	706	98.6	41.5	20.4	12.6	12.6			

(Test Car Coupled to Backup Cars Before Run #8 Impact)

TEST SERIES: 2A    OUTAGE: 0%    IMPACTED END: B-END    DISK TYPE/ PHYSICAL CONDITION ----  
 A60 - Stainless Steel Rated for 60 psi  
 B100 - Composite Disk Rated for 100 psi  
 R - Indicates Disc Ruptured During Test

TEST #	IMPACT SPEED (mph)	COUPLER FORCE (kips)	2" B-END		PEAK SURGE PRESSURE (psi)						2" A-END PIPE FITTING	
			PIPE FITTING	COUPLER	2 1/2" NOZZLE	4 1/2" NOZZLE	6 1/2" NOZZLE	SIDE		TOP		
9	5.4	888	99.9	45.8 (A60)(R)	60.6 (A60)(R)	33.5 (A60)						
10	5.5	843	100.3	70.5 (Open Vent)	46.1 (Open Vent)	10.9 (A60)						
25	5.4	810	100.0	60.0 (B60)	50.0 (B60)	10.0 (B60)						
26	6.4	1047	297.6	88.0 (B60)(R)	113.6 (B60)(R)	25.3 (B60)(R)						
90	5.3	--	110.4	24.6 (B100)	97.6 (B100)	69.3 (B100)						--
91	6.3		136.5	34.6 (B100)	115.5 (B100)(R)	59.4 (B100)						

TEST SERIES: 3A OUTAGE: 0X IMPACTED END: B-END

TEST #	IMPACT SPEED (mph)	COUPLER FORCE (kips)	2" B-END		PEAK SURGE PRESSURE (psi)						2" A-END PIPE FITTING	
			PIPE	FITTING	2 1/2" NOZZLE	4 1/2" NOZZLE	6 1/2" NOZZLE	SIDE	TOP	SIDE		TOP
11	5.5	833			17.5 (Baffle SPR)		106.5 (Pipe SPR)	89.6	4.5 (Baffle SPR)			1500.0
12	6.4	1134			26.0 (Baffle SPR)		422.9 (Pipe SPR)	114.1	6.5 (Baffle SPR)			2700.0
13	3.4	300			4.0 (Baffle SPR)		0.0 (Pipe SPR)	0.0	11.0 (Baffle SPR)			
14	3.6	331			4.7 (Baffle SPR)		0.0 (Pipe SPR)	0.0	4.6 (Baffle SPR)			
15	4.4	463			7.8 (Baffle SPR)		0.0 (Pipe SPR)	2.8	0.6 (Baffle SPR)			
21	5.4	705			45.4 (Pipe SPR)		18.8	45.9	9.7			
22	5.3	760			48.8 (Pipe SPR)		20.6	41.0	15.7			

TEST SERIES: 4A    OUTAGE: 0%    IMPACTED END: B-END    DISK TYPE/ PHYSICAL CONDITION ---  
 A60 - Stainless Steel Rated for 60 psi  
 B100 - Composite Disk Rated for 100 psi  
 R - Indicates Disc Ruptured During Test

TEST #	IMPACT SPEED (mph)	COUPLER FORCE (kips)	2" B-END PIPE FITTING	←-----PEAK SURGE PRESSURE (psi)----->						2" A-END PIPE FITTING
				2 1/2" NOZZLE		4 1/2" NOZZLE		6 1/2" NOZZLE		
				SIDE	TOP	SIDE	TOP	SIDE	TOP	
16	3.6	415	45.4	9.9 (B60) (Baffle SPR)		15.3 (B60) (Pipe SPR)		75.8 (B60) (Baffle SPR)		
17    4.4 ALL DATA AFFECTED BY NOISE										
18	5.3	751	90.6	30.5 (B60) (Baffle SPR)		20.0 (B60) (Pipe SPR)		3.4 (B60) (Baffle SPR)		
19	6.3	993	268.8	31.5 (B60) (Baffle SPR)		79.5 (B60) (Pipe SPR)		4.0 (B60) (Baffle SPR)		
20	7.2	1179	460.7	44.1 (B60) (Baffle SPR)		>114 (B60) (Pipe SPR)		4.8 (B60) (Baffle SPR)		
23	5.3	751	93.5	54.5 (B60) (Pipe SPR)		17.1 (B60)		9.3 (B60)		
24	6.3	992	320.1	103.1 (B60) (Pipe SPR)		98.9 (B60)(R)		35.2 (B60)(R)		

TEST SERIES: 1B OUTAGE: 1X IMPACTED END: B-END

TEST #	IMPACT SPEED (mph)	COUPLER FORCE (kips)	2" B-END PIPE FITTING	←-----PEAK SURGE PRESSURE (psi)----->						2" A-END PIPE FITTING
				2 1/2" NOZZLE SIDE	2 1/2" NOZZLE TOP	4 1/2" NOZZLE SIDE	4 1/2" NOZZLE TOP	6 1/2" NOZZLE SIDE	6 1/2" NOZZLE TOP	
32	3.6	309	103.3	7.4		4.9		8.9		
33	4.5	334	103.8	12.1		7.9		12.5		
34	5.4	404	73.2	27.6		14.0		22.9		
35	5.4	396	96.7	23.2		13.3		19.0		
36	5.4	404	92.3	23.4		13.1		20.4		
37	6.3	653	148.2	54.2		19.6		24.3		
38	7.6	914	318.6	47.2		29.2		43.5		
39	8.2	1162	310.3	63.6		38.8		46.5		

TEST SERIES: 28 OUTAGE: 1% IMPACTED END: B-END

DISK TYPE/ PHYSICAL CONDITION ----

A60 - Stainless Steel Rated for 60 psi  
 B100 - Composite Disk Rated for 100 psi  
 R - Indicates Disc Ruptured During Test

TEST #	IMPACT SPEED (mph)	COUPLER FORCE (kips)	2" B-END PIPE FITTING	-----PEAK SURGE PRESSURE (psi)----->						
				2 1/2" NOZZLE		4 1/2" NOZZLE		6 1/2" NOZZLE		2" A-END PIPE FITTING
				SIDE	TOP	SIDE	TOP	SIDE	TOP	
40	6.4	751	131.8	36.9 (B60)		20.5 (B60)		33.6 (B60)		
41	7.3	1033	242.9	46.9 (B60)		27.8 (B60)		39.8 (B60)		
42	8.3	1174	370.6	40.0 (B60)(R)		40.4 (B60)		40.0 (B60)		
92	8.3		315.7	40.5 (B100)		39.8 (B100)		103.4 (B100)		

TEST SERIES: 38 OUTAGE: 1% IMPACTED END: B-END

TEST #	IMPACT SPEED (mph)	COUPLER FORCE (kips)	2" B-END		PEAK SURGE PRESSURE (psf)						2" A-END	
			PIPE FITTING	PIPE FITTING	2 1/2" NOZZLE	4 1/2" NOZZLE	6 1/2" NOZZLE	PIPE FITTING	PIPE FITTING			
			SIDE	TOP	SIDE	TOP	SIDE	TOP	SIDE	TOP	SIDE	TOP
43	5.4	368	(Baffle SPR)	14.4	(Pipe SPR)	16.6	14.1	18.4	(Baffle SPR)			
44	6.3	762	(Baffle SPR)	20.0	(Pipe SPR)	24.2	21.0	24.6	(Baffle SPR)			
45	7.4	965	(Baffle SPR)	24.0	(Pipe SPR)	30.8	29.3	28.3	(Baffle SPR)			
46	8.3	1179	(Baffle SPR)	40.0	(Pipe SPR)	46.6	40.7	28.0	(Baffle SPR)			
47	8.2	1209	(Pipe SPR)	161.1		42.3	48.0	19.8	(Baffle SPR)			
48	7.2	858	(Pipe SPR)	122.8		29.8	34.6	30.0	(Baffle SPR)			

TEST SERIES: 48    OUTAGE: 1X    IMPACTED END: B-END    DISK TYPE/ PHYSICAL CONDITION ---  
 A60 - Stainless Steel Rated for 60 psi  
 B100 - Composite Disk Rated for 100 psi  
 R - Indicates Disc Ruptured During Test

<-----PEAK SURGE PRESSURE (psi)----->

TEST #	IMPACT SPEED (mph)	COUPLER FORCE (kips)	2" B-END PIPE FITTING	2 1/2" NOZZLE SIDE   TOP	4 1/2" NOZZLE SIDE   TOP	6 1/2" NOZZLE SIDE   TOP	2" A-END PIPE FITTING
93	8.3	228.3		20.8 (A60) (Baffle SPR)	42.8 (A60) (Pipe SPR)	56.1 (A60) (Baffle SPR)	



TEST SERIES: 1C OUTAGE: 2% IMPACTED END: B-END

TEST #	IMPACT SPEED (mph)	COUPLER FORCE (kips)	2" B-END		←-----PEAK SURGE PRESSURE (psi)----->						2" A-END	
			PIPE FITTING	PIPE FITTING	2 1/2" NOZZLE		4 1/2" NOZZLE		6 1/2" NOZZLE		PIPE	FITTING
			SIDE	TOP	SIDE	TOP	SIDE	TOP	SIDE	TOP	SIDE	TOP
49	3.6	272	44.2	11.2	5.6	5.2	5.2	5.2	5.2	5.2	5.2	5.2
50	4.4	326	63.5	22.6	9.5	18.2	18.2	18.2	18.2	18.2	18.2	18.2
51	5.3	355	65.9	24.0	15.8	13.0	13.0	13.0	13.0	13.0	13.0	13.0
52	6.3	724	155.5	19.0	20.8	22.4	22.4	22.4	22.4	22.4	22.4	22.4
53	7.3	854	227.8	68.0	32.1	29.8	29.8	29.8	29.8	29.8	29.8	29.8
54	8.2	441	22.4	3.5	16.8	16.8	16.8	16.8	16.8	16.8	16.8	16.8
55	8.2	1124	282.2	39.9	24.2	16.0	16.0	16.0	16.0	16.0	16.0	16.0
56	7.2	801	163.3	37.1	34.2	25.8	25.8	25.8	25.8	25.8	25.8	25.8

TEST SERIES: 2C OUTAGE: 2X IMPACTED END: B-END

DISK TYPE/ PHYSICAL CONDITION ---

- A60 - Stainless Steel Rated for 60 psi
- B100 - Composite Disk Rated for 100 psi
- R - Indicates Disc Ruptured During Test

TEST #	IMPACT SPEED (mph)	COUPLER FORCE (kips)	2" B-END PIPE FITTING	PEAK SURGE PRESSURE (psi)						2" A-END PIPE FITTING
				2 1/2" NOZZLE		4 1/2" NOZZLE		6 1/2" NOZZLE		
				SIDE	TOP	SIDE	TOP	SIDE	TOP	
57	7.3	825	190.0	40.0 (B60)		32.0 (B60)		29.0 (B60)		
58	8.2	1111	260.5	55.6 (B60)		39.4 (B60)		26.0 (B60)		

TEST SERIES: 1D OUTAGE: 4% IMPACTED END: B-END

TEST #	IMPACT SPEED (mph)	COUPLER FORCE (kips)	2" B-END		2 1/2" NOZZLE		4 1/2" NOZZLE		6 1/2" NOZZLE		2" A-END PIPE FITTING
			PIPE	FITTING	SIDE	TOP	SIDE	TOP	SIDE	TOP	
59	3.6	339	45.9		7.6		4.8		1.5		
60	4.4	379	62.0		13.5		15.2		5.5		
61	7.3	859	154.0		50.1		20.0		15.0		
62	8.2	1059	184.1		60.3		27.0		19.8		

TEST SERIES: 20    OUTAGE: 1X    IMPACTED END: B-END    DISK TYPE/ PHYSICAL CONDITION ---  
 A60 - Stainless Steel Rated for 60 psi  
 B100 - Composite Disk Rated for 100 psi  
 R - Indicates Disc Ruptured During Test

<-----PEAK SURGE PRESSURE (psi)----->

TEST #	IMPACT SPEED (mph)	COUPLER FORCE (kips)	2" B-END PIPE FITTING	2 1/2" NOZZLE SIDE	TOP	4 1/2" NOZZLE SIDE	TOP	6 1/2" NOZZLE SIDE	TOP	2" A-END PIPE FITTING
63	8.2	1055	183.4	51.8 (B60)(R)		55.9 (Blind Flange)		20.8 (Blind Flange)		

TEST SERIES: 30 OUTAGE: 4X IMPACTED END: B-END

<-----PEAK SURGE PRESSURE (psi)----->  
 TEST # IMPACT COUPLER 2" B-END 2" A-END  
 FORCE PIPE PIPE  
 (mph) (kips) FITTING FITTING  
 SIDE | TOP SIDE | TOP SIDE | TOP  
 2 1/2" NOZZLE 4 1/2" NOZZLE 6 1/2" NOZZLE  
 FITTING FITTING FITTING

95	8.3	5.0	35.0	10.0
	(Baffle SPR)	(Pipe SPR)	(Baffle SPR)	

TEST SERIES: 40    OUTAGE: 4%    IMPACTED END: B-END    DISK TYPE/ PHYSICAL CONDITION ---  
 A60 - Stainless Steel Rated for 60 psi  
 B100 - Composite Disk Rated for 100 psi  
 R - Indicates Disc Ruptured During Test

TEST #	IMPACT SPEED (mph)	COUPLER FORCE (kips)	2" B-END			4 1/2" NOZZLE			6 1/2" NOZZLE			2" A-END									
			PIPE	PIPE	FITTING	PIPE	PIPE	FITTING	PIPE	PIPE	FITTING	PIPE	PIPE	FITTING							
94	8.3	145.0																			

TEST SERIES: 1E OUTAGE: 0X IMPACTED END: A-END

TEST #	IMPACT SPEED (mph)	COUPLER FORCE (kips)	2 1/2" NOZZLE		4 1/2" NOZZLE		6 1/2" NOZZLE		2" A-END PIPE FITTING
			SIDE	TOP	SIDE	TOP	SIDE	TOP	
64	3.6	310	5.0		1.3		10.0		17.4
*65	4.4	375	5.0		2.0		25.0		25.0
66	5.3	780	21.9		79.4		113.4		107.7
67	6.3	1075	47.8		135.7		>200		173.6
68	3.6	405	8.7		4.7		8.2		17.3
69	4.4	542	18.7		5.5		25.4		69.1
70	5.4	863	30.6		87.9		112.6		185.1
71	6.2	1217	68.8		135.6		>200		236.1

\* Run 65 data was read from strip charts instead of being recorded from Hewlett-Packard data acquisition equipment

TEST SERIES: 2E OUTAGE: 0X IMPACTED END: A-END DISK TYPE/ PHYSICAL CONDITION ---  
 A60 - Stainless Steel Rated for 60 psi  
 B100 - Composite Disk Rated for 100 psi  
 R - Indicates Disk Ruptured During Test

TEST #	IMPACT SPEED (mph)	COUPLER FORCE (kips)	2" B-END		2 1/2" NOZZLE		4 1/2" NOZZLE		6 1/2" NOZZLE		2" A-END PIPE FITTING
			PIPE	FITTING	SIDE	TOP	SIDE	TOP	SIDE	TOP	
72	4.4	459			8.2 (A60)		6.6 (A60)		27.5 (A60)		35.9
73	5.4	814			16.5 (A60)		76.5 (A60)(R)		115.2 (A60)(R)		106.7
74	6.4	1167			51.0 (A60)(R)		135.8 (A60)(R)		>200 (A60)(R)		185.6
75	5.4	818			27.3 (B100)		61.7 (B100)		177.9 (B100)		132.3
76	6.4	1143			38.8 (B100)		135.9 (B100)(R)		>200 (B100)(R)		186.3



TEST SERIES: 3E CUTAGE: 0X IMPACTED END: A-END

TEST #	IMPACT SPEED (mph)	COUPLER FORCE (k-lbs)	2" B-END		2 1/2" NOZZLE		4 1/2" NOZZLE		6 1/2" NOZZLE		2" A-END PIPE FITTING
			PIPE	FITTING	SIDE	TOP	SIDE	TOP	SIDE	TOP	
77	5.4	825			2.5 (Baffle SPR)			65.7 (Pipe SPR)	76.8	21.1 (Baffle SPR)	
78	6.4	1170			2.5 (Baffle SPR)		228.3 (Pipe SPR)	135.7	147.2		
96	5.3	766			27.7		3.3		57.5 (Mesh SPR)	59.9	
97	6.4	1082			63.3		75.9		138.7 (Mesh SPR)	150.0	
98	6.4	1023			60.1		81.2		149.9 (Mesh SPR)	156.1	

TEST SERIES: 4E OUTAGE: 0X IMPACTED END: A-END DISK TYPE/ PHYSICAL CONDITION ---  
 A60 - Stainless Steel Rated for 60 psi  
 B100 - Composite Disk Rated for 100 psi  
 R - Indicates Disc Ruptured During Test

TEST #	IMPACT SPEED (mph)	COUPLER FORCE (kips)	2" B-END PIPE FITTING		2 1/2" NOZZLE		4 1/2" NOZZLE		6 1/2" NOZZLE		2" A-END PIPE FITTING
			SIDE	TOP	SIDE	TOP	SIDE	TOP	SIDE	TOP	
79	5.5	850	2.5 (A60) (Baffle SPR)		76.0 (A60) (Pipe SPR)		15.0 (A60) (Baffle SPR)				117.9
80	6.5	1206	2.5 (A60) (Baffle SPR)		135.8 (A60)(R) (Pipe SPR)		38.0 (A60) (Baffle SPR)				160.6
81	6.4	1198	2.5 (A60) (Baffle SPR)		135.8 (B100) (Pipe SPR)		35.9 (A60) (Baffle SPR)				208.0
82	6.4	1205	5.0 (A60) (Baffle SPR)		136.0 (B100) (Pipe SPR)		26.3 (A60) (Baffle SPR)				293.7
99	5.4	747	21.0 (Blind Flange)		10.0 (Blind Flange)		60.7 (A60) (Mesh SPR)				
100	6.4	1037	73.1 (Blind Flange)		74.0 (Blind Flange)		136.6 (A60)(R) (Mesh SPR)				
101	6.3	975	54.4 (Blind Flange)		60.0 (Blind Flange)		127.7 (B60) (Mesh SPR)				

TEST SERIES: 1F OUTAGE: 2X IMPACTED END: A-END

TEST #	IMPACT SPEED (mph)	COUPLER FORCE (kips)	2" B-END PIPE FITTING		2 1/2" NOZZLE		4 1/2" NOZZLE		6 1/2" NOZZLE		2" A-END PIPE FITTING
			SIDE	TOP	SIDE	TOP	SIDE	TOP	SIDE	TOP	
83	4.4	316	3.1		10.4		44.6		80.3		
84	5.4	346	10.1		15.5		44.7		78.9		
85	6.3	652	13.0		17.3		52.1		111.3		
86	7.3	1009	16.3		19.0		53.5		208.0		
87	8.3	1164	10.0		36.1		>200		263.7		

TEST SERIES: 2F    OUTAGE: 2X    IMPACTED END: A-END    DISK TYPE/ PHYSICAL CONDITION ---  
 A60 - Stainless Steel Rated for 60 psi  
 B100 - Composite Disk Rated for 100 psi  
 R - Indicates Disc Ruptured During Test

TEST #	IMPACT SPEED (mch)	COUPLER FORCE (kips)	2" B-END		2 1/2" NOZZLE		4 1/2" NOZZLE		6 1/2" NOZZLE		2" A-END PIPE FITTING			
			PIPE	FITTING	SIDE	TOP	SIDE	TOP	SIDE	TOP				
88	7.2	916			11.1 (A60)			32.7 (A60)			48.3 (A60)			231.5
89	8.3	1130			13.7 (A60)			31.7 (A60)			155.7 (A60)			316.7

TEST SERIES: 4F OUYAGE: 2X IMPACTED END: A-END

DISK TYPE/ PHYSICAL CONDITION ---

- A60 - Stainless Steel Rated for 60 psi
- B100 - Composite Disk Rated for 100 psi
- R - Indicates Disc Ruptured During Test

TEST #	IMPACT SPEED (mph)	COUPLER FORCE (kips)	2" B-END		2 1/2" NOZZLE		4 1/2" NOZZLE		6 1/2" NOZZLE		2" A-END PIPE FITTING
			PIPE	FITTING	SIDE	TOP	SIDE	TOP	SIDE	TOP	
102	5.4	407			29.9 (Blind Flange)		3.0 (Blind Flange)		48.8 (A60) (Mesh SPR)		
103	6.4	713			33.6 (Blind Flange)		3.0 (Blind Flange)		47.5 (A60) (Mesh SPR)		
104	8.3	1204			35.0 (Blind Flange)		3.0 (Blind Flange)		85.8 (A60) (Mesh SPR)		

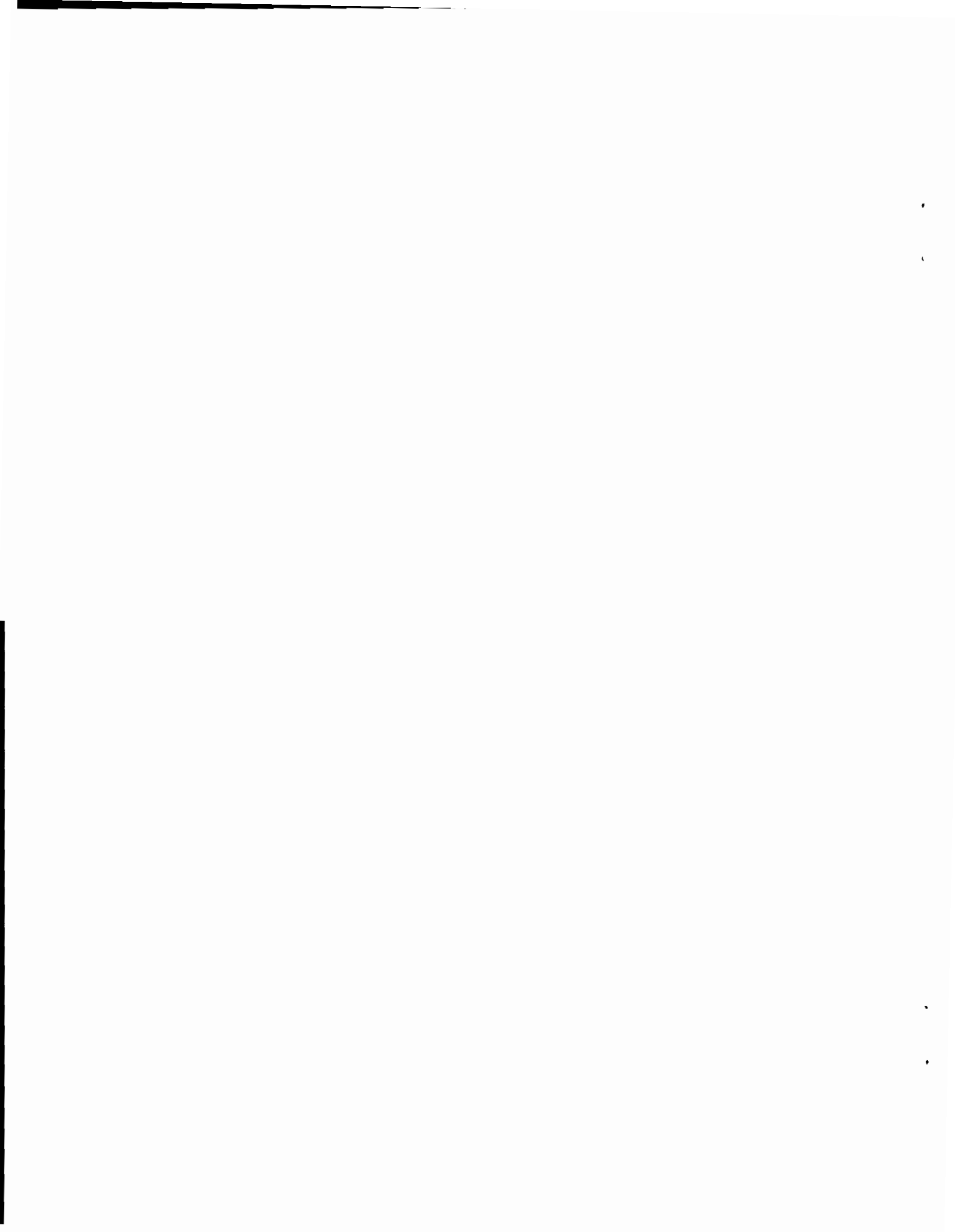

**APPENDIX C**  
**VIDEO LOG**  
**(LIST OF VIDEO RECORDINGS**  
**SHOWING RUPTURES)**

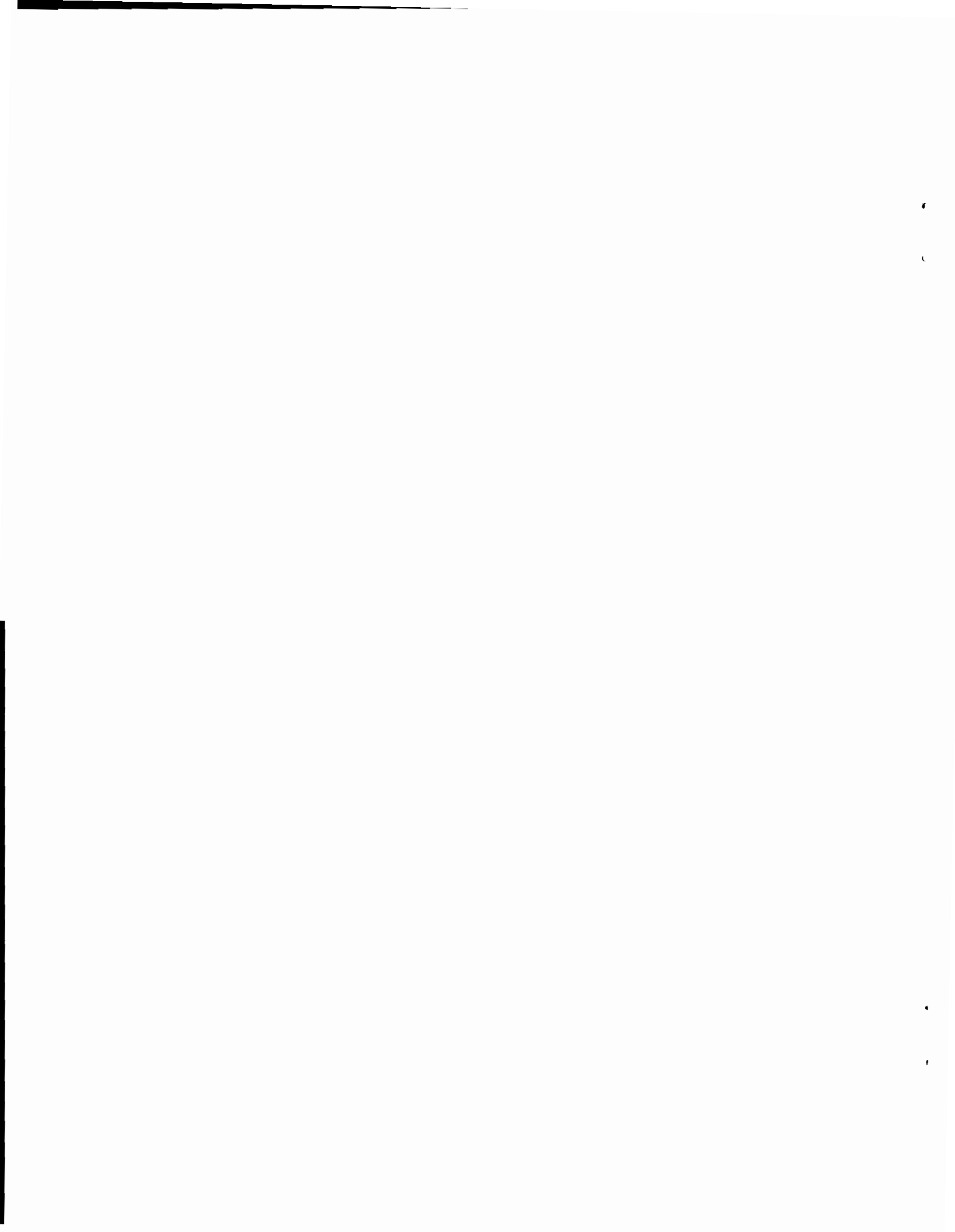



Run Number	Date	Video Time (min)	Test Series	Outage (%)	Actual Speed (mph)	Coupler Force (kips)	2-1/2"	4-1/2"	6-1/2"
26	8/4/89	15:39:45.87	2A	0	5.4	888	X	X	X
42	8/10/89	13:27:37.51	2B	1	8.3	-1200	X		
63	8/11/89	15:34:17.83	2D	4	8.2	-1050	X		
73	8/15/89	12:54:49.65	2E	0	5.4	-800		X	X
74	8/15/89	13:12:00.83	2E	0	6.4	-1200	X	X	X
76	8/15/89	13:41:13.63	2E	0	6.4	-1200		X	X

