



FRA Office of Research and Development

Current Projects

Research Sections

Section 1: [Track](#)

Section 2: [Rolling Stock](#)

Section 3: [Train Control and Communications](#)

Section 4: [Human Factors](#)



Section 1

Track Division

Rail Integrity

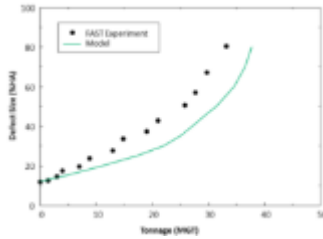
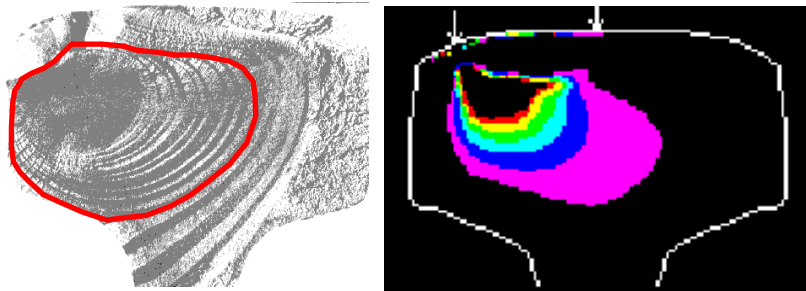

Railroad Impact

- Rail represents a majority of a railroad's assets.
- Railroads spend a significant portion of their budget on maintaining and inspecting rail.
- Broken rail is a major cause of mainline derailments.
- Most broken rails originate from internal rail head defects.

Project Description

- Apply engineering principles to understand the development and growth of internal rail defects
- Conduct experiments and analysis to examine fracture behavior of head-hardened rail
- Develop rational strategies to manage rail defects
- Consider improved strategies for non-destructive inspection and scheduling of rail tests

Project Partner(s)

- Transportation Technology Center, Inc.

Cost & Schedule

- Budget allocation for FY2015: \$150k

FRA Project Manager

Leith Al-Nazer, (202) 493-6128, leith.al-nazer@dot.gov

Joint, Weld and Component Integrity



Railroad Impact

- Failed rail joints and welds are also major causes of mainline derailments.
- Joint bars are often used in continuous welded rail (CWR) as a temporary repair of defective rail.
- Failures and derailments at frogs occur from wheel impact loads and dynamic interaction.

Project Description

- Understand the mechanics of failures at rail joints, welds and rail components such as frogs
- Develop and refine finite element analysis of bolted rail joints
- Monitor projects under the FRA Broad Agency Announcement (BAA) Program

Project Partner(s)

- Edison Welding Institute
- ENSCO, Inc.
- Transportation Technology Center, Inc.

Cost & Schedule

- Budget allocation for joint integrity in FY 2015: \$75k
- Budget allocation for weld and component integrity in FY2015: \$50k

FRA Project Manager

Leith Al-Nazer, (202) 493-6128, leith.al-nazer@dot.gov

Rail Integrity Support to Office of Railroad Safety



Railroad Impact

- Rail safety is maintained by periodic rail testing mandated by the Track Safety Standards published by FRA in the Code of Federal Regulations.
- Modifications and amendments to standards and regulations are achieved through the RSAC process

Project Description

- Provide technical support to FRA Office of Railroad Safety in regulatory activities, on an as needed basis, such as deliberations of the Rail Safety Advisory Committee(RSAC).

Project Partner(s)

- Railroads
- Labor Organizations
- Suppliers and Manufacturers

Cost & Schedule

- RSAC Rail Integrity Working Group convened in July 2014, and is scheduled to conclude in July 2015
- Budget allocation for FY2015: \$50k

FRA Project Manager

Leith Al-Nazer, (202) 493-6128, leith.al-nazer@dot.gov

Handheld Rail Flaw Tomographic Imaging System

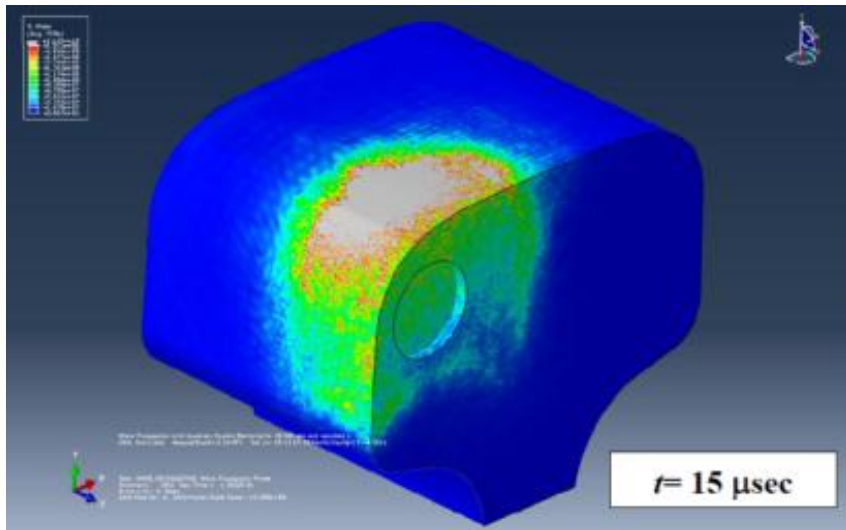

Railroad Impact

- Currently, identification of potential internal rail defects is hampered by two significant limitations:
- First, it is impossible to confirm the presence of an internal defect without first removing the affected area of the vehicle
- Second, once detached, follow-up inspections are often conducted with portable ultrasonic devices that require a highly specialized skill set to operate.
- This proposed task focuses on the development of instrumentation that yield easily interpreted results that could eventually lead to automatic detection and imaging of internal rail flaws.

Project Description

- The goal of this project is to develop advanced means to visualize the results of manual inspections of suspected internal rail flaws;
- Initial phase of study would employ a technology survey to determine the state-of-the-art in inspection technology;
- Efforts will then focus on the use of signal processing practices used in other fields, such as tomography, or alternative approaches, to process data collected with the final goal of creating a user interface that displays a 3-D image of the rail defect being interrogated.
- Performs rapid sizing, type, and location of rail flaws in the field.

Project Partner(s)

- Avanti Tech

Cost & Schedule

- Project duration: 2011 – Present
- Approximate cost to date: \$800k
- FRA Report:
http://www.fra.dot.gov/eLib/details/L04509#p1_z5_gD_krail%20flaw

FRA Project Manager

Leith Al-Nazer, (202) 493-6128, leith.al-nazer@dot.gov

Low Solar Absorptivity Coating for Rails



Railroad Impact

- Based on FRA accident statistics, most of the T109 (rail sun kink / buckling) derailments occur near fixed structures (such as open deck bridges and switches), which indicates that rail neutral temperature may be decaying more rapidly near fixed structures.
- Lowering rail temperatures near these fixed structures could help reduce the number of track buckle derailments.

Project Description

- This project investigates the effectiveness of topical thermal control coatings in reducing the maximum daily rail temperatures and therefore reducing the risk of track buckles.
- Several (3 or 4) commercial coatings used in other industries will be tested on rail.
- A section of rail will be coated with each of the chosen commercial coatings, and rail temperature data will be collected over the course of a couple months.
- The effectiveness of the coatings will be determined by comparing the temperatures of the coated rail sections to the temperature of an uncoated rail section.

Project Partner(s)

- EWI

Cost & Schedule

- Project duration: 2013 – Present
- Approximate cost to date: \$100k

FRA Project Manager

Leith Al-Nazer, (202) 493-6128, leith.al-nazer@dot.gov

Rail Neutral Temperature Time & Spatial Variability Study



Railroad Impact

- Based on FRA accident statistics, most of the T109 (rail sun kink / buckling) derailments occur near fixed structures such as open deck bridges and switches, which indicates that rail neutral temperature may be decaying more rapidly near fixed structures.
- Knowing the rate of the decay of rail neutral temperature near these fixed structures may help railroads plan de-stressing maintenance operations and reduce the number of track buckles occurring near fixed structures.

Project Description

- This project quantifies the rate of decay of rail neutral temperature near fixed structures as well as the rate of decay of rail neutral temperature in open track (i.e., away from fixed structures).
- Three sites on a Class I railroad will be chosen and instrumented with strain gages which will measure the rate of decay of neutral temperature adjacent to the fixed structures as well as a significant distance away from the fixed structure (greater than 0.5 miles) over a one year period.

Project Partner(s)

- QinetiQ-NA

Cost & Schedule

- Project duration: 2013 – Present
- Approximate cost to date: \$300k

FRA Project Manager

Leith Al-Nazer, (202) 493-6128, leith.al-nazer@dot.gov

In-Motion Rail Temperature Measurement System

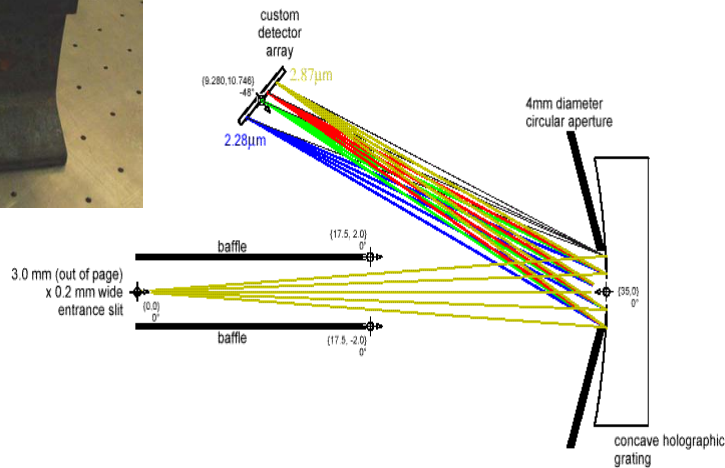
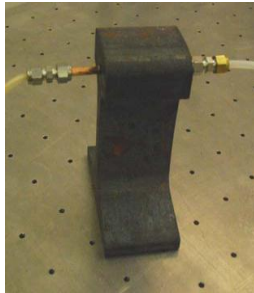

Railroad Impact

- Currently, rail temperature measurements are approximated by adding 30 degrees F to the air temperature. This project will allow real time monitoring of rail temperature.
- Conductors will be able to immediately alter operations and reduce speed if high rail temperatures are detected.
- Data can be used to validate a rail temperature prediction model which is currently in development.

Project Description

- A rail temperature measurement system will be developed capable of being installed on an in-service rail vehicle.
- Multiple sensors will detect the surface temperature of the head and web of both rails.
- Software with a streaming, real-time display of rail temperature data.
- An integrated GPS location capability is included in the system.

Project Partner(s)

- En'Urga

Cost & Schedule

- Project duration: 2009 – Present
- Approximate cost to date: \$700k, FRA Research Results: http://www.fra.dot.gov/eLib/details/L04123#p1_z5_gD_krail%20temperature

FRA Project Manager

Leith Al-Nazer, (202) 493-6128, leith.al-nazer@dot.gov

Ultra-Portable Ride Quality Meter (UPRQM)



Project Description

- This project will develop a compact, portable ride quality meter with GPS data integration.
- The UPRQM will allow for real-time display of data channels and real-time GIS-based mapping of current location.
- The UPRQM will be designed to work in conjunction with a laptop from which it will receive its power through a USB connection.

Railroad Impact

- Presently, track inspectors evaluate the ride quality of a train in a subjective manner by riding the train and feeling the “bumpiness” of the ride.
- The UPRQM will quantify this process, thereby allowing for collection, analysis, and recording of data.
- The collected data will be beneficial in addressing immediate safety concerns, as well as long-term track degradation and statistical studies.

Project Partner(s)

- dFuzion, Inc.

Cost & Schedule

- Project duration: 2007 – Present
- Approximate cost to date: \$800k, FRA Research Results: http://www.fra.dot.gov/eLib/details/L04124#p1_z5_gD_kride%20quality%20meter

FRA Project Manager

Leith Al-Nazer, (202) 493-6128, leith.al-nazer@dot.gov

Rail Temperature Prediction Model

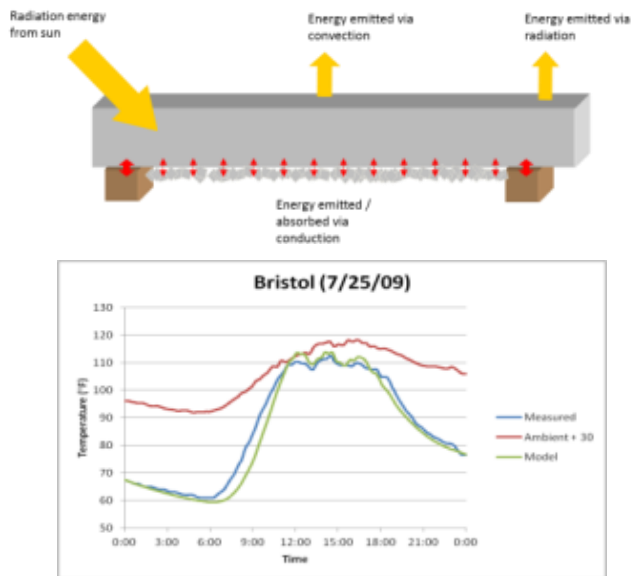

Railroad Impact

- Rail temperatures can be predicted up to 24 hours in advance
- Railroads can anticipate potentially hazardous situations and target slow orders and heat inspections early in the day.
- Increase safety and efficiency through more effective and accurate targeting of heat related slow orders

Project Description

- This project will develop a rail temperature prediction model based on heat transfer principles.
- Validate rail temperature prediction model by comparing rail temperature predictions to measured rail temperatures.
- Use signal detection theory to compare accuracy of the rail temperature prediction model to the current empirical method, which approximates maximum rail temperatures by adding 30 degrees F to the maximum predicted ambient temperature.
- Create web based application and user interface for disseminating rail temperature predictions to end users.

Project Partner(s)

- Ensco

Cost & Schedule

- Project duration: 2006 – Present
- Approximate cost to date: \$1.2M

FRA Project Manager

Leith Al-Nazer, (202) 493-6128, leith.al-nazer@dot.gov

Nondestructive measurement of neutral temperature

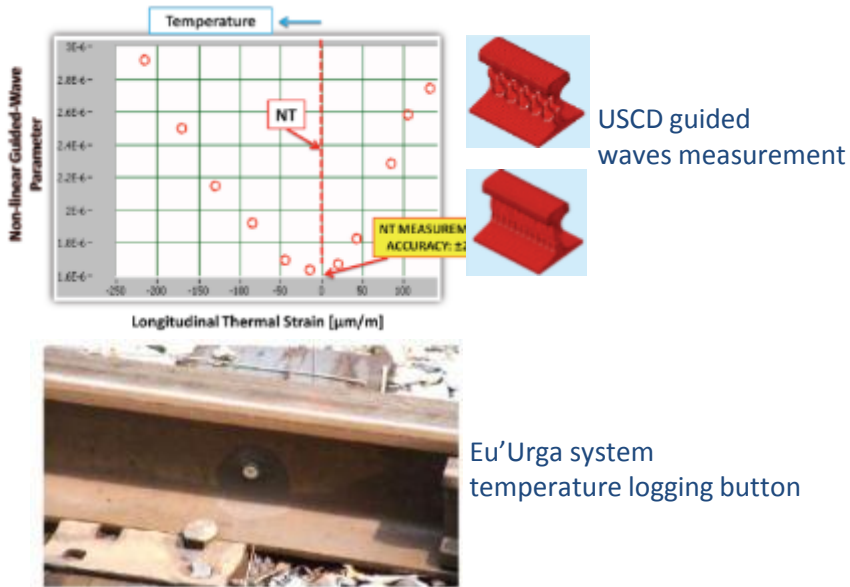

Railroad Impact

- Improve understanding of the current state of thermal stress in the rail is needed to properly schedule slow-orders and prevent track buckling derailment
- Measurement systems deployed on BNSF, Amtrak and the UPRR railroads for field testing and related data acquisition
- Improved track buckling risk related slow orders will have an economic benefit by more accurately targeting high risk areas

Project Description

- Support the testing of a new diagnostic system for neutral temperature in CWR based on nonlinear ultrasonic complex guided waves under constrained thermal expansion.
- Develop independent assessment of the data resulting from new rail force measurement systems to help validate the results
- Assess results from rail force redistribution tests to identify new or unexpected trends that might require modifications of analytical tools or maintenance guidelines.

Project Partner(s)

- University of California at San Diego
- En'Urga, ENSCO and QinetiQ

Cost & Schedule

- Budget: \$175k
- Recommendations for deployment of emerging technology: May 2015
- Review and assessment of the use of the discrete element model for track lateral resistance assessment: May 2015
- Test Support as needed based on FRA plan with contractor

FRA Project Manager

Leith Al-Nazer and Mahmood Fateh

(202) 493-6128 - (202) 493-6361

leith.al-nazer@dot.gov - Mahmood.Fateh@dot.gov

Real-Time Measurement of Track Deflection from a Moving Car



Railroad Impact

- Now 4 Units of this FRA developed technology are in service:
 - Unit #1 testing on UPRR
 - Unit #2 testing on CP/AGR/BNSF
 - Unit 33 testing on CN
 - FRA's T218
- Tested on FRA's T218 at TTCI, Western Mega Test Site, Amtrak Northeastern Corridor
- Performed before/after testing on the former CP's South Dakota line quantifying ballast stabilization methods and undercutting.
- Significant Bridge testing at TTCI

Project Description

- The objective of this project is to design a system that provides autonomous real-time measurements of track deflection from a moving railcar operating in revenue service.
- MRAIL, a privately funded startup company, has been licensed to commercialize results of this research.
- MRAIL recently partnered with Harsco Rail to move technology into the domestic and international marketplace.

Project Partner(s)

- Project Partners: University of Nebraska, Lincoln (UNL)- , UPRR, BNSF, HARSCO, CN, CP, TTCI; PI: Dr. Shane Farritor

Cost & Schedule

- Project successfully completed on 10/31/2014 as scheduled, and specified deliverable prototype installed on FRA Research Vehicle (T-18) and accepted.

FRA Project Manager

Mahmood Fateh, (202) 493-6361, Mahmood.Fateh@dot.gov

Non-contact Rail Inspection Prototype

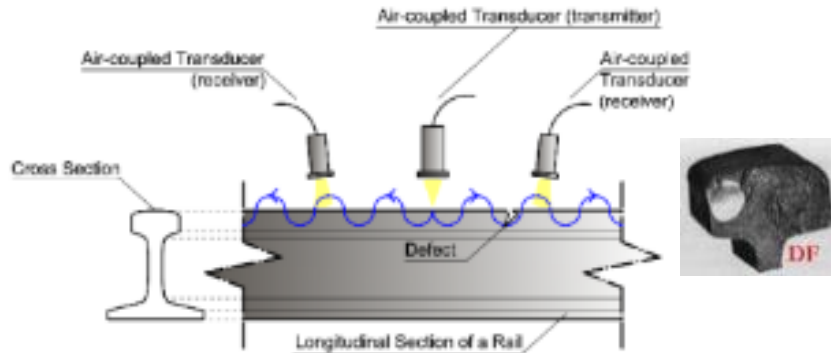

Railroad Impact

- Reliability of current rail inspection technologies need improvement, particularly under shelling conditions and grime. False positives are also a challenge.
- NTSB Safety Reports addressed disastrous train derailments in Superior, WI in 1992 (BNSF) and Oneida, NY in 2007 (CSX) caused by undetected internal head defects under shelling.
- A non-contact system that maximizes Probability of Defect Detection and minimizes False Positives can complement existing rail inspection technologies for increased safety.
- If new system's coverage is extended to the full section of the rail (head, web and base), this technology could potentially replace existing inspections based on contact wheels.

Project Description

- Purpose of project is improved reliability of rail defect detection, particularly under surface conditions of shelling and grime.
- System uses air-coupled transducers, ultrasonic guided waves, and patented statistical signal analysis to maximize Probability of Detection and to minimize False Positives.
- First field test of the air-coupled system performed at the Transportation Technology Center (TTC) in October 2014 at walking speed. Evaluation of results is in currently process.
- A second field test incorporating lessons learned, at speeds comparable to current rail inspections is planned for the spring/summer 2015.

Project Partner(s)

- University of California San Diego (grantee), BNSF (test support), ENSCO (test support), Volpe Center (test evaluation)

Cost & Schedule

- FY2013: \$350k (ends 12/31/2014)

FRA Project Manager

Mahmood Fateh, (202) 493-6361, Mahmood.Fateh@dot.gov

Rail Neutral Temperature Measurement



Rail-NT system



Field tests at TTCI

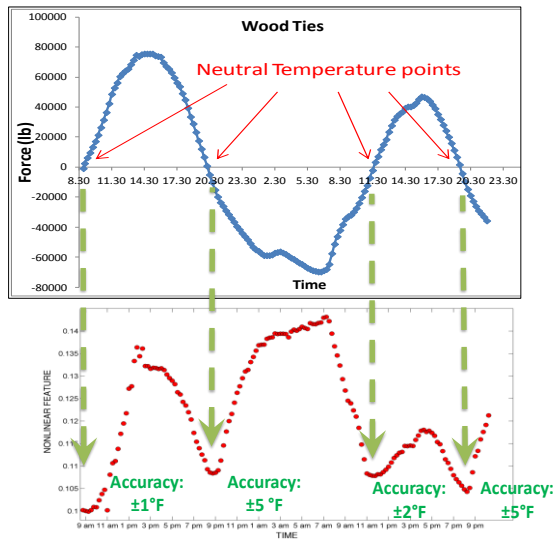

Railroad Impact

- Knowledge of NT in CWR is critical to avoid breakage in cold weather and buckling in hot weather. This need is ever more stringent with increasing train tonnage and speeds.
- Current methods to determine rail NT require unfastening of the rail, can be sensitive to rail fastening/support conditions and/or residual stresses.
- A system capable of measuring rail NT in-situ without the need for unfastening the rail, not affected by tie-to-tie variations or residual stress effects would benefit both safety and efficiency of operation of railroads.

Project Description

- This project is to develop a new technology for measuring the Neutral Temperature (NT) of rails using non-linear behavior of ultrasonic guided waves. Two patent applications have been filed by UCSD.
- *Rail-NT* prototype developed at the 70-ft long large-scale CWR testbed of UCSD's Powell Structural Laboratories, with BNSF help.
- Results from the testbed showed NT measurement accuracy of +/- 3 deg F. Tests at TTC showed NT accuracy of +/- 5 deg F.
- *Rail-NT* system is being further developed by Rail Inspections, LLC (UCSD licensee), in partnership with railroads (BNSF, UP, AMTRAK, NS), to evaluate both performance and economy of operation.
- Prototype calibrated for rail sections 136RE and 141RE. Currently calibrating for 115RE and 132 RE rails. Also studying option of artificial rail heating to reduce test time.

Project Partner(s)

- University of California San Diego (grantee), BNSF (test support & evaluation), NS (test support & evaluation), UP (test support & evaluation), AMTRAK (test support & evaluation).

Cost & Schedule

- Current obligations: \$300k (ends 03/31/2015)
- FY2015: Planning underway on next steps, including compact re-packaging for efficient deployment, potential partnering, etc.

FRA Project Manager

Mahmood Fateh, (202) 493-6361, Mahmood.Fateh@dot.gov



Development and Evaluation of Continuous Welded Rail (CWR) Joints

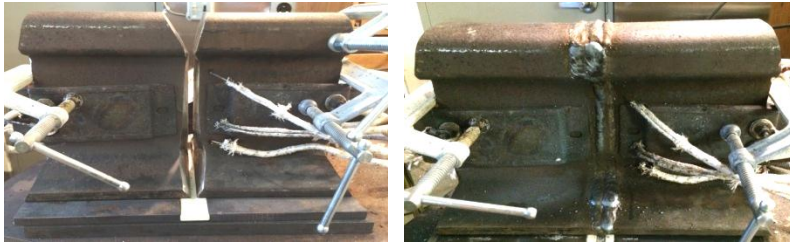

Rail sections before welding

Rail sections after welding (CWR-joint)

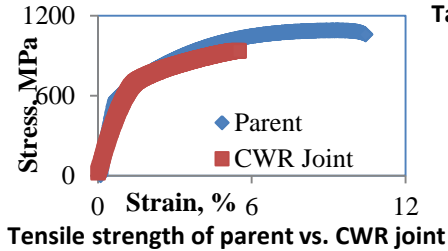

Table. Mechanical Properties Comparisons

#Average	Tensile Strength, σ_u	Residual strength, σ_r
Parent	1100	500
CWR Joint	940	475
Efficiency, $\dot{\eta}$ (%)	$\sigma_{uW}/\sigma_{uP} = 86$	$\sigma_{rW}/\sigma_{rP} = 95$

Railroad Impact

- An innovative joining technique is being developed that address some of the drawbacks of thermite and flash-butt welded joints.
- Reduce the time and cost of joining processes.
- Improve performance, safety, and comfort of the railroads.
- Enhance the fatigue damage tolerance of the welded rail joints

Project Description

- CWR joints were produced using gas metal arc welding (GMAW).
- Welding parameters including preheating, heat input, weld speed, feed rate were optimized.
- The geometry of the rail section at the ends was modified to facilitate the production of the weld joint with maximum integrity.
- NDE using UT are being employed for weld integrity verification.
- Mechanical tests including strength, fracture toughness, fatigue and failure analysis of the welded joints are performed.

Project Partner(s)

- Tuskegee University, Nucor Steel Corporation, Lincoln Electric & TTCI

Cost & Schedule

- Current obligations: \$300k
- 3-year program:
 - Phase I: Development of welded rail joints
 - Phase II: NDE evaluation of the welded joints
 - Phase III: Mechanical, fracture and fatigue testing of the welded joints

FRA Project Manager

Mahmood Fateh, (202) 493-6361, Mahmood.Fateh@dot.gov

Ground Penetrating Radar (GPR) Technology Evaluation and Implementation



Railroad Impact

- GPR will be utilized to advance research in track support and track substructure investigations, particularly at revenue service locations that have been jointly identified by FRA and industry as problem areas of concern.
- GPR on an FRA platform will allow for correlation and better alignment between existing measurement systems such as track geometry, vertical track deflection, gage restraint measurement and GPR, so as to assist in determining main root causes of track geometry defects and degradation over time and give an indication of the performance and lives of other track components such as rails and ties.
- GPR testing assists in proactive planning of maintenance activities before substructure and support problems become more visible and severe. As such, performance and safety of the track substructure become more predictable and reliable.

Project Description

- Develop recommendations and improved guidelines for use of GPR in North America based track substructure parameters.
- GPR system procurement for FRA research vehicle.
- Conduct evaluation tests of data collected in revenue service, including Ballast layer thickness, Ballast layer fouling, Ballast layer moisture content, and Subgrade analysis.
- Provide an assessment of the track substructure degradation conditions identified by GPR at the revenue service locations.
- Evaluate the relationship between the GPR based substructure parameters and the track condition in terms of stiffness and track geometry.
- Project end date: Mid FY2017.

Project Partner(s)

- TTCI

Cost & Schedule

- FY 2014 funding \$375k,
- http://www.fra.dot.gov/eLib/details/L05318#p1_z50_gD_IRS

FRA Project Manager

Hugh Thompson, (202) 493-6383, hugh.thompson@dot.gov

Concrete Tie Rail Seat Deterioration (RSD) Mechanisms



Railroad Impact

- RSD has been identified as a cause in several recent high profile derailments.
- RSD is difficult to detect when in early stages, leaving little opportunity for repair before failure.
- Detection of RSD in its early stages will allow time for remediation and prevent derailments.
- Current methods utilize visual inspection (slow) and cant measurements (cant not unique to RSD).

Project Description

- Rail seat deterioration remains a risk to track operations that is a challenge to inspect for visually.
- The root cause of RSD has still not been demonstrated, although analysis of RSD through literature review, field evaluation, and modeling continues.
- Inspection techniques targeting this problem are critical because the problem will not likely be eliminated until the the cause is known
- Inspection technology builds on existing FRA R&D capabilities
- Builds on initial survey of RSD detection methods by AAR in 2008 showing wide range of measured rail cant from different inspection methods.
- With the cooperation of AAR and member railroads the basic measurement of rail cant will be improved to develop correlation of actual cant to measured.
 - Measure actual RSA and resulting cant.
 - Determine acceptable cant limits.

Project Partner(s)

- TTCI

Cost & Schedule

- FY 2014/2015 funding \$250k

FRA Project Manager

Hugh Thompson, (202) 493-6383, hugh.thompson@dot.gov

Portable Track Loading Fixture (PTLF)



Railroad Impact

- Improve inspection of track gage widening conditions
- Provide more reliable validation of GRMS identified defects
- An digital PTLF that uses the return load-deflection characteristics will
 - Improve gage widening detection capability
 - Improve repeatability by four (4) times that of the current PTLF
- Improved detection and reliability will lead to greater acceptance in the industry of the PTLF as a gage widening assessment tool.
- Ease of measurement would result in more widespread use by Industry.

Project Description

- Gage Widening defects are a leading derailment cause
- The project goal is:
 - To improve detection and verification of tie-fastener defects
 - Provide inspectors with an unbiased and reliable tie, fastener, and gage widening assessment tool
- A modification of the PTLF design will result in two prototype PTLFs for field validation testing.
- Improvements to the PTLF include improved consistency of the PTLF measurement and improved correlation to GRMS.
- In the future, PTLF standards will be evaluated and issues addressed to improve acceptance in the industry.

Project Partner(s)

- ENSCO

Cost & Schedule

- FY 2013 funding \$200k (through 2/2015)
- http://www.fra.dot.gov/eLib/details/L04119#p1_z50_gD_IRS

FRA Project Manager

Hugh Thompson, (202) 493-6383, hugh.thompson@dot.gov

Assessment and Analysis of Track Measurements Systems



Railroad Impact

- Changing environmental conditions and rail service trends require rapid, reliable, and actionable track condition data to identify emerging risks.
- This track structural assessment technology could provide actionable results for further inspection or repair
- Research in this task has allowed for the possible application of performance based track strength evaluation.
- Methods accessed through this task are targeting the identification of rail seat deterioration for concrete ties to minimize the risk of rail rollover derailments.
- Approaches for the overall assessment of track developed through this task will directly bear on the evaluation of track rehabilitation projects.

Project Description

- Evaluate gage widening due to rail roll and seat translation including:
 - Load regime required to exercise the roll and translation modes
 - identify locations exhibiting signs of rail seat deterioration on concrete ties,
 - support the development of class-based GRMS standards, especially for higher track classes.
- Improving the state of the art of GRMS technology.
- Demonstrate the safety benefits of track strength assessment to corridor condition assessment and rehabilitation efforts.
- Development of correlations between multiple track assessment technologies, such as GRMS, TGMS, GPR, and vertical track deflection.

Project Partner(s)

- ENSCO

Cost & Schedule

- FY2015 funding \$150k

FRA Project Manager

Hugh Thompson, (202) 493-6383, hugh.thompson@dot.gov

Ballast Inspection and Performance Characteristics

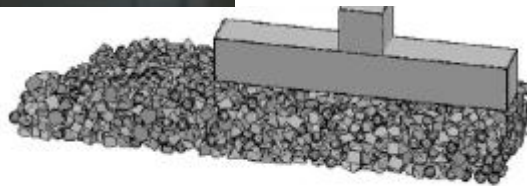

Railroad Impact

- Adequate ballast performance is required to ensure the safety, longevity and economical performance of all track components
- Inadequate ballast performance reduces the economic benefits of rail transport and results in degradation that can affect safety
- Ballast maintenance is required to alleviate track geometry problems and ensure adequate track support needed to realize the benefits of premium track structures like concrete ties
- Improved detection of ballast condition and performance problem areas will result in safety and economic benefits resulting from improved problem detection, targeted maintenance, and quantifiable quality control criteria

Project Description

- Support the development and validate the results from ballast related inspection technology including ground penetrating radar, track deflection, and track moisture assessment
- Develop track support and ballast information for simulations of track buckling / shift, tie / rail performance, and degradation
- Support, validate, and extend analytical techniques for ballast safety and mechanical performance
- Support development of failure criteria for ballast

Project Partner(s)

- Universities of Illinois, Nebraska, and Massachusetts
- Zetica/Balfour Beatty, Hyground Engineering, TTCI

Cost & Schedule

- \$125k
- Ballast Discrete Element Model Assessment: May 2015
- Paper on Ballast Performance Limits and Failure: May 2015
- Deflection / GPR Deployment Recommendations: March 2015
- Review of TTCI GPR Assessment Results: Feb. 2015
- Review of ballast moisture detection: Feb. 2015
- Paper on tie deflection with UIUC: Jan. 2015

FRA Project Manager

Hugh Thompson, (202) 493-6383, hugh.thompson@dot.gov

Subgrade Inspection and Performance



Railroad Impact

- Adequate subgrade performance is required to ensure the overall stability and safety of the track structure
- Inadequate subgrade performance can result in particularly problematic failures that are slow to repair
- Few economical maintenance options exist for subgrade repair
- Guidelines for subgrade and embankment performance following inundating rainfall events may reduce the likelihood of washouts
- Detection of subgrade conditions and performance problem areas is critical to correct identification of the problem cause and development of targeted remedies

Project Description

- Support the development and validate the results from subgrade related inspection technology including spectral analysis of surface waves and combined GPR/deflection data
- Develop track support related subgrade information for simulations of tie / rail performance and track degradation
- Support development of failure criteria for subgrade including lower bound properties for operations

Project Partner(s)

- Universities of Illinois/Texas El Paso and Massachusetts

Cost & Schedule

- Budget \$60k
- Transition Model Subgrade Deformation Analysis: March 2015
- Review of subgrade inspection techniques including SASW Subgrade Deployment Recommendations: July 2015
- Recommendations for combined GPR/deflection data for subgrade stability assessment: Feb. 2015

FRA Project Manager

Hugh Thompson, (202) 493-6383, hugh.thompson@dot.gov

Track Gauge Widening and Strength Measurements



Railroad Impact

- New loading strategy with PTLF will be evaluated for compatibility with the track strength limits set in the FRA track safety standard
- GRMS and PTLF will be tested for their capability to detect RSD failure in addition to gauge widening failure
- GRMS limits established for timber tie tracks will be evaluated for applicability in concrete tie, plastic tie, steel tie and slab tracks and in heavy haul and high speed operations

Project Description

- Help expand the Gauge Restraint Measurement System's (GRMS) failure mode detection capability, mainly to include the detection of rail seat deterioration (RSD)
- Support the extension of GRMS limits to different track structures and vehicle conditions
- Support the design and engineering of a new Portable Track Loading Fixture (PTLF)

Project Partner(s)

- Volpe Center
- Ensco

Cost & Schedule

- \$60k for 12 months

FRA Project Manager

Hugh Thompson, (202) 493-6383, hugh.thompson@dot.gov

Concrete Tie and Fastener Research



Railroad Impact

- Improved performance of concrete tie and fastening systems for passenger and freight operations.

Project Description

- **Performance-based specifications**
(UIUC, CXT, BNSF, UP, Amtrak)
 - Tie performance requirements based on empirical and laboratory analyses
 - Full-scale experimental lab for tie/fastener/ballast testing
- **Pre-stress/transfer length optimization**
(Kansas State University, CXT)
 - Detailed analysis and testing of steel reinforcements used in concrete tie construction
- **Internal tie condition measurement**
(NDT Corp, UP, Amtrak)
 - Non-destructive technologies for objectively assessing in-track tie condition
- **Freeze/thaw performance**
(Kansas State University, UIUC, CXT, UP)
 - Industry standards for freeze/thaw testing of whole ties
 - Investigation of design and construction variables affecting freeze/thaw performance

Cost & Schedule

- Research Investment 2010 – 2014: \$7M
- <http://www.fra.dot.gov/eLib/details/L04792>
- <https://www.fra.dot.gov/eLib/details/L05317>
- <http://www.fra.dot.gov/eLib/details/L04284>

FRA Project Manager

Cameron Stuart, (202) 493-6384, Cameron.Stuart@dot.gov

Concrete Tie Failure Mechanism



Railroad Impact

- Concrete tie and fastener failure in track either increases life cycle costs or leads to derailment accidents
- Improved design and test standards will result in products with greater safety performance in railroad tracks
- Failure types of immediate safety concerns will be identified, and failure criterion determined
- Improved inspection technology will timely detect and differentiate tie and fastener failure and help the formulation of safety solutions

Project Description

- Understand the basic mechanisms of main failure modes of ties and fasteners
- Improve design and test standards (AREMA, ASTM, PCI, etc.)
- Improve inspection technologies for tie and fastener failure
- Provide a scientific basis for the FRA Track Safety Standard Crosstie Section

Project Partner(s)

- Volpe Center
- Kansas State University
- University of Illinois at Urbana-Champaign

Cost & Schedule

- \$390k for 12 months

FRA Project Manager

Cameron Stuart, (202) 493-6384, Cameron.Stuart@dot.gov

Autonomous Track Geometry Measurement System (ATGMS)



Railroad Impact

- Continuous, un-manned geometry data collection provides critical track data in real-time wherever the system(s) are deployed.
- No impact on rail traffic operations. The system can be installed on normal revenue railcars or locomotives and run in consist.
- Track testing is automatically scheduled based on normal operation of the vehicle.
- ATGMS provides a reduction in complexity, size, and cost of traditional geometry systems without compromising performance.

Project Description

- Development Plan for FRA ATGMS research program:
 - Stage 1: Long-Term Pilot to Establish Baseline Performance
 - Stage 2: Revenue Operations Simulation Test
 - Stage 3: Develop Advanced Measurement Technology
 - Stage 4: Develop Energy Harvesting Technology
 - Stage 5: Demonstrate in Freight Service: currently constructing a solar powered, freight car-based system that will operate in revenue trains. Technology demonstration on short line railroads planned for mid-2015.

Project Partner(s)

- ENSCO Inc.

Cost & Schedule

- Research Investment 2000 – 2014: \$4M

FRA Project Manager

Cameron Stuart, (202) 493-6384, Cameron.Stuart@dot.gov

Heavy Axle Load (HAL) Revenue Service Testing



Railroad Impact

- Better understanding of the effects of HAL on railway infrastructure and root causes of HAL-related problems
- Mitigate adverse effects of HAL on track degradation and improve operational safety
- Safer, more efficient and reliable infrastructure for heavy-haul lines

Project Description

- HAL revenue service testing provides an opportunity to evaluate:
 - New & alternative track component designs & materials
 - Improved track maintenance procedures
- Experiments consolidated within western & eastern mega sites
- Provides wider range of track, operational, & climatic conditions under which to evaluate performance

Project Partner(s)

- Transportation Technology Center, Inc. (TTCI)
- Association of American Railroads (AAR)

Cost & Schedule

- 2005 - Present:
 - Premium rail performance & rail life extension strategies
 - Special application of alternative crosstie designs
 - Improved welding strategies & performance monitoring
 - Special track work including frogs and joints
 - Bridge approach remedies
 - Track substructure
- Total FRA Funding: \$700k

FRA Project Manager

Luis Maal, (719) 584-0551, luis.maal@dot.gov

Investigation of Slab Track – Performance and Serviceability



Railroad Impact

- Knowledge of slab track behavior under heavy axle loads
- Knowledge of behavior of track material used in slab track but also usable in other track applications

Project Description

- The slab track section on the High Tonnage Loop at the Transportation Technology Center has been removed after 10 years of testing and monitoring. In conjunction with the demolition of the slab, an assessment of the components of the slab track was considered warranted to evaluate general performance of the entire slab track system.

Project Partner(s)

- PCA (Portland Cement Association)

Cost & Schedule

- 2014 Demolition of slab and investigation of components
- 2015 Final report
- Total FRA cost \$60k

FRA Project Manager

Luis Maal, (719) 584-0551, luis.maal@dot.gov

Evaluation of Wheel/Rail Contact Mechanics

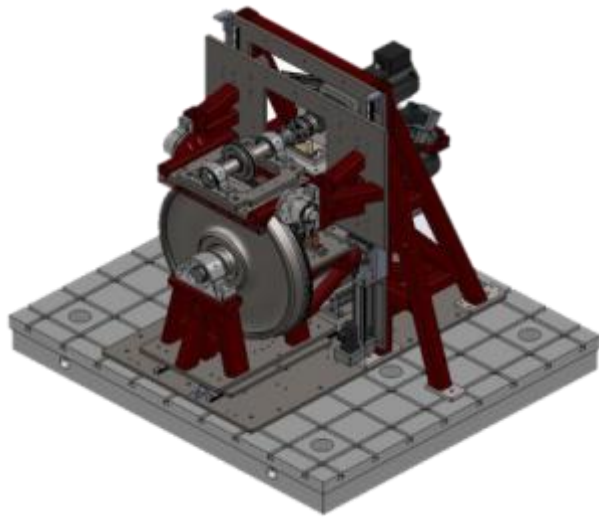

Railroad Impact

- Understanding the complex mechanics and dynamics that occur at the wheel-rail interface is critical for improving railway operational safety and efficiency
- Provide the capability to more accurately measure the critical forces, moments, and displacements that are necessary for rail vehicle modeling and engineering analysis for both passenger and freight trains, far beyond the means currently available to the FRA and rail industry

Project Description

- Design a wheel/rail contact mechanics evaluation test rig that can be used for the needs of both freight and passenger trains
- Provide the means for thorough understanding of the mechanics and dynamics associated with the wheel/rail interaction, under conditions that can be scientifically related to train operation
- Provide the means for measuring the parameters that are necessary for practical evaluations that are of interest to the FRA and U.S. rail industry

Project Partner(s)

- Virginia Tech
- Norfolk Southern Railroad

Cost & Schedule

- System integration and facility improvements to ensure long-term and cost effective operation of the test rig
- Assembly of the rig, and calibrate/regulate components and subsystems
- Commission the rig and start gathering/analyzing the experimental data
- Project Duration: 15 months; Budget: \$450k

FRA Project Manager

Ali Tajaddini, PE, (202) 493-6438, Ali.Tajaddini@dot.gov

International Collaborative Research Initiative on Wear and Fatigue of Rails and Wheels



Railroad Impact

- RCF and wear cost the rail industry billions of dollars each year as a result of associated rail and wheel replacements, derailments, work stoppages, inspection and maintenance.
- This ICRI exists to identify and solve wheel/rail problems and advance technology developments that will improve safety and maintenance of railways.
- The ICRI model is an efficient and economical way of undertaking research by pooling resources, leveraging work already underway, accessing test equipment and sharing field results promptly.

Project Description

- There is work going on all around the world which, if coordinated and made available publicly, could significantly improve understanding and modeling, and speed the development of an effective methodology for minimizing losses associated with rolling contact fatigue and wear.
- This group undertake joint research on wear and fatigue of rails and wheels. Teams are working on "Quantifying the Magic Wear Rate", "Friction Modelling", "Wheel Damage", "Quantifying Surface Damage"

Project Partner(s)

- National Research Council, Canada
- Transport Canada

Cost & Schedule

Coordinating ICRI

- Annual funding of 50k is being matched by funding from Canadian organizations (Transport Canada, CP Rail and NRC Canada).

FRA Project Manager

Ali Tajaddini, PE, (202) 493-6438, Ali.Tajaddini@dot.gov

Adjustable Precision Track Anomaly Test Section



Railroad Impact

- Track geometry testing is a critical function for safety and operations of railroads, especially for high speed passenger trains.
- For high speed passenger rail, the track anomaly test section will provide a unique testing platform where vehicle-track interaction modeling simulations can be validated and existing and new technologies can be tested.
- This Track section can be used to validate a track geometry measurement system.

Project Description

- Track geometry measurement validation and vehicle-track interaction testing are critical functions for safety and operations of railroads, especially for high speed passenger trains.
- This project will design and construct a test track section on the high speed test track at FRA's Transportation Technology Center where geometric track anomalies can be installed and adjusted.

Project Partner(s)

- Transportation Technology Center, Inc.

Cost & Schedule

- Design and build the track section
- Commissioning of the track
- Total cost of the project \$1.0M

FRA Project Manager

Ali Tajaddini, PE, (202) 493-6438, Ali.Tajaddini@dot.gov

Improvements to FRA Track Geometry Data for Use in Simulations

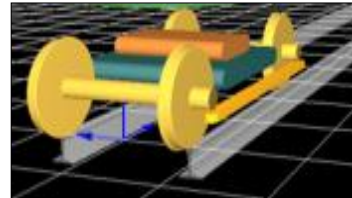
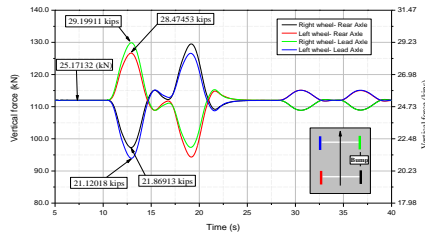
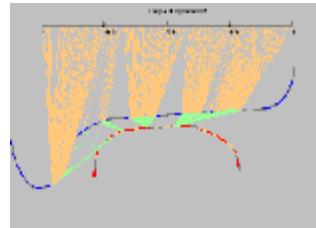
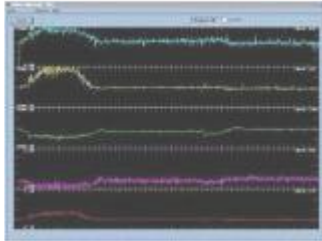

Railroad Impact

- The use of vehicle dynamics simulations in the assurance of rail safety is more prevalent than ever before.
- Recent FRA safety standards require the use of computer simulations during the vehicle qualification process.
- This effort will provide a tool that will allow all researchers relying on FRA-collected track data to improve the inputs to dynamic simulations to maximize the quality of simulations that are at the center of many safety performance evaluations.

Project Description

- Development of off-line applications dedicated to addressing track geometry and rail profile (contour) data quality issues that impact data used in vehicle dynamics simulation work.
- Offline applications will be developed to allow researchers to produce track data over particular areas of interest, remove numerical artifacts that can impact data quality, specify critical wavelengths to improve the representation of the track in multi-body simulation codes.

Project Partner(s)

- EnSCO Inc., Volpe Center

Cost & Schedule

- Development of off-line tool to improve track geometry measurement data employed by multi-body simulation codes;
- Enhancement of off-line utilities to provide for improved rail profile (contour) data used in many numerical studies
- Total cost of \$150k

FRA Project Manager

Ali Tajaddini, PE, (202) 493-6438, Ali.Tajaddini@dot.gov

Rolling Load Test machine for Rolling Contact Fatigue Research

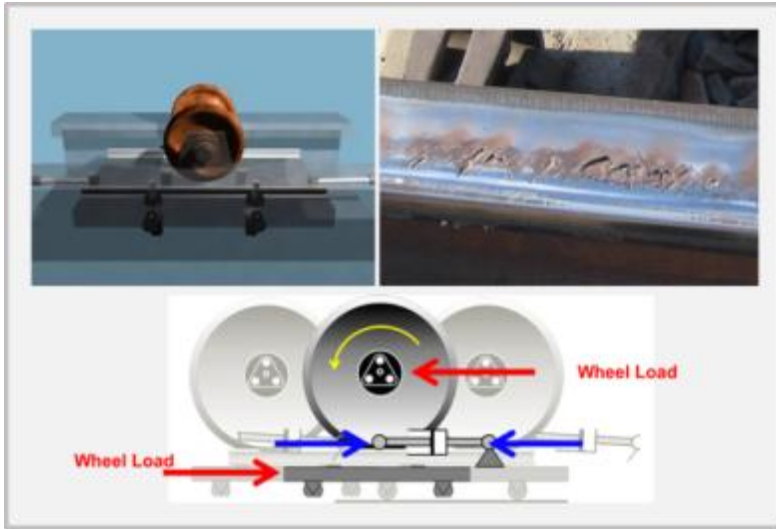

Railroad Impact

- Results will lead to the reduction of RCF through optimization of wheel and rail materials, profiles, and maintenance procedures.
- High speed passenger operation with RCF has been found to lead to rail failure and this research will help prevent it.
- RCF may contribute to shattered and vertical split rims; it may also mask deeper seated cracks in rail from ultrasonic detection and this research will help prevent them

Project Description

- Acquisition support and utilization of a Rolling Load Test Machine (RLTM) for the assessment of the root causes of rolling contact fatigue (RCF) to be installed at TTC
- This facility will be capable of testing full scale, standard-gauged freight and passenger wheelsets and rails under current and anticipated future load conditions with precisely controlled variables.
- Root cause of rolling contact fatigue will be studied

Project Partner(s)

- Transportation Technology Center, Inc.

Cost & Schedule

- Jointly funded by FRA and TTCI
- FRA funding is \$1.5M
- Design has been completed
- Construction to be finished by end of 2014
- Acceptance and testing to begin in Spring 2015

FRA Project Manager

Ali Tajaddini, PE, (202) 493-6438, Ali.Tajaddini@dot.gov

Heavy Point Frog Performance

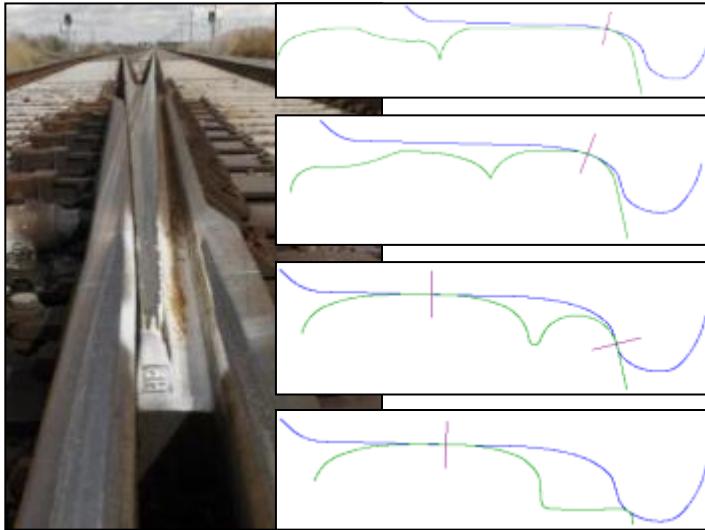

Railroad Impact

- This research will provide results and findings for heavy point frog (HPF) performance with passenger equipment traveling at speed up to 110 mph.
- This research will provide results and findings concerning the assessment of potential derailment risks and dynamic effects of heavy point frogs.

Project Description

- The aim of this research is to investigate how the heavy point frog (HPF) will perform in operations up to 110 mph and if there is any risk of derailments of passenger equipment.

Project Partner(s)

- Transportation Technology Center, Inc.

Cost & Schedule

- Model mainline operations on HPF for higher speed operations from 60 to 110 mph
- Use FRA VTI safety criteria to examine the safety of the equipment based on simulation results.
- Present comprehensive summary of key findings regarding heavy point frog and how it relates to vehicle performance
- Total cost \$150k

FRA Project Manager

Ali Tajaddini, PE, (202) 493-6438, Ali.Tajaddini@dot.gov

Joint Bar Study

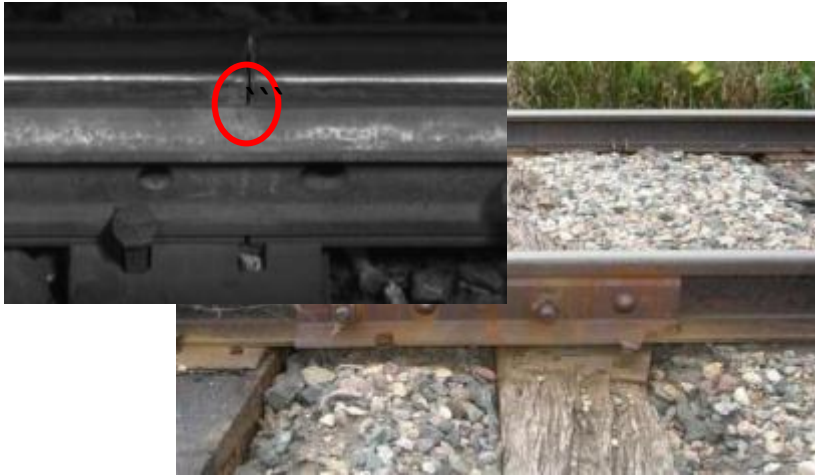

Railroad Impact

- Broken joint bars have been identified as one of major causes of main line derailments in US .
- A complete understanding of the role of all contributing factors to failed joint bars continues to allude the railroad industry.
- By documenting and understanding track and track component conditions surrounding failed joints, railroads will be better able to identify structurally compromised joints, which are likely to fail

Project Description

- Using FRA's Failed Joint Fracture Report, create a document/log for recording all pertinent conditions and information surrounding failed (broken) joint bars.
- Attend Joint Bar Inspection Surveys to collect data as part of the normal production operation of a Class I Railroad .Document the conditions surrounding each failed joint.
- Analyze data at the conclusion of the data collection for trending information on conditions surrounding failed joints.

Project Partner(s)

- EnSCO, Inc., Transportation Technology Center, Inc.

Cost & Schedule

- Preparation of field survey/test plans, conducting field surveys and an analysis of the collected data, reporting on the findings.
- conducting additional field surveys and an analysis of the collected data, reporting on the findings.
- Total Cost - \$300k

FRA Project Manager

Ali Tajaddini, PE, (202) 493-6438, Ali.Tajaddini@dot.gov

Vehicle-Track Interaction (VTI) Testing, Modeling and Analysis

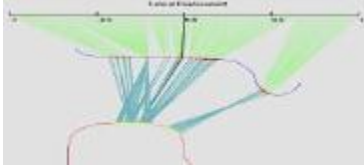
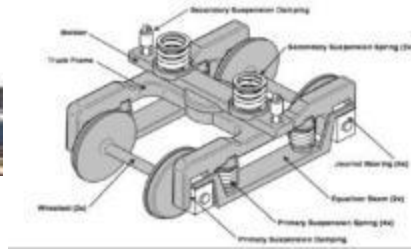

Railroad Impact

- Reduce derailment risk, track degradation, vehicle wear or damage, lading damage and passenger discomfort;
- Establish performance-based track geometry tolerances and vehicle design parameters that ensure safety and maximize effective and efficient use of maintenance resources;
- Move goods and passengers at higher speeds and more efficiently.

Project Description

- Provide support in modeling, simulation, test, data collection and analyses of VTI related issues; understand the mechanics, evaluate current track geometry standards, and improve and verify the accuracy of vehicle dynamics modeling in predicting forces and accelerations exerted on wheel and rail;
- Determine the influence of track geometry characteristics and vehicle speeds on extreme lateral and vertical dynamic forces and accelerations that can potentially lead to derailment or compromise passenger safety.

Project Partner(s)

- Ensco, Inc.

Cost & Schedule

- Establish VTI models and dynamic modeling/ simulation program for practical applications; research VTI and wheel/rail interface issues for high speed rail/high cant deficiency initiatives; improve methods of VTI inspection and data reporting
- Identify improvements to measured track geometry data for simulations; evaluate vehicle responses to track geometry deviations; evaluate dynamic models for train handling
- validate/update high speed rail vehicle dynamic simulation tools; evaluate vehicle responses to track geometry deviations; assess existing track geometry standards \$750k

FRA Project Manager

Ali Tajaddini, PE, (202) 493-6438, Ali.Tajaddini@dot.gov

Vehicle Modeling and Validation

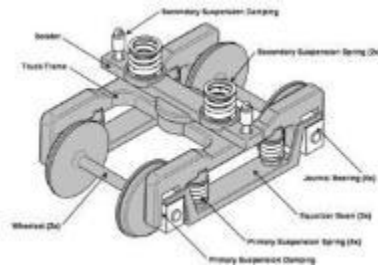
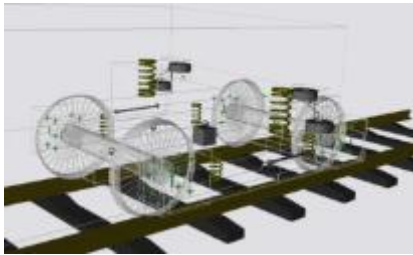

Railroad Impact

- Establish a low-cost method to derive the required parameter values for modeling a railroad vehicle.
- Increase confidence in modeling railroad vehicles by developing a validated model and compare the predicted results with measured wheel/rail forces.
- Support the new FRA Safety Standards that requires modeling for approving railroad vehicles.

Project Description

- Develop a method that can be used to derive the required parameter values for modeling of railroad.
- Use the developed method to determine the design and off-design parameter values.
- Develop a validated model using the proposed method.
- Establish the degree of confidence and accuracy of a developed vehicle model that is based on using the proposed method to derive the railroad vehicle characterization.

Project Partner(s)

- Enesco, Inc.

Cost & Schedule

- Develop a methodology for characterizing a railroad vehicle, building and validating a vehicle model
- Create a validated model
- Cost: \$400k

FRA Project Manager

Ali Tajaddini, PE, (202) 493-6438, Ali.Tajaddini@dot.gov

Track Geometry and Vehicle Performance

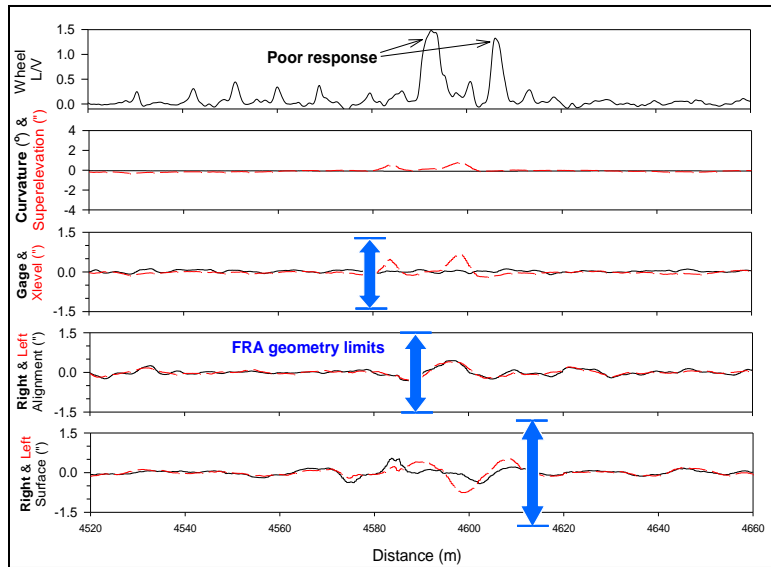

Railroad Impact

- Findings from the literature review and past studies can point out possible issues and root causes of poor vehicle performance due to track geometry
- Simulation results and findings can be used by the FRA and the railroad industry to refine track geometry limits for safer vehicle/track interaction in revenue service
- The state-of-the-art NUCARS® models can be used by the railroad industry in future simulation studies geared towards performance-based track geometry limits for safe operations

Project Description

- Investigate how track geometry parameters, individuals as well as combinations of them, affect freight vehicle dynamic performance
- Develop models for five freight vehicles. Different track deviation combinations over various track classes and features will be used in the simulation work for each vehicle type.

Project Partner(s)

- Transportation Technology Center, Inc.

Cost & Schedule

- Literature Survey
- Making model of cars
- Simulation over single and combined geometry
- Final report
- Total cost of \$150k

FRA Project Manager

Ali Tajaddini, PE, (202) 493-6438, Ali.Tajaddini@dot.gov

Atlas of Rail Surface Fatigue



Railroad Impact

- Improved, more reliable and more effective management of rail surface condition.
- Reduction in surface initiated defects that lead to broken rails and some derailments
- Supports proactive, preventive rail maintenance regime through automated surface condition assessment
- Extend rail life and reliability

Project Description

- A previous review identified that one of the most promising and important opportunities relates to the monitoring of RCF. Whether it be through interpretation of yet to be developed machine vision systems, or through eddy current measurements, there is a strong need to translate surface appearance to damage, or crack length to depth, respectively.
- Develop an atlas of rail surface fatigue that categorizes rail RCF according to features, operating conditions and growth rates.

Project Partner(s)

- National Research Council Canada
- LORAM, Class I freight Railroads

Cost & Schedule

- Year 1: Field work to validate MRX, Rohmann and Sperry crack measuring systems. Measure/monitor RCF development on the CP Paynesville subdivision.
- Year 2: Include Sperry in the measurement program. Continue field monitoring. Start to assemble data into document. Preliminary correlations.
- Year 3 : Correlation and analysis of data, reporting and dissemination.
- Total cost of \$450k

FRA Project Manager

Ali Tajaddini, PE, (202) 493-6438, Ali.Tajaddini@dot.gov

Coil Spring Characterization and Modeling

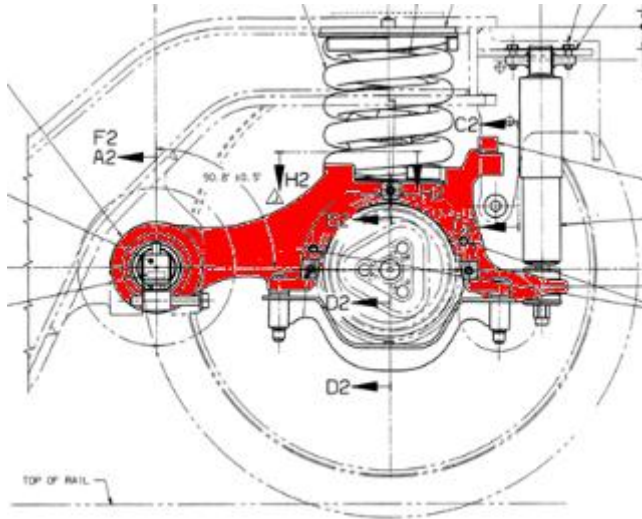

Railroad Impact

- Provide guidelines how to measure Spring properties
- Provide information on how to model springs in multibody simulation program

Project Description

- Procure a multiaxial test machine to test suspension springs under various loading conditions
- First phase is to procure the test machine then,
- Measure the axial, shear, and torsional stiffness of the spring
- Study the best practice for modeling suspension springs in the trucks
- Investigate the need for modifications in the methods that the springs are modeled in multibody simulation programs

Project Partner(s)

- Volpe Center, Zwick

Cost & Schedule

- Phase I: Procure the test machine: \$500k
- Phase II: Perform testing to characterize springs: \$200k

FRA Project Manager

Ali Tajaddini, PE, (202) 493-6438, Ali.Tajaddini@dot.gov



Section 2

Rolling Stock

Passenger Equipment Structural Crashworthiness

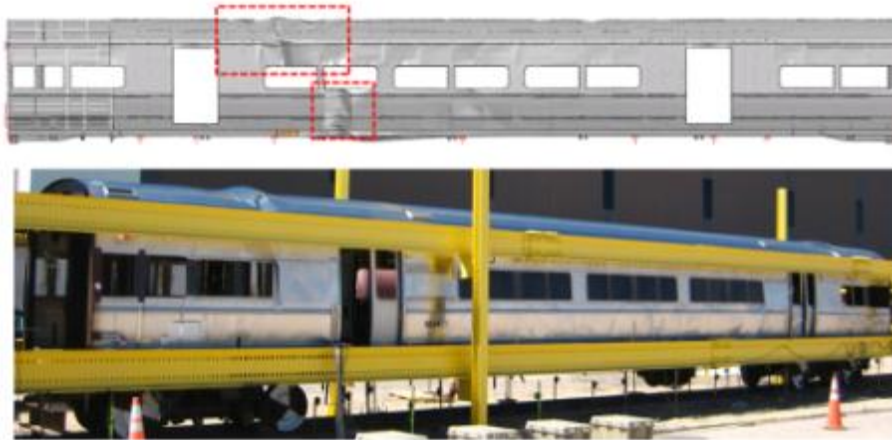

Railroad Impact

- The current longitudinal loading requirement for passenger cars requires the structure to experience no permanent deformation while an 800,000 pound load is placed along the line of draft
- NPRM under development contains alternative OVI requirements that are applicable to passenger cars designed to alternate standards
- The alternative requirements move the evaluation load from the line of draft to the collision load path, permit evaluation of the structural capacity of car according to one of three loading conditions and pass/fail criteria, and permit a combination of elastic testing and elastic/plastic analysis to be used in demonstrating OVI
- Development of techniques for demonstrating compliance with the requirements and conducting assessments of the results of those analyses assist FRA in ensuring that passenger vehicles achieve sufficient occupied volume strength

Project Description

- The goal of the passenger equipment safety research program is to develop design strategies for improving the structural crashworthiness of passenger railcars relative to existing designs.
- Data and information derived from this research are used in the development of specifications and regulations, and to support various waiver requests and evaluations of compliance with FRA regulations
- Occupied Volume Integrity (OVI) describes the ability of a passenger railcar to support a large longitudinal load without compromising the space occupied by passengers and crew.
- Program focus is on developing reliable techniques for the timely evaluation of the structural crashworthiness of a passenger railcar's OVI using a combination of testing and analysis

Project Partner(s)

- Volpe Center

Cost & Schedule

- Presentation of ASME paper on crippling test and analysis: April 2014.
- FRA report on overall testing program: March 2014 (draft), March 2015 (publication).
- Technical Report on 1- and 2-car CEM Tests - "Crash Energy Management One and Two-Car Passenger Rail Impact Tests", August 15, 2014
- **Funding level:** \$25k

FRA Project Manager

Jeff Gordon, (617) 494-2303, jeffrey.gordon@dot.gov



Moving America Forward



Locomotive Structural Crashworthiness



Railroad Impact

- Locomotives, because of their great longitudinal strength and stiffness, are particularly susceptible to override when they collide with another vehicle, and the consequences can be catastrophic
- Research has shown that conventional anti-climbing structures can deform on impact and form a ramp, increasing the likelihood of override
- Such behavior was exhibited in a 23-mph collision that occurred in Red Oak, Iowa on April 17, 2011 (photo)
- Research has also shown that the addition of modest structural features to the forward end of a locomotive can greatly reduce the propensity for override

Project Description

- Research will demonstrate effectiveness of crashworthy components in preventing override of locomotives by impacted equipment in a collision
- The performance of the combination of a push-back coupler and deformable anti-climber will be evaluated under full-scale dynamic impact scenarios
- Components are to be re-designed as a retrofit to existing locomotives
- Individual component testing has been performed to demonstrate performance and develop technical information to inform finite element modeling
- Routine coupling tests to be performed to develop range of expected impact forces and characterize behavior
- Activities to also include evaluation of iso-cab designs and locomotive crashworthiness standards

Project Partner(s)

- Volpe Center, TTCI, TIAX, Canarail

Cost & Schedule

- FRA Report on Component Re-designs, December 2014
- ASME Paper on Component Re-designs, April 2015
- Summary Report on Coupling Tests, July 2015
- Funding level: \$480k

FRA Project Manager

Jeff Gordon, (617) 494-2303, jeffrey.gordon@dot.gov



Moving America Forward



Interior Occupant Protection



Railroad Impact

- Impacts with fixed workstation tables can cause significant abdominal injuries to passengers
- Both the UK and US have safety standards for workstation tables that rely on ATDs that are capable of assessing abdominal injury – in partnership with UK researchers, costs to improve the H3RS ATD can be shared
- Planned parametric studies form the basis to develop a globally acceptable test device which would present an opportunity to exploit advances in ATD instrumentation since the ATD was first developed (ca. 2002)

Project Description

- FRA performed research to develop an industry safety standard to address the crashworthiness of workstation tables in passenger rail cars
- The safety standard requires dynamic sled testing with an advanced ATD to evaluate abdominal injuries
- The H3RS ATD was developed in the UK specifically to assess abdominal injuries due to impacts with tables in trains
- Further ATD research and development is necessary to improve the biofidelity, reliability, and repeatability of the performance of the H3RS ATD
- Additional activities include development of a simulation model representative of the H3RS ATD and a study to identify additional interior arrangements prone to cause occupant injury

Project Partner(s)

- Volpe Center, Rail Safety and Standards Board (UK), Transportation Research Laboratory (UK)

Cost & Schedule

- Develop test requirements for parametric impact tests to evaluate the H3RS abdominal instrumentation, September 30, 2014.
- MADYMO model of H3RS ATD, validated with 2012 sled test data, November 19, 2014.
- MADYMO model of H3RS ATD, validated with parametric test data (and 2015 sled test data, if conducted), March 12, 2015.
- Test Report on parametric testing (and 2015 sled tests, if conducted), March 12, 2015.
- Funding level: \$160k

FRA Project Manager

Jeff Gordon, (617) 494-2303, jeffrey.gordon@dot.gov

Field Investigations



Railroad Impact

- Passenger equipment safety research program areas of focus cannot be developed absent information derived from real-world conditions
- Field investigations of actual accidents can assist in identifying deficiencies related to equipment performance and operating practices
- Program direction is tuned based on the findings of the field investigations to ensure maximum application and effectiveness of research results

Project Description

- Accident investigations are conducted at the request of the FRA
- Activities include documenting the damage to the equipment (both interior and exterior), reconstructing the sequence of events and identifying causal mechanisms for injury and fatality
- Findings serve to assess the current performance of rail equipment, interiors, emergency egress, fuel tank integrity and other safety features
- A technical presentation of the field investigation is produced from the preliminary findings
- A technical report or paper is written from the technical presentation and reconstruction of the field investigations

Project Partner(s)

- Volpe Center

Cost & Schedule

- Accident investigations have been performed for: Lake City, SC in August 2000; Nodaway, IA in March 2001; Crescent City, FL in April 2002; Placentia, CA in April 2002; Kensington, MD in July 2002; Flora, MS in April 2004; Glendale, CA in January 2005; Chicago, IL in September 2005; Chicago, IL in November 2007; Chatsworth, CA in 2008; Red Oak, IA in April 2011; Lovelock, NV in 2011; Goodwell, OK in June 2012; Bridgeport, CT in May 2013; and Spuyten Duyvill, NY in Dec 2013.
- Funding level: \$40k

FRA Project Manager

Jeff Gordon, (617) 494-2303, jeffrey.gordon@dot.gov

Regulatory Development, Waiver Support and Technology Transfer



Railroad Impact

- FRA R&D has been supporting rail equipment standards development since the advancement of Amtrak's technical specification for the Acela in 1993
- These requirements evolved into FRA's Tier II equipment standards, the first national standards requiring Crash Energy Management
- Additional standards supported include the Passenger Equipment Safety Standards, the Locomotive Crashworthiness Standards, and the Cab Car End Frame Standards.
- FRA Research and Development is currently supporting development of crashworthiness standards for high speed passenger trains, revisions to safety standards for conventional speed passenger trains, and revisions to safety standards for high-speed passenger trains used in mixed service

Project Partner(s)

- Volpe Center



Moving America Forward

Project Description

- The overall program goal is to advance and enhance technologies for rail equipment safety and facilitate their implementation in the railroad industry
- This work applies the research results from all program activities to increase safety, efficiency and effectiveness of federal regulations, help drive down life-cycle costs, and create consistent safety standards world-wide, so that foreign train designs require minimal adaptation for domestic use
- Focus is on identification of safety concerns, safety strategies for mitigating the concerns, and the information needed to explain and apply new technology:
 - definition of accident scenarios of concern and assessment of likelihood and loss from accidents
 - identification of technologies for improved occupied volume protection, injury prevention, fuel containment, and glazing impact resistance
 - application of information derived to support policy decisions and standards development, and verification of required performance.

Cost & Schedule

- Editing and commenting on Notice of Proposed Rulemaking for High Speed Passenger train crashworthiness: September 1, 2014
- Editing and commenting on Addendum A: Suggested Practices - Technical Criteria and Procedures for Evaluating the Crashworthiness and Occupant Protection Performance of Alternatively-Designed Passenger Rail Equipment for Use in Tier I Service: September 1, 2014
- Draft regulations for alternatively designed single locomotives and single cab cars for use in Tier I service: August 1, 2014
- Draft regulations for alternatively designed single coach cars for use in Tier I service: August 1, 2014
- Funding level: \$100k

FRA Project Manager

Jeff Gordon, (617) 494-2303, jeffrey.gordon@dot.gov



U.S. Department
of Transportation

Federal Railroad
Administration

Vehicle-Track Interaction Research



Railroad Impact

- The vehicle's suspension system has a significant effect on the ability to provide safe motion of equipment along the track over which it operates
- Suspension systems should be designed to control and damp the motions of both the sprung and unsprung masses to ensure the vehicle remains on the track, the vehicle motions are stable, the effects of irregularities in track geometry are filtered out to provide ride quality within acceptable limits, and wayside clearances are met
- As components of the suspension system degrade or fail, unsafe operating conditions may develop
- Track Safety Standards require vehicles to be qualified per § 213.345 in order to demonstrate safe operation for various track conditions, but these requirements are limited and examine the performance of the vehicle and its suspension in new or near new condition

Project Description

- Technical support and coordination are provided to develop regulations and industry standards to promote the safe interaction of rail vehicles with the track over which they operate
- Technical support includes conducting analyses, simulation studies designed to examine vehicle response to track geometry irregularities, reviews of vehicle qualification and revenue service test data, and consideration of international practices focusing on the following:
 - Development of Tier III regulations in support of ETF II Inspection, Testing and Maintenance (ITM) and Trackworthiness Working Groups
 - Revision/update of APTA Standards including the Truck Equalization Standard
 - Support of PRIIA Specification Development Efforts
 - Development of methods for condition monitoring and inspection of critical suspension components
 - Specification of vehicle curving performance

Project Partner(s)

- Volpe Center

Cost & Schedule

- Summary report on Tier III and APTA Safety Standards development
- Summary report on methods for condition monitoring and inspection of critical suspension components and specification for vehicle curving performance
- Funding level: \$100k

FRA Project Manager

Jeff Gordon, (617) 494-2303, jeffrey.gordon@dot.gov

Fire Safety Research

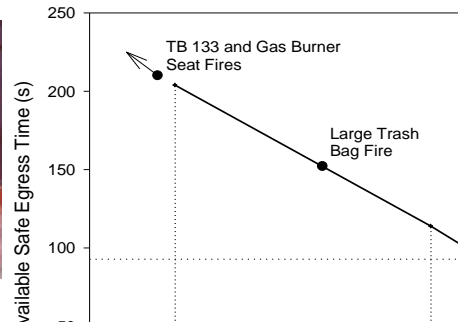

Railroad Impact

- Provide objective minimum criteria for meeting FRA regulations and industry standards for new and existing passenger equipment
- Continue to expand systems approach for passenger rail car design to evaluate fire safety beyond current emphasis on materials
- Provide cost-effective test alternative based on Heat Release Rate to existing flammability and smoke emissions requirements

Project Description

- Support rulemaking activities associated with Fire Safety and emergency preparedness
 - The research project is currently aimed at developing a fire growth model that will interface with time-based performance egress standards.
 - Future work will focus on developing alternative fire safety standards based on the Heat Release Rate (HRR) of the various materials used in design of passenger rail cars
- Investigate and evaluate alternative strategies and technologies relating to evaluating passenger rail car fire safety performance.
- Provide sound technical basis for revising the content of FRA passenger train fire safety requirements.
- Interface with industry standards (APTA, NFPA)

Project Partner(s)

- Volpe Center

FRA Project Manager

Melissa Shurland, (202) 493-1316, melissa.shurland@dot.gov

Emergency Preparedness Research



Railroad Impact

- Provides objective minimum criteria for meeting FRA regulations and industry standards for new and existing passenger equipment
- Use systems approach for rail car emergency design to locate, reach, and operate emergency exits
- Provides a cost-effective alternative to electrical powered emergency lighting, signs, and path marking
- Reorganizes CFR to consolidate all emergency equipment to 238 to assist RR in following all regulations

Project Description

- Support the development of new regulations relating to emergency lighting, signage, and egress
- Investigate and evaluate alternative strategies and technologies relating to passenger rail system emergency preparedness
- Provide sound technical basis for revising the content of FRA passenger train emergency preparedness / equipment requirements
- Interface with industry to develop and revise APTA passenger rail equipment safety standards
- Determine feasibility of time-based performance based egress standards
- Determine impact of Amtrak Conductors on passenger safety

Project Partner(s)

- Volpe Center

FRA Project Manager

Melissa Shurland, (202) 493-1316, melissa.shurland@dot.gov

Biodiesel In Railroad Applications

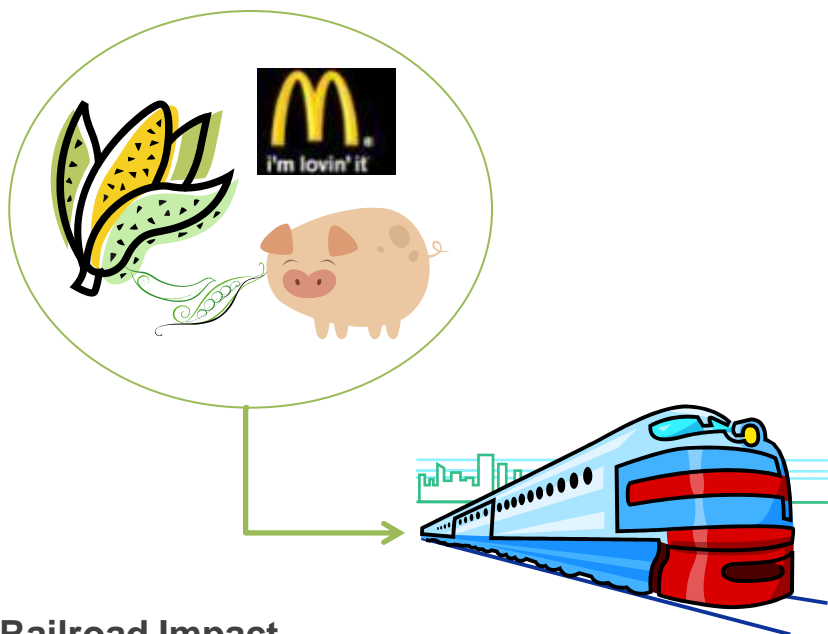

Railroad Impact

- Newly proposed US EPA regulation will require railroad to reduce the amount of greenhouse gases emitted from locomotive engines: Nitrogen Oxides (NO_x), Carbon Monoxide (CO), Hydrocarbons (HC) and Particle Matter (PM)
- The railroad industry is interested in alternative fuel and its capabilities
- Provides guidelines for the sustainable use of a renewable fuel source

Project Description

- This project focuses on determining the long term effects of using biodiesel in railroad equipment.
- The research is separated into the following subtasks:
 - Emissions testing of B5 and B20 biodiesel fuel in various models of locomotive engines
 - Engine Durability Assessment of B5 and B20 biodiesel in various models of locomotive engines
 - Railroad diesel fuel survey to assess homogeneity in fuel composition

Project Partner(s)

- Southwest Research, Inc., LMOA Fuel, Lube and Environmental Committee

FRA Project Manager

Melissa Shurland, (202) 493-1316, melissa.shurland@dot.gov

Locomotive Biofuel Study



Railroad Impact

- Newly proposed US EPA regulation will require railroad to reduce the amount of greenhouse gases emitted from locomotive engines: Nitrogen Oxides (NOx), Carbon Monoxide (CO), Hydrocarbons (HC) and Particle Matter (PM)
- The railroad industry is interested in alternative fuel and their capabilities
- Provides guidelines for the sustainable use of a renewable fuel source

Project Description

- This project intends to determine the extent to which freights railroads, Amtrak, and other passenger rail operators could use biofuel blends to power locomotives and other vehicles that currently operate on diesel fuel. Further, it aims to determine a “premium” blend of biofuel for rail vehicles. Focusing on comparing biofuels and diesel fuel for:
 - Energy intensity
 - Environmental effects
 - Emissions
 - Cost
 - Availability
 - Public benefits from biofuel use
 - Engine durability
 - Warranty specifications.

Project Partner(s)

- North Carolina State University

FRA Project Manager

Melissa Shurland, (202) 493-1316, melissa.shurland@dot.gov

Study of the Use of Bio-based Lubricant Technology



Project Description

- This project tests the feasibility of using readily biodegradable lubricants and greases in locomotive, rolling stock and other equipment by conducting a comparative study of bio-based and conventional greases. Specifically, it analyzes the following factors:
 - Lubricant Performance in a railroad environment
 - Health and safety
 - Environmental impact
 - Equipment performance

Railroad Impact

- Lubricants and greases that are used in rail equipment can come from biodegradable sources that are considered:
 - renewable
 - cost effective
 - Environmentally benign.

Project Partner(s)

- University of Northern Iowa, National Agriculture-based Lubricant Center

FRA Project Manager

Melissa Shurland, (202) 493-1316, melissa.shurland@dot.gov

Cost-Benefit Analyses of Electrification for Next Generation Freight and Passenger Rail Transportation

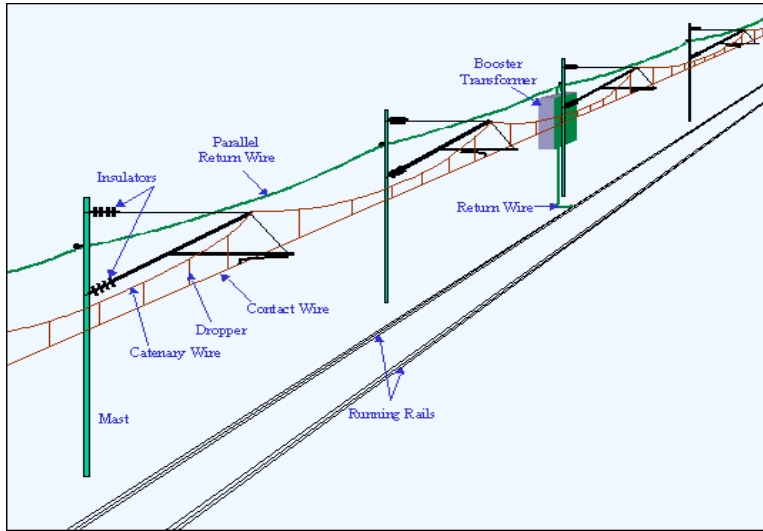

Railroad Impact

- Identification of innovative electrification technologies that would:
 - Improve railroad efficiency
 - Reduce emissions
 - Reduce costs

Project Description

- Electrification study to assess the costs and benefits of electrifying nation's rail transportation system
 - Investigate the costs, benefits, barriers, and mitigation strategies of electrification
 - Determine efficiency impact
 - Assess the emissions reduction of electrification.
 - Identify innovative technology that can reduce costs and improve performance

Project Partner(s)

- Booz Allen Hamilton

FRA Project Manager

Melissa Shurland, (202) 493-1316, melissa.shurland@dot.gov

Evaluation of the Displacement between Locomotive and Trailing Rail Vehicle (Simulated Natural Gas Tender)



Railroad Impact

- Improves the safety of rail transportation with the introduction of natural gas as a locomotive fuel
- Develops design specifications for interconnecting piping, hoses, and cables for natural gas locomotives

Project Description

- To assist in the safe design and testing of gas/liquid/electrical interconnections by analyzing the dynamic loading of interconnection between locomotive and natural gas tender.
 - Determine the tri-axial displacement, acceleration, and jerk environment between the locomotive and trailing (simulated tender) vehicle
 - Support development of equipment performance standard specification/test with railroad industry
 - Understanding the displacement environment between these two vehicles should enhance the effort to design and test the interconnecting equipment and result in improved performance and safety of those components

Project Partner(s)

- TTCI, Sharma & Associates

FRA Project Manager

Melissa Shurland, (202) 493-1316, melissa.shurland@dot.gov

Review of Codes, Standards, and Regulations for Natural Gas Locomotives



Railroad Impact

- Identifies existing standards, design codes, and regulations that can apply to new, natural gas locomotive systems
- Pinpoints gaps in current regulations relating to natural gas use in railroad environment

Project Description

- Review of codes, standards, and regulations for natural gas locomotive systems and components with the goal of identifying compliance with FRA regulations.
 - Develop a high level map of major natural gas fuelling sub-systems between the incoming gas pipeline and the natural gas locomotive.
 - Identify, collect, and summarize relevant global codes, standards, and regulations for natural gas rail applications
 - Create a summary matrix that relates identified codes, standards, and regulations to the selected sub-system categories
 - Identify gaps in the global codes, standards and regulations which will need to be addressed for implementation of natural gas as a fuel for rail

Project Partner(s)

- Ricardo, Inc.

FRA Project Manager

Melissa Shurland, (202) 493-1316, melissa.shurland@dot.gov

Accelerating Implementation of ECP Brake Technology

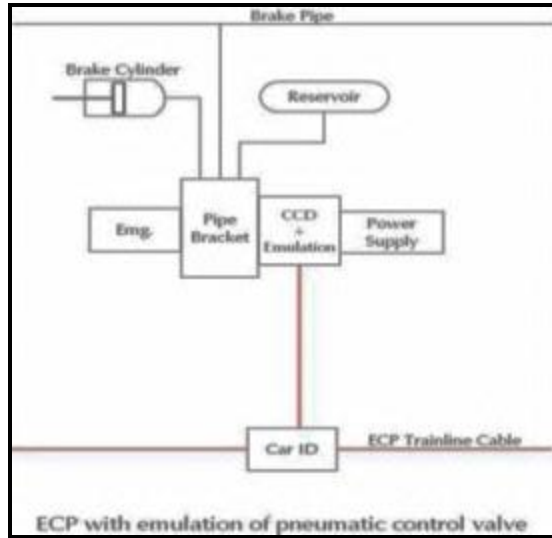

Railroad Impact

- Increased railroad operation safety due to more reliable and effective braking
- Higher average operating speed
- Increased line-haul speeds due to reduced terminal and in-service train delays
- Improved safety for both crew and public with better performance equipment

Project Description

- Assessment of available technology for their ability to accelerate the implementation of ECP brakes.
 - Conduct ECP emulator technology review to identify potential candidate(s) for accelerating the ECP implementation
 - Conduct cost-benefit analyses for the identified candidate emulators
 - Evaluate compatibility of the Zeftron emulator with existing equipment, AAR standards, and specifications
 - Modify the emulator design and develop test plans to take the emulator to prototype stage
 - Complete the required mechanical, electrical, and communication development work for technology compliance with existing industry standards
 - Develop plans and complete needed AAR/industry required compliance testing
 - Prepare a final development, test, and analysis report with recommendation for industry-wide implementation

Project Partner(s)

- Sharma & Associates

FRA Project Manager

Melissa Shurland, (202) 493-1316, melissa.shurland@dot.gov

Feasibility of Load-shedding to Improve Efficiency and Reduce Energy Consumption on Passenger Rail Vehicles

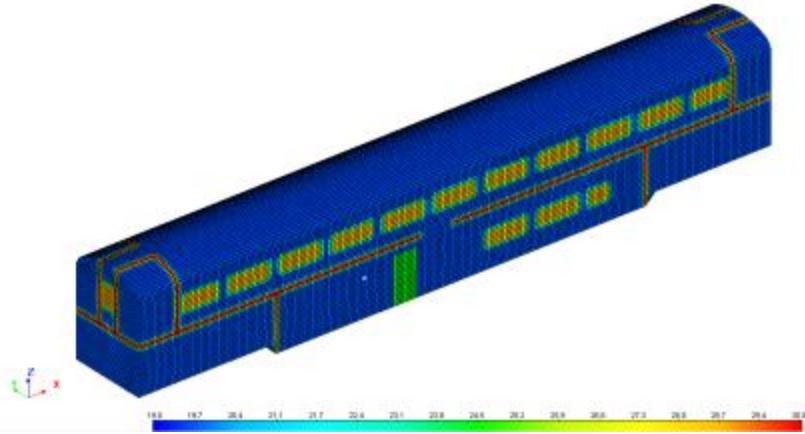

Project Description

- Investigate the energy savings and improved efficiency associated with the concept of load-shedding as a means of reducing the power draw from some components on the HEP system. The project will identify the impact of load shedding on:
 - Reduction of peak power demand of primer engine
 - Cooling capacity for railcars within the train
 - Performance and reliability of air conditioning components, such as compressors
 - Ambient noise level within passenger compartments
 - Reduction of life cycle costs
- Finally, it will determine barriers to implementation and how should they be overcome.

Railroad Impact

- Improves efficiency of passenger rail locomotives
- Reduces energy consumption
- Identifies innovative technologies

Project Partner(s)

- Sharma & Associates

FRA Project Manager

Melissa Shurland, (202) 493-1316, melissa.shurland@dot.gov

Fuel Tank Impact Test

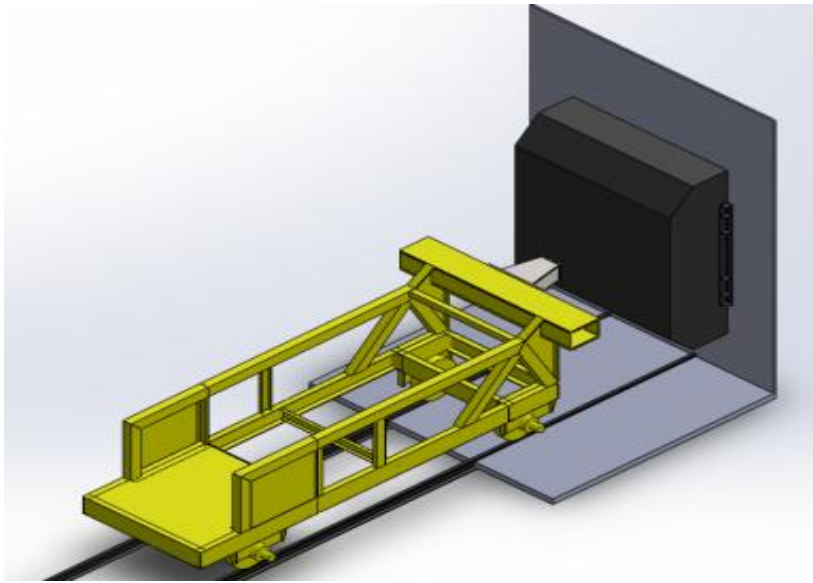

Railroad Impact

- Identification dynamic performance of passenger locomotive fuel tank
- Understand performance of DMU fuel tank
- Support development of guidance for alternatively designed passenger equipment fuel tank

Project Description

- This research focuses on evaluating dynamic impact conditions for passenger fuel tanks and investigating how fuel tank design features (such as baffle placement) affect the collision performance of the tank. Research activities include :
 - Analytical modeling of fuel tanks under dynamic loading conditions
 - Dynamic impact testing of fuel tank articles
 - Recommendations for improved fuel tank protection strategies

Project Partner(s)

- Transportation Technology Center Inc., Volpe Center

FRA Project Manager

Melissa Shurland, (202) 493-1316, melissa.shurland@dot.gov

Safety Assessment of Natural Gas Fueled Locomotives

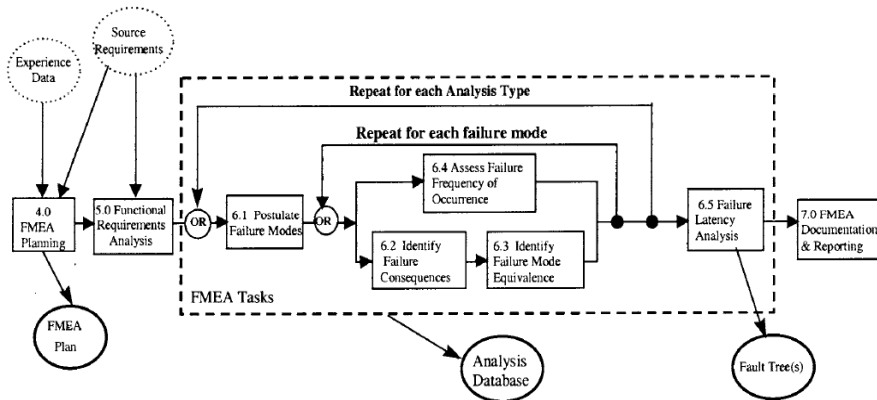

Project Description

- Support to the Federal Railroad Administration in review of industry submitted Failure Modes, Effects Analysis (FMEA)
- Identify methodology for evaluation of industry submitted FMEA and other safety assessment
- Development of informational brochure on natural gas fueled locomotives
- Aims to understand the safety of natural gas locomotive systems through:
- Identification of types of failures of natural gas system with potential for significant impact

Railroad Impact

- Identify standard industry accepted methodology for safety assessment of natural gas locomotive systems
- Identification of the risks associated with natural gas locomotive systems
- Improve design and safety of next generation natural gas locomotive systems

Project Partner(s)

- Sandia National Laboratories

FRA Project Manager

Melissa Shurland, (202) 493-1316, melissa.shurland@dot.gov

Evaluation of the Structural Integrity of Natural Gas Fuel Storage Equipment for Locomotives

Project Description

- Develop Crashworthiness Standards for LNG Tenders
 - Evaluate structural performance, puncture resistance, and fitting integrity with simplified analyses of legacy natural gas fuel tender
 - Apply results of simplified analyses to estimate performance in scenarios
 - Evaluate safe speeds in scenarios

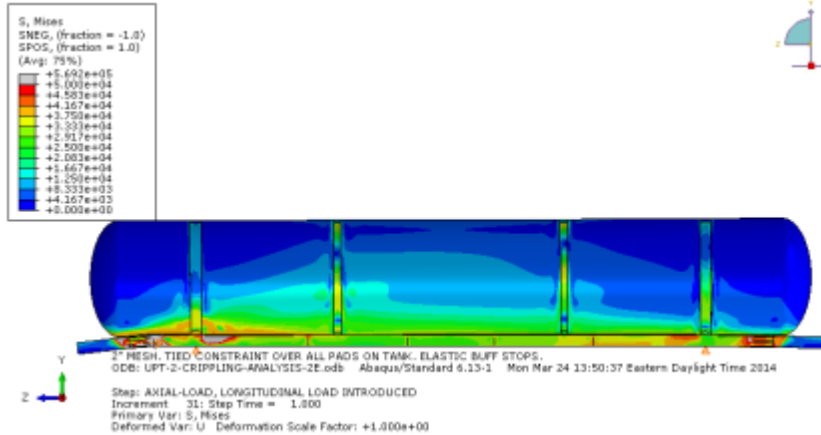

Railroad Impact

- Improve the state of the art of knowledge on natural gas fuel tenders and other storage equipment
- Assess crashworthiness of legacy natural gas fuel tenders
- Development strategies for structural analyses of next generation of natural gas fuel tenders
- Collaborate with railroad industry in development of specifications for next generation of natural gas fuel tender

Project Partner(s)

- Volpe Center

FRA Project Manager

Melissa Shurland, (202) 493-1316, melissa.shurland@dot.gov

Review of Battery Energy Storage Systems for Railroad Application



Railroad Impact

- Provide RR operators with easy to understand comparison of batteries
 - RR's will be able to compare benefits and risks advanced battery chemistries based on Class I and Commuter load profiles
 - Enable better decision making regarding near and long term capital investments
 - Support next phase development of ruggedized container for hybrid locomotive battery for testing and validation
 - Enable longer-term adoption of hybrid technology

Project Description

- Evaluate performance and safety of battery chemistries for locomotive use
 - Paper report with summary table to be made available to RR's to identify optimal battery system for hybrid locomotives
 - Model and evaluate battery chemistries for performance and safety vs. load profile for Class I and Commuter locomotives; and identify requirements for ruggedized battery system
 - Lead Acid, Pb-C, Ni-Cad, Ni Capacitor, NiMH, Li-ion

Project Partner(s)

- Saft, Inc.

FRA Project Manager

Melissa Shurland, (202) 493-1316, melissa.shurland@dot.gov

Hybrid (Battery Energy Storage System) Locomotive

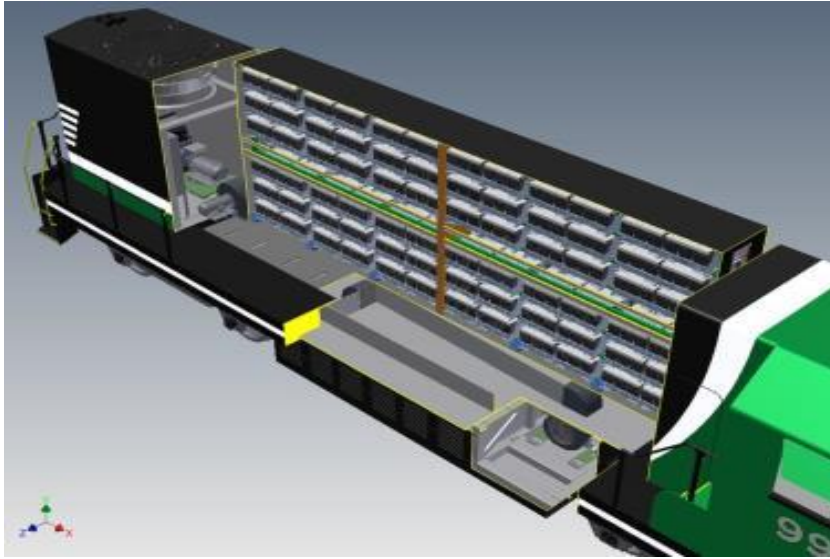

Railroad Impact

- Zero-emissions solution for rail transportation
 - Evaluations of battery energy storage systems to reduce emissions associated with rail transportation
- Identify deficiencies and solutions for various battery technologies for rail transportation

Project Description

- Norfolk Southern Railroad S is developing a prototype electric switching locomotive (NS 999) powered by a lead-carbon battery based Energy Storage System (ESS).
- The ESS batteries, arranged in strings of 54 12 V batteries (~ 650 VDC), will be charged via wayside power and through onboard regenerative braking energy. A battery management system (BMS) monitors battery temperature, voltage, and current. The BMS system provides for active equalization of individual batteries across the strings with the ability to isolate batteries if parameters exceed preset safety thresholds. The electric switcher is the first step toward developing a locomotive energy storage system capable of recovering dynamic braking energy from line-of-road freight operations. Work under this grant focuses on addressing several shortcomings identified from the initial NS 999 field trials including redesign of the Battery Management System, exploration of alternative battery technologies and repackaging of the energy storage system to improve battery maintenance practices.

Project Partner(s)

- Norfolk Southern Corporation

FRA Project Manager

Melissa Shurland, (202) 493-1316, melissa.shurland@dot.gov

Investigation of an Anti-knock Index and Hydrocarbon Emissions of Natural Gas Blends



Project Description

- Fuel specification to limit the variation in knock index, hydrocarbon emissions and heating value is needed for natural gas-fueled locomotives
- Development of a non-proprietary natural gas anti-knock index through modeling and regression analysis of fuel test data to determine knock index curve
- Determination of hydrocarbon emissions effects of various blend of natural gas

Railroad Impact

- Facilitation of a robust solution for understanding fuel specification needs for natural gas-fueled locomotives by providing clarity for the fuel suppliers, engine developers, railroads and regulators
- Understanding the efficiency and emissions performance of natural gas-fueled locomotives based on the various fuel blends

Project Partner(s)

- Caterpillar, Southwest Research Inc.

FRA Project Manager

Melissa Shurland, (202) 493-1316, melissa.shurland@dot.gov

Universal and Inclusive Accessibility for Next Generation of Passenger Rail Equipment

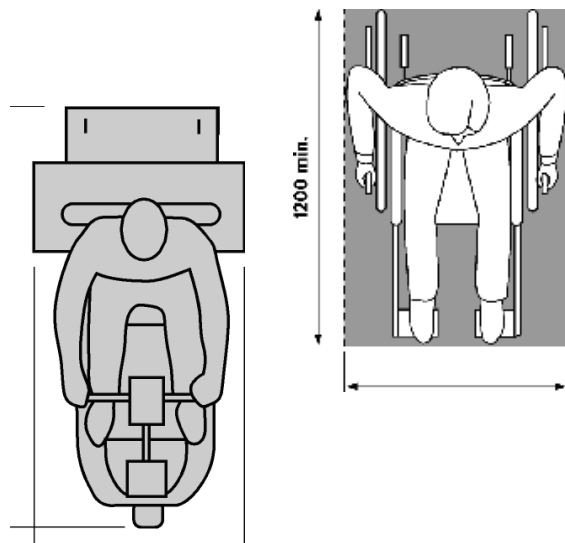

Railroad Impact

- Inclusion of enhanced accessibility requirements on PRIIA bi-level equipment
- Enhanced train travel for passengers who are disabled
- Improved communication with all passengers during normal and emergency operations
- Establishment of US Access Board Rail Vehicle Access Advisory Committee to develop guidance for new regulations for improved accessibility on passenger rail vehicles

Project Description

- Development of recommendations for improved accessibility on passenger rail equipment
 - Larger accessible space to accommodate powered wheeled mobility devices
 - Improved maneuverability in accessible restroom
 - Automatic controls in accessible restrooms
 - Dual-mode passenger information system to ensure communication with passengers who are deaf or have hearing loss

Project Partner(s)

- Oregon State University, PRIIA Next Generation Equipment Committee

FRA Project Manager

Melissa Shurland, (202) 493-1316, melissa.shurland@dot.gov

Advanced Noise Cancellation (ANC) Demonstration

Shown here: Active Noise Cancellation Speakers in Locomotive Cab



Railroad Impact

- In addition to improving crew comfort, the technology has several significant safety benefits, including:
 - Reduced crew fatigue
 - Improved crew situational awareness by reducing noise induced issues
 - Reduced low frequency noise in locomotive cabs without crews having to wear special gear
- Additionally, the system has potential to reduce noncompliant noise levels in locomotive cabs to compliant levels.

Project Description

- High interior cab noise has several safety implications including crew fatigue concerns and impeding communications, particularly on older locomotives. ANC systems attenuate high noise levels by counteracting the harmful noise with equivalent 'negative' sound.
- Current effort has focused on evaluating and documenting the effects of ANC implementation on EMD and GE built locomotive cab AC 4200 and two older legacy locomotives SD-40 and GP-38. Cab noise levels are measured and compared with ANC reduced noise levels and crews' input on the effects of ANC.
- Measureable reductions in locomotive cab noise were observed with the ANC system turned on.

Cost & Schedule

- FY2010: Tested and validated ANC and AVC systems aboard two locomotives – \$200k
- FY2012: Purchased the ANC and AVC system and kept it in field service – \$285k
- FY2014 – Evaluate ANC system effectiveness in reducing locomotive cab noise using spot checks and long term monitoring /accumulation of noise dosage – \$200k
- FY15 Est. – Complete ANC field demonstration – \$100k

FRA Project Manager

John Punwani, (202) 493-6369, john.punwani@dot.gov

Operating Practices Research to Reduce Derailment / Optimize Fuel Use

Shown here: Train Derailment



Railroad Impact

- Better understanding of train make up and train handling practices with respect to derailment risk reduction
- Significant reduction in train derailment risks
- Reduced fuel consumption and emissions
- Operator assist software may result, making engineers' jobs less stressful

Project Description

- This project seeks to identify opportunities for risk reduction through evaluation of significant derailments attributed to train make up and train handling causes. Some specific activities include:
 - Establishing train make up rules/guidelines using simulation tools
 - Proactively researching route specific train handling for difficult territory and different train types to reduce risks
 - Evaluating the benefits of alternate configurations such as ECP brakes and distributed power
- Report on 5 recent accidents is being published.

Cost & Schedule

- FY2011 – Conducted TEDS simulations to demonstrate ECP brakes' improved safety potential wherever airbrake applications were involved - \$250k

FRA Project Manager

John Punwani, (202) 493-6369, john.punwani@dot.gov

Whole Body Vibration

Shown here: WBV Instrumentation



Seat Pad Accel
• Compliant with ISO 2631
• Fixed with tape on seat pad

Tri-Axial Accelerometers
• MEMS accels to minimize drift over long durations
• Used under seat and on seat frame



Railroad Impact

- Establish new or modified ride quality standards
- Identify characteristic vibration frequencies in locomotive cabs to inform future seat design
- Optimize seat configuration for comfort and ergonomics

Project Description

- Determine ride quality on North American freight locomotives using the independent assessment of a third-party contractor
- Determine risks, if any, for physical health effects
- Compare ride quality with ISO 2631 standards for whole body vibration
- Nearly 4,000 miles of data has been collected from different locomotives on different railroads. Report is being prepared for publication

Cost & Schedule

- FY2009 – Literature Review and began noise and vibration measurements – \$500k
- FY2011/12/13 –Continued vibration measurements (4000 mile) frequency analysis, cab ergonomics health assessment, survey, collecting and processing the data – \$1,150,000
- FY2013/FY2014 – Final analysis of data collected and reports – \$200k
- FY15 Est. – Specification requirements will be updated – \$150k

FRA Project Manager

John Punwani, (202) 493-6369, john.punwani@dot.gov

Next Generation Locomotive Cab

Shown here: Next Generation Locomotive Eye Tracker



Project Description

- Partner with industry & labor to establish new cab design standards for the next generation locomotive
- Use an integrated systems approach to guide the development of cab design standards
- Key elements include:
 - Displays
 - Controls
 - Seat
 - System Architecture
- Evaluate prototypes using design standards in FRA Cab Technology Integration Laboratory (CTIL)
- Solicit engineer feedback from new design
- Develop Next Generation Cab for safety and comfort

Railroad Impact

- Standardize cab design across Industry
- Integrate engineer-friendly in-cab controls, displays, and seating
- Reduce engineer fatigue and discomfort
- Improve operating safety and efficiency
- Develop common system architecture and communications protocol

Cost & Schedule

- FY2012 – Requirements analysis and development of information display rapid prototyping software tool – \$950k
- FY2013/FY2014 – Study to identify critical operating display elements using non-obtrusive eye-tracking technology - \$500k
- FY15 Est. – Work with Stakeholders on Cab of the future \$650k

FRA Project Manager

John Punwani, (202) 493-6369, john.punwani@dot.gov

Optimized Acoustical Warning Device (AWD) as a Train Horn

Shown here: AWD and Acoustic Sound Wave

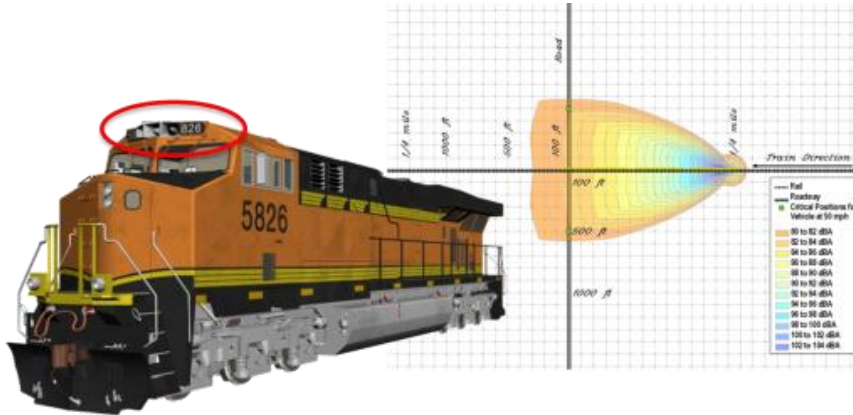

Railroad Impact

- Decreased wayside sound levels away from the grade crossing
- Minimize cabin sound levels
- Ensure required sound levels at the grade crossing
- Reduce accident risk at crossings

Project Description

- Implement AWD in a Pilot Implementation Program at the Maryland Transit Authority.
- Optimize GPS controlled sound patterns approaching a grade crossing to meet required dB sound levels while minimizing environmental noise.
- Demonstrate dynamic performance at TTCI
- Compile responses of several stakeholders, including railroad, wayside community, local government officials, and FRA to the system performance.
- Evaluation of the optimized system will be done with benchmark level system evaluation as well as a suite of environmental tests to validate durability.
- Tests will be conducted in transit at MTA and freight lines in cooperation with BNSF and other railroads.

Cost & Schedule

- FY2010/FY2011 – Feasibility study of using LRAD as train audible warning device - \$400k
- FY2012 – Prototype developed and tested – \$300k
- FY2013 – AWD prototype optimized and dynamically tested at TTCI – \$400k
- FY2014 – Tests will be conducted in transit at MTA and freight lines in cooperation with BNSF and other railroads – \$300K
- FY15 Est. – Continue demonstration to evaluate community noise reduction - \$250k

FRA Project Manager

John Punwani, (202) 493-6369, john.punwani@dot.gov

Benefits of Fuel Vapor Reclamation System

Shown here: Cooled return fuel to 90F has the biggest impact on lowering LEL

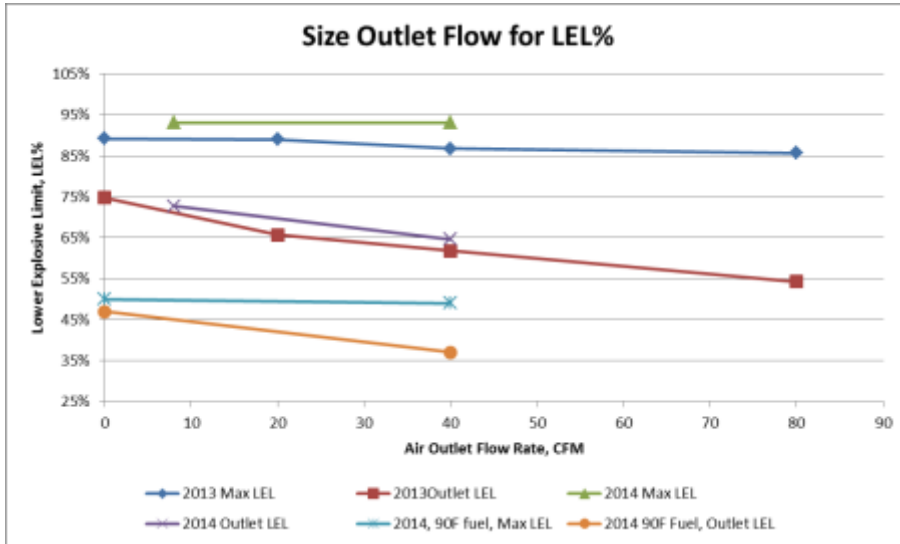

Railroad Impact

- Fuel tank leaks, caused by collision, derailment, or foreign object penetration are major fire hazards in locomotive accidents that can be prevented with the reclamation of fuel vapor
- Improve safety by reducing fire hazards
- An anticipated 2% to 5% in fuel savings
- Reduce emissions

Project Description

- The goal of the research is to minimize the diesel vapor content in locomotive fuel tanks with the combined benefits of mitigating fire hazards, increasing fuel use efficiency and reducing environmental pollution.
- QinetiQ developed a fuel vapor reclamation device known as the Diesel Vapor Reclamation Unit (DVRU) under FRA funding, that is adapted to the locomotive fuel tank during overhaul.
- This research extends the system usage baseline through extending the geographic routes and climatic conditions.
- The Phase 3 work optimizes the DVRU for an revenue locomotive deployment, validates the updated unit and installs and verifies performance on several locomotives.
- Field test will be done to measure actual fuel savings.

Cost & Schedule

- FY2010/FY2011 – Literature search and laboratory-scale proof-of-concept demonstration – \$750k
- FY2012 – Vapor reclamation unit design, integration, and testing with locomotive – \$300k
- FY2013 – Optimization of vapor reclamation unit, installation and monitoring - \$350k
- FY2014 – Bench top and environmental validation tests, field evaluations - \$400k
- FY2016 Est. – Continue field evaluations and develop a cost benefit analysis - \$200k

FRA Project Manager

John Punwani, (202) 493-6369, john.punwani@dot.gov



Locomotive Emergency Response Training

Shown here: Locomotive Emergency Egress Experiments



Railroad Impact

- In the last five years, 30 major accidents requiring emergency egress have occurred
- Responders have lacked adequate training and appropriate tools
- The original version of this this course has already been requested by 20,000 fire departments, railroads, and other emergency responders to date.

Project Description

- To develop training protocols instructing first responders on how to successfully and safely respond to locomotive crashes.
- The training encompasses three main topics: locating and accessing the incident scene, conducting rescue operations, and maintaining scene safety.
- Conducted emergency egress experiments using donated locomotives to determine best tools and methods for rescue operations.
- Pilot tested training at six locations to assess effectiveness and knowledge transfer. An average improvement of 54% per participant was found.
- We are working with operation Lifesaver to disseminate course information.

Cost & Schedule

- FY2010/FY2011 – Developed and conducted pilot training for firefighters to learn how to respond to a locomotive accident – \$450k
- FY2013 – Tested various firefighting tools and techniques in extricating, obtained and added video of extraction in training , developed train-the-trainer course - \$350k
- FY2014 – Develop training for dispatcher response to a locomotive emergency - \$400k
- FY15 Est. – Develop crew emergency survival training for locomotive emergencies - \$200k

FRA Project Manager

John Punwani, (202) 493-6369, john.punwani@dot.gov

Advanced Devices Train & Test Bed



Railroad Impact

- Improve safety of train operations by bringing to a minimum the human interaction with cars and car devices.
- Improve reliability of newly developed devices through testing.
- Increase train capacity and reduce costs by decreasing the time needed during stops due to functionality of devices.

Project Description

- Facilitate the creation of an Advanced Devices Train and Test Bed (ADT&TB) in order to test advanced devices either developed or under development for functionality and ergonomics.
- Advanced devices include Electrically Driven Hand Brake (EDHB), Tri-Couplers (air, electrical, and mechanical coupling systems), remote controlled angle cocks, and remote controlled cut-levers.
- Conduct evaluations and demonstrations of advanced devices and the advanced device network.
- Advanced devices can be operated either on the side of the car or remotely from within the locomotive.

Project Partner(s)

- TTCI, Sharma & Associates

FRA Project Manager

John Punwani, (202) 493-6369, john.punwani@dot.gov

Design Considerations for High-Speed Passenger Trucks



Railroad Impact

- Impacts both safety and quality of high-speed passenger rail by stipulating passenger truck design parameters which assure optimized operation in a mixed traffic environment.
- Identifies track design and maintenance requirements for both safety and passenger comfort (ride quality).

Project Description

- This project aims to develop general design guidelines for high-speed passenger trucks for shared operations, and to identify one or more potentially viable trucks for use in North America by:
 - Addressing braking systems and bearing monitoring systems used in high-speed trucks
 - Quantifying track conditions and load environments that rail vehicles are expected to encounter
- Four truck design types were selected for further evaluation.
- Performance was modelled on selected high speed corridors.

Project Partner(s)

- TTCI

Cost & Schedule

- FY2013/FY2014 – Reviewed existing truck designs and identified truck technologies for upgrades, recommended design considerations for improvement– \$500k
- FY2015 est. – Review truck designs to identify high speed passenger truck for U.S. shard corridor service.

FRA Project Manager

John Punwani, (202) 493-6369, john.punwani@dot.gov

Higher Speed Freight Truck (HST)

Shown here: HST Prototype



Railroad Impact

- Development of the HST is expected to result in:
 - Increased line-haul speeds that will allow sharing of routes and costs with passenger service
 - Reduced track damage due to improved dynamic performance and lower un-spring mass
 - Increased track and rolling stock life-cycles due to better dynamic performance
- Further, higher speed freight operations would produce beneficial services for the railroad industry by opening up certain market sectors for freight rail service.

Project Description

- Safe increases in freight operating speeds have significant capacity, efficiency, and economic benefits. The focus of this program is the development of a freight truck capable of higher speed operations. Past efforts have resulted in the design and fabrication of a pair of prototype HSTs. Current focus is on the following:
 - Dynamic performance of the prototype was recently completed at TTCI and validated.
 - Truck design will be extended for use with 286,000 pound GRL cars.

Project Partner(s)

- TTCI, Sharma & Associates

Cost & Schedule

- FY2013/FY2014 – Modifying refrigerated container car for higher speed freight - \$400k
- FY2015 – Extend design to 110-ton and design brake arrangement for the truck. – \$300k

FRA Project Manager

John Punwani, (202) 493-6369, john.punwani@dot.gov

Effects of Temperature on Wheel Shelling

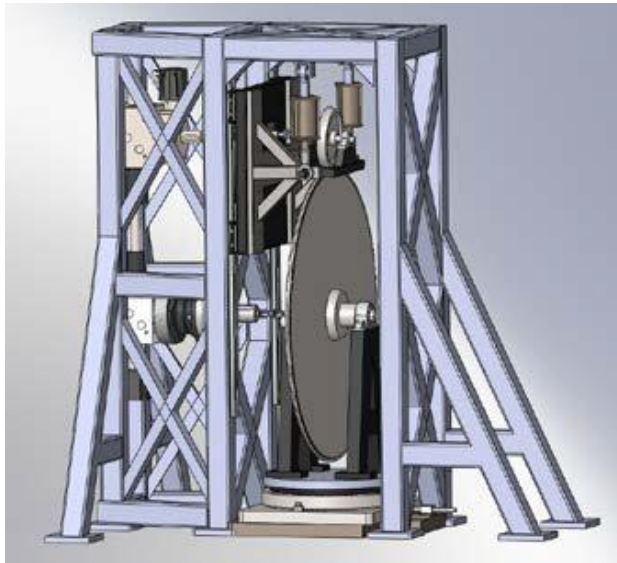

Railroad Impact

- Increase railroad safety and reliability by identifying root causes of wheel shelling, which lead to high impact loads, defects, and wheel removal.
- Reduce cost by identifying the effects of temperature which can ultimately reduce wheel shelling and wheel change-outs.

Project Description

- Investigate and quantify relationship between temperature and wheel shelling to allow future research to focus on the root causes and solutions of wheel shelling.
- Create the test samples as described in Phase I test matrix.
- Perform thermally controlled twin disc testing in accordance with a test matrix to maximize the utility of the testing.

Project Partner(s)

- TTCI

Cost & Schedule

- Phase I complete
- Awaiting approval for Phase II
 - Testing of twin discs as described in the Literature Review

FRA Project Manager

John Punwani, (202) 493-6369, john.punwani@dot.gov

Improved Truck Castings



Railroad Impact

- Reduced number of accidents caused by low temperature fracture
- Fewer side frame fractures due to lower stresses
- Faster weld repair in manufacturing and repair shops

Project Description

- Investigate alternative steels for truck castings:
 - Easily weldable, not requiring preheat
 - Increased resistance to cracking in low temperatures
- Reduce maximum stress in side frames

Project Partner(s)

- TTCI

Cost & Schedule

2015

- Report on ultraweldable steels
- Report on steels for low temperature service
- Side frame maximum stress reduction report
- Final report
- Total FRA cost \$160k

FRA Project Manager

John Punwani, (202) 493-6369, john.punwani@dot.gov

Vertical Split Rim Wheel Failure Mode



Railroad Impact

- Fewer vertical split rim accidents
- Improved detection of vertical split rims before failure

Project Description

- Investigate root causes of vertical split rim failures using the following methods:
 - Finite element analysis to model fatigue crack initiation
 - Creation of vertical split rim under controlled conditions
 - Measurement of residual stresses in new wheels
- Compare VSR trends in freight car and locomotive wheels

Project Partner(s)

- TTCI, AAR, and Texas A&M University
- Jointly funded by FRA and AAR

Cost & Schedule

- 2013 Machined 'crack' in wheel ; began rolling load test to propagate crack
- 2014 Finite element modeling and residual stress testing
- 2014 Reporting and project conclusion
- Total FRA cost \$200k

FRA Project Manager

John Punwani, (202) 493-6369, john.punwani@dot.gov

Advanced Tri-Coupler

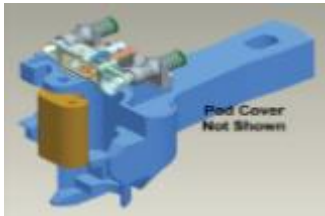

Railroad Impact

- Eliminates the need for crewmembers to access unsafe areas of the train to perform coupling/uncoupling and connecting/disconnecting of air and electrical lines (including electric and pneumatic brake lines), etc.
- Serves as a catalyst for remote controlled car coupling/uncoupling when combined with remote controlled cut-levers, angle cocks, and hand brakes (EDHB).

Project Description

- This advanced component provides automatic mechanical, pneumatic (brake pipe), and electrical (electronically controlled pneumatic brake (ECP) or electrical power supply system (EPSS)) coupling between two freight cars. This is expected to significantly improve the safety and efficiency of coupling operations.
- The Advanced Tri-Coupler prototype was successfully field tested verifying its reliability when subjected to on-track extreme geometry, extreme temperature, and impacts.
- Current focus is on developing isolated electrical contacts, and verifying performance under extreme wear and limiting mechanical conditions. Long-term field tests are planned.

Project Partner(s)

- Sharma & Associates

FRA Project Manager

Monique Stewart, (202) 493-6358, monique.stewart@dot.gov

Barriers to Electronically Controlled Pneumatic (ECP) Brakes

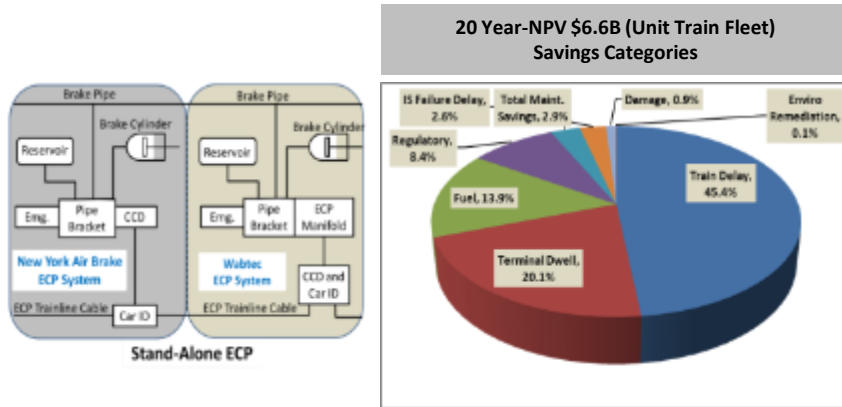

Railroad Impact

- ECP implementation is expected to result in:
 - Increased railroad operating safety due to inherently more reliable and effective braking
 - Higher average operating speed
 - Increased line-haul speeds due to reduced terminal and in-service train delays
 - Improved safety for both crew and public due to better performing equipment

Project Description

- The safety and economic benefits of ECP brakes are well known, and yet the technology has not been widely adopted by North American railroads. This project seeks to understand barriers to ECP brake system implementation and identify strategies to accelerate industry-wide ECP adoption. The major tasks include:
 - Review current state of ECP brake system technology and existing implementation and user experiences.
 - Identify and document the current barriers to implementation of the ECP brake system and potential strategies to overcome them.
 - Quantify benefits of various ECP brake system implementation strategies.

Project Partner(s)

- Sharma & Associates

FRA Project Manager

Monique Stewart, (202) 493-6358, monique.stewart@dot.gov

Electrically Driven (Set & Release) Hand Brake (EDHB)



Railroad Impact

- Reduces risk of operator injuries and the need to go in-between/climb rail cars.
- Reduces damage to hand brakes due to controlled application and release forces.
- Mitigates slid flat and out-of-round damage to wheels.
- Mitigates damage to lading, track, vehicles and bridges.
- Reduces railroad operating costs.

Project Description

- EDHB is a remotely controlled, electrically driven, set and release, vertical wheel hand brake that keeps all normal manual AAR Group N and related Groups' specified functions and requirements. Subsequent to successful prototype development, past work has included: 1) Development of a draft performance specification template for remotely operated hand brakes, including EDHB, in collaboration with hand brake suppliers, and AAR's GHBMEC/ROB task force. 2) Accomplishment of successful prototype testing and validation per the above performance specification. 3) Long term field test on three (3) prototype EDHBs installed on freight cars at the Facility for Accelerated Service Testing (FAST) at TTCI. Current work includes:
 - Improvement of electrical power to the EDHB motor
 - Improvement of control
 - Development of more positive chain load feed back

Project Partner(s)

- Sharma & Associates

FRA Project Manager

Monique Stewart, (202) 493-6358, monique.stewart@dot.gov

Next Generation Automated Cracked Wheel Detection



Railroad Impact

- Higher through-put capacity
- Operational on or near mainline
- Higher rate of wheel inspection
- Fewer broken wheel derailments

Project Description

- Demonstrate, develop, and validate new and alternative cracked wheel detection technologies
- Technologies addressed:
 - Next generation ultrasonic inspection
 - Acoustic cracked wheel detection
 - Broken rim detector

Project Partner(s)

- TTCI and AAR
- Jointly funded by FRA and AAR

Cost & Schedule

- 2012 System installation
- 2013 Analysis, Systems commissioning, and testing
- 2014 System capability testing and validation
- 2015 Reporting and implementation decisions
- Total FRA cost \$700k

FRA Project Manager

Monique Stewart, (202) 493-6358, monique.stewart@dot.gov

Train Energy & Dynamics Simulator (TEDS)

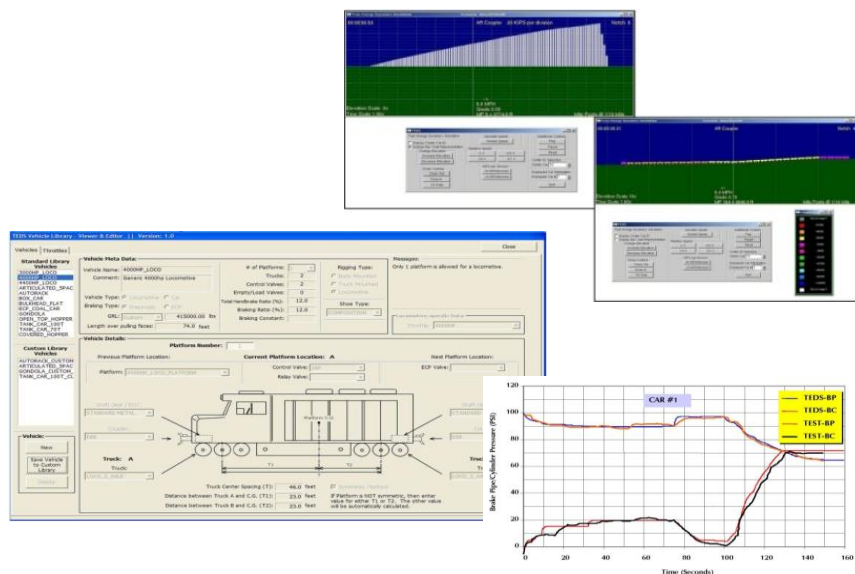

Railroad Impact

- TEDS facilitates the identification and quantification of train operations affected by :
 - Equipment
 - Train makeup
 - Train handling
 - Track conditions
 - Operating practices
 - Environmental conditions

Project Description

The Train Energy and Dynamics Simulator (TEDS) is a computer program for conducting longitudinal train dynamics simulations. Such simulations may be used to assist development of guidelines and recommendations to improve train operating safety.

- TEDS simulates the longitudinal dynamics and energy consumption resulting from the operation of a train over a section of track with the details about train consist, track characteristics and train handling specified by the user.
- TEDS is capable of simulating a large variety of scenarios consisting of a wide variety of vehicles, track layouts, posted track speeds, train handling and operating conditions.
- TEDS was used successfully for several simulations to assist FRA's Office of Safety in its investigations.
- FRA is in the process of expanding TEDS users base and providing technical and other support to improve effective use of this critical safety tool.

Project Partner(s)

- Sharma & Associates

FRA Project Manager

Monique Stewart, (202) 493-6358, monique.stewart@dot.gov

Wayside Advanced Technology Systems (WATS) Data Analysis & Pilot Demonstration

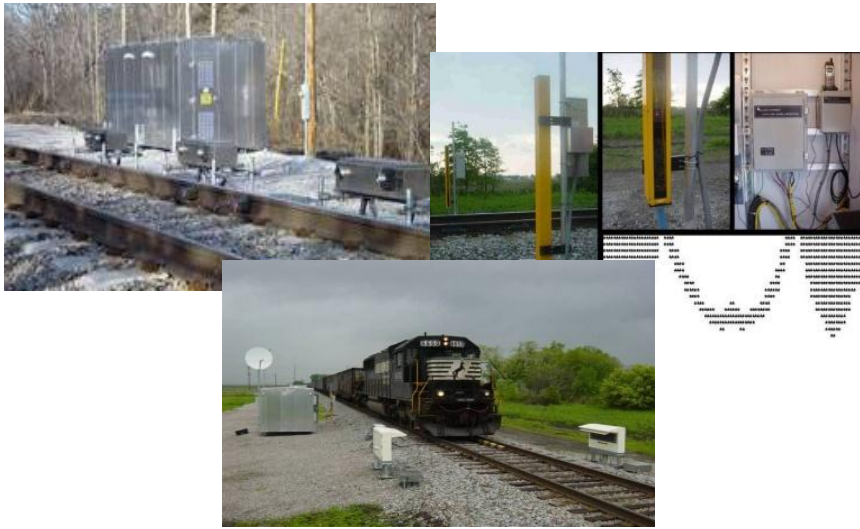

Project Description

- Wayside detection systems promote rail safety and improved performance through appropriate and optimal application of automated inspection technology to detect defects and precursors to safety critical defects in railway rolling stock. Project activities include:
 - Understand impact of wayside detection systems deployment on derailments
 - Identification of derailment causes to be addressed through technology innovation to further improve railroad safety
 - FRA working with various stakeholders to quantify and validate these systems.

Railroad Impact

- Implementation of wayside technology will complement existing manual inspection procedures to facilitate early detection of rolling stock defects.
- Reduce the number of incidents and accidents caused by rolling stock equipment and component failures.
- Identify opportunities for further safety improvement through innovative wayside detection technologies.

Project Partner(s)

- Sharma & Associates

FRA Project Manager

Monique Stewart, (202) 493-6358, monique.stewart@dot.gov

Wayside Pilot Demonstration

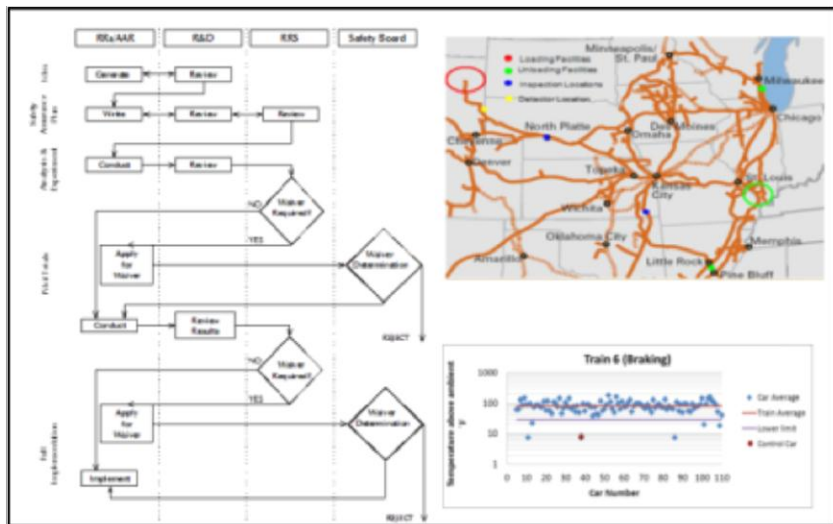

Railroad Impact

- Improve the process for demonstrating and implementing new technology.
- Establish a standard process for wayside technology pilot demonstrations.
- Wayside technologies will reduce the number of incidents and accidents through proactive maintenance driven by monitored performance of rolling stock equipment and components.

Project Description

- The key focus of this program is to assist railroads with pilot demonstration of new wayside technologies to detect defects and precursors to safety critical defects in railroad rolling stock. Among others this program has:
 - Developed roadmap for effective implementation of new wayside detection technologies.
 - Developed a Safety Assurance Plan framework to support FRA in evaluation of safety benefits of new technology.
 - Supported the demonstration of a Wheel Temperature Detector (WTD) system as a pilot project to assess the effectiveness of automated hot/cold wheel detection for detecting brake effectiveness.

Project Partner(s)

- Sharma & Associates

FRA Project Manager

Monique Stewart, (202) 493-6358, monique.stewart@dot.gov

Wheel Temperature Reduction

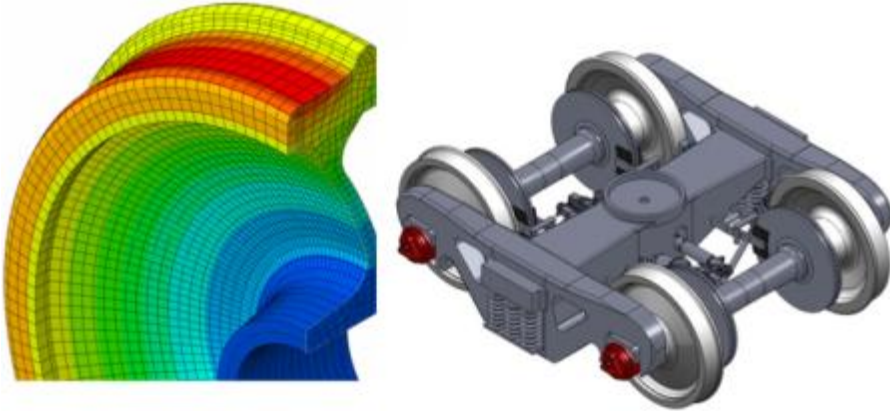

Railroad Impact

- Improve wheel fatigue due to reduced thermal stress.
- Develop alternative/complementary brake systems for higher speed operations.
- Safely increase wheel load and operating speeds, and improve productivity.

Project Description

- This project's goal is to investigate the potential to lower thermal stresses in wheels. The project includes the following components:
 - Analyze practical braking power dissipation limits of current freight car braking systems.
 - Identify alternative braking methods for freight cars to supplement or replace friction tread braking in order to reduce thermal stresses.
 - Identify devices and methods providing enhanced heat transfer from freight car wheels during braking.
 - Document advantages and disadvantages of each of the devices/methods identified.

Project Partner(s)

- Sharma & Associates

FRA Project Manager

Monique Stewart, (202) 493-6358, monique.stewart@dot.gov

Wireless Sensor Motes

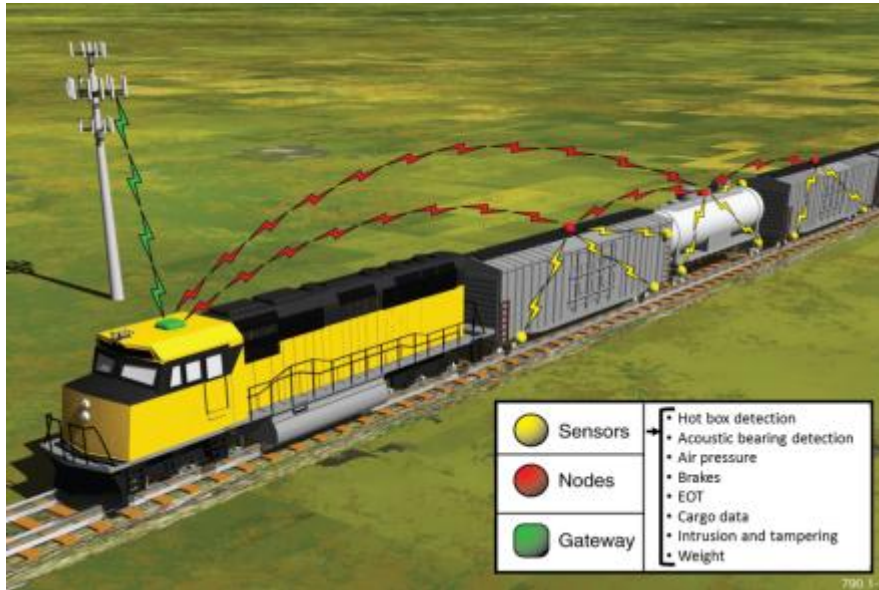

Railroad Impact

- Enable real-time railcar, locomotive, and cargo monitoring.
- Facilitate protocol development for a wide range of wireless sensors on a train.

Project Description

- Define a Wireless Sensor Network environment appropriate for train consist monitoring.
- Define a Wireless Sensor Mote architecture for a broad range of railcar and lading monitoring.
- Design and implement wheel monitoring sensor motes.
- Demonstrate Wireless Sensor Motes at TTCI.

FRA Project Manager

Monique Stewart, (202) 493-6358, monique.stewart@dot.gov

Non-Destructive Evaluation in Lieu Of Hydrostatic Testing of DOT Specification Tank Cars

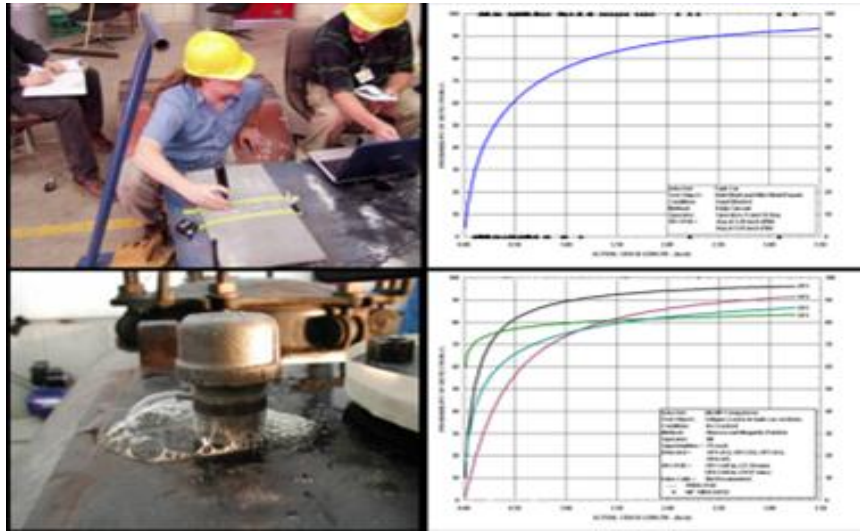

Railroad Impact

- Increases safety through technological development
- Addresses industry needs in the areas of maintenance, inspection, and damage tolerance
- Increases reliability of inspections
- Provides for operator and procedure qualification

Project Description

- Evaluate and quantify Non-Destructive Testing (NDT) methods authorized under 49 Code of Federal Regulations Section 180.509 for use in replacing the hydrostatic pressure test in the qualification or re-qualification of railroad tank cars.
- Quantify NDT methods using the probability of detection (POD) approach.

Project Partner(s)

- TTCI

Cost & Schedule

- Small Tank car shop NDT testing 2015 - \$100k

FRA Project Manager

Francisco Gonzalez, (202) 493-6076, francisco.gonzalez@dot.gov

Improving Safety of Tank Car Fittings in Hazmat Service

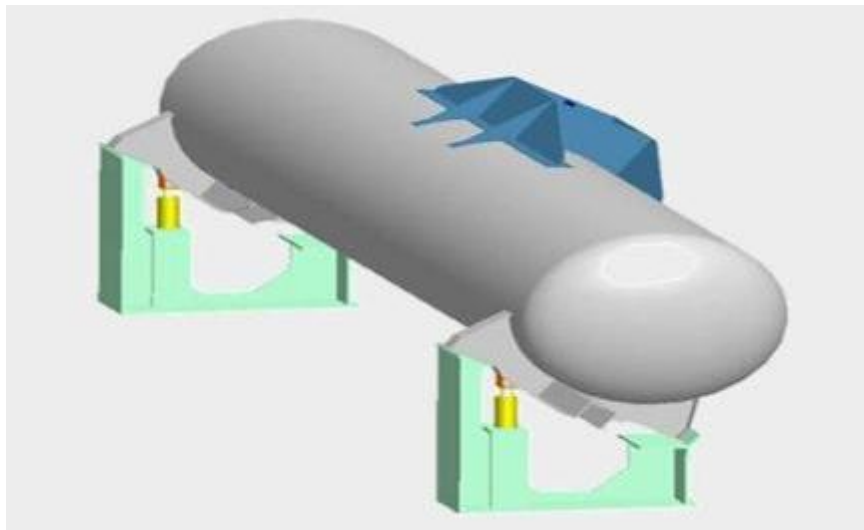

Railroad Impact

- Improve overall safety of tank car operations by mitigating the release of hazardous material in tank car rollover derailments.
- Develop recommendations for future design and testing of fittings for industry use.

Project Description

- Perform full scale static and dynamic testing of tank car fittings under rollover conditions.
- Evaluate effectiveness of three types of protective devices: base case, top skid, and reinforced protective housing.
- Calibrate analytical models to test results.
- Develop criteria and protocols for future industry research.

Project Partner(s)

- Sharma and Associates

Cost & Schedule

- Evaluate retrofit techniques for DOT 111 – 2015 - \$150k

FRA Project Manager

Francisco Gonzalez, (202) 493-6076, francisco.gonzalez@dot.gov

Instrumented Tank Car

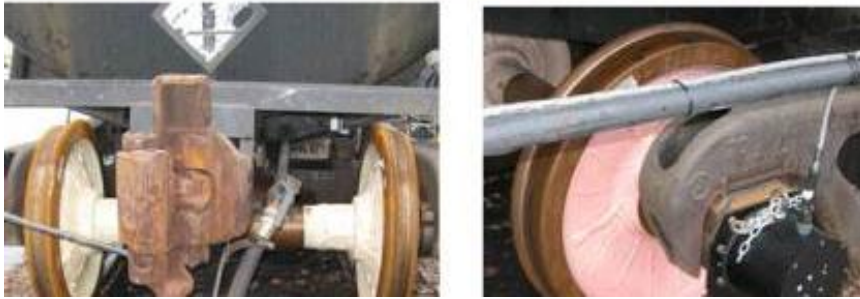

Railroad Impact

- Creates better understanding of the operational environment and forces exerted on tank cars when fracture occurs.
- Confirms the industry's current understanding of fracture initiation and propagation.
- Potentially reveals additional factors that are critical to the understanding of the phenomena.

Project Description

- To determine the cause of fractures in the stub sills of tank cars.
- Instrument tank car with strain gauges, accelerometers, instrumented couplers, instrumented wheelsets, etc.,
- Measure speeds as well as distance to couple for all track, specially Yard.
- Using similar instrumentation, add remote monitor equipment for autonomous data collection.

Project Partner(s)

- ENSCO Inc., GE Rail

Cost & Schedule

- Yard impact testing – 2015 - \$75k
- Over the road test-crude oil route - \$100k

FRA Project Manager

Francisco Gonzalez, (202) 493-6076, francisco.gonzalez@dot.gov

Renewable Fuels Non-Accident Releases Research



Railroad Impact

- Reduces the Non-Accident releases.
- Reduces the exposure of railroad employees to chemical releases.

Project Description

- The objective of this task is to reduce the number of product releases in the renewable fuels industry as a result of failures in the assembly of bolted joints and threaded connections.
- The project will focus on people, processes, and equipment in the bolted and threaded assembly joint process.
- Case studies-Emergency Response and mitigation strategies

Project Partner(s)

- Renewals Fuels Foundation

Cost & Schedule

- Best practices guideline 2015 - 50k

FRA Project Manager

Francisco Gonzalez, (202) 493-6076, francisco.gonzalez@dot.gov

Tank Car Total Containment Fire Testing



Railroad Impact

- DOT requires that these tank car safety systems are designed so that they will protect the tank car from rupture for 100 minutes in a defined engulfing fire, 30 minutes in a defined torching fire.
- If it is proved that the tank car survives the experiment then these materials can be transported without a PRD, thus reducing the non-accident releases during transportation.

Project Description

- Tank cars are required to have a pressure relief device (PRD) to protect the tank car when they carry hazardous materials.
- The objective is to demonstrate by scale testing that there is a regulation-grade alternative to PRD by loading rail cars with Sodium or Potassium hydroxide in a pool fire environment for 100 minutes without rupture or otherwise release any lading.

Project Partner(s)

- Sharma & Associate, ARA, Transport Canada, The Chlorine Institute, BAM

Cost & Schedule

- 1/3 scale test report 2015 - \$100k

FRA Project Manager

Francisco Gonzalez, (202) 493-6076, francisco.gonzalez@dot.gov

Tank Car Structural Integrity



Railroad Impact

- There are 28,116 pre-1989 pressurized tank cars in service today.
- Address safety concerns and NTSB recommendation arising from Minot, North Dakota train derailment and subsequent tank car ruptures in January 2002.
- National Rail Safety Action Plan (2005) calls for accelerated tank car structural integrity research.

Project Description

- Conduct engineering analyses and develop computational tools to evaluate structural performance of railroad tank cars under accident loading conditions.
- Conduct material testing to determine mechanical properties and fracture behavior of tank car steels.
- Risk ranking to prioritize tank cars most vulnerable to catastrophic failure.

Project Partner(s)

- Volpe Center

Cost & Schedule

- Full scale testing and modeling - 2015 \$150k

FRA Project Manager

Francisco Gonzalez, (202) 493-6076, francisco.gonzalez@dot.gov

Hazmat Risk Assessment



Railroad Impact

- Understand the risks involved with all aspects of hazmat transportation by railroad tank cars.
- Understand the impact of varying operational conditions on the risk of accidental release of hazmat during transportation

Project Description

- Identify and characterize baseline risks and metrics associated with the operation and transportation of hazmat by rail under current conditions.
- Determine the potential benefit of various risk reduction strategies (e.g. enhanced tank cars, PTC, re-routing, ECP brakes, and speed restrictions).
- Identify future research needs to support industry and governmental efforts to further reduce risk.

Project Partner(s)

- Dr. Alan Bing, Private Consultant

Cost & Schedule

- Final report 2015 - \$50k

FRA Project Manager

Francisco Gonzalez, (202) 493-6076, francisco.gonzalez@dot.gov

Collaboration with Industry

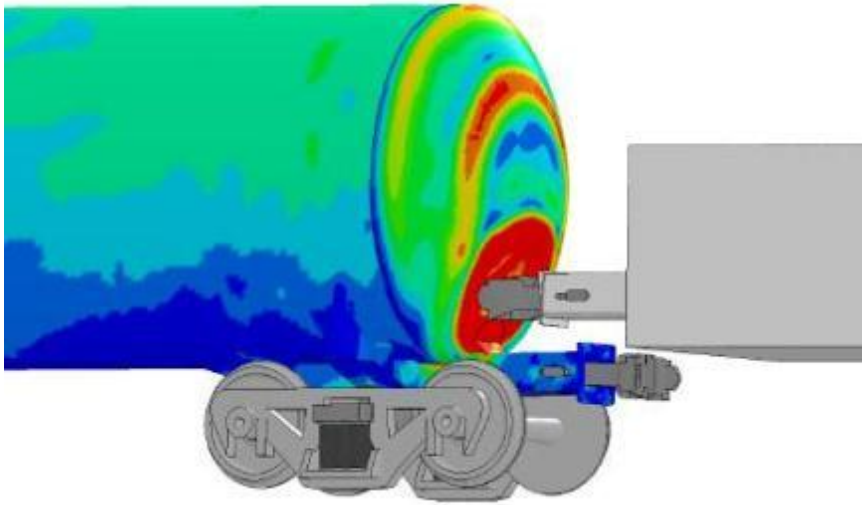

Railroad Impact

- This research is in cooperation with Advance Tank Car Collaborative Research Program (ATCCRP)
- These analyses will help to better understand the damaged caused by the different impactors on different tank cars and should provide us with conclusions/recommendations for performance tests for tank head and shell for each impactor.

Project Description

- Evaluate the puncture behaviors of tanks under a more general range of impact conditions. This includes analyses using three different impactor sizes (3x3, 6x6, 12x12) and real impactor shapes (coupler, coupler shank, and a section of rail).
- Task 1: Analysis of Different Sized Impactors
- Task 2: Analysis of Real World Impactors: extends Task 1 to include different complex impactors (e.g. coupler head, broken rail, etc.)
- Task 3: Analysis of real world impacts
- Task 4: Analysis of real world threats
- Coordinate with DHS and FRA to evaluate protection system concepts under Tasks 1 and 2 impact conditions.

Project Partner(s)

- AAR, Tank car manufacturers, Chemical Industries, PHMSA

Cost & Schedule

- Full scale test of pressure tank cars 2015 - \$150k
- Develop testing procedures for new designs 2015 - \$150k

FRA Project Manager

Francisco Gonzalez, (202) 493-6076, francisco.gonzalez@dot.gov



Section 3

Train Control and Communications

Connected Vehicles Grade Crossing Violation Warning

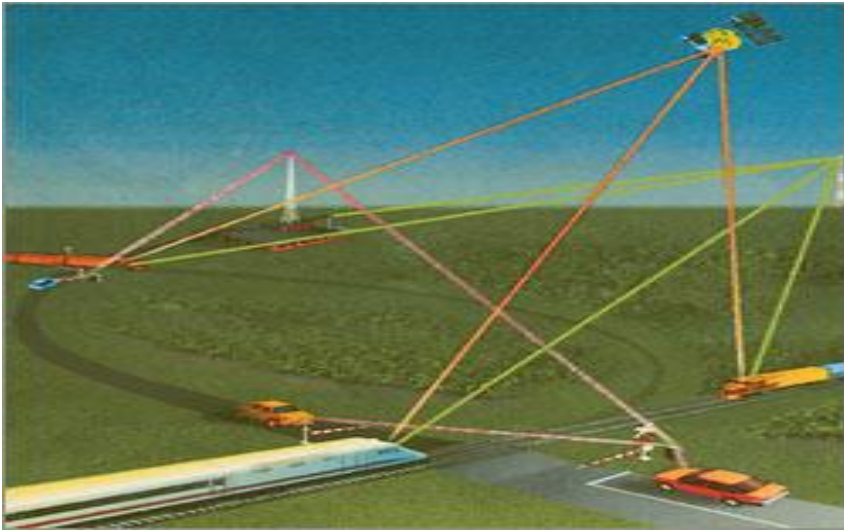

Railroad Impact

- Assures increased safety for vehicles approaching an active rail crossing.
- Enables route calculation to avoid occupied crossings for emergency vehicles.
- Provides a lower cost solution for protecting un-signalized grade crossings.

Project Description

- Integrate connected vehicle technologies with crossing protection systems to enable in-car warning of an active grade
- Develop an operational safety application in cooperation with railroad and automotive industries

Project Partner(s)

- DOT ITS Joint Program Office, Volpe Center

Cost & Schedule

- Project in planning stage
- \$1M marked for FY15

FRA Project Manager

Jared Withers, (202) 493-6362, Email: jared.withers@dot.gov

DSRC Performance Evaluation

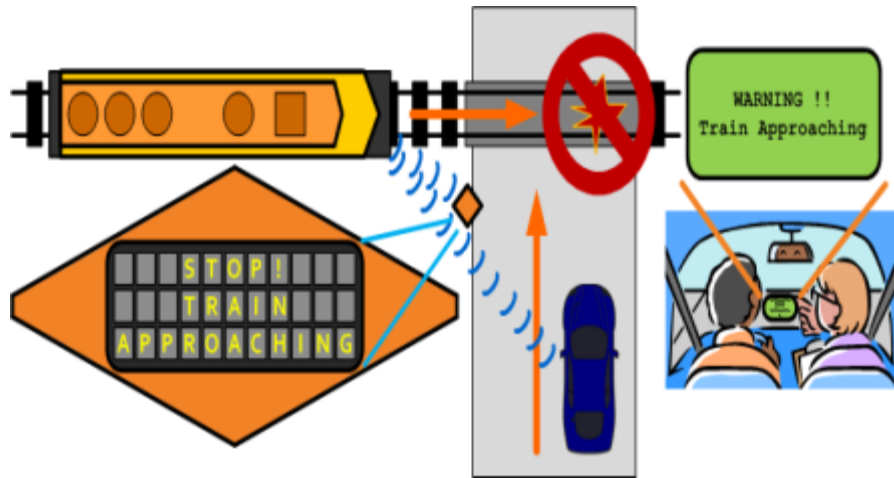

Railroad Impact

- Leverage Connected Vehicles technology to increase safety at passive grade crossings
- Reduce Train-to-Vehicle collisions
- Provide a low-cost, easily deployable solution for enhanced safety at grade crossings.

Project Description

- Characterize wireless propagation performance in a locomotive environment
- Perform simulations and field measurements of DSRC transmission protocols to rigorously characterize performance.

Project Partner(s)

- Virginia Polytechnic
- US Naval Academy

Cost & Schedule

- Period of Performance - 10/1/2013 – 9/30/2015
- \$600k project cost

FRA Project Manager

Jared Withers, (202) 493-6362, Email: jared.withers@dot.gov

Friction Braking Adaptive Enforcement Algorithm

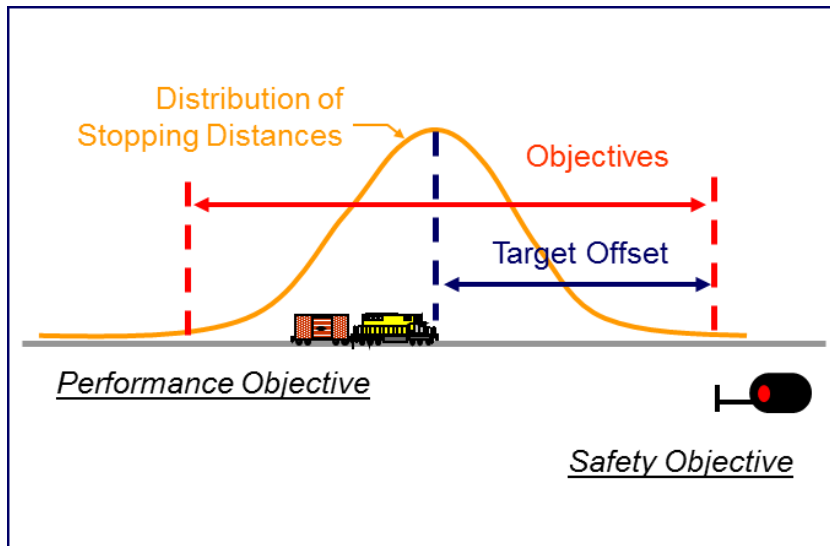

Railroad Impact

- Support continued improvement of the algorithm and make research and data available to railroads and PTC developers.
- Evaluate performance of PTC enforcement algorithms with reduced time and cost associated with revenue service testing.
- Assess alternative methods for improving braking distance calculations.

Project Description

- Develop more accurate braking performance algorithm for PTC
- Model and test trains under a realistic range of operational scenarios
- Support integration with commercial PTC systems

Project Partner(s)

- Transportation Technology Center, Inc. (TTCI)

Cost & Schedule

- Project Complete
- Technical report available at <http://www.fra.dot.gov/Elib/Document/3327>

FRA Project Manager

Jared Withers, (202) 493-6362, Email: jared.withers@dot.gov

Track Circuit Loss of Shunt Prevention

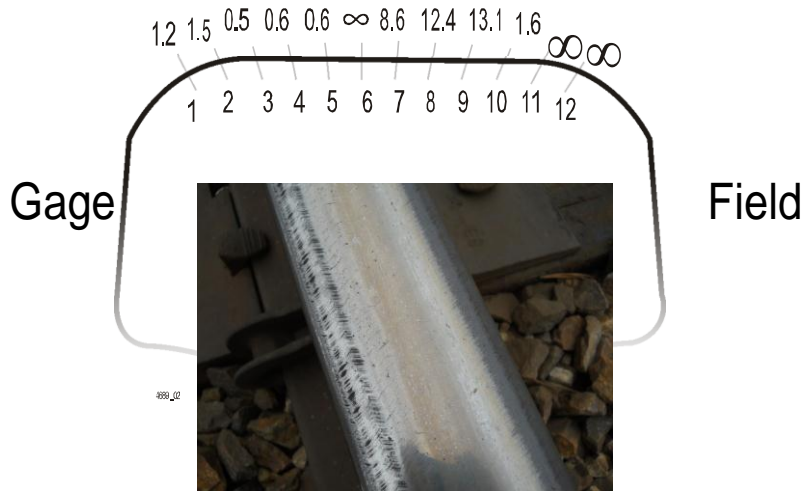

Railroad Impact

- Prevent loss of confidence in crossing protection equipment amongst motorists
- Mitigate capacity reductions due to loss of train detection
- Eliminate operational burden of adding axles to lightweight trains for shunting performance

Project Description

- Identify common factors in loss of shunt situations
- Evaluate rail cleaning methods with laboratory static and rolling load tests
- Determine feasibility of various prevention methods

Project Partner(s)

- Transportation Technology Center, Inc. (TTCI)

Cost & Schedule

- \$500k project cost
- Project Complete
- Report publication pending

FRA Project Manager

Jared Withers, (202) 493-6362, Email: jared.withers@dot.gov

Positive Train Location

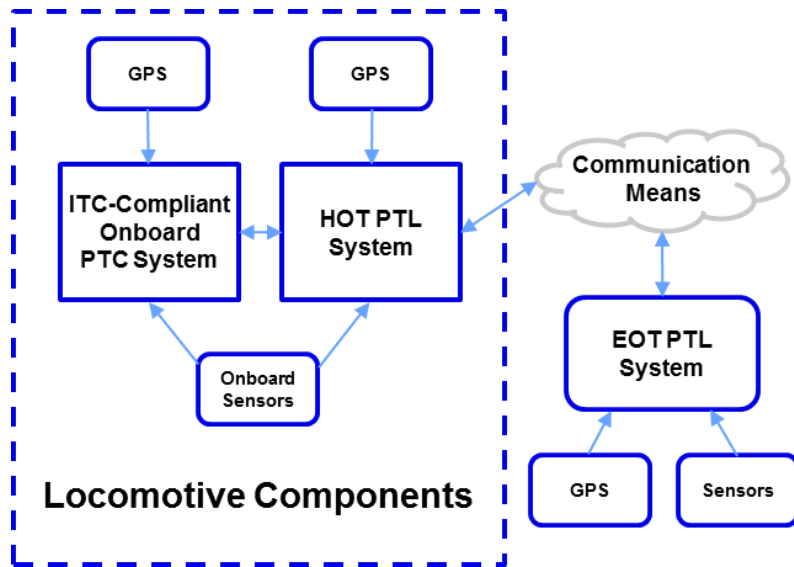

Railroad Impact

- Accurate train length and train location data at both train initialization and during train operation
- Reliable automatic track discrimination
- Determination of train clearing switch with no track circuit
- Enabling technology for moving block or virtual block operations

Project Description

- Develop, integrate, and test a high accuracy augmented GPS train location system
- For use on ITC-compliant PTC equipped trains

Project Partner(s)

- Transportation Technology Center, Inc. (TTCI), Leidos

Cost & Schedule

- \$5M overall cost
- 3/2012 – 5/2015

FRA Project Manager

Jared Withers, (202) 493-6362, Email: jared.withers@dot.gov

Vibration-based Broken Rail Detection

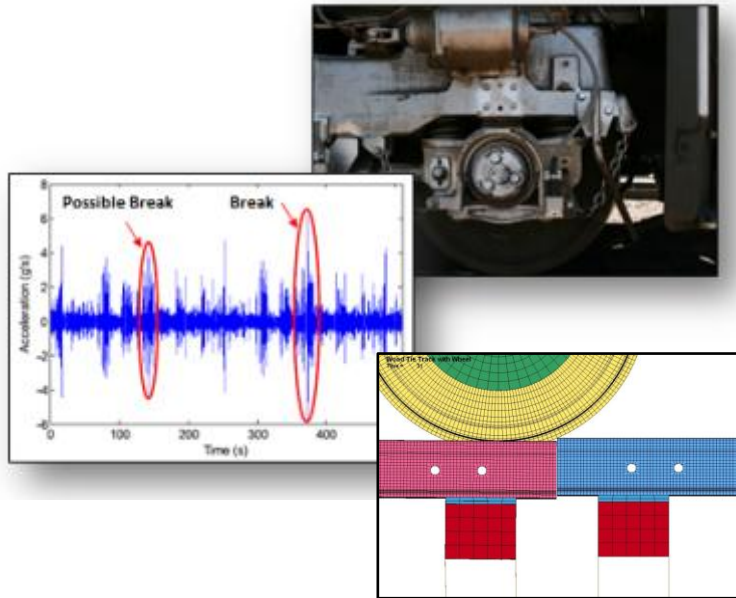

Railroad Impact

- Reduction in train derailments
- Increased safety – automatic detection of broken rails in dark territory
- Assess alternative methods for improving braking distance calculations.

Project Description

- Develop and refine wavelet-based broken rail detection algorithm
- Conduct a controlled conditions rail break test to assess accuracy of algorithms

Project Partner(s)

- ENSCO Inc., Norfolk Southern, Virginia Tech, Transportation Technology Center, Inc.

Cost & Schedule

- Project Complete
- \$500k project award

FRA Project Manager

Jared Withers, (202) 493-6362, Email: jared.withers@dot.gov

PTC Shared Network

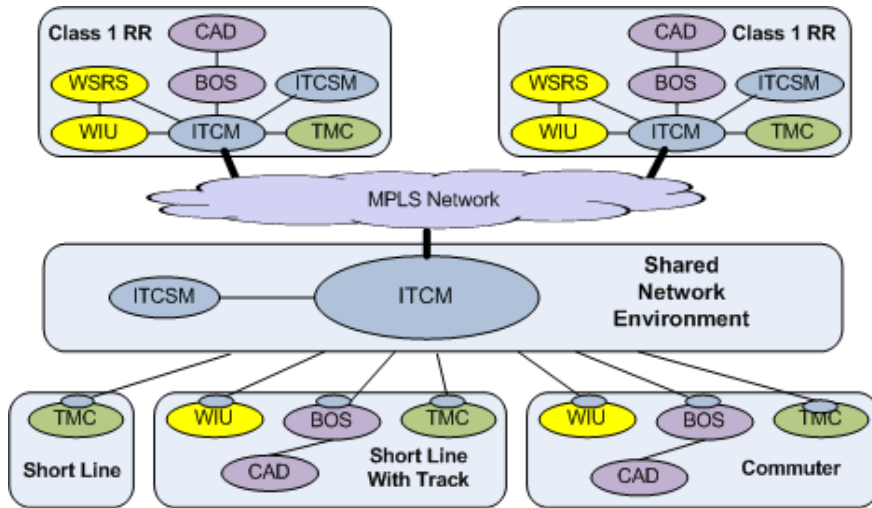

Railroad Impact

- Reduce small rail investments in IT human and computer resources required for PTC operation
- Reduce small railroad and FRA resources needed for PTC testing
- Reduce PTC technology training burden
- Simplify PTC configuration management
- Reduce complexity of PTC network connections for Class 1 railroads

Project Description

- Develop Concept of Operations for a Shared ITCM/ITCSM Environment for small railroads handling PTC message routing and delivery
- Establish a demonstration shared ITCM/ITCSM environment

Project Partner(s)

- Rockwell Collins

Cost & Schedule

- Proof of concept and Concept of Operation completed October 2014
- \$500k project award

FRA Project Manager

Jared Withers, (202) 493-6362, Email: jared.withers@dot.gov

ACSES Upgrade to Transit Test Track

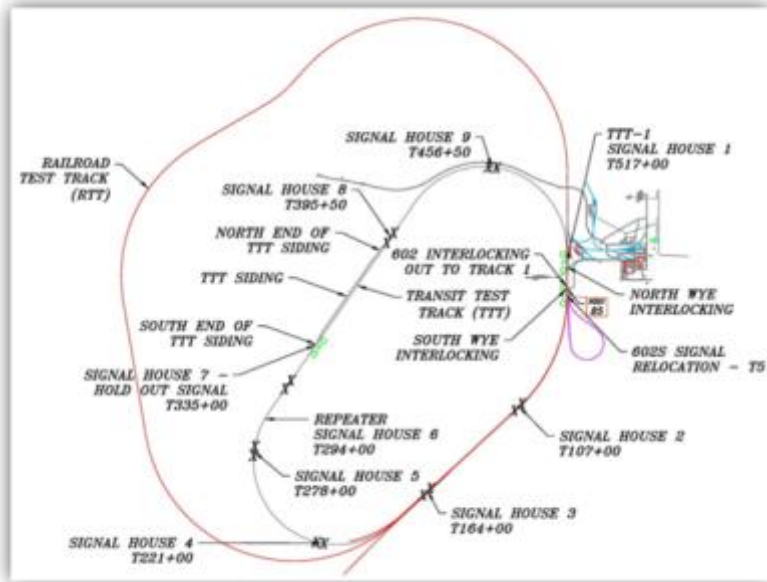

Railroad Impact

- Representative of commuter rail track
- Provide capability of testing dual-equipped territory (ACSES and ITC)
- Provides the capability to demonstrate and test the ability to transition from ITC to ACSES territory at track speed

Project Description

- Upgrade the PTC Test Bed at TPCI to support testing that accurately represents ACSES and ATC cab signaling applications in revenue service with electrified third rail track

Project Partner(s)

- Transportation Technology Center, Inc. (TTCI)

Cost & Schedule

- Period of Performance – 8/13/2014 – 8/12/2016
- \$2.3M project cost

FRA Project Manager

Richard Orcutt, (719) 584-0507, richard.orcutt@dot.gov

Rail Defect Detection by Fiber Optics

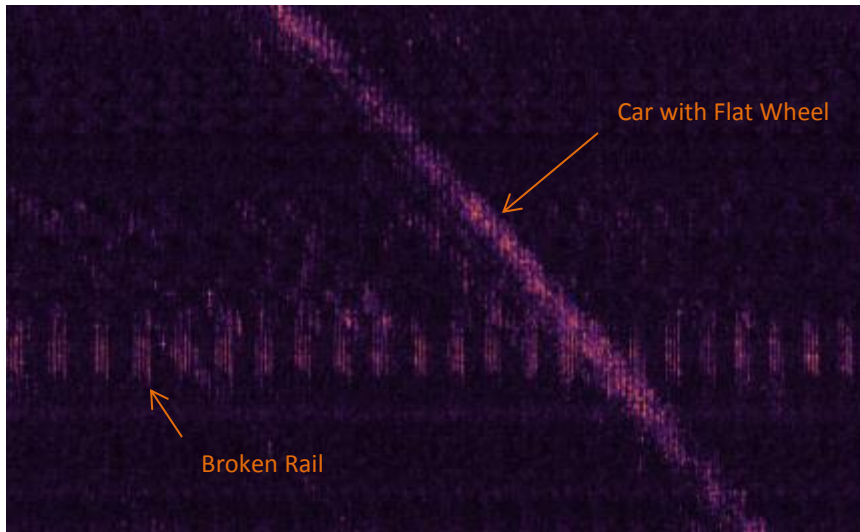

Railroad Impact

- If key requirements identified can be achieved, system may offer ROI benefits over track circuits

Project Description

- Develop method to quantify performance of FOAD broken rail detection
- Gather and store Helios Web Interface data
- Develop dataset to evaluate rail break alg.
- Evaluate the current algorithm

Project Partner(s)

- Transportation Technology Center, Inc. (TTCI)

Cost & Schedule

- Preliminary ROM of \$750k
- 24 Month Project

FRA Project Manager

Richard Orcutt, (719) 584-0507, richard.orcutt@dot.gov

PTC RF Network Design for Dense Urban Areas

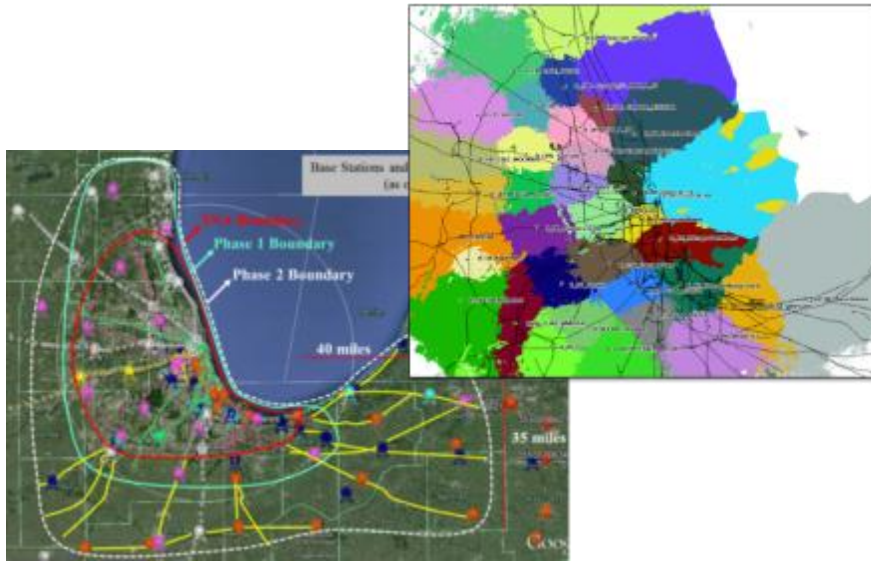

Railroad Impact

- Determines amount of frequency and communication infra-structure required for the operation of PTC systems for dense urban areas - allowing railroads to take actions for a successful PTC deployment
- Analysis of coverage redundancy for commuter lines and extremely dense areas will lay out solutions
- Analyzed Dallas/Fort Worth, Kansas City, Chicago. New project funded for Northeast Corridor.

Project Description

- Collect and Organize input data from Railroads
- Configure Radio Frequency propagation models
- Simulate and analyze train message traffic
- Generate Radio Frequency network design plan

Project Partner(s)

- Transportation Technology Center, Inc. (TTCI)

Cost & Schedule

- Period of Performance - 3/12/2013 – 6/30/2015
- \$900k project cost

FRA Project Manager

Richard Orcutt, (719) 584-0507, richard.orcutt@dot.gov

Investigate the use of Air Bags for Mitigating Grade Crossing and Trespass Accidents

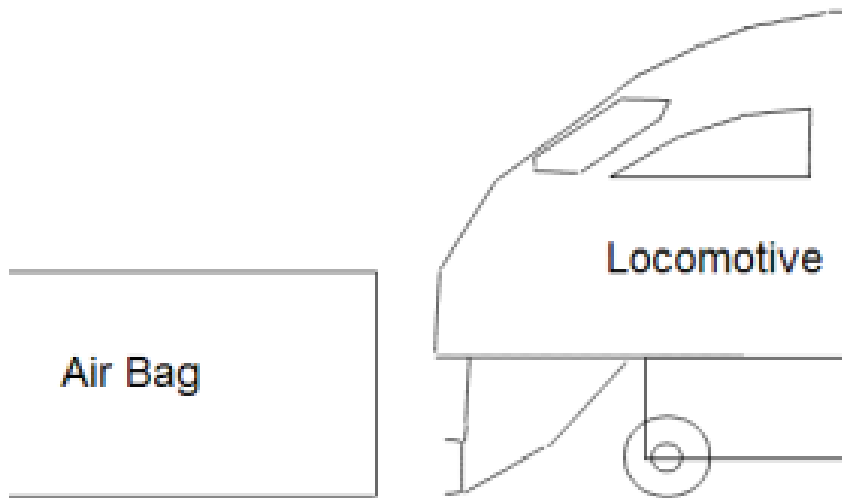

Railroad Impact

- Mitigate the severity of the Train collision with a vehicle or a pedestrian/trespasser.
- Reduce the fatalities due to Grade Crossing accidents/crashes.
- Reduce derailments due to Train crash with heavy vehicles.

Project Description

- Research effort to evaluate the feasibility of and conceptually design "airbag" devices on the front of trains that possibly deflect and lessen the impact with vehicles at grade crossings, as well as mitigate occupant and pedestrian injuries.
- The analyses will be conducted using computational physics-based computer simulation techniques.

Project Partner(s)

- The Applied Physics Lab of Johns Hopkins University (APL/JHU)

Cost & Schedule

- Total Funding: \$300k
- POP (09/01/13 – 09/30/14)

FRA Project Manager

Tarek Omar, Ph.D., (202) 493-6189, Tarek.Omar@dot.gov

Acoustical Warning Device as a Secondary Emergency Warning System



Railroad Impact

- Mitigate the number of casualties and injuries resulting from train collision with pedestrians/trespassers.
- Reduce the sever cost associated with train delays due to collision with Trespassers

Project Description

- Design and test an Emergency Warning Signal (EWS) to be installed onboard locomotives to alert right of way trespassers and railroad workers – even those not paying attention or those with ear buds or headphones – of oncoming trains.

Project Partner(s)

- QinetiQ North America (QNA)

Cost & Schedule

- Phase-1 Funding = \$250k (06/17/13 – 06/16/14)
- Phase-2 Funding = \$80k (09/02/14 – 12/01/14)
- Phase-3 Funding = \$250k (12/02/14 – 12/01/15)

FRA Project Manager

Tarek Omar, Ph.D., (202) 493-6189, Tarek.Omar@dot.gov

Rail Safety Training Course for Law Enforcement

Chatsworth, CA



Railroad Impact

- Improve Law Enforcement qualifications and behavior in responding to Railroad accidents.
- Reduce fatalities and injuries associated with railroad crashes/accidents.

Project Description

- Develop an updated and advanced rail safety training course targeting law enforcement officers. The effort in this project encompasses the following key objectives:
 - Update and expand the Operation Lifesaver GCCI program through development of a modular-learning rail safety training course for law enforcement officials.
 - Pilot the training program with Operation Lifesaver GCCI instructors and law enforcement personnel to gather stakeholder feedback.

Project Partner(s)

- QinetiQ North America (QNA)

Cost & Schedule

- Funding: \$250k
- POP (01/06/2014 – 01/05/2015)

FRA Project Manager

Tarek Omar, Ph.D., (202) 493-6189, Tarek.Omar@dot.gov

Automated Extraction of Grade Crossing Parameters using LiDAR Technology



Railroad Impact

- Reduce hang-ups at grade crossings
- Commensurate with the FRA's need to identify high profile grade crossings throughout the country
- Improve the safety features/warnings at grade crossings

Project Description

- Validation of LiDAR Data: collection and comparison of survey data over a humped grade crossing using the LiDAR system on FRA's DOTX 218 against independently collected ground survey data to identify system accuracy and repeatability.
- Data Management Plan: develop procedures for collection, processing, storage, and distribution of LiDAR data.
- Develop and implement algorithms for automated detection of grade crossings in order to eliminate the need for a forward observer to identify the grade crossing during surveys.

Project Partner(s)

- ENSCO

Cost & Schedule

- Funding: \$270k
- POP (12/19/13 – 12/18/14)

FRA Project Manager

Tarek Omar, Ph.D., (202) 493-6189, Tarek.Omar@dot.gov

Safety Innovations Deserving Exploratory Analysis (IDEA)



Railroad Impact

- New mechanism to solicit and obtain new creative research ideas that have potential to be implemented later in the Railroad service.
- The ultimate goal is to improve safety and performance of railroad transportation.

Project Description

- FRA provides funding for the TRB/NAS to continue to carry out the Safety IDEA program.
- The IDEA programs explore innovative concepts that are initiated and proposed by researchers, inventors, universities, or companies, both within and outside the usual transportation research community.

Project Partner(s)

- TRB of the NAS

Cost & Schedule

- FY-15 Funding: \$400k
- POP (12/15/2014 - 12/14/2015)

FRA Project Manager

Tarek Omar, Ph.D., (202) 493-6189, Tarek.Omar@dot.gov

Highway Rail Grade Crossing and Trespass Research (RR97A7)



Railroad Impact

- Contribute to reduction on trespass and crossing casualties
- Facilitate implementation and evaluation of innovative safety technologies
- Information exchange on cutting edge technologies and /or strategies for grade crossing safety and trespass prevention

Project Description

- Analyze incident causation and develop safety countermeasures, programs, and guidance to reduce the number of casualties on rail rights-of-way. Current projects include:
 - Conducted of a trespass research study in the City of West Palm Beach, FL with TriRail, Amtrak, CSX, and state and local partners.
 - Evaluation of dynamic envelope zone pavement markings being piloted by the Florida DOT
 - Implementation and evaluation of pedestrian gate enhancement technologies (gate skirts and second train warning signs) with New Jersey Transit.
 - Development of a Trespass Detection and Warning System.

Project Partner(s)

- Inter-Agency Agreement with Volpe Center

Cost & Schedule

- FY-15 Funding: \$1M
- POP (11/02/2014 - 11/01/2015)

FRA Project Manager

Tarek Omar, Ph.D., (202) 493-6189, Tarek.Omar@dot.gov

Low Ground Clearance Vehicle Detection and Warning System (SBIR 13.1 – Phase 1 & 2)

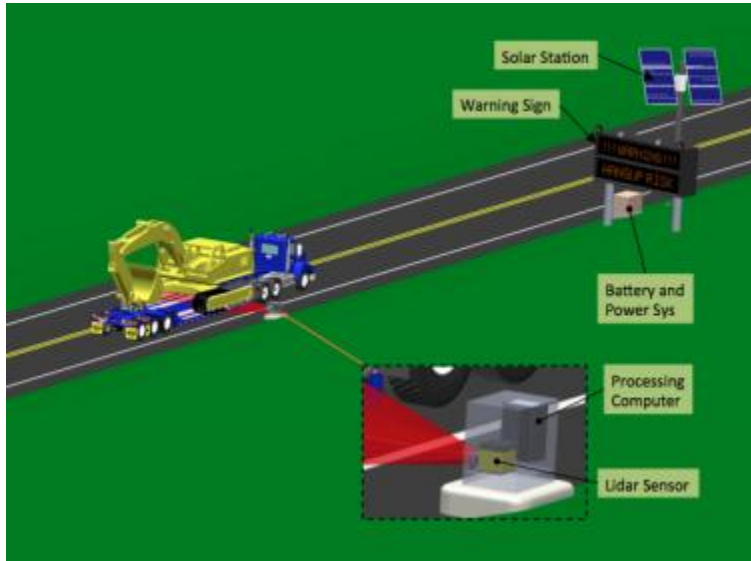

Railroad Impact

- Reduce or eliminate the risk of accidents at hump crossings.
- Save lives and reduce injuries.
- Reduce/eliminate the cost of delays due to accidents at GCs.

Project Description

- Hump crossings present a severe risk to Low Ground Clearance Vehicles (LGCV).
- This problem could be more complicated knowing that the underbody of LGCV is not always a flat surface. There could be electric cables, air lines, tanks, storage cabinets, etc. suspended from the flat surface of the underbody of a LGCV.
- It is aimed to design an accurate and reliable detection system to detect whether a LGCV will stuck in the specific crossing and if yes – provide enough warning.

Project Partner(s)

- Advanced Technology and Research Corp. (ATR)

Cost & Schedule

- Phase-1 Funding: \$150k - POP (05/20/2013 - 11/20/2013)
- Phase-2 Funding: \$750k - POP (07/31/2014 - 01/30/2016)

FRA Project Manager

Tarek Omar, Ph.D., (202) 493-6189, Tarek.Omar@dot.gov

Providing Wireless Bandwidth for High-speed Rail Operations

Can VETMS work with GSM-R in CA high-speed rail?



GSM-R with ERTMS in Europe



Proposal GSM-R Cell Planning for VETMS



Job-up of Wireless Array
WMax Antennas
Clearwire's WMax
Possibly Verizon & AT&T (unconfirmed)
Microwave Backhaul (line-of-sight; two total here)

Railroad Impact

- Knowledge of bandwidth requirements for high-speed trains
- Cell planning blueprint for high-speed trains
- Limitations and capabilities of using IETMS for high-speed trains
- GSM-R specifications can be used to determine how to place towers and use frequencies in order to determine if the traffic density and delays can be adhered to.
- This guarantee is required to ensure safe high-speed operation, especially in California.

Project Description

- Determine the capacity of 220 MHz Bandwidth to Support PTC with 125 mph and 250 mph Train Speeds
- Determine the ability of ERTMS to Support 250 mph Train Speeds over GSM-R on 220 MHz
- Irrespective of the PTC protocols used, what are the Radio Properties and 250 mph Speeds, such as signal attenuation and Doppler effect

Project Partner(s)

- George Mason University (GMU)

Cost & Schedule

- Funding: \$350k
- POP (02/01/2013 - 08/31/2014)

FRA Project Manager

Tarek Omar, Ph.D., (202) 493-6189, Tarek.Omar@dot.gov

Hazards associated with HSR operations adjacent to conventional tracks

Chatsworth, CA



Railroad Impact

- The final product shall be a document that provides relevant information for those designing or evaluating HSR system designs.
- The guiding information should mitigate accidents/incidents associated with HST operating near conventional Tracks.

Project Description

- Conduct a comprehensive literature review for the most severe Hazards associated with HSR operations adjacent to conventional tracks.
- Develop a Guidance document that will provide information on the design considerations, and potential mitigations for high-speed rail (HSR) systems adjacent to, and sharing corridors with existing railway operations.

Project Partner(s)

- Booz Allen Hamilton (BAH)

Cost & Schedule

- Phase-1 Funding: \$75k - POP (03/31/14 – 06/30/14)
- Phase-2 Funding: \$100k - POP (10/31/14 – 02/28/15)

FRA Project Manager

Tarek Omar, Ph.D., (202) 493-6189, Tarek.Omar@dot.gov



Section 4

Human Factors

Sustained Attention and Error: A Scientific Approach to Reducing Major Rule Violations

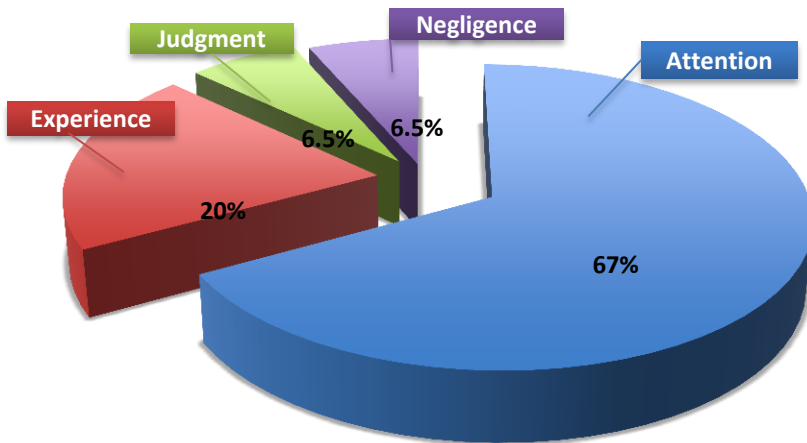

Veolia Transportation Services Inc. Study

Railroad Impact

- A collaborative effort with railroad industry to address sustained attention and human error related rule violations
- Contributes to the understanding of accidents involving signals passed at danger (SPADs)

Project Description

- Investigate attention related errors in train operations and analyze operator attention using the Cab Technology Integration Lab (CTIL)
- Develop a sustained attention/distraction training program and validate course content utilizing CTIL
- Share knowledge with railroad industry

Project Partner(s)

- Veolia Transdev, Inc. and the George Mason University, Applied Cognition Research Program

Cost & Schedule

- Project was completed September, 2014, FRA Technical Report in editing
- Cost-share agreement, \$250k, started May, 2011
- Data collection completed mid-August, 2014
- Analysis completed September, 2014
- Pilot training course on distraction developed.

FRA Project Manager

Mike Jones, RPD-34, michael.e.jones@dot.gov

Development and Evaluation of a High Speed Rail Scheduling Display and a Virtual Head-Up

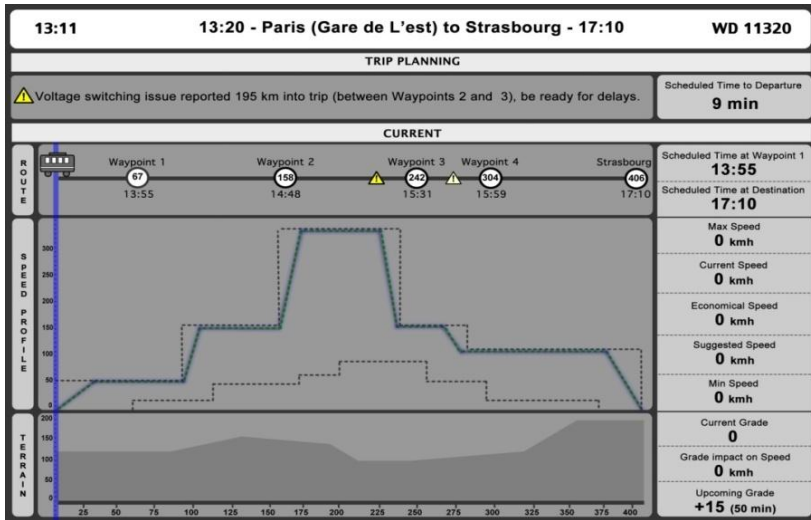

Project Description

- Using Cab Technology Integration Laboratory (CTIL), a real-time interactive planning and scheduling display is developed for U.S. high speed rail operators that reduces operator workload.
- Demonstrates human and system performance advantages, including cost and safety improvements.
- Head-Up Display (HUD) in virtual environment helps determine HUD human requirements.

Project Partner(s)

- Massachusetts Institute of Technology, Humans and Automation and the Manned Vehicle Labs

Cost & Schedule

- Project completed June, 2014
- Concept HUD methodology prototyped but not installed in CTIL

Railroad Impact

- Preliminary usability evaluations show display is easy to learn, operators are confident in their use after just two hours of interaction, and the display was consistent with expectations
- Reduces crew workload
- Improves crew situation awareness
- Manages fuel more efficiently
- Enhances on-time performance (OTP)
- Results in higher customer satisfaction

FRA Project Manager

Mike Jones, RPD-34, michael.e.jones@dot.gov

Engineer's Workstation Design



Railroad Impact

- Improves crew health, safety, and performance over current workstation designs
- Workstation design meet requirements for bi-directional locomotive operations

Project Description

- Develop experimental locomotive engineer's crewstation as a concept demonstration that migrates the common AAR-105 control stand functions onto the crewstation and attempts to address the "display stacking" problem.

Project Partner(s)

- QinetiQ North America, Waltham MA.

Cost & Schedule

- Project completed. Fabrication and installation in CTIL completed.
- Volpe Center beginning crew use assessment. Inform further refinement on the concept.
- \$230k project completed with integration in CTIL, Late August 2014

FRA Project Manager

Mike Jones, RPD-34, michael.e.jones@dot.gov

Investigation of New Roles for Humans and Automation In Next-Generation Rail Operations

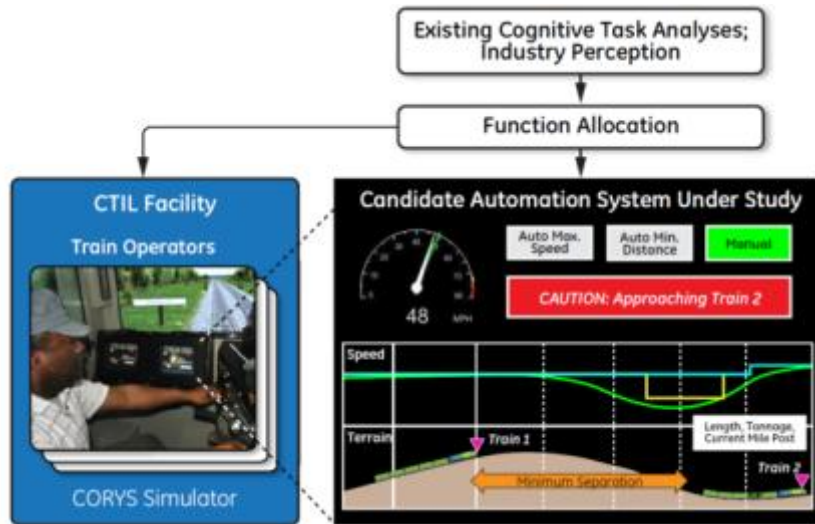

Railroad Impact

- Framework for novel workflow and roles definition for, e.g., reduced workload & improved situation awareness, with emerging train automation (Trip Optimizer, PTC, etc.)
- Tools to evaluate impact of *integrated* information outside the train to improve human and system performance metrics (dispatcher roles, nearby trains, etc.)
- Path toward standards for human factors requirements for current and future advanced automation systems

Project Description

- GEGR and MIT will establish a framework, or methodology for determining and evaluating the allocation of functions between human operators and in-cab automation performance.
- Develop and test a framework for human factors analysis of in-cab advanced automation technologies using GE's Trip Optimizer as a baseline automation platform; prototype system in the Cab Technology Integration Lab (CTIL) Explore alternative workload assignments among crew, dispatcher and automation

Project Partner(s)

- GE-Global Research, the MIT Man-Vehicle Lab, Volpe Center

Cost & Schedule

- Phase 1 cost share \$350k Analysis, Function allocation
- Phase 2 Cost share \$360k Research in FRA's CTIL
- Overall 2-year study, started May, 2014

FRA Project Manager

Mike Jones, RPD-34, michael.e.jones@dot.gov

Computer-Based Training in Human Systems Integration



Railroad Impact

- Introduce and inform rail industry on HSI/HFE methods
- Encourage implementation of HSI/HFE methods to improve performance, safety, and reduce total life-cycle costs of new rail systems.

Project Description

- Conduct a pilot project to develop, implement and assess a computer-based training (CBT) suite to improve industry's awareness of, and use of Human Systems Integration (HSI), particularly human factors engineering methods in system development.

Project Partner(s)

- Applied Research Associates, Inc

Cost & Schedule

- Project started December, 2013, \$450k
- Phase 1 1st year, \$250k, develop training requirements and learning objectives
- Phase 2 2nd year, \$200k, develop CBT pilot suite

FRA Project Manager

Mike Jones, RPD-34, michael.e.jones@dot.gov

Incidents and Accidents of Maintenance of Way Employees and Signalmen



Railroad Impact

- The purpose of this study is to provide information that can help to reduce the risk of safety incidents, injuries and fatalities associated with the duties of non-operating railroad employees, particularly maintenance of way (MOW) employees and signalmen.
- The most common accident and incident scenarios and their related causal factors will be identified and characterized in terms of date and time of the accident or incident, job code and age of the injured party, physical action of injured party at the time of injury, location of the injured party at the time of injury, equipment involved in the injury, etc.

Project Description

- Analyzes fatal accident reports and incident/accident records (1997 through 2014) that railroads have submitted to FRA to determine the factors that contribute to the incidents and accidents involving MOW and signalmen that have been attributed to human factors causes
- Analyses will also provide information about the relative risk of human factors accidents at different times of the day

Project Partner(s)

- Volpe Center

Cost & Schedule

- \$100k; Final technical report in FY15

FRA Project Manager

Starr Kidada, 202-493-1300, starr.kidda@dot.gov

Short Line Safety Institute

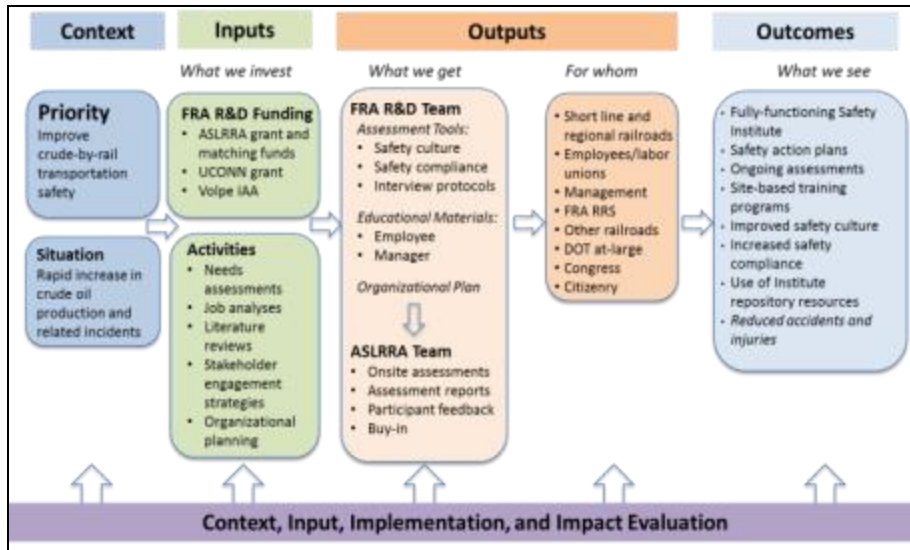

Railroad Impact

- Development of the Institute responds to a January 2014 letter from the U.S. Department of Transportation Secretary Anthony Foxx to ASLRRA President Richard Timmons regarding the transportation of crude oil on short line and regional railroads.
- Impact includes enhanced safety practices and increased commitment to building a strong safety culture on short line and regional railroads that transport crude oil

Project Description

- This project's mission is to enhance safety culture and safety compliance of short line and regional railroads transporting crude oil through voluntary, non-punitive partnerships.
- FRA is working with ASLRRA to develop and evaluate the Institute, which will: conduct safety compliance and safety culture assessments, and provide safety education, training, and development to managers and employees.

Project Partner(s)

- American Short Line and Regional Railroad Association (ASLRRA), University of Connecticut (UCONN), and Volpe Center

Cost & Schedule

- UCONN received a \$100k grant to develop: questionnaires assessing safety culture, safety compliance checklists, and a site visit protocol.
- ASLRRA received a \$250k grant to begin the pilot phase of the assessments. ASLRRA provided a \$250k in-kind match to its grant.
- Pilot testing of the Safety Institute's processes and procedures will begin in early 2015.

FRA Project Manager

Starr Kidda, 202-493-1300, starr.kidda@dot.gov

Suicide Countermeasures



Railroad Impact

- Reduction in the number of suicide casualties that occur on the railroad rights-of-way
- Reduction in service disruption and employee time off due to suicide incidents
- Better understanding of potential countermeasures and improved understanding of feasibility of implementing countermeasures to mitigate suicides
- Improvement in the quality of data being collected on suicide and trespass casualties by railroad carriers
- Involvement of other groups who may be able to share countermeasure costs

Project Description

- Better understand potential countermeasures to mitigate suicides on the rights-of-way
- Develop rail specific guidelines for reporting on suicides on the rights-of-way
- Track suicide and trespass rates and identify potential regions of concern (e.g., hotspots) using Geographic Information Systems (GIS) mapping
- Continue to gather information about the prevalence of suicides on the rights-of-way as well as demographic characteristics of the individuals involved and characteristics of the time and location that may impact countermeasure development
- Continue working with railroad carriers to implement pilot tests of various countermeasures

Project Partner(s)

- Association of American Railroads (AAR)
- George Washington University (GWU),
- Volpe Center, and various railroad carriers

Cost & Schedule

- Period of Performance: through 6/30/2015

FRA Project Manager

Michael Coplen, (202) 493-6346, michael.coplen@dot.gov

Critical Incident Intervention Framework

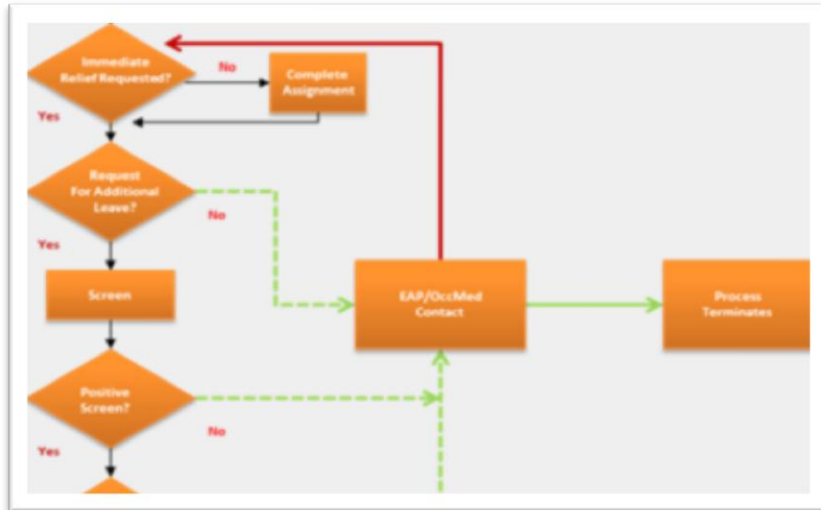

Railroad Impact

- Framework for railroads to use after a train crew member has witnessed or been involved in a potentially critical incident (e.g., grade crossing, trespass, or suicide incident)
- Sample standard operating procedure for carriers to use when adapting their programs to fit new FRA rule
- Sample module to assist in the adaptation of existing peer support training to follow more modern approaches
- Plan to confidentially monitor effectiveness of new FRA rule will help railroads to modify programs to be most effective

Project Description

- Develop a sample standard operating procedure for rail carriers based on the new Critical Incident Stress Plan rule
- Develop a module for carriers to cover psychological first aid and to adapt existing peer support efforts
- Draft a document which describes the findings from following one carrier's adaptation to the new FRA rule – this may be used as a lessons learned document by other carriers
- Draft a plan to establish a confidential and anonymous data repository for tracking the impacts of this new rule – this information will be used to improve the plans as more is known about their impact

Project Partner(s)

- Amtrak
- Volpe Center

Cost & Schedule

- Period of Performance: 8/1/2012 – 12/31/2015
- \$250k project award (for Phase 2 only)

FRA Project Manager

Michael Coplen, (202) 493-6346, michael.coplen@dot.gov