



U.S. Department  
of Transportation  
**Federal Railroad  
Administration**

# Thermal Insulation Systems Study for the Chlorine Tank Car

---

Office of Research  
and Development

William P. Wright  
Wayne A. Slack  
Willis F. Jackson

Department of Army  
Ballistic Research Laboratory  
Aberdeen Proving Ground, Maryland 21005-5066

### NOTICE

This document is disseminated under the sponsorship of the Department of Transportation in the interest of information exchange. The United States Government assumes no liability for the contents or use thereof.

Technical Report Documentation Page

1. Report No. FRA/ORD-85-10		2. Government Accession No.		3. Recipient's Catalog No.	
4. Title and Subtitle THERMAL INSULATION SYSTEMS STUDY FOR THE CHLORINE TANK CAR				5. Report Date APRIL 1985	
				6. Performing Organization Code	
7. Author(s) William P. Wright, Wayne A. Slack & Willis F. Jackson				8. Performing Organization Report No.	
				10. Work Unit No. (TRAIS)	
9. Performing Organization Name and Address Department of Army Ballistic Research Laboratory ATTN: DRXCR-TBD Aberdeen Proving Ground, MD 21005-5066				11. Contract or Grant No. DTFR53-84-X-00008	
				13. Type of Report and Period Covered Final December 1983 - August 1984	
12. Sponsoring Agency Name and Address Department of Transportation Federal Railroad Administration, RRD-20 400 Seventh Street, S.W. Washington, D.C. 20590				14. Sponsoring Agency Code	
				15. Supplementary Notes This work was monitored by the Equipment & Operating Practices Safety Research Division of the Federal Railroad Administration	
16. Abstract <p>A number of thermal tests were performed on three insulation systems. The purpose was to ascertain if an insulation system consisting of existing materials could prevent the temperature of the shell of a chlorine tank car from exceeding 251 °C (483 °F) while the tank car is exposed to representative fire environments which can occur in a railroad accident. The significance of the temperature criteria is that a corrosive reaction between chlorine vapor and steel begins at approximately that temperature. Each insulation system was tested in two environments as prescribed by the Department of Transportation regulation documented in Title 49, Code of Federal Regulations, Part 179.105-4. The insulation systems consisted of fiberglass plus a type of ceramic fiber. A total of seven tests were performed with a simulated torch fire environment and ten tests with a simulated pool fire environment. The thermal protection performance of each of the three insulation systems easily surpassed the temperature test criteria. It was determined that the wind constituted a serious obstacle to the performance of a valid pool fire test and it is recommended that an effective wind shield be provided for the facility. While the wind made the task difficult, legitimate pool fire tests were performed.</p>					
17. Key Words Thermal Systems Ceramic Fiber Safety Chlorine Railroad Tank Cars			18. Distribution Statement This document is available to the U.S. public through the National Technical Information Service, Springfield, Virginia 22161		
19. Security Classif. (of this report) Unclassified		20. Security Classif. (of this page) Unclassified		21. No. of Pages 18	22. Price



# METRIC CONVERSION FACTORS

Approximate Conversions to Metric Measures			Approximate Conversions from Metric Measures					
Symbol	When You Know	Multiply by	To Find	Symbol	When You Know	Multiply by	To Find	Symbol
<b>LENGTH</b>								
in	inches	*2.5	centimeters	mm	millimeters	0.04	inches	in
ft	feet	30	centimeters	cm	centimeters	0.4	inches	in
yd	yards	0.9	meters	m	meters	3.3	feet	ft
mi	miles	1.6	kilometers	km	kilometers	1.1	yards	yd
<b>AREA</b>								
in <sup>2</sup>	square inches	6.5	square centimeters	cm <sup>2</sup>	square centimeters	0.16	square inches	in <sup>2</sup>
ft <sup>2</sup>	square feet	0.09	square meters	m <sup>2</sup>	square meters	1.2	square yards	yd <sup>2</sup>
yd <sup>2</sup>	square yards	0.8	square meters	km <sup>2</sup>	square kilometers	0.4	square miles	mi <sup>2</sup>
mi <sup>2</sup>	square miles	2.6	square kilometers	ha	hectares (10,000 m <sup>2</sup> )	2.5	acres	
<b>MASS (weight)</b>								
oz	ounces	28	grams	g	grams	0.035	ounces	oz
lb	pounds	0.45	kilograms	kg	kilograms	2.2	pounds	lb
	short tons	0.9	tonnes	t	tonnes (1000 kg)	1.1	short tons	
	(2000 lb)							
<b>VOLUME</b>								
tsp	teaspoons	5	milliliters	ml	milliliters	0.03	fluid ounces	fl oz
Tbsp	tablespoons	15	milliliters	l	liters	2.1	pints	pt
fl oz	fluid ounces	30	milliliters	l	liters	1.06	quarts	qt
c	cups	0.24	liters	l	liters	0.26	gallons	gal
pt	pints	0.47	liters	m <sup>3</sup>	cubic meters	36	cubic feet	ft <sup>3</sup>
qt	quarts	0.95	liters	m <sup>3</sup>	cubic meters	1.3	cubic yards	yd <sup>3</sup>
gal	gallons	3.8	liters					
ft <sup>3</sup>	cubic feet	0.03	cubic meters					
yd <sup>3</sup>	cubic yards	0.76	cubic meters					
<b>TEMPERATURE (exact)</b>								
oF	Fahrenheit temperature	5/9 (after subtracting 32)	Celsius temperature	oC	Celsius temperature	9/5 (then add 32)	Fahrenheit temperature	oF

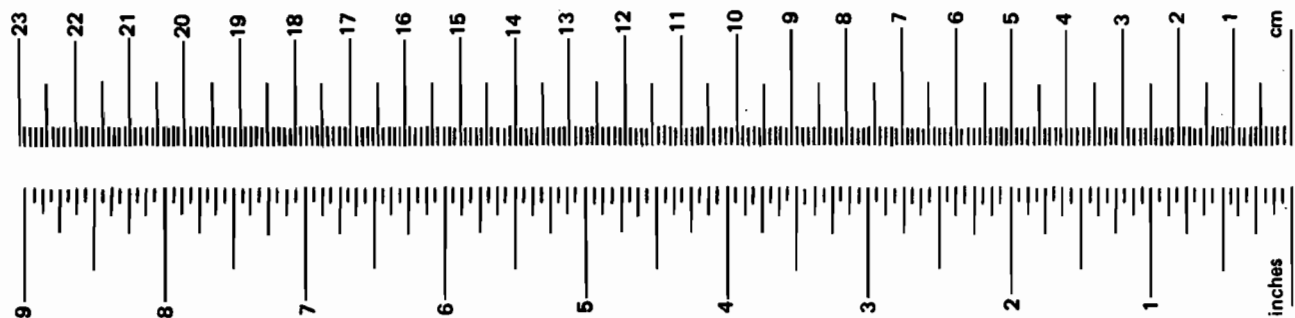

\*1 in. = 2.54 cm (exactly). For other exact conversions and more detail tables see NBS Misc. Publ. 286. Units of Weight and Measures. Price \$2.25 SD Catalog No. C13 10 286.



TABLE OF CONTENTS

	Page
LIST OF TABLES .....	v
LIST OF FIGURES .....	v
INTRODUCTION .....	1
DOT PERFORMANCE STANDARDS .....	1
THE TORCH FIRE FACILITY & TEST SET UP .....	2
DATA ACQUISITION .....	4
SUMMARY OF TESTS .....	5
TORCH FIRE CALIBRATION TESTS .....	5
TORCH FIRE INSULATION TESTS .....	6
POOL FIRE CALIBRATION TESTS .....	10
POOL FIRE INSULATION TESTS .....	13
SUMMARY .....	18

LIST OF TABLES

1. FLUKE DATA LOGGER CHANNELS .....	4
2. DENSITIES OF THE INSULATION SYSTEMS.....	5
3. SUMMARY OF TESTS PERFORMED .....	5
4. INITIAL CONDITIONS OF TORCH FIRE TESTS ..	6
5. POOL FIRE CALIBRATION TESTS .....	10
6. INITIAL CONDITIONS OF POOL FIRE TESTS ...	13

LIST OF FIGURES

1. The Insulation Test Assembly Holder and Cart.....	3
2. The Insulation Test Assembly .....	3
3. Bare Plate and Rear Enclosure Air Temperatures for the First Torch Fire Calibration Test .....	6
4. Bare Plate and Rear Enclosure Air Temperatures for the Second Torch Fire Calibration Test .....	6
5. Jacket Temperatures and Wind Speed for the First Torch Fire Test of Kaowool (A-1) .....	6
6. Back Plate and Rear Enclosure Air Temperatures for the First Torch Fire Test of Kaowool (A-1) .....	7
7. Jacket Temperatures and Wind Speed for the Second Torch Fire Test of Kaowool (A-2) .....	7
8. Back Plate and Rear Enclosure Air Temperatures for the Second Torch Fire Test of Kaowool (A-2) .....	7
9. Jacket Temperatures and Wind Speed for the First Torch Fire Test of Fiberfrax (B-1) .....	8
10. Back Plate and Rear Enclosure Air Temperatures for the First Torch Fire Test of Fiberfrax (B-1) .....	8
11. Jacket Temperatures and Wind Speed for the Second Torch Fire Test of Fiberfrax (B-2) .....	8
12. Back Plate and Rear Enclosure Air Temperatures for the Second Torch Fire Test of Fiberfrax (B-2) .....	8
13. Jacket Temperatures and Wind Speed for the First Torch Fire Test of Cerawool (C-1) .....	8
14. Back Plate and Rear Enclosure Air Temperatures for the First Torch Fire Test of Cerawool (C-1) .....	9
15. Jacket Temperatures and Wind Speed for the Second Torch Fire Test of Cerawool (C-2) .....	9
16. Back Plate and Rear Enclosure Air	

Temperatures for the Second Torch Fire Test of Cerawool (C-2) .....	9
17. Jacket Temperatures and Wind Speed for the Third Torch Fire Test of Cerawool (C-3) .....	9
18. Back Plate and Rear Enclosure Air Temperatures for the Third Torch Fire Test of Cerawool (C-3) .....	10
19. Bare Plate and Rear Enclosure Air Temperatures for the First Pool Fire Calibration Test .....	10
20. Bare Plate and Rear Enclosure Air Temperatures for the Second Pool Fire Calibration Test .....	10
21. Bare Plate and Rear Enclosure Air Temperatures for the Third Pool Fire Calibration Test .....	11
22. Bare Plate and Rear Enclosure Air Temperatures for the Fourth Pool Fire Calibration Test .....	11
23. Bare Plate and Rear Enclosure Air Temperatures for the Fifth Pool Fire Calibration Test .....	11
24. Bare Plate and Rear Enclosure Air Temperatures for the Sixth Pool Fire Calibration Test .....	11
25. Bare Plate and Rear Enclosure Air Temperatures for the Seventh Pool Fire Calibration Test .....	12
26. Bare Plate and Rear Enclosure Air Temperatures for the Eighth Pool Fire Calibration Test .....	12
27. Bare Plate and Rear Enclosure Air Temperatures for the Ninth Pool Fire Calibration Test .....	12
28. Bare Plate and Rear Enclosure Air Temperatures for the Tenth Pool Fire Calibration Test .....	12
29. Bare Plate and Rear Enclosure Air Temperatures for the Eleventh Pool Fire Calibration Test .....	12
30. Bare Plate and Rear Enclosure Air Temperatures for the Twelfth Pool Fire Calibration Test .....	12
31. Bare Plate and Rear Enclosure Air Temperatures for the Thirteenth Pool Fire Calibration Test .....	13
32. Jacket Temperatures and Wind Speed for the First Pool Fire Test of Kaowool (A-3) .....	13
33. Back Plate and Rear Enclosure Air Temperatures for the First Pool Fire Test of Kaowool (A-3) .....	13
34. Jacket Temperatures and Wind Speed for the Second Pool Fire Test of Kaowool (A-4) .....	14
35. Back Plate and Rear Enclosure Air Temperatures for the Second Pool Fire Test of Kaowool (A-4) .....	14
36. Jacket Temperatures and Wind Speed for the Third Pool Fire Test of Kaowool (A-5) .....	14
37. Back Plate and Rear Enclosure Air Temperatures for the Third Pool Fire Test of Kaowool (A-5) .....	14
38. Jacket Temperatures and Wind Speed for the Fourth Pool Fire Test of Kaowool (A-6) .....	15
39. Back Plate and Rear Enclosure Air Temperatures for the Fourth Pool	

	Fire Test of Kaowool (A-6) .....	15
40.	Jacket Temperatures and Wind Speed for the First Pool Fire Test of Fiberfrax (B-3) .....	15
41.	Back Plate and Rear Enclosure Air Temperatures for the First Pool Fire Test of Fiberfrax (B-3) .....	15
42.	Jacket Temperatures and Wind Speed for the Second Pool Fire Test of Fiberfrax (B-4) .....	16
43.	Back Plate and Rear Enclosure Air Temperatures for the Second Pool Fire Test of Fiberfrax (B-4) .....	16
44.	Jacket Temperatures and Wind Speed for the Third Pool Fire Test of Fiberfrax (B-5) .....	16
45.	Back Plate and Rear Enclosure Air Temperatures for the Third Pool Fire Test of Fiberfrax (B-5) .....	16
46.	Jacket Temperatures and Wind Speed for the First Pool Fire Test of Cerawool (C-4) .....	17
47.	Back Plate and Rear Enclosure Air Temperatures for the First Pool Fire Test of Cerawool (C-4) .....	17
48.	Jacket Temperatures and Wind Speed for the Second Pool Fire Test of Cerawool (C-5) .....	17
49.	Back Plate and Rear Enclosure Air Temperatures for the Second Pool Fire Test of Cerawool (C-5) .....	17
50.	Jacket Temperatures and Wind Speed for the Third Pool Fire Test of Cerawool (C-6) .....	18
51.	Back Plate and Rear Enclosure Air Temperatures for the Third Pool Fire Test of Cerawool (C-6) .....	18



## INTRODUCTION

The Ballistic Research Laboratory (BRL) was contracted by the Federal Railroad Administration (FRA) to conduct a series of exploratory fire tests of thermal insulation systems with respect to their application to the chlorine tank car. It had previously been established that at approximately 251 °C (483 °F), a serious corrosive reaction begins between dry chlorine and steel. Therefore, it was concluded that if a steel tank car loaded with liquid chlorine becomes exposed to a railroad accident fire and the shell temperature equals or exceeds that value for a long period, the development of a serious leak is inevitable. Thus, the objective of the test series was to generate data to serve as a basis for determining if the temperature could be held below that critical temperature using existing types of insulations and acceptable insulation thicknesses. The tests were conducted according to Department of Transportation (DOT) Regulations as presented in Title 49, Code of Federal Regulations (CFR), Part 179.105-4. The data indicates the thermal protection capability of the insulation systems tested exceeds the test criteria by a comfortable margin.

## DOT PERFORMANCE STANDARDS

The DOT Performance Standards are based on data generated in an extensive research program concerning the thermal protection of the propane tank car. The intention was to conduct these tests according to the performance standards, but due to the characteristics of the chlorine tank car and certain developments in the performance of the tests, some deviations from the standards were required. These are explained, but first the performance standards as cited in Title 49, CFR, Part 179.105-4 are presented.

Prior to actually testing an insulation system a pool fire calibration is required to verify that the torch fire facility is operating with sufficient efficiency that a proper pool fire environment can be created. A pool fire environment is a representative environment that a surface area of a tank car is exposed to while the tank car is engulfed in the flames of a pool fire. Such a pool fire would be a typical one which might occur at the site of a wrecked railroad train.

The requirements for the performance of a pool fire calibration test are as follows: "A pool fire environment shall be simulated in the following manner: (i) The source of the simulated pool fire shall be a hydrocarbon fuel. The flame temperature from the simulated pool fire shall be at 1,600 °F, plus or minus 100 °F, throughout the duration of the test. (ii) An uninsulated square steel plate (bare plate) with thermal properties equivalent to tank car steel shall be used. The plate dimensions shall be not less than one foot by one foot by nominal 5/8-inch thick. The plate shall be instrumented with not less than nine thermocouples to record the

thermal response of the plate. The thermocouples shall be attached to the surface not exposed to the simulated pool fire, and shall be divided into nine equal squares with a thermocouple placed in the center of each square. (iii) The pool fire simulator shall be constructed in a manner that results in total flame engulfment of the front surface of the bare plate. The apex of the flame shall be directed at the center of the plate. (iv) The steel plate holder shall be constructed in such a manner that the only heat transfer to the back side of the plate is by heat conduction through the plate and not by other heat paths. (v) Before the plate is exposed to the simulated pool fire, none of the temperatures shall be in excess of 100 °F, nor less than 32 °F. (vi) A minimum of two thermocouple devices shall indicate 800 °F after not less than 12 minutes nor, more than 14 minutes of simulated pool fire exposure."

A torch fire calibration test is required for the same reason as the pool fire calibration test except that the verification is to ascertain that an acceptable torch fire environment can be created. A torch fire environment is a simulation of the environment a tank car is exposed to when it has impinging on its outer surface a propane torch caused by a punctured propane tank car located nearby.

The required procedure for performing a torch fire calibration test is as follows: "A torch fire environment shall be simulated in the following manner: (i) The source of the simulated torch shall be a hydrocarbon fuel. The flame temperature from the simulated torch shall be 2,200 °F, plus or minus 100 °F, throughout the duration of the test. Torch velocities shall be 40 miles per hour plus or minus 10 miles per hour throughout the duration of the test. (ii) An uninsulated square steel plate with thermal properties equivalent to tank car steel shall be used. The plate dimensions shall be not less than four feet by four feet by nominal 5/8-inch thick. The plate shall be instrumented with not less than nine thermocouples to record the thermal response of the plate. The thermocouples shall be attached to the surface not exposed to the simulated torch and shall be divided into nine equal squares with a thermocouple placed in the center of each square. (iii) The steel-plate holder shall be constructed in such a manner that the only heat transfer to the back side of the plate is by heat conduction through the plate and not by other heat paths. The apex of the flame shall be directed at the center of the plate. (iv) Before exposure to the simulated torch, none of the temperature recording devices shall indicate a plate temperature in excess of 100 °F or less than 32 °F. (v) A minimum of two thermocouples shall indicate 800 °F in a time of 4.0 minutes, plus or minus 0.5 minutes of torch simulation exposure."

Whenever a successful calibration test is run, the same distance between the torch nozzle and the front surface of the bare plate must be used in the following test of an insulation system. The importance of that distance is easy

to understand, since naturally, the greater its value, the cooler is the flame at the front surface of the bare plate. For convenience in discussing the tests, this distance is referred to as the TN/SS Distance, where TN and SS implies torch nozzle and specimen surface, respectively.

The procedure for submitting an insulation system to the pool fire environment according to Title 49, CFR, Part 179.105-4 is as follows: "(i) The thermal insulation system shall cover one side of a steel plate identical to that used to simulate a pool fire. (ii) The uninsulated side of the steel plate shall be instrumented with not less than nine thermocouples placed as described above to record the thermal response of the steel plate. (iii) Before exposure to the pool fire simulation, none of the thermocouples on the thermal insulation system's steel plate configuration shall indicate a plate temperature in excess of 100 °F nor less than 32 °F. (iv) The entire insulated surface of the thermal insulation system shall be exposed to the simulated pool fire. (v) The pool fire simulation test shall run for a minimum of 100 minutes. (vi) A minimum of three successful simulation pool fire tests shall be performed for each thermal insulation system in question."

The procedure for submitting an insulation system to the torch fire environment according to Title 49, CFR, Part 179.105-4 is as follows: "(i) The thermal insulation system shall cover one side of a steel plate identical to that used to simulate a torch fire as described above. (ii) The back of the steel plate shall be instrumented with not less than nine thermocouples placed as described above to record the thermal response of the steel plate. (iii) Before exposure to the simulated torch, none of the thermocouples on the thermal insulation system steel plate configuration shall indicate a plate temperature in excess of 100 °F nor less than 32 °F. (iv) The entire outside surface of the thermal insulation system shall be exposed to the simulated torch fire environment. (v) A torch simulation test shall be run for a minimum of 30 minutes. (vi) A minimum of two successful torch simulation tests shall be performed for each thermal insulation system."

The word "successful" was used in the regulations to indicate that an insulation system had performed within the test criteria; and that a minimum of three successful pool fire tests and two successful torch fire tests are required in order for an insulation system to be judged an approved system. An assumption was that those tests to be used would be legitimate in that, from a physical standpoint, the regulations were met and nothing occurred which could be judged as a reason for concluding that the tests were unfair. The most frequent physical occurrence leading to a substandard test was the wind which tended to blow the torch flame off center. In the review of each test, BRL provided all of the data generated and pointed out problem areas for the benefit of FRA.

One of the procedural variations from the regulations was that the thickness of the steel back plate used in the insulation tests was 1.98 cm (0.779 in) rather than the 1.59 cm (5/8 in) as specified in Title 49, CFR, Part 149.105-4. That modification was made because many chlorine tank cars have a shell thickness of at least 1.98 cm (0.779 in). In addition, the steel plate was made of TC-128B steel to correspond to the typical chlorine tank car shell.

Another variation concerned the torch insulation tests. According to Title 49, CFR, Part 179.105-4, a separate torch calibration test must be performed prior to torch testing each type of insulation system. In this program, one successful torch calibration was conducted and then the three different insulation systems were tested without the benefit of additional calibration tests. The reason for this was that in the test plan the initial tests were reserved for the purpose of evaluating the insulation assembly configuration which contained significant modifications from that previously used. These initial tests showed the configuration worked well and therefore the tests were acceptable. Since there was great interest in pool fire tests, the following effort was expended in performing those tests rather than repeating the torch fire tests. The plan was to repeat those tests at a later date, but due to difficulties in performing successful pool fire calibration tests, that was not done. For that same reason no pool fire calibration test was performed between the pool fire testing of two of the insulation systems. That variation is explained in the section which presents the discussion on the pool fire tests.

#### THE TORCH FIRE FACILITY & TEST SETUP

The torch fire facility was designed to produce a large hydrocarbon fuel flame for impingement on the front surface of a test specimen so that its insulating qualities could be evaluated. The characteristics of the flame corresponded to the requirements cited Title 49, CFR, Part 179.105-4. Therefore, the facility was qualified as an approved system for testing insulation systems.

The basic structure of the torch was two 10.2 cm (4 in) diameter pipes leading vertically from a propane supply tank and then horizontally to the torch nozzle. One of the pipes was used to transport propane vapor while the other was used to transport liquid propane. Each pipe had a compressed air actuated valve which was used to regulate the propane flow rate. Prior to reaching the nozzle, the two pipes joined so that a mixture of liquid and vapor propane flowed through the nozzle. These valves were regulated by the torch operator remotely from inside an instrumentation and control trailer. In the tests, the propane valve was opened about 28.0 percent and the liquid valve was closed all the way. That combination of valve openings produced a flame with the desired thermal characteristics.

The configuration of the insulation test assembly holder and the supporting cart were as shown in Figure 1. The cart was setting on a track so that the TN/SS Distance could be changed to fit the need of a specific test. The holder, which actually supported the test specimen assembly, was mounted vertically on top of the cart. The holder consisted of a holder box, a rear flame shield, and a rear enclosure. On the test assembly and locations on the holder were mounted thermocouples. The leads to these thermocouples were passed through the six inch pipe indicated in Figure 1. The purpose of the rear flame shield was to prevent flames from wrapping around the holder box and heating up the outside surface of the rear enclosure. The inside surfaces of the holder box and the rear enclosure were lined with insulation, 5.08 cm (2 in) thick, to minimize the loss of heat. A thermal blanket was placed over the rear enclosure and the six inch pipe to further protect against significant heat transport out of or into the rear enclosure.

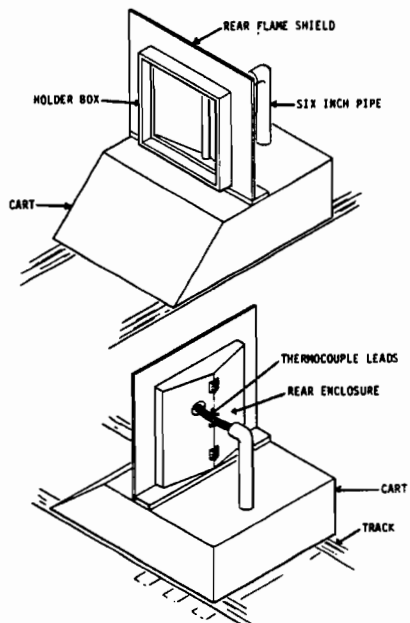

Figure 1: The Insulation Test Assembly Holder and Cart

The test specimen assembly consisted of a sandwich of thermal insulation, backed by a steel plate, referred to as the back plate, and covered on the front (toward the torch nozzle) by a eleven gauge steel plate, referred to as the jacket. This combination corresponded to a section of a jacketed type insulated tank car. The physical characteristics of the sandwich structure was as shown in Figure 2.

The back plate was the first component of the test assembly installed on the holder box. It was 1.22 meters squared (4 ft sq.) and 1.98 cm (0.779 in) thick. The design was such that the thickness of the plate extended completely beyond the front edge of the holder box. In the center of the front surface of the back plate was a standoff bracket. That bracket was similar to some of the standoff brackets used in the construction of chlorine tank cars. The bracket was 10.2 cm (4.0 in) high, 7.6 cm (3.0 in) wide, and 15.2 cm (6.0 in) long.

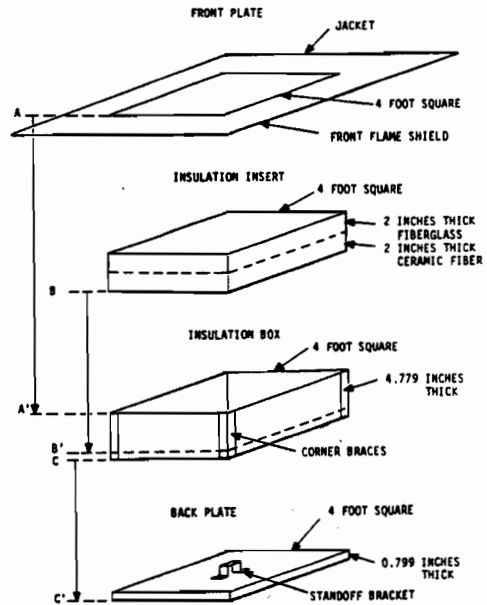

Figure 2: The Insulation Test Assembly

The second component of the insulation test assembly installed on the holder was the insulation box which fitted over the back plate and was deep enough to accommodate the thickness of the insulation. The insulation box was secured by clamping together metal lips welded on the edges of both boxes.

The insulation specimens were 1.22 meters (4 ft) squared and fitted snugly inside the insulation box. A three sided rectangular shaped incision made in the insulation accommodated the standoff bracket. The flap of insulation was pushed under the top of the bracket such that the steel bracket completed a short circuit due to the fact that no thermal insulation barrier was placed between the top of the bracket and the inner surface of the jacket. Such a barrier was not included because none exists in at least some of the chlorine tank cars. All other metal to metal surfaces were separated by a thermal barrier to preclude unauthorized heat conduction.

The jacket was the last component to be installed. An extension of jacket metal beyond the insulation box was for the purpose of diverting the torch flames to prevent them from heating the sides of the box. This extension was referred to as the front flame shield. About 10.2 cm (4 in) of insulation was placed over the sides of the insulation box and between the front and rear flame shields to reduce further the possibility of heat conduction through the sides. Insulation was stuffed under the insulation box and a row of fire bricks placed on top of the cart against the front of the jacket.

DATA ACQUISITION

The Data Acquisition System consisted of several devices which recorded with redundancy in order to minimize the chance of losing data. The key device in the system was the Fluke Data Logger which accepted 28 channels of measurements. The device transformed the signals into units consistent with the parameters measured and passed the data to other devices. Besides obtaining a permanent record, data concerning the operation of the facility was displayed for monitoring purposes. That was important because adjustments during testing were required to maintain an appropriate flame environment. More important, such monitoring would have provided information which could have warned of developing circumstances that would have warranted aborting the test for safety reasons.

Definitions of the 28 channels are listed in Table 1. In those cases where locations of measuring devices were defined by indicating right or left, the observer was assumed to be facing the rear of the holder. The temperature signals were immediately converted from millivolts to degrees Fahrenheit, tabulated, and stored. The other parameters listed were stored in millivolts (or volts) and converted later by the formulas given in Table 1.

The first nine channels provided the temperatures on the back plate. These were the most important set of data since they served as the basis for evaluating the insulation systems in question. The same nine channels were used to acquire temperatures on the back of the bare plate in calibration tests. The positions of the nine thermocouples were in accordance with the regulations presented in Title 49, CFR, Part 179.105-4. That is, in the center of each of nine equal size squares was attached a thermocouple. Viewing the back plate from the rear of holder, the signals for Channel Number 1 and Channel Number 9 were measured by thermocouples located in the centers of the top-left and the bottom-right squares, respectively. The others were located in numerical order; proceeding from left to right and top to bottom. The nine thermocouples in question were referred to as the back plate thermocouples.

There was interest in determining the conduction of heat to the back plate through the sides of the insulation box. Therefore, three thermocouples were installed near the edges of

the back plate. As noted in Table 1, the numerical designation for these thermocouples were 11, 12, and 13. These measurements were only taken during the testing of insulation systems.

TABLE 1: FLUKE DATA LOGGER CHANNELS

Channel Number	Parameter & Location
1	Temp. - Back Plate, Top Left Square
2	Temp. - Back Plate, Top Center Square
3	Temp. - Back Plate, Top Right Square
4	Temp. - Back Plate, Center Left Square
5	Temp. - Back Plate, Center Center Square
6	Temp. - Back Plate, Center Right Square
7	Temp. - Back Plate, Bottom Left Square
8	Temp. - Back Plate, Bottom Center Square
9	Temp. - Back Plate, Bottom Right Square
10	Temp. - Rear Enclosure, Free Air, Back
11	Temp. - Back Plate, Center Left Edge
12	Temp. - Back Plate, Center Top Edge
13	Temp. - Back Plate, Center Right Edge
14	Temp. - Rear Encl., Center Left Side
15	Temp. - Rear Encl., Center Left Door
16	Temp. - Rear Encl., Center Right Door
17	Temp. - Rear Encl., Center Right Side
18	Temp. - Jacket, Center Left Square
19	Temp. - Jacket, Top Center Square
20	Temp. - Jacket, Center Right Square
21	Temp. - Water Bath
22	Temp. - Torch Orifice
23	Speed (mph) = # mv/10, Wind
24	Direction (Deg) = # mv, Wind
25	Pressure (psi) = # mv x 10, Supply Tank
26	Percent Open = # v x 100, Liquid Valve
27	Percent Open = # v x 100, Vapor Valve
28	Pressure (psi) = # mv x 10, Torch Orifice

Channel Numbers 14 through 17 corresponded to thermocouples which were positioned outside the rear enclosure and mounted directly on the steel surface. The purpose of these measurements was to determine if a substantial amount of heat was lost through these surfaces. The term "center" refers to the middle of the surface and half way up the holder. The side of the rear enclosure was taken to be the surface behind the rear flame shield. Thermocouples were mounted on the back of the jacket to measure the level of the temperature on the front surface of the insulation. These proved to be quite useful for monitoring the location of the torch flame relative to the center of the jacket. The channels used for this purpose were Numbers 18 through 19, which were in line with the back plate thermocouples 4, 2, and 6, respectively. The wind speed and direction were recorded on Channels 23 and 24, respectively. The remaining channels were used to record values which indicated important information concerning the operation of the facility. All of these were displayed on the console.

While the data from all active channels were available, only the back plate (or bare plate) temperatures, the rear enclosure air temperature, the jacket temperatures, and the wind velocity were considered for this report.

## SUMMARY OF TESTS

The test program was designed to obtain temperature data for three insulation systems. The thickness of each was 10.16 cm (4 in), with 5.08 cm (2 in) of a type of ceramic fiber placed next to the back plate and 5.08 cm (2 in) of fiberglass placed between the ceramic fiber and the jacket. Table 2 presents the densities of the test specimens for each system. The ceramic fiber types were Kaowool, Fiberfrax, and Cerawool which were manufactured by the Babcock & Wilcox Company, the Corborundum Company, and the John Manville Company, respectively. The fiberglass specimens were manufactured by the Owens Corning Company.

TABLE 2: DENSITIES OF THE INSULATION SPECIMENS

ID Number	Fiberglass Densities		Ceramic Fiber Densities	
	(kg/cu m)	(lbs/cu ft)	(kg/cu m)	(lbs/cu ft)
Kaowool				
A-1	9.14	0.686	55.2	4.14
A-2	9.22	0.692	58.4	4.38
A-3	9.44	0.708	49.5	3.71
A-4	9.24	0.693	44.5	3.34
A-5	9.33	0.700	49.1	3.68
A-6	9.08	0.681	48.5	3.64
A-7	9.21	0.691	51.6	3.87
A-8	9.22	0.692	53.7	4.03
A-9	9.28	0.696	58.9	4.42
A-10	9.34	0.701	52.9	3.97
Fiberfrax				
B-1	9.21	0.691	57.7	4.33
B-2	9.25	0.694	67.8	5.09
B-3	9.24	0.693	60.4	4.53
B-4	9.18	0.689	67.6	5.07
B-5	9.02	0.677	65.9	4.94
B-6	9.40	0.705	67.6	5.07
B-7	9.29	0.697	70.0	5.25
B-8	9.28	0.696	69.3	5.20
B-9	9.25	0.694	67.0	5.03
B-10	9.15	0.687	67.4	5.06
Cerawool				
C-1	9.36	0.702	52.6	3.95
C-2	9.16	0.687	47.6	3.57
C-3	9.29	0.697	52.8	3.96
C-4	9.32	0.699	54.1	4.06
C-5	9.14	0.686	54.9	4.12
C-6	9.28	0.696	54.0	4.05
C-7	9.01	0.676	55.6	4.17
C-8	9.24	0.693	55.5	4.16
C-9	9.44	0.708	54.5	4.09
C-10	9.12	0.684	53.2	3.99

Table 3 presents a list of tests performed. The first nine consisted of two torch fire calibrations and seven torch fire tests on insulation systems. The remaining were pool fire tests consisting of 13 calibrations and 10 on insulation systems. The large number of pool fire calibrations were required due to difficulty in achieving one with satisfactory results

because of wind effects. As a consequence, the additional torch fire tests were cancelled and no calibration was performed between the pool fire tests on the Fiberfrax and the Cerawool insulation systems.

The Identification Number attached to each of the tests was generated on the following basis. The first two letters signifies that the test was performed using the torch facility. The six following numbers indicates the day, the month, and the year in which the test was performed. The following three letters are to provide some indication of the purpose of the test. In this case, CHL indicates chlorine. The last letter designates the run of the day. For example, an "A" would indicate the first test, a "B" the second test, and so forth.

TABLE 3: SUMMARY OF TESTS PERFORMED

No.	I.D. Number	Test Specimen	Test Type
1	TF-06-03-84-CHL-A	Bare	Torch
2	TF-07-03-84-CHL-A	Bare	Torch
3	TF-07-03-84-CHL-B	(A-1)	Torch
4	TF-08-03-84-CHL-A	(A-2)	Torch
5	TF-09-03-84-CHL-A	(B-1)	Torch
6	TF-09-03-84-CHL-B	(B-2)	Torch
7	TF-10-03-84-CHL-A	(C-1)	Torch
8	TF-12-03-84-CHL-A	(C-2)	Torch
9	TF-13-03-84-CHL-A	(C-3)	Torch
10	TF-13-03-84-CHL-B	Bare	Pool
11	TF-14-03-84-CHL-A	Bare	Pool
12	TF-15-03-84-CHL-A	Bare	Pool
13	TF-04-04-84-CHL-A	Bare	Pool
14	TF-04-04-84-CHL-B	Bare	Pool
15	TF-04-04-84-CHL-C	Bare	Pool
16	TF-05-04-84-CHL-A	(A-3)	Pool
17	TF-07-04-84-CHL-A	(A-4)	Pool
18	TF-08-04-84-CHL-A	(A-5)	Pool
19	TF-08-04-84-CHL-B	(A-6)	Pool
20	TF-10-04-84-CHL-A	Bare	Pool
21	TF-10-04-84-CHL-B	Bare	Pool
22	TF-11-04-84-CHL-A	Bare	Pool
23	TF-11-04-84-CHL-B	Bare	Pool
24	TF-12-04-84-CHL-A	Bare	Pool
25	TF-13-04-84-CHL-A	Bare	Pool
26	TF-19-06-84-CHL-A	Bare)	Pool
27	TF-20-06-84-CHL-A	(B-3)	Pool
28	TF-21-06-84-CHL-A	(B-4)	Pool
29	TF-22-06-84-CHL-A	(B-5)	Pool
30	TF-25-06-84-CHL-A	(C-4)	Pool
31	TF-27-06-84-CHL-A	(C-5)	Pool
32	TF-28-06-84-CHL-A	(C-6)	Pool

### TORCH FIRE CALIBRATION TESTS

The bare plate temperatures and the rear enclosure air temperature for the first of two torch fire calibration tests are presented in Figure 3. The bare plate temperatures rose smoothly, but the rear enclosure air temperature began to increase unrealistically at about 3.75 minutes. With no physical explanation available, the rapid increase was attributed to some temporary flaw in the data acquisition system. In addition, several of the temperatures exceeded 427 °C (800 °F) prior to 3.5 minutes. As a con-



The temperature data for the back plate and the air in the rear enclosure for the first Kaowool torch fire test are presented in Figure 6. The values measured by Thermocouple Number 5 exceeded those measured by the others because of its location behind the metal standoff bracket. Ambient values persisted for five minutes, then the temperatures measured by Number 5 began to increase, followed by the others at about seven minutes. The slow temperature rise of the back plate provided time for the air temperature in the rear enclosure to maintain the same rise rate. That was a characteristic prevalent in all tests of insulation systems. The final temperatures at 30 minutes ranged from 66 °C (150 °F) to 93 °C (200 °F). An exception was the value due to the Number 5 Thermocouple which was just under 121 °C (250 °F). The smooth rise in the temperatures and the small spread in the curves reflected the steady environment indicated by the jacket temperatures and the speed data.

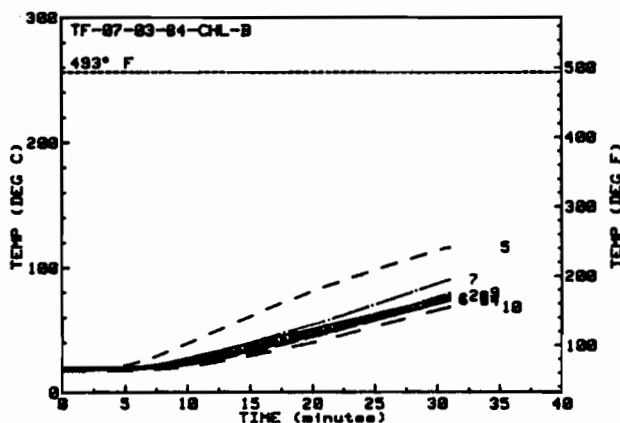

Figure 6: Back Plate and Rear Enclosure Air Temperatures for the First Torch Fire Test of Kaowool (A-1)

Figure 7 contains the jacket temperatures and the wind speed for the second torch fire test of the Kaowool-Fiberglass System. There were several large peaks in the wind speed that far exceeded the desired wind speed criteria. The highest value reaching above 12 km/hr (7.46 mi/hr). At 25 minutes, a peak in the jacket temperatures showed a clear correlation with the wind speed. However, the other peaks caused only slight variations in the temperatures. The jacket temperatures essentially matched the values from the previous test.

The back plate temperatures and rear enclosure air temperatures for the second torch fire test of Kaowool are presented in Figure 8. The back plate temperatures are similar to those values from the first test, but the curves are spread out more. This was probably due to variations in the wind speed. Even so, the results appeared satisfactory.

The Kaowool-Fiberglass System easily passed the 251 °C (483 °F) test criteria. Except for

Number 5, none of the thermocouples measured values above 93 °C (200 °F).

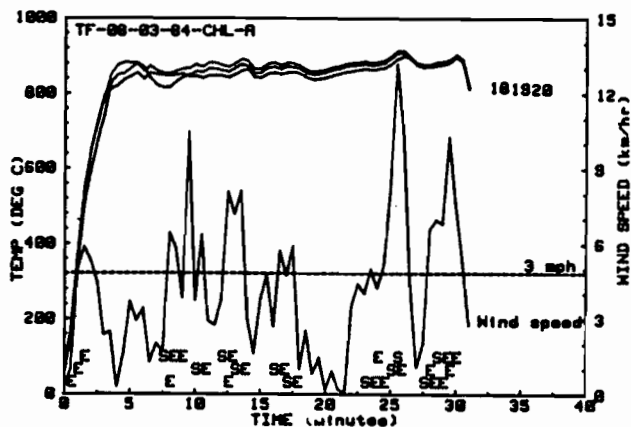

Figure 7: Jacket Temperatures and Wind Speed For the Second Torch Fire Test of Kaowool (A-2)

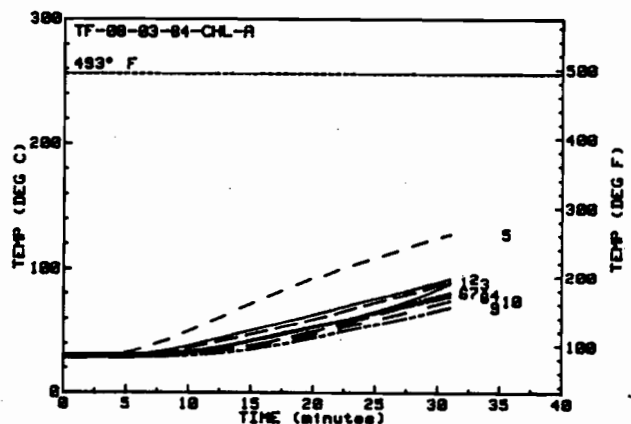

Figure 8: Back Plate and Rear Enclosure Air Temperatures for the Second Torch Fire Test of Kaowool (A-2)

The jacket temperatures and the wind speed for the first torch fire test of the Fiberfrax-Fiberglass System (B-1) are presented in Figure 9. The wind speed was less than the speed criteria for the entire test period except for several small peaks. The spread of the jacket temperature curves indicated that the flame was not as steady as in previous tests, but the values of the temperatures were similar.

The back plate temperatures and the rear enclosure air temperature as a function of time are presented in Figure 10. The closely clustered back plate temperature curves showed that the heat transport across the plate was uniform. The values of the temperatures were similar to those obtained in the torch fire tests on Kaowool, but the final values were lower by about 17 °C (30°F).

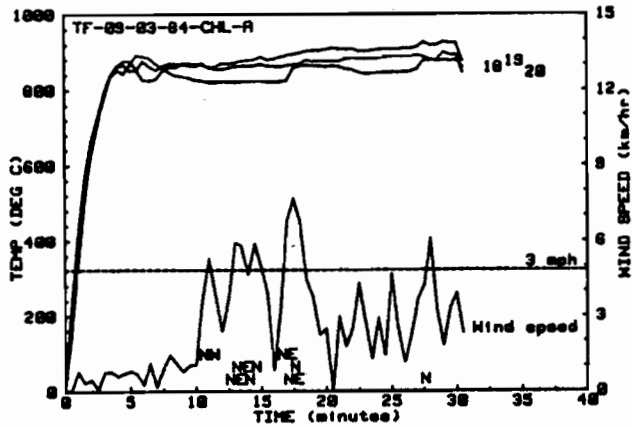

Figure 9: Jacket Temperatures and Wind Speed for the First Torch Fire Test of Fiberfrax (B-1)

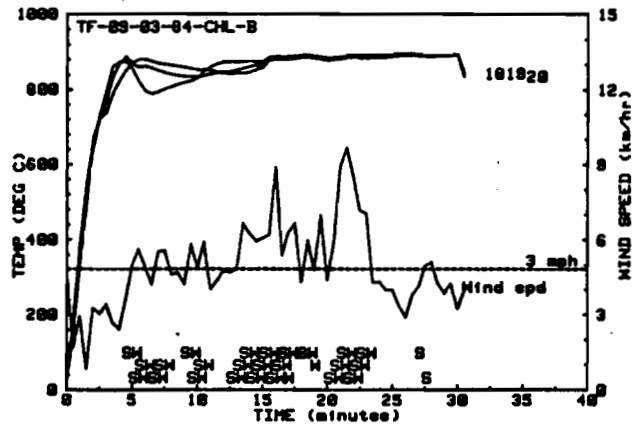

Figure 11: Jacket Temperatures and Wind Speed for the Second Torch Fire Test of Fiberfrax (B-2)

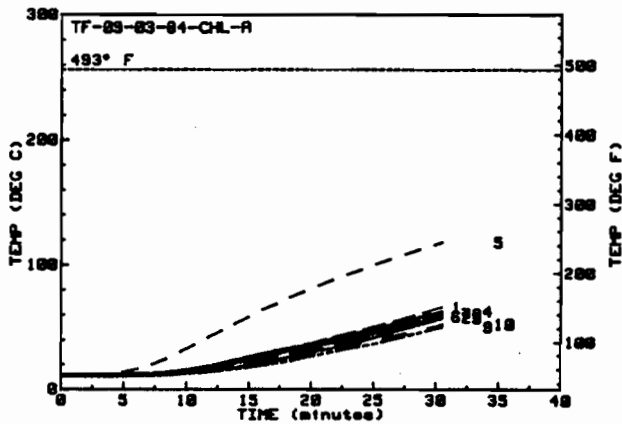

Figure 10: Back Plate and Rear Enclosure Air Temperatures for the First Torch Fire Test of Fiberfrax (B-1)

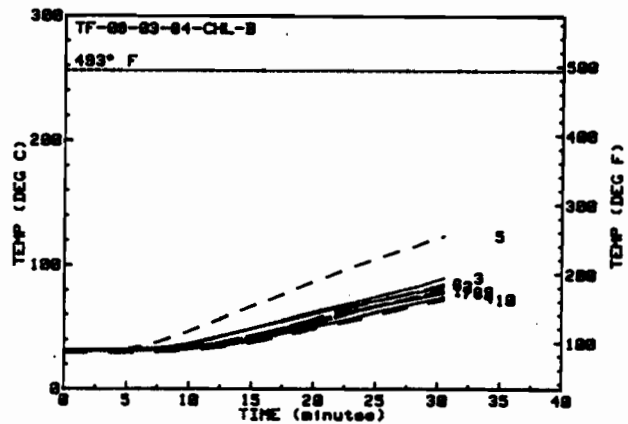

Figure 12: Back Plate and Rear Enclosure Air Temperatures for the Second Torch Fire Test of Fiberfrax (B-2)

The jacket temperatures and wind speed as a function of time for the second torch fire test on the Fiberfrax-Fiberglass System (B-2) are shown in Figure 11. The back plate temperatures and rear enclosure air temperature as a function of time are presented in Figure 12. While the wind was significantly greater (exceeding by far the test criteria), the results from this test were only slightly higher than in the first test. The jacket temperatures again averaged around 871 °C (1600 °F). The final back plate temperatures were beneath the test criteria by about 149 °C (300 °F).

The data from the first torch fire test on Cerawool-Fiberglass System (C-1) are shown in Figures 13 and 14. Immediately after the start of the test, the speed of the wind jumped to 15 km/hr (9.5 mi/hr), but then fell below the wind speed criteria. This apparently did not affect the jacket temperatures because the three jacket temperature curves remained close to each other. The approximate average of the jacket temperatures was 871 °C (1600 °F). The final back plate temperatures ranged from 66 °C (150 °F) to 93 °C (200 °F). Overall, this test was a near perfect run.

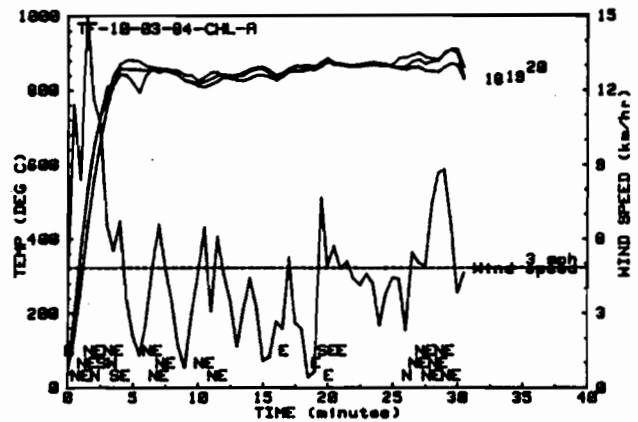

Figure 13: Jacket Temperatures and Wind Speed for the First Torch Fire Test of Cerawool (C-1)



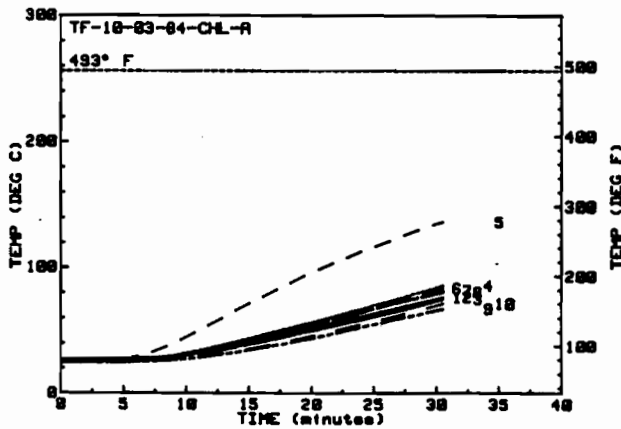

Figure 14: Back Plate and Rear Enclosure Air Temperatures for the First Torch Fire Test of Cerawool (C-1)

Unexpected trouble occurred on the second test of the Cerawool-Fiberglass System (C-2). The insulation which had been placed on the outside of the insulation box and between the two flame shields fell away very early in the test. This apparently caused an uneven heating of the interior of the test assembly. The spread in the jacket temperature curves, shown in Figure 15, reflects the uneven effect since Thermocouple Number 20 measured much higher values. The incident was unfortunate because the wind was calm throughout the test.

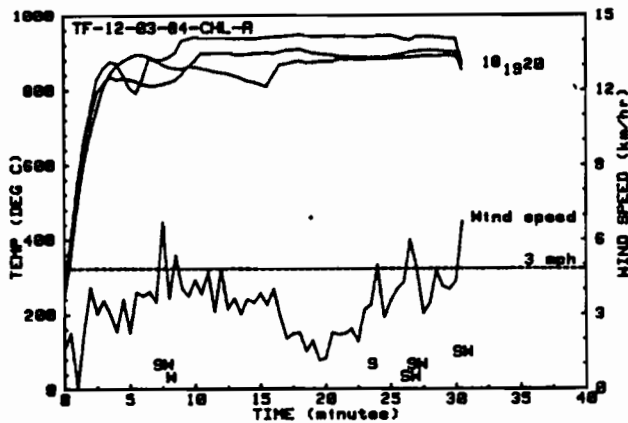

Figure 15: Jacket Temperatures and Wind Speed for the Second Torch Fire Test of Cerawool (C-2)

The back plate and rear enclosure air temperatures for the second test of Cerawool, shown in Figure 16, were slightly higher than in the first test. Even though the results appeared to be acceptable, it was decided that the program would be served best by repeating the test.

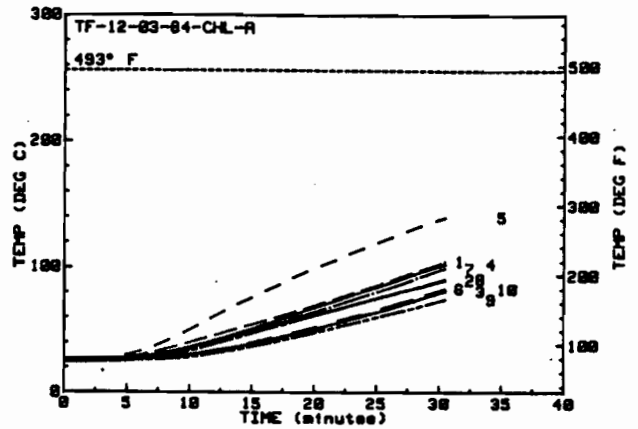

Figure 16: Back Plate and Rear Enclosure Air Temperatures for the Second Torch Fire Test of Cerawool (C-2)

The third test on the Cerawool-Fiberglass System (C-3) was a success. The jacket temperatures, presented in Figure 17, again averaged about 871 °C (1600 °F) over the run period. The final back plate temperatures, presented in Figure 18, were again in the range between 66 °C (150 °F) and 93 °C (200 °F). These data are similar to those from the first test of Cerawool, but the back plate temperature curves are slightly more spread out.

These torch fire tests indicate that for a valid test, the jacket temperatures should reach approximately 871 °C (1600 °F) in about four minutes and remain in that region throughout the remainder of the test. Since the flame temperature has been determined to be 1204 °C (2200 °F) at the TN/SS Distance at which a torch fire test is conducted, the effect of the jacket is to effectively reduce the temperature by 315 °C (600 °F). The comparison of results between tests show that if the wind is relatively calm, torch fire tests can be essentially duplicated. The results indicate that all three insulations systems have comparable thermal protection qualities well below the test criteria.

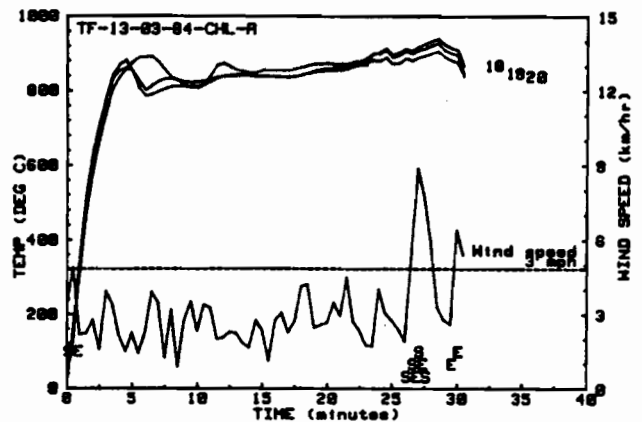

Figure 17: Jacket Temperatures and Wind Speed for the Third Torch Fire Test of Cerawool (C-3)

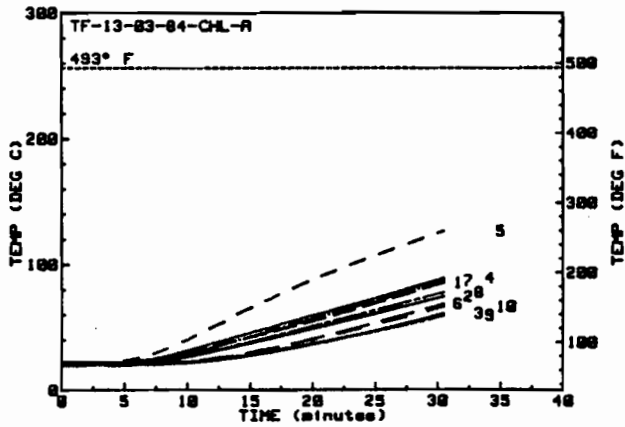

Figure 18: Back Plate and Rear Enclosure Air Temperatures for the Third Torch Fire Test of Cerawool (C-3)

POOL FIRE CALIBRATION TESTS

A total of thirteen pool fire calibration tests were conducted in the program. In the formulation of the work plan, it was anticipated that no more than six would be needed because the tests were to be conducted during a season when the wind speeds are normally low. However, as the discussion which follows indicates, the wind seriously affected the torch flame even though a special effort was made to wait for a calm period during each day. Such a "window" had the greatest probability of occurring at dawn and dusk. A list of the tests are presented in Table 5, where the successes or failures are noted. The primary result was the determination that the best value for the TN/SS Distance was 6.45 meters (21.5 ft).

TABLE 5: POOL FIRE CALIBRATION TESTS

Test Number	Initial Plate Temperature		TN/SS Distance (Meters)	TN/SS Distance (Feet)	Successful?
	(°F)	(°C)			
10	68	20	6.45	21.5	No
11	46	8	6.60	22.0	No
12	75	24	6.45	21.5	Yes
13	39	9	6.45	21.5	No
14	95	35	6.45	21.5	No
15	80	27	6.45	21.5	Yes
20	87	31	6.45	21.5	No
21	80	27	6.45	21.5	No
22	45	7	6.45	21.5	No
23	82	28	6.45	21.5	No
24	85	29	6.45	21.5	No
25	63	17	6.45	21.5	Yes
26	58	14	6.40	21.0	No

The first three tests listed in Table 5 were conducted in preparation for testing the insulation system consisting of Fiberglass and Kaowool. The data for the first one are presented in Figure 19. The wind remained below the speed criteria for approximately seven minutes and then exceeded the criteria for most of the remainder of the test. With the advent of the speed increase, the slope of the temperature curves changed appreciably. This indicated a slowing of the heat deposition behind the plate. As a consequence, two of the plate measurements

exceeded the temperature criteria before 12 minutes by a small margin and the test was considered to have been below standard. The wind was from the side, and therefore, it pushed the flame off the center of the plate. However, the slopes of the early parts of the temperature curves indicated that the test would have failed anyway because the heating of the plate was too rapid. The reason was due to the effect of a south wind which tended to increase the effective TN/SS Distance that was actually set at 6.45 meters (21.5 ft). At any rate, it was decided to repeat the test before moving on to the testing of the Kaowool-Fiberglass Insulation System.

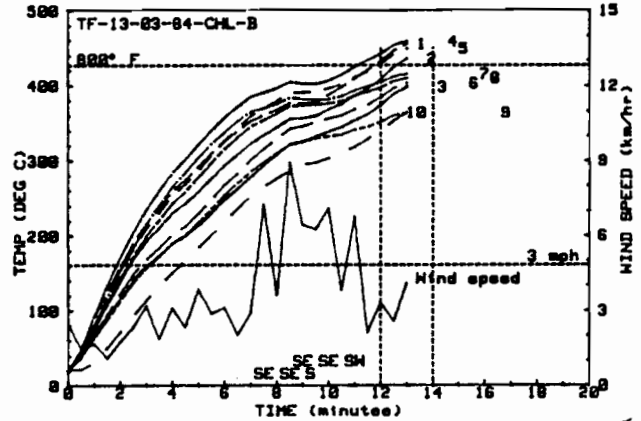

Figure 19: Bare Plate and Rear Enclosure Air Temperatures for the First Pool Fire Calibration Test

As a consequence of the failure of the first test, it was decided to increase the TN/SS Distance to 6.6 meters (22 ft) in the hopes that the initial temperature rise would not be as great. The data from the second test are presented in Figure 20. The wind speed remained below the test criteria. Unfortunately, the heat deposition was low throughout the test and the test failed by a large margin. The conclusion was that the TN/SS Distance was too long.

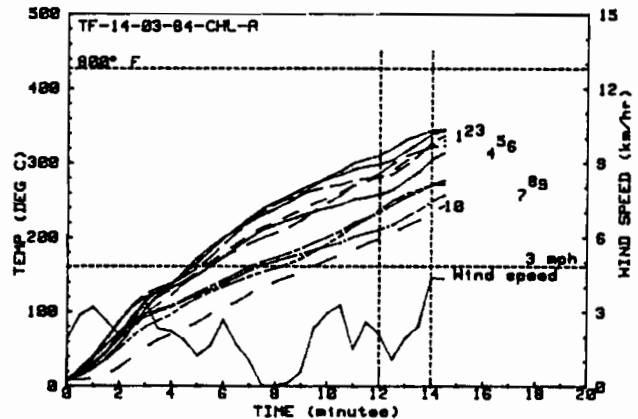

Figure 20: Bare Plate and Rear Enclosure Air Temperatures for the Second Pool Fire Calibration Test

The third test of the group resulted in a success in that five of the back plate thermocouples reached the temperature criteria in the appropriate time interval. While this was within the requirements of the regulation, a review of the temperature curves in Figure 21 showed that at about 8 minutes into the test the wind speed increased and thereby caused the rate of heat deposition to decrease; otherwise the test may have again failed. Even so, it was decided to conduct tests on insulations with a TN/SS Distance of 6.45 meters (21.5 ft); the distance used in this test. Unfortunately, the wind speeds of the following days were unfavorable such that additional tests could not be performed in the remaining time available in the March test period.

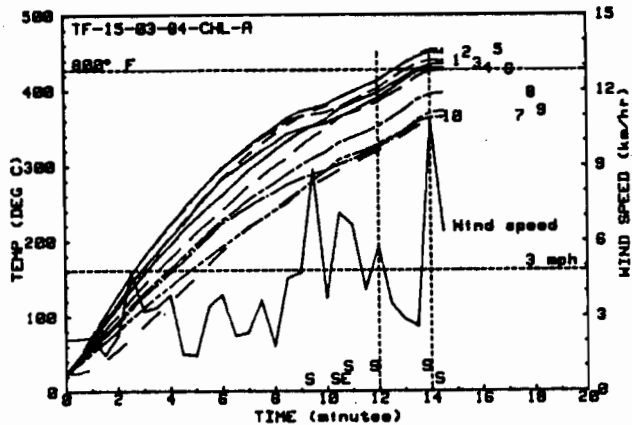

Figure 21: Bare Plate and Rear Enclosure Air Temperatures for the Third Pool Fire Calibration Test

The next three tests listed in Table 5 were the initial ones conducted in the two week test period of April 1984. Figure 22 presents the bare plate temperatures from the first test. The test failed to meet the criteria by a large margin. It was discovered that the wind indicator had a malfunction, therefore, the values were probably affected a great deal by the wind.

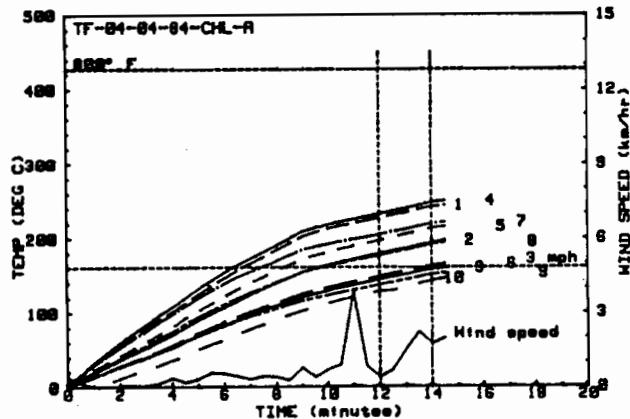

Figure 22: Bare Plate and Rear Enclosure Air Temperatures for the Fourth Pool Fire Calibration Test

The results from the second test performed in this group are shown in Figure 23. A north wind speed above the test criteria effectively cooled the flame. The initial slopes of the curves started at what appeared to be correct, but the final values fell short of the temperature criteria and caused the test to be a disqualification.

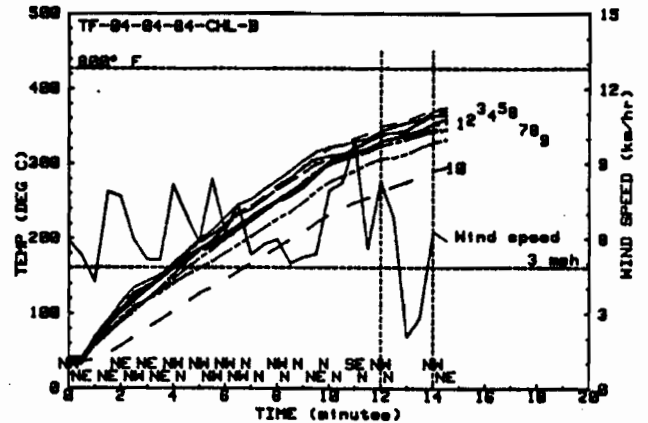

Figure 23: Bare Plate and Rear Enclosure Air Temperatures for the Fifth Pool Fire Calibration Test

The third calibration test of this group was successful as can be seen by the data presented in Figure 24. The general shape of the curves indicate no drastic effects from the wind and a number of the thermocouple measurements reached the temperature criteria in the appropriate time interval. The TN/SS Distance of 6.45 meters (21.5 ft) used in these three tests was used in the pool fire tests of Kaowool-Fiberglass Insulation System which followed.

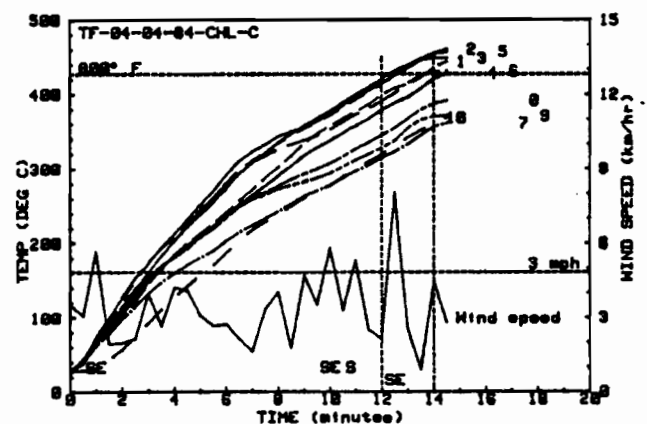

Figure 24: Bare Plate and Rear Enclosure Air Temperatures for the Sixth Pool Fire Calibration Test

The next six tests listed in Table 5 were conducted following the Kaowool pool fire tests and in preparation for testing the Fiberfrax-Fiberglass Insulation System. The wind caused the first five to fail (Figures 25 through 29). The sixth test (Figure 30) was successful since the wind was calm. However, the Fiberfrax System could not be tested because the wind was too unfavorable to attempt a 100 minute test.

The torch fire test results had indicated that the performance of the insulation systems in providing thermal protection easily exceeded the test criteria and it was expected that the same would hold true in the pool fire tests. Therefore, for the purpose of minimizing wind effects, a test was run at a shorter TN/SS Distance in anticipation of a successful calibra-

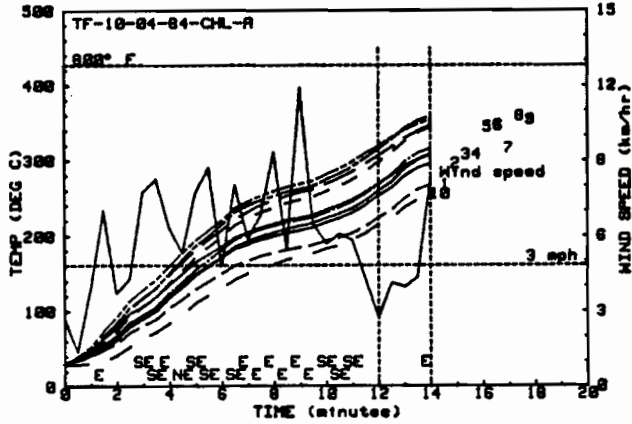

Figure 25: Bare Plate and Rear Enclosure Air Temperatures for the Seventh Pool Fire Calibration Test

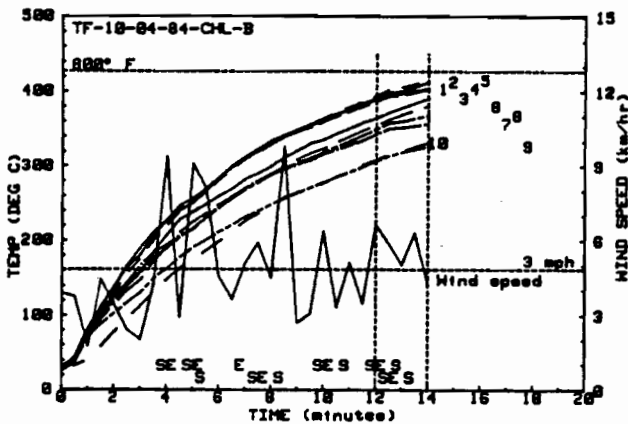

Figure 26: Bare Plate and Rear Enclosure Air Temperatures for the Eighth Pool Fire Calibration Test

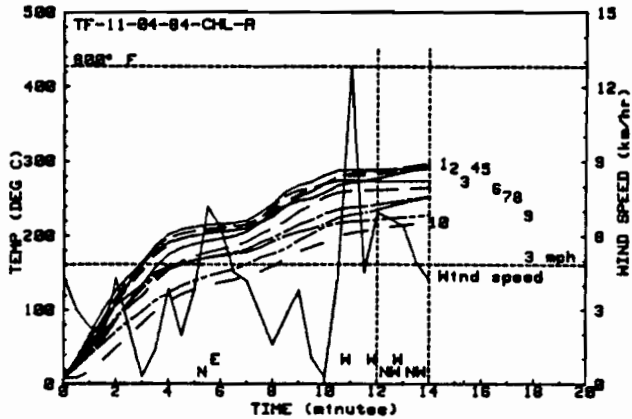

Figure 27: Bare Plate and Rear Enclosure Air Temperatures for the Ninth Pool Fire Calibration Test

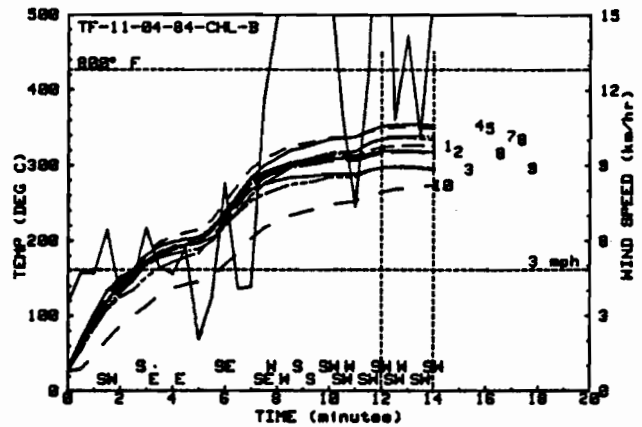

Figure 28: Bare Plate and Rear Enclosure Air Temperatures for the Tenth Pool Fire Calibration Test

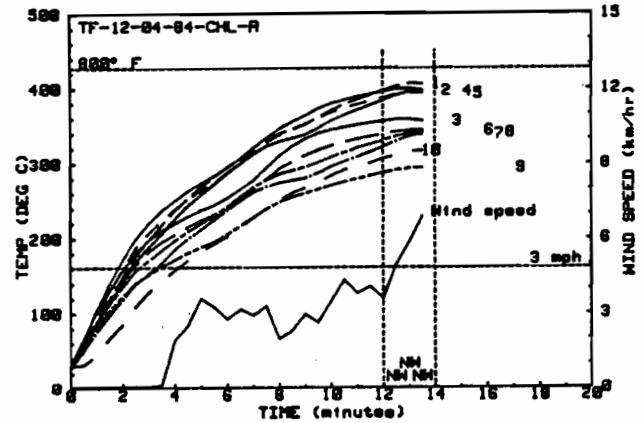

Figure 29: Bare Plate and Rear Enclosure Air Temperatures for the Eleventh Pool Fire Calibration Test

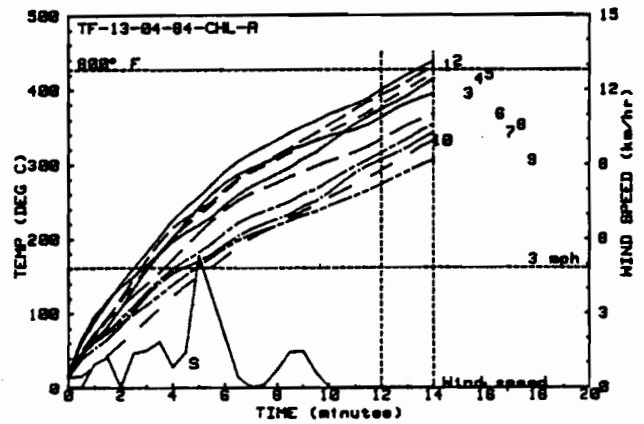

Figure 30: Bare Plate and Rear Enclosure Air Temperatures for the Twelfth Pool Fire Calibration Test

tion test. The TN/SS Distance of 6.4 meters (21 ft) was used. The results, plotted in Figure 31, indicated the flame had been too hot and hence the test failed. That failure verified that the correct TN/SS Distance was 6.55 meters (21.5 ft) as was determined previously. Due to wind difficulties and resources, no more calibration tests were performed.

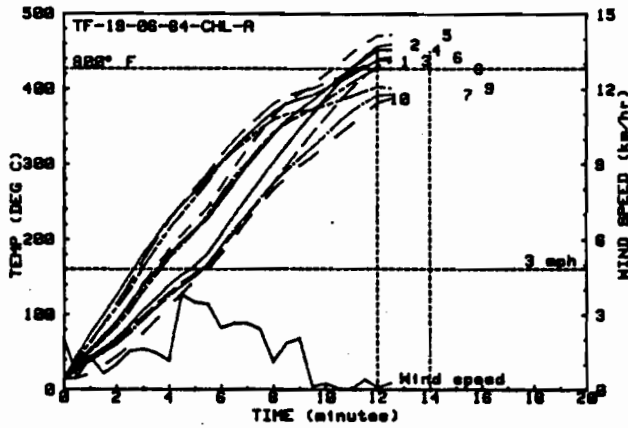

Figure 31: Bare Plate and Rear Enclosure Air Temperatures for the Thirteenth Pool Fire Calibration Test

POOL FIRE INSULATION TESTS

A total of nine pool fire tests were made on the three insulation systems in question. As with the calibration tests, these tests were more affected by the wind than were the torch fire tests because of the longer TN/SS Distance. At the torch fire TN/SS Distance the flow of the gases in the flame were stronger, thus, the task of deflecting the flame was more difficult. In any case, the tests were successful and the data verified the torch tests in that the insulation systems again easily qualified under the thermal criteria of 251 °C (483 °F). Table 6 summarizes the initial conditions for the pool fire tests. All of the tests were conducted with the initial back plate temperatures within the temperature range cited in the regulation except for the last test where the average value was around 37.8 °C (100 °F). The same TN/SS Distance of 6.55 meters (21.5 ft) was used in all of these pool fire tests.

TABLE 6: INITIAL CONDITIONS OF POOL FIRE TESTS

Test Number	Back Plate Temperature (°C)	Back Plate Temperature (°F)	Wind Speed (km/hr)	Supply Tank Pressure (kg/sq cm)	Vapor Valve Opening (%)
16	36.1	97.0	3.60	157	28.2
17	16.1	61.0	4.50	160	28.1
18	10.0	50.0	0.08	158	28.1
19	32.8	91.0	5.74	162	28.1
27	0.61	69.0	0	155	28.9
28	22.8	73.0	2.27	158	28.9
29	25.0	77.0	3.80	155	28.9
30	31.1	88.0	0.02	155	29.6
31	31.7	89.0	0.03	155	28.9
32	37.8	100.0	1.69	156	28.9

The first insulation system tested was the Fiberglass-Kaowool combination. Figure 32 shows plots of the jacket temperatures and wind speeds for the first of four tests (A-3). The back plate temperature curves for this test are presented in Figure 33. For approximately 60 minutes, the jacket temperatures oscillated around 621 °C (1150 °F) while the wind speed averaged near the speed criteria. The wind was generally from the south and southeast. At 60

minutes, the wind speed suddenly increased to around 9 km/hr (5.6 mi/hr). In turn, the jacket temperatures plummeted to 427 °C (800 °F) over the following 20 minutes. As the wind speed increased, the direction changed to the southwest. The flame was blown off the center of the test specimen and, although the nozzle was adjusted to bring the flame back on center, the curved flame was still cooler. Number 18 Thermocouple malfunctioned due to a loose connection in the wire leading from the thermocouple and therefore measured unrealistic results.

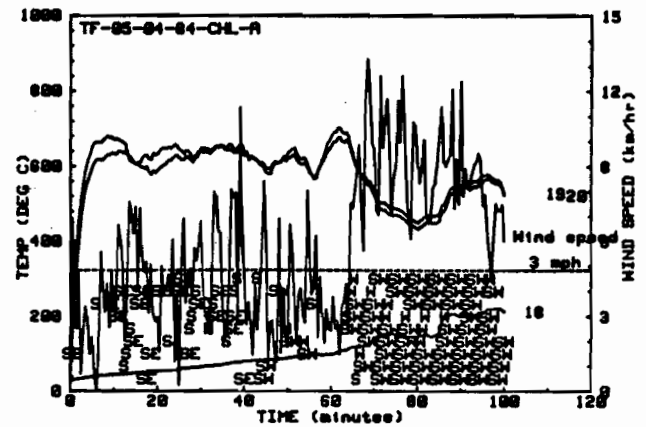

Figure 32: Jacket Temperatures and Wind Speed for the First Pool Fire Test of Kaowool (A-3)

The back plate and the rear enclosure air temperatures are presented in Figure 33. At 80 minutes, the Number 5 Thermocouple data made a drastic drop. That was no doubt due to the large reduction in the jacket temperatures. The Number 5 Thermocouple, located behind the stand-off bracket, was more sensitive to the flame environment. Except for Number 5, the top three thermocouples (Numbers 1, 2, and 3) measured the highest temperatures. That was due to a tendency of the flame to rise. The rear enclosure air temperature remained at the same level as the lower part of the back plate. The maximum back plate temperature fell far below the test criteria of 251 °C (483 °F).

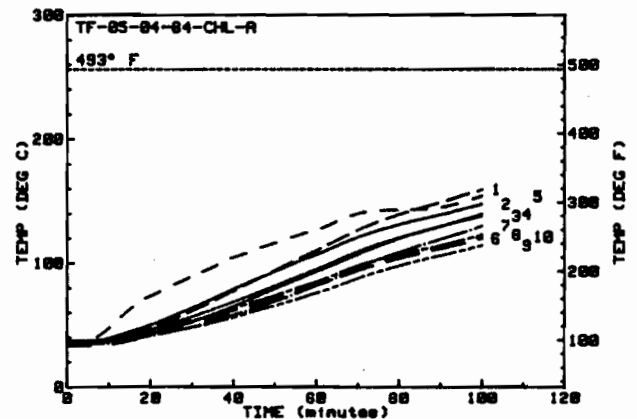

Figure 33: Back Plate and Rear Enclosure Air Temperatures for the First Pool Fire Test of Kaowool (A-3)

The jacket temperatures and the wind speed for the second pool fire test of the Kaowool-Fiberglass Insulation System (A-4) are presented in Figure 34. The wind speed remained below the test criteria for much of the test period, but exceeded that greatly between 30 and 60 minutes and as a consequence the jacket temperatures dropped. The oscillating form of the jacket temperature curves reflected fluctuations in the flame due to wind effects. In addition, the jacket temperature curves showed a spread which indicated that the torch flame was not always on the center of the test specimen. At 80 minutes, the wind died down and the jacket temperatures showed a gradual rise. The values averaged near 538 °C (1000 °F).

The back plate and rear enclosure air temperatures for the second test on Kaowool are presented in Figure 35. A drop in the Number 5 Thermocouple temperature correlates with a similar drop in the jacket temperatures at 40 minutes. Such a correlation is not apparent in the remaining curves. Except for Number 5, none of the back plate measurements showed a significant temperature rise for 20 minutes.

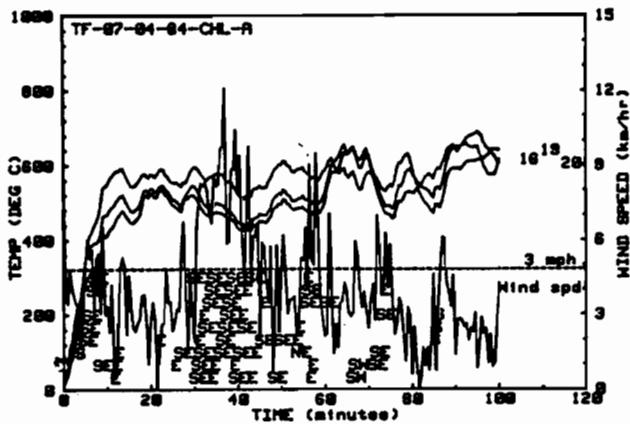

Figure 34: Jacket Temperatures and Wind Speed for the Second Pool Fire Test of Kaowool (A-4)

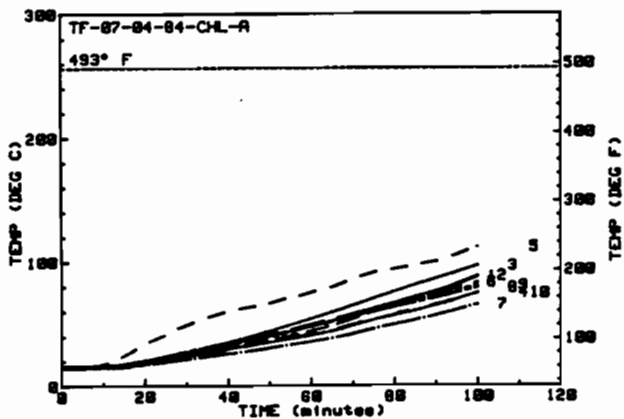

Figure 35: Back Plate and Rear Enclosure Air Temperatures for the Second Pool Fire Test of Kaowool (A-4)

Figure 36 presents the jacket temperatures and the wind speed for the third pool fire test of the Kaowool-Fiberglass Insulation System (A-5). The wind speed oscillated during the test, but it remained below the test criteria. Consequently, the jacket temperature curves oscillated uniformly throughout the test. The average value was near 538 °C (1000 °F). The environment was generally cooler than that which existed in the second test. The back plate and rear enclosure air temperatures for the third Kaowool test are shown in Figure 37. While the curves are spread out, there are no unusual dips or rises. The final values indicate the cooler environment alluded to above.

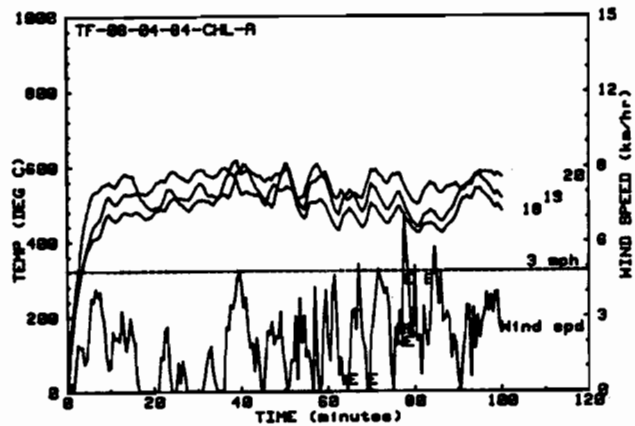

Figure 36: Jacket Temperatures and Wind Speed for the Third Pool Fire Test of Kaowool (A-5)

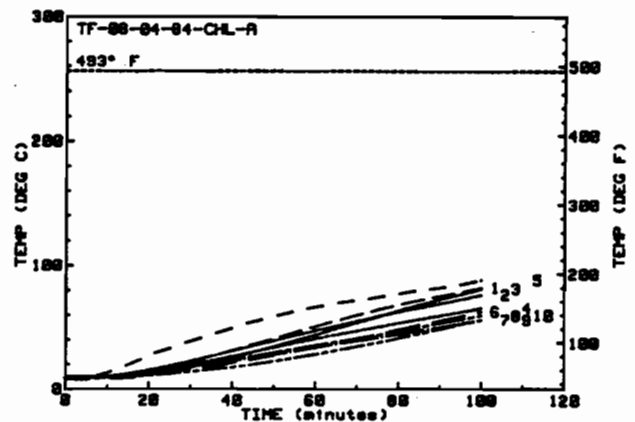

Figure 37: Back Plate and Rear Enclosure Air Temperatures for the Third Pool Fire Test of Kaowool (A-5)

The jacket temperatures and the wind speed for the fourth test on the Kaowool-Fiberglass System (A-6) are presented in Figure 38. The wind speed remained fairly low for approximately 40 minutes. At that time it increased and at 60 minutes increased again. The jacket temperatures responded accordingly. That is, the jacket

temperatures fell gradually from about 600 °C (1112 °F) down to about 550 °C (1022 °F). In addition to the increase in speed, the direction of the wind switched from south to north. The former caused the over all environment to be more severe than in the previous test.

The back plate and rear enclosure air temperatures are presented in Figure 39. The spread in the back plate temperature curves appear normal with the warmest measurement having been made by the top thermocouples. The one exception being Thermocouple Number 5. Overall, these temperatures were warmer than in the previous tests due to the warmer environment. In addition, the initial back plate temperatures were higher in this test, and thus contributed to the higher values.

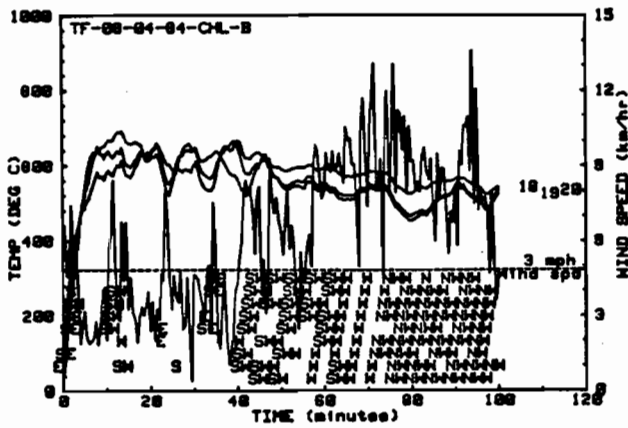

Figure 38: Jacket Temperatures and Wind Speed for the Fourth Test Pool Fire Test of Kaowool (A-6)

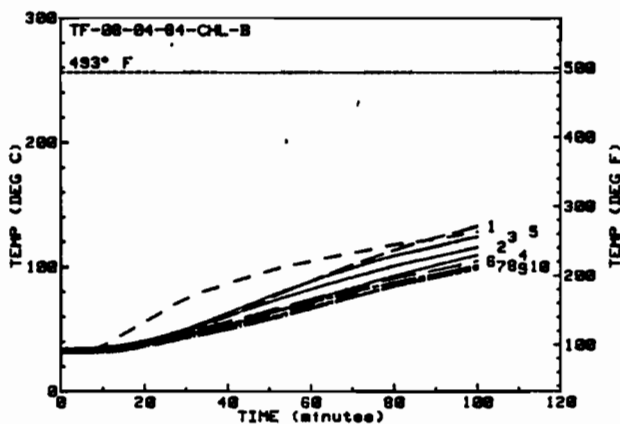

Figure 39: Back Plate and Rear Enclosure Air Temperatures for the Fourth Pool Fire Test of Kaowool (A-6)

The Fiberfrax-Fiberglass Insulation System was tested during the next three pool fire tests. The jacket temperatures and the wind speed for the first of these (B-3) are presented in Figure 40. The wind was nonexistent for about 55 minutes and the jacket temperatures were

similar to those obtained in previous tests. At around 80 minutes, the speed increased and the jacket temperatures dropped in response. The jacket temperatures oscillated around 621 °C (1150 °F) for 30 minutes, during which the wind was calm. Starting at 30 minutes, the wind speed increased continually throughout the remainder of the test period. The jacket temperatures gradually fell such that by the end of the test their values had dropped to approximately 427 °C (800 °F). The wind was generally from the north which effectively reduced the environment temperature.

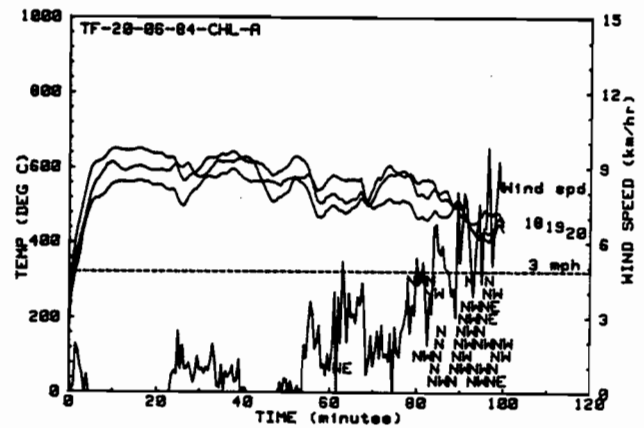

Figure 40: Jacket Temperatures and Wind Speed for the First Pool Fire Test of Fiberfrax (B-3)

The temperatures of the back plate and the air in the rear enclosure for the first pool fire test of the Fiberfrax-Fiberglass Insulation System are presented in Figure 41. The shape of the temperature curve from data measured by Thermocouple Number 5 indicates that the torch environment during the early part of the test was warmer than that which existed later. There is some spread in the temperature curves with an average of about 93.3 °C (200 °F) for the final values.

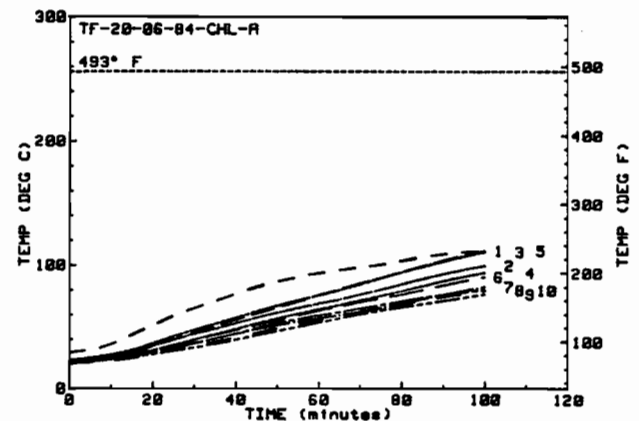

Figure 41: Back Plate and Rear Enclosure Air Temperatures for the First Pool Fire Test of Fiberfrax (B-3)

The jacket temperatures and the wind speed for the second pool fire test of Fiberfrax (B-4) are presented in Figure 42. The wind was calm during the test and the temperatures behind the jacket appeared to have been at a reasonable level. However, at about 65 minutes, the torch flame began to cool. It was discovered that the air compressor had failed and the control valves did not therefore operate. Termination of the test occurred at 80 minutes.

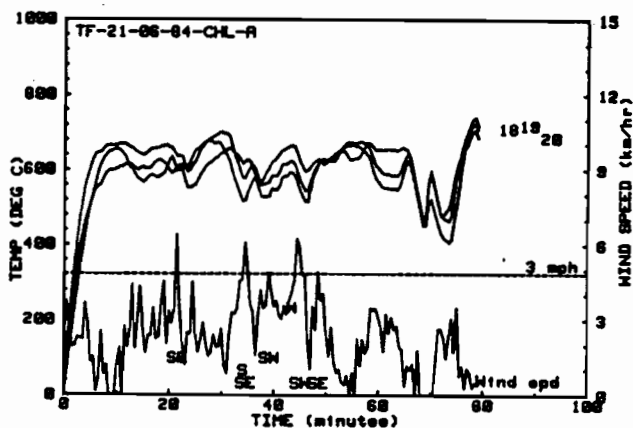

Figure 42: Jacket Temperatures and Wind Speed for the Second Pool Fire Test of Fiberfrax (B-4)

The back plate and the rear enclosure air temperatures for the second pool fire test of the Fiberfrax-Fiberglass System are presented in Figure 43. The final back plate temperatures did not exceed 121 °C (250 °F), but the test was not successful because of the air compressor problem and the early termination. The fate of this test is an example of potential problems which may arise in a test program.

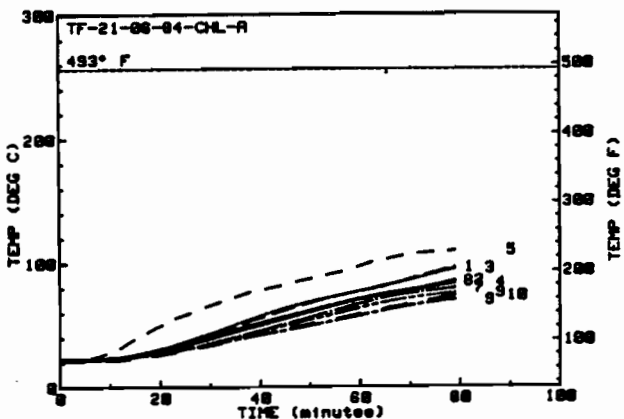

Figure 43: Back Plate and Rear Enclosure Air Temperatures for the Second Pool Fire Test of Fiberfrax (B-4)

The jacket temperatures and the wind speed for the third pool fire test of the Fiberfrax-Fiberglass System (B-5) are presented in Figure 44. This was the only test in which the wind speed was above the test criteria at the start.

The wind had accelerated in the short interval between the decision to perform the test and torch ignition. The jacket temperatures reached 677 °C (1250 °F) in about four minutes and, by 30 minutes, had obtained the value of 704 °C (1300 °F). The wind speed then dropped below the speed criteria and the jacket temperatures in turn decreased to 621 °C (1150 °F).

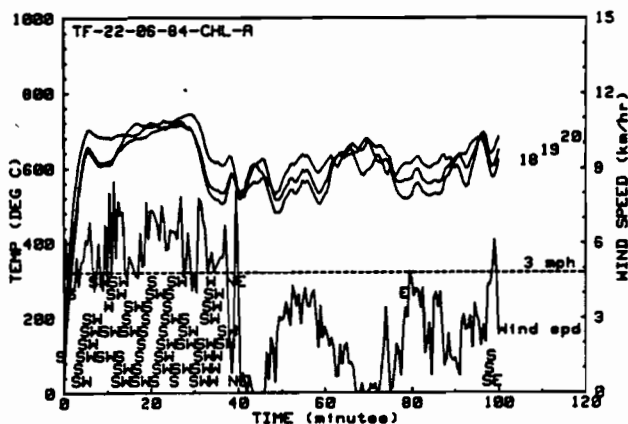

Figure 44: Jacket Temperatures and Wind Speed for the Third Pool Fire Test of Fiberfrax (B-5)

The back plate temperature data for the second pool fire test of the Fiberfrax-Fiberglass System, shown in Figure 45, reflects the high initial jacket temperatures and the sudden temperature drop. The initial torch environment was severe when compared to previous test data. Even so, the back plate temperatures did not exceed 149 °C (300 °F).

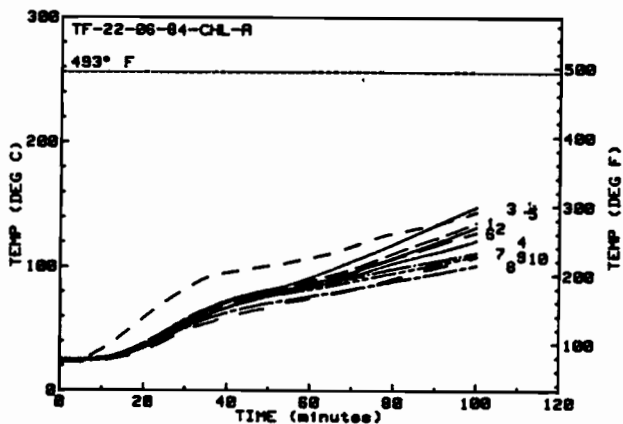

Figure 45: Back Plate and Rear Enclosure Air Temperatures for Third Pool Fire Test of Fiberfrax (B-5)

The jacket temperatures and wind speed for the first pool fire test of the Cerawool-Fiberglass Insulation System (C-4) are presented in Figure 46. The jacket temperatures stayed around 663 °C (1225 °F) which was hotter than usual. A dip occurred at 40 minutes due to an unexpected drop in the supply tank pressure. The problem was corrected and the flame returned



to normal. Overall the flame was fairly steady since the wind was low. However, the spread in the jacket temperature curves indicated that the torch flame was not on center much of the time.

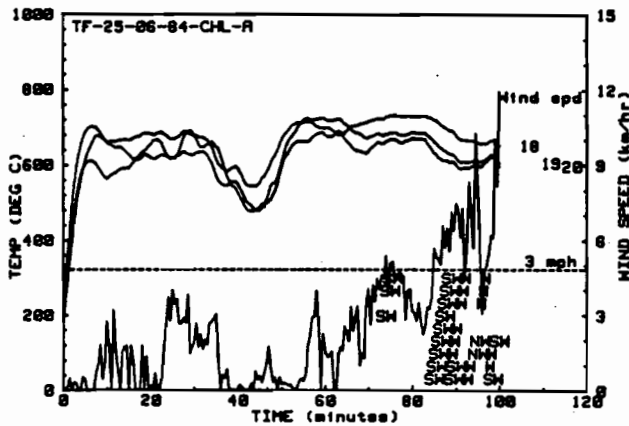

Figure 46: Jacket Temperatures and Wind Speed for the First Pool Fire Test of Cerawool (C-4)

The back plate and rear enclosure air temperatures for the first pool fire test of the Cerawool-Fiberglass Insulation System are shown in Figure 47. The curves have a definite dip which corresponds to the dip already noted in the jacket temperature curves. The spread in the curves is greater than in previous tests on the other insulation systems but this may be a reflection of an unsteady torch flame environment. The final back plate temperatures were slightly higher than those values obtained in tests of the other systems due to the more severe environment.

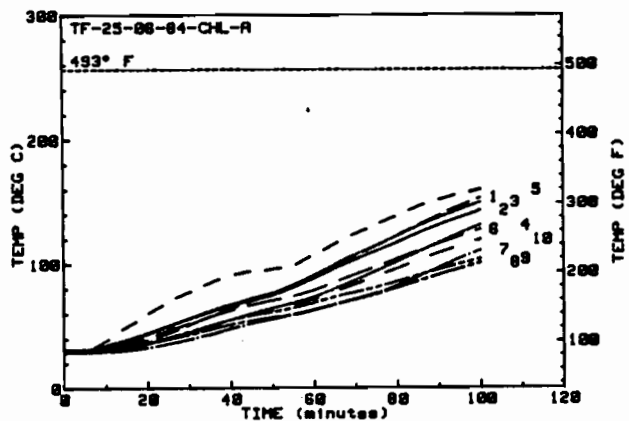

Figure 47: Back Plate and Rear Enclosure Air Temperatures for the First Pool Fire Test of Cerawool (C-4)

The jacket temperatures and wind speed for the second pool fire test of the Cerawool-Fiberglass System (C-5) are presented in Figure 48. The jacket temperatures started out in the neighborhood of 649 °C (1200 °F). A dip occurred at approximately 40 minutes due to a gust of

wind from the east. For the next 20 minutes, the temperatures oscillated around 621 °C (1150 °F), then the wind increased in speed and shifted to the northeast. This caused the temperatures to fall to 454 °C (850 °F). At the completion of the test, the jacket temperatures were at the 538 °C (1000 °F) level.

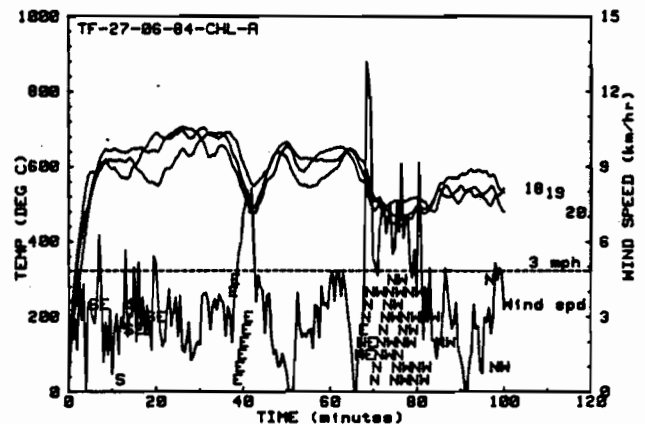

Figure 48: Jacket Temperatures and Wind Speed for the Second Pool Fire Test of Cerawool (C-5)

The temperatures for the back plate and the air in the rear enclosure for the second pool fire test of the Cerawool-Fiberglass Insulation System are presented in Figure 49. These curves reflect the dip at 40 minutes and the decline in the jacket temperatures toward the end of the test. The shapes of the curves are similar to those from the last test with the exception that they are clustered closer together.

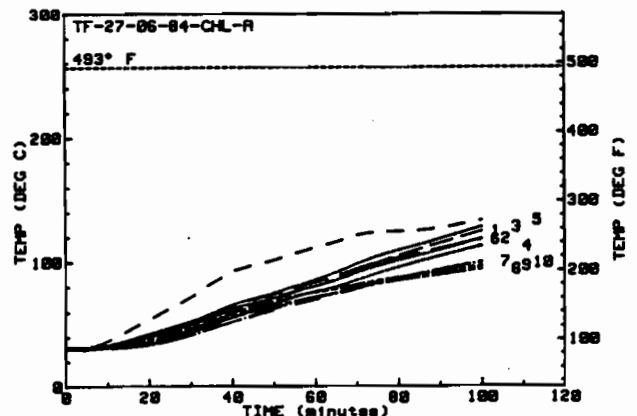

Figure 49: Back Plate and Rear Enclosure Air Temperatures for the Second Pool Test of Cerawool (C-5)

The third pool fire test of the Cerawool-Fiberglass Insulation System (C-6) was the best test of that system. The jacket temperatures and wind speed are presented in Figure 50. They oscillated around 649 °C (1200 °F) during the entire test. The wind speed was fairly low and blew from the southeast. There were no large dips, therefore the data reflected a relatively steady torch flame.

The back plate temperatures for this test

are presented in Figure 51. The curves are smooth with no humps or dips. The spread in the curves show that the flame heated the test specimen more at the top and progressively less toward the bottom. This trend was caused by the natural tendency of the torch flame to rise.

SUMMARY

A total of 32 tests were conducted in this program. These were two torch fire calibration tests, seven torch fire insulation tests, 13 pool fire calibration tests, and 10 pool fire insulation tests. The primary objective of the program was to determine if an insulation system could in fact hold the shell temperature of a tank car below 251 °C (483 °F) for the periods and environments prescribed in Title 49, Code of Federal Regulations, Part 179. 105-4 (as of November 1983). This thermal performance level was achieved by all three insulation systems tested. It seems that the use of thinner layers of ceramic fibers would be adequate, but these would require being tested before a judgement can be made with confidence.

In addition to generating the desired test data, the equipment and test procedures were improved. The insulation test assembly was re-designed, so that in effect, a front flame shield was added. Therefore, no flames were permitted to wrap around the edges of the test specimen. This ensured the prevention of heat transport through the sides. Because of the new design, a substantial amount of labor was saved in setting up a test. Also, the amount of material required for each test was reduced. For example, it was shown that a jacket survives a pool fire test and can be reused a number of times. A very important consequence was the establishment of the fact that the wind was the dominate factor which reduced the quality of data produced in pool fire tests and, therefore, a shield is recommended. Such a device could reduce a program's cost by enabling an efficient test crew to perform a minimum of two acceptable tests per day.

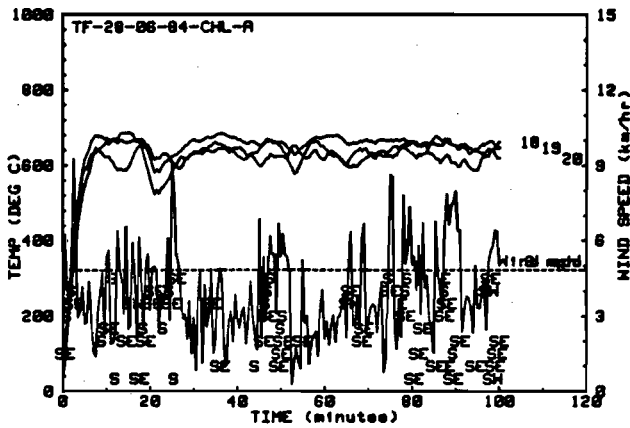

Figure 50: Jacket Temperatures and Wind Speed for the Third Pool Fire Test of Cerawool (C-6)

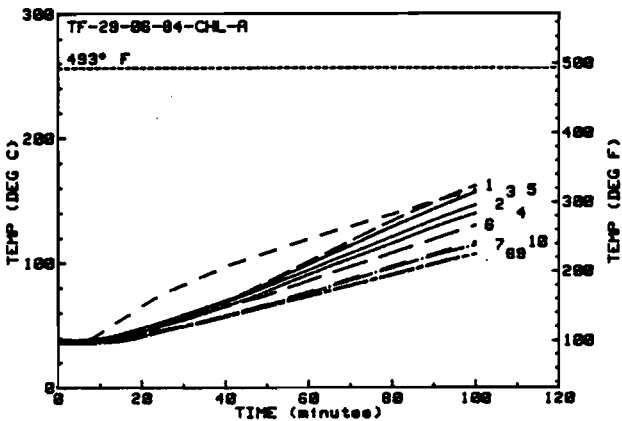

Figure 51: Back Plate and Rear Enclosure Air Temperatures for the Third Pool Fire Test of Cerawool C-6)

The pool fire test results show that some effective method for neutralizing wind effects provides the greatest potential for improving the quality of the pool fire test data. This can only be realized by the installation of an effective wind shield. In the event a shield becomes available, the calibration tests may indicate a different TN/SS Distance. Based on the data obtained in this series of tests, the probable jacket temperature for the pool fire environment is around 621 °C (1150 °F), plus or minus 28 °C (50 °F). The most important conclusion which can be drawn from the pool fire tests is that the thermal protection performance of all three insulation systems easily exceeded the thermal test criteria.



