



U.S. Department  
of Transportation

**Federal Railroad  
Administration**

# Fire Tests on Insulation for Aluminum Tank Cars

---

Office of Research and  
Development  
Washington, DC 20590

An evaluation of glass fiber, ceramic  
fiber, and mineral fiber materials in  
torch-fire and pool-fire environments

William G. Larson

Transportation Test Center  
Association of American Railroads  
Box 11130  
Pueblo, CO 81001

### **Notice**

This document is disseminated under the sponsorship of the Department of Transportation in the interest of information exchange. The United States Government assumes no liability for the contents or use thereof.

The United States Government does not endorse products or manufacturers. Trade or manufacturers' names appear herein solely because they are considered essential to the object of this report.

1. Report No. DOT/FRA/ORD-87/04	2. Government Accession No.	3. Recipient's Catalog No.	
4. Title and Subtitle <b>Fire Tests on Insulation for Aluminum Tank Cars</b> An evaluation of fiber glass, ceramic fiber, and mineral fiber materials in torch-fire and pool-fire environments		5. Report Date August, 1987	
		6. Performing Organization Code	
7. Author(s) William G. Larson		8. Performing Organization Report No. 86-121	
9. Performing Organization Name and Address Transportation Test Center Association of American Railroads Box 11130 Pueblo, CO 81001		10. Work Unit No. (TRAIS)	
		11. Contract or Grant No. DIFR53-82-C-00282	
12. Sponsoring Agency Name and Address Federal Railroad Administration Office of Research & Development 400 Seventh Street S.W. Washington, DC 20590		13. Type of Report or Period Covered Final	
		14. Sponsoring Agency Code	
15. Supplementary Notes			
16. Abstract  <p>Tests were conducted at the Transportation Test Center to determine the vulnerability to fire of aluminum tank cars designed to transport hazardous materials under pressure when the aluminum was protected by three types of insulation. Glass, mineral, and ceramic fiber blankets, each covering a specimen of aluminum plate commonly used in tank car construction, were subjected to standard torch-fire and pool-fire tests while instrumentation recorded the rise in temperature of the aluminum plate. The tests were conducted per the procedures described in CFR Title 49, Part 179.105-4, "Thermal Protection," with the exception that the aluminum plate was substituted for the specified steel plate. The data derived from the tests will be used by the FRA to build the information base required for an examination of the vulnerability of aluminum tank cars to both mechanical and thermal accidents. This report presents details of the 20 tests performed by the Research &amp; Test Department of the Association of American Railroads. It compares the thermal protective qualities of the three individual types of insulation covering the aluminum and includes a comparative test series on bare aluminum plate.</p>			
17. Key Words Aluminum Fire tests Insulation Tank car		18. Distribution Statement Available from: National Technical Information Service Springfield, VA 22161	
19. Security Classification (of this report) Unclassified	20. Security Classification (of this page) Unclassified	21. No. of Pages 30	22. Price

# METRIC CONVERSION FACTORS

Approximate Conversions to Metric Measures				Approximate Conversions from Metric Measures			
Symbol	When You Know	Multiply by	To Find	Symbol	When You Know	Multiply by	To Find
<b>LENGTH</b>							
in	inches	2.54	centimeters	mm	millimeters	0.04	inches
ft	feet	30	centimeters	cm	centimeters	0.4	inches
yd	yards	0.9	meters	m	meters	3.3	feet
mi	miles	1.6	kilometers	km	kilometers	1.1	yards
						0.6	miles
<b>AREA</b>							
in <sup>2</sup>	square inches	6.5	square centimeters	cm <sup>2</sup>	square centimeters	0.16	square inches
ft <sup>2</sup>	square feet	0.09	square meters	m <sup>2</sup>	square meters	1.2	square yards
yd <sup>2</sup>	square yards	0.8	square meters	m <sup>2</sup>	square kilometers	0.4	square miles
mi <sup>2</sup>	square miles	2.6	square kilometers	km <sup>2</sup>	hectares (10,000 m <sup>2</sup> )	2.5	acres
	acres	0.4	hectares	ha			
<b>MASS (weight)</b>							
oz	ounces	28	grams	g	grams	0.035	ounces
lb	pounds	0.45	kilograms	kg	kilograms	2.2	pounds
	short tons (2000 lb)	0.9	tonnes	t	tonnes (1000 kg)	1.1	short tons
<b>VOLUME</b>							
teaspoon	teaspoons	5	milliliters	ml	milliliters	0.03	fluid ounces
fluid ounce	fluid ounces	30	milliliters	ml	liters	2.1	pints
cup	cups	0.24	liters	l	liters	1.06	quarts
quart	quarts	0.95	liters	l	liters	0.26	gallons
gallon	gallons	3.8	liters	l	cubic meters	36	cubic feet
cubic foot	cubic feet	0.03	cubic meters	m <sup>3</sup>	cubic meters	1.3	cubic yards
yd <sup>3</sup>	cubic yards	0.76	cubic meters	m <sup>3</sup>			
<b>TEMPERATURE (exact)</b>							
°F	Fahrenheit temperature	5/9 (after subtracting 32)	Celsius temperature	°C	Celsius temperature	9/5 (then add 32)	Fahrenheit temperature

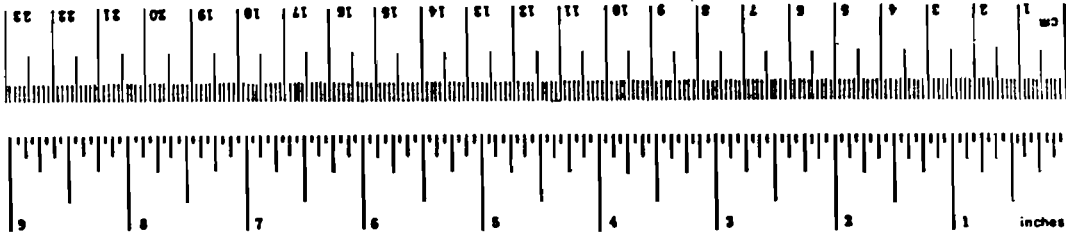

\* 1 in. = 2.54 (exact). For other exact conversions and more detailed tables, see NBS Misc. Publ. 286, Units of Weights and Measures, Price \$2.25, SD Catalog No. C13.10 286.

# Contents

1.0 Introduction	1
2.0 DOT Performance Standards	2
2.1 Pool Fire Simulation Test Series	2
2.2 Torch Fire Simulation Test Series	2
2.3 Modifications of CFR Performance Standard	2
3.0 The Torch Test Facility	3
3.1 Data Acquisition and Monitoring System	3
3.2 Propane Transfer and Pressurization Systems	4
3.3 Torch and Torch Nozzle Positioning Systems	4
3.4 Wind Shield	4
3.5 Test Cart and Specimen Holder	4
4.0 Test Specimens	5
4.1 Uninsulated Aluminum Plate	5
4.2 Glass Fiber-Insulated Aluminum Plate	5
4.3 Ceramic Fiber-Insulated Aluminum Plate	6
4.4 Mineral Fiber-Insulated Aluminum Plate	6
5.0 Tests Performed	7
6.0 Test Results	8
6.1 First Test Series: Uninsulated Aluminum Plate	8
6.2 Second Test Series: Glass Fiber-Insulated Aluminum Plate	9
6.3 Third Test Series: Ceramic Fiber-Insulated Aluminum Plate	11
6.4 Fourth Test Series: Mineral Fiber-Insulated Aluminum Plate	12
7.0 Summary and Conclusions	15
8.0 Appendix	17
A: Specimen Graphs of Jacket Temperatures, Wind Speed and Direction	17
B: Calibration Test Graphs, Bare Plate Temperatures and Wind Speed and Direction	21
C: Test Standard, 49 CFR Part 179.105-4, "Thermal Protection"	25
D: Related Materials	28

## Exhibits

Table 1:	Fluke data logger channel assignments	3
Table 2:	Test specimens	5
Table 3:	Tests performed	7
Figure 1:	Front and rear views of test cart and specimen holder	4
Figure 2:	Exploded view of specimen holder	4
Figure 3:	Results of torch fire simulation on uninsulated aluminum plate	8
Figure 4:	Results of torch fire simulation on insulated aluminum plate	8
Figure 5:	Results of pool fire simulation on uninsulated aluminum plate	9
Figure 6:	Results of pool fire simulation on uninsulated aluminum plate	9
Figure 7:	Results of pool fire simulation on uninsulated aluminum plate	9
Figure 8:	First torch fire simulation of aluminum plate insulated with glass fiber	10
Figure 9:	Results of the second torch fire test of aluminum plate insulated with glass fiber	10
Figure 10:	First pool fire simulation with the glass fiber insulation	10
Figure 11:	Second pool fire test of glass fiber insulation	10
Figure 12:	Final pool fire test with glass fiber insulation	11
Figure 13:	Torch fire simulation test on aluminum plate insulated with ceramic fiber	11
Figure 14:	Torch fire simulation test on aluminum plate insulated with ceramic fiber	11
Figure 15:	Results of the first pool fire simulation with the aluminum plate insulated with ceramic fiber	12
Figure 16:	Results of the second pool fire test with the aluminum insulated by ceramic fiber	12
Figure 17:	Results of the third pool fire test with the aluminum insulated by ceramic fiber	12
Figure 18:	First test of the aluminum plate insulated with mineral fiber	13
Figure 19:	Second test of the aluminum plate insulated with mineral fiber	13
Figure 20:	First pool fire simulation of the aluminum plate insulated with mineral fiber	13
Figure 21:	Second pool fire test of the aluminum insulated by mineral fiber	13
Figure 22:	Third pool fire test of the aluminum insulated with mineral fiber	13

## 1.0 Introduction

Due to a number of serious railroad accidents in the early 1970's that involved toxic compressed gases, flammable compressed gases and other hazardous materials, the U. S. Department of Transportation (DOT) initiated a review of specifications for steel tank cars. As a result of this review and under the direction of the Materials Transportation Bureau (MTB) and the Federal Railroad Administration (FRA), certain specification tank cars now are required to have, in part, increased thermal protection.

The requirements for this increased protection are set forth as final rules under 49 CFR Parts 173 and 179, Dockets HM-144, HM-174, and HM-175. All proposed tank car thermal insulation systems must undergo torch fire qualification testing, according to the procedures described in 49 CFR Part 179.105-4, "Thermal Protection," before the cars are used in revenue service.

A variety of studies have been conducted under contract to the FRA in which tank car thermal insulation systems were subjected to fire. Most of these studies applied the methods prescribed in 49 CFR Part 179.105-4, which involves the application of a torch flame to a 4 ft. square insulation specimen covering a steel "backplate," which represents a steel tank-car shell.

In a more elaborate test, two full-scale pressure tank cars loaded with propane, one insulated and the other not, were placed in a pit and subjected to a "pool fire" environment (Appendix C). The purpose of this test was to investigate and determine the failure

modes of a tank car in order to develop procedures and mechanisms for preventing or delaying the rupture of pressurized tank cars.

In all of these studies, the test data gathered were relative to steel tank cars.

In July, 1983, the National Transportation Safety Board held a public hearing on hazardous materials safety in rail yards. An aluminum tank car carrying nitric acid had been involved in an accident at Denver, Colorado, the previous April. As a result of the hearing, NTSB recommended that FRA initiate a project to examine the vulnerability of aluminum tank cars to both puncture and fire. Data gathered from this project would be used by the FRA to build the information base required for the examination of the vulnerability of aluminum tank cars to both mechanical and thermal accidents.

The data described in this report comprise the results of torch tests performed to determine the vulnerability of aluminum tank cars to fire. The tests were performed according to the methods and procedures described in 49 CFR Part 179.105-4, "Thermal Protection." They were conducted on tank car aluminum plate, uninsulated and insulated with three different blanket materials: glass fiber, ceramic fiber, and mineral fiber.

The tests were conducted by personnel of the Association of American Railroads at the torch fire test stand of the Transportation Test Center, which is near Pueblo, Colorado.

## 2.0 DOT Performance Standards

The series of tests covered by this report were conducted according to the methods and procedures prescribed in the Code of Federal Regulations, Title 49, Part 179.105-4, "Thermal Protection." A copy of this section of the regulations is contained in Appendix C of this report.

This regulation requires that two types of torch fire tests be conducted on each insulation system proposed for use on certain specification tank cars:

1. A pool fire simulation test series;
2. A torch fire simulation test series.

Each test series covers only one thickness and material configuration of an insulation system. Different insulation materials, thicknesses, and combinations thereof would require separate testing.

The following two sections focus on the key elements of each type of torch test.

### 2.1 Pool Fire Simulation Test Series

This test series requires a flame temperature of 1,600 deg. F plus or minus 100 deg. for the duration of each test. Three consecutive insulation specimen tests are required, following one flame temperature "calibration" test in which a 5/8 in. thick bare steel plate is used per the regulation.

In the pool fire calibration test, the steel plate is representative of that used in the construction of a steel tank car. In this case, the steel plate was 4 ft. square and instrumented on the back side (opposite the flame) with nine type "K" thermocouples evenly spaced in a grid pattern per the regulation.

The simulated pool fire totally engulfs the front surface of the bare plate. Temperature rise through the plate is recorded. The calibration thermal performance requirements are as follows:

"A minimum of two thermocouple devices shall indicate 800 deg. F after not less than 12 minutes nor more than 14 minutes of simulated pool fire exposure."

The flame temperature is adjusted by varying the torch nozzle-to-plate distance.

After a successful pool fire calibration test has been conducted, the three insulation specimens may then be tested using the "calibrated" nozzle-to-plate distance. The regulation requires that an instrumented steel plate, as used in the calibration test, is to be covered on one side—the flame side—with the insulation system to be tested.

The insulation system is then subjected to the simulated pool fire, with the temperature rise through the insulation system and the steel backplate again being recorded via the thermocouple sensors.

The thermal performance requirements for an insulation system are as follows:

"A pool fire simulation test shall run for a minimum of 100 minutes. The thermal insulation system shall

retard the heat flow to the steel plate so that none of the thermocouples on the uninsulated side of the steel plate indicates a plate temperature in excess of 800 deg. F."

As indicated, three consecutive pool fire tests of each insulation system are required. Each system must meet the performance requirements in all three tests.

### 2.2 Torch Fire Simulation Test Series

This test series requires a flame temperature of 2,200 deg. F plus or minus 100 deg. for the duration of each test. Two consecutive insulation specimen tests are required, following one flame temperature "calibration" test in which a 5/8 in. thick bare steel plate is used per the regulation.

The torch fire calibration test uses the same bare steel plate and thermocouple instrumentation used in the pool fire calibration test. In this case, the simulated torch fire virtually "impacts" the full front surface of the bare plate.

The CFR standard has the following requirements for a torch fire calibration test:

"Torch velocities shall be 40 miles per hour plus or minus 10 miles per hour throughout the duration of the test. . . . A minimum of two thermocouples shall indicate 800 deg. F in a time of 4.0 plus or minus 0.5 minutes of torch simulation exposure."

After a successful torch fire calibration test has been conducted, the two insulation specimens may then be tested using the "calibrated" nozzle-to-plate distance. The torch fire insulation test configures the insulation, back plate, and instrumentation in the same manner as in the pool fire insulation test.

The thermal performance requirements for an insulation system are as follows:

"A torch simulation test shall be run for a minimum of 30 minutes. The thermal insulation system shall retard the heat flow to the steel plate so that none of the thermocouples on the uninsulated side of the steel plate indicate a plate temperature in excess of 800 deg. F."

### 2.3 Modification of CFR Performance Standard

The CFR performance standard (49 CFR 179.105-4), which describes the methods and procedures to which this aluminum tank car fire test series conformed, stipulates the use of a 5/8 in. thick instrumented steel plate in both the bare plate calibration tests and the actual thermal insulation tests (where it serves as the backplate). The explanation for this is that the CFR performance standard was developed around specification 112T, 112J, 114T,



and 114J pressurized steel tank cars. The standard was designed to identify thermal protection systems that "prevent the release of any of the car's contents (except release through the safety relief valve) when subjected to: (1) a pool fire for 100 minutes; and (2) a torch fire for 30 minutes."

The aluminum tank car fire test series dealt

exclusively with low-pressure aluminum tank cars. Accordingly, the instrumented aluminum backplate was substituted for the steel backplate specified for use in the insulation tests.

All other variables remained as specified in the CFR performance standard, including the use of a 5/8 in. thick steel plate for the calibration tests.

### 3.0 The Torch Test Facility

The Torch Test Facility is located at the DOT's Transportation Test Center, Pueblo, Colorado. It was designed and constructed with funds provided by the DOT. This facility has played a major role in the development of DOT regulations requiring increased thermal protection of certain specification tank cars. Indeed, the test plan and performance standard for conducting a torch/pool fire simulation test (49 CFR 179.105-4, "Thermal Protection") is tailored around the operation of this facility.

The primary systems and components that constitute the Torch Test Facility are briefly described in the following sections, and are described in greater detail in the unpublished "Operating Instructions for the Torch Fire Test Facility" (Appendix D).

#### 3.1 Data Acquisition and Monitoring System

This system consists principally of equipment located in the instrumentation and control (IC) trailer. The data-acquisition portion of the system includes a Fluke Data Logger, a Kennedy magnetic tape recorder, a Hewlett-Packard 9845-series desktop computer with disk storage, and a General Electric 12-column printer.

The data logger receives input signals from 28 channels, which are listed and defined in Table 1. It converts these signals into units that are characteristic of the measurements being taken and then feeds the information every 30 sec. to the tape recorder, the printer, and the computer.

The Kennedy recorder permits the data from the 28 channels to be stored on magnetic tape during each test. This data record serves as a second storage source in the event that the computer should lose the test data.

The Hewlett-Packard computer, with monitor, is the primary storage device in this system. It contains programs to generate graphics and tabulate data and to write reports. Temperature-vs.-time bar graphs are generated and printed out on hard copy throughout each test. At the conclusion of each test, temperature curves and wind speed-direction plots are also produced; these plots are the two graphic figures incorporated in this report. The data from each test are stored on flexible disks.

The General Electric printer produced another record of the test data. The 12-column printer provides tabulations of all 28 channels at 30-sec. intervals on hard copy.

The monitoring portion of this system is composed of console-mounted digital meters, video cameras, and a video recorder. The test is observed through the IC trailer window. The digital meters monitor channels 21 thru 28, which are defined in Table 1. These eight channels convey to the test operators information important to the proper conduct of the test.

Two video cameras are used during each test, one behind the torch, facing the test cart, and one to the side of the torch and test cart. The use of these cameras with a television monitor allow the operators to monitor the character and direction of the torch flame, and to compensate for wind effects and other disturbances by adjusting the position of the torch

**Table 1: Fluke Data Logger Channel Assignments**

Channel	Parameter and Location
1	Thermocouple, back of backplate, top left
2	Thermocouple, back of backplate, top center
3	Thermocouple, back of backplate, top right
4	Thermocouple, back of backplate, center left
5	Thermocouple, back of backplate, center center
6	Thermocouple, back of backplate, center right
7	Thermocouple, back of backplate, bottom left
8	Thermocouple, back of backplate, bottom center
9	Thermocouple, back of backplate, bottom bottom
10	Thermocouple, back of inside of rear enclosure
11	Thermocouple, inside of thermocouple junction box
12	Not used
13	Not used
14	Thermocouple, left side of holder, facing rear of holder
15	Thermocouple, left door of holder, center
16	Thermocouple, right door of holder, center
17	Thermocouple, right side of holder
18	Thermocouple, back of jacket, center left
19	Thermocouple, back of jacket, top center
20	Thermocouple, back of jacket, center right
21	Thermocouple, bath temperature
22	Thermocouple, orifice temperature
23	Wind speed (mph)
24	Wind direction (deg)
25	Supply tank pressure (psi)
26	Vapor valve (percentage open)
27	Orifice pressure (psi)
28	Liquid valve (percentage open)

Thermocouple locations are as viewed from behind the test plate

nozzle (see Section 3.3). A videocassette recorder provides a visual record of each test performed.

### 3.2 Propane Transfer and Pressurization Systems

The propane fuel used in each torch test is stored in an 18,000-gal. tank. Prior to and during a test, propane is pumped to a 500-gal. pressurizing tank located below grade.

The pressurizing tank is submerged in a hot water bath, the heat for which is provided by an external steam generator. Four electric immersion heaters are located inside the tank and heat the liquid propane directly. The pressurizing tank relies on the heat from the bath and the immersion heaters to elevate the propane to a nominal 220 PSIG operating pressure throughout each test and to maintain it at that pressure. Operation of the propane transfer pumps and the immersion heaters is automatic during a test.

### 3.3 Torch and Torch Nozzle Positioning Systems

The torch consists of two pipes of 4 in. diameter that emerge directly from the top of the propane pressurization tank and converge into one 2 in. dia. nozzle. One of the 4-in. pipes takes propane from the vapor

portion of the pressurization tank; the other takes liquid.

For normal test work, only the vapor supplied by the vapor line is required. The liquid line is shut off. The flow rate is controlled from the IC trailer with a pneumatic valve.

The torch nozzle position is adjusted remotely from the IC trailer with an operator-controlled "joy stick." The joy stick controls two linear electro-mechanical actuators connected to the torch nozzle. The nozzle tube incorporates two ball joints, which permit it to move in all directions. Proper position of the flame on the target is determined by temperature uniformity of the bare plate or front jacket thermocouples, and also visually with the video system.

### 3.4 Wind Shield

The torch flame can be upset easily by the effects of wind, especially during a pool fire simulation test where the torch nozzle-to-specimen distance is relatively long. Aggravating this problem, the torch fire test facility is located on an open, flat prairie where no natural wind barriers exist. The prevailing winds at TTC are from the north.

The torch test area is protected on the north and west sides by a 16 ft. high wind fence and on the east by a 20 ft. high building. The south side of the test area is normally open. During pool fire simulation tests and when wind velocities require it otherwise, a temporary wind fence is moved into place on the south side.

### 3.5 Test Cart and Specimen Holder

The test cart is a tracked vehicle used to carry the insulation system and its holder to the desired distance from the torch nozzle (Figure 1). By moving the test cart to within a nominal 12 ft. of the torch nozzle, the stage is set for a torch-fire simulation test. Likewise, by moving the cart to approximately 21 ft. from the torch nozzle, the arrangement is in position for a simulated pool fire test.

The test specimen holder is mounted vertically on top of the test cart, as shown in Figure 1. The holder is designed to accept a 4 ft. square bare plate or a

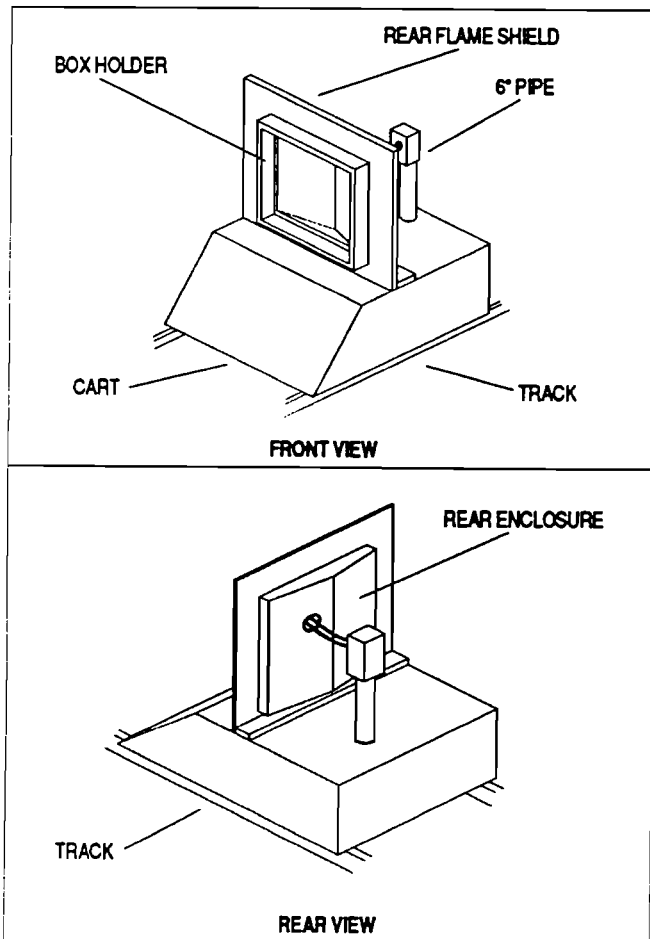

Fig. 1: Front and rear views of the test cart and specimen holder as used in the torch tests.

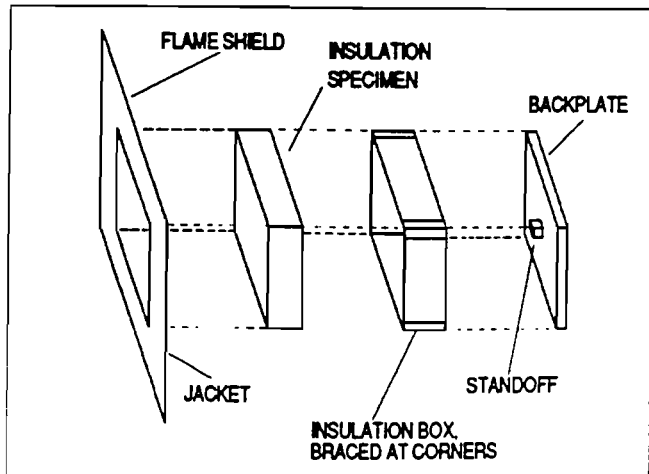

Fig. 2: Exploded view of the specimen holder, showing the backplate, standoff, insulation box and insulation sample, jacket, and flame shield.

multiple-component insulation system (Figure 2). The holder consists of a holder box or spacer, a rear flame shield, and a rear enclosure with double access doors.

The bare test plate or insulated backplate is mounted to the front side of the holder box. The rear flame shield prevents the flames from wrapping around to the rear enclosure, contributing unwanted heat to the thermocouples. The rear enclosure provides access to the thermocouples on the rear of the backplate.

The interior of the rear enclosure is lined with a thermal insulation blanket. The exterior is covered with a thermal textile "shroud" to protect the system further from heat gain to and heat loss from the enclosure.

Eighteen channels of thermocouple extension wire

extend from the IC trailer to the rear of the test cart. They enter the test cart through the vertical 6 in. dia. pipe and run to the junction box on the rear of the test cart (Figure 1).

In addition to the nine thermocouples attached to the backplate, nine supplementary thermocouples are available to monitor the temperatures of the exterior surfaces of the specimen holder, the air inside the rear enclosure and the thermocouple junction box, and the rear of the front steel jacket, as used in the insulation system shown in Figure 2. The three jacket thermocouples are used solely to monitor the position of the flame on the insulation system. The other six supplemental thermocouples are used to verify that no heat is being lost or gained from beneath the rear textile shroud. Refer to Table 1 for thermocouple channel assignments.

## 4.0 Test Specimens

One series of simulated torch fire and pool fire tests, per 49 CFR 179.105-4, "Thermal Protection," was conducted on each of the following test specimens:

- Uninsulated aluminum plate;
- Aluminum plate insulated with 4 in. thick glass fiber blanket;
- Aluminum plate insulated with 1/2 in. thick ceramic fiber blanket;
- Aluminum plate insulated with 1 in. thick mineral fiber blanket.

Each specimen tested utilized a 1/2 in. thick, 4 ft. square aluminum plate mounted on the specimen holder box.

A detailed description of each test specimen and set-up follows in the next four sections.

### 4.1 Uninsulated Aluminum Plate

This test specimen configuration consisted of a bare, uninsulated aluminum plate (backplate) subjected to the direct application of simulated torch fire and pool-fire flames. The aluminum plate specimen was 5454 H112 aluminum alloy, 1/2 in. thick. This material was selected for the test series because of its frequent use in aluminum tank cars.

The melting range and thermal conductivity of this particular alloy, as published by the Aluminum Association, Inc., is approximately 1,115 to 1,195 deg. F and 930 b.t.u./in./s.f./deg. F/hr., respectively. By comparison, carbon steel melts at approximately 2,500 deg. F and has a thermal conductivity of approximately 314 b.t.u./in./s.f./deg. F/hr.

The aluminum plate specimen in each test was instrumented on its back surface (away from the flame) with nine thermocouple temperature sensors to record the thermal response of the plate during each test.

### 4.2 Glass Fiber-Insulated Aluminum Plate

The second series of tests was conducted on a three component insulation "system," a "sandwich" that duplicated the construction of a typical insulated aluminum tank car (Figure 2).

A piece of aluminum plate, as described in Section 4.1, represented the tank car shell (referred to in this report as the backplate). A 4 in. thick piece of glass fiber thermal insulation 4 ft. square represented the insulation layer and was installed against the aluminum. A piece of 11 ga. carbon steel sheet 6 ft. square was then installed, representing a typical outer protective jacket.

One other component, exclusive to this insulation

**Table 2: Test Specimens**

Test Identification	Specimen	Weight (lbs)
4" glass fiber, Owens-Corning "AT-420"		
TF-28-01-86-OC1-A	OC1	5.38
TF-29-01-86-OC2-A	OC2	5.41
TF-26-03-86-OC4-A	OC4	5.30
TF-27-03-86-OC6-A	OC6	5.28
TF-28-03-86-OC7-A	OC7	5.29
1/2" ceramic fiber, Carborundum "Fiberfrax"		
TF-16-05-86-CF1-A	CF1	3.92
TF-19-05-86-CF2-A	CF2	4.09
TF-21-05-86-CF3-A	CF3	4.60
TF-22-05-86-CF4-A	CF4	4.28
TF-23-05-86-CF5-A	CF5	4.18
1" mineral fiber, USG "Thermafiber"		
TF-03-09-86-MF1-A	MF1	9.17
TF-04-09-86-MF2-A	MF2	9.58
TF-08-09-86-MF3-A	MF3	9.95
TF-09-09-86-MF4-A	MF4	8.30
TF-11-09-86-MF5-A	MF5	10.09
1/2" bare aluminum plate, 5454 H112		
TF-21-01-86-ALU-A	N/A	N/A
TF-23-01-86-ALU-A	N/A	N/A
TF-01-02-86-ALU-A	N/A	N/A
TF-03-02-86-ALU-A	N/A	N/A
TF-03-02-86-ALU-B	N/A	N/A

system, was also installed: a 4 in. oak cube over a dowel welded to the center of the aluminum backplate. This oak "standoff bracket" projected through the insulation material to the steel jacket surface. This component is typical of the method used on aluminum tank cars to support the jacket away from the tank and to provide a space for the insulation material.

The insulation material used was manufactured by the Owens Corning Corporation. It is a 4 in. thick, 1 lb. density glass fiber blanket identified as Type AT-420, "Tank Car Insulation Blanket."

The thermal insulation system as described in this section is not listed in the "List of Excepted Thermal Protection Systems for Tank Cars," Federal Register, Volume 49, No. 165.

An insulation specimen inventory list, indicating the test identification number, the specimen identification number, and the individual specimen weights, is given in Table 2.

#### **4.3 Ceramic-Fiber-Insulated Aluminum Plate**

The third series of tests was also conducted on a three component insulation system that resembled the assembly shown in Figure 2, and is discussed in Section 4.2. In this test series, a 1/2 in. thick piece of ceramic fiber thermal insulation represented the insulation layer that was installed against the aluminum plate. (See Section 4.1 for a description of the aluminum plate.) An 11 ga. carbon steel sheet, representing the outer protective jacket, was then installed. No standoff bracket was used in this test series.

The insulation material used was manufactured by

the Carborundum Company. It is a 1/2 in. thick, 4.5 lb. density high-temperature ceramic fiber blanket identified as "Fiberfrax Tank Car Insulation-S."

This ceramic fiber thermal insulation system, as described in this section and when provided in a minimum thickness of 65/100 in. is listed as an excepted thermal protection system for tank cars in the Federal Register, Volume 49, No. 165.

The individual specimen weights, including the test identification number and the specimen identification number, are given in Table 2.

#### **4.4 Mineral-Fiber-Insulated Aluminum Plate**

The fourth and last series of specimen tests conducted in the series was another three component insulation system resembling Figure 2. This test series utilized a 1 in. thick piece of mineral fiber thermal insulation installed against the aluminum plate. (See Section 4.1 for a description of the aluminum plate.) An 11 ga. carbon steel sheet, representing the outer protective jacket, was installed against the insulation assembly. No standoff bracket was used in this test series.

USG Corporation manufactured this insulation material, which is a 1 in. thick, 8 lb. density, semirigid mineral fiber blanket identified as "Thermafiber Tank Car Fireproofing." This blanket incorporates a foil scrim polyethylene facing on one side, which was installed against the 11 ga. jacket.

The Federal Register, Volume 49, No. 165, lists this insulation system, as described in this section, as an excepted thermal protection system for tank cars.

The individual specimen weights, including test identification number and specimen identification number, are given in Table 2.

## 5.0 Tests Performed

A list of each test performed within this aluminum tank car fire test series, including calibration tests, is presented in Table 3. The tests are grouped according to the type of specimen tested.

The test identification (ID) number is explained as follows:

- The first pair of letters, TF-, indicates that the test was performed at the torch facility.

- The next three pairs of numbers indicate the date in which the test was performed, with the first pair indicating the day, the second pair the month, and the third the year.

- The next three characters indicate the specimen ID number as shown in Table 2; or, if it was a calibration test, the reference is shown as "CAL."

- The last alphabetic or numeric character indicates the run of the day. For example, "A" or "1" would indicate the first test of the day; "B" or "2" would indicate the second.

Table 3: Tests Performed		
Test Number	Test Identification	Test Type
<b>Uninsulated aluminum plate</b>		
1	TF-21-01-86-CAL-1	Torch calibration
2	TF-21-01-86-ALU-A	Torch
3	TF-23-01-86-ALU-A	Torch
4	TF-31-01-86-CAL-5	Pool calibration
5	TF-01-02-86-ALU-A	Pool
6	TF-03-02-86-ALU-A	Pool
7	TF-03-02-86-ALU-B	Pool
<b>Fiber glass insulated aluminum plate</b>		
8	TF-27-01-86-CAL-1	Torch calibration
9	TF-28-01-86-OC1-A	Torch
10	TF-29-01-86-OC2-A	Torch
11	TF-26-03-86-CAL-4	Pool calibration
12	TF-26-03-86-OC4-A	Pool
13	TF-27-03-86-OC6-A	Pool
14	TF-28-03-86-OC7-A	Pool
<b>Ceramic fiber insulated aluminum plate</b>		
15	TF-12-05-86-CAL-1	Torch calibration
16	TF-16-05-86-CF1-1	Torch
17	TF-19-05-86-CF2-A	Torch
18	TF-20-05-86-CAL-1	Pool calibration
19	TF-21-05-86-CF3-A	Pool
20	TF-22-05-86-CF4-A	Pool
21	TF-23-05-86-CF5-A	Pool
<b>Mineral fiber insulated aluminum plate</b>		
22	TF-02-09-86-CAL-1	Torch calibration
23	TF-03-09-86-MF1-A	Torch
24	TF-04-09-86-MF2-A	Torch
25	TF-05-09-86-CAL-3	Pool calibration
26	TF-08-09-86-MF3-A	Pool
27	TF-09-09-86-MF4-A	Pool
28	TF-11-09-86-MF5-A	Pool

## 6.0 Test Results

The results of the aluminum tank car fire test series are presented and discussed in the following sections of this report.

The graphic presentations of the pertinent data from each test are exhibited in Figures 3 through 23. These graphs show the nine required aluminum backplate temperature curves, which were generated from thermocouple signals recorded every 30 sec.

Channel 10 was also recorded and indicates the temperature rise of the air behind the backplate, inside the rear enclosure. This measurement assures that no heat is being lost from the insulated rear enclosure, but it is not required by the CFR regulation.

An additional graph generated from each test, showing the three jacket temperature curves, the wind speed curve and wind direction symbols, is contained in Appendix A. The channels providing this information were Nos. 18, 19, 20, 23 and 24, respectively.

Graphs showing the results of the required temperature calibration tests for each series of torch and pool fire tests are contained in Appendix B.

### 6.1 First Test Series: Uninsulated Aluminum Plate

In this series of fire tests, the tank car aluminum plate was subjected to the direct contact of the flame without the benefit of protective insulation material or front jacket, simulating the effects of fire on the exposed, uninsulated shell of an aluminum tank car. The aluminum plate was expected to fail the requirements of 49 CFR Part 179.105-4. The question was how far into a simulated torch and pool fire test would failure occur, and how extensive would the physical damage be.

Figures 3 through 7 illustrate the rapid temperature rise and resultant failure of the bare aluminum plate in each test. A new aluminum plate specimen was installed for each of the five tests.

Results of the torch fire simulation tests are presented in Figures 3 and 4. The nozzle-to-specimen distance was 11 ft. 3 in. The high-temperature flame caused the plates to exceed the 800 deg. F limit within 3 min. of the start of the tests, 27 min. short of the CFR requirement.

The first test (Figure 3) shows the temperatures at the nine backplate thermocouples climbing uniformly to a peak of 1,103.8 deg. F (at thermocouple 5). Thermocouple 10 shows a substantial lag in the temperature of the air behind the plate, emphasizing the short time allowed to heat that air.

The torch was shut off just before reaching the minimum melting temperature of the aluminum, so that the plate's physical condition could be checked. The post test examination revealed that the center area of the plate was slightly pushed in or concave, by

about 1/8 in. to 1/4 in. No actual melting was visible, however.

The second torch fire test (Figure 4) was similar to the first except at the end. Temperatures at thermocouples 6 through 9 fell off steeply, indicating that the aluminum plate had melted. Melting occurred at 5 min. into the test, instantly "blowing out" the center portion of the plate. Thermocouple 7 reached 1,145.7 deg. F just before the plate melted. Relatively small remnants of the plate remained.

Results from the pool fire simulation tests are presented in Figures 5, 6, and 7. The nozzle-to-specimen distance was 20 ft. 9 in. The lower temperature "pool" flame allowed the aluminum plates to survive through two of the three 100-min. pool fire tests.

In the first pool fire test (Figure 5), the plate exceeded the 800 deg. F limit 24-1/2 min. into the test.

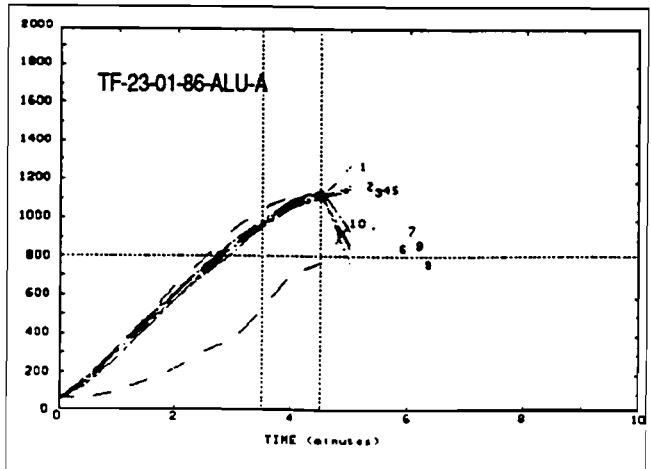
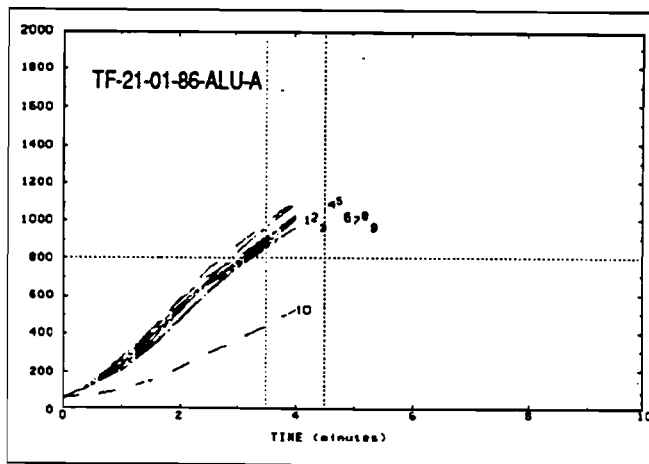

Figs. 3 (top) and 4: Results of the torch fire simulations on uninsulated aluminum plate. Vertical axes in these and all similar plots is deg. F.

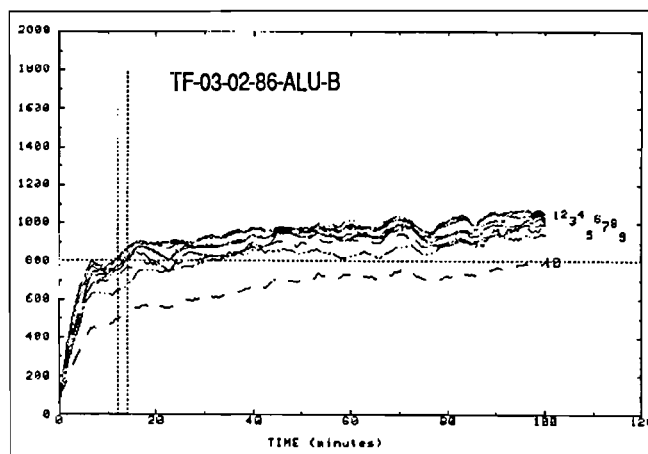
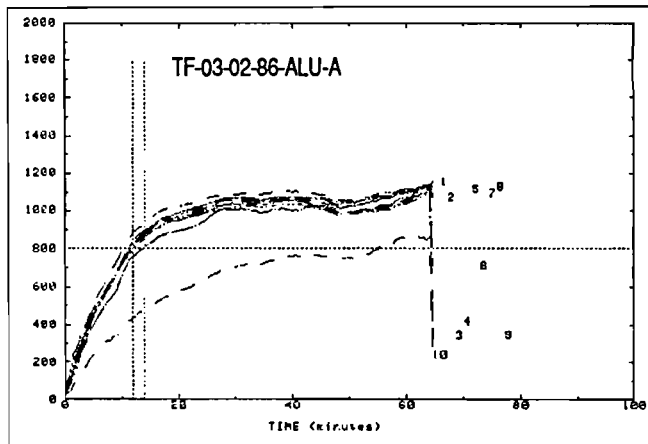
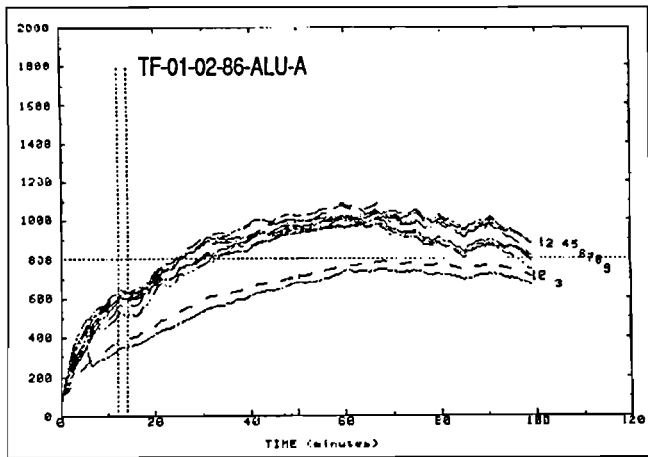

Figs. 5, 6 and 7: Results of the pool fire simulations on uninsulated aluminum plate. See text for description of the data.

All backplate thermocouples rose uniformly in temperature except one. The lag in temperature rise of thermocouple No. 3 throughout the test indicates that it was not functioning properly.

Wind velocity fluctuated between 2 and 10 m.p.h. throughout the test and caused some problems in maintaining constant flame contact with the plate. The wind influence is displayed in thermocouple No. 5 (center of plate), which reached a high of 1,075 deg. F about one hour into the test, but then cooled off to 870 deg. F by the end of the test. Based on the results of the next test (Figure 6), constant flame contact would have melted this plate.

At post test inspection, it was noted that the

aluminum plate specimen exhibited only slight warpage, with no other damage being visible.

The second pool fire test (Figure 6), was run during ideal wind conditions. Near constant flame contact with the aluminum plate was possible. The temperature at thermocouple No. 5 exceeded the 800 deg. F limit 10 min. into the test. At 63 min. into the test, when the temperature at thermocouple No. 5 reached 1,134 deg. F, a visible "bow" formed at the bottom of the plate. Finally, at 64 min. into the test, thermocouple No. 5 reached its highest recorded temperature of 1,137.5 deg. F and, except for some small pieces, the aluminum plate literally fell off the mounting frame.

The third and final pool fire test (Figure 7), was much the same as the first in that wind tended to steer the flame away from the aluminum plate surface. Although the 0-to-7-m.p.h. wind velocities were not excessive, the direction of the wind (into the torch) had a marked negative effect on the flame. As a result, the backplate temperatures never exceeded 1,080 deg. F at any point in the test. The backplate temperature (thermocouple No. 2) exceeded the 800 deg. F limit 11-1/2 min. into the test.

The post test visual inspection of the aluminum plate revealed little visible warpage.

To sum up:

A bare aluminum plate will fail (melt) in a simulated pool fire test when wind conditions permit proper contact of the flame on the specimen's surface.

## 6.2 Second Test Series: Glass Fiber-Insulated Aluminum Plate

In this series of fire tests, the aluminum plate was protected by a 4 in. thick piece of glass fiber insulation and an 11 ga. carbon steel jacket, an insulation system similar to that illustrated in Figure 2.

Past tests in which steel plate insulated with 4 in. of glass fiber was subjected to a simulated torch fire test showed that glass fiber alone will not pass the requirements of 49 CFR Part 179.105-4. Therefore, the aluminum-plate tests were also expected to fail. However, it was not known whether this insulation system would survive the cooler simulated pool fire.

Figures 8 through 12 present the results of the series of tests with glass fiber insulation. Three new aluminum plate specimens and five glass fiber specimens were used in the five tests. No melting of the aluminum plates occurred, although some warpage was noted.

The results of the torch fire simulation tests are presented in Figures 8 and 9. The nozzle-to-specimen surface distance was 11 ft 3 in.

The high-temperature flame caused the backplates to exceed the 800 deg. F limit before the required 30-min. duration; one test (Figure 8) exceeded the limit at 23 min., the other at 19 min.

The highest backplate temperature recorded at the end of the first test was 1,058.9 deg. F (at thermocouple No. 2). The highest recorded in the second test was 1,120.6 deg. F (thermocouple No. 2), very close to the melting point of the aluminum.

Wind velocities in the first test were a moderate 3 to 9 m.p.h.; winds during the second test reached a rather high 17 m.p.h. However, even these somewhat high winds did not disturb the high-velocity, short distance simulated torch flame.

In the first test (Figure 8), the temperature at eight

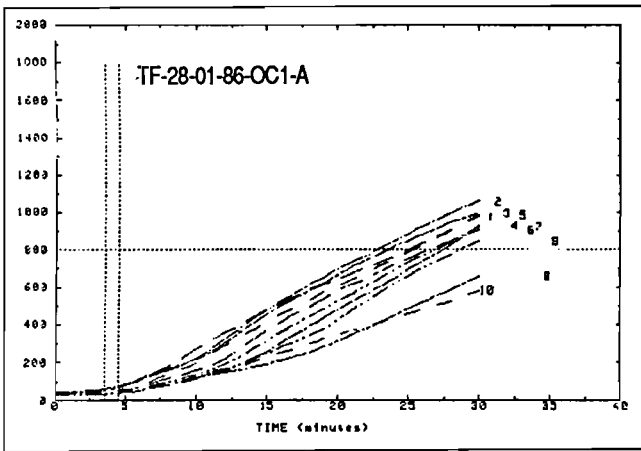

Fig. 8: First torch fire simulation of aluminum plate insulated with glass fiber.

of the nine backplate thermocouples rose fairly uniformly. The temperature at thermocouple No. 8 began to rise much more slowly from 12 min. into the test until the end, however.

The post test examination revealed that the glass fiber blanket had fallen down and around the aluminum dowel that supported the oak standoff cube at the center of the backplate. The remains of the insulation blanket were found mostly at the center bottom of the holder frame, protecting the area instrumented by thermocouple No. 8. The oak cube was burned and charred, with its remains having fallen to the bottom of the insulation box. The appearance of the aluminum plate was quite good, with no warpage noted.

The second test, Figure 9, produced much the same result as did the first, although thermocouple No. 8 did not lag behind the others. The post test examination again revealed that the insulation blanket had slumped down and that the oak standoff cube had burned and fallen to the bottom. Appearance of the aluminum plate was good, but slight warpage was visible.

Results from the pool fire simulation tests are presented in Figures 10, 11, and 12. The nozzle-to-specimen distance was 20 ft. The glass fiber insulation was capable of surviving the lower temperature "pool" flame and performed very well, easily passing the CFR requirements in all three tests.

In the first pool fire test (Figure 10), the temperature at the backplate reached a high of only 262.5 deg. F (at thermocouple No. 2) at the end of the test. Wind conditions were somewhat disruptive throughout the test, changing from 1 m.p.h. to higher than 10 m.p.h. Problems with the wind were also evidenced by the somewhat cool front jacket temperatures, which reached no higher than 1,000 deg. F during the test (Appendix A).

Post test examination of the glass fiber revealed that it was fully in place over the plate and in good physical condition. Only the surface against the hot jacket had discolored to a white appearance. The oak standoff cube was also in relatively good condition, with one darkened surface. The aluminum backplate never reached 300 deg. F and was in like-new condition.

The second pool fire test (Figure 11) was a more severe test of the aluminum specimens insulated with glass fiber than was the first. Wind conditions were perfect due to a prevailing north wind that averaged only 4 mph. The backplate temperature graph

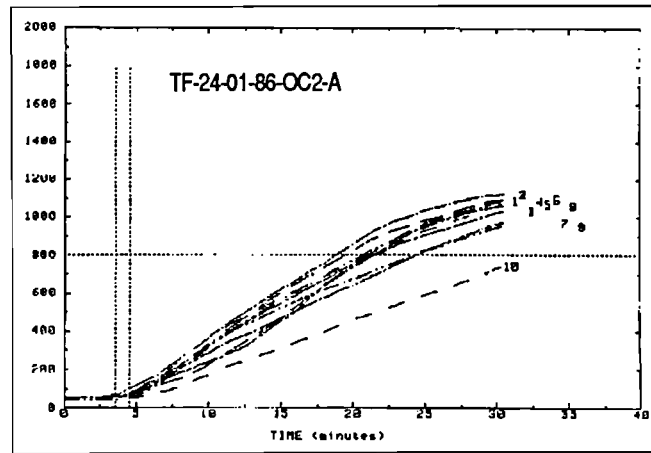

Fig. 9: Second torch fire test of aluminum plate insulated with glass fiber.

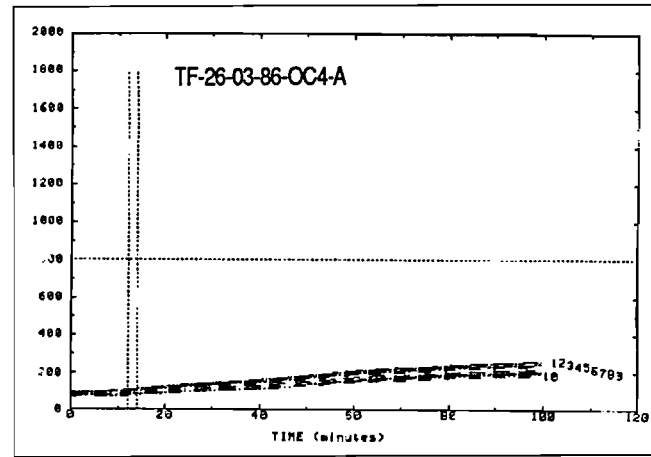

Fig. 10: First pool fire simulation with the glass fiber insulation. Wind conditions kept temperatures low.

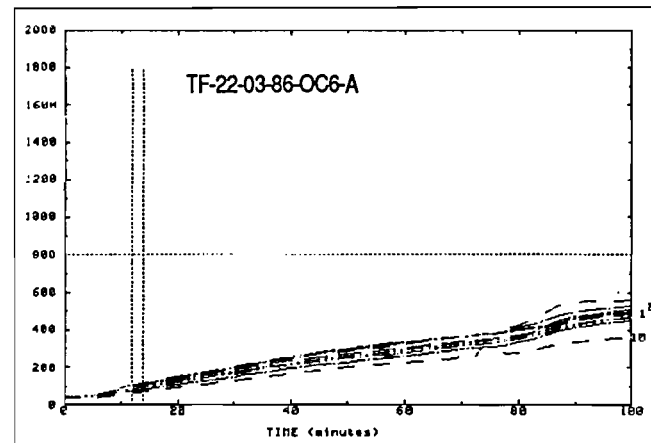

Fig. 11: Second pool fire test of glass fiber insulation, conducted in near-perfect wind conditions.

indicates that the temperatures at all thermocouples rose uniformly, with the center thermocouple (No. 5) being the hottest, reaching a maximum of 559.6 deg. F. This temperature was still well below the 800 deg. limit of the CFR standard. Jacket temperatures (Appendix A) reached a high of 1,331 deg. F, well above those in the previous test.

Post test inspection revealed that the glass fiber



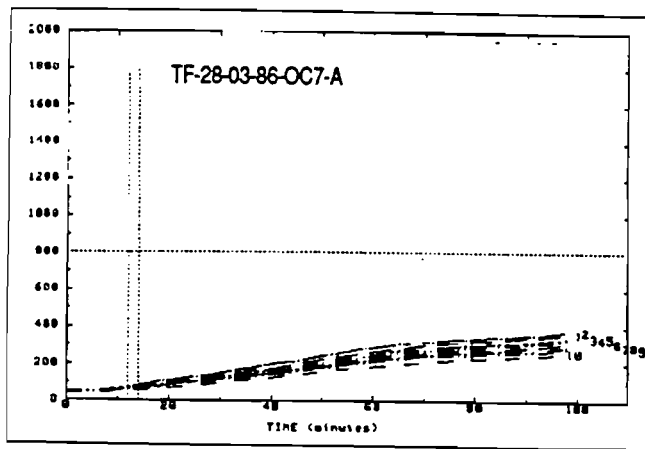

Fig. 12: Final pool fire test with glass fiber insulation, which was conducted in adverse wind conditions.

was fully in place over the aluminum plate and, aside from discoloration on the jacket side, was in good physical condition. The oak cube was darkened on one surface. The aluminum plate appeared to be in like-new condition.

The third and final pool fire simulation test (Figure 12) was conducted in less-than-perfect wind conditions. Wind speeds changed constantly and abruptly between 4 and 8 m.p.h., interfering with constant flame contact on the jacket. However, the backplate temperatures rose to a higher final value than they did in the first test, with 376.9 deg. F being recorded by thermocouple No. 2. Jacket temperatures (Appendix A) reached a high of 1,137 deg. F, about 200 deg. below the second test and 200 deg. above the first.

Post test inspection of the insulation system revealed that the glass fiber was fully in place over the plate and in good condition. The aluminum backplate never reached 400 deg. F and was in like-new condition.

### 6.3 Third Test Series: Ceramic Fiber-Insulated Aluminum Plate

The aluminum backplate in this series of tests was protected by a 1/2 in. thick blanket of ceramic fiber and an 11 ga. carbon steel jacket, which resembles the Figure 2 assembly. However, no standoff was installed at the center of the backplate.

The Federal Register lists a ceramic fiber blanket material of the same thickness and density as that tested here as an excepted thermal protection system for tank cars. It was therefore expected, but not certain, that the aluminum plates protected by this material would pass both the torch and pool fire test series.

Figures 13 through 17 present the results of the series of ceramic fiber tests. Two new aluminum plate specimens and five ceramic fiber specimens were used in the five tests. No melting or warpage of the aluminum plates occurred in this series of tests.

The results of the torch fire simulation tests are presented in Figures 13 and 14. The nozzle-to-specimen surface distance was calibrated at 11 ft. 3 in. The ceramic fiber insulation performed very well in a torch fire environment, protecting the aluminum plate and surpassing the CFR standard in both tests.

The highest backplate temperature recorded at the

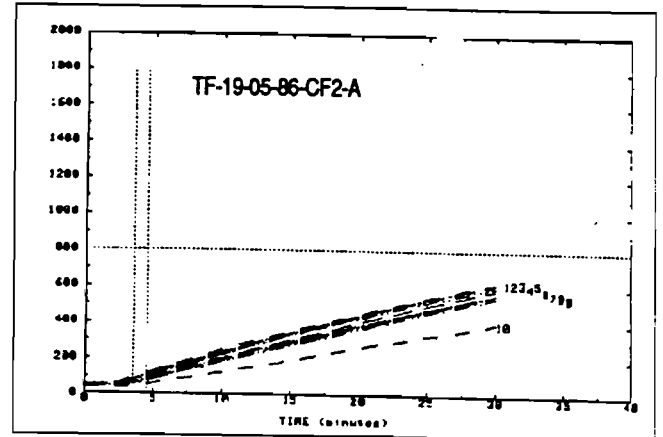
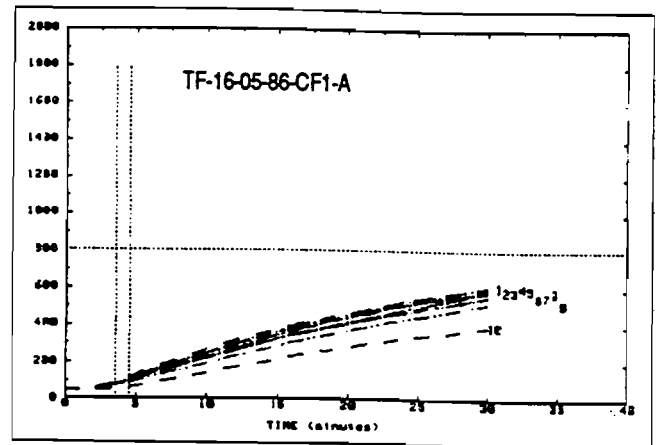

Figs. 13 and 14: Torch fire simulation tests on aluminum plate insulated with ceramic fiber.

end of the first test was 612.5 deg. F (at thermocouple No. 1). The highest recorded in the second test was 624.1 deg. F (thermocouple No. 3), well below the 800 deg. F limit and very good for such thin material.

Wind velocities outside the protection of the wind fence sometimes exceeded 20 m.p.h. during the first test. Winds during the second test averaged between 8 and 12 m.p.h. Although these are high velocities, they were recorded outside the protected envelope of the torch area. Also, extreme wind velocities are required before they are of any consequence in a high-velocity, short-distance torch simulation test.

The first test (Figure 13) shows the temperatures at all nine backplate thermocouples rising uniformly from the beginning of the test to the end. Jacket temperatures (Appendix A) were relatively constant throughout the test and reached a high of 1,721 deg. F. The high temperature indicates good flame contact with the jacket.

The post test examination revealed that the blanket was fully in place over the aluminum plate and in like-new condition. The aluminum plate was also undamaged.

The second test (Figure 14) again shows the temperatures at all nine backplate thermocouples rising uniformly and in a virtually straight line on the chart. Jacket temperatures were also very uniform and reached a high of 1,726 deg. F near the end of the test. The result was a good, representative torch fire test.

The post test examination again found the blanket fully in place and that the aluminum backplate had

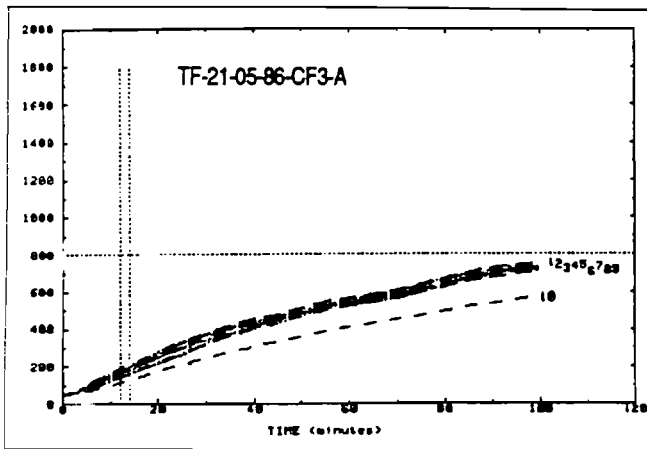

Fig. 15: Results of the first pool fire simulation with the aluminum plate insulated with ceramic fiber.

been well protected and was in like-new condition.

Results from the pool-fire simulation tests are presented in Figures 15, 16, and 17. The nozzle-to-specimen surface distance was 20 ft. 6 in. The ceramic fiber blanket survived and surpassed the CFR standard for a pool fire in all three tests. However, the final backplate temperatures in all three tests were higher than they were in the torch-fire simulations.

In the first pool fire test (Figure 15) the temperature at the backplate reached a high of 755.8 deg. F (thermocouple No. 1) at the end of the test, very close to the 800 deg. limit of the CFR standard. Wind velocities fluctuated between 3 and 8 m.p.h. and were considered mildly disruptive. Jacket temperatures fluctuated between 1,000 and 1,400 deg. F, indicating some problems in maintaining flame contact.

Post test inspection of the ceramic fiber revealed that the blanket was in place over the aluminum plate. The appearance of the insulation and the backplate was as-new.

The second and third pool fire tests (Figures 16 and 17) were almost copies of each other except for the wind, and were little changed from the first test. Wind speeds fluctuated between 0 and 14 m.p.h. during the second test, and between 3-1/2 and 8-1/2 m.p.h. during the third test.

The backplate graphs show a tightly grouped, gradual rise of temperatures at all nine thermocouples in each test. The highest recorded backplate temperatures were 675.7 deg. F (thermocouple No. 7) in the second test and 697.6 deg. F (thermocouple No. 5) in the third test. Jacket temperatures fluctuated between 1,000 and 1,300 deg. F during both tests (Appendix A).

Post test examinations of the specimens in both tests indicated that all components were in like-new condition.

#### 6.4 Fourth Test Series: Mineral Fiber-Insulated Aluminum Plate

A semirigid 1 in. thick mineral fiber blanket with one foil scrim side was tested against the aluminum backplate. An 11 ga. carbon steel jacket was also installed, the assembly resembling Figure 2 but without a standoff block. The Federal Register lists this particular insulation with an 11 ga. jacket as an accepted thermal protection system for tank cars. It

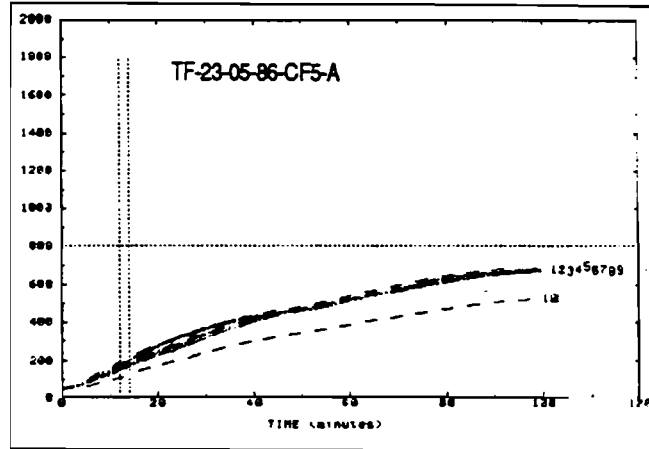
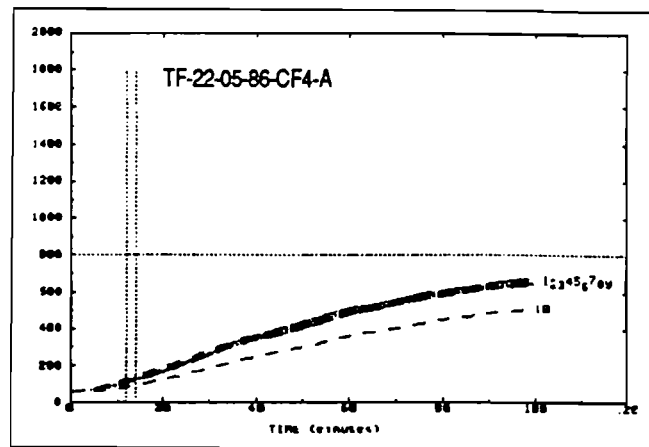

Fig. 16 and 17: Results of the second and third pool fire tests with the aluminum plate insulated by ceramic fiber.

was therefore expected that the aluminum plates protected by this material would pass both the torch- and pool-fire tests.

Figures 18 through 22 present the results of the mineral fiber series of tests. Two new aluminum plate specimens and five mineral fiber specimens were used in the five tests. No detectable damage occurred to the aluminum plates in this series of tests.

The results of the torch fire simulation tests are presented in Figures 18 and 19. The nozzle-to-specimen-surface distance was 11 ft. 6 in. The mineral fiber insulation did very well in the torch fire environment, outperforming the two previous insulation materials and easily surpassing the CFR standard in both tests.

The highest backplate temperature recorded at the end of the first test was 519.1 deg. F (thermocouple No. 3). The highest recorded in the second test was 528.2 deg. F (thermocouple No. 3).

Wind velocities were nearly ideal, moderate and steady for both tests. Winds during the first test averaged 6-1/2 m.p.h. and during the second test averaged less than 3 m.p.h. (Appendix A).

The first test (Figure 18) shows the temperatures at all nine backplate thermocouples rising together in nearly straight lines on the graph. Jacket temperatures were high and steady, averaging 1,625 deg. F throughout the test. Good flame contact was made throughout the test.

Post test examination revealed that the insulation

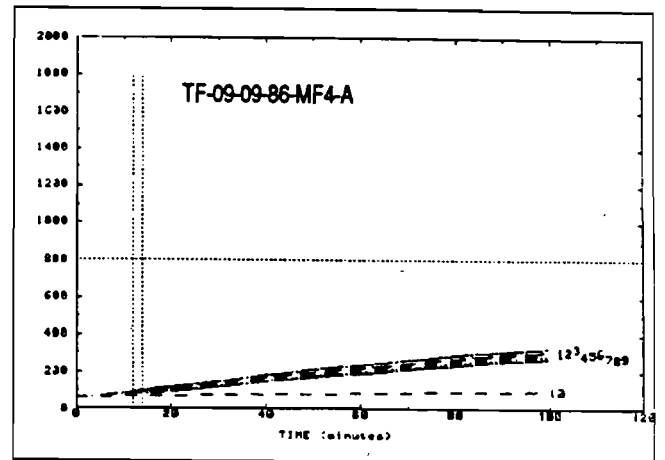
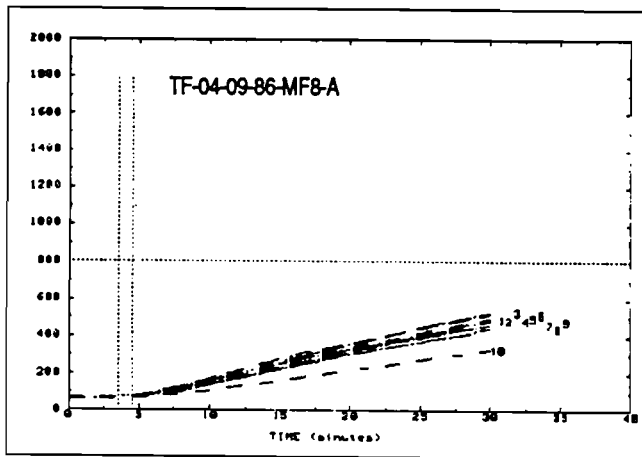
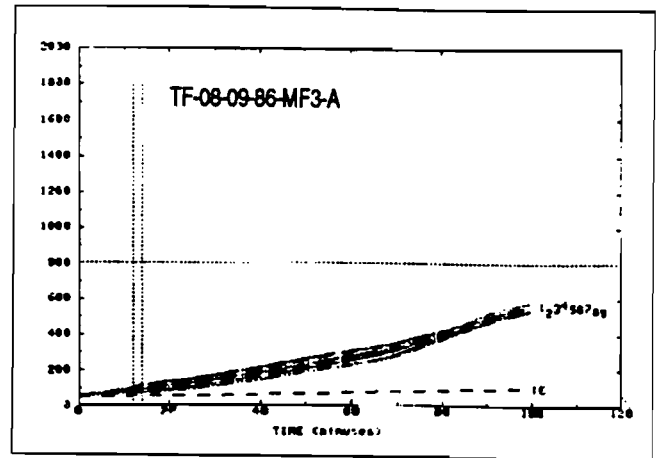
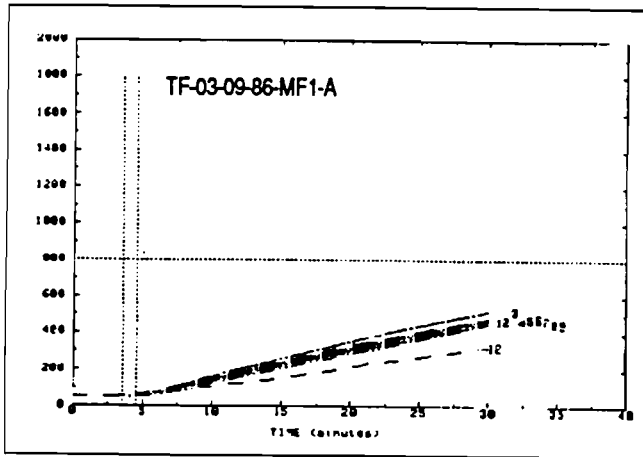

Figs. 18 and 19: First and second torch fire simulations of the aluminum plate insulated with mineral fiber.

had deteriorated to a certain degree. The foil scrim facing against the jacket had melted into pieces and the mineral fiber material was blackened through about half of its depth. The blanket did remain fully in place throughout the test. However, the blanket tended to break apart into pieces when it was removed from the backplate. This would indicate that a binding agent may have burned away within the blanket material. The aluminum plate was well protected during the test and no visible damage or warping was apparent.

The second test (Figure 19) was a virtual copy of the first. Jacket temperatures were high and fairly steady, averaging about 1,600 deg. F. Good flame contact was made throughout the test.

The post test examination again revealed that the blanket was fully in place throughout the test, but that some deterioration had occurred from the heat. The foil scrim facing had been burned away and the insulation was partially blackened through. When removed from the backplate, the insulation broke apart into pieces, possibly indicating that a binding agent had been burned away. The aluminum plate was, again, in like-new condition.

Results from the pool fire simulation tests are presented in Figures 20, 21, and 22. The calibrated nozzle-to-specimen-surface distance was 20 ft. 6 in. The mineral fiber insulation physically survived and easily surpassed the CFR standard for a pool-fire simulation test series.

An unexplained problem with channel 10 in all

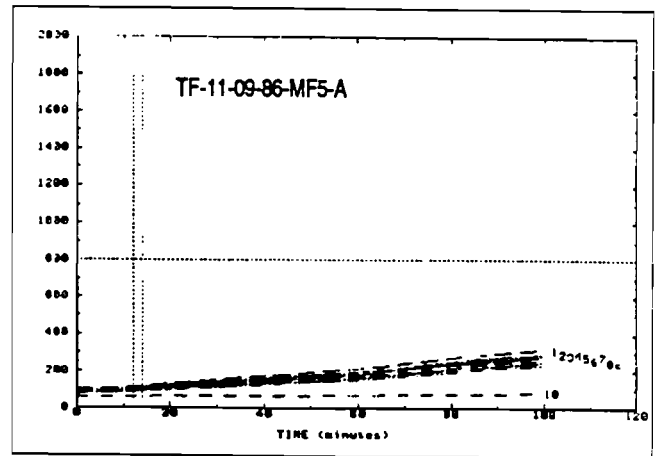

Figs. 20, 21 and 22: First, second and third pool fire simulations of the aluminum plate insulated with mineral fiber.

three tests manifested itself in a cool, flat, almost unchanging temperature curve. However, no problems were experienced with the important backplate channels.

In the first pool fire test (Figure 20) the backplate temperature reached a high of 580.9 deg. F (thermocouple No. 4). Wind velocities fluctuated between 0 and 6-1/2 m.p.h. and were only mildly disruptive.

Initially, there was some problem maintaining a central flame position on the target, with the top three thermocouples (Nos. 1, 2 and 3) being the hottest.

However, control was established further into the test and temperatures became uniform. Jacket temperatures were high (Appendix A) and rose from an average of 1,000 deg. F to an average of 1,400 deg. F in the last 30 min. of the test. The upturn of the nine backplate thermocouple temperatures during the last 30 min. of the test reflect the good flame contact and higher jacket temperature.

Post test examination of the mineral fiber specimen revealed that the blanket was fully in place over the aluminum backplate. The foil scrim facing tended to tear away as the jacket was removed. The blanket did not hold together as well as it had when new. The aluminum backplate was in like-new condition.

The second and third pool fire tests (Figures 21 and 22, respectively) resulted in backplate temperature curves that looked much alike and were cooler than in

the first test. Although wind speeds (which rarely exceeded 6 m.p.h. in either test) were not excessive, the wind direction seemed to cause swirling effects on the flame. Constant flame contact was difficult to achieve and jacket temperatures rarely rose above 1,000 deg. F (Appendix A).

The aluminum backplate temperatures reached a high of 326.9 deg. F in the second test (thermocouple No. 3), and 316.3 deg. F in the third test (thermocouple No. 1). These figures are well below the 800 deg. limit set by the CFR standard.

Post test examination of the specimens in both tests revealed that the insulation blanket was fully in place over the aluminum backplate and that the foil facing was also intact. Although there was little visible discoloration of the insulation, the blanket did not hold together as well as it had when new. The aluminum backplates were in like-new condition.

## 7.0 Summary and Conclusions

The aluminum tank car fire test series was composed of 20 thermal tests of combinations of aluminum plate and insulation, which were conducted according to the procedures specified in the Code of Federal Regulations, Title 49, Part 179.105-4, "Thermal Protection."

The objective of this test series was to gain information needed to examine the vulnerability of aluminum tank cars subjected to a thermal accident environment. Therefore, the CFR standard, which had been designed to test insulation systems proposed for use on steel tank cars was modified to accommodate this test series by substituting an aluminum plate for the steel plate.

Tank car aluminum plate specimens were subjected to simulated torch-fire and simulated pool-fire tests in the following four configurations:

- Uninsulated (bare) aluminum plate;
- Glass fiber-insulated aluminum plate;
- Ceramic fiber-insulated aluminum plate;
- Mineral fiber-insulated aluminum plate.

In the thermal test of uninsulated aluminum plate, it was expected and confirmed that the 1/2 in. plates would not pass or physically survive a torch-fire environment. In fact, they melted through in less than 5 min. In the three pool fire tests conducted, two plates survived with some visible warpage and one melted at 64-1/2 min. into the 100-min. test. All three plates failed to meet the CFR standard.

Glass fiber-insulated aluminum plate, with an 11 ga. steel jacket, did not pass a torch fire simulation test. The high temperatures caused the 4 in. glass fiber blanket to fall to the bottom, leaving the aluminum plate exposed to direct radiant heat from

the jacket. As a result, the aluminum backplates recorded a rapid temperature increase, and one exhibited slight warpage.

The pool fire simulation tests all were successful. The glass fiber specimens survived in surprisingly good condition, and the aluminum backplates were well-protected and in like-new appearance. A thin layer of high-temperature-rated material in front of the glass fiber would be needed for this material to pass a torch fire simulation test.

The ceramic fiber-insulated aluminum plate combination passed the full series of torch and pool fire simulation tests. The relatively thin 1/2-in. ceramic fiber material was especially effective in the higher temperature, shorter duration torch simulation tests. This material displayed little, if any, physical deterioration from the high temperatures. The aluminum plate was well protected in each test and survived in like new appearance.

The mineral fiber insulated aluminum plate system will also pass a full series of torch and pool fire simulation tests. The 1 in. thick material was the most effective in repressing heat transfer to the aluminum backplate. However, the mineral fiber material was blackened through half its depth during the torch fire simulation tests, and it appeared to lose some of its fiber-binding qualities in all of the tests. Therefore, it is questionable whether or not the insulation could be considered serviceable after exposure to a fire. If no mechanical method of holding the insulation in place is used in tank car construction, it seems possible that normal vibration and movement during transit could cause the burned insulation to separate and settle within the jacket.



## Appendix A: Specimen Graphs of Jacket Temperatures, Wind Speed and Direction

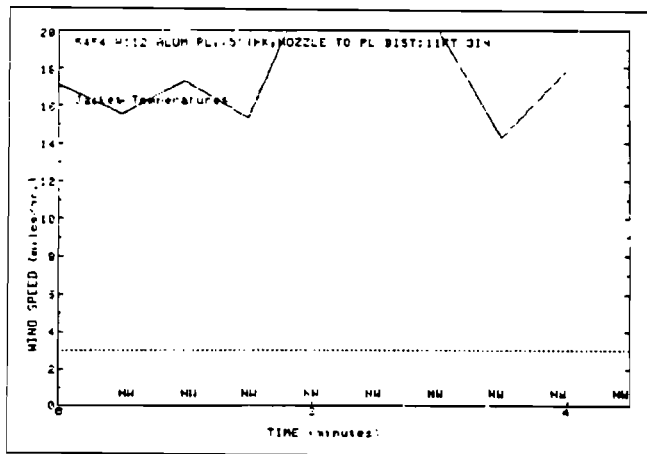

Fig. A-1: Torch fire test TF-21-01-ALU-A on uninsulated aluminum plate.

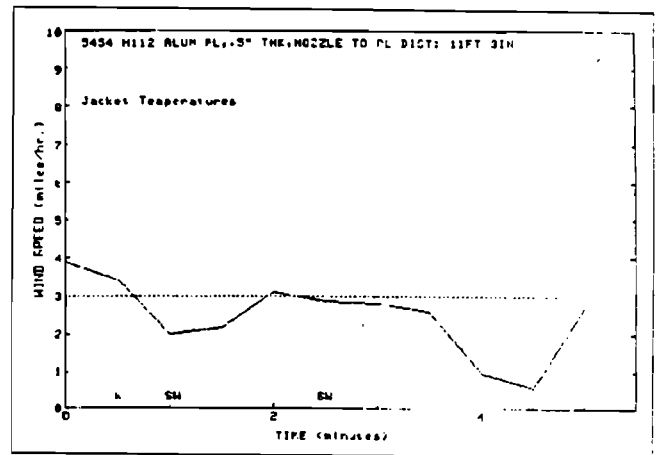

Fig. A-2: Torch fire test TF-23-01-86-ALU-A on uninsulated aluminum plate.

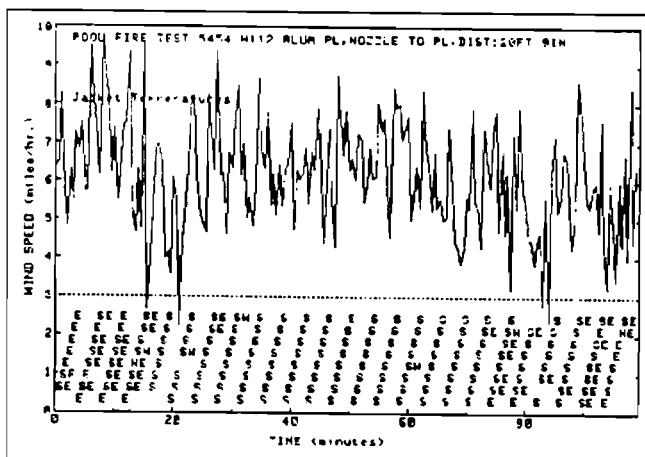

Fig. A-3: Pool fire test TF-01-02-86-ALU-A on uninsulated aluminum plate.

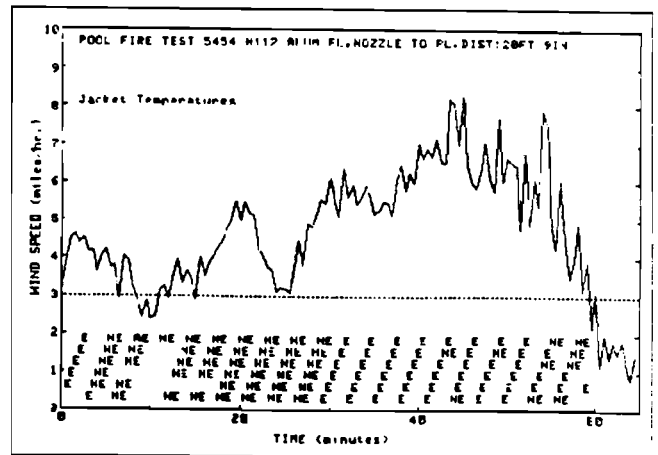

Fig. A-4: Pool fire test TF-03-02-86-ALU-A on uninsulated aluminum plate.

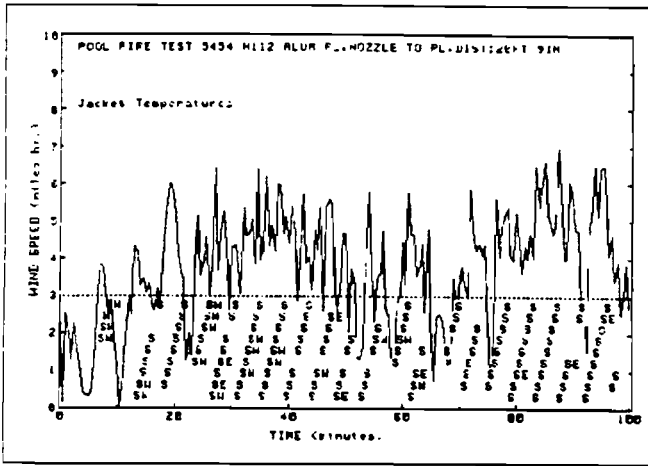

Fig. A-5: Pool fire test TF-03-02-86-ALU-B on uninsulated aluminum plate.

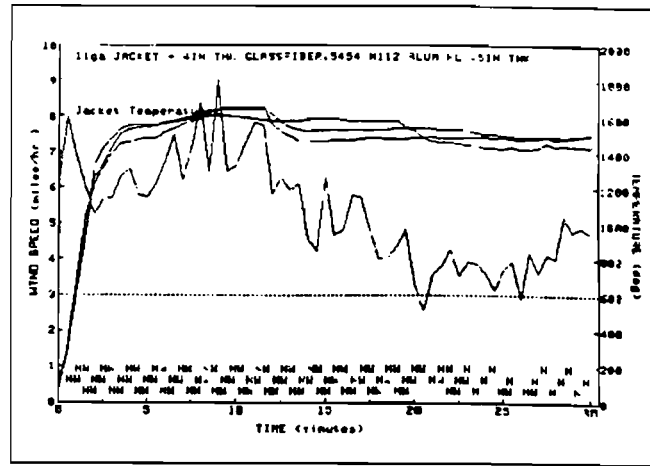

Fig. A-6: Torch fire test TF-29-01-86-OC1-A on aluminum plate insulated with glass fiber.

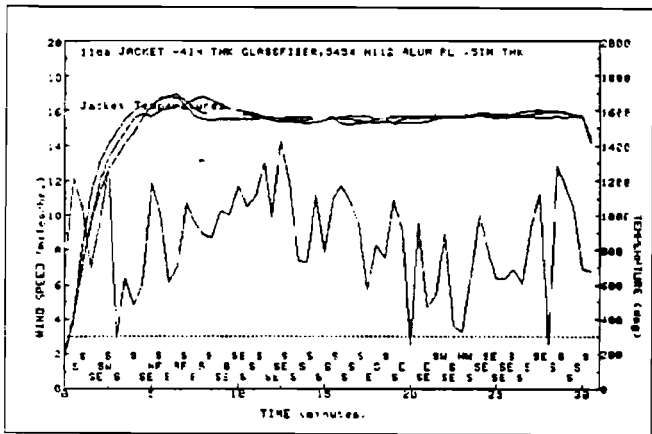

Fig. A-7: Torch fire test TF-29-01-86-OC2-A on aluminum plate insulated with glass fiber.

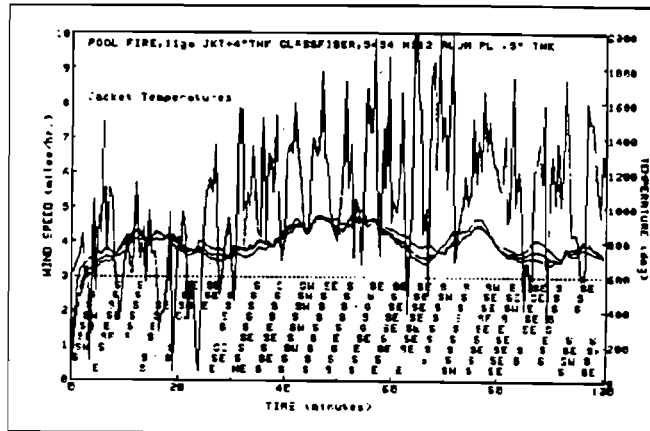

Fig. A-8: Pool fire test TF-26-03-86-OC4-A on aluminum plate insulated with glass fiber.

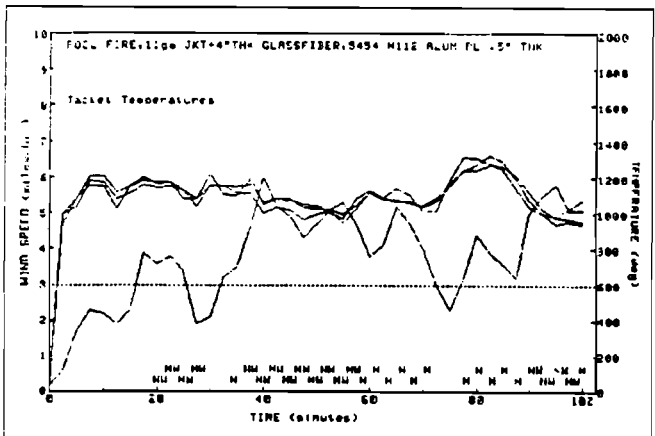

Fig. A-9: Pool fire test TF-27-03-86-OC6-A on aluminum plate insulated with glass fiber.

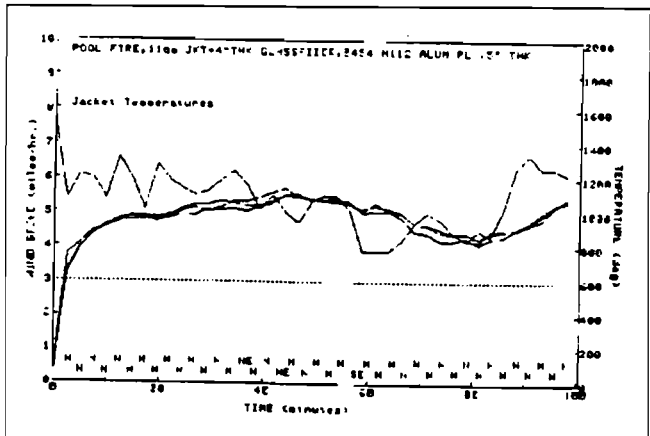

Fig. A-10: Pool fire test TF-28-03-86-OC7-A on aluminum plate insulated with glass fiber.



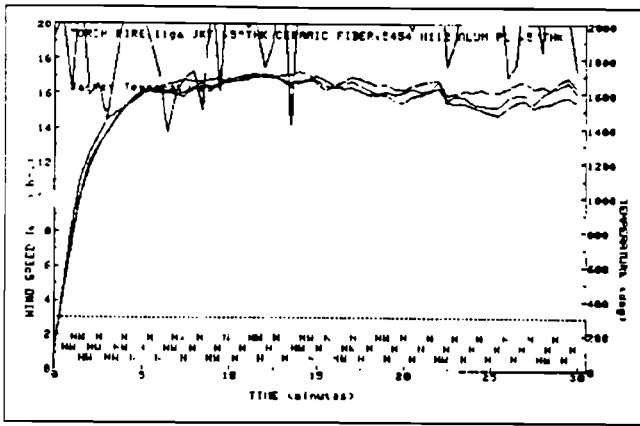

Fig. A-11: Torch fire test TF-16-05-86-CF1-A on aluminum plate insulated with ceramic fiber.

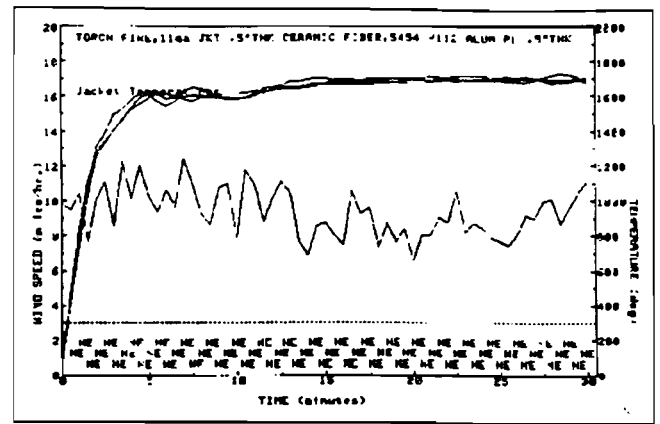

Fig. A-12: Torch fire test TF-16-05-86-CF2-A on aluminum plate insulated with ceramic fiber.

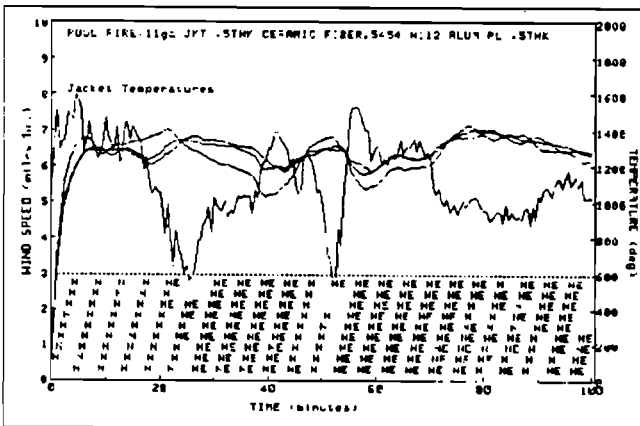

Fig. A-13: Pool fire test TF-21-05-86-CF3-A on aluminum plate insulated with ceramic fiber.

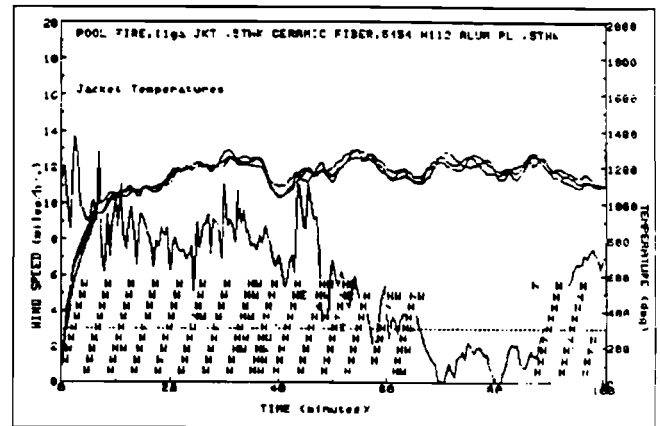

Fig. A-14: Pool fire test TF-22-05-86-CF4 on aluminum plate insulated with ceramic fiber.

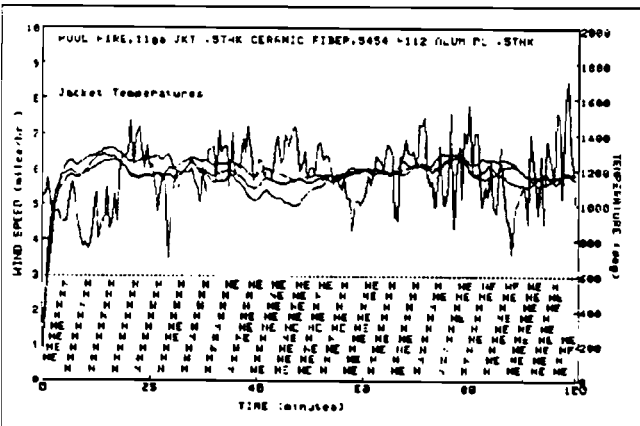

Fig. A-15: Pool fire test TF-23-05-86-CF5-A on aluminum plate insulated with ceramic fiber.

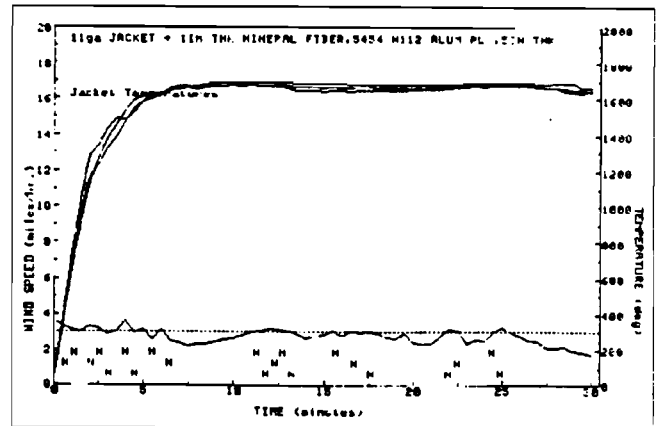

Fig. A-16: Torch fire test TF-03-09-86-MF1-A on aluminum plate insulated with mineral fiber.

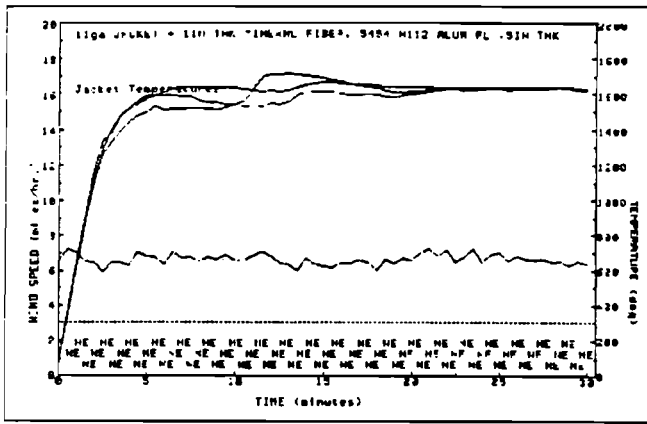

Fig. A-17: Torch fire test TF-04-09-86-MF2-A on aluminum plate insulated with mineral fiber.

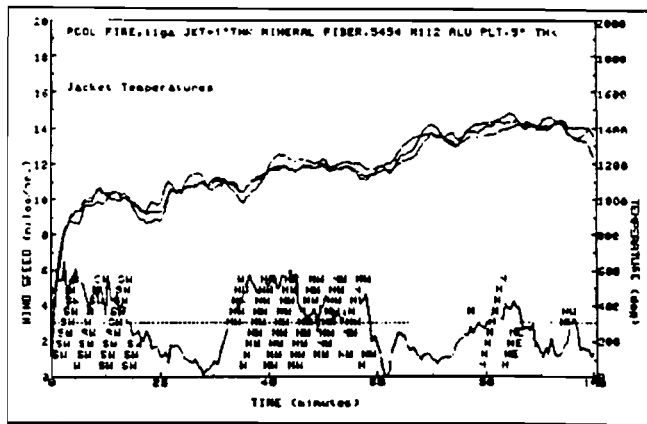

Fig. A-18: Pool fire test TF-08-09-86-MF3-A on aluminum plate insulated with mineral fiber.

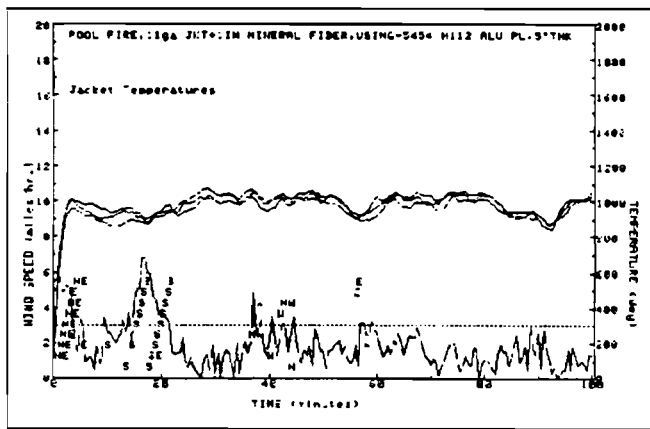

Fig. A-19: Pool fire test TF-09-86-MF4-A on aluminum plate insulated with mineral fiber.

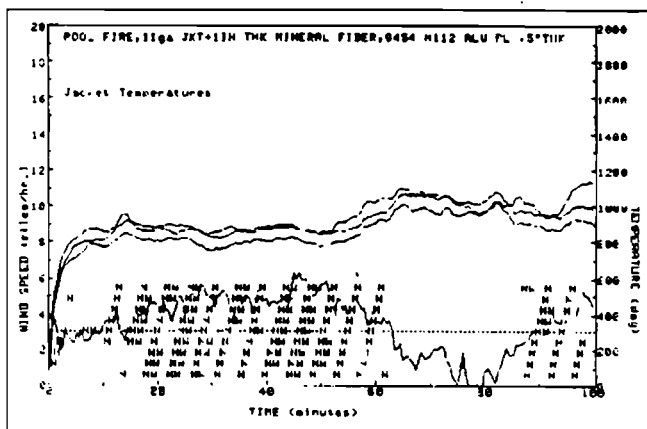

Fig. A-20: Pool fire test TF-11-09-86-MF5-A on aluminum plate insulated with mineral fiber.

## Appendix B: Calibration Test Graphs, Bare Plate Temperatures and Wind Speed and Direction

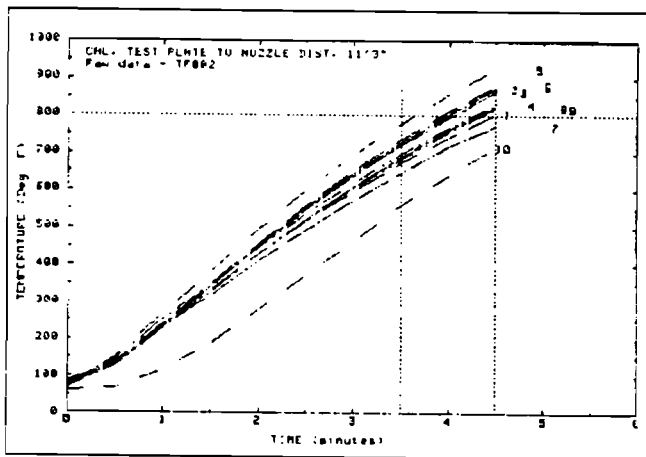

Fig. B-1: Torch fire calibration test TF-21-01-86-CAL-1, temperatures.

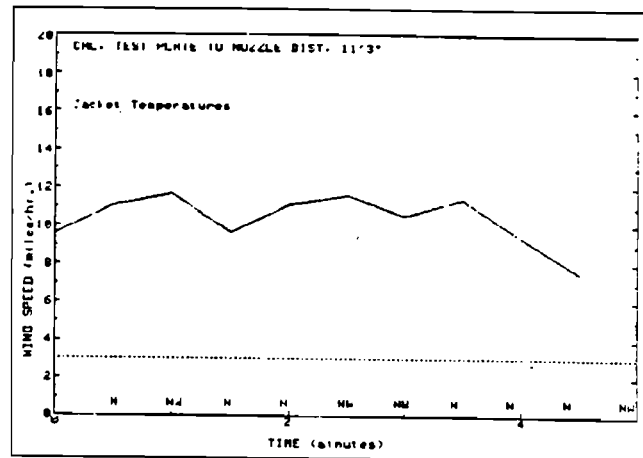

Fig. B-2: Torch fire calibration test TF-21-01-86-CAL-1, wind speed and direction.

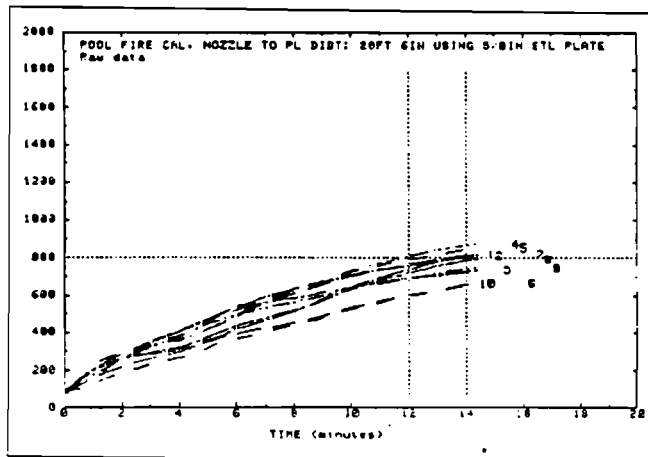

Fig. B-3: Pool fire calibration test TF-31-01-86-CAL-E, temperatures.

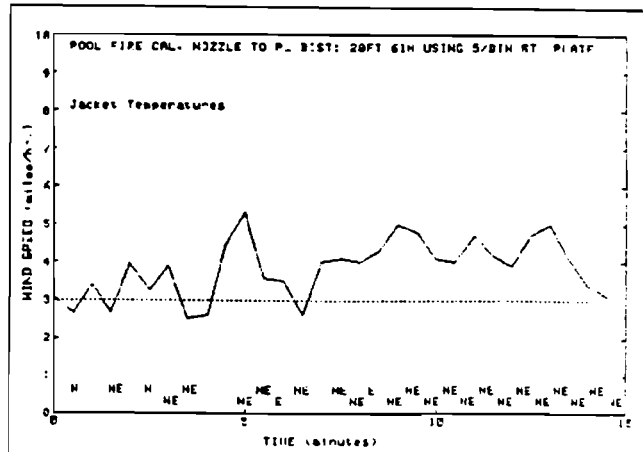

Fig. B-3: Pool fire calibration test TF-31-01-86-CAL-E, wind speed and direction.

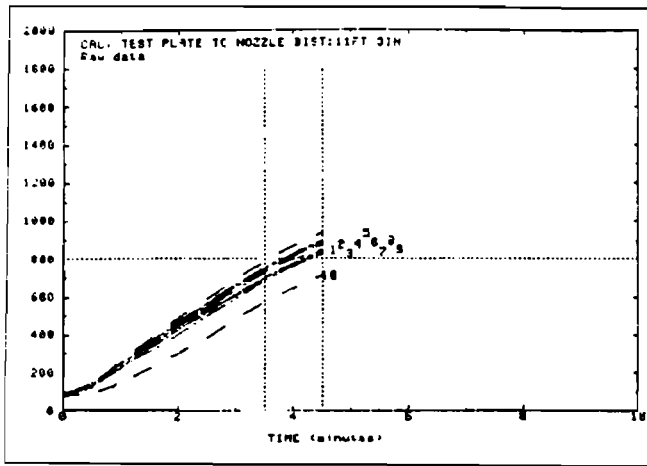

Fig. B-5: Torch fire calibration test TF-27-01-86-CAL-1, temperatures.

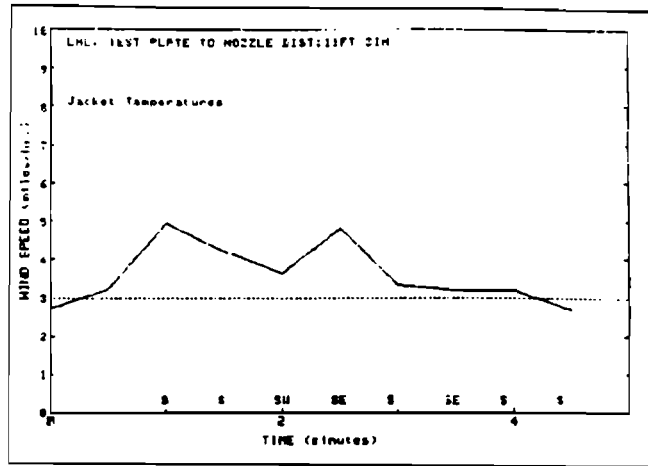

Fig. B-6: Torch fire calibration test TF-27-01-CAL-1, wind speed and direction.

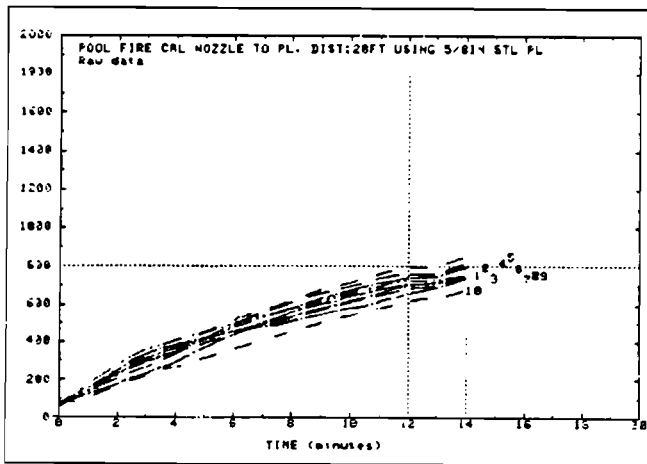

Fig. B-7: Pool fire calibration test TF-26-03-CAL-D, temperatures.

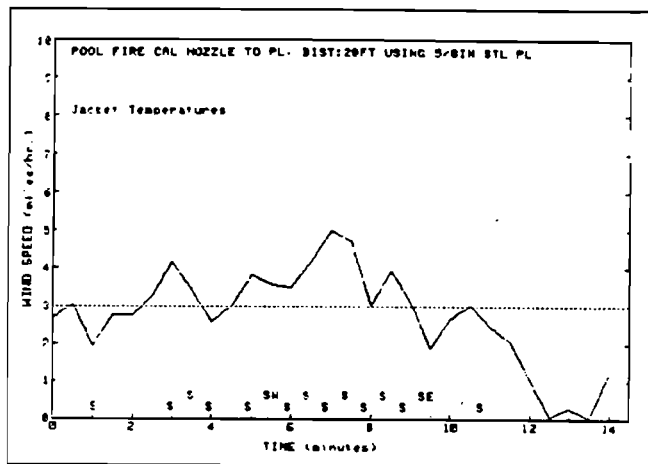

Fig. B-8: Pool fire calibration test TF-26-03-86-CAL-D, wind speed and direction.

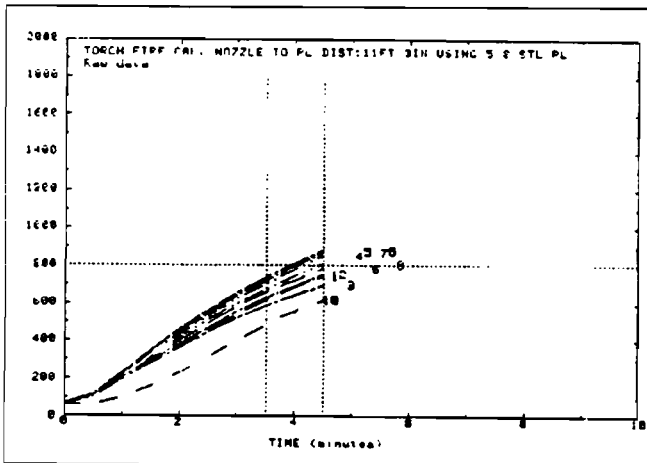

Fig. B-9: Torch fire calibration test TF-12-05-86-CAL-1, temperatures.

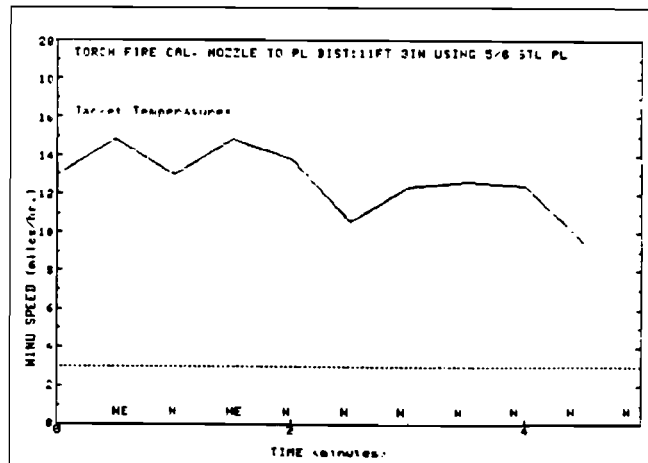

Fig. B-10: Torch fire calibration test TF-12-05-86-CAL-1, wind speed and direction.

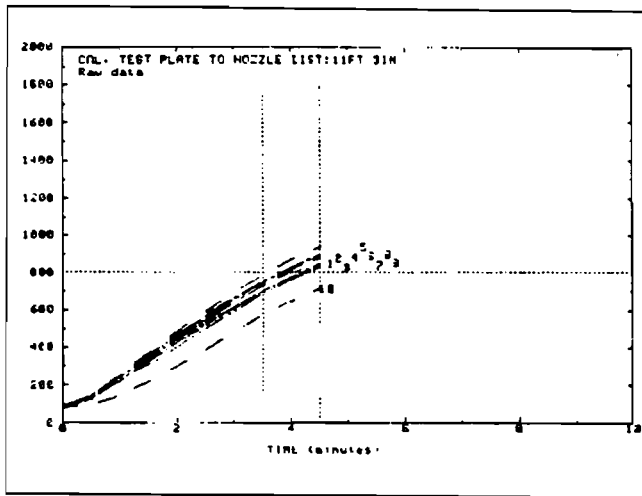

Fig. B-5: Torch fire calibration test TF-27-01-86-CAL-1, temperatures.

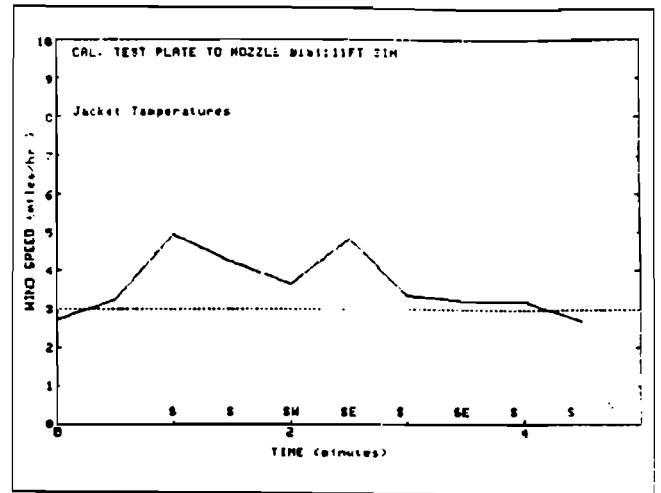

Fig. B-6: Torch fire calibration test TF-27-01-CAL-1, wind speed and direction.

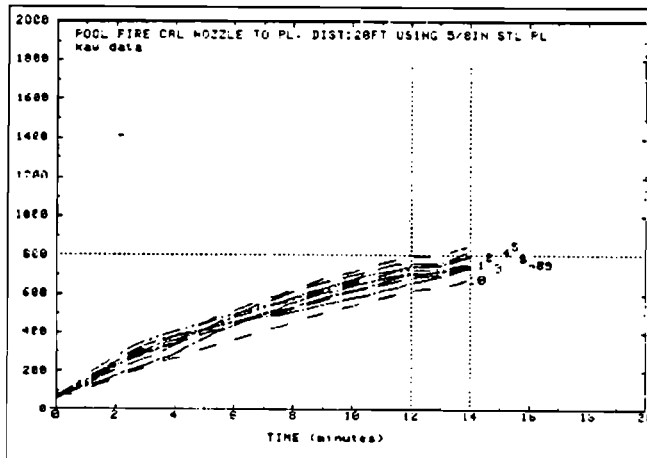

Fig. B-7: Pool fire calibration test TF-26-03-86-CAL-D, temperatures

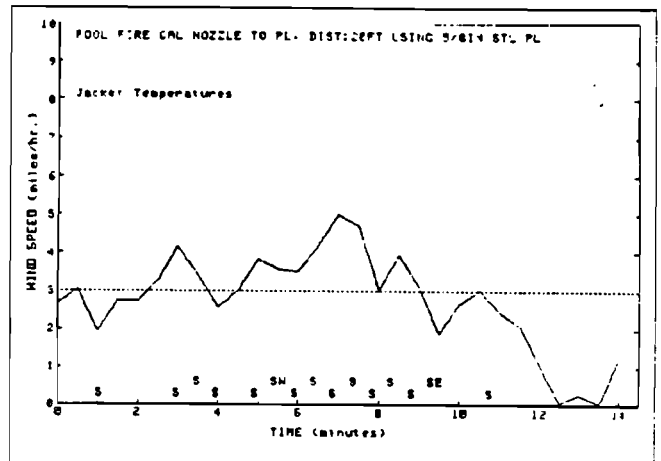

Fig. B-8: Pool fire calibration test TF-26-03-86-CAL-D, wind speed and direction.

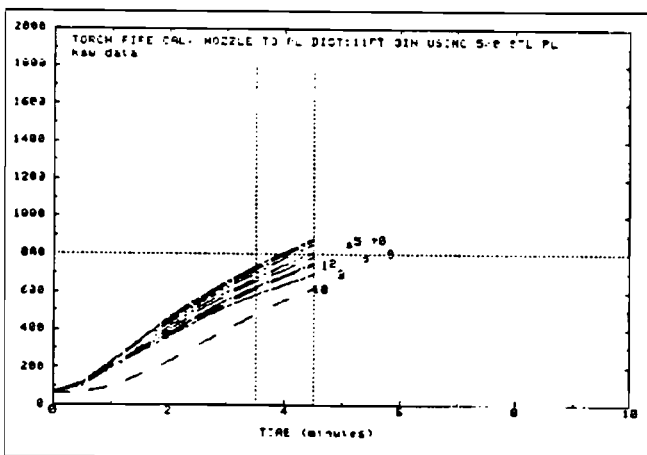

Fig. B-9: Torch fire calibration test TF-12-05-86-CAL-1, temperatures.

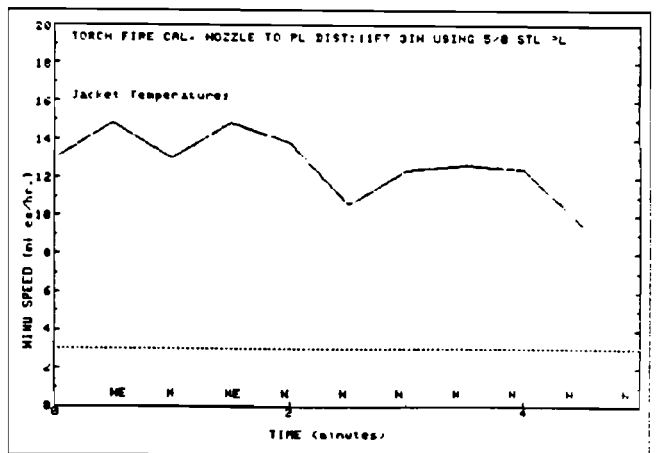

Fig. B-10: Torch fire calibration test TF-12-05-86-CAL-1, wind speed and direction.

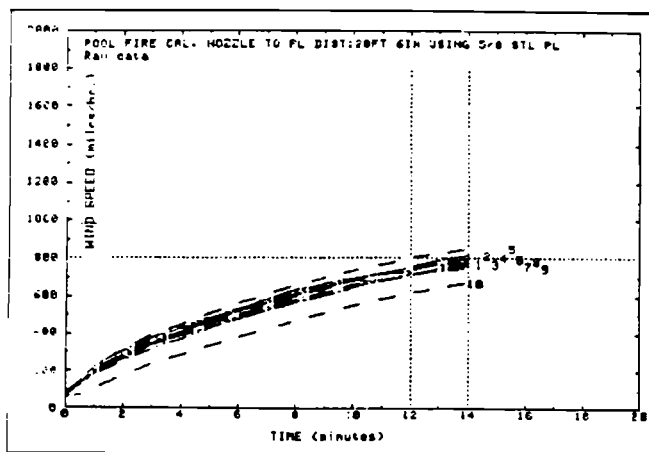

Fig. B-11: Pool fire calibration test TF-20-05-86-CAL-1, temperatures.

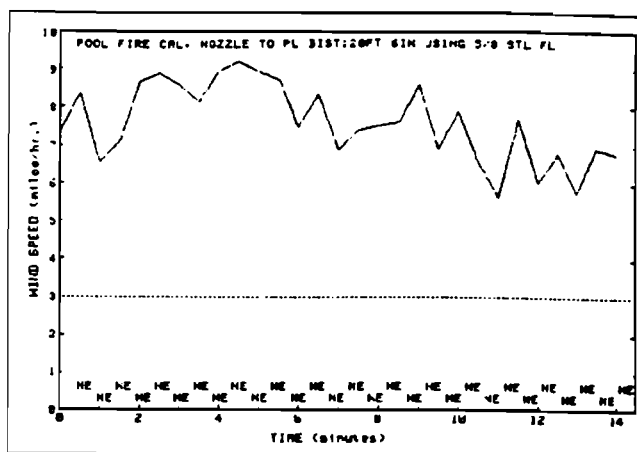

Fig. B-12: Pool fire calibration test TF-20-05-86-CAL-1, wind speed and direction.

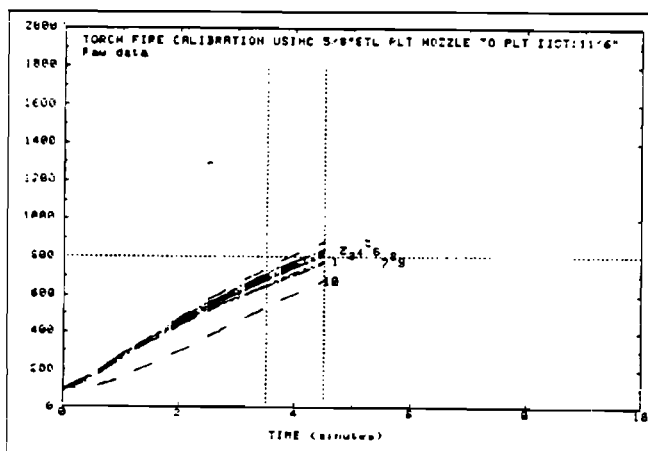

Fig. B-13: Torch fire calibration test TF-02-09-86-CAL-1, temperatures.

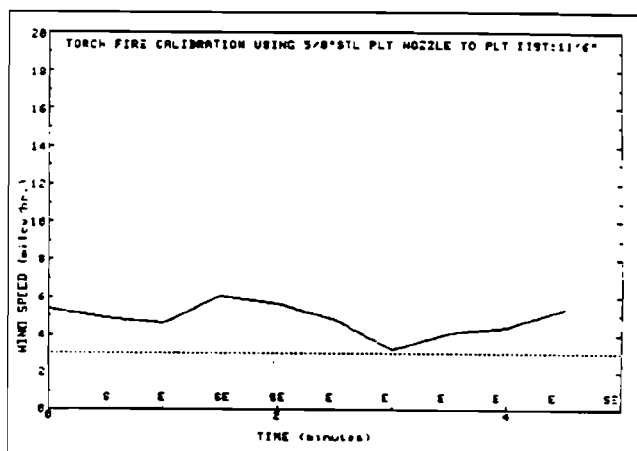

Fig. B-14: Torch fire calibration test TF-02-09-86-CAL-1, wind speed and direction.

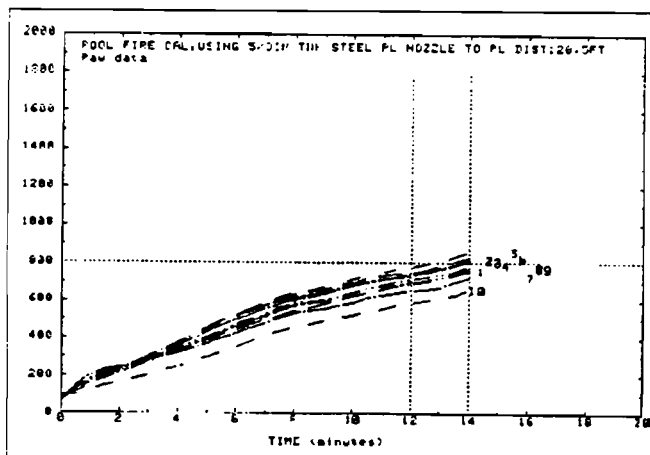

Fig. B-15: Pool fire calibration test TF-05-09-86-CAL-3, temperatures.

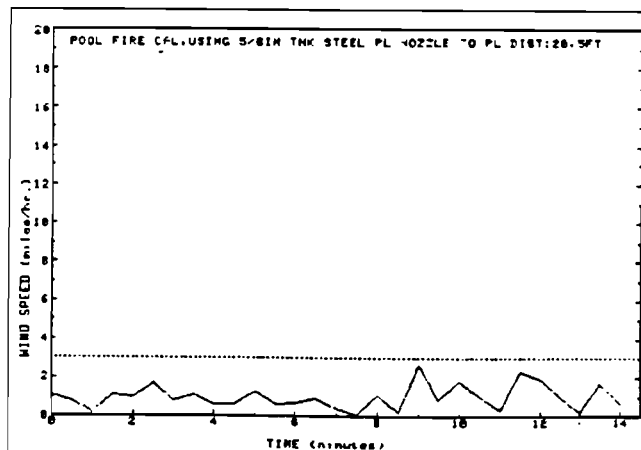

Fig. B-16: Pool fire calibration test TF-05-09-86-CAL-3, wind speed and direction.

## Appendix C: Test Standard, 49 CFR Part 179.105-4, 'Thermal Protection'

(4) Comply with paragraph (d) of this section.

(5) Be stenciled as prescribed in § 179.105-8.

(d) Each tank car owner shall equip its tank cars which are subject to paragraphs (b) and (c) of this section in accordance with the following schedule:

(1) Each tank car which is being retrofitted in accordance with paragraph (b) of this section, shall be retrofitted not later than December 31, 1979.

(2) Each tank car which is being retrofitted in accordance with paragraph (c) of this section, with a nonjacketed thermal protective system and a separate tank head puncture resistance system (112T/114T) shall be retrofitted:

(i) With the tank head puncture resistance system not later than December 31, 1979; and

(ii) With thermal protection not later than December 31, 1980.

(3) All tank cars being retrofitted in accordance with paragraph (c) of this section, with a thermal protective system enclosed in a metal jacket (112J/114J) shall be retrofitted such that:

(i) At least 20 percent of those cars owned on December 31, 1978, are so equipped by not later than that date;

(ii) At least 55 percent of those cars owned on December 31, 1979, are so equipped by not later than that date; and

(iii) All of those cars owned on December 31, 1980, are so equipped by not later than that date.

(49 U.S.C. 1803, 1804, 1808; 49 CFR 1.53(e))  
[Amdt. 179-19, 49 FR 46313, Sept. 15, 1977,  
as amended by Amdt. 179-23, 43 FR 30061,  
July 13, 1978]

### § 179.105-4 Thermal protection.

(a) *Performance standard.* Each specification 112T, 112J, 114T, and 114J tank car shall be equipped with a thermal protection system that prevents the release of any of the car's contents (except release through the safety relief valve) when subjected to:

- (1) A pool fire for 100 minutes; and
- (2) A torch fire for 30 minutes.

(b) *Test verification.* Except as provided in paragraph (c) of this section, compliance with the requirements of paragraph (a) of this section shall be

verified by testing and analyzing the thermal protection system in accordance with paragraphs (d), (e), and (f) of this section. A complete record of each test verification shall be made, retained and, upon request, made available for inspection and copying by authorized representatives of the Department.

(c) *Excepted systems.* The Department maintains a list of thermal protection systems which comply with the requirements of paragraphs (d) and (e) of this section and which are excepted from the test verification requirement of paragraph (b) of this section. Information necessary to equip tank cars with one of these systems is available in the Dockets Branch, Room 8426 of the Nassif Building, 400 Seventh Street SW., Washington, D.C. 20590, between the hours of 8:30 a.m. and 5:00 p.m., Monday through Friday.

(d) *Simulated pool fire test.* (1) A pool fire environment shall be simulated in the following manner:

(i) The source of the simulated pool fire shall be a hydrocarbon fuel. The flame temperature from the simulated pool fire shall be at 1600° F. plus or minus 100° F. throughout the duration of the test.

(ii) An uninsulated square steel plate with thermal properties equivalent to tank car steel shall be used. The plate dimensions shall be not less than one foot by one foot by nominal 3/8-inch thick. The plate shall be instrumented with not less than nine thermocouples to record the thermal response of the plate. The thermocouples shall be attached to the surface not exposed to the simulated pool fire, and shall be divided into nine equal squares with a thermocouple placed in the center of each square.

(iii) The pool fire simulator shall be constructed in a manner that results in total flame engulfment of the front surface of the bare plate. The apex of the flame shall be directed at the center of the plate.

(iv) The steel plate holder shall be constructed in such a manner that the only heat transfer to the back side of the plate is by heat conduction through the plate and not by other heat paths.

(v) Before the plate is exposed to the simulation pool fire, none of the temperature recording devices shall indicate the plate temperature in excess of 100° F. nor less than 32° F.

(vi) A minimum of two thermocouples devices shall indicate 800° F. after not less than 12 minutes nor more than 14 minutes of simulated pool fire exposure.

(2) A thermal insulation system shall be tested in the simulated pool fire environment described in paragraph (d)(1) of this section in the following manner:

(i) The thermal insulation system shall cover one side of a steel plate identical to that used to simulate a pool fire under paragraph (d)(1)(ii) of this section.

(ii) The uninsulated side of the steel plate shall be instrumented with not less than nine thermocouples placed as described in paragraph (d)(1)(ii) of this section to record the thermal response of the steel plate.

(iii) Before exposure to the pool fire simulation, none of the thermocouples on the thermal insulation system/steel plate configuration shall indicate a plate temperature in excess of 100° F. nor less than 32° F.

(iv) The entire insulated surface of the thermal insulation system shall be exposed to the simulated pool fire.

(v) A pool fire simulation test shall run for a minimum of 100 minutes. The thermal insulation system shall retard the heat flow to the steel plate so that none of the thermocouples on the uninsulated side of the steel plate indicates a plate temperature in excess of 800° F.

(vi) A minimum of three consecutive successful simulation fire tests shall be performed for each thermal insulation system.

(e) *Simulated torch fire test.* (1) A torch fire environment shall be simulated in the following manner:

(i) The source of the simulated torch shall be a hydrocarbon fuel. The flame temperature from the simulated torch shall be 2200° F. plus-or-minus 100° F. throughout the duration of the test. Torch velocities shall be 40 miles per hour plus-or-minus 10 miles per hour throughout the duration of the test.

(ii) An uninsulated square steel plate with thermal properties equivalent to tank car steel shall be used. The plate dimensions shall be not less than four feet by four feet by nominal ¼-inch thick. The plate shall be instrumented with not less than nine thermocouples to record the thermal response of the plate. The thermocouples shall be attached to the surface not exposed to the simulated torch, and shall be divided into nine equal squares with a thermocouple placed in the center of each square.

(iii) The steel-plate holder shall be constructed in such a manner that the only heat transfer to the back side of the plate is by heat conduction through the plate and not by other heat paths. The apex of the flame shall be directed at the center of the plate.

(iv) Before exposure to the simulated torch, none of the temperature recording devices shall indicate a plate temperature in excess of 100° F. or less than 32° F.

(v) A minimum of two thermocouples shall indicate 800° F. in a time of 4.0 plus-or-minus 0.5 minutes of torch simulation exposure.

(2) A thermal insulation system shall be tested in the simulated torch fire environment described in paragraph (e)(1) of this section in the following manner:

(i) The thermal insulation system shall cover one side of a steel plate identical to that used to simulate a torch fire under paragraph (e)(1)(ii) of this section.

(ii) The back of the steel plate shall be instrumented with not less than nine thermocouples placed as described in paragraph (e)(1)(ii) of this section to record the thermal response of the steel.

(iii) Before exposure to the simulated torch, none of the thermocouples on the thermal insulation system steel plate configuration shall indicate a plate temperature in excess of 100° F. nor less than 32° F.

(iv) The entire outside surface of the thermal insulation system shall be exposed to the simulated torch fire environment.

(v) A torch simulation test shall be run for a minimum of 30 minutes. The



thermal insulation system shall retard the heat flow to the steel plate so that none of the thermocouples on the un-insulated side of the steel plate indicates a plate temperature in excess of 800° F.

(vi) A minimum of two consecutive successful torch simulation tests shall be performed for each thermal insulation system.

(f) *Analysis.* The analysis required by paragraph (b) of this section must verify that the entire surface of the tank car, including discontinuous structures (e.g., stub sills, protective housings, etc.), complies with the requirements of paragraph (a) of this section.

(g) *Exterior tank color.* Notwithstanding the provisions of § 179.101-1(a) Table, Note 4, each specification 112 and 114 tank car equipped with thermal protection that complies with the requirements of paragraph (a) of this section need not be painted white.

[Amdt. 179-19, 42 FR 46313, Sept. 15, 1977, as amended by Amdt. 179-27, 46 FR 8011, Jan. 26, 1981]

**§ 179.105-5 Tank head puncture resistance.**

(a) *Performance standard.* Each specification 112S, 112T, 112J, 114S, 114T, and 114J tank car shall be capable of sustaining, without loss of contents, coupler-to-tank head impacts within the area of the tank head described in § 179.100-23 at relative car speeds of 18 miles per hour when:

(1) The weight of the impact car is at least 263,000 pounds;

(2) The impacted tank car is coupled to one or more "backup" cars which have a total weight of at least 480,000 pounds and the hand brakes are applied on the first car; and

(3) The impacted tank car is pressurized to at least 100 psi.

(b) *Test verification.* Compliance with the requirements of paragraph (a) of this section shall be verified by full scale testing or by the alternate test procedures prescribed in paragraph (c) of this section. However, protective head shields that meet the requirements of § 179.100-23 or full tank head jackets that are at least 1/4-inch thick and made from steels specified

in § 179.100-23(a)(1) need not be verified by testing.

(c) *Tank head puncture resistance test.* A tank head resistance system shall be tested under the following conditions:

(1) The ram car used shall weigh at least 263,000 pounds, be equipped with a coupler, and duplicate the condition of a conventional draft sill including the draft yoke and draft gear. The coupler shall protrude from the end of the ram car so that it is the leading location of perpendicular contact with the standing tank car.

(2) The impacted test car shall be loaded with water at six percent outage with internal pressure of at least 100 psi and coupled to one or more "backup" cars which have a total weight of 480,000 pounds with hand brakes applied on the first car.

(3) At least two separate tests shall be conducted with the coupler on the vertical centerline of the ram car. One test shall be conducted with the coupler at a height of 21 inches, plus-or-minus one-inch, above the top of the sill; the other test shall be conducted with the coupler height at 31 inches, plus-or-minus one-inch above the top of the sill. If the combined thickness of the tank head and any additional shielding material at any position over the area described in § 179.100-23 is less than the combined thickness on the vertical centerline of the car, a third test shall be conducted with the coupler positioned so as to strike the thinnest point.

(4) One of the following test procedures shall be applied:

	Minimum velocity of impact (in miles per hour)	Restriction
Minimum weight of ram car plus attached cars (in pounds)		
263,000	18	1 ram car only
480,000	18	1 ram car or 1 ram car plus 1 rigidly attached car

## Appendix D: Related Materials

### **Tank Car Fire Test Reports**

1. *Thermal Insulation Systems Study for the Chlorine Tank Car*, FRA/ORD-85/10.
2. *Thermal Protection Study of Cryogenic Tank Cars*, DOT/FRA/ORD-85/12.
3. *Comparison of Thermally Coated and of Uninsulated Rail Tank Cars Filled with LPG Subjected to a Fire Environment*, FRA/ORD-75/32.
4. *Effects of a Fire on a Tank Car Filled With LPG*, FRA/ORD-75-31.
5. *Comparison of Various Thermal Systems for the Protection of Rail Tank Cars Tested at the FRA/BRL Torching Facility*, FRA Interim Memorandum Report, December, 1975.

### **Instruction Manuals**

- 1 *Operating Instructions for the Torch Fire Test Facility*, Transportation Test Center (unpublished).

### **Federal Standards**

1. *Specifications for Railroad Tank Cars Used to Transport Hazardous Materials*, DOT Docket HM-175, Amdt. Nos. 173-173, 179-35.
2. *Shippers; Specifications for Railroad Tank Cars*, DOT Docket HM-174; Amdt. Nos. 173-172, 179-34.
3. *Research and Special Programs Administration: "List of Excepted Thermal Protection Systems for Tank Cars," Federal Register*, latest edition.
4. "Specifications for Tank Cars," Title 49, Code of Federal Regulations (Transportation), Part 179.
5. "Shippers - General Requirements for Shipments and Packagings," Title 49, Code of Federal Regulations (Transportation), Part 173.

