



U. S. Department
of Transportation
**Federal Railroad
Administration**

Rail Vehicle Crashworthiness Symposium

Office of Research
and Development
Washington, D.C. 20590

**June 24-26, 1996
Volpe National Transportation Systems Center
Cambridge, Massachusetts**



Sponsored by the FRA's Office of Research and Development

DOT/FRA/ORD-97/08
DOT-VNTSC-FRA-98-1

March 1998
Final Report

This document is available to the
public through the National Technical
Information Service, Springfield, VA 22161

NOTICE

This document is disseminated under the sponsorship of the Department of Transportation in the interest of information exchange. The United States Government assumes no liability for its contents or use thereof.

NOTICE

The United States Government does not endorse products or manufacturers. Trade or manufacturers' names appear herein solely because they are considered essential to the objective of this report.

REPORT DOCUMENTATION PAGE*Form Approved*
OMB No. 0704-0188

Public reporting burden for this collection of information is estimated to average 1 hour per response, including the time for reviewing instructions, searching existing data sources, gathering and maintaining the data needed, and completing and reviewing the collection of information. Send comments regarding this burden estimate or any other aspect of this collection of information, including suggestions for reducing this burden, to Washington Headquarters Services, Directorate for Information Operations and Reports, 1215 Jefferson Davis Highway, Suite 1204, Arlington, VA 22202-4302, and to the Office of Management and Budget, Paperwork Reduction Project (0704-0188), Washington, DC 20503.

1. AGENCY USE ONLY (Leave blank)		2. REPORT DATE March 1998		3. REPORT TYPE AND DATES COVERED Final Report June 1996 – July 1997	
4. TITLE AND SUBTITLE Rail Vehicle Crashworthiness Symposium				5. FUNDING NUMBERS R8001/RR828	
6. EDITOR(S) David C. Tyrell, Arthur H. Rubin					
7. PERFORMING ORGANIZATION NAME(S) AND ADDRESS(ES) U.S. Department of Transportation Research and Special Programs Administration Volpe National Transportation Systems Center Kendall Square, Cambridge, MA 02142-1093				8. PERFORMING ORGANIZATION REPORT NUMBER DOT-VNTSC-FRA-98-1	
9. SPONSORING/MONITORING AGENCY NAME(S) AND ADDRESS(ES) U.S. Department of Transportation Federal Railroad Administration Office of Research and Development Washington, DC 20590				10. SPONSORING/MONITORING AGENCY REPORT NUMBER DOT/FRA/ORD-97/08	
11. SUPPLEMENTARY NOTES					
12a. DISTRIBUTION/AVAILABILITY STATEMENT This document is available to the public through the National Technical Information Service, Springfield, VA 22161				12b. DISTRIBUTION CODE	
13. ABSTRACT (Maximum 200 words) This document contains the proceedings of the Rail Vehicle Crashworthiness Symposium held at the Volpe Center in Cambridge, Massachusetts on June 24, 25, and 26, 1996. These proceedings have been developed from a transcript of the symposium and the material used by the presenters at the symposium. The symposium was conducted in three technical sessions over three days. The three sessions were: 1. Collision Risk: Strategies for evaluating the effectiveness of collision safety measures incorporated into a train system; description of the likely collision scenarios that can occur on train systems. 2. Structural Crashworthiness: The performance of the vehicle structure during a collision; its ability to preserve sufficient volume for the passengers to survive and its ability to control the decelerations experienced by the occupied volumes. 3. Interior Crashworthiness: The performance of the interior during a collision; the ability of the interior to limit the forces and decelerations imparted to the occupant. Presenters at the symposium included representatives from foreign government agencies, including Société Nationale des Chemin de Fer Français (French National Railways) and British Rail Research, as well as from several agencies within the U.S. Department of Transportation, including the Federal Railroad Administration (FRA), the National Highway Transportation Safety Administration, the Federal Aviation Administration, and the Research and Special Programs Administration's Volpe Center. Representatives from foreign and domestic rail equipment suppliers, as well as domestic transportation operators, also gave presentations.					
14. SUBJECT TERMS Collision risk, structural crashworthiness, interior crashworthiness, human injury criteria (HIC), passenger rail safety, secondary impact				15. NUMBER OF PAGES 606	
				16. PRICE CODE	
17. SECURITY CLASSIFICATION OF REPORT Unclassified	18. SECURITY CLASSIFICATION OF THIS PAGE Unclassified	19. SECURITY CLASSIFICATION OF ABSTRACT Unclassified	20. LIMITATION OF ABSTRACT		

METRIC/ENGLISH CONVERSION FACTORS

ENGLISH TO METRIC

METRIC TO ENGLISH

<p>LENGTH (APPROXIMATE)</p> <p>1 inch (in) = 2.5 centimeters (cm) 1 foot (ft) = 30 centimeters (cm) 1 yard (yd) = 0.9 meter (m) 1 mile (mi) = 1.6 kilometers (km)</p>	<p>LENGTH (APPROXIMATE)</p> <p>1 millimeter (mm) = 0.04 inch (in) 1 centimeter (cm) = 0.4 inch (in) 1 meter (m) = 3.3 feet (ft) 1 meter (m) = 1.1 yards (yd) 1 kilometer (km) = 0.6 mile (mi)</p>
<p>AREA (APPROXIMATE)</p> <p>1 square inch (sq in, in²) = 6.5 square centimeters (cm²) 1 square foot (sq ft, ft²) = 0.09 square meter (m²) 1 square yard (sq yd, yd²) = 0.8 square meter (m²) 1 square mile (sq mi, mi²) = 2.6 square kilometers (km²) 1 acre = 0.4 hectare (he) = 4,000 square meters (m²)</p>	<p>AREA (APPROXIMATE)</p> <p>1 square centimeter (cm²) = 0.16 square inch (sq in, in²) 1 square meter (m²) = 1.2 square yards (sq yd, yd²) 1 square kilometer (km²) = 0.4 square mile (sq mi, mi²) 10,000 square meters (m²) = 1 hectare (ha) = 2.5 acres</p>
<p>MASS - WEIGHT (APPROXIMATE)</p> <p>1 ounce (oz) = 28 grams (gm) 1 pound (lb) = 0.45 kilogram (kg) 1 short ton = 2,000 pounds (lb) = 0.9 tonne (t)</p>	<p>MASS - WEIGHT (APPROXIMATE)</p> <p>1 gram (gm) = 0.036 ounce (oz) 1 kilogram (kg) = 2.2 pounds (lb) 1 tonne (t) = 1,000 kilograms (kg) = 1.1 short tons</p>
<p>VOLUME (APPROXIMATE)</p> <p>1 teaspoon (tsp) = 5 milliliters (ml) 1 tablespoon (tbsp) = 15 milliliters (ml) 1 fluid ounce (fl oz) = 30 milliliters (ml) 1 cup (c) = 0.24 liter (l) 1 pint (pt) = 0.47 liter (l) 1 quart (qt) = 0.96 liter (l) 1 gallon (gal) = 3.8 liters (l) 1 cubic foot (cu ft, ft³) = 0.03 cubic meter (m³) 1 cubic yard (cu yd, yd³) = 0.76 cubic meter (m³)</p>	<p>VOLUME (APPROXIMATE)</p> <p>1 milliliter (ml) = 0.03 fluid ounce (fl oz) 1 liter (l) = 2.1 pints (pt) 1 liter (l) = 1.06 quarts (qt) 1 liter (l) = 0.26 gallon (gal) 1 cubic meter (m³) = 36 cubic feet (cu ft, ft³) 1 cubic meter (m³) = 1.3 cubic yards (cu yd, yd³)</p>
<p>TEMPERATURE (EXACT)</p> <p>$[(x-32)(5/9)] \text{ } ^\circ\text{F} = y \text{ } ^\circ\text{C}$</p>	<p>TEMPERATURE (EXACT)</p> <p>$[(9/5)y + 32] \text{ } ^\circ\text{C} = x \text{ } ^\circ\text{F}$</p>

QUICK INCH - CENTIMETER LENGTH CONVERSION

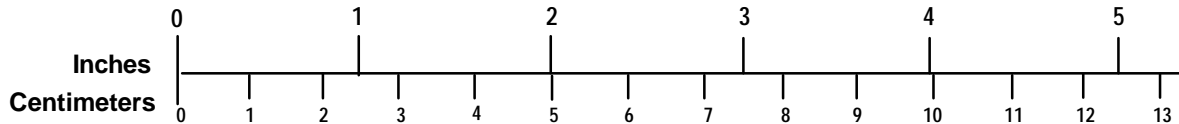

QUICK FAHRENHEIT - CELSIUS TEMPERATURE CONVERSION

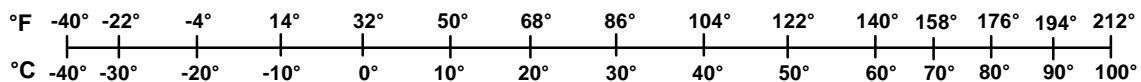

For more exact and or other conversion factors, see NIST Miscellaneous Publication 286, Units of Weights and Measures.
 Price \$2.50 SD Catalog No. C13 10286

Updated 6/17/98

Preface

The Rail Vehicle Crashworthiness Symposium was held at the U.S. Department of Transportation's Volpe National Transportation Systems Center in Cambridge, Massachusetts on June 24, 25, and 26, 1996. The objective of the symposium was to present results of current research on rail equipment collision safety and to provide a forum for exchange of technical information among research organizations, passenger railroad operators, equipment manufacturers, and constituent organizations concerned with rail passenger car collision safety. The symposium was organized, in part, to address interest in rail equipment crashworthiness research results expressed by the government-industry working group on Rail Passenger Equipment Safety Standards. This working group was organized by the Federal Railroad Administration (FRA) for the purpose of developing passenger equipment safety standards. Members of the working group include the operators, represented principally through Amtrak and the American Passenger Transit Association, the unions-- Brotherhood of Locomotive Engineers, Brotherhood of Railway Carmen, and the United Transportation Union -- and the suppliers -- General Motors Electro-Motive Division, General Electric Transportation Systems, Bombardier, GEC Alsthom, and Siemens Transportation Systems -- and other government organizations including the Federal Transit Administration (FTA) and the National Transportation Safety Board. Additional motivation for the symposium came from the significant advances made in rail equipment crashworthiness in the past decade.

Worldwide, there have been substantial efforts made over the last ten years to increase the crashworthiness of rail equipment, driven by concerns caused by increased equipment speeds, which can increase the severity of train collisions, and increased traffic density, which can increase the likelihood of the occurrence of train collisions. These efforts have resulted in rail equipment such as the double deck TGV trainset, which includes crush-zones in the nose and at the rear of the power cars and at the front of the end trailers and the British 465 Networker multiple-unit commuter train, which includes crush-zones at the leading and trailing ends of each of the cars. In a collision, these crush zones are designed to absorb some of the collision energy and to collapse in controlled manner. The American Flyer - Amtrak's high speed trainset for the Northeast Corridor - is being designed with crush zones in the nose and at the rear of the power cars and leading and trailing ends of the passenger cars.

Proposals to include crush zones in rail equipment to control the decelerations of the occupant volume, carbody structural design strategies to increase occupant volume strength, lap and shoulder belts to restrain passengers and prevent direct impacts of the occupants with the interior, and other concepts for improved rail equipment crashworthiness have been made for nearly 100 years. Until relatively recently, evaluating the effectiveness of these concepts and fully developing those concepts found to be effective has been time-consuming and expensive. Rail equipment is expensive - it costs about \$2 million to purchase a single rail passenger coach car - which has precluded the widespread use of experimental techniques like those used by the automotive industry. Detailed computer modeling programs, which can simulate transportation equipment collisions and other conditions which cause large deformations of structures, have been developed by the aerospace industry. These programs have been available for more than ten years, but affordable computer equipment capable of exercising detailed models of train collisions have only been available for about five years.

The symposium was sponsored by the Federal Railroad Administration's Office of Research and Development and conducted as part of the Improved Equipment Safety and High Speed Ground Transportation Programs which the FRA supports at the Volpe Center. The symposium was organized by Tom Tsai, of the FRA's Equipment and Operating Practices Division, Herbert Weinstock, Chief of the Volpe Center's Structures and Dynamics Division, David Tyrell and Joseph Davin of the Volpe Center's Structures and Dynamics Division, and Debra Duncan of Camber Corporation.

In 1978 the Center organized and held the Urban Rail Vehicle Crashworthiness Workshop. At the workshop, results of then-current research on rail equipment collision safety were presented and technical information was exchanged among constituent organizations concerned with rail passenger car collision safety. Under the sponsorship of the FRA and FTA, the Volpe Center has conducted research on rail passenger equipment crashworthiness to develop strategies to better protect the operator and passengers, freight locomotive crashworthiness to develop strategies to better protect the operator, as well as tank car crashworthiness to develop strategies to minimize the likelihood of a hazardous materials spill. The Volpe Center conducts research in a broad range of technical areas related to transportation safety.

Table of Contents

<u>Opening Session</u>	<u>Page</u>
Opening Session/Welcome/Introductory Remarks	1
<u>Session I: Collision Risk</u>	
Methodology/Approach	I-1-1
The Need for Rail Passenger Equipment Structural Standards/Accident History Review	I-2-1
Operator Experience	1-3-1
Detailed Risk Assessment	I-4-1
Collision Risk Panel Discussion	I-5-1
<u>Session IIa: Design Considerations</u>	
Structural Crashworthiness Design Practice	IIA- 1-1
Design Considerations for Rail Vehicle Crashworthiness	IIA-2-1
High-Speed Rail Collision Safety	IIA-3-1
Crush-Zone Development	IIA-4-1
<u>Session IIb: New Trainset Designs</u>	
Structural Crashworthiness Overview.....	IB-1-1
Crashworthiness of TGV 2N and the TER	IB-2- 1
NEC Trainsets - Practical Considerations for the Introduction of a Crash Energy Management System.....	IIB-3-1
Structural Crashworthiness Panel Discussion	IIB-4-1

Table of Contents (cont.)

<u>Session IIc: Locomotive Crashworthiness</u>	<u>Page</u>
Locomotive Crashworthiness Research	IIC- 1-1
Locomotive Crashworthiness: A Builder's Perspective	IIC-2-1
GE Genesis Series Locomotives	IIC-3-1
Structural Crashworthiness Panel Discussion	IIC-4-1
 <u>Session III: Interior Crashworthiness</u>	
Interior Collision Environment	III-1-1
Testing and Analysis of Occupant Vehicle Collisions	III-2-1
Occupant Restraint	III-3-1
Passenger Response in Train Collisions	III-4-1
Interior Crashworthiness Panel Discussion.....	III-5-1
 <u>Appendix</u>	
Speakers.....	A-1
Attendees.....	A-4

Agenda

FRA Symposium on Rail Vehicle Crashworthiness

Volpe National Transportation Systems Center

Cambridge, Massachusetts

----- **Monday, June 24, 1996** -----

Registration 8:30 - 9:30 a.m.

Opening Session

Welcome 9:30 - 9:45 a.m.
Dr. Richard R. John, Director
Volpe National Transportation Systems Center

Introductory Remarks 9:45 - 10:15 a.m.
James T. McQueen, Associate Administrator *Grady Cothen, Deputy Associate Administrator*
Railroad Development *Safety Standards*
Federal Railroad Administration *Federal Railroad Administration*

Session I: Collision Risk

Chair
Grady Cothen, Deputy Associate Administrator
Safety Standards
Federal Railroad Administration

Co-Chair
Robert Dorer, Chief
High Speed Ground Transportation Office
Volpe Center

Methodology/Approach 10:15- 11:00 a.m.
Dr. Alan Bing, Arthur D. Little, Inc.

The Need for Rail Passenger Equipment Structural Standards 11:00 - 11:45 a.m.
Thomas Peacock, Federal Railroad Administration

Lunch 11:45 - 1:15 p.m.

Operator Experience 1:15 - 2:00 p.m.
Frank Cihak, American Public Transit Association

Detailed Risk Assessment 2:00 - 2:45 p.m.
Dr. Mark Snyder, Foster-Miller, Inc.
Duncan W. Allen, P.E., DeLeuw, Cather & Company

Break 2:45- 3:00 p.m.

Collision Risk Panel Discussion 3:00- 4:00 p.m.
Robert Dorer, Volpe Center, Moderator

Reception 5:30 - 7:00 p.m.
Swissotel, One Avenue de Lafayette, Boston

Agenda
FRA Symposium on Rail Vehicle Crashworthiness
Volpe National Transportation Systems Center
Cambridge, Massachusetts

----- **Tuesday, June 25, 1996** -----

Session IIa: Structural Crashworthiness - Design Considerations

Chair

*Dr. Herbert Weinstock, Chief
Structures and Dynamics Division
Volpe Center*

Co-Chair

*Kristine Severson
Structures and Dynamics Division
Volpe Center*

Structural Crashworthiness Design Practice 8:15 - 9:00 a.m.

Dr. Clifford A. Woodbury, 3", LTK Engineering Associates

Design Considerations for Rail Vehicle Crashworthiness 9:00 - 9:45 a.m.

Dr. Herbert Weinstock, Volpe Center

Break 9:45 - 10:00 a.m.

High Speed Rail Collision Safety 10:00 - 10:45 a.m.

Steven Kirkpatrick, SRI International

Crush-Zone Development 10:45 - 11:30 a.m.

Professor Roderick Smith, University of Sheffield

Lunch 11:30 - 1:00 p.m.

Session IIb: Structural Crashworthiness - New Trainset Designs

Chair

*Steven R. Ditmeyer, Director
Office of Research and Development
Federal Railroad Administration*

Co-Chair

*Frank Cihak
Chief Engineer
American Public Transit Association*

Structural Crashworthiness Overview 1:00 - 1:45 p.m.

John H. Lewis, British Rail Research

Crashworthiness of the TGV2N and the TER 1:45 - 3:15 p.m.

*Louis-Mane Cleon, Societe Nationale
des Chemin de Fer Frangais
Marc Villemien, GECAlsthom*

Break 3:15- 3:30 p.m.

*NEC Trainsets - Practical Considerations for the
Introduction of a Crash Energy Management System* 3:30 - 4:15 p.m.

*Frank Duschinsky, Bombardier, Inc.
Daniel Palardy, Bombardier, Inc.
Larry Kelterborn, LDKEngineering, Inc.*

Structural Crashworthiness Panel Discussion 4:15 - 5:15 p.m.

Dr. Herbert Weinstock, Volpe Center, Moderator

Agenda
FRA Symposium on Rail Vehicle Crashworthiness
Volpe National Transportation Systems Center
Cambridge, Massachusetts

----- **Wednesday, June 26, 1996** -----

Session IIc: Structural Crashworthiness - Locomotive Crashworthiness

<p>Chair <i>Dennis Ramm</i> <i>Chief Mechanical Officer</i> <i>Metra</i></p>	<p>Co-Chair <i>Dr. Tom Tsai</i> <i>Office of Research and Development</i> <i>Federal Railroad Administration</i></p>
--	--

<i>Locomotive Crashworthiness Research</i>	<i>8:15 - 9:00 a.m.</i>
<i>Dr. Ron Mayville, Arthur D. Little, Inc.</i>	

<i>Locomotive Crashworthiness: A Builders Perspective</i>	<i>9:00 - 9:45 a.m.</i>
<i>Harvey C. Boyd, Electro-Motive Division,</i> <i>General Motors Corporation</i>	

<i>Break</i>	<i>9:45 - 10:00 a.m.</i>
--------------	--------------------------

<i>GE Genesis Series Locomotives</i>	<i>10:00 - 10:45 a.m.</i>
<i>Al Bieber, General Electric, Transportation Division</i>	

<i>Structural Crashworthiness Panel Discussion</i>	<i>10:45 - 11:30 a.m.</i>
<i>Dr. Tom Tsai, Federal Railroad Administration, Moderator</i>	

<i>Lunch</i>	<i>11:30 - 1:00 p.m.</i>
--------------	--------------------------

<p>Chair <i>Tom Peacock</i> <i>Office of Safety Assurance and Compliance</i> <i>Federal Railroad Administration</i></p>	<p>Co-Chair <i>David Tyrell</i> <i>Structures and Dynamics Division</i> <i>Volpe Center</i></p>
---	---

<i>Interior Collision Environment</i>	<i>1:00 - 1:45 p.m.</i>
<i>Robert Galganski, CALSPAN Advanced Technology Center</i>	

<i>Testing and Analysis of Occupant Vehicle Collisions</i>	<i>1:45 - 2:30 p.m.</i>
<i>Dr. Michael Kleinberger, National Highway Traffic Safety Administration</i>	

<i>Occupant Restraint</i>	<i>2:30 - 3:15 p.m.</i>
<i>Steve Soltis, Federal Aviation Administration</i>	

<i>Break</i>	<i>3:15 - 3:30 p.m.</i>
--------------	-------------------------

<i>Passenger Response in Train Collisions</i>	<i>3:30 - 4:15 p.m.</i>
<i>Kristine Severson, Volpe Center</i>	

<i>Interior Crashworthiness Panel Discussion</i>	<i>4:15 - 5:00 p.m.</i>
<i>David Tyrell, Volpe Center, Moderator</i>	

Opening Session/Welcome/Introductory Remarks

DR. RICHARD R. JOHN: I'm Dr. Richard John, Director of the Volpe Center. I'll wait until everyone gets seated. On behalf of Dr. Sharma, Administrator of the Research and Special Programs Administration of DOT, I'm pleased to welcome you to the Volpe Center and the FRA-sponsored Symposium on Railroad Vehicle Crashworthiness. Since, some of you are visiting the Volpe Center for the first time, I thought I would use this opportunity to tell you a little about the Center.

Last October, we celebrated our 25th anniversary with a symposium on Challenges and Opportunities for Transportation in the 21st Century. We currently have more than 300 projects in progress, and annual volume of about 175 million dollars. Two-thirds of the Center's work is for the Department of Transportation, and one-third is for outside customers. More than one-half of our 500 Federal employees have advanced degrees, and our staff is augmented by about a thousand labor years, the private sector, and university expertise.

We're involved in supporting our clients, both in shaping the transportation system through safety and other initiatives, and then providing activities such as the Air Traffic Control System and military goods movement. Most recently, we have been involved with the Northeast Corridor Electrification and Environmental Impacts Statement, Application of Communication and Computer Technology to Grade Crossings, and most appropriately for this meeting, the Crashworthiness of High-Speed Trainsets. In Vice President Gore's National Performance Review vernacular, Volpe has become the model of a Federal entrepreneurial organization.

The Volpe Center is particularly pleased to host this symposium, because of the research related to collision safety and vehicle crashworthiness that we have worked on for the National Highway Traffic Safety Administration, The Federal Aviation Administration, the Urban Mass Transportation Administration, now FTA, as well as the Federal Railroad Administration. I recall in the 1970s, when I was the Chief of the Center's Mechanical Engineering Division, I was personally involved with work with FRA and UMTA in the development of projects related to collision safety of tanks, cars, locomotive and passenger equipment. Some of you can still remember those were the days of Miles Mitchell, who is here in the audience with us today; Ken Lawson; Carlos Villareal; Herb Richardson; and a speaker who will be joining us later, Steve Ditmeyer. I understand that many of the results of our research of that period have been incorporated into industry practice.

In January 1979, we were privileged to host a similar workshop which addressed the state-of-the-art of passenger rail crashworthiness at that time. I'm pleased to note that Frank Cihak, the Chief Engineer for the American Public Transit Association; Herb Gould, Deputy Director of our Office of Systems Engineering; George Neat, Chief of our Crashworthiness Division; and Herb Weinstock, Chief of our Structures and Dynamics Division, participated in the 1979 Symposium and are also here today.

I understand that the activities associated with the development of high-speed train sets and the expansion of computer rail operations have resulted in significant extensions of the state-of-the-art for controlling collision safety. This symposium brings together rail equipment crashworthiness researchers from around the world, including England, France, and the United

States, with manufacturers and operators, Amtrak, and commuter authorities. I'm personally looking forward to learning about the advances in the state-of-the-art of collision safety.

I also know that the subject of collision safety has been an exceptional strong interest to Dr. Sharma and to the Federal Railroad Administration, particularly Jolene Molitoris. They both planned to be with us today but were required to attend other matters. We are, however, pleased to have Mr. Steve Ditmeyer, Director of the Office of Research and Development of the Federal Railroad Administration with us to open this symposium and to describe these proceedings. Steve?

STEVE DITMEYER: Thank you, Dick. Good morning, everybody. On behalf of FRA Administrator Jolene Molitoris and Associate Administrator Jim McQueen, I'm pleased to welcome you all to this symposium today. The Administrator very much wanted to be here, but she got caught by a scheduling conflict. Today is also an annual meeting of the Brotherhood of Locomotive Engineers out in California. And there's a group that has obviously very strong interest in what we're going to be talking about here the next several days.

As you're probably aware, the Administrator has a very strong interest in the topics that we're going to be talking about here. She's been very active in the matters related to the specifications for crashworthiness of the new American Flyer Train sets for Amtrak. As she has said, she wants to make sure that these are the safest train sets manufactured anywhere in the world. Also, too, obviously, the recent accidents have been some matter of personal concern to her. So I do convey her personal greetings, and she wishes all of us the best for this meeting today.

The Volpe Center has been kind enough to sponsor this symposium on behalf of FRA's Office of Research and Development. We in the Office of Research and Development have two major programs that we carry on. One is to develop and demonstrate technology related to the safety of our national railroad freight and passenger system. Claire Orth is Division Chief that handles those activities. We also have another activity dealing with the advancement of technological innovation for high-speed passenger rail transportation, both safety and system performance. Bob McCown is the Division Chief responsible for this next-generation high-speed rail program.

Within these two programs, we conduct research on track, rolling stock, operations, human factors, hazardous materials, grade crossing safety, and signal and control technology. For our programs, we have a number of major customers. But probably the most significant one is FRA's own Office of Safety. And we support them with data for the development of improved regulations. But we have a variety of other customers for our work. They include the freight railroad industry, Amtrak, commuter railroads, rail labor, passengers, freight shippers, and the equipment manufacturers.

A fair portion of my work over the last decade-and-a-half has been involved in the field of accident prevention, working on advanced train control systems that offer the likelihood of reducing the probability of train collisions and over-speed accidents by perhaps as much as two orders of magnitude. However, it's clear that accidents such as the Chase, Maryland accident a decade ago, and the Secaucus and Silver Spring accidents in last February, remind us that accident mitigation is still a very important topic for all of us.

As Dr. John noted, the FRA conducted intensive research in the 1970s on the issues of freight railroad collision safety. The studies were carried out by FRA's office of R&D, and a lot of testing was done out at the Transportation Technology Center in Pueblo, Colorado. That work resulted in improvements in tank car head shields, shelf couplers, and improvements in locomotive cab design. These improvements were adopted by the freight railroad industry and incorporated into standards such as, for example, AAR's Specification S580, which deals with locomotive cab design. Also in the 1970s, the Federal Transit Administration, with support from the Volpe Center, did some work on passenger-car crashworthiness.

The renewed interest in this country in high-speed passenger trains during the last few years have caused us in FRA to re-evaluate areas of passenger-car collision safety. There were particular concerns that rolling stock that was being considered was designed abroad to different structural standards than those practiced in the U.S. The interest of Amtrak in acquiring higher-speed equipment for use in the Northeast Corridor has resulted in a concern for potential higher-speed type accidents that could result from shared rights-of-way.

The focus of this symposium is toward the exchange of information on research conducted by our organizations, on methodologies for evaluation of risks associated with passenger train collisions and the state-of-the-art of the technologies available for improving crashworthiness through structural design and the design of safe passenger compartment interiors. We expect that presentations in this symposium will show modern computer-aided analysis techniques along with modern materials and construction techniques that they hold potential for substantially increased rail equipment crashworthiness, with minimal weight penalties and manufacturing cost increases. However, it may require significant research and engineering costs to realize these potentials. Our studies have profited significantly from complementary research going on in other modal administrations within DOT. National Highway Traffic Safety Administration and FAA, to name two. We'd like to thank both of those organizations for their help and for their participation in this symposium.

We're going to have three sessions at this symposium. Session I being held today is going to deal with overall collision safety and methodologies for describing collision conditions that have to be survived for a particular train operation. The second session will be held in three parts. Tomorrow morning, we'll deal with crashworthiness design considerations. Part II, tomorrow afternoon, will deal with recent train designs. And Part III, on Wednesday morning, is going to cover locomotive crashworthiness. And then the third session for this symposium, on Wednesday afternoon, is going to deal with secondary collision, what happens to the passengers during a collision. We hope that this exchange of information will prove profitable to all of us and that it will help us to provide and assure transportation safety and provide a focus for our future research activities in this area.

I'd like to recognize a few people right now. Dr. Thomas Tsai is Program Manager within FRA's Office of Research and Development, and overall responsible for work in this area. Tom? And I'd also like to congratulate Herb Weinstock, the symposium Chair, and his committee members Dave Tyrell, Joseph Davin, and Deborah Duncan, for their fine work in coordinating this symposium for us.

Okay, thank you. And at this point, I'd like to turn the podium over to my good friend and colleague, Grady Cothen, who's the Deputy Associate Administrator for Safety Regulation. And he is clearly one of the most important customers of ours for these safety research activities.

GRADY COTHEN: Good morning, everyone, and thank you for committing your time and effort to participate in this symposium. Like Steve, I'd like to bring greetings to you from Administrator Molitoris and the officers and employees of the Federal Railroad Administration, who are pleased to sponsor this conference. The issue of safety of employees and passengers on the nation's rail system is obviously among the top priorities, not only of the Federal Railroad Administration, but of the U.S. Department of Transportation.

Our purpose here this week is to support public and private sector initiatives that are directed at the improvement of railroad safety, specifically including regulatory development, but certainly not limited to regulatory development. There are a number of events and confluence of factors that have brought us to this meeting. In 1992, the Congress enacted the Rail Safety Enforcement and Review Act, which called upon the Federal Railroad Administration to conduct a proceeding in the area of locomotive crashworthiness. A report flowing from the research that was initiated as the result of that statutory command is nearing release from the department. And a number of the products of that research will be discussed here this week.

Over the past several years, FRA has re-evaluated its position and approach to the issue of passenger rail safety. And as a result, in 1994, in September of that year, at a Rail summit in Washington, Secretary Peda announced that the Department would undertake a five-year program of standards development in the area of passenger train safety. Later in that year, just a couple of months later, the legislation was enacted, along with the Swift Rail Development Act, which was a re-authorization statute for our Railroad Safety program, and that statute codified a five-year timetable for passenger standards. That timetable includes a proposed rule-making this year and initial standards next.

Not incidentally, we are here because safety is the most fundamental level on which modes of transportation and transportation companies compete. I think we see increasingly that the tolerance of occupants of common-carriage vehicles for accidents and injury is very low. These are our customers. These are the people whom we serve every day as transportation companies, as public authorities that support passenger rail. And I think when one considers the calculus of costs and benefits associated with measures that we can take to prevent and mitigate rail accidents, that it's absolutely critical to take that factor into consideration.

In railroading, unlike some other forms of transportation, it normally is not possible, following a serious event, simply to put a company in reorganization, put a new logo on the transport vehicle, and continue business. In the rail industry, we have relatively stable transportation providers, fixed routes, large investments in fixed infrastructure. And it's very important for us to realize the benefit of those investors in the interests of a balanced transportation system. In order to do so, we must operate safely.

Part of the Federal Railroad Administration's calculation in terms of determining that we should be in the more active business of passenger rail safety with a more comprehensive regulatory program had to do with the growth of commuter rail in the United States, in areas where it's

previously not been provided. The unbundling of the services related to commuter rail, so that very often sponsors of commuter rail service have not been from the same institutions that historically have managed commuter rail. The promise of new high-speed rail starts on 10/10 corridors and elsewhere in the United States. Amtrak's plans for enhanced high-speed service on the Northeast corridor. And of course, occasional and very serious accidents that have brought to our attention the need for additional countermeasures and mitigating strategies, including National Transportation Safety Board recommendations.

I want to emphasize that members of the National Transportation Safety Board and staff certainly have been encouraged to participate in this activity. However, as a result of conflict in preparation for a major public hearing in Silver Spring later this week, we've not had the same sort of participation that we had definitely expected to have.

Obviously, reinforcing all of our concerns were two accidents that occurred this past February, involving push-pull operations with control cab forward. These accidents followed a January 1993 cornering collision of two MU trains on the Northern Indiana Commuter Transit district, in Gary, Indiana, and these issues continue to pose to us the issue of how we better protect passengers in that configuration of operation.

Let me talk for just a moment about context. I think that the general response that we have received to the issue of rail vehicle crashworthiness over the years has been an immediate reaction: you're asking the wrong question. And I think that very often it's been suggested that the first question that should be asked is, "How do we prevent these accidents from occurring?" Let me say as a matter of context for this discussion that we agree wholeheartedly with that proposition, that that's the first question that we should be asking. And I believe Steve refers to the fact that the agency's separately working on issues related to accident prevention, particularly the promotion of positive train control systems and allied technologies. We are continuing to do that very aggressively in partnership with freight railroads, Amtrak, and other partners, including states.

However, I think it's necessary to note that investments to realize the benefits of those technologies are, to the largest extent, not in business plans at this point. There are not commitments at this point to make those investments. And until there are commitments to make those investments, we need to be urgently concerned about the issues that we face here, and even then residual risks will exist that need to be accounted for and that will be a part of the discussion today.

Obviously, we start with a system on a passenger-mile basis that's extremely safe. However, there's no reason we cannot do better. It's certain that we can do better. We should not have to be competing with trucks who operate in a joint use environment with a very difficult situation in terms of other motorists on the road, year after year, for the best spot in the competition on a passenger-mile basis for land transport. We should far exceed that record based upon the availability of a single-use right-of-way; albeit, with mixed freight and passenger service.

Obviously, we're going to have to contend as the years go on, with highway rail grade crossings. Undersecretary Peña, the Department of Transportation, under an action plan, has committed to addressing highway rail crossings on a corridor basis, to seeking elimination of as many redundant and high-risk crossings as we can. But when we start from a base of 167,000 public

crossings and 110,000 private crossings, it's a daunting task, and not one that is easily addressed when you address it over time. We hope to continue to drive down accidents, fatalities and injuries at crossings, even as train miles increase and vehicle counts increase. Nevertheless, heavy motor vehicles will continue to find themselves on these crossings at times inconvenient to the rail movements competing with them for that same piece of real estate.

We have to be increasingly cognizant of the fact that vandalism and other deliberate threats to safety will continue to impact our society and users of all its services and facilities. We also have to keep in mind the fact that adjacent property owners may engage in activities that may create risk. Obviously, we know that where we have passenger and freight operations together on the same right-of-way, that we have residual problems of interfering freight traffic, even with the most secure PTC systems that we can currently envision, including the dangers of foul weather derailments and side collisions at switches. Terminal operations, it's been noted, and I'm sure Dr. Bing will comment, will remain congested; this presents an additional source of risk.

So what's our challenge this week? Well, I would suggest to you that our challenge is to first shake off complacency. If we do nothing, things will not stay the same. Things will get worse because other factors in the environment are changing. The extent to which rail vehicle crashworthiness needs to contribute should be and is an active subject of debate. And we certainly should not be complacent about the issues. I hope that we will come into this discussion with open minds, both about what is possible and practicable, and also a sense of realism about the engineering work, the research and development that needs to be done before we can implement additional mitigating measures.

I hope that we will commit to relentlessly pursuing cost-effective solutions, and Federal Railroad Administration is certainly prepared, and I assume we are all prepared, to be flexible in implementing solutions so that safety and operational reality and customer expectations can all be taken into account.

Thanks very much to our colleagues from the Office of Research and Development, the Volpe Center, and other Department of Transportation elements that are contributing to this conference this week. We're constantly in your debt, as users of your research, and we appreciate it very much.

You may be somewhat relieved at this point to know that you've heard the last from the regulators until we've had a chance to share with you in discussion later today. At this time, it's my pleasure to introduce the first of our speakers for the morning. Dr. Alan J. Bing is Principal Investigator and Senior Consultant with Arthur D. Little's Technology and Product Development Directorate. Dr. Bing has over 25 years' experience in transportation systems. From a background in railroad track and rolling stock engineering, Dr. Bing has expanded his interests to embrace many aspects of the operations, management, and technology of transportation systems, with emphasis on railroads, transit systems, and related supply and service industries. Dr. Bing holds a Bachelor of Science and Ph.D degrees in Mechanical Engineering from Nottingham University in England; his doctoral research was in the field of Railway Pneumatic Brake Systems, but we will not kid him about this, this morning, because he's a very esteemed colleague. And Dr. Bing, if you would please come forward at this time.

Methodology/Approach

DR. ALAN BING: Well, good morning everybody. It's my role to kick off the research and technically oriented part of this symposium. I'm not sure why they selected me. Maybe they think the odd accent might keep you a little more awake early on a Monday morning than otherwise. Maybe because in my research over a number of years in this subject on rail safety, I have been something more of a big picture guy looking at the overall view of everything, rather than focusing on one little aspect.

So what I'm going to try to do is set the scene, the overall picture of rail safety, primarily in the United States, and try to show where crashworthiness issues and where crashworthiness research and understanding the benefits of improved crashworthiness can fit into the big picture. I can assure you that it has a major and very important role.

I'm going to look a little bit at different kinds of rail accidents that occur out there, what causes them, what the consequences are and particularly try and highlight the severity of collision accidents and the major impact that collision accidents can have on casualties in rail accidents in general.

Right at the end I'm going to try and talk a little bit about how good do we have to be. What is the present overall performance from a safety point of view in the rail industry and is this good enough. Grady referred to the fact that the public is entitled to expect a high level of safety in a public transportation mode, and I'm going to try to emphasize what that level maybe ought to be.

Most of what I'm going to say has been culled in one way or another from a bunch of previous pieces of research and studies that myself and my colleagues have performed. I'm afraid that this slide is not in the package that got distributed in the books. That lists various studies that we at Arthur D. Little have done for the Federal Railroad Administration and for some individual clients including an effort for Amtrak and John Bell on the Northeast Corridor. I should also try to precede this a bit with an Alan Bing credibility warning. I am going to quote some numbers for accident rates and casualty rates. They are drawn from a variety of data samples from different time periods and to some extent done for different projects under different goals. So these are indicative numbers indicating the approximate level of risk and they are not to be taken very literally if you like. Someone else performing the same study with a slightly different data set will probably arrive at a slightly different number but I think it's unlikely to affect, as I said, the big picture.

An overview of what leads to casualties. I think I've got four boxes there that contribute to the end effect of people getting hurt or killed in rail accidents. The first one is what are you being exposed to? This is quite important when considering the risks that apply to a specific route or a specific type of operation. A route without any grade crossings, or very few grade crossings, like the Northeast Corridor, grade crossing accidents are not a big deal. Go somewhere else where there are a lot of grade crossings and obviously it becomes an important issue. Likewise, I'm thinking increasingly becoming aware that traffic density on the railroad is an important factor particularly in collisions. The higher the density, the more opportunities there are for something to go wrong and an accident to result. Alternatively, if something does go wrong, there's more

chance that will lead to an accident than on a low density route. The likelihood of the accident is associated with the likelihood of something going wrong, sort of error that leads to a collision, a failure of a piece of the track or rolling stock that leads to the derailment. Those kinds of events are usually measured on the basis of an event for so many train-miles or car-miles.

The severity of an accident is the element with which crashworthiness is concerned. If there is an accident, how severe is it particularly from the point of view of causing casualties. Finally, I think Stephanie Markos is very concerned with here, how good after an accident is the emergency response? Is there a good means of escape from damaged vehicles? If there a good emergency response on the part of fire, police departments and so on, the severity of casualties can often be mitigated. The last step in this picture of the factors that contribute to overall safety performance.

What tools have we got for searching and examining all this? There are a variety of tools and I think I don't want to dwell on this too much today, which tend to go from tools that are aimed at identifying accident causes and accident scenarios to those at the bottom which are concerned with putting a number on the accident likelihood or the accident risk. Mostly what I have done myself in rail vehicle accidents, railroad accidents, is to do a quantitative analysis. Fortunately we do have quite substantial databases of past accidents which give us the opportunity to put some numbers on accident likelihood and the severity of consequences.

If you are dealing with a situation where you do not have that luxury, for example looking at a new form of maglev system where there is no history to go on, the more qualitative methods are really all you have. Something like preliminary hazard analysis which ranks risks as high, medium, and low and consequences as high, medium, and low are a good way to go.

Reverting to the rail vehicle, conventional railroad accidents, most investigators, and certainly ourselves, identify four main groups of accidents: collisions between trains on the same track, and again that particular form of accident has been the focus of I guess the bulk of crashworthiness research; straightforward derailments where trains leave the track. There's no other train involved, usually caused by the failure of either the rolling stock or the track although there are other reasons. An overspeed accident in a curve, for example, through a turnout would be another example. Collisions with obstructions which I usually define when I analyze these things as anything other than another train on the same track. It can include vehicles not left in the clear; shifted loads on a train on an adjacent track; the wreckage from another accident, and again as traffic densities increase, the chances that an initial accident where the collision or derailment could be followed by another accident, second train running into the first train that was derailed, do increase quite significantly. Some of the very high density routes where 300 or 400 trains a day, that is starting to become certainly a potential risk there in high density commuter rail operations for example. Also, that category includes things like debris placed on the track by vandals and so forth. Finally, the rail highway collision which Grady mentioned. The one or two kinds that I haven't considered in this discussion that are out there, fires and explosions are one, particularly those associated with hazardous materials, are an important cause of accidents but are not included in my discussion today.

It's also, getting back to the issue of traffic density, somewhat aware that there are a whole bunch of different operating environments out there which can range from high density passenger

corridors, like the Northeast Corridor probably the best example, through various mixes of traffic density and traffic types. Each one of these results in a somewhat distinct set of accident threats. From the point of view of the operator looking at an individual corridor, it's important to understand where you are on this map and what particular kinds of risks might be present in your corridor or your route. From the point of view of a rolling stock manufacturer who probably only wants to make one design of rolling stock that has pretty broad application, then a piece of equipment probably has to deal with all the different operating environments it might encounter when sold to the different customers. It's certainly important not to just think in terms of one or two of these but to think of the overall picture.

Now I'll talk in a little bit more detail about the quantitative analysis we've done of rail safety and risks. There really are two kinds. I kind of divide them in my head to the macro and micro kinds of analysis. On the macro level we're probably looking at either the whole country or the performance associated with a particular kind of rail service whether it's freight railroading, commuter rail, intercity rail, something like that. The micro analyses tend to involve looking at a particular route. The detailed study that we did for Amtrak of Boston to New York on the Northeast Corridor, looking at accident risks whether they were acceptable or not and what you had to do to essentially bring them down into the acceptable range would be a good example of a microstudy.

The process for looking at what I might call a macro study system-wide analyses is illustrated in this picture. I'll point to a few of the boxes. The first steps involve defining what we're analyzing and identifying the accident scenarios, usually the four I've mentioned previously but maybe others as well or maybe subdivisions of those scenarios. Use historic data, data we have from the Federal Railroad Administration and other sources, to calculate the historic accident risk for that kind of service. Very often the historic operating conditions are not the ones you particularly want to be informed about. You're looking at a service definition that differs from an historic experience in some way. At this point things get a little less well-defined, maybe a little more flaky, but you have to identify the differences from historic experience and make a shot at estimating what influence that has on each of these accident scenarios, the likelihood that accidents will occur and the severity of those accidents. This is where analysis like that of crashworthiness becomes very valuable because it enables me as a system safety analyzer to look at and say well if we improve crashworthiness by making these modifications, then this is how much better things will get. Without that information I'm stuck, I can't tell you how good things will be or how bad things will be overall. So with that information, the best we can get, we estimate the safety performance of the desired system.

The approach in a microanalysis is really very similar with probably the major variation that we look at a route, say the Northeast Corridor, divide it up into segments that have roughly constant train speed, traffic mix characteristics, and work out the accident performance for each of those segments and add them up to get the overall corridor safety performance. It's rather tedious but fortunately one can use a spreadsheet on the computer to do the analysis for you. Here's a diagram of it. I don't want to dwell on it too much on how one might start a spreadsheet program to calculate the risk on a given corridor or route. You can bring in to this analysis runs with different equipment types, having different crashworthiness performance, look at the effects of increasing speed on selected segments, changing traffic density and a bunch of other things.

When we did it for the Northeast Corridor it proved to be quite a powerful way of analyzing accident performance and safety performance.

One point that actually came up in the Northeast Corridor analysis is the question of in collisions what the risk was of collisions between locomotives and locomotives, locomotives and cab cars, cab cars and cab cars. That proved to be a little complicated to work out because for example in the Boston area, all the commuter trains operate with a locomotive out of South Station at the south end of the train or the west end of the train. That guarantees that when two commuter trains are involved, a collision between cab car and a locomotive, you cannot get locomotive to locomotive or cab car to cab car. So in terms of exposure to risk, it is quite important to look at how the individual operators run their service. It's not necessarily a random mix of collision.

We also in that particular calculation the same would be true of any other. In a busy commuter corridor, we looked at weekend traffic separately from weekday traffic and looked at the effects of different levels of crashworthiness improvement of the passenger equipment, without in our study getting involved with how that crashworthiness would be achieved. We just assumed if you could make it this much better, what impact would it have on overall safety performance.

Now to go on to some specific figures for collisions, derailments and other forms of accidents. What I've done is looked back at all the work we've done in recent years and kind of amalgamated it, expressing accident likelihood in fairly round numbers. As I said before because we've looked at different historical time periods and performed analyses in different ways, all these things are not strictly comparable but I think they tell an interesting story so I'd like to show the results and talk about them a little bit.

The first thing I looked at was collision likelihood or more exactly the likelihood of any individual train being involved in a collision, bearing in mind that collisions usually involve two trains. I looked at three of the six or so operating environments that I mentioned earlier, high density passenger corridors and passenger trains, mostly intercity trains on freight corridors or freight railroads, and freight-only operations. The interesting thing to me and Frank is that the risk of collision is not in fact terribly different on those three forms of operation, although the traffic densities and the kinds of signals that are in place are distinctly different. I formed the conclusion that in fact traffic density does play a significant role, certainly in collision risk and it's something maybe that we have not focused on a whole lot in the past and could be subject worthy of more thorough study in the future. The other point, and I think Grady has already given me a trailer about this in his remarks, that on the high density passenger corridor which is actually the Northeast Corridor, a significant fraction of the accidents, collision accidents, are in fact, occur in major stations and terminals. There's a lot of complex train movements in such terminals. The degree of protection offered by the signal system is somewhat less and that leads to quite a large number of mostly minor accidents. I do think it's a mistake to expect them all to be minor because trains are moving around in the presence of major fixed structures and I think in at least one instance a train succeeded in hitting a structural member and becoming quite severely damaged even though it wasn't moving very fast. So that point is something to be aware of and I would strongly recommend that in accident studies to separate out those that are low speed, tend to occur in terminals, and tend to have somewhat unique hazards from the ones that occur doing normal operations over the road as it were.

There's not a whole lot to say about the passenger trains on freight railroads. In fact the accident performance is a little bit worse but not a whole lot worse than the corridor and slightly different in single systems. Likewise the freight railroad accident is somewhat worse again, but not dramatically bad I would say.

The other important point about collisions is that they are responsible for the lion's share of casualties. This diagram shows the breakdown of all accidents other than grade crossing accidents. These are collisions, derailments and some of the other category of collisions with obstructions on the track. Most of the accidents are derailments or other collisions, and this is passenger trains on freight railroads. But collisions cause most of the fatalities and about half the casualties. So it's very clear that even though collisions are relatively few in number, and again allowing some room for error in these numbers, collisions are the thing that causes the casualties. So a study of crashworthiness and ways to improve it are richly warranted by the experience in operation.

You see almost exactly the same picture on the Northeast Corridor where a rather larger proportion of collisions, 10% instead of 5%, I think related to traffic density but again responsible for virtually all the casualties. Finally, going to freight operations. Again, I think it's probably very well known, collisions are a relatively small fraction of the total accidents, but they are responsible for a significant part of the casualties to train crew members on trains. Near as I could do it, these casualty figures are for train crew and not people who are otherwise involved whether railroad employees or not.

Now since none of those figures contained grade crossing accidents, I've taken a look at grade crossings separately. I think there is a mistake in the handout in your books which omitted the definition of the quantity in this table. It is accidents, that is grade crossing collisions with road vehicles, per million crossing passage. That is for each million times a train crosses over a public grade crossing. I've not looked at private ones. There are very strong differences interestingly between the risk in different kind of operation. High density passenger corridor seems to have relatively low grade crossing accident risk. That is simply a function of the kinds of crossings that are out there. They tend to be relatively low highway traffic and are kind of equipped with more than their fair share of warning systems compared with national practice. Moving to passenger trains on freight railroads, the picture is distinctly gloomier. There really is quite a high risk and that kind of makes logical sense. The trains are going faster. They give the road user less warning that they're approaching, and there's a good deal more likelihood of an accident occurring than on a dedicated freight corridor.

Whenever you milk a grade crossing accident along with all the others, they do perform quite an important part of the risk. They're a very large fraction of total collision type accidents and they also lead to somewhere around 10% of total passenger casualties, mostly injuries. There are very few occasions where a collision on a grade crossing causes a fatality on a passenger train, but it does occur sometimes.

The other thing thinking of passenger trains and grade crossing accidents is the faster you go, the worse it is for the road user. Clearly, passenger trains are breaking 80, 90 miles an hour. Getting into a grade crossing collision almost certain to cause a fatality for the occupants of the road vehicle.

Just a few more points about grade crossings, again my role as the big picture person. I think most of these points are well known. The road user is the cause. There are quite a number of accidents out there of grounded vehicles on humped crossings, particularly the kind that move construction machinery around and so on, and that obviously points to one of the ways of reducing the risk of grade crossing accidents is making sure the surface is reasonably good.

The other one that has a lot of prominence recently, two very bad accidents where road vehicles have become trapped on grade crossings by traffic congestion, a school bus in the Chicago area and a gasoline tanker I think near Ft. Lauderdale in Florida. Both were involved in serious grade crossing accidents. That is also clearly I would think something that something can be done about, particularly on making local government authorities aware of these kinds of risks and getting them to manage their highway features to try and minimize the risk of that happening. In fact there's one not far from here that I cross on occasion in West Medford where there is a grade crossing that has road junctions either side of it, a fairly aggressive school crossing lady who holds up the traffic every time a kid wants to cross the road. Traffic is very frequently backed up across that crossing. There is a flagman and the trains are moving slowly because there's an adjacent station, but I still have nightmares that one day there'll be a non-stop train and it won't stop.

The last subject I want to make a few remarks about is how good do we have to be? This is of course a very thorny subject and I'm not sure certainly what I have to say is a long way from the last word on it, but I think it might perhaps at least provoke a little discussion. When I thought about this before, and most of this thinking was in the context of a Volpe Center project that David Tyrell managed on collision avoidance and accident survivability, we did ask this question, what should be the target? How good do we have to be? We came down to really three or four different perspectives with which you have to look at this. You cannot look at it with just one perspective, say casualties per passenger mile. You have to look at it from a several points of view.

The first one is what the public in general will accept whether they are rail travelers or not. We have certainly seen this criteria of work in this year both with rail accidents and aviation safety as a result of the Valu-Jet tragedy. There is a sort of societal tolerance of accidents which is related really how many occur in a year, somewhat unrelated to how many train miles are operated or flights or whatever. It's kind of more an absolute thing. If the public's perception is that accidents have exceeded this comfort level than there will be pressure for more severe regulation, better oversight of industry and so forth. There is I think a way of finding out where that comfort threshold sits, simply from empirical observation.

The second sort of group if you like that have a stake in this issue are employees of railroads whether freight railroads or passenger railroads. From their point of view it's a question of occupational safety. It's the risk of working on the railroad reasonable relative to other comparable occupations. The third point of view is the obvious one, the one that probably gets the most attention, and is that perspective of the passenger. Am I as a traveler being subject to an unreasonable risk or not? Finally, the question of grade crossing accidents where probably the perspective should be that of the operator of a motor vehicle and the risks that they accept by going out there on the highway in Boston or elsewhere. Again, that's a different perspective on risk. You tend to get different comfort levels and results.

Just to illustrate the way of dealing with the first one of those, the societal risk. We found, and this is not just looking at rail accidents and looking at things like accidents in manufacturing plants, aviation, nuclear power plants, whatever, that there is a boundary of acceptability that looks something like that. It's on a scale of a number of severe events per year against the severity of the individual event. The worse the individual event are, the lower the threshold of comfort. In previous studies of this or efforts, I've been very uncomfortable with this events per year. It's got to be related to how many train miles are operated or landings and takeoffs or whatever, but in fact I think that's not how the public perception work. Public perception is all to do with "my goodness you've had three accidents in a month. Something must be wrong." Completed unrelated to how busy the railroad or the aviation industry happens to be.

I think it's also an illustration of how this has worked over many years and if you look at the long term history of either aviation or highway history; in fact, the number of severe accidents in a year tends to stay more or less constant with a number of ups and downs, even though the activity in those two areas, automobile travel and air travel, has gone up very steeply over the last 20 or 30 years. Every time there is an increment in travel, more accidents result and there's a public outcry it's not safe enough, and something gets done, new standards or oversight is introduced. So I think that would be another, in fact, area that would be very interesting to look at, to see how that has worked out over time. I think that's the effect at work.

The point of view to do with the other areas that I mentioned, occupational safety and safety accepted by operators of travelers. You can see from those figures the railroad, and this is all employees of the railroad lumped in together. I haven't tried to separate out train crew from other occupations on the railroad. Tends to be quite a bit worse than manufacturing and occupational risk in general. I think this perhaps explains why railroad employees are somewhat concerned about this issue, the safety in performing their daily work. It's nothing like as bad as some notable high risk occupations such as construction, commercial fishing, mining, farming, all of which are up in the 30-40 fatalities per 100,000 employees per year.

From the point of view of passenger safety expressed in terms of risk per passenger kilometer or billion passenger kilometers, air travel, in spite of recent events, comes out to be very safe indeed. Rail travel is also pretty safe, and this number does jump around from year to year because it's a product of a small number of severe accidents, but generally seems to sit at about this level for a number of years. What people accept when they're driving around in automobiles is at least ten times as worse. Far more risky driving your car. Again, people that set this obviously because they feel they have a degree of control about what's going on. I'm not going to suggest any targets we ought to be aiming at but that does give an idea of where rail sits in the bigger picture and might give some ideas on where it ought to fit.

Finally, just to sum up, what I've described, both the methodologies and the broad data I have presented does indicate more or less how well the rail industry is doing. It places the risks in some perspective relative to other risks out there in society, and particularly when doing quantitative analyses, it does help very much perform this tradeoff between prevention of accidents and mitigation of their consequences. It does show that we're a long way from successfully preventing collision accidents. I certainly endorse Grady's remarks that maybe there's a holy grail out there of total prevention. We're a long way from getting there and we're

not going to get there for at least the life cycle of a new rail vehicle being built today, so crashworthiness matters.

There are some limitations on data with which to perform these analyses. The two I most commonly encounter is estimating how much better things will get as a result of the change and all the crashworthiness analysis clearly contributes greatly to helping that one. The other for which I've yet to find a good way around, is that you often do not have good information on the exposure to risk. How many train miles are operated across a given track class with a given kind of signal system is data that is simply not collected in the industry and is not available. You've got the numerator of the risk, how many accidents have occurred under those circumstances, but you have no idea how many train miles or car miles were operated to produce that accident rate. So that is another difficulty and you have to resort to making a bunch of estimates.

I sincerely look forward to the rest of the seminar and learning about how to understand collision rate. Thank you very much.

GRADY COTHEN: We do have some time in the schedule if you would consent to take questions.

AUDIENCE ATTENDEE: Do you have copies of your presentation to hand out?

DR. ALAN BING: They aren't in the book?

GRADY COTHEN: Let me answer that question. They're being copied right now and hopefully they'll be here tomorrow.

DR. ALAN BING: I should explain that I was one of David's delinquents who didn't get the hard copy in early enough, but it's available.

GRADY COTHEN: Come now, you were offered coffee earlier. That was a very provocative presentation and you must have questions, please. Steve.

STEVE: The statistics that you showed were U.S.

DR. ALAN BING: Yes, yes.

STEVE: Have you looked at any other foreign statistics and do you have any sense to which they validate these or to what extent they might vary?

DR. ALAN BING: The particular foreign one I've looked at is the passenger risk in terms of fatalities per billion passenger miles. European railways fall right in the same band as U.S. railroads, but the mix of accidents tends to be a little bit different. I think frankly they have a good deal more collisions. Much higher density operations and collision risk and running past signals and that sort of thing tends to be a high profile for them, and derailments are less common because most of the systems are heavy use passenger lines which are maintained to a

fairly high standard. It's based on rather sketchy information. I have not done an in-depth study of foreign experience.

The other one I did is trying to get a little bit of a handle on, it comes to this exposure issue again with the much quoted performance of the various high-speed rail systems in France and Japan and how they have not had a passenger fatality. When you look at France, the total cumulative passenger kilometers are of the order of now probably two or three hundred billion passenger kilometers which indicates they are significantly better than rail in general. In Japan, I think it's a trillion passage kilometers at least without a fatality. So those systems are performing at a higher standard by quite a high margin than conventional rail operators.

GRADY COTHEN: If I could ask Frank, could you come to the floor mike please? We are taking a tape of the proceedings so if questioners would state their names, that would help us get a full record.

FRANK CIHAK: American Public Transit Association. Alan, you had a great number of very provocative illustrations there and it's unfortunate that we couldn't interrupt you while it was going on because there was so much material going by here so fast, I was trying to figure out how to write down fast enough the questions. But the particular illustration that was put together to illustrate when people become concerned about safety which had the instruments on the left side and the severity I guess expressed in fatalities along the bottom. If that's the curve of perception or the illustration of perception, based on your experience in doing all the work you've done over the years, where does this tell you to put your safety dollars? Which part of that do you think is best to attack?

DR. ALAN BING: I think it's the very rare but severe accident. This end of the spectrum. The ones at this end do not get a lot of public attention. The ones up here, certainly those that might cause more than ten fatalities or thereabouts, are those that create a tremendous amount of attention, pressure for regulatory change, hearings in Congress and so on, and have the risk attendant to them of ill-considered actions being taken in the heat of the fuss. If the industry can somehow get out ahead of those and make sure they don't happen.

FRANK CIHAK: Automobiles are on the left side?

DR. ALAN BING: Automobiles are way down here because they're so individually small.

FRANK CIHAK: Passenger rail is somewhere under the 10 range, right?

DR. ALAN BING: Passenger rail is usually here. Aviation up here. Interestingly you get a slightly different shape for aviation accidents than you do for rail and that is because people somehow accept that if a plane goes down, it will kill all or most of the occupants.

FRANK CIHAK: Tends to be a problem.

PROFESSOR RODERICK SMITH: This question of international comparison of accident statistics which I'm particularly interested in. This overhead may be of interest to you. It's a

summary of rail accidents this century up to '89 with 20 or more deaths of so major accidents in the following countries.

I'm sure more accidents have occurred particularly in some countries that haven't been reported. The U.S. is a very open society with information, an average about one major accident a year this century. Same's true of India. Lots of passenger kilometers in India and I would think fairly accurate reporting of accidents. Probably the same true of France, Germany, U.K. Probably more accidents have occurred in Russia that haven't been reported. China doesn't figure on this statistic. It's not competing in this particular Olympics. But quite interesting, the figures aren't wildly different. In terms of societal perception of risk, this sort of average of one accident a year or half an accident a year over a wide range of countries is fairly interesting I think. But I think if we take modern statistics, there's a lot to be made from a comparison of equipment and attitudes in different countries. I'm convinced that the accident figures in Japan are an order of magnitude at least say than for any other country. It's not to do with equipment; it's to do with people and the attitude to running the system. The figures for the Shinkansen are just the tip of the iceberg.

In terms of our personal risk per year to various exposures of transport, I calculated some figures taken from U.K. accident statistics and taking an average year's exposure to various types of transport. I took that fairly lazy person who walks 500 kilometers a year, commutes by train 40 kilometers per working day (so clearly not an American), travels by car approximately 20,000 kilometers a year, takes two long air journeys a year totaling 50,000 kilometers and tries to keep fit by cycling 50 kilometers a week. So it's a mix of activities which is not unreasonable. In this typical year's exposure to travel modes, the likely death rates are taking one for the train, 7.5 times more likely by air, 16 times more likely by car, 21 times more likely by cycle, and 5.4 times more likely by foot. So those are quite interesting figures because of the perception people have of the utility of the mode of transport they're in. They'll jump into the cars and discount the fact that they're more dangerous because of the extra use they give. But if you attempt to keep fit by cycling, don't.

DR. ALAN BING: I think I might add one comment if I may. The U.S. has not really had one major passenger rail accident annually in recent years. I think that is somewhat fated by the early years of this century. In recent years it's been more like one every five years or so that have been serious multiple fatalities, like Chase, Maryland, like the accident off the bridge in Alabama where a train went over a damaged bridge that collapsed which resulted in a derailment in which a large number of people were drowned in that circumstance. That's the most serious one in the recent last few years. Any more?

GRADY COTHEN: Yes, Dr. Bing, you're not off the hook yet. Mr. Bell?

JOHN BELL: I'm John Bell. I'm with Amtrak. I have a couple of questions. In one of your early slides you indicated that speed was a factor in the likelihood of an accident or occurrence rather than disparity. Could you describe where that's coming from? Does it have to do with track forces and that kind of thing? Where does that part of speed come into play.

DR. ALAN BING: It's one that I suspect is there but it's kind of hard to get a good handle on. I do think that as speed goes up there is some slight increase in risk if other things stay equal. What makes it difficult of course is that usually for high speed the track quality is different and

the kind of vehicles you're using change so it's hard to get a handle on. It's not a very strong effect.

JOHN BELL: Second one, your comparison of three types of rail operations. The passenger service included operation of stations. Your freight service did not include services and yards, and I think if you work that factor in or take the factor out for passenger service, you'll see a much larger disparity reflected in intensity of inspection and performance. I think you overstated the similarities between the types of rail service. Lastly, if load trucks are a problem, why aren't they better regulated or eliminated? Is there a problem on the other side of the building?

DR. ALAN BING: Thank you John. That last comment, as far as I know there's no regulation about the underclearance of road vehicles. Maybe there is but I'm not aware of it. On the question of yards and so forth, that's probably true and it's an artifact of the way the statistics are partitioned. There are passenger accidents in yards, but they generally mean maintenance facilities and that kind of thing and passenger stations count as main track. I agree there are a lot of freight accidents in yards, a very large number, but we should look at the bigger picture.

GRADY COTHEN: Any other questions for Dr. Bing.

DR. ALAN BING: Thank you, Grady.

GRADY COTHEN: What did he say, "It's an artifact of the manner in which the data are partitioned? Is that what he said?"

DR. ALAN BING: I partitioned it.

GRADY COTHEN: Next time we're accused of polishing up our numbers, that's the phrase I'm going to use. Very helpful kickoff here. We appreciate that. Let me just interlineate here a point or two about where we are at the Federal Railroad Administration with regard to regulation since I think it's going to come up and I forgot to do it.

We spent a good deal of time, much to John Bell's chagrin, but ultimately to all our collective satisfaction, working with Amtrak on high-speed train sets in the period of 1994 for ultimately playing a role in the announcement of the procurement in this past March. In the course of that activity, we marshalled a lot of resources including resources from the Volpe Center to address safety standards for high-speed equipment to 150 miles per hour and mixed use right-of-way. That gave us a good foundation and we moved into the regulatory activity on passenger equipment safety standards that I mentioned earlier as mandated by this legislation and acted as part of the Swift Rail Development Act in 1994.

On June 10, just a few days ago, we published an advanced notice of proposed rulemaking on passenger equipment safety standards. That document is very much out of phase. It was drafted a good number of months ago, but it's intended to let everyone know what we are doing within the passenger equipment safety standards working group which has broad participation from the passenger rail community, employees, railroads and suppliers. We hope to have a notice of proposed rulemaking on that issue for initial standards this November and we're working very diligently with that group to come to agreement on core standards. Over the next few weeks we

will publish a notice of proposed rulemaking on emergency preparedness for passenger rail service supported by the Volpe Center which produced an excellent set of emergency preparedness guidelines that was a starting point for the work of the group, and a resource I'm sure that will be consulted very frequently over the coming years. Then we will conclude that rulemaking as expeditiously as we can likely, I would think being realistic, early next year.

A key player in the FRA staff on these issues is Mr. Thomas Peacock who is our next presenter. Tom received his Bachelor of Science degree in Mechanical Engineering from the University of Maryland and Master of Science degrees, two of them, one in Mechanical Engineering, University of Maryland, the other in Technical Management at Johns Hopkins University. Tom has 20 years of experience with the United States Navy including program manager for major weapon system research and development projects, a director of the Navy's premier nuclear weapons effects test facility. For the past four years, we've been fortunate enough to have Tom work with us at the Federal Railroad Administration, Office of Safety, where he's been responsible for passenger equipment and high speed rail technical issues that impact safety, among other duties as assigned I might add. It gives me a great deal of pleasure to introduce Thomas Peacock to you.

PRESENTATION

METHODOLOGY/APPROACH

**An Approach to Evaluating
Railroad Accident Risks**

Presentation to:
Symposium on Rail Vehicle
Crashworthiness
Volpe National
Transportation Systems
Center
June 24-26, 1996

Arthur D. Little, Inc.
Acorn Park
Cambridge, Massachusetts
02140-2390
(617) 498-5000
Reference 92057-02

Methodology Overview

This presentation discusses methodologies for analyzing railroad accident risks, from which the need for and benefits from improving vehicle crashworthiness can be derived.

- Analysis Methodology Options
- Likelihood of Accidents of Different Types
- Characteristics of Accidents of Different Types
- Typical Accident Consequences
- Railroad Safety Performance Targets

The focus of this discussion is a North American freight, and conventional and higher speed passenger operation.

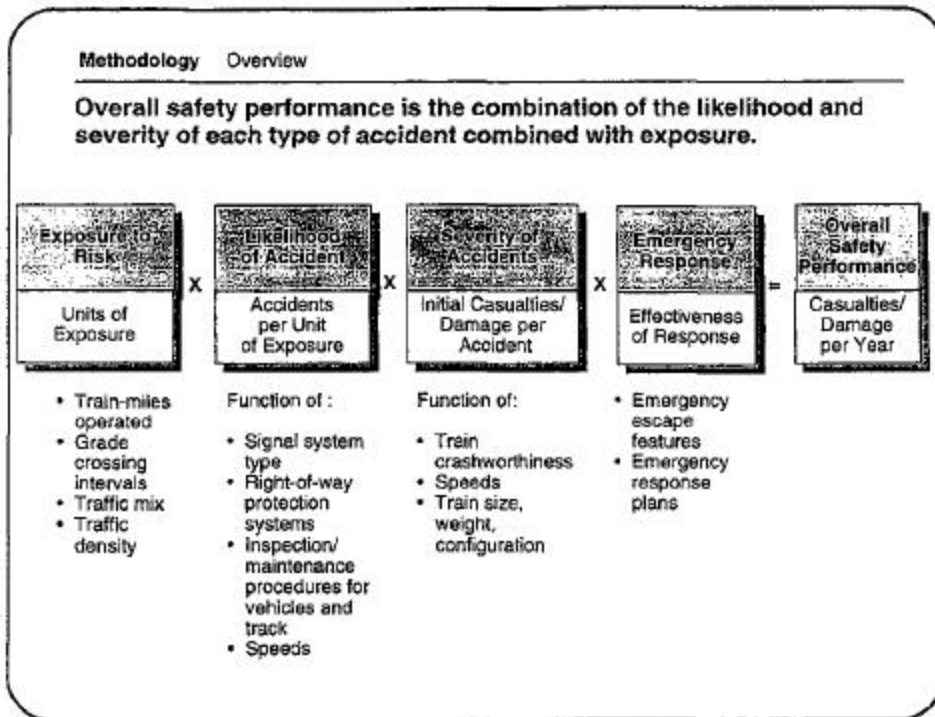

Methodology Overview

A number of analysis techniques exist for identifying accident scenarios and assessing accident likelihood and consequences.

Analysis Technique	Purpose
Hazard and Operability Analysis (Hazop)	Identify Accident Scenarios and Consequences
Failure Modes and Effects Analysis (FMEA)	Identify Accident Scenarios and Consequences
Preliminary Hazard Analysis (MIL STD 882C)	Qualitative Evaluation of Accident Likelihood and Severity
Fault and Event Tree Analysis	Identifies Logical Relationships Between Accident Causes and Consequences
Quantitative Risk Analysis (QRA)	Quantitative Estimate of Accident Likelihood and Severity

Choice of analysis technique or combination of techniques depends on data availability and the objectives of specific analyses.

Accident Scenario

Four principal railroad accident scenarios can be defined, each with several sub-scenarios having distinctive causes and consequences.

Scenario	Typical Causes	Typical Consequences*
1 Train to train collision	<ul style="list-style-type: none"> Human error Brake system defect Signal system defect 	Moderate to very severe, depending on speed
2 Derailment	<ul style="list-style-type: none"> Track or vehicle defect Excessive speed 	Minor to severe, depending on speed, local circumstances
3 Collision with obstruction on track (except at a grade crossing)	<ul style="list-style-type: none"> Lack of adequate warning/protection systems Vehicles/loads not adequately secured Vandalism 	Minor to severe, depending on speed and size of obstruction
4 Collision at rail-highway grade crossing	<ul style="list-style-type: none"> Error of road vehicle operator Lack of adequate warning or protection systems Warning system defect 	Minor with autos or light truck Moderate to severe with tractor-trailers or oversize loads

*Minor, no casualties; Moderate: significant injuries; Severe: some fatalities; Very severe: >10 fatalities

Accident Scenario Exposure

Several types of railroad route or operation can be identified, each have distinctive differences in exposure to accident risks and accident severely.

Railroad Operation Type	Traffic Density	Speeds	Signal System Type	Grade Crossings
High Density Passenger (Northeast Corridor)	40 - 300 trains/day	up to 200 km/h 240 km/h in	Automatic Train Control	Very few
Medium Density Passenger (Most Commuter Operations)	10 - 40 trains/day	Up to 127 km/h	Automatic Block	Significant Number (0.1 - 0.5/km)
Low Density Passenger and Freight	2 - 4 passenger < 10/trains freight < 10 trains/day freight	Up to 127 km/h	Automatic Block	Large Number (0.3 - 1.0/km)
Low Density Freight Only	2< 10 trains/day	Up to 63 km/h	Direct Train Control	Large Number (0.3 - 1.0/km)
High Density Freight with Passenger	2 - 10 passengers/day > 10 trains/day freight	Up to 127 km/h	Automatic Block CTC PTS/PTC in Future	Significant Number (0.1 - 0.5/km)
High Density Freight Only	> 10 freight trains/day	Up to 97 km/h	Automatic Block or CTC, PTS in Future	Significant Number (0.1 - 0.5/km)

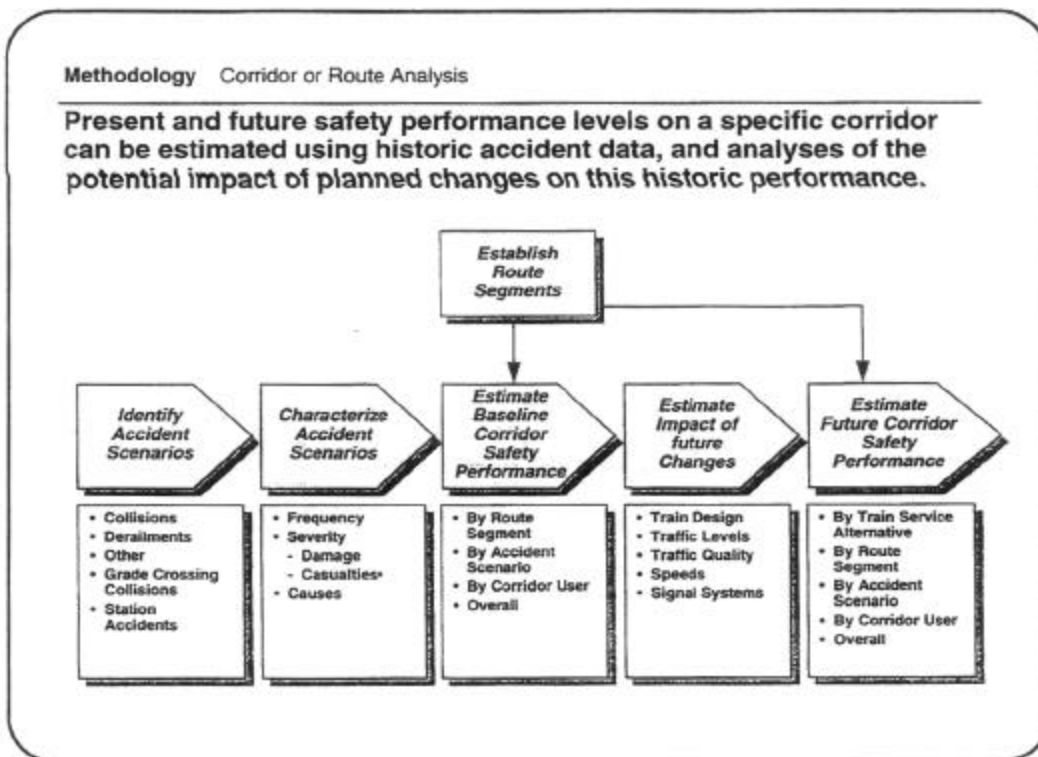
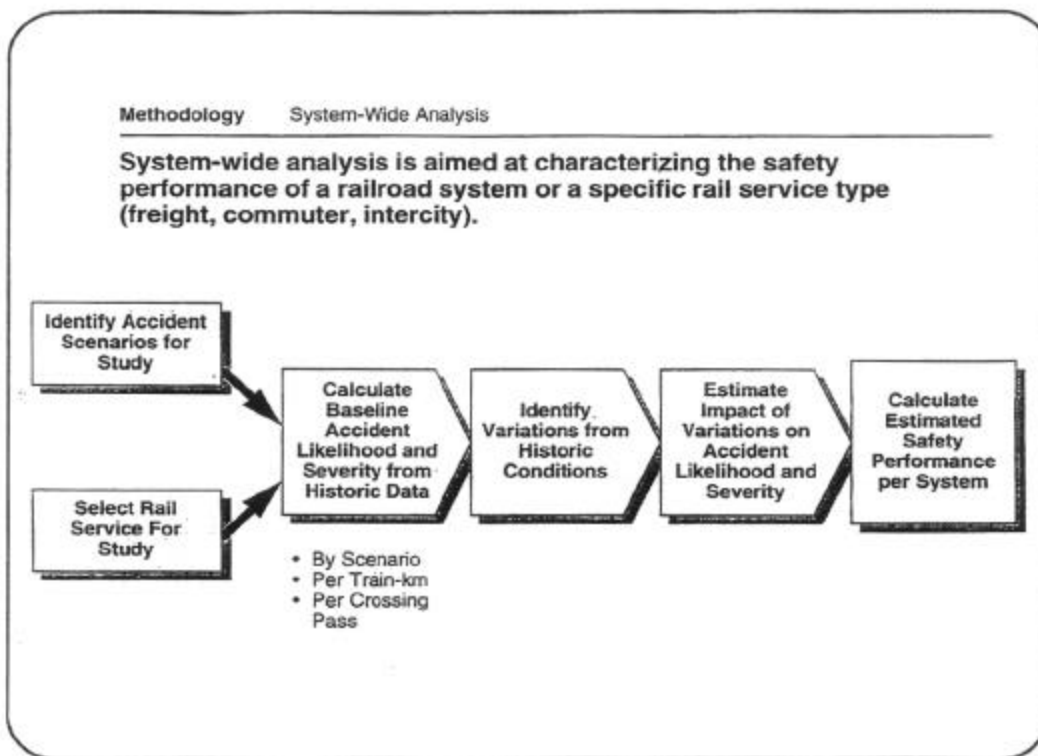

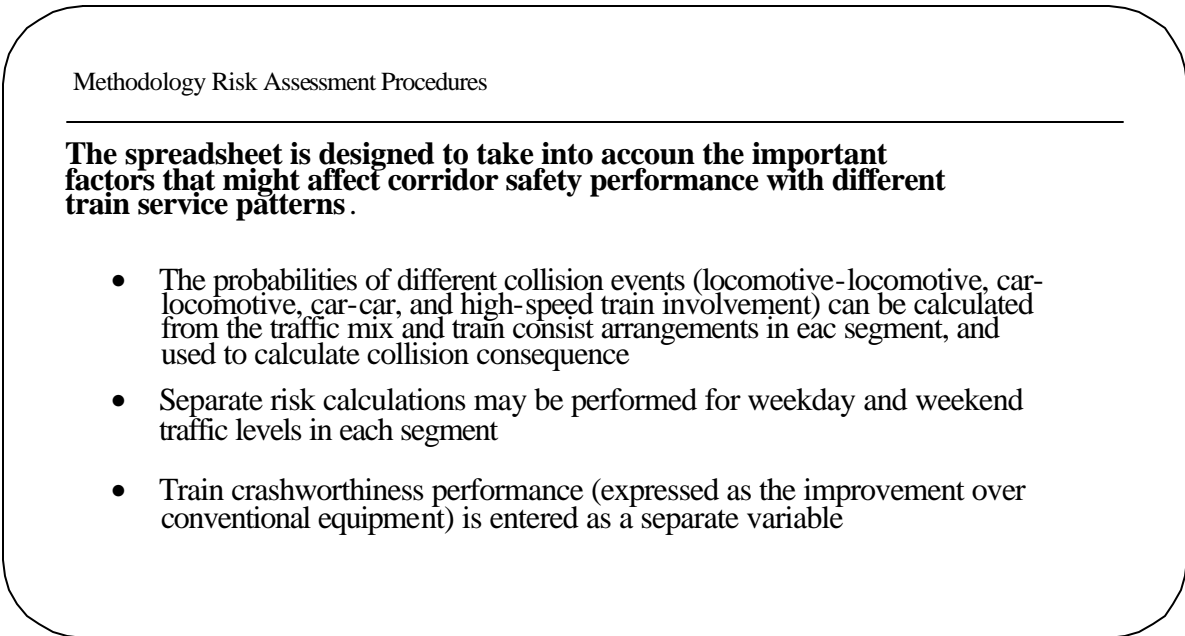
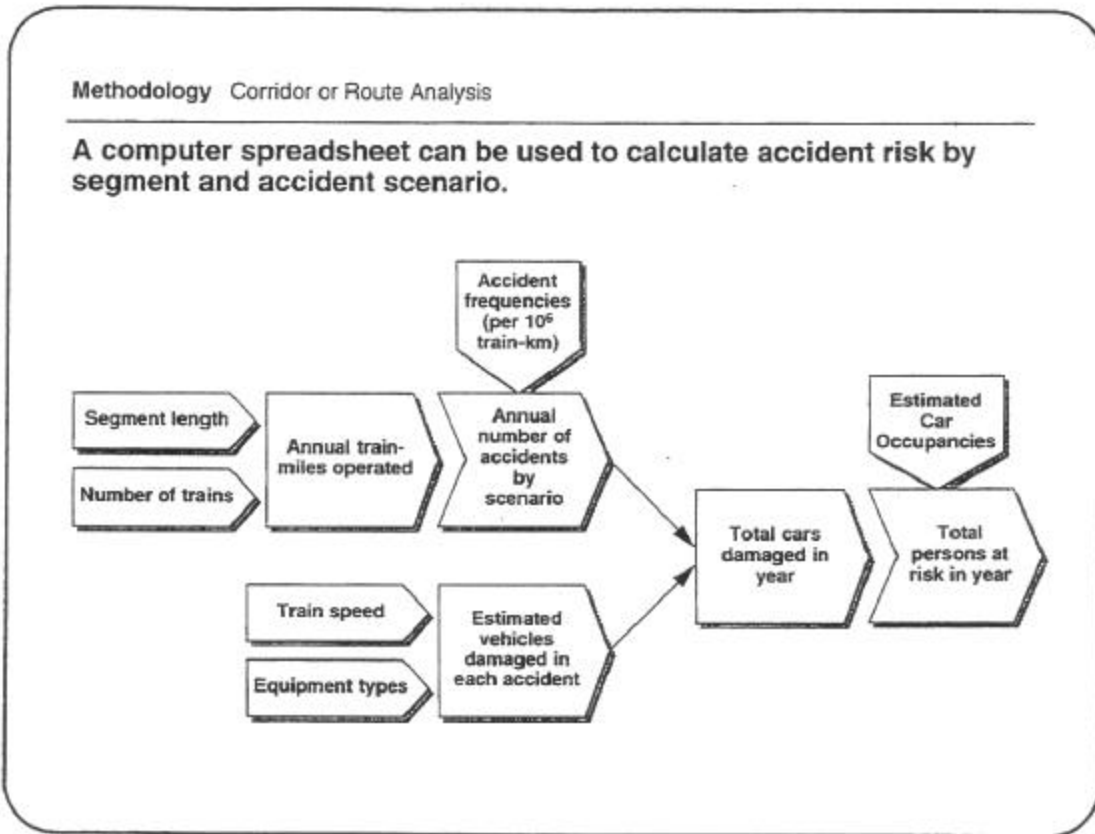

Methodology Data Sources

In the United States, the primary sources of accident data are in federal Government reports and databases.

- Federal Railroad Administration annual Accident/Incident Bulletin
- Federal Railroad Administration annual Rail-Highway Crossing Accident/Incident and Inventory Bulletin
- Federal Railroad Administration annual Railroad Accident/Incident Report database
- National Transportation Safety Board reports on serious accidents

The most significant problems in safety analysis are a lack of good exposure data - breakdown of train-km operated by speed, track quality class, traffic density etc.

Safety Performance Train-to-Train Collisions

Train-to-train collision likelihood appears to be fairly insensitive to the operating environment, as indicated by some representative analysis results.

Rail Operation Type	Approximate Trains in Collision per 10 ⁶ Train-km	Comments
High-Density Passenger (Northeast Corridor)	0.03	<ul style="list-style-type: none"> •About 30% of collisions are in major stations •Automatic train control used
Passenger Trains or Freight	0.04	•Analysis of Amtrak safety
Passenger Trains or Freight Railroads	0.04	performance on freight railroads * Mostly ABS or CTC signaling
Freight Trains	0.05	<ul style="list-style-type: none"> •Includes only main track (i.e., not yards/sidings) •All signal system types

Possibly, high traffic densities offset some of the benefits of improved train control.

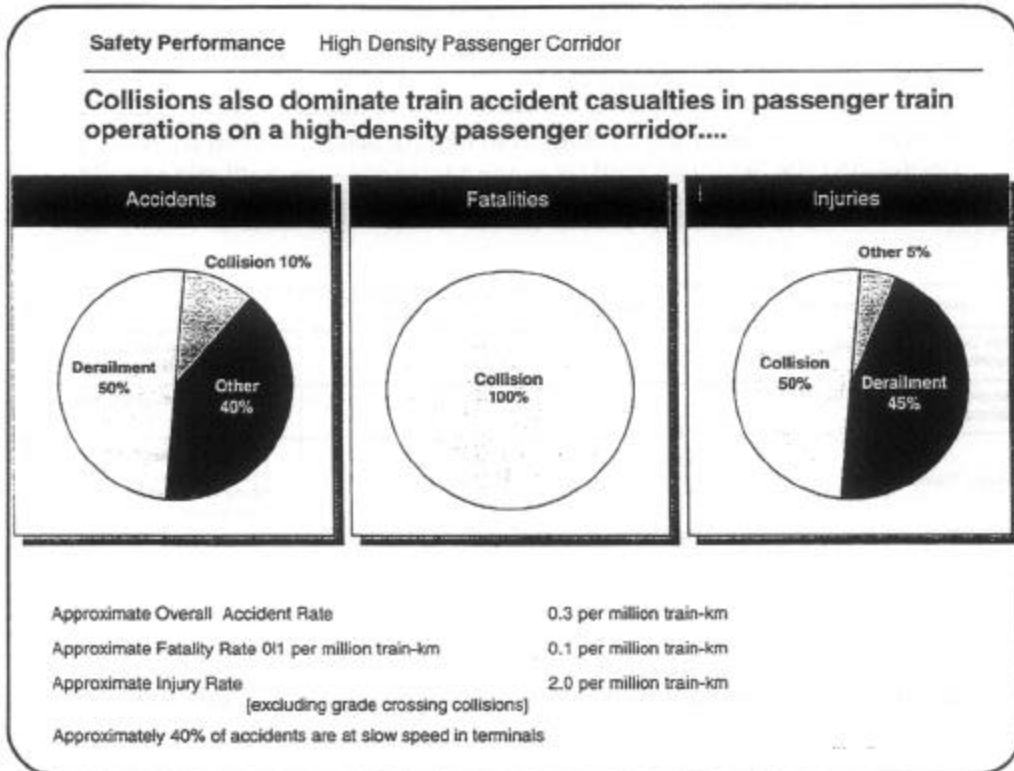
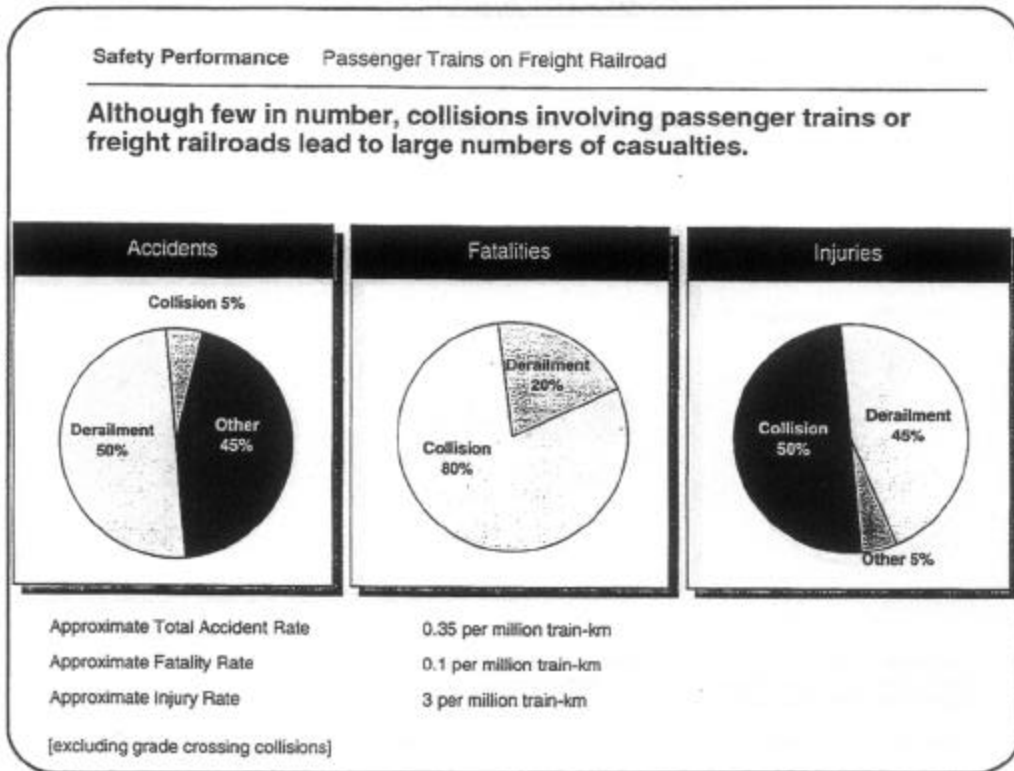

Safety Performance High Density Passenger Corridor

... and in main-line freight railroad operations.

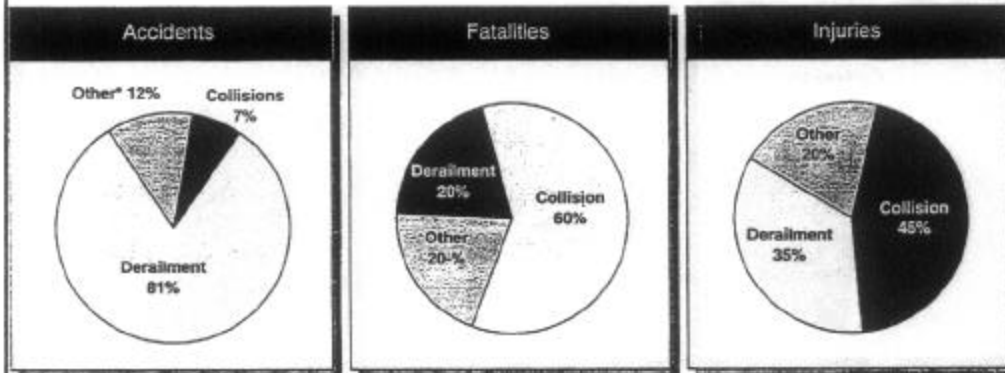

Approximate overall accident rate 0.7 per million train-km
 Approximate overall fatalities rate 0.0035 per million train-km
 Approximate overall injury rate 0.15 per million train-km

[*Other includes fire/explosion events but excludes grade crossing collisions]

Safety Performance Grade Crossings

Grade crossing accident likelihood is significantly affected by railroad operation type, as illustrated by some representative analysis results.

Rail Operation Type	All Accidents	Reportable as Train Accident	Comments
High Density Passenger (Northeast Corridor)	2	0.3	<ul style="list-style-type: none"> • Low highway traffic • Full set of warning systems
Passenger Trains or Freight Railroads	6	0.9	<ul style="list-style-type: none"> • Limited crossing warning systems
Freight Trains	8	0.3	<ul style="list-style-type: none"> • Limited crossing warning systems • Many Crossings cross-bucks only

Grade Crossing collisions cause over 10% of passenger casualties.

Safety Performance Grade Crossings

The casualty rate for highway vehicle occupants in grade crossing accidents depends strongly on train speed.

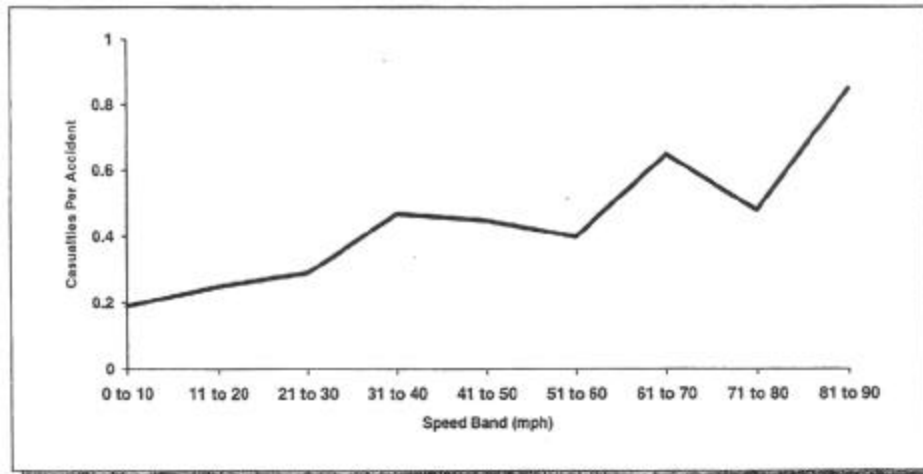

Safety Performance Grade Crossings

The characteristics of grade crossing accidents depend primarily on the nature of highway vehicle, actions of its operator, and highway conditions generally

- Majority of accidents are caused by the road vehicle operator failing to observe warning signs and signals
- Heavy tractor - trailer rigs and over-size vehicles cause the worst accidents
- "Grounded" low-clearance vehicles are a significant factor
- Traffic congestion trapping vehicles on a crossing has been a factor in two recent very serious accidents
- Grade crossing collisions can lead to significant casualties
 - Over 10% of passenger casualties
 - Over 20% of train crew casualties in train accidents

Target Safety Performance

To address the difficult question of what is an acceptable safety performance for freight and passenger rail systems, several perspectives must be taken into account:

- The public at large - societal acceptability
- Employees of the rail system at risk of becoming casualties
- Passengers using rail intercity and commuter services
- Other persons at risk, e.g. highway users at grade crossings

Target Safety Performance Societal Acceptability

Societal acceptability is best represented by a risk profile (on a severity vs. annual accidents scale), using severe accidents in other "man-made" systems as a benchmark.

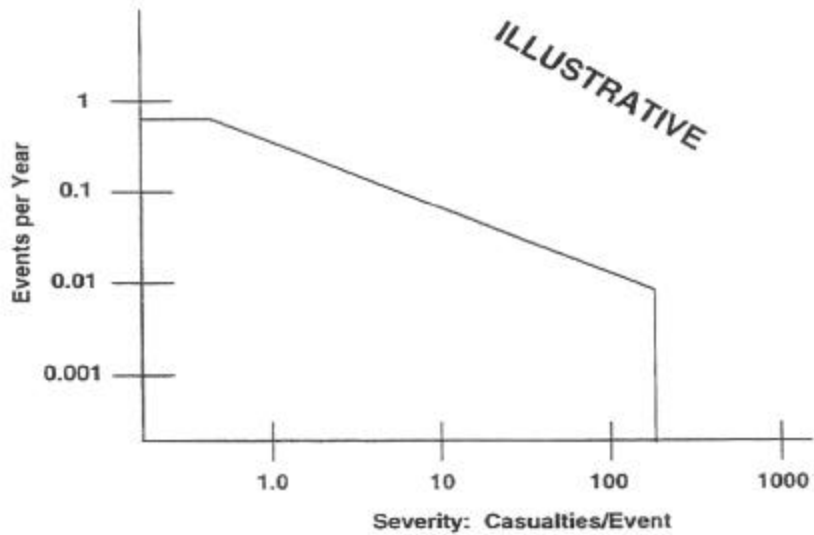

Target Safety Performance Employer and Passenger

Target safety performance for employees and passengers should be at least no worse than recent historic experience on rail systems, and preferably, equivalent to "best practice" in other transportation modes and industries.

Occupational Safety [Annual Fatalities/100,000 employees]	Railroad	14
	High Risk Occupations	40
	Manufacturing	6
	All Occupations	8
Passenger Safety [Fatalities per 1 09 pass-km)	Railroad	0.4
	Major U.S. Airlines	0.15
	Automobile Occupants	6

Safety Performance Analyses Benefits and Limitations

The methodologies described are valuable in understanding railroad safety issues but their limitations must be appreciated.

- Benefits
 - Place risks in perspective
 - Enable trade-off analysis between accident likelihood and severity
- Limitations
 - Paucity of hard data especially of benefits of changes to vehicles, track and other systems: many estimates and assumptions are needed to reach a result
 - Difficulty of establishing acceptability criteria: "how safe is safe enough"

This seminar will help reduce a major area of uncertainty in understanding and analyzing the benefits of improved crashworthiness.

The Need for Rail Passenger Equipment Structural Standards Accident History Review

THOMAS PEACOCK: Thank you, Grady, very much. Everyone out there hear me? Ok. I'd like to thank Dr. Bing for warming up the crowd a little bit. I don't know if it's Monday morning or because there's a lot of engineers in the crowd, but you were kind of quiet there for a while. Glad to see things liven up a little bit.

I'm going to talk a little bit about the need for passenger equipment structural standards. The regulations that Grady's talking about cover more than structural standards, but I want to focus on structural standards in my talk because that's where I hope all of you can help us. That's really one of the reasons why we're having this symposium. Some of the things that the Federal Railroad Administration proposed kind of put the people who buy passenger equipment and the people who build passenger equipment outside their comfort zone. I'm hoping that this symposium helps either expand that comfort zone or give us a better sense of reality, one or the other, so we're working in the same-with an understanding of where we need to be.

My talk is kind of divided into four subjects: What's driving the need for rail passenger equipment standards? I'd like to give some insight into the FRA's database of past accident history. I'd kind of like to take Peacock's corollary to Bing's caveat in that this data is over various spans of time so if you compare it directly to what Alan showed, there might not be a direct correlation. There might be a little discrepancy there and I think that it's largely because I'm looking at this chunk of history and maybe he's looking at this chunk.

I'd like to expand a little bit on the approach we're taking. Grady introduced you to it. Finally, I'd like to acknowledge some notable progress and some contributions of people, a lot of whom are here in the audience who have helped the FRA along. Some of the drivers of why we need to have passenger safety standards are pretty obvious but I thought I'd at least enumerate on them here. The current industry standards are out of date and haven't been maintained. The old Association of American Railroad Standards last attempted revision was in the early 1980's and the AAR has concentrated on the freight end of the business and the passenger end has been neglected. There are no federal standards for passenger equipment. There's only freight car safety standards. We need some set of equivalent passenger equipment safety standards.

You're all aware that operating speeds are starting to increase for passenger equipment. Traffic density is increasing. The types of authorities that run passenger equipment are becoming more diverse. Some of them do not have a wealth of history in the railroad industry. They're upstarts. Foreign equipment is starting to come into play. They've been designed for a different operating environment, a different set of standards. There's a big question: Is it appropriate to operate that equipment in our operating environment in this country? We've had a lot of recent criticism; by recent, I mean maybe in the past five years, General Accounting Office and NTSB all have published recommendations on things that the industry needs to address as far as standards for passenger equipment. Last but not least, and it's probably the graph that Dr. Bing showed, is we're probably over the past year the public's perception threshold and we're getting a lot of scrutiny.

So for the next few minutes I'd like to give you some insight in what's in the Federal Railroad Administration's database on accident history. To do that, you kind of need to understand how the database is defined. In our database, there's accidents and accidents involve a moving train and equipment or track or damage to the railroad's property of greater than \$6300. So you need those two things to be called an accident. An incident, or a train incident, involves less than the threshold of damage of \$6300, but there was an injury involved. Then there are non-train incidents where somebody was hurt and they were a passenger or crew member on the train but the train wasn't moving. So just keep those three things in mind.

Over about, I guess this is a nine-year period, this shows the trend for passenger train accidents and incidents. Nominally, there's about 120 a year with a slightly increasing trend. When you put these accidents and incidents and try to divide them up by cause, equipment defects about 20%, grade crossings slightly larger, human error about the same as equipment defects, and the other involves things like vandalism, track problems, things like that.

Now separating out just collisions. This is collisions involving a passenger train. Nominally about 15 per year, again with a slightly increasing trend. The way the database handles collisions it calls a collision between trains traveling in the opposite direction on the same track, that's a head-on collision. A rear-end collision is when the trains are traveling in the same direction on the same track. A side collision is at a turnout where one train can impact the side of another, and a raking collision involves trains on adjacent tracks or a train coming into contact with a structure adjacent to a track. This is important to remember. In this database, for a collision to occur, the train has to be on the track. If the train derails and then collides, the database calls that a derailment.

For the past six years or so, a breakdown of the kinds of collisions of passenger trains that have occurred (this surprised me a little bit when I saw this), is that the rear-end and head-on collisions are much less numerous than the side impact and the raking collisions. This could have some design implications on future passenger equipment.

Derailments of passenger trains. Again, these are derailments that caused more than \$6300 of damage or caused an injury. So the very minor one wheel set that comes off the track probably isn't included in here. But nominally about 30 derailments of passenger trains per year, again with a slightly increasing trend.

Collisions of passenger trains with highway vehicles. Again, it's about 40 per year nominally, with a slight increasing trend. This is kind of a tabular form of what's the impact of all these accidents and incidents. It's divided into train accidents, grade crossing accidents, and then when you add the incidents into the accidents and then a total of all three of these categories. I guess this is 11 years' worth of data; 130 people killed, a little over 6000 injured, gives you about average 11 people per year killed and maybe 600 people per year injured in any kind of event involving a passenger train.

This is when you plot out the people who were killed aboard passenger trains. This data is skewed badly by the bad year in 1993. We'd actually have a decreasing trend here if it weren't for that one bad year. It's nominally less than 10 per year. Then, passenger train occupant injuries. We have a decreasing trend here which is encouraging, but if you took it for the last five years

that trend would change to increasing. So you have to take this chart with a grain of salt. There's kind of pivot point right here. If you drew the data here we'd have an increasing injury trend.

Now I'd like to switch gears a little bit to the approach the FRA is taking. We've established an industry working group and it has members of all interested parties in the railroad industry. We're looking at possibly having tiered safety standards where we draw a line at some operating condition and speed is usually the one bandied about the most. Say a certain set of standards applies above this speed and some other set of standards applies below this speed. There's actually a new proposed part of the Code of Federal Regulations 238, and it will have standards that include a formal systems safety program, or at least proposed to include, similar to what Dr. Bing talked about. It will have mechanical standards, power brakes will be included in there, and safety appliances.

A formal system safety program is kind of acknowledging that the industry needs to have more big picture guys like Dr. Bing to take a global view of the entire railroads' operation, identify the risks, track them and take some kind of proactive action to mitigate these risks. In my view, this kind of leads to a defense-in-depth approach where rail vehicle crashworthiness is actually the last line of defense. When everything else has failed, this is what you have to fall back on.

I believe that we have a challenge here in that Dr. Bing is somewhat of a pioneer in that this approach is not ingrained in the railroad industry yet. It's kind of in its infancy. There's not much experience in applying it to our environment. There's a problem in those defense-in-depth rings. They compete for resources and we don't have a good way to decide which of those rings should get the bulk of the money. I'll be quite honest with you. I'm not a systems guy. My job is to advocate the vehicle crashworthiness. I have to go out and compete, and if all of those other guys don't get any money and I put it all in that last ring, then I've done my job. So somebody out there has to be out there advocating that the other rings need investment, and then there has to be somebody who's the decisionmaker, the systems guy, who decides how we really make these investments. That's the kind of setup we need to work towards.

This is just a list of the kind of structural standards that the Federal Railroad Administration has proposed. Crash energy management which is really a way to absorb energy and control a collision, and I think there are several papers that discuss this kind of approach. We have end strength and in structure standards proposed, anti-climbers, rollover strength, side impact strength, a lot of interior design features such as how strongly seats need to be attached and other interior fixtures, glazing standards and fuel tank design standards. I'm pleased to be able to do this because there's been so notable progress made. The Federal Railroad Administration has had a lot of help. I think Amtrak and people that Amtrak has had help them like Dr. Bing, the winning consortium of Amtrak's contract, they've all been very responsible citizens. They've done things the law hasn't required. They're kind of blazing the path here for I guess giving us a template of what some of the high speed standards might be.

The American Public Transit Association has taken up the banner of industry standards for passenger equipment. They've kind of picked up the ball that the AAR dropped. They've put an awful lot of work into what they think industry standards should be for passenger equipment. I think it's not only good for safety but it's good business. The Volpe Center and their supporting contractors have been very helpful, and they've increased or pushed forward the state-of-the-art a

good bit. The members of the Passenger Equipment Safety Standards Working Group-there's been a lot of differences, a lot of points to get by, but the group is functional and it's working well and I think they're going to improve the product the FRA comes out with. Finally, this symposium. I think this is going to be of great benefit to us. I appreciate all of you coming, participating and giving us some guidance. We genuinely appreciate this support. I'd be glad to take any questions if anybody has them.

FRANK CIHAK: I hate to be first all the time, but Tom you had your list of drivers that is pushing this whole process forward. I noticed it did not specify any increase in accident rates, and I assume that is true. There is not any increase in passenger rail accident rates happening over the last few years.

THOMAS PEACOCK: That's probably a pretty true statement. You saw some slightly increasing trends on some of the charts I showed, but that doesn't cause me great alarm because it's in an environment that's changing also, so there's reasons for those increasing trends. So probably what you say is a fair statement. Yes sir?

JOHN LEWIS: British Rail Research in England. You quoted on your database that one of your collision definitions was raking accidents and then on the following slide you showed that raking accidents actually count for most of the train collisions. What I'm interested in is how do these occur at all. How do two trains running side-by-side ever come into contact unless it's a sort of sideswipe or more a sort of turnout type accident. It's the type of accident that we never see that I'm aware of in Europe and I'm just interested to know how it occurs in the States.

THOMAS PEACOCK: I would have to draw out the individual accident reports for those accidents to give you a definite answer. Honestly, I don't have a good answer for you but I certainly could go back and get one. I can see what's going on there. It's in the details of the individual accident reports that I didn't pull up. But I will do that.

GRADY COTHEN: Some of them of course are shifted loads on freight movements that are on parallel tracks. Some of them are probably equipment fouling at turnouts that are reported as raking since the equipment is stationary rather than being reported as being as side with the equipment moving. That would be in terminal areas largely. Most of those, not all, are low damage accidents, but it does indicate the envelope of safety in which you attempt to operate is difficult to protect.

THOMAS PEACOCK: Any other questions? Frank.

FRANK CIHAK: With that chart that has the four raking, collisions, and so forth, do you have a distributed fatalities across there that gives us an idea where the fatalities would be versus type of accident?

THOMAS PEACOCK: I certainly could do that. I could give you a feel for that right now. There aren't too many fatalities in rear end collisions that I'm aware of. There's quite a few in head on. I would say that head-on probably has more fatalities than the others. As far as injuries go, that would be an interesting thing for me to go back and replot. I could do that for you.

FRANK CIHAK: How about the last two side impact and raking collisions in terms of fatalities?

THOMAS PEACOCK: Side impact I have seen relatively few casualties because they're usually very low speed and they usually involve the lead vehicles and oftentimes they're locomotives so side impact hasn't been a huge problem. Raking collisions, that sometimes tears open the side and exposes people to injuries but it would be less than the head on. I think head on is probably the biggest injury producer.

FRANK CIHAK: Silver Spring would be classified as a side?

THOMAS PEACOCK: No, that was actually by our definition two trains traveling in opposite directions on the same track. The Amtrak train was desperately trying to get off the same track but didn't quite succeed. So that's a form of head-on collision but not a direct head-on collision, but the database would classify it as a head-on collision.

Any other questions? Thank you very much.

GRADY COTHEN: Before I ask Bob, we surprisingly beat our timetable this morning. What would you like to do?

PRESENTATION

***THE NEED FOR RAIL PASSENGER EQUIPMENT
STRUCTURAL STANDARDS***

The Need For Rail Passenger Equipment Structural Standards

Rail Vehicle Crashworthiness Symposium, June 24, 1996
Tom Peacock, Federal Railroad Administration
Office of Safety

TOPICS OF DISCUSSION

- Drivers for Passenger Equipment Safety Standards
- Recent Passenger Train Accident/Incident History
- Approach to Developing Safety Standards
- Notable Progress/Contributions

DRIVERS

- Industry Standards Outdated, Not Maintained
- Federal Passenger Car Safety Standards Do Not Exist
- Operating Speeds Increasing
- Commuter Traffic Increasing
- Number and Type of Operating Authorities Increasing
- Introduction of Foreign Equipment
- GAO/NTSB Criticism/Recommendations
- Public Scrutiny from Recent Accidents

Accident/Incident History

**Some Insight
into the
Extent
of the Problem**

FRA DATA BASE DEFINITIONS

- Accident
 - operation of on track equipment
 - damage greater than \$6300
- Incident
 - operation of on track equipment
 - damage less than \$6300
 - death or injury
- Non-Train Incident
 - no movement of on track equipment
 - damage less than \$6300
 - death or injury

PASSENGER TRAIN ACCIDENTS/INCIDENTS REPORT TO FRA 1986 thru: 1994

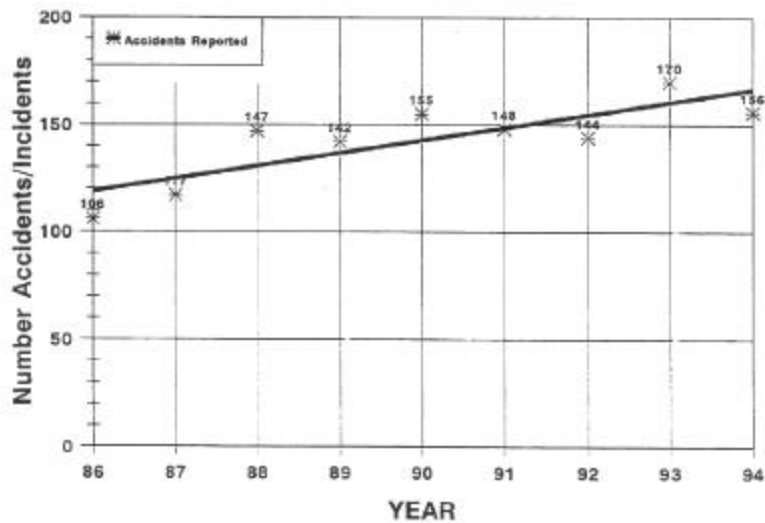

Passenger Train Accident Causes Ten Year Period 1985 to 1994

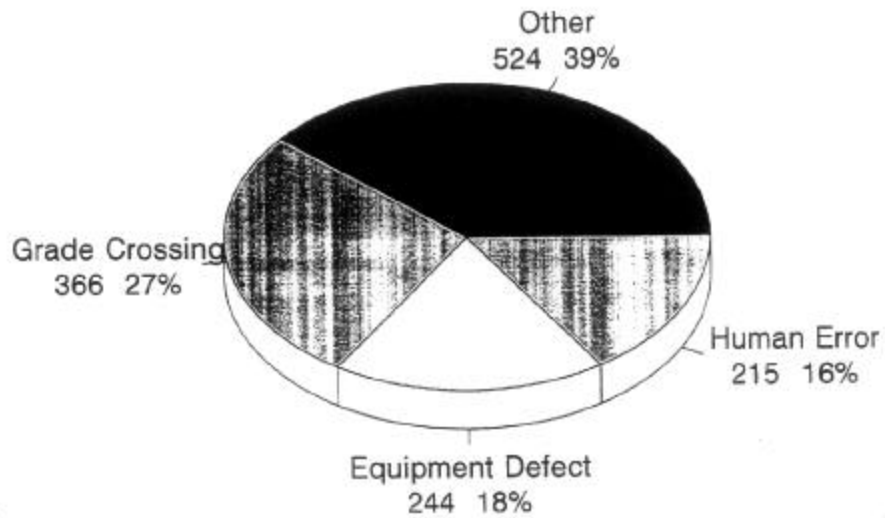

PASSENGER TRAIN COLLISIONS 1986 thru 1994

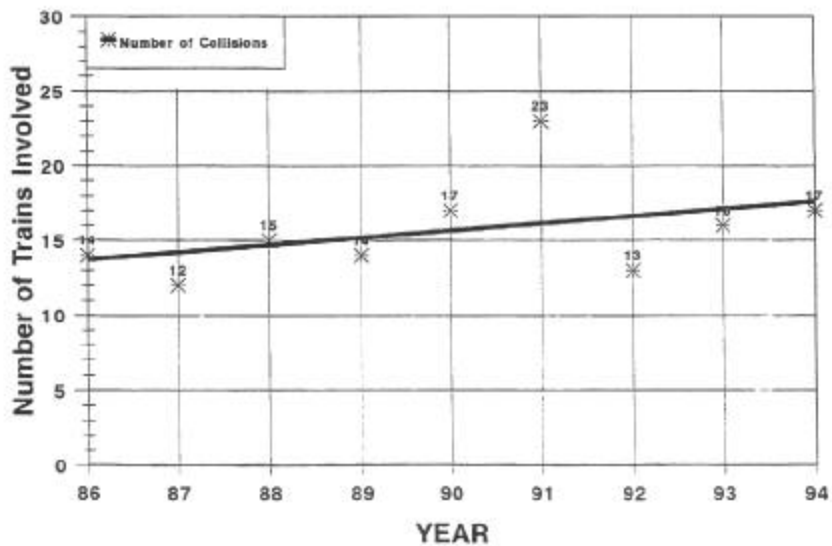

DATA BASE - COLLISION DEFINITIONS

- Head-on = trains traveling in opposite directions on same track
- End = trains traveling in same direction on same track
- Side = at a turnout where one train strikes the side of another
- Raking = trains on adjacent tracks or a collision with a structure

*Both trains must be on the rails for a 'collision' to occur.
A derailment followed by a collision is a derailment.*

TYPES OF PASSENGER TRAIN COLLISIONS 1990-1995

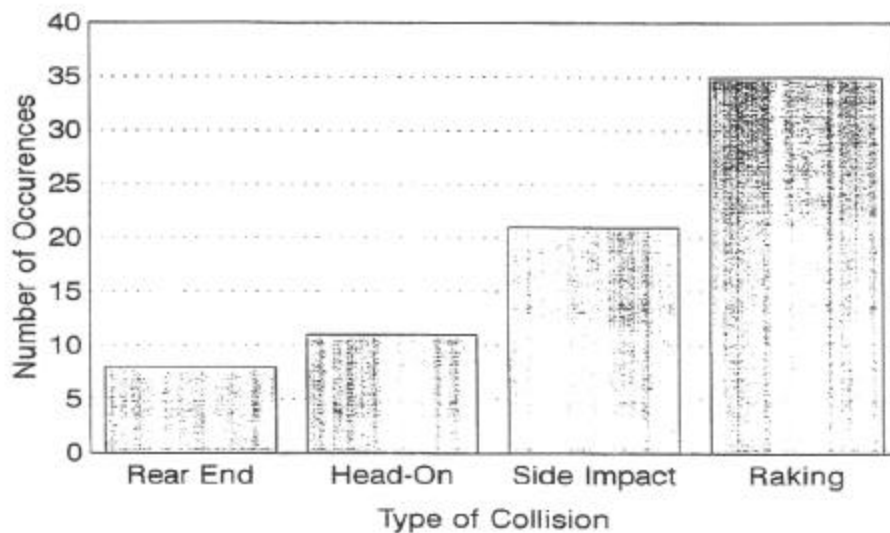

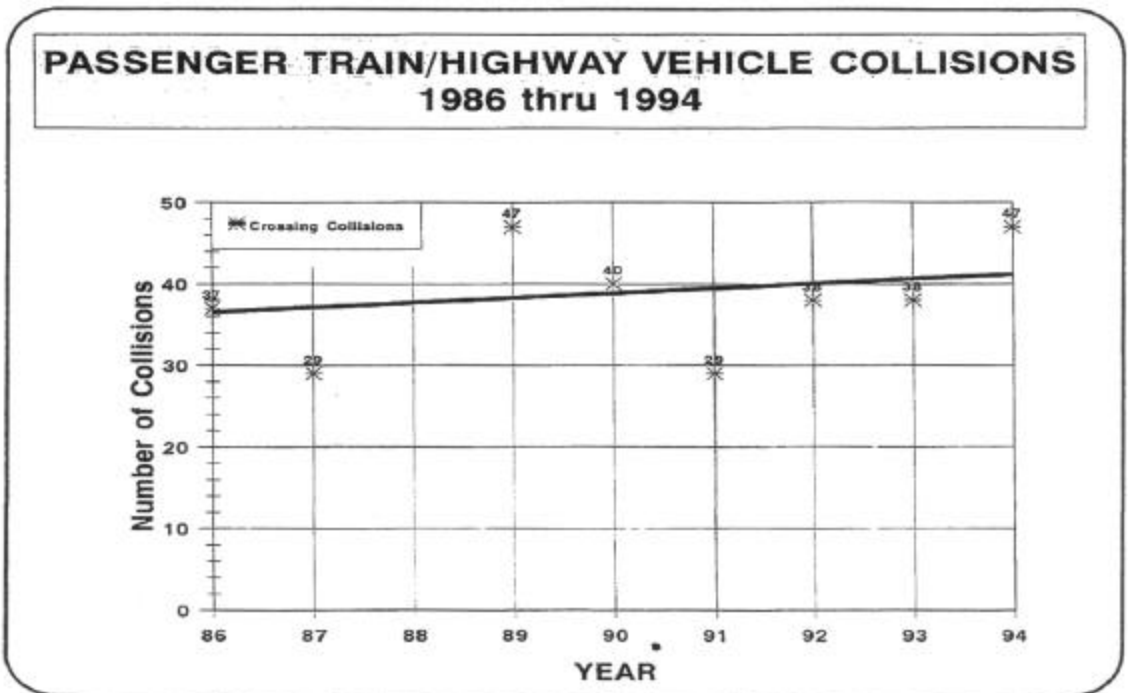
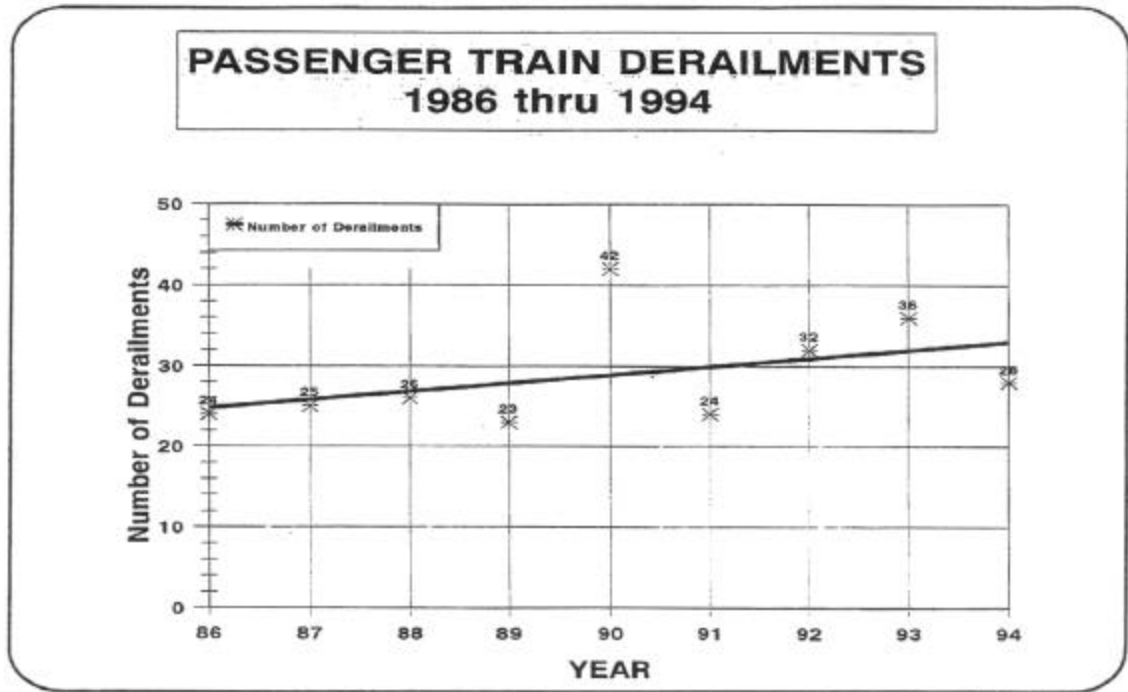

Passenger Train Occupant Casualties
1985-1995

	Train Accidents		Grade Crossing Accidents		Non-Accident Passenger Train Incidents		Total Passenger Train Occupants	
	Killed	Injured	Killed	Injured	Killed	Injured	Killed	Injured
1985	0	287	0	30	3	424	3	741
1986	1	409	0	72	4	269	5	750
1987	17	258	0	20	1	261	18	539
1988	2	160	0	39	2	246	4	445
1989	1	103	2	123	8	253	11	479
1990	0	238	1	41	3	280	4	559
1991	9	61	0	29	0	333	9	423
1992	0	48	1	114	3	299	4	461
1993	54	171	1	86	9	402	64	659
1994	3	129	0	96	3	343	6	568
1995	1	247	1	45	0	309	2	615
Totals	88	2111	6	696	36	3419	130	6239

PASSENGER TRAIN OCCUPANT DEATHS
1985 thru 1995

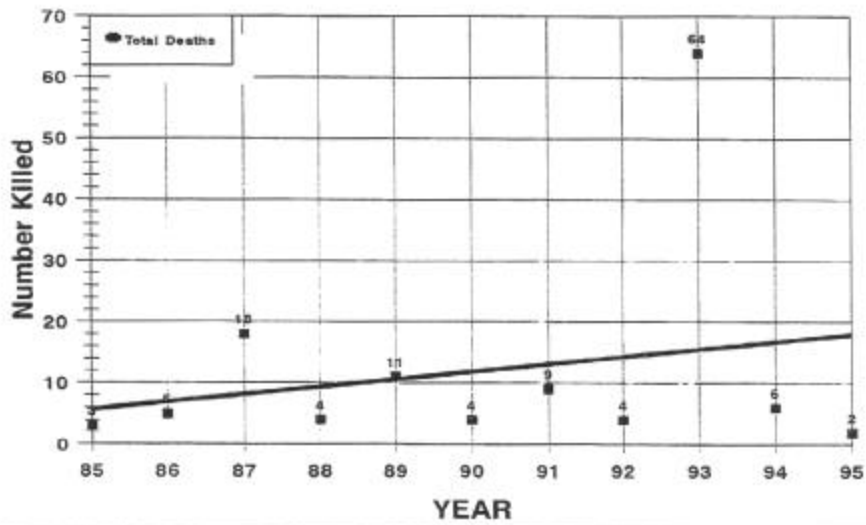

PASSENGER TRAIN OCCUPANT INJURIES 1985 thru 1995

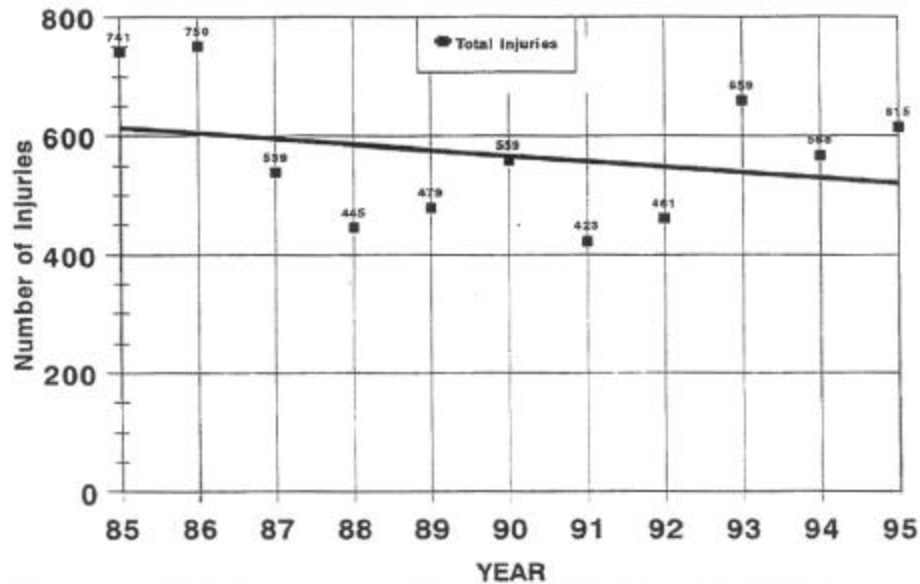

APPROACH TO SAFETY STANDARDS

- Passenger Equipment Safety Standards Working Group
 - Rail Labor
 - Rail Management
 - Builders
 - Advocate Groups
- Possible Tiers of Safety Standards
- Proposed Part 238 in Code of Federal Regulations
 - Formal System Safety Program
 - Mechanical Safety Standards
 - Power Brake Standards
 - Safety Appliance Standards

Formal System Safety Program

- Global Operational Analysis to Identify Risks
- Systematic Tracking of Hazard Reduction/Elimination
- All Hazards Identified Must Be Reduced to an Acceptable Level

Leads to Defense-in-Depth

Defense-in-Depth

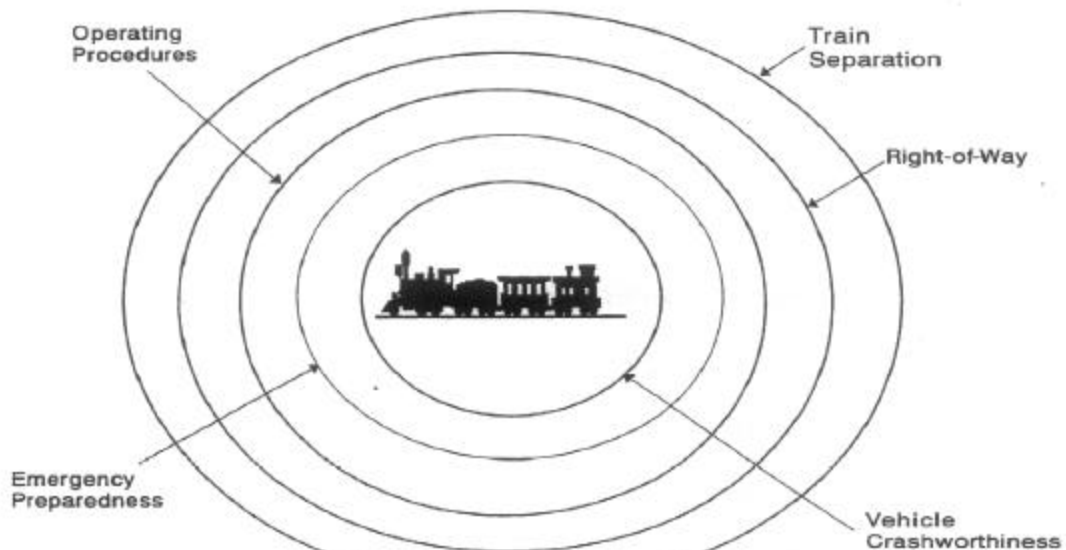

CHALLENGE

- True systems approach to safety is not yet part of the railroad industry culture.
- Not much experience applying a system safety approach in a railroad environment.
- Defense-in-depth rings compete for resources, a methodology for making trade-off decisions is needed.

In the mean time, my job is to advocate crashworthiness.

Proposed Structural Standards

- Crash Energy Management
- End Strength
- End Structure (Collision & Corner Posts)
- Anti-Climbers
- Rollover Strength
- Side Impact Strength
- Interior Design
- Glazing
- Fuel Tanks

NOTABLE PROGRESS STRUCTURAL STANDARDS

- Amtrak High Speed Trainset Specification
- APTA Taking on Responsibility for Industry Standards
- Volpe Center Modeling
- Industry Support for The Passenger Equipment Safety Standards Working Group
- This Symposium

FRA Greatly Appreciates this Support!

Operator Experience

MR. DORER: I would like to present Mr. Frank Cihak, Deputy Executive Vice-President for Technical Services of the American Public Transit Association, better known as APTA, in Washington. Mr. Cihak has 33 years of widely varied public transit experience for the Chicago Transit Authority and APTA. Following graduation with a B.S. in mechanical engineering, Mr. Cihak filled various management and engineering positions with the CTA, being Chief Equipment Engineer and Director of Maintenance Engineering among the positions. He is presently responsible for research, bus, rail car engineering, maintenance procurement, safety, security, Transit Cooperative Research Program (TCRP) information activities, and Phase II of the FTA APTA Bus Procurement Program at APTA. Mr. Cihak is a member of the Society of Automotive Engineers, the American Society of Mechanical Engineers, the American Society for Testing and Materials, the Transportation Research Board and the Car Department's Officers' Association, and also serves as Executive Director of the Transit Development Corporation, Inc., and is the Chairman of the National Fire Protection Association Committee on Fixed Guideway Transit Systems (Standard-130).

MR. CIHAK: Thank you, Bob. As I prepared my remarks for this meeting, this symposium, I was cognizant of being a member of the Class of 1979, and I'm going to ask: How many people in this room were here in '79? One? Okay, for your edification a very similar conference was held then, and the fact that that one was held is one of the reasons why this one is being held, because it became evident that there was a need to update our knowledge base over the ensuing 17 years. So this particular symposium was organized. The circumstances are a little bit different, but many of the issues have not changed.

This morning Alan made some comments and he referred to them as "big picture items." I'd like to continue on that basis. I considered a presentation for this meeting filled with statistics, diagrams, charts, but I know that over the next few days I think you'll get into a very deep level of detail on those types of things. So I concluded that I would try to give you the benefit of my experience, based on the theory that we don't live long enough to learn everything ourselves; we have to learn from other people. And I chose to focus on safety objectives that cover all forms of rail transit-not just railroad or commuter but also light rail, heavy rail; also to comment on some features other than the physical crashworthiness protection, which is the subject of this symposium. The need, for instance, for a system safety program plan in FRA and railroad operations is a step forward. Every rapid transit system, for instance, has had such an internal requirement, which was sponsored by APTA over the last seven years, and we do have 23 members in our Rail Safety Audit Program (RSAP), which mandates and requires that each participating agency have a system safety program plan that includes 23 specified elements in it. We do also have in the RSAP a commuter operator, so it's not just light rail or heavy rail.

I also note here that it was mentioned this morning that the NTSB is not represented here, and that certainly is a disappointment considering their important role in crashworthiness research. I also looked through the list of attendees and I could not find anyone from the Federal Highway Administration. So my question is: Is anybody here from FHA? No, there's another segment of our interest group that's not represented here, particularly in respect to highway crossing accidents caused by trucks and automobiles.

The points I choose to cover in this commentary are safety concerns-what are they and why do they exist; safety perceptions-the public's perception vs. reality; and then philosophy-addressing the real problems and solutions of this business. And they should help us determine what we want to do as a result of all this work. My observations are based on my experience, now 33 years. It includes such events as the investigation of Chicago Transit Authority accidents, including the famous Lake Wabash collision and derailment in February 1977, which claimed 11 lives; the Illinois Central Gulf accident-the most horrendous one in modern times, certainly-of October 30, 1972, and I also attended the NTSB field hearings, which occurred about three weeks later, and I sat within five feet of the witness box because I wanted to hear every word that was said at that time-there were many interesting things that happened.

That accident, you may know or remember, had 44 people dead on the first day and one died the following day. In addition, I participated in several panels of inquiry that the Association has organized for its members. The two most significant ones are the Washington Metropolitan Area Transit Authority accident of January 13, 1982, which was a derailment that resulted in three fatalities. You may also remember that as the day that Air Florida Flight 70 crashed into the Potomac River, and that happened 30 minutes before the WAMATA accident, so it was a very bad day in Washington, in the midst of a blizzard. More recently I participated in the New York City Transit Authority-then it was the Transit Authority-accident of August 28, 1991, which is called the Union Square- 14th Street derailment, and that resulted in five deaths. That probably was the most horrendous rapid transit accident I've ever seen.

So having done all these things, they have pointed out to me some truisms of railroad operation and design that I would like to summarize at the very end. For those of you who want to be students of accidents, I recommend an excellent history of railroad and rail transit accidents and associated safety responses, because we always want to think of them when something happens, what is the response: That is a book entitled A History of Railroad Accidents. Safety Precautions and Operating Practices, and it was written by Robert B. Shaw and published in 1978. And if you don't want to spend the time reading that (it's about three or four hundred pages long), there's a more graphic record, which is more casual reading, of railroad accidents which can be found in a photo book called Train Wrecks by Robert Reed published in 1976. If you look at that, and you look at what happens to the cars involved and the locomotives, you find out many things that are still true today.

So now I'd like to begin with passenger concerns. Passengers want to complete their travel without injury, and that's what we call an accident; they want a safe trip. Now I'm not here considering or will comment on security issues, which are totally different than safety issues and should not be confused between the two. I believe that safety is not usually a primary travel mode choice decider: people do not decide on their travel mode primarily based on safety. You've heard comments this morning that verify that.

In respect to rail travel, passengers do have certain fears, though, and those, I believe, are collisions, derailments and fires. Now why do those fears exist? Well, rail transit frequently operates in tunnels or on elevated structures where egress is difficult. You can't just walk away from it; it's not like a bus. Rail transit often operates at fairly high speeds, and rail transit operates generally in very close headways with fully loaded cars. So you have the rush hour condition, the trains are close together, the cars are all filled with people, you're operating in a

tunnel somewhere—you can see why people might have some concerns. So those are the factors: confined areas, speed and crowded cars.

So stepping back a little bit, what are the public and passenger perceptions of rail transit? I think primarily they think it's safe; that's why they ride it every day. However, security is a concern, as I mentioned, and a very real one not to be discussed here. And what is the reality of this. Well, rail transit is safe, we know that, and some numbers that I had tried to generate in respect to commercial air travel in the United States, and I'm looking at it from a different criterion—this morning Alan, put some numbers up there and it was passenger-miles or passenger-kilometers, but I choose to use the one that is the more appropriate, passenger boardings. Every time someone makes a travel choice, they decide to get on a train or get on an airplane or drive, I counted that as a boarding and based on the gross numbers that I looked at—and I have to tell you these are subject to discussion, because they're taken from different sources—that I could find ratios of 8 to 20 times safer boarding rail transit versus getting on an airplane. I think those are very significant numbers, but those are facts and not related to perceptions.

Well, having looked at perceptions a little bit, now we can talk about the real problems and solutions. The real problem in our business is events, which we call accidents, that result in collisions, derailments or fires. We have many events that occur that do not result in accidents. They must be concurrent in both time and place. And I also want to stress that events, I believe, are always plural. The single-point failure accident cause in rail transit is almost unknown. The only one that I know about in modern times—and I'm looking at the era from, say, middle-1960s on—was the famous BART Fremont Flyer in 1972, which resulted from a single-point failure in the automatic train control system.

Also, we can determine that rail accident investigations, when they're properly done, almost always reveal the true causes of an accident. There are very few railroad accidents where the causes are unknown. Again, in modern times I can point out to one where the cause is unknown, and this occurred in 1975 in the London Underground; it was the famous Moorgate accident, which resulted in 41 fatalities. There never was a cause found for that accident. So if accident defines the real problem, then how do we prevent or defend against these events happening?

Well, we do this by considering several things: they are personnel, procedures, equipment, usage and design. And the process of using all of those elements has been well thought out in the railroad business for many years, but it always should be re-examined in the light of any accident investigation—you have to go back and feed in new information. Our first priority should always be to prevent accidents. When we have an accident we need to find out what caused it, and we need to examine those causes in relation to our defenses and make appropriate changes as required. We never finish our safety work; we just keep plugging away at it.

In respect to personnel, you must consider all aspects of employees in safety-critical positions. By the way, that term "employees in safety-critical positions" is one that's become fixed into legislation now and also by regulation. Most rail accidents that I've been involved in are the result of personnel mistakes. In airlines, it's pilot error. Human performance can be enhanced. How do we do that? You do it by careful selection, by training, by testing, by retraining, by monitoring and evaluation. Again, this is the major cause of accidents, but we're not going to cover that aspect in this symposium. This might be a basis for a future symposium.

Procedures: these are the rules of operation of a railroad, the rule book, as it's usually called, and the associated standard operating procedures that govern and define operations. These are backed up by the maintenance procedures we use to keep our equipment in proper condition. In respect to equipment, most accident evaluations again that I've been involved in recognize that since personnel errors are the cause, there are very few instances, particularly in rail transit, where equipment is the cause. In fact, equipment has been developed to prevent and limit human intervention in operations. In most operations these are called ATP or ATO signal control systems. And from observations we know that they are remarkably good in preventing collisions. Accidents in rail systems with ATO and ATP are almost always due to human interference or override of safety functions, either by mistake or on purpose. The Amtrak Northeast Corridor accident at the Gunpowder River Bridge was the result of persons purposefully disabling safety devices, and that's extremely difficult to defend against.

Now if we start looking to the subject of this particular symposium, and that is the role of crashworthiness, remember it always occurs after the accident. I define it as the loss of livable or survivable volume for the passengers and crew and/or extreme deceleration. The loss of livable volume is due to crushing, overriding, telescoping or penetration by external forces-I'd use the term "missiles" but that's not particularly correct: penetration of the space by these missiles is almost always connected to shifted loads or wide loads on adjacent rail or freight tracks, it's a very rare occurrence. The loss of volume in modern cars due to overturning or side penetrations is also very rare. Based on all this, we can conclude that the longitudinal collision is our main concern, and I think again that was presented today, you remember the one diagram had head-to-head collisions and also rear collisions: well, they're both the same collision, just some of the cars seem to be running in the opposite direction. These are both collisions that occur directly on the center line of equipment or slightly offset.

Our usual defenses on these are well known in this business, and we are carefully reviewing them as part of the APTA Task Force to Develop Safety Standards. And I'm going to recite these; maybe you've heard them all, maybe you haven't, I do it because in every kind of meeting here there are some people who are not necessarily well informed about all this business and they need to have a basic level of understanding.

First of all, we need to describe and discuss buff load or static end strength. As described by the AAR in their Standard S034, 1969, it is "the load applied at the line of draft." In light rail and heavy rail particularly, that requirement is defined as the load applied at the anticlimber, which is basically at the floor level, in line with the main structure. Now why are those dimensions different? Why is one at the line of draft and one at the floor? Well, it's due to the weight of the cars, the length of trains, and the handling practices. Five-mile-an-hour couplings with freight cars and railroad passenger cars are relatively routine. On the other hand, the five-mile-an-hour coupling with heavy rail cars can be described as a collision and cause some significant damage.

In respect to devices that we use to prevent accidents, the couplers are part of that scenario also. Obviously, passenger cars now in all heavy rail and light rail service use tightlock coupler designs, which don't have any slack and do not permit vertical uncoupling. Interestingly enough, if we think about it, couplers are almost always aligned by springs or center locks; and in most collisions the cars couple up before they collide or at the same time they collide. And that limits the forces that can be exerted afterwards. Anticlimbers resist the tendency of one car to override the other and are complemented by the collision posts, which are intended to prevent telescoping

and penetration. The strength, the height and the method of attachment to the floor and the roof are very important in collision post design.

An item that is never put into any specification that I've ever seen, but is a fact, is the similarity of design, and that means that one car is going to operate with other cars of a particular configuration. If this is not considered when you design a car, then you're going to have very bad results. The classic example of this was the 1972 Illinois Central Gulf Railroad collision in Chicago, where there was a floor height difference between the striking car and the struck car, and it resulted in the striking car overriding the floor of the standing new Highliner car. Due to faulty welding detail of the collision post connection to the floor, the collision post sheared off in that particular collision, and it resulted in penetration of 35 or more feet into the Highliner car. Again, there were a total of 45 fatalities, so in the scope of things we need to defend against, that's a very important one.

Another item which is often specified and is very important is the truck-to-car body connection. That connection significantly increases the resistance to crushing, particularly at the end of the car, and prevents penetration. In the Illinois Central accident, it should be noted that the striking car truck separated from the car body, which made further penetration possible.

Now I'd like to cover how these principles could be applied to a particular car design in a procurement specification. And the cars that I want to refer to here are rapid transit cars that I'm particularly knowledgeable about, since I was the person responsible for the specifications. I bring it to your attention because the people who designed the car, based on the specifications, were not traditional railroad people at all; they were engineers from the Boeing Vertol Company, and they undertook to build a car order for the Chicago Transit Authority in 1974. The cars were delivered in late 1976, and they're 2400 Series cars. They are of stainless steel construction; there was some low alloy/high tensile steel in the end underframe, but essentially they were all stainless steel car bodies, they were 48 feet long. They weighed a little under 48,000 pounds, and with the maximum train length of eight cars, you have an empty train weight of around 400,000 pounds.

Now this particular car order had a series of design features. I mentioned those features before and I'll tell you how they were incorporated there. The couplers, for instance, were identical to all other CTA car couplers; 1100 cars had the same mechanical coupler. So in a collision we knew how those couplers were going to react. These couplers did include another feature not mentioned earlier, which is the provision for shear bolts that allowed the coupler to slide back when it exceeded the bolt shear strength which is around 75,000 pounds, and it allowed the anticlimbers to come together in a controlled fashion. Again, the couplers being coupled together limited vertical displacements, for instance, and were important in the car design. The anticlimbers again were identical to all other CTA car anticlimbers. They were on the floor structural center line where the 200,000-pound static end strength was specified.

In respect to the end structure of the car-which includes the anticlimber, the end framing, and collision posts-the collision posts were full height, and the floor and roof connections were required to develop the full strength of the connected members. Now that's different from other specifications where they say it must have certain strength; in addition to having that strength, we required all those connections to be, wherever possible, welded on both sides and all welds were

full-length. We did not permit any skip welds; even though that amount of welding could have met the requirement, we did require a completely welded design.

It was intended that this end structure would collapse as a unit, keeping the floor and roof together, to maximize the energy absorbed by the deformation of metal. Now this was a concept adopted by the CTA years earlier and known at that time as "controlled crush design." A useful description of this is contained in a report entitled "Controlled Type Crush Design for Rapid Transit Cars" by Lawrence Gordon Anderson, who was then Superintendent of Shops and Equipment with the Chicago Transit Authority, in 1965. This particular design included a controlled void in the floor structure behind the anticlimber, which was put there to direct and initiate the structure collapse. We wanted the collapse to begin at a place specified, so there was a void put into the structure at that point.

The truck attachment for the CTA cars used a unique design. It's the PCC car kingpost design, which easily exceeded our 150,000-pound horizontal strength requirement; it also had 100,000-pound vertical strength. In addition, these cars had, as I indicated, a 200,000-pound static end strength "without permanent deformation" requirement. Later in the specifications there was a provision that required that this design was to be achieved using 100 percent of yield strength for the portion of the car between the end of the car and the body bolster. The portion of the car between the bolsters was required to have this strength but at only 70 percent of yield. So the strength between bolsters was commensurately higher. That meant that the ends would crush first, not the car center. In addition, it was required that positive car body camber was to be maintained under all load conditions, a very important feature. So this is how these principles were applied to a particular car construction. They had proved very successful over 45 years of experience.

Other points we should think about are strength definitions, which I'm sure we'll talk about a lot here in the next few days, and fire resistance. And the definition of strength levels-if you look at lots of specifications and reports, you'll find many terms used, and they are very important and they need to be carefully considered. I indicated one was load without permanent deformation, that's one; ultimate strength, yield strength are others. They have to be carefully worded when you write a specification. In regard to rail car fire resistance, this is also part of a system of design, and I would refer you to the National Fire Protection Association Standard #130 for Fixed Guideway Transit Systems, which is a comprehensive defense against fire loss.

In that document there are four principles: one is isolation of fire and energy sources. And since most cars are powered by electricity, particularly in rapid transit, all of them are, separation of electrical sources is very important. The next principle was to try to limit the total BTU load of the car. Next was to limit individual item fire propagation rates and smoke propagation. And lastly, in special cases like when trains operate in tunnels, to provide external ventilation and specific egress requirements.

So I've given you a lot of ideas here and told you a lot of things, so let's try to pull all this together. First of all, I want to commend everyone here to continue to try to find better, cheaper, more reliable and more effective solutions to improve crashworthiness. I hope this symposium does eventually end with a new paradigm for crashworthiness. (I went to a course on paradigms so I promised to get the word into every talk I did after that.) To this end, I note that there has been very little direct real world crash information generated and available. We know some

things by analysis and modeling, very little by test. So as a result of this symposium and other things, we may recommend a comprehensive test program to fill in our knowledge gaps.

Now getting to the very end, I'd like for you to consider, as this symposium goes on, the following truisms that I've learned. There's basically ten simple rules. First of all, weight is the enemy. Second, where cars and equipment are similar, the design is simpler. Third, where cars and equipment are dissimilar, such as three 100,000-pound locomotives and 100,000-pound coaches, our problem and our design has to be much more complex. Fourth, we should always seek to reduce or eliminate human decision-making or response to routine tasks. Fifth, maintenance of equipment by inspection, repair and overhaul is important. Sixth, we have to maintain our personnel by training, testing and monitoring. Seventh, the most survivable accident is the one that did not happen, and the highest priority must always be to eliminate accidents, again by means of automatic train protection and automatic train operation systems. Eighth, crashworthiness is always after the event; we can only seek to minimize injury and damages. Ninth, safety is a continuous task and we need to always apply ourselves. And lastly, there are some rules of operation violations that happen over and over again: in significant accidents, you find out they're always violated, and when they are violated they always result in terrible things.

And they are: Rule #1, don't pass stop signals. Rule #2, don't back up. Rule #3, don't back up. And you know what Rule #4 is, don't back up. Thank you for your attention. [Applause]

PRESENTATION

OPERATOR EXPERIENCE

**AMERICAN PUBLIC TRANSIT
ASSOCIATION**

**TRANSIT OPERATOR
CRASHWORTHINESS EXPERIENCE**

Remarks by:

Frank J. Cihak
Chief Engineer and Deputy Executive Vice President -
Technical Services
American Public Transit Association
June 24, 1996
Volpe National Transportation Systems Center
Cambridge, Massachusetts

Transit Operator Crashworthiness Experience**Frank J. Cihak****June 24, 1996**

As a member of the Crashworthiness Conference (VNTSC) Class of 1979 I considered a presentation filled with statistics, diagrams and charts. I know a great deal of information will be provided later in this Symposium. Some is based on experience, some on analysis, modeling and testing. I chose to focus on Safety Objectives covering all rail transit - light, heavy and commuter rail.

I will also comment on features other than physical crashworthiness protection. The need for a System Safety Program Plan (SSPP) in FRA/Railroads is a step forward - heavy rail has the APTA Rail Safety Audit Program with SSPP requirement for the last seven years.

I also regret that the NTSB is not represented here today. I also note that the Federal Highway Administration is not present.

The main points I will cover are:

- > **Safety Concerns** - what are they and why do they exist?
- > **Safety Perceptions** - public vs. reality
- > **Philosophy Addressing Real Problems and Solutions** - what do we want to do includes all rail transit - light rail, heavy rail, commuter rail

My views are based on my experience

33 years of observations and investigations at -

- a) **Chicago Transit Authority** - many accidents including Lake/Wabash collision and derailment on February 4, 1977 - 11 fatalities
- b) **Illinois Central-Gulf Railroad** - collision of October 30, 1972 and NTSB Field Hearing following - 45 fatalities
- c) **American Public Transit Association Panels of Inquiry** -
 - Washington Metropolitan Area Transit Authority - January 13, 1982 - derailment - 3 fatalities
 - New York City Transit Authority - August 28, 1991 - derailment - 5 fatalities

This experience has pointed out some truisms of railroad operations and design that I will summarize at the end of my remarks.

For those of you who want to read an excellent history of railroad and rail transit accidents and associated safety responses, I recommend: "*A History of Railroad Accidents, Safety Precautions and Operating Practices,*" by Robert B. Shaw, 1978. A more graphic record of railroad accidents can be found in "*Train Wrecks,*" by Robert C. Reed, 1976?.

To begin with, what are the passenger concerns?:

Passengers want to complete travel without injury (accident) i.e., a "safe" trip - we are not here considering security issues.

Safety is not **usually** a primary travel mode choice decider.

In respect to rail travel, there is fear of

- collisions
- derailments
- fires

Why do these Passenger Concerns Exist?:

- a) rail transit frequently operates in tunnels or on elevated structures where egress is difficult.
- b) rail transit often operates at much higher speeds than buses.
- c) rail transit operates close headways with fully loaded cars.

The factors are:

- confined areas
- speed
- crowded cars

What are Public/Passenger Perceptions of Rail Transit?

- a) it's safe
- b) security is a concern

What is the reality?

- a) rail transit is safe - it may be 8 - 20 times "safer" per **boarding** than scheduled air carriers
- b) rail transit is secure

Now We Can Discuss Real Rail Problems and Solutions

The real problem is events, which we call accidents, resulting in collisions, derailments or fires.

Note that many times the "events" do not result in accidents - the events must occur in the same place and time. I want to stress events are plural - that single point failures almost unknown. An exception was the BART Fremont Flyer in 1972.

Rail accident investigation almost always reveal the true cause(s) of the accident - how many causes are listed as "unknown"? Very few i.e., an exception was the London Underground collision at Moorgate in April 1975 (41 fatalities).

If "Accident" as defined is the real problem, then how do we prevent or defend against the events happening? We do this by personnel, procedures and equipment design and usage.

This process has been well thought out and should always be re-examined as appropriate to the results of any accident investigation.

Our first priority should always be to **prevent** accidents. This is a constant cycle of investigation of accidents and incidents and the analysis and feed back of results into the operating system. We can never say we have finished our safety work, its never finished but in a constant state of re-evaluation.

Personnel - We must consider all aspects of employees in safety critical positions. Most rail accidents are the result of personnel mistakes ("pilot error" in the air travel industry). Human performance can be enhanced by careful selection, training, testing, re-training, monitoring and evaluation. However, this is not the subject of this symposium.

Procedures - These are the "Rules of Operation" - The Rule Book - and Associated Standard Operating Procedures (SOPs) that govern and define operations. These are backed by maintenance procedures to keep equipment in proper condition.

Equipment- most accident evaluation efforts in rail transit recognize that personnel mistakes in operations or maintenance are the major cause of accidents. Rail transit equipment has been developed and installed to reduce or eliminate the role of human intervention in operations. These are Automatic Train Protection (ATP) and Automatic Train Operation (ATO) signal/control systems. These are remarkably good in preventing collisions. Accidents at rail systems with ATO/ATP are almost always due to human interference or override of safety functions either by mistake or on purpose.

This brings us to the accident after the event and the role of Crashworthiness - this problem can be defined as loss of livable volume or extreme deceleration. The loss of livable volume is due to crushing, overriding, telescoping or penetration by external missiles. The penetration of passenger space is almost always connected to shifted or wide loads on adjacent freight tracks and is very rare. The loss of volume in modern rail cars due to overturning or side penetration is also very rare.

We can therefore conclude that longitudinal collisions are our main concern. This was confirmed by Alan Bing's earlier remarks. Longitudinal collisions include on center line and offset collisions.

The traditional defenses against these collisions are well known and are being carefully reviewed by the APTA PRESS Task Force. They are:

- a) **Buff strength or static end load** - a note of caution here, the requirements developed by the AAR as shown in Standard S-034-69 have the load applied at the "line of draft." This is the standard applied to railroad and commuter cars. The common requirement for heavy rail cars defines the load to be applied to the anticlimber at the car floor level and therefore, in line with the main structure. The difference is due to the weight of cars, length of trains and handling practices. For instance a five mile per hour coupling is not unknown in freight car and railroad passenger car operations. On the other hand, a five mile per hour coupling with heavy rail cars is a collision.
- b) **Couplers** - passenger car couplers are of the tight lock design and do not have slack or permit vertical uncoupling. Couplers are usually aligned by springs or center locks and often couple up in a collision to limit load direction.
- c) **Antidclimbers** - this feature resists the tendency of one car to override the floor structure of another car in a collision and engage the collision posts. The vertical strength and width of anticlimbers are important features.
- d) **Collision posts** - these resist the opposite car floor structure in overriding and are intended to preclude telescoping. The strength, height and method of attachment to the floor and roof structure is very important.
- e) **Similarity of design** - this is normally not stated in a specification but is very important. The design features of a car have to be considered part of a system. If this is neglected than very bad results will be obtained. The classic example of this was the Illinois Central-Gulf Railroad collision on October 30, 1972 in Chicago. There was a floor height difference which resulted in the striking car overriding the floor of the standing Highliner car. Faulty welding detail of the Highliner collision post connection to the floor structure allowed the collision posts to shear off at the floor and the result was penetration of more than 35 feet of the Highliner car. There were a total of 45 fatalities.

f) Truck to carbody connection - the ability to retain the truck to the carbody greatly increases the resistance to crushing and penetration of the carbody. Both horizontal and vertical strength must be specified in a design. In the ICG accident the striking car lead truck separated from the carbody permitting the further penetration of the Highliner car.

Application of These Design Principals to a Specific Design

I would like to describe how a particular car order used these principals as a system of design. The example will be a rapid transit car, so you must take into consideration the differences with railroad and commuter cars. The example is 200 cars designed by the Boeing-Vertol Company in 1974 and delivered beginning in October 1976 to the Chicago Transit Authority in Chicago, Illinois. They were of stainless steel construction, 48 feet long, weighed under 48,000 lbs and operated in a maximum train length of eight cars for train weight of about 400,000 lbs. I am familiar with these cars as I was the Chief Equipment Engineer of the CTA and was responsible for the specifications and procurement of this car order. The design featured:

Mechanical couplers - identical to all other CTA cars, they included shear bolts that allowed controlled engagement of the anticlimber.

Anticlimber - identical to all other CTA cars, is on the floor (structure) line where the static end strength of 200,000 lbs without permanent deformation was specified.

End structure - this included the anti-climber, the floor framing between the anti-climber and the body bolster, the collision posts and the roof structure.

- a) the collision posts were full height and the roof and floor connections were required to develop the full strength of the connected members. All welds were full length and double sided where possible.
- b) it was intended that the end structure would collapse as a unit keeping the floor and roof together to maximize the energy absorbed by deformation of metal. The concept adopted by the CTA was that of "controlled crush design." It included a controlled

void behind the anti-climber to direct and initiate collapse. A useful description is contained in a report entitled, "*Controlled Type Crush Design for Rapid Transit Cars,*" by Lawrence Gordon Anderson, Superintendent of Shops and Equipment of the Chicago Transit Authority in 1965.

Truck attachment - this used the PCC kingpost design and easily exceeded the 150,000 lbs horizontal strength requirement and 100,000 lbs. vertical strength requirement.

Strength level definition for static end strength - the 200,000 lbs static end strength, without permanent deformation, applied at the anticlimber was designed using 100% of yield strength from anticlimber to body bolster and 70% of yield strength between bolsters. This design will have the ends crush - not the car center section. Positive car body camber was to be maintained under all load conditions.

The preceding describes a system of design based on local and external experience and has been proven successful over 45 years. Other points of note are in strength definitions and fire resistance.

Definition of strength levels - in technical documents and specifications, the terms used to describe strength levels must be very specific. Such terms as yield strength, ultimate strength, "load without permanent deformation," all have specific meaning and must be carefully considered in a system of design.

Regarding rail car fire resistance - this is also part of a system of design and the best application for rail transit can be found in the National Fire Protection Association (NFPA) Standard #130 for Fixed Guideway Transit Systems. The basic principals are:

- a) isolation of fire/energy sources
- b) limit total BTU load

- c) limit individual item fire propagation rates and smoke generation
- d) in special cases, like tunnels, provide external ventilation and egress requirements

SUMMARY

Having recited the well known, traditional views, and experience, I commend that we all continue to find better, cheaper, more reliable and effective solutions to crashworthiness for a new paradigm! I hope this symposium will help this quest. To this end, very little direct, real world crash information is available. We know some things by analysis and modeling, little by test. We may recommend consideration of a specific research program to develop factual crash information for existing equipment if such testing is appropriate.

I would like to leave you to consider, while the symposium continues, the following certain "truisms" I have learned. They are contained in 10 simple rules:

1. Weight is the enemy.
2. Where cars and equipment are similar, design is simpler.
3. Where cars and equipment are greatly dissimilar, i.e., 300,000 lb locomotives and 100,000 lb coaches, design is much more complex.
4. Reduce or eliminate human decision making or response to routine tasks.
5. Maintenance of equipment by inspection, repair, and overhaul is important.
6. Maintenance of personnel by training, testing and monitoring is important.
7. The most survivable accident is the one that did not happen. Our highest priority must be to eliminate accidents by means of APT and ATO systems.
8. Crashworthiness is always after the event - it can only seek to minimize injury and damages.
9. Safety is a continuous task.
10. There are violations of four rules of railroad operation that we repeat again and again.

They are:

Rule 1 - Don't pass stop signals

Rule 2 - Don't back up

Rule 3 - Don't back up, and,

Rule 4 - Don't back up

Detailed Risk Assessment

MR. DORER: Any questions? Any that come up we can handle in the panel discussion. Next will be a presentation on the detailed risk assessment work, and the two gentlemen presenting are Dr. Mark Snyder and Duncan Allen. I'll introduce both at this time and then handle the presentation however they plan to. Dr. Snyder has over 25 years of experience in mechanics, materials and finite-element analysis. Since joining Foster Miller he has directed a number of programs involved in finite-element analysis: mechanics, structural design, robotics, rail vehicle crashworthiness, and rail vehicle dynamics. Prior to joining Foster Miller, Dr. Snyder was a mechanical engineering consultant whose work included investigation of fatigue failures in helicopters, structural design in industrial furnaces, and development of solution algorithms for non-linear finite element analysis. Dr. Snyder holds a Ph.D in mechanical engineering from Massachusetts Institute of Technology and a B.S. in mechanical engineering from Tufts University. While pursuing his doctoral degree, he made extensive contributions to the design and development of a computer program for finite element stress in thermal analysis that is currently in use worldwide.

Duncan Allen is a principal transportation engineer and Senior Project Manager with DeLeuw, Cather & Company. A graduate also of MIT and the University of Toronto, he has been with the company for over 15 years. Over that time Mr. Allen has been extensively involved with railroad and light rail transit projects, including design of centralized traffic control, centers for Amtrak and the MBTA in Boston and SEPTA in Philadelphia, operating in maintenance planning and cost estimation for commuter rail, high-speed rail and magnetic levitation systems, and accident frequent estimation and grade crossing designs for Baltimore's central light rail line. Prior to joining DeLeuw Cather, Mr. Allen was project engineer for the IBI group on the design of several aspects of Calgary's light rail transit system and participated in the design of the reconfiguration of Toronto's Union Station for commuter rail operation with bilevel equipment. He is the author of several papers on railroad and LRT operations planning. So if Duncan and Mark will come up.

DR. SNYDER: Okay, it's a pleasure to be here this afternoon, and our talk this afternoon is about detailed risk analysis in general; specifically, we're going to talk about a methodology that we've developed for performing this type of analysis and some results that were obtained looking at the study of current intercity passenger rail operations. This was a quantitative assessment; we're going to be presenting numbers, probabilities and frequencies of accidents, differentiation by speed range, accident severity, casualties in terms of fatalities, and severe injury. This was a program that was developed by the Volpe Center-David Tyrell was our contact manager- and there were other companies involved in this project with Foster Miller.

Our team members are DeLeuw Cather, Duncan Allen; The Analytic Sciences Corporation (TASC), and SRI International. Since risk involves both accident frequency and accident severity, our talk this afternoon is going to concentrate on the frequency side; and Steve Kirkpatrick and Jeff Simons from SRI will be talking about the severity portion of the work in their talk, which I believe is tomorrow.

Now what are the key features here of this work? Accident frequency: so many accidents per year. Accident severity: what are the consequences of the accident. Combinations of the two

give you a measure of risk. The uniqueness of the work that we're going to talk about is that we are looking really- we've gone beyond historical data and we're looking at the root causes of train accidents. We've developed what we believe is a generic methodology which will allow us to look not only at current railroad operations, or allowed us to look at current railroad operations, but will also allow us to assess the introduction of new technology. And this is because we have dissected accidents and the structure of events leading to an accident and are looking at very low levels and building upwards.

Now what are some of the key components? Following on the ADL work that Dr. Bing talked about this morning, we've identified a number of accident scenarios. Scenarios are high-level groupings of accidents, such as head-on collisions or overtake collisions with trains; derailment, which is a single train event or could possibly happen as the consequence of an accident; or collisions with obstructions, obstructions being rocks, shifted loads, heavy vehicles at grade crossings. Underneath these high-level scenarios are a number of sub-scenarios.

Now we've introduced what we call basic metrics, and basic metrics are fundamental units of railroad operation that Duncan will be talking about in some detail, that really describe an exposure to an accident. The train does something: it goes past a signal, goes through a switch. Each one of these present a certain possibility of an accident occurring. And after connecting the basic metrics to the accident scenarios, we then proceeded to dissect them, if you will. And that led to the formulation of a number of event trees or logic trees, and I'll show an example of one of those in a moment.

On the accident severity side, crashworthiness of individual cars, detailed assessment of how a car behaves in an impact process. That is also coupled with modeling of complete consists in collisions, and also interior assessment of the cars: how an occupant in a car interacts with his surroundings in a train collision. And some very detailed modeling was done of an occupant and the seating and the part of the vehicle around him, and some very interesting results were obtained.

Now since these event trees were a key part of the study, I think it's worthwhile just to throw one up here. This is the event tree for no action to apply the brakes. And in most of these accident scenarios, braking is a key thing: you either brake or you don't brake or you don't brake sufficiently. And starting with the high-level event- no action to apply the brakes- we've dissected the process back down. On the left side is a case that would apply if ATP were present in this system, and on the right side is the case of what would happen if the operator failed to initiate braking when required. As you come down the tree, you'll see a number of events which were also- we developed other subsidiary models to feed probabilities into these events, so in the end we were able to come up the tree and evaluate a very specific situation, the conditional probability of the "no action to apply brakes." And as I've said, a number of these were developed and used throughout the study.

Now another key part of this study was: how do we apply the accident frequency methodology to current intercity passenger rail operations? And a composite, fictitious or what-have-you railroad car was developed, the description of one was developed, and this incorporates a number of key features. For example, there's a segment that could be described as generally representative of Amtrak's Northeast operations: dense corridor operations. There's another segment that is representative more of a nationwide kind of average. And then there's another segment which

would be perhaps or is representative of next generation high-speed rail service, say the proposed Florida Overland Express. The issues that were involved in developing this model are things like the traffic mix and density, the signal and control system equipment descriptions. And all of this information was gathered to support the accident frequency assessment. I think we'll just go right to some results at this point.

These are some model predictions. These are for the composite railroad corridor as a whole; we also have developed results on a segment-by-segment basis. And I think that you can clearly see that the most frequent accident is heavy vehicles at grade crossings. All accidents—there's a small number of accidents on a yearly basis, fractions of an accident—and the interesting thing is the second most frequent accident predicted by the model is collisions with the end of the tracks, small accidents, low-speed accidents in a terminal. Coming down the list we have derailments, track and train fault-related derailments, overspeed derailments; and then collisions, head-on collisions. And we're talking about very small fractions of an accident for a year. So to get a whole number you're going to have to scale this up quite a bit. It is definitely not kilometers.

I want to present detailed results, complete results, which include frequency and severity for two types of accident scenarios. The first one is collisions with heavy vehicles at grade crossings. So we can look at whole numbers; this is ten-year expected values. So over ten years we can expect a total of 18 collisions with heavy vehicles at grade crossings, for a total of 444 fatalities and serious injuries. Now a couple of things are noteworthy here: one, there's a cluster of accidents down at the 29- to 30-mile-an-hour impact speed range, which is probably due to the fact that trains—this is a group of accidents where the passenger trains are operating at lower speeds and there's sufficient time to give warning so braking can be initiated. The other cluster of accidents, from 60 miles an hour and above, is reflective of the higher-speed operation, where there is very little time to give warning, and so braking is either not initiated or has relatively low effect. The injuries which were evaluated using the methodology that Steve and Jeff will be talking about tomorrow were based on complete consist modeling and modeling of individual cars, and are based primarily on the head injury criterion as well as seats lost due to structural crushing.

Now the next type of accident is a head-on collision. And we've lumped together here once again ten-year expected values. These are all types of collisions between a primary passenger train and an opposing train, so lumped in here are head-on collisions with similar types of trains, commuter trains and freight trains; and once again it's a relatively rare event, one-and-a-half head-on collisions over ten years, with a cluster in the 60- to 112-mile-an-hour closing speed range. And also fatalities and serious injuries were evaluated in the same manner.

At this point I think I want to turn the presentation over to Duncan, who will continue on with a more-cover some more details of the accident frequency methodology.

MR. ALLEN: Thank you, Mark. Just to give you an overview of what I'm going to address here, I'll talk somewhat more about the structure of the frequency model as it was built up. Basically, we've discussed—and you've heard from Dr. Bing as well—the idea of the scenarios. We've divided them into sub-scenarios, as you'll see. I'll talk somewhat about the various elements of the model, as it was developed. And I'll discuss the event trees somewhat more, then discuss the composite corridor description. As we found out, and I think as all of you already heard from Dr. Bing, a lot depends on what the particulars of the corridor are. You used the word "tedium" at one point, and I think it is operative when you start having to look at the particular operating

rules, procedures, the features of the particular signal system, the traffic mix and density and other operating arrangements: there's a lot that does have to come into play to start getting a reasonable prediction of what the results might be.

MR. ALLEN: We will tell you about the composite corridor we developed its territory segments, traffic characteristics, and then spend some more time talking about the observations and conclusions.

The basic structure of the model that you saw, includes a scenario and subscenario structure which basically builds on prior work that was done, basic metrics which have to do with the unit on which the model is built, event trees and then as Mark mentioned within some of the subscenarios, we do break out the results by the speed at the occurrence of the accident what we call the primary train which is the one we are studying as opposed to a secondary train which may be the other train involved in an accident that we analyze and breaking out by the type of object impacted for various types of collisions.

The basic results for, we have 23 subscenarios and many segments, we roll those up by scenarios and segment to produce results that you have seen and the ones that we will be getting into.

Brief word on the basic metrics we have applied, these are the basic units that we kind of decomposed the operating plan or the assumptions for the railroad into a number of measures that were used. A number of things are determined on a train kilometer basis such as equipment failures which are logically associated with the operation of a train on a fairly continuous basis. We look at interlocking movements or actually or perhaps more strictly, termed controlled point movements, the actual movements of a train through an interlocking or control point.

The diverging movements, those particularly interlocking movements which actually include a diverging move where you move off the straight at a turn out, overtake movements or following interlocking movements, those are occasions where you are routed in behind a train traveling at a slower speed and in effect have to run on the signals and slow down to that train's speed. Slow orders traversed, this again is referring to particularly to temporary slow orders that may come out of the bulletin order and also to gray crossing traverse another case whenever another train operates over a highway crossing that counts as a unit of gray crossing traversal. Permanent speed restrictions traverse, again you may have civil or particular curve speed restrictions that are permanent.

Every time a train runs through one of those we actually estimated them by the amount of speed change required so that a change from 79 to 59 would be classified differently than a change from 79 to 30 or 25 for a curve restriction. A train termination, again number of instances where your corridor, train would or your train being studied would wind up in effect approaching a bumper post at a subterminal, all our terminals stations would assume to be subterminals. A number of freight trains passed and finally the number of occasions where you would be making a movement around a track lock instituted for a maintenance away purposes. Which is again in some cases may be something which is not protected through your signal system.

This basic structure of scenarios is divided into three categories pretty much as you have already heard, looking at collisions with secondary trains, that is, with a train other than the one being studied; collisions with obstructions, in this case including wayside structures, heavy vehicles,

rocks, debris. One thing we did do was exclude collisions with typical passenger automobiles and less, so we talk about collisions with heavy vehicles; we're talking basically trucks and heavier vehicles. Derailments from any cause form the third basic scenario.

When we looked within each scenario, we had a number of sub-scenarios defined: collisions with secondary trains is one of the major categories, and we divided those into, in effect, head-on collisions which include some of what FRA terms as side collisions or raking collisions-they're basically involved when an opposing train as opposed to a train you may be following, and we broke those up in our category, in our corridors, into collisions with other intercity passenger trains which were assumed to be of the same equipment type as the primary train; with freight trains; and with commuter trains, either in a push-or-pull mode.

Our basic commuter consist was assumed to be a locomotive hauled bilevel if I recall correctly, that basically had a push-pull configuration. So you're looking at some instances where your opposing train is cab forward or push-or-pull mode locomotive forward. Rear-end collisions again, we have the possibility of all of those interactions occurring as a rear-end collision, where in effect you overtake a preceding train. Collisions with obstructions: what we included as sub-scenarios there were various interactions with the heavy highway vehicles at grade crossings, one that we thought was somewhat unlikely, the overpass runoffs, as well as runoffs from parallel highways or roadway facilities.

One just happened a couple of days ago here in Boston on the Needham line-a car wound up on the tracks. It has happened on some of the normal running track off the TGV in France, and our estimated rates in fact compare pretty well with the reported rates of vehicles running off the highways or overpasses onto tracks. Also, then, rocks and debris: again, there are a lot of rock and debris accidents reported, or incidents reported, that involve impacts with very small objects. We cut it off at a point where we felt it began to present some risk of actually causing a derailment or on-board injuries. So as we get to discuss the actual accident data, again there are a lot of categories and you have to understand that there are some items that may or may not be included from the FRA accident database. End of track, the bumper post scenario, and again non-shutting equipment if you've got maintenance-away activity in a bloc that you were protecting, it is possible for a train to get in there and strike either equipment or crews on the tracks.

Derailment scenarios, we looked at a number of possibilities: overspeed through a permanent speed restriction, primarily curves, we did not look at, say, civil speed restrictions that are there for noise or other reasons; we concentrated primarily on looking at curve restrictions where there is some danger of derailment inherent in overspeed operation. Overspeed through temporary slow orders, again where a track condition that you're protecting with a temporary speed order; an overspeed there again presents the risk of derailment. Looking at various train faults and track faults, again these categories are fairly well established in the FRA database, and we've pretty much preserved those classifications. And finally, a route map line, again a situation where you may enter a turnout against a switch that is lying in the wrong way.

Key elements of the frequency model that we've talked about before again are occurrence rates for a lot of train fault and track fault. We went through an exercise very similar to what Dr. Bing outlined in terms of going down to a fairly low level in the FRA accident database and extracting in terms of speeds and types of operation and geography-looking at urban versus rural versus

suburban, east versus west, looking at rates that seem to be reasonable. We did try to look at some of the transit experience as well, figuring that that was all essentially urban, to look at occurrence rates for various obstructions. An important element was the warning time distribution, where we looked at—in fact, I think the tree that Mark showed you did talk about the various communication pathways that exist for getting word on an obstruction on the track. It may be in multitrack territory, it may be from the crew of a train operating on the other track, it may be from motorists, police—there are all kinds of possibilities whereby a dispatcher can get word of an obstruction and in fact radio the train crew other than simply coming around a curve and seeing it. So we tried to look at every possible way the information that would prevent the accident could get to the train crew in time to begin braking, a safe braking distance, or at a distance short of that sufficient to reduce the speed.

Signal braking: again we looked at a very complex event tree, we're looking at typical signaling arrangements. We basically had consideration of territories either with or without ATP features. We were looking exclusively at automatic block signal territory at this point and did not get into looking at dark territory, because we were looking at primarily a passenger train environment. And finally, the downstream secondary train locator: this is where the density comes into consideration. Clearly, while the risk of passing a stop signal may be at a certain level, the risk also is contingent on their being something protected by it downstream; and then as a function of traffic density we had a model which told us what the relative likelihood was of having a train a given number of blocks away at a given relative speed at the time of the signal overrun. So basically in all instances which were protected by dark signals, we had a model that enabled us—given the braking state of the train with its associated probabilities, given the overrun speed at the signal that was at stop—we were then able to look at the conditional probability of there being an opposing train or a train operating ahead of you downstream a given number of blocks and looking at its speed. So that's where a lot of the very, if you will, tedious computations came in; there were literally hundreds of possible combinations that were worked through spreadsheets to do this, so it's not a trivial exercise to look at even just a single track segment.

The overall structure of the model looks essentially like this: there are three major scenarios. We look at the basic metrics going on, the corridor description, and build up the accident scenarios and sub-scenarios on that basis. Two or three different mechanisms may come into play, depending on whether you're talking about a derailment or a collision. In most cases, a signal and/or braking event tree is involved, where you look at the possibility of beginning braking on encountering the first signal and following signals, which depends on the presence of ATP or not; on the number of blocks involved—one of our territories was a three-aspect borderline territory, in other words a two-aspect three-block kind of arrangement.

Fault occurrence rates we discuss briefly. The warning time distributions, again we have communication pathways. So for each of the three major scenarios, for each sub-scenario in there, one or more of the blocks shown may have been active; they were combined back into actual frequencies by segment. The results, as you may have inferred already, are very dependent on the territory assumed and the operating assumptions. As Mark mentioned, we had sort of three basic overall sub-pieces of the corridor here, from what we call City A to Control Point 470, which is kind of our major junction in the middle of a hypothetical railroad, is really pretty representative of what I call national practice. You'll see some numbers, but basically it was patterned after—in fact, it's divided into two pieces: one which has geography and terrain typical of the eastern United States, the other half has geography and terrain typical of the western

United States. It basically carries two daily passenger trains in each direction with about 20 freight trains in each direction. So for a medium-dense freight car there are a couple of daily passenger trains on it.

The branch to the south down to City C, shown in orange, is kind of almost a prototype high-speed rail operation. It's a dedicated high-speed rail at 110 miles an hour. We did assume that a number of grade crossings would be retained on there, and we learned a lot from doing that. It's not something I'd recommend, but it proved very interesting as we did it. The last corridor is where all of these services come together. The freight, at that point, basically gets off; it's essentially a dedicated passenger corridor but with a fairly rich mix of commuter and longer-distance trains operating on it as well. It's probably roughly equivalent to the Northeast corridor perhaps between Providence and Boston or between Wilmington and Philadelphia, or perhaps Baltimore and Washington—some commuter, not really intense commuter activity like New York, but an intermediate level.

What we've done there is just—I'll throw some numbers out here just to get a better sense of what these territories look like. Again, the red territory is a typical passenger territory, being a 70-mile-hour territory with a couple of primary passenger trains, 20-odd freights over most of that except in the vicinity of the downtown; and right near City A there was a commuter service, a sort of starter level commuter service at five trains a day. The orange corridor was 110 mile-an-hour with 12 trains per day per direction, no freight or commuter on it; that was the area that had the four-aspect system. And the remainder of the corridor to City B was 70 mile an hour with 14 trains per direction per day, as well as 16 commuter trains per day per direction on there. We did assume, on both the high-speed branch and the dense branch, we assumed a form of automatic train protection: basically it's a cab signal overlay, it's automatic enforcement of the cab signal aspect if you overrun a signal.

As being more representative of some of the national experience, the red corridor does not have any ATP on it. Looking at some aggregate statistics here, to give you an idea of the size of the operation on each one in terms of the basic metrics, they're roughly the same size in terms of interlocking movements, 60-odd thousand per year, about a million—one to two and change—a million train kilometers in each territory per year; grade crossings traversed, varies a bit but there's about 148,000 in the western portion of the system, only 43,000 on the high-speed, so what we did is we closed a lot of the crossings that would otherwise have existed, but we did leave a fair number of suburban and rural crossings open. We did assume only standard flasher and gate protection; there was no attempt to look at a four-quadrant or a more advanced grade crossing protection system in that territory.

Some of the results that Mark already showed you, again, had to do with rates looking very much at heavy vehicle crossings being the largest source is, in fact, grade crossing accidents. The overrun end of track, again, we're very low speed, and in terms of severity do not have significant consequences. Overspeed derailments, both for temporary slow orders and permanent speed restrictions, appear to be a fairly rich source of accident potential. The train and track fault related derailments are also major contributors; as you get down into the head-on collisions they're not so important. Shifting loads and freight trains were showing up in the top ten; even though freight trains were only operating on that western portion of the railroad and we only had two trains a day out there, they managed to get onto the list. And the head-on collision with commuter train being another aspect of concern.

A few things to bear in mind, and everybody else has provided caveats, so I have to get my caveats in here too. Expected frequency of grade crossing collisions—what we're really trying to do is go back into the model and just take a quick look at what the fact that our grade crossing collisions increased so much meant, and the sense I really felt that we had looked at both 70- and 110-mile-an-hour grade crossings. It appears that for a grade crossing with the same train frequency and the same highway traffic density, that the incidence of grade crossing collisions would somewhat more than double going between 70 and 110 miles per hour, which does fall in line with the square of the speed, although there was nothing in the model to mathematically force it to do that other than perhaps the physics of the braking model. But certainly there was a very marked increase in risk by going up that 40 miles an hour for a grade crossing with traditional flasher and gate protection.

Frequency of overspeed operation: the violations, in effect, of either the bulletin orders, the general orders, or the timetable provisions protecting speed restrictions, either permanent or temporary—that again seems to be a threat which grows markedly with operating speed, which is something we noted. Low-speed collisions with end of track were relatively frequent; some of those, frankly, were probably not reportable in FRA terms. They would be something that people in reality might not choose to report because of their low consequences.

Automatic train protection, ATP, does as you might expect significantly reduce the incidence of train-to-train collisions. When we started looking at this with a few other—there were a lot of numbers we could present and I tried to be a little selective here. This is probably the highest level of comparison here: this is looking at accidents per million train miles on passenger main lines. From this have already been exempted freight trains, yard movements; either freight-related or in terms of equipment moves to and from stations by passenger trains—this is all revenue train miles of passenger operations. And what we've done there is divide it up: I looked at the 1993-94 FRA accident base, and you do see on that bar—there is some yellow, there's a number of categories of train accidents that we did not explicitly model, that just weren't included in our framework as it's currently built. The largest number of those are in fact grade crossing collisions with automobiles, which are probably two-thirds of that yellow bar. Other reportable types of accidents which really cannot be strongly linked—I think you heard about fires and explosions, we have not got anything in there that tries to in any detail generate the possibility of causing fires and explosions. But when we look at the difference in remaining non-yellow, looking at derailments which appear in sort of a magenta, collisions with obstructions in green, and collisions with other trains in blue—overall, the very next bar over, the composite corridor in fact pretty good correspondence with nationwide passenger train operations, the big exception being the collisions with other trains being lower. And that is really directly a consequence of the assumptions that we made about the signal system, as you can see from the next three right-hand bars, which look at the three territories as we displayed them before. The one in the middle, A to 470, is the sort of typical national segment and, not surprisingly, its breakout of accidents among scenarios is very close to the national average, with a fair number—I mean, it's not a large number of collisions, but a large number of the accidents, collision with trains is significant, as you heard before; because of the severity of those accidents and the number of possible injuries, it's of very great importance.

What happens basically in the other territories is because they are under ATP, the number of train-to-train collisions goes down markedly, both in absolute terms and as a fraction of the total accidents. In the high-speed territory, C to 470, the second from the rightmost, you notice that

both the number and the share of grade crossing accidents go up markedly, again because the incidence of those collisions does increase dramatically with speed and becomes the dominant accident source for the high-speed operation. And finally, the last territory has fewer grade crossings; therefore grade crossings become a smaller fraction of the total, but there still are some in there. Collisions with obstructions becomes a fairly large component because now a lot of that track is used in urban areas and suburban areas, areas subject to higher levels of vandalism, which is also included effectively in the collisions with obstructions category.

When we move to look at what some of the differences might be between our results here and national experience, there are some points that I wanted to make there. In our corridor, again, almost all primary train movements are under ATP, which is not the case with the nationwide passenger system in the aggregate. And there were some collision types, as I pointed out, that were not explicitly modeled, particularly with some kinds of obstructions. Another difference between the composite corridor's vision of the near-term high-speed rail and proposed corridors: we did not include any improved grade crossing treatments. So we're assuming sort of state-of-the-practice; there was assumed elimination of selected grade crossings, but if they did not eliminate a grade crossing, we kept it in with standard treatment. And again, the feature does not-the train control system or even the high-speed territory we looked at does not include any automatic enforcement of either permanent speed restrictions or temporary slow orders. That is something which can be done; TGV and other high-speed lines have a feature to do that, but for the purposes of doing this particular corridor, we did not assume that that feature was active.

A few more notes on comparing the '93-'94 experience: again, we excluded from our database accidents that were still under investigation as of the time we got the data. Certain fractions that we reported for '93-'94 were estimated based on reclassification of individual accidents on the basis of the cause codes. Some of the train-handling related things we felt we could reclassify. Again, we only included some categories, most categories of accidents, but there was that yellow slice we didn't. Rock and debris collisions are difficult to sort of get a comparison on: we did estimate the fraction that we felt were causing less than \$50,000 in equipment value and we excluded them from what we reported as the '93-'94 results. So if you try to just take raw results for FRA, you'll find there are some differences in our numbers which are the results of specific adjustments that we did make.

Looking for a minute at how some of the key sub-scenarios compare within the scenarios, this is kind of an examination of the collisions with obstructions. Looking at the three or four categories that showed up most strongly in our results against nationwide practice, we basically found that since we only had freight in the westernmost portion of our system, that was the only place where shifted loads showed up as a fraction of the total, which was a significant fraction of total accidents as we estimated them there. The high-speed branch collisions with heavy vehicles totally dominated the collisions with obstructions. There was still a small amount of maintenance away, and almost vanishingly small rock debris possibilities there.

The 470 to City B, again because of the number of grade crossings in there, they really swamped all the other forms of accident in there. The composite corridor as a whole showed essentially the same shifted load fraction as the nationwide database. What didn't show up so strongly there was maintenance away activity, and rock and debris; and again the '93-'94 number contains probably a lot of impacts with rock and debris which would not be sufficient to cause injuries. And maintenance away activity: again, all our territory that we looked at did have the ability to

enforce a track block through the signal system, which is not true of a lot of territories nationwide, which is why I think that shows up as non-negligible in that scenario.

Looking very briefly, just sort of as a validation check, looking at the fraction of collisions with vehicles in highway grade crossings, I did compare the FRA reported impact speeds or accident speeds with our model, and I think we got a satisfactory basic match with that. We did not have any—I think the one difference was we did not consider any commuter trains as our primary trains, and in fact the commuter trains are probably operating or are going to account for some of what's going on around the 20-meter-per-second neighborhood. Basically our trains are either going faster than that or are in the terminal areas going slower, but there seems to be pretty good agreement—plus we have real true high-speed rail in here at 110 and there's not really any grade crossing at that speed in the national database. So basically the basic shape of the distributions seem to be a good match, and the differences that were there we felt could be explained in terms of the assumptions we make.

Looking briefly at derailments by cause in a similar way—looking at a fraction of the estimated or actual numbers—overspeed derailments being a significant fraction of the total but basically, except for the high-speed corridor, being pretty close to the nationwide; track-related, again, being generally comparable as a fraction and so I think if you took the average of our three territories it would be very close to the national, with the exception of the overspeed, which again we get into a high-speed corridor with curve restrictions and very high-speed territory. I'd suggest that automatic enforcement of those speed restrictions is probably a pretty good idea, because we did see that source of accidents growing significantly with speed.

Another quick look at the collision area there: a similar type of analysis with some significant differences there, again, which really can be related to the traffic we assumed was there. Our situation on the typical western, if you will, or long distance scenario there being a lot of the collisions are of course with freight trains; they're relatively unlikely in that small commuter territory we had, and train-to-train among the passengers actually being a fairly significant possibility. So you see, where there's nothing else operating but that high-speed branch, of course all train-to-train collisions are between high-speed trains. Looking at the 470 to City B, there's so much commuter traffic in there that in fact they account for most of the train-to-train collisions. When we take our whole composite corridor—we didn't set it up, we tried to make it broadly representative of national experience—when you add it all together, the breakout by type of train impact, it is fairly close to the national breakout.

At this point you'll be hearing more—let me address a few conclusions first, we have this one. Again, basic conclusions: We feel we have a comprehensive methodology that has been worked out for most accident scenarios. There are a few exceptions, but it does allow us to assess the collision frequency for a particular territory. One has to develop all the operating assumptions and all the basic metrics in order to begin processing those numbers, but we do have a method. Some of the unique features of that method are the use of the basic metrics; breaking down the railroad operation into eight or ten specific operational statistics; and the fairly detailed modeling of the signal and braking and warning time processes that are involved. So we feel that this is an effective methodology that can get us to the point where we can get accident frequencies out and start looking at severity as a next piece.

Some other observations there: the predictions generally agree pretty well with the nationwide experience when we combine all three of our segments together and look at the aggregate result. Collisions with heavy vehicles at grade crossings do seem to really stick out there as a threat, and that does increase substantially with speed; ATP, not surprisingly, does seem to reduce the risk of train-to-train collisions pretty substantially. At that point, with numbers on the risk, we're able to go into the severity side of it, which will be addressed by the people from SRI tomorrow. And with that thank you; I guess we're ready for questions. [Applause]

MR. DORER: Any questions before we take a break and have the panel discussion?

MR. SONG SING: I'm Song Sing from the AAR. In one of your slides where you showed 300 fatalities out of a total of 444 in the speed range of 70-74 miles an hour, and at the high speed it's a much smaller rate. In your slide you are saying all things being equal, that's how the analysis turns out. I'm just wondering, is it because when you do the regression that you don't have sufficient data at high speed now, or involving such a small...

MR. ALLEN: Let's see if we can find the slide... Is that the one? You mentioned 444, that was this one, right?

MR. SING: Yes.

MR. ALLEN: Sorry, your question again.

MR. SING: I'm just wondering what's the explanation for such a small number of high-speed versus 74 miles an hour.

MR. ALLEN: Okay, the basic reason for that is the corridor has 400 and some odd miles of 70-mile-an-hour operation without ATP out of a segment to the west; whereas all that high-speed operation at over 70 miles an hour occurs with automatic train detection lines.

MR. SING: But if you are projecting this...

MR. ALLEN: Do we have the wrong viewgraph?

MR. DORER: Grade crossings.

MR. SING: It's the other one.

MR. ALLEN: The 444 number I heard, let's go back to this one, then.

MR. DORER: He wants the other one up because the grade, you're modeling something at the lower speed; at the high speed you're likely to have more elements..

MR. ALLEN: Okay, as soon as you leave the accident frequency area, you are leaving the area where I'm best familiar with results. I think in general that the fatalities per collision, or the fatalities per collision, are going up with speed, and whether that correction is exactly what it should be or not I'm not in a position to discuss. It's the percentage of collisions; the fatalities are not going to go up with speed, because the number of collisions is different.

MR. ALLEN: Right, the absolute number. Again, to really have time to look at the situation at the lower speed, you've got two injuries for 12 percent of the accidents, you've got 42 for 35, so this is only one-sixth; here it's one, here it's more than one, here's one-half. So the severity does increase with speed, but the absolute number of accidents depends on both the severity and the frequency of accidents.

MR. TOM LEWIS: Tom Lewis, from British Rail England, again. Now I don't want to make a speech, but we're doing risk assessments in the U.K. as well, and we're doing them in a very similar way to the way you're doing them: we're trying to split down the type of accidents you can get in such minute detail and such a frequency for each possible occurrence. The first question I would like to ask is: you say you've tried to some extent to base it on historical data, but have you taken an actual line within the U.S.A. and modeled that using your techniques to see if you come up with the same answer? Because it seems to me that is the only way that you're really going to validate this model. The second question is: looking at that slide, our experience is most of our running in the U.K. is about 90, between 70 and 100 miles an hour; most of our accidents occur below 40 miles an hour. So line speed and accident speed are not related.

MR. ALLEN: Well, they're related. This is the speed at which the accident occurs, not the line speed.

MR. LEWIS: That's right, and I'm surprised that a 70-mile-an-hour track—what you have, you have three types of lines: you have high-speed lines, which are very well protected, and you have no accidents-TGV in France, Shinkansen; and you have normal lines, where you've got intermixed running, and you have quite a number of accidents, and my position would be that those accident speeds are far too fast.

MR. ALLEN: If you're talking about a British national average, I think you're taking in a lot of more or less local workings that are not in the—this is representative of intercity passenger service by North Americans; probably the average stock is 50 miles and all fairly consistent, this is a composite corridor. And your other point is that it would certainly be very interesting in modeling an actual corridor, you'd think that we'd come close to what the national aggregate rates are when we look at our aggregate corridor. Yes, we certainly would like to be able to apply that to a specific corridor of some size and see how that compares.

MR. LEWIS: I was talking about intercity lines as well. We have very few accidents for 40 miles an hour on intercity lines.

MR. ALLEN: Offhand I don't have an immediate reaction as to why that might be the case, but I know that when we compare—this is the one with the grade crossings, but again when we look at speeds that are against the national aggregate, when we look at the distribution of speeds at times referring to the aggregate of the accident, in fact we get a pretty good match. It may be that the United States has more, or North America has more higher-speed accidents than the U.K. does, but I...

MR. LEWIS: Grade crossings are easier to model. My third question is: have you discussed these findings actually with the people who operate the railways? Let me give you an example. Last winter we had a very severe winter in Scotland, and the end of track stops at Glasgow station. Our water, hydraulic water failed, and they all froze, and so we had to do a risk

assessment as to what the likely possibilities were in terms of increased accident frequency. And the risk assessment recommended that if the platform was empty at 10 miles an hour instead of 50 miles an hour, the risk would be a tenth of what it would be at 50 miles an hour, and therefore we could get away without making these buffers. All that in fact happened is you have a joint that would break later when they came into the station, so the risk is exactly the same. These are the sort of factors which when you apply pure physics and common sense you don't think about. And I would ask you if you'd actually discussed these with the operators and with drivers and this sort of thing.

MR. ALLEN: We've not got to the point of looking a details operating at that level. I think that in that particular case of the Scot terminals, there are a lot of other visual cues that you're coming to the end of the track that you probably could not explicitly model in at great detail. That's one of the sub-scenarios where I think there are some additional factors that contribute to probably lowering that rate in terms of the assumption there was essentially that you're depending on wayside signals and/or path signals to give you that indication, or in fact as you come into the station, in through the terminal area through those interlockings and turnouts and actually get onto the station track platform and whatnot, that you're going to have a much higher likelihood of recognizing that as a place where you have to bring yourself to a big stop. As far as getting down to exact points, where somebody makes a brake application of what magnitude, we've not tried to address that now.

DR. SNYDER: I'd just like to get back to your question about the distribution of collision speeds. That's head-on collisions with all other types of opposing trains, which have different braking characteristics, and since the model does have a detailed representation of the braking process at different times as the trains are coming together, when that data is broken apart and presented individually, you might see the type of relationship that you were asking about. That's an aggregate.

MR. ALLEN: A territory that might be temporarily dark, for instance; again, that's another corner of the area that we've not delved into, so again that might contribute possibly to some accidents in the lower speed ranges that might occur.

MR. DORER: The question I had probably for Duncan was given that it sounds as if you used the FRA accident data to validate the model or the assumptions of the model, could you step through one example of how you developed your accident frequency with some specific numbers? I'm kind of confused as to....

MR. ALLEN: Well, I'd have to be judicious in choosing a fairly simple one, I guess. In cases where we did have to rely on the actual accident frequency, I think some of the collisions-let's look at the grade crossing type collisions. We in fact took from FHWA a lot of detailed data on the distribution of traffic by type of roadways. So in fact what we did is look through a lot of corridors, look at the actual roads that were crossing at grade, got the distribution of the average road traffic and the speed that would be operating there, then looked for a baseline, looked at the upper edge accident crossing prediction formula to again relate that to the number of possible encounters.

We knew roughly what we expected the result to be based on the accident prediction formula. We then exorcised the model of warning times to estimate the fraction of potential grade crossing

accidents, those instances when there would be somebody-say a heavy vehicle-stuck on the grade crossing to hit, using our model to estimate the fraction of time that you wouldn't hit it because you would have had adequate warning time or it would have been cleared before the train got to the crossing. So at that point it involved coming up with our estimate; in effect, we tuned the warning time model so that it would in fact get a rate which seemed to be representative of the national accident data rate. That involved doing a lot of breaking down the FRA data into fairly small categories in terms of operating speed range and then comparing that to what the expected distribution of traffic was. So a lot of it had to do with looking at conditional probabilities.

MR. DORER: That will be covered in a report that'll be available in six months to a year, depending? It's going to be a published report. Yes. Right. Okay, I guess we're now ready for-are there going to be refreshments outside? Okay, so we have about a 15-minute break, so we could tend to back around 10 of 3 or 15 minutes from what your watch says now for the panel discussion. Thank you for all the presenters. [Applause]

PRESENTATION

DETAILED RISK ASSESSMENT

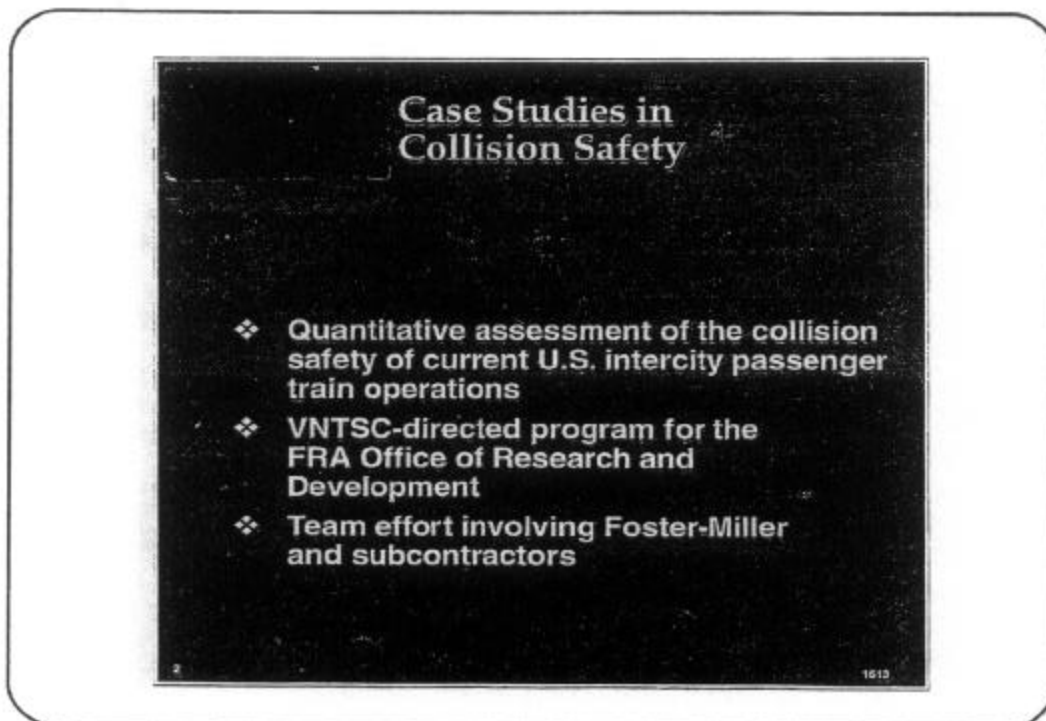
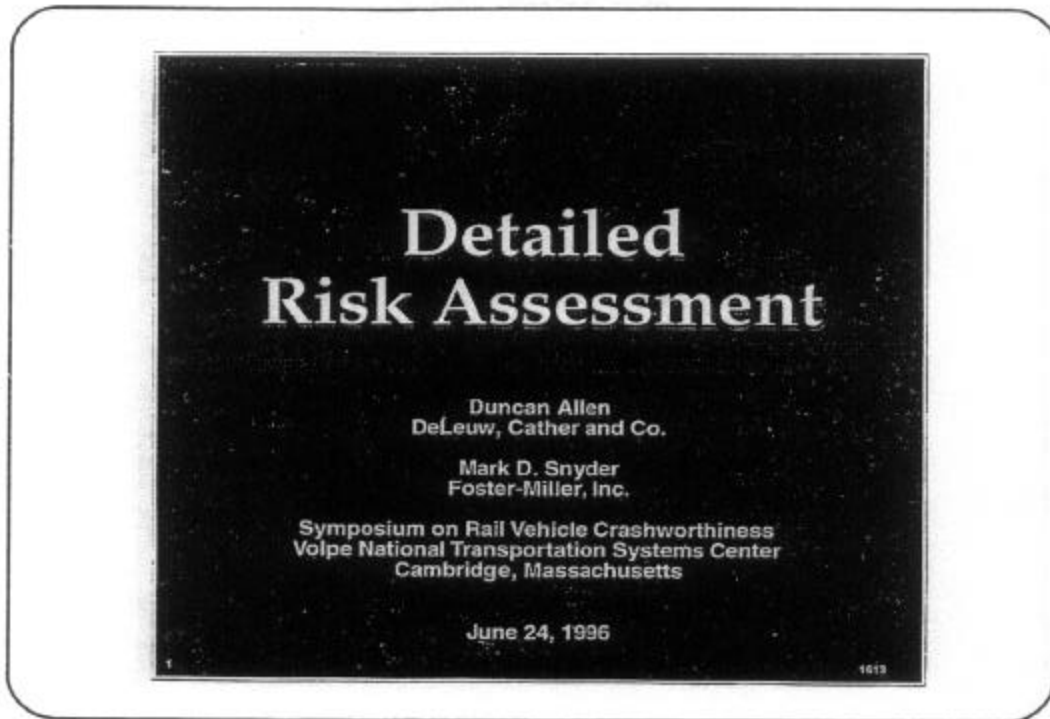

Risk Assessment

- ❖ **Combine the evaluation of**
 - ◆ **Accident frequency**
 - ◆ **Accident severity**
- ❖ **Look beyond historical data to the root causes of train collisions**

3 1613

Key Components

- ❖ **Accident frequency**
 - ◆ **Accident scenarios**
 - ◆ **Event trees**
 - ◆ **Basic metrics**
- ❖ **Accident severity**
 - ◆ **Crashworthiness of individual cars**
 - ◆ **Consistent collision dynamics**
 - ◆ **Interior assessment**

4 1613

**Key Components
(continued)**

- ❖ **Composite corridor description**
 - **Represent the significant features of current U.S. intercity passenger operations**
 - **Traffic mix and density**
 - **Equipment**
 - **Signal and control system**

5 1613

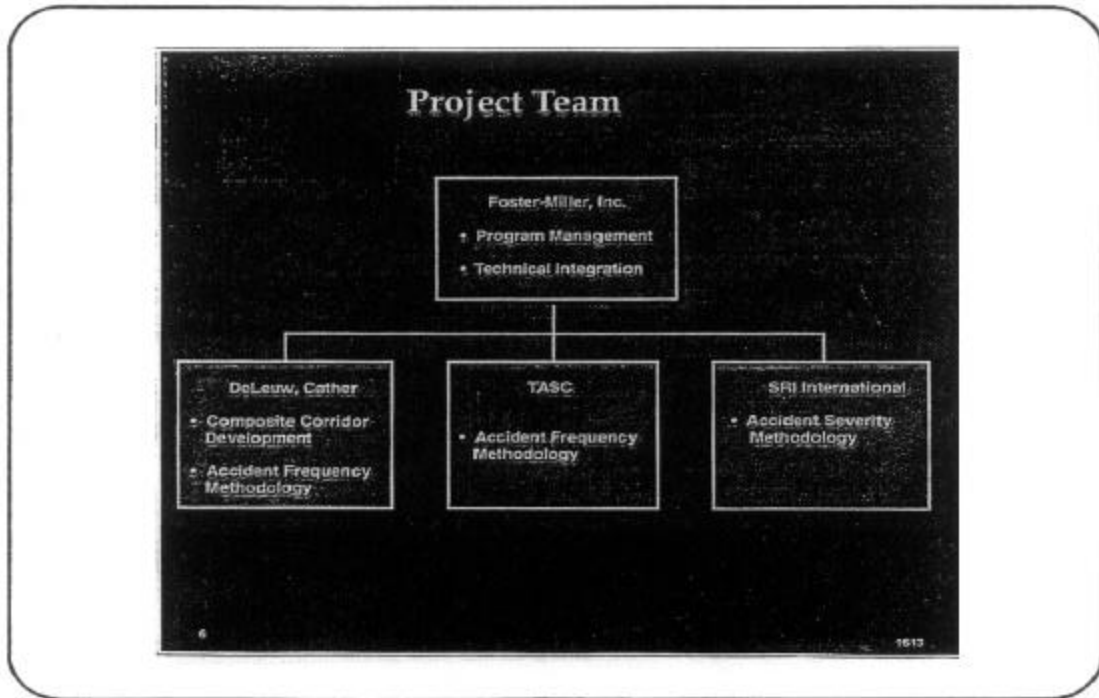

**Accident Frequency Estimation
in a Composite Corridor
Ten Most Frequent Suscenarios
(99 Percent of Accidents)**

Subscenario	Annually	Fraction (%)	Accident per Million (Train-Kilometers)
Heavy vehicles at crossings	1.80	52.3	0.390
Overrun end of track	0.38	11.0	0.082
Overspeed derailment (PSR)	0.35	10.2	0.076
Track fault-related derailment	0.30	8.5	0.065
Train fault-related derailment	0.19	5.6	0.041
Overspeed derailment (TSO)	0.17	4.9	0.037
Head-on collision with primary train	0.07	2.1	0.015
Head-on collision with freight train	0.06	1.9	0.013
Shifted load on freight train	0.06	1.7	0.013
Head-on collision with commuter train	0.03	1.0	0.0065

**Grade Crossing Collisions
with Heavy Highway Vehicles
Composite Corridor; Ten Year Expected Values**

Midpoint of Speed Range		Number of Collisions*	Percent	Number of Fatalities and Serious Injuries**
(m/s)	(mph)			
6	13	0.18	1	-
13	29	2.16	12	4
20	45	-	-	-
27	60	1.62	9	40
33	74	10.8	60	300
40	89	1.62	9	50
50	112	1.62	9	50
Totals		18		444

* 0.63 Collisions per million train-miles (0.39 per million train-kilometers)
 ** Based on HIC (full passenger loading)

Head-On Collisions with All Train Types
Composite Corridor; Ten Year Expected Values

Closing Speed		Number of Collisions*	Percent	Number of Fatalities and Serious Injuries**
(m/s)	(mph)			
5	13	0.19	12	2
13	29	-	-	-
20	45	-	-	-
27	60	0.09	6	6
33	74	0.54	35	42
40	89	0.19	12	17
50	112	0.48	31	50
66	135	-	-	-
83	181	0.06	4	6
70	157	-	-	-
77	172	-	-	-
83	186	-	-	-
90	201	-	-	-
102	224	-	-	-
Totals		1.55		123

* 0.056 Collisions per million train-miles (0.012 per million train-kilometers)
 ** Based on HIC and seats lost due to crushing (full passenger loading)

- ACCIDENT FREQUENCY ESTIMATION**
in a Composite Corridor
- Overview**
- **Frequency Model Structure**
 - scenarios and subscenarios
 - model elements
 - event trees
 - **Composite Corridor Description**
 - territories and segments
 - traffic characteristics
 - **Observations and Conclusions**

ACCIDENT FREQUENCY ESTIMATION
in a Composite Corridor

Frequency Model Structure

- Scenario/subscenario basis derived from prior work
- Basic metrics → accident preconditions
- Event trees (conditional probabilities)
- Classification within subscenario
 - speed at occurrence
 - object impacted (collisions)
- Rollup by scenario into expected annual values for estimating consequences

11 1813

ACCIDENT FREQUENCY ESTIMATION
in a Composite Corridor

Basic Metrics

- train- km(TK)
- interlocking movements (IM)
- diverging movements (DIM)
- overtakes (FIM)
- slow orders traversed (SOT)
- grade crossings traversed (GCT)
- permanent speed restrictions traversed
- train terminations (end of track)
- freight trains passed
- movements around traffic blocks for MOW (IMTB)

12 1813

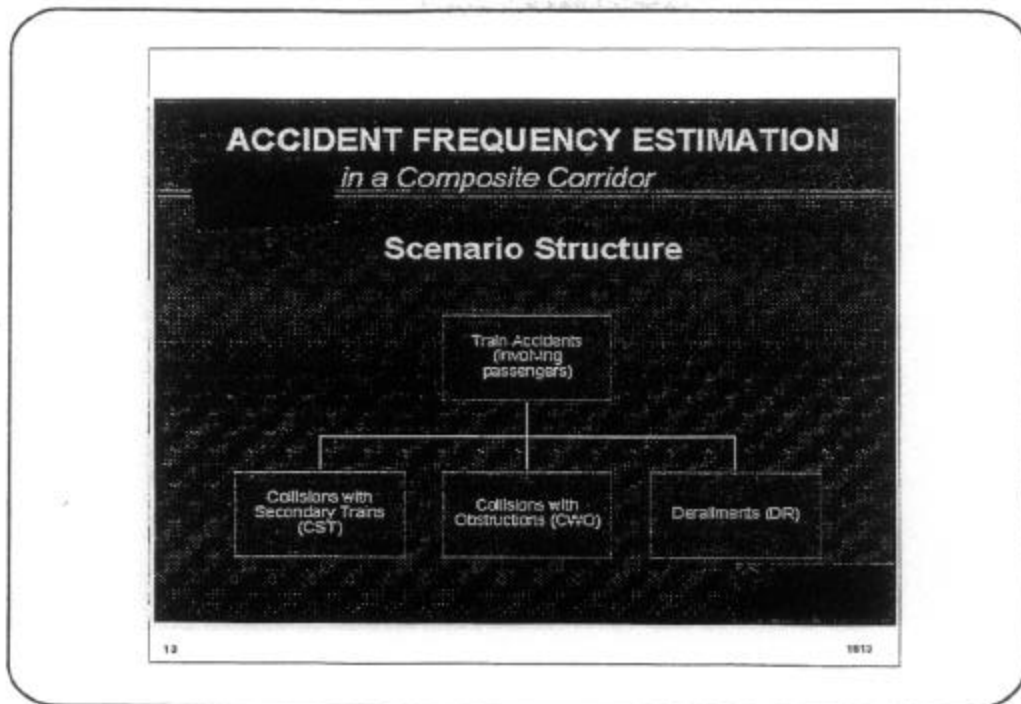

-
- ACCIDENT FREQUENCY ESTIMATION**
in a Composite Corridor
- CST Subscenarios**
- **Head-on Collisions**
 - other intercity passenger trains
 - freight trains
 - commuter trains in "pull" mode
 - commuter trains in "push" mode
 - **Rear-end Collisions**
 - by secondary train classification as above
- 14 1613

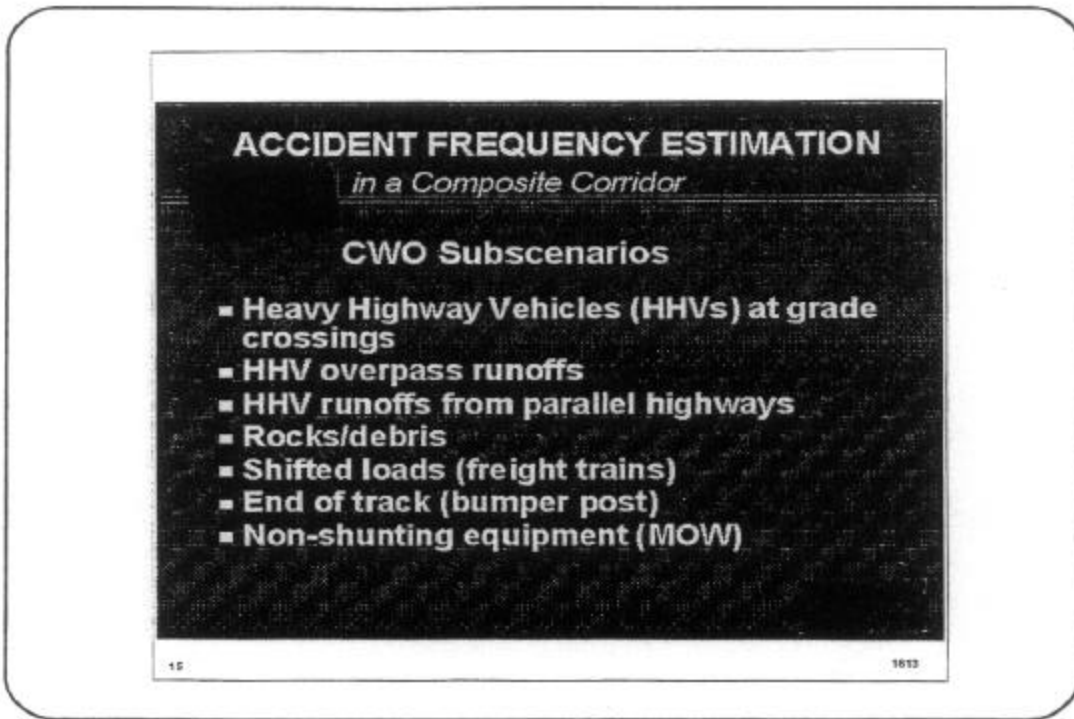

ACCIDENT FREQUENCY ESTIMATION
in a Composite Corridor

CWO Subscenarios

- Heavy Highway Vehicles (HHVs) at grade crossings
- HHV overpass runoffs
- HHV runoffs from parallel highways
- Rocks/debris
- Shifted loads (freight trains)
- End of track (bumper post)
- Non-shunting equipment (MOW)

15 1613

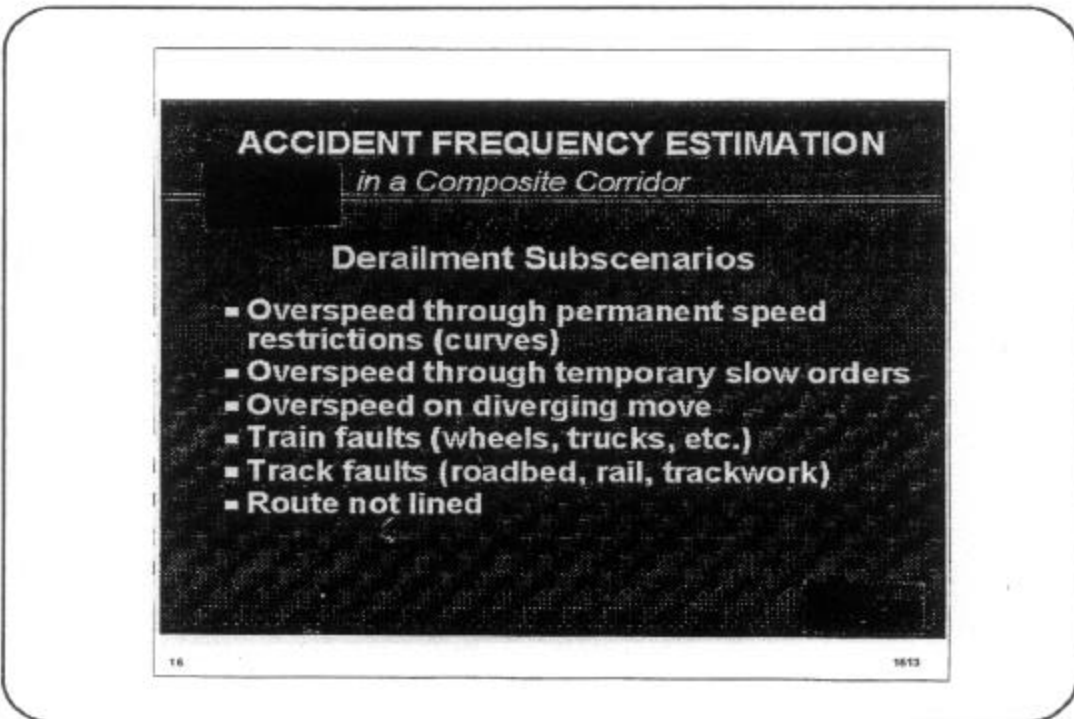

ACCIDENT FREQUENCY ESTIMATION
in a Composite Corridor

Derailment Subscenarios

- Overspeed through permanent speed restrictions (curves)
- Overspeed through temporary slow orders
- Overspeed on diverging move
- Train faults (wheels, trucks, etc.)
- Track faults (roadbed, rail, trackwork)
- Route not lined

16 1613

ACCIDENT FREQUENCY ESTIMATION
in a Composite Corridor

Key Frequency Model Elements

- Occurrence Rates (for faults and certain obstructions)
- Warning Time Distributions (for certain obstructions)
- Signal/Braking "Event Tree" for subscenarios protected by ABS (with or without ACS, ATP)
- "Downstream" secondary train locator

17 1813

ACCIDENT FREQUENCY ESTIMATION
in a Composite Corridor

The Composite Corridor

City A CP 470 City B

471 mi "national" 81 mi "corridor"

City C 144 mi "dedicated near-HSR"

18 1813

ACCIDENT FREQUENCY ESTIMATION
in a Composite Corridor

Corridor Territories - Overview

	A - CP 470	C - CP470	CP470 - B
Passenger MAS (mph)	70	110	70
Primary tpd/direction	2	12	14
Freight tpd/direction	2-22	0	0
Commuter tpd/direction	0-5	0	16
Signal System(s)	3-aspect ABS	4-aspect ACS + ATP	3-aspect ACS + ATP

19 1613

ACCIDENT FREQUENCY ESTIMATION
in a Composite Corridor

Corridor Territories - Annual Metrics

Primary Train Metric	A - CP470	C - CP470	CP470 - B
Interlocking Movements	73,701	54,351	63,032
Train kilometers	1,104,050	2,184,744	1,326,558
Grade Crossings Traversed	148,920	43,800	235,060

20 1613

**Accident Frequency Estimation
in a Composite Corridor**
*Ten Most Frequent Subscenarios
(99 Percent of Accidents)*

Subscenario	Annually	Fraction (%)	Accident per Million (Train-Kilometers)
Heavy vehicles at crossings	1.80	52.3	0.390
Overrun end of track	0.38	11.0	0.082
Overspeed derailment (PSR)	0.35	10.2	0.076
Track fault-related derailment	0.30	8.5	0.065
Train fault-related derailment	0.19	5.6	0.041
Overspeed derailment (TSO)	0.17	4.9	0.037
Head-on collision with primary train	0.07	2.1	0.015
Head-on collision with freight train	0.06	1.9	0.013
Shifted load on freight train	0.06	1.7	0.013
Head-on collision with commuter train	0.03	1.0	0.0065

- Significant Findings on
Accident Frequency**
- ❖ The expected frequency of grade crossing collisions more than doubles between 70 and 110 mph, all other things being equal
 - ❖ The frequency of overspeed operation through permanent speed restrictions and temporary slow orders increases significantly with speed
 - ❖ Low-speed collision with ends of track at stub terminals are relatively frequent
 - ❖ Automatic protection (ATP) significantly reduces the frequency of train-to-train collisions

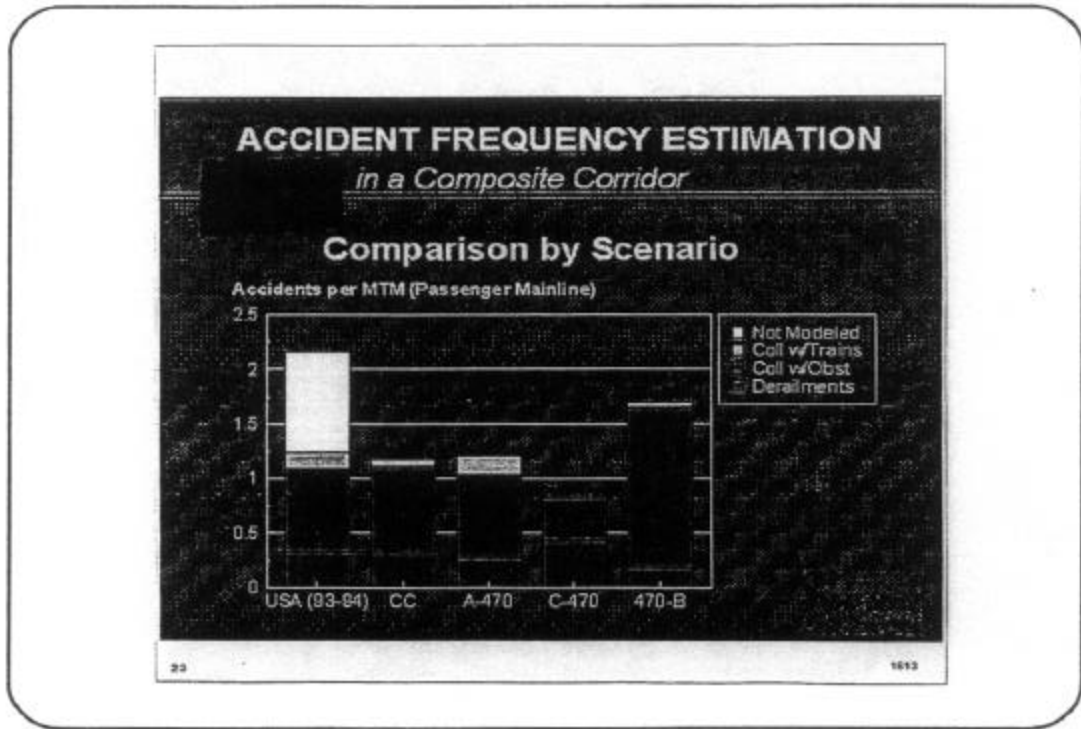

- ### ACCIDENT FREQUENCY ESTIMATION *in a Composite Corridor*
- **Differences Between CC and National Experience**
 - most CC primary trains move under ATP
 - some collision types not modeled
 - **Differences Between CC "near- HSR" and Proposed Corridors**
 - program to eliminate/upgrade grade crossings was limited to closing selected crossings (No improved treatments included)
 - no automatic enforcement of permanent speed restrictions or temporary slow orders
- 24 1613

ACCIDENT FREQUENCY ESTIMATION *in a Composite Corridor*

- **Notes on Comparisons**
 - "USA 93-94" represents FRA-reportable accidents involving passenger trains in mainline operation
 - accidents under investigation were excluded from scenario-specific comparisons
 - certain fractions for "USA 93-94" were estimated based on sample data and/or reclassification of individual accidents based on FRA cause code
 - comparisons of fractions include only the accident subscenarios which were modeled
 - rock/debris collisions causing < \$50 K equipment damage were excluded from "USA 93-94"

251613

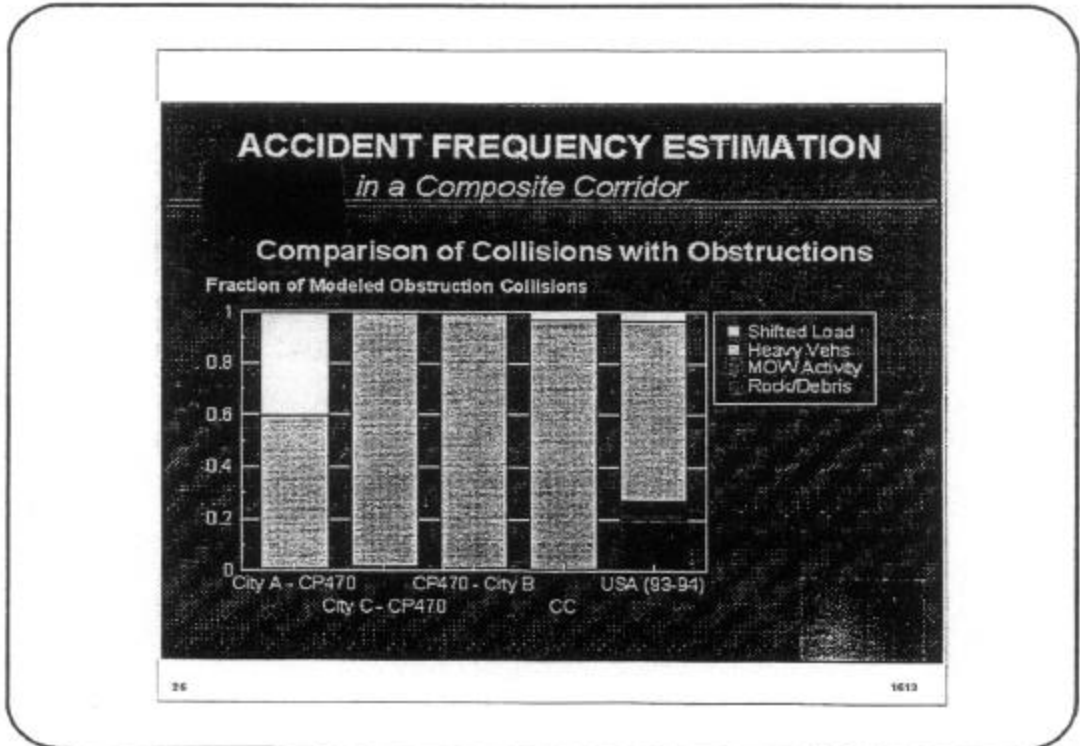

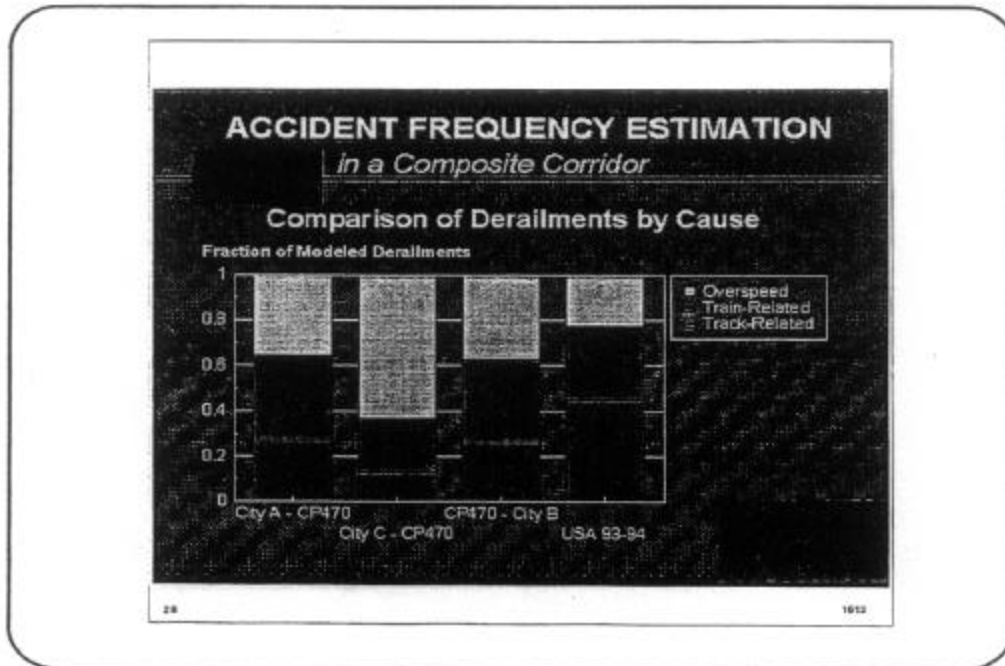
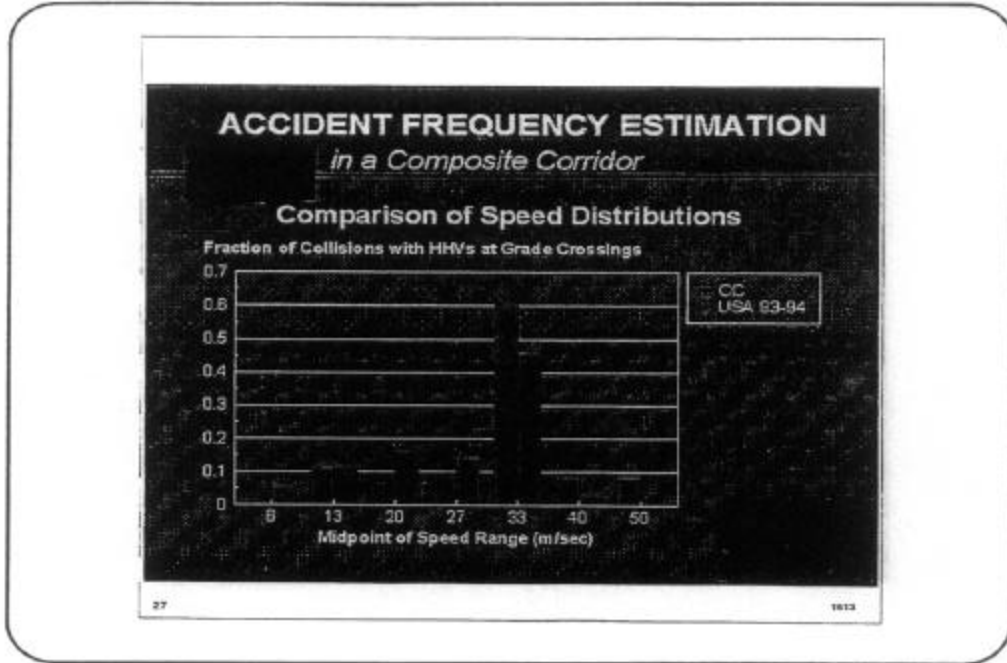

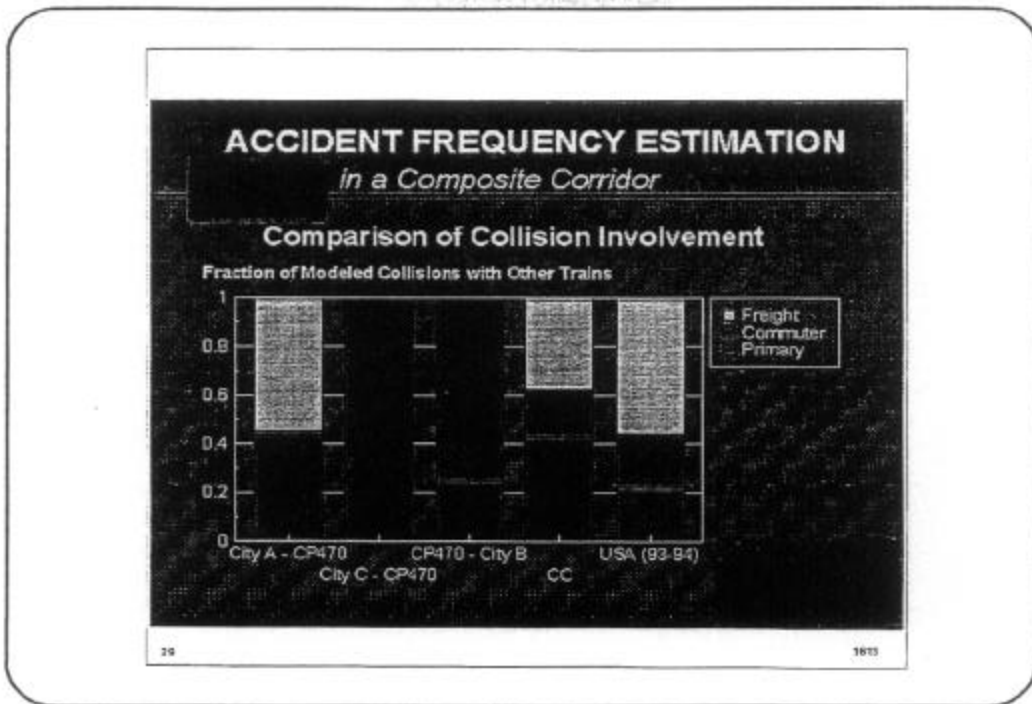

- ### ACCIDENT FREQUENCY ESTIMATION *in a Composite Corridor*
- **Interface to Severity and Risk Estimation**
 - annual accidents by subscenario
 - speed distributions by subscenario
 - territory characteristics by segment
 - characteristics of secondary trains
- 39 1613

Collision Risk Panel Discussion

BOB DORER: We have in addition to the panel a member you haven't heard from yet today. Well, you've heard from him, but he hasn't been formally introduced. That's John Bell, who's program director of High-Speed Train Sets at Amtrak. And he's responsible for directing all aspects of the acquisition and design of high-speed performance train sets for service on the Northeast Corridor. Prior to joining Amtrak, Mr. Bell worked as a consultant in the areas of Corporate Strategy, Transport Operations, High-Speed Rail Planning and Implementation, Transportation Networks, Organizational Assessment, Contract Management, and Privatization Planning, both domestically and internationally. He's also been Vice President and General Manager of the Buffalo and Pittsburgh Railroad, and Terminal Superintendent for the Southern Pacific, and even a maintenance foreman for the Mongehela Connecting Railroad. And he was a Strategic Planner at Conrail.

Mr. Bell received a Master of Business Administration from Harvard Graduate School of Business Administration, and a Bachelor of Science in Civil Engineering from Carnegie Mellon University. He is currently active in the American Railway Engineering Association and the Transportation Research Board.

So I think what we'll do to start things going, I'd like to offer the opportunity for the various panelists and presenters to fire a few questions to each other, and then we'll open it up to the floor. So, does anybody have a first question? If not, we can always open it up to the floor and the questions can be fired later.

JOHN BELL: I'd like to toss something out to Frank that we didn't ask before. I'd like him to elaborate on the similarity of design issue that he started on. I think it's one that deserves a fair amount of discussion beyond the simple point that he made. And I'll start by saying I'm in general agreement with the concept.

FRANK CIHAK: Well, the more differences that are required to be compensated for by design features, obviously the more complicated things get. In our business, the units of mass here are vastly dissimilar between locomotives and passenger cars. Where in rapid transit, where the cars are essentially self-propelled and all weigh about the same, it's much simpler. And I think at the end I said that where design becomes dissimilar, our problem becomes much more difficult, and we should therefore seek, when we particularly when we design or contemplate changes, we need to carefully consider how a changed vehicle that is going to operate with other ones, what the effects of those changes are.

BOB DORER: Well, let's open it up to the floor. Are there any comments, questions that people would like to propose? Yes?

STEVE SOLTIS: I'm Steve Soltis with the FAA, and I'd like to echo that comment, that similar designs make a lot of sense. And one of the ten summary points I think that was presented by Mr. Frank Cihak I believe was the name, one was he made a comment that crashworthiness is after the event. And I hope that's understood what is meant by that. And it's not considered after the event. Crashworthiness should be considered up front in the design, and trying to keep the crashworthiness aspects similar. It was mentioned in the CTA cars there's a lot of thought given

to crashworthiness in the initial design; I think it proved very successful. So in the initial design stages, you can get a lot for your money when you're considering crashworthiness.

FRANK CIHAK: What I meant about crashworthiness after the event meaning that the operation of those features only occurs after we've had an accident. And I want to emphasize that we should be preventing accidents from happening first, and with our highest priority.

STEVE SOLTIS: I agree with that. I just wanted to make sure that after the event is understood. It's that inner concentric circle that was presented by one of the other presenters.

FRANK CIHAK: That's the last line of defense, not the first.

RON MAYVILLE: Ron Mayville from Arthur D. Little. We've heard this morning, or all day, I guess, the accident information and risk analysis. What I haven't heard yet, which I was kind of hoping for, is how we'll use all that information to design for crashworthiness. In other words, now that we have that, what scenario or what conditions do we choose for designing crashworthy vehicles. For example, I think we'll hear tomorrow morning about the use by British Rail Research of the 40-mile-an-hour closing speed collision. And I'd like to hear some comments, I think, from the panel about that.

JOHN BELL: To paraphrase a little bit of the work that ADL did for Amtrak a year and a half ago, this is the study that Alan was quoting from. It was used to identify how much of the risk had been mitigated by investments in signalling systems and upgrades in track and structures, to offset the risk that had been created by higher-speed operations and a higher density of operations. Alan made a comment that I hope you'll pick up on, that in the end one of the major conclusions was it was the density, not the speed that was driving the risk in the corridor. Because at the time, we were doing the analysis around the projected operations in 2010, which included such things as I believe almost a doubling or a tripling of the MBTA operations, a significant Connecticut shoreline operation, the P&W projections based upon their most optimistic forecast: all those were getting dumped into the density, and that density was driving risk up and the risk was requiring greater mitigation. Over on the environmental impact side, the same thing was going on. That density was driving controlling noise, controlling vibrations. To the extent that we project growth, we project risk, or project problems. And Alan, if you want to pick up on the density question?

ALAN BING: Yes. I'd like to actually add a couple of things to that. Firstly, one of my feelings is that density is very important. The higher the density, the more exposure you have to potential errors or failures causing or leading to an accident. I don't think that has been examined enough. I think Fosterman and their colleagues got into it to some extent in the most recent presentation, but it deserves a lot more effort. That is not answering Ron's question, which is, "What do I have to design for?" I'm afraid my answer, at least at this stage in all that I and other people have looked at things in a similar way have done, is we don't know yet.

What we can do is jointly work through an assessment of different crashworthiness strategies, how much they might cost to implement, and how much benefit you get out of them. We on the risk assessment side can certainly tell you, if you can give us this performance, here's the benefit. And we ought to examine two or three alternatives of those and home in on the one that seems to offer the best compromise between benefit and cost. And the best way of meeting our overall

goals. Because I don't think there's any one performance requirement we can say, "Here, you must insure survivability of this kind of accident at this speed, and then you've done it." I think that's something to work towards, but we can't tell you what it is today.

DUNCAN ALLEN: Mr. Cihak remarks at one point did not seem to spend a lot of time talking about the track and equipment-related derailments, which are a factor but again don't necessarily result in quite the same severity or injury impacts. What it appeared to us to look like is that looking at national rail statistics as a function of density, across the board, the collisions are a fairly small fraction of accidents, but that does seem to grow noticeably when you get into the 40/50/60-train a day neighborhood. This is on the railroad side. And my guess is, and maybe Frank would comment on this, that when you start talking about rapid transit at 150 or 200 or 250 or something, that collisions become a much more significant fraction of the total?

FRANK CIHAK: I don't know if I ever looked at it that way. I don't think you can tolerate many collisions on a rapid transit line, even if it runs two or three hundred train movements a day, which rapid transit operations do every day. You just can't have lots of those.

DUNCAN ALLEN: Well, yes, I'm just curious about the derailment-to-collision ratio in the sense of its....

FRANK CIHAK: Well, rapid transit tracks are in pretty good shape, and derailments, other than those which occur in yards, are almost unknown.

THOMAS PEACOCK: Ron, back to your original question: How do we use all this stuff to change designs to make improvements? I think we have a credibility problem in that if you say build a passenger car so that it has a 800,000 pound end strength, that's pretty easy to verify. You just squeeze some substructure 800,000 pounds and demonstrate it. When you give them a requirement that says, "Keep the passenger acceleration to some level in a certain accident scenario in the occupied compartment of the train," how do you prove you've done that is a problem. And you can run a model, put together some of the models that people here have developed, and it shows, yes, the acceleration of the passenger in this high-speed collision was less than some head injury criteria, but there's a lot of people in the railroad industry who are from Missouri, and they don't believe the models, and it's a show-me kind of situation we're in. And it's a hurdle we need to get over, I think, before we can really make use of this kind of information. Is if you can't do a simple test to demonstrate it, we don't want it. If you have to go through a lot of analysis that's too hard to do and we don't necessarily believe it, is the problem in this industry.

DUNCAN ALLEN: Tom, you kind of beat me to the punch here. When Ron brought up the issue of what do you design to in your talk this morning, you were talking about a proposed structural design basis for passenger cars. Could you talk about what the status is of that? And what that will be based on? Because in effect, won't that govern future car designs?

THOMAS PEACOCK: Yes. Just recently, within the past week or so in the Federal Registry, there was published an advance notice, and it discusses the proposals the Federal Railroad Administration made and the fact that an industry group has been put together to take these proposals and try and modify them to make them more tolerable to the industry. We have two efforts ongoing right now. One is for high-speed trainsets, over 125 miles an hour, and working

largely with Amtrak. And it looks like the requirements will kind of track Amtrak's system specification with their builder. It'll be based on that. That's where the high-speed requirements will come from.

The requirements for the more conventional equipment that travels at slower speeds probably is going to be based on some of the work that AFTA is doing to develop industry standards. AFTA, over the last month, has been working real hard. They kind of owe us right now a response; when we put out our proposal, they're going to make a counter-proposal, and we'll probably negotiate from there in these passenger working groups. But I think by September or so, these things need to be nailed down and starting to get into the notice of proposed rulemaking phase of the process we have to go through.

BOB DORER: Yes, Herb?

HERB WEINSTOCK: Herb Weinstock, Volpe Center. And Ron had a question that people keep on posing: What is it I have to do? And that's really not necessarily the question. The first part of the effort that we started to describe was the question of, "Gee, if we leave things the same, or we leave things with these representative systems, how many people are we going to kill?" If this becomes a horrendous number, that's definitely unacceptable. The other side of the question becomes one of, "What is it that we know how to do? What is it that we know how to design for?" So in terms of what the English had done was, "Here, I've got a design that will make the 40 miles an hour. I've done my risk analysis, and lo and behold, the accident history. I've saved, in theory, most of the people I would have killed. On the other hand, it cost another nickel or another ten cents per, and they could have handled a 50-mile-an-hour closing speed with that ten cents if they knew how, they would have done it." The challenge on the design side, or the question on the design side is, "Where are the limits of what we know how to do on design?" On the risk analysis side, "How important or how imperative is it that we get a design to achieve it?" And both elements have to keep working together and have to keep going back and forth. So if I tell you that it costs us a dollar to increase the speed survivability from 40 miles an hour to 80 miles an hour, you're going to say, "Herb, go spend the money." If I tell you that it's going to cost you twenty billion dollars, you're going to say, "Go away and don't bother me." But what we need is the information. And I'm hoping that our participants tomorrow will be able to tell us a little bit more in terms of what's doable in terms of design. And how far away, what the engineering uncertainties are, and what the engineering possibilities are.

HOWARD MOODY: Howard Moody from the AAR. This is to any from the FRA. Are you doing a risk mitigation analysis with any of your NPR analysts? In other words, are you falling in the same trap that you fall in when you come from the other direction of your performance standard you were talking about, in that you are proposing a standard without knowing what the risk is that you are building?

GRADY COTHEN: Probably, Howard. On the other hand, we are funding most of this research that you're hearing reported from the point of view of the U.S. R&D community. Specifically, for the purpose of understanding the context in which we are regulating, providing tools to conduct such analysis. We were at the center last week looking at an analytical tool with regard to distribution of collision risk on the national rail system; we'll be back on Monday.

I think that another point, perhaps, that's pertinent, is that risk assessment is useful to the extent that it refines one's understanding of hazard. Unfortunately, when you look at the issues of national applicability, we have adequate epidemiology to be able to predict risk from prior outbreaks on a gross level. More difficult issues come when we start varying our assumptions, as was the case down the North End with Amtrak, where reasonably sophisticated work was done to look at what happens when we start varying those assumptions. We have those opportunities, if we have the tools available and they're well-honed, to do similar analyses in other situations. And we will.

To me, one of the benefits of this kind of work is to have pointed out from a number of different directions that the risks are manifold and one can isolate them, determine whether they can be dealt with or not independently, as opposed to with regards to the subject matter immediately at hand. And so, you can look at what the opportunity cost is of not making an investment over here.

Amtrak, when it looked at the North End, immediately said, "Thank goodness we've already determined that we want advance civil speed enforcement, for instance, and positive stop features in that territory where the densities were going up." And that decision had been made before the risk assessment was done. But the risk assessment very clearly pointed out the wisdom of that decision. It also pointed out the congestion in terminal areas, and as the planning goes forward, Amtrak knows that it has to focus on discipline in terms of terminal operations, and Amtrak knows, FRA knows that it has to follow-up.

Another pertinent comment, perhaps, is that whoever gave FRA the ability to consider overall risk anyway? FRA has been under the gun with respect to one statutory mandate or another, essentially since Chase, Maryland. And one of the difficulties with regulating in this environment is that you're taking the next project in line based on the statutory deadline that's coming up, rather than stepping back and looking at, on a systems level, what should we be doing. Again, I think the good news is that we're hopefully assimilating some of the learning that's being generated by the research. And as opportunities present themselves, we'll be able to act responsive to that information, positive train control being one of the areas that may or may not at some future time be ripe for mandatory action from the standpoint of a regulator based on benefit cost analysis.

That's a lot of talk, Howard. Did it even respond at all to the question you asked?

HOWARD MOODY: I just wanted a yes or no! [laughter]

GRADY COTHEN: Yes. You know better than to ask me a yes-or-no question, Howard!

GEORGE NEWMAN: George Newman from the Brotherhood of Locomotive Engineers, the Massachusetts legislative board. And I'd like to convey the greetings and regrets of our Vice President, Leroy Jones, who had another commitment. And I'd like to applaud the efforts of everyone here to make locomotives and control cars crashworthy, because that can save the lives of our members. We concur that prevention of accidents is certainly the first line of defense; let's try to eliminate these accidents before they happen.

In line with that, the BLE has long advocated safety measures such as positive train separation. We've advocated looking into the work/rest cycles of locomotive engineers. Fatigue is a major incident in many of these accidents, a major factor in many of these accidents. As you said, Mr. Cihak, it's rarely one event that leads to an accident. There's a human being at the throttle, for some reason, no locomotive engineer sets out to roll by a red signal, or to plow into the rear of a train ahead of him. There are other factors involved.

Fatigue is one major factor that has to be addressed. The Canadians are a step ahead of us in this regard; they've done a great study recently on studying the work/rest cycles and carrier calling procedures for freight pool engineers. And they even set up a division where they implemented a whole new set of operating rules, where they allowed crews to pull into sidings to take rests. They could radio ahead to the dispatcher and say, "Gee, I think I need a little nap," and they'd allow them to take a little nap. You know, innovative procedures such as that....

But again, it's been said that the human error seems to be a major factor. And we'd like to eliminate everyone of those. Those are our members, their families; we represent them. We don't want to see anyone hurt ever. But let's, we urge the industry and the FRA to help us give the locomotive engineer all the help you can give him. We're all human, we all make mistakes; unfortunately, when a locomotive engineer makes a mistake, he's either killed or maybe there's serious property damage. So but we applaud your efforts, and we'll pledge to work with you any way we can. But we're not bad guys; an engineer that rolls by a signal is an unfortunate character. Let's try to see that doesn't happen.

FRANK CIHAK: I'd just offer two comments in response. First of all, thanks very much for stepping forward with those remarks. Secondly, FRA has on file a petition from the Brotherhood to deal with the issue of signals and train control, particularly with respect to redundant or additional approach signal and traffic control territory consideration of positive train control systems. And I think that it's no secret, it should be no secret that that's an issue very much to the fore of the Federal Railroad Administration. Fatigue issue as well; we were instrumental in getting an authority for pilot projects into the 1994 legislation that would be similar to what's been done up in Canada. And indeed, one of the eastern roads is considering using the same consulting outfit that's also done work for us, that did the Canadian work, along with the operating employees and railroads in Canada to do a pilot project in this country under operating conditions in the eastern United States. And we encourage that.

And then, finally, as we move this discussion forward over the next two days, what if, best efforts notwithstanding, we do have an accident which can certainly occur today in cab signal territory, with automatic train control, particularly where there's a derailment on an adjacent main and engineer rounds the curve and there's an obstruction in the way, or rounds the curve and there's one of those lowboys on the grade-crossing. One of the big issues, probably the \$64,000 question here in terms of how much further we ought to go, is a question regarding the degree to which we can instill confidence in employees in those last resort situations, that the crash refuge being provided is one that's reasonably secure, taking into consideration the crash exposure, the threat of fire from diesel fuel, and any other factors that may obtain in that scenario. If you can't convince employees to stay in the cab, there is no reason to spend enormous amounts of money improving that cab. And I mean, I don't know the answer to that question, and I do know that we will not come to an answer to that question without very careful consultations with railroad

operating employees who live and work in that environment every day, and incur these risks on our behalf.

BOB DORER: No additional questions?

STEVE DITMEYER: By asking a question, that means I don't have to answer it. I asked a question earlier about national differences, national statistics. And I guess that remains an issue that is of some concern to me. Six months ago I visited Japan, and meeting with people from JR West, they said to the FRA administrator Molitoris and myself, "We are putting our money into crash avoidance techniques," and by crash, that would be both collision and derailment avoidance techniques, "rather than putting money into crashworthiness and other effects, other items that would mitigate the effects of accidents and derailments." We know that over in Europe, the UIC standards for passenger equipment are less stringent than those in the United States. And again, I'll throw over to the panel of experts over here who gave presentations today, the question, "Is it the severity of the accidents that's different in these countries?" "Is it the frequency that's different?" "Is there a matter of national attitudes that has an effect on these different approaches?"

I will end my comments by saying that I was for many years an advocate for having lighter-weight passenger cars; cheaper to build, easier and cheaper to operate and so on. However, at the Chase, Maryland, accident, the son of a good friend of mine was in the lead coach. He survived, simply because that car was built very solidly and withstood the crash. So I have backed off my strong feelings on this, but yet, I still wonder about the national differences. And would any of you care to address that?

DUNCAN ALLEN: Well, let me jump in. First, I think some people who are involved in other countries probably have their own observations. As we've said before, you brought up both factors, there's multiplication involved. So whenever you have a risk times severity, they both, small changes in each, depending particularly when they're both fairly small numbers, can have dramatic differences. I think there has been very definite differences in the sort of national psychology or approach. What I find very interesting, my guess would have been, up to a few years ago, that on average, Western Europe and Japan were putting more of an investment into track inspection and other areas which would reduce crash risk. And I'm curious whether there's a perception now, as we move towards separating those former National Railroads into business-like operating units, some of which they're dealing with maintenance away and some of which are doing maintenance of equipment, whether that is likely to change.

ALAN BING: Could I just leap in and make a few comments, having observed, certainly there are similarities and differences between Europe and North America. I cannot speak very much about Japan. Certainly, based on the numbers, the safety performance of passenger railways or railroads in North America and Europe are not dramatically different from each other. The risk you face as a passenger riding in certainly anything other than a dedicated high-speed line, or a train on a dedicated high-speed line, in recent years has not been terribly different. I think it's true that there was a focus in Europe on automatic train protection and similar systems. Those systems are expensive, as I think my former colleagues in Britain have found out. And what's more, accidents, particularly in the U.K. and France, have focused attention on crashworthiness, the TGV that hit the large piece of machinery on a grade-crossing and the Clapper Maximate in

the U.K. both resulted in much greater focus on crashworthiness in those countries, despite a sort of prevention orientation.

And I think the lesson in that for all of us is that it's very hard to eliminate accidents, and at least some measure of effort has to be devoted to crashworthiness, the survivability part of the equation. I also suspect, and I think this is where Steve is coming from in his former life with the Burlington Northern interest in ATCS, that the capabilities of electronics in communications are sooner or later going to make the prevention a whole lot easier. I think the industry leaped into it a few years ago thinking it was probably going to be a bit easier than it turned out to be. But that doesn't mean a second look in a few years' time might yield much more effective results. And I think the industry's beginning to head that way. With great benefit to all of us. I don't know if that helps to talk to your comments at all.

BOB DORER: I have a rather specific question that maybe will help spur the discussion on risk trade-offs versus crashworthiness. And I'll use an example, and if I don't have the facts exactly right, please correct me. Talking about the American Flyer, and if I understand correctly, it is now designed, or to be designed, with high-platform exits only. And that has to do with the structural strength at the end of the car. That obviously has implications on emergency, not necessarily preparedness, but emergency response, if you need to evacuate the train. I'm not saying it's easier or harder, but it's different.

During that cycle between an operator and the regulator, was that risk trade-off made, or was it just sort of, how was it made? It obviously was made. And do we need to make progress on making that kind of a risk trade-off more understandable and trackable for future efforts?

JOHN BELL: I'm not sure I envision the use of trap doors as part of an emergency egress system. In a true emergency, the instructions are to open the door and to depart the train. There are no instructions to open a trap door, so the two are unconnected.

THOMAS PEACOCK: The aircraft industry has an emergency-preparedness requirement that the aircraft has to be evacuated in, I think it's 90 seconds. In the railroad industry, we say it has to have a certain number of emergency exits. We had some discussions that maybe we should go to a performance-type requirement that the entire train has to have enough exit capacity to be evacuated in some minimum time. And that minimum time maybe should be tied to some kind of a fire-prevention or fire-resistant capability of the train, that if the material in the train is designed to withstand for 60 or 90 seconds some heat level. We had discussions about maybe this is the way we should be going. We haven't specifically done it yet, but we've talked about it. But maybe rather than just requiring four window exits, four window emergency exits, we ought to say, "You, Industry, design the exits, but show us you can evacuate your train in 90 seconds, or some other reasonable time."

FRANK CIHAK: The NFPA 130 requires the floor to be resistant to pretty substantial fire-loading for 30 minutes. So that's essentially cars that don't have any fuel other than the electrical components. So I'm not sure that an evacuation time when the major separation is built into the car of 30 minutes, makes a lot of sense to me. Ten-minute evacuation for a car shouldn't be any problem with one exit.

JOHN BELL: As was pointed out earlier, where are you going to evacuate to? Because all too often, these incidents occur in settings where the evacuation of the train is the last thing you want. You may want people to move to adjacent cars, which is Amtrak's first instruction. So to make it too simple and too direct to egress to an adjacent live track or off of a structure is really not a controlled egress at all.

GRADY COTHEN: Just to punch it once more, since I have to answer this question in Silver Spring on Friday, maybe I'll get a head start. Again, our experience in looking at some of these accidents is that very often, the method of safest egress is through the train to another unit of the train, that is in a more secure location. One of the issues raised by NTSB was situations where passageway doors are inoperable. And we think that's a legitimate question to raise. They've suggested either kick panels or glazing that would be easily removed in a dire emergency where the normal means of egress fails to function or egress to that location wasn't appropriate. We think that's worthy of exploration, and are encouraging APTA to, in fact, explore those options along with us. As long as we're talking about passageways through the train. The issue of quick-release on automatic doors is also worthy of discussion, and along with that, an appropriate packaging of those releases so that they're not used casually by passengers. And we're also in active discussion about that, and will be for the next couple of months, I think.

BOB DORER: I guess that was a bad example question, given that you dismissed it immediately. Maybe a more general question, from the process of balancing risk versus crashworthiness, do you have any lessons learned for future endeavors in that area? Because obviously decisions were made.

JOHN BELL: Who is that question directed to?

BOB DORER: Anybody who would care to... I'm just thinking that the most recent example we have of experiencing this effort to first try to deal with risk and mitigation and different creative ways of dealing with the design of the train set was the American Flyer. There are some good experiences and probably some good lessons learned as to how to proceed.

MARK SNYDER: Well, I see some gentleman from Bombardier in the audience. Perhaps they might want to make a few comments? [laughter]

BOB DORER: While he's coming to the mike, I'll say there's one thing we should do, and that's start earlier.

FRANK DUSCHINSKY: Frank Duschinsky from Bombardier. Maybe I will answer the question with a question. And basically, we've seen a number of presentations where pieces of puzzle were presented, but somehow I would say it was missing the clarity what we see in, for instance, from our English colleagues or French, where the logic is relatively simple: you do the study of historical data, and evaluate it, come to some conclusions, and eventually get on with certain levels, and experimentally prove it or don't prove it, or whatever. But as an end result, there is a certain level of crashworthiness which is tested, and it is not really a law, but it is a rule or a regulation.

For the American Flyer, the specification tried very hard to bring some clarity into this process. And I think that was appreciated, and we're going to discuss about it tomorrow. The question

would be: The studies what were presented just before, what are the conclusions? And what are the scenarios and what would be the approach one would take? And what would be the logic, for instance, to decide what to do for Tier One and what to do for Tier Two? I don't know if somebody will take it?

ALAN BING: I'll try and say few words. Probably the study that we did for Amtrak on the North End of the Northeast Corridor was the, if you like, the most directed effort in risk assessment that's been done recently here. And there we did deliberately set out to compare conditions as they are today and as they would be with the proposed high-speed train service and other changes to the corridor. Compare the risks and say broadly what you had to do to make sure that the safety performance of rail service on that corridor was at least as good, if not better, than the existing service. And that did show that a certain level of crashworthiness improvement, plus all the other improvements that John Bell mentioned to us a while ago, would, taken together, produce this desired result. As far as I am aware, that kind of study has not been done. Certainly a lot of people have worked, as colleagues here have, on methodologies, and have done studies on hypothetical corridors, and I've done some myself, but have not looked at the real world, said what performance are we aiming at and what are the alternative ways of getting there? And that seems to me to be something we collectively ought to do. We've got, I think, some fairly good tools and methodologies now. We have not spent a lot of time using them in the real world. And as Grady mentioned earlier, given the mandates imposed on the FRA safety regulatory process, it's kind of difficult for that to get into the regulatory process. I think maybe what we should do is work towards making risk assessment the respectable way to go, or at least an accepted contributor to working out what safety requirements for rail service ought to be. Don't think we're quite there yet.

DUNCAN ALLEN: I will add to that, we did try to make our hypothetical corridor, which was ultimately the FRA suggested that was a way we ought to proceed, at least initially at looking at this, to try to be broadly representative of North American inter-city passenger service as it could be. And certainly, as I've seen and heard of the results of the Amtrak Risk Assessment, I have not been surprised by anything, in the sense that certainly we're not seeing anything that was indicating anything at variance with what was coming out of that study.

DUNCAN ALLEN: I think another point we should make is that the study that Mark Schneider and Duncan Allen reported on was initially conceived to be another one of those direct comparisons of the Texas TGV at the time dedicated right-of-way against Northeast Corridor operations, with the premise that at an absolute minimum the public would accept nothing less than the high level of safety experienced on the Northeast Corridor. And that was going to feed a lot of things, including a rule making at some point. But the project died for other reasons, and that's all history, and the project was refocused for other reasons.

JOHN BELL: I'll take a good stab at and leave it as a question. Ultimately, Amtrak's procurement had to come back around to the issue of, "How do you write a specification for a train that enhances the safety of the passengers, enhances the safety of the corridor that it's in, including the public riding trains, the public crossings, and still end up with a doable design." In other words, not end up in the corner of design and feasibility by writing into it "the reach" that the academic community seems to want. The problem with that process is that it's doomed to find enough infeasibilities to financially destroy the project. And at some point, when you're going to try and make a business out of it, and clearly the Republican Congress had said it's going to be a

business or it's not going to exist, you don't want to end up throwing out the baby with the bathwater. You want to have a project that builds a train that can be built that can provide the service and can provide the safety, without overreaching.

Now, if we want to go into an R&D project, I'd be glad to do that, but I won't put passengers in it and I won't put Amtrak financially at risk over it. And if someone wants to crash some cars, I'm sure the American Flyer team would be glad to build them cars to crash, but not to run in the corridor in revenue service. And if there's one message that I want to bring, it's, "Don't decide to regulate and reach." Regulate for what has been established in empirical testing. Because that you can build, and that you can build and support in contractual arguments: you can put it into service, you can prove that it's capable. If we fail to deliver this thing to the American public in the next four years, we're all going to be out of a job, because I don't think they'll give us another shot. So I'm sincerely hoping the regulatory process that's starting doesn't end up in a blind alley.

GRADY COTHEN: As one who's been down many blind alleys, this gentleman who's coming to the microphone, just wanted to concur with John's point. We actually did start out with a design philosophy at FRA for high-speed equipment. And we entered into a very extensive conversation. The conversation pointed out some of the infeasibility that John's describing, which we were not surprised, but we, of course, were educated as to at various junctures the nature of that lack of feasibility. And we tried to keep our eye on the ball, and that is what improvements could we make in the current state-of-the-art, which is actually quite good, that would not create an incompatibility and that would yield a reduction in casualties that would return the investment to the company purchasing the equipment, based on the reduction and the liability. And I think that's not a bad way of going at it if you have to be in the public policy business.

DANIEL MCNAUGHT: Daniel McNaught from Transport. We are one of the suppliers of the American Flyer. What's surprised me in your project of regulations for the high-speed for the train in U.S.A., your new regulation, is that you limit the speed of operation when you consider the worst set of regulations with speed of 160 miles per hour. And you don't consider to append this regulation up to 200 or 250 miles per hour. We have demonstrated since a long time that it's possible to operate trains at 200 miles per hour with a high level of safety. And it's difficult for us, the Europeans and French especially, builder of TGV since 20 years, to understand why the United States limits its project of new regulation to such a speed of 200 miles per hour. And when we consider the Amtrak specs for the American Flyer, it's clear that you have walked for the compatibility of the new train set with the existing train in operation. But this limits the speed of operation. Because when we apply the rules and the specifications, we obtain the weight of train, the weight of car which is not compatible with the operation at 200 miles per hour. Understand? So it seems that there is a difficulty in the process. It's difficult to understand why you limit the speed.

GRADY COTHEN: Bob, shall I respond to that?

BOB DORER: Go ahead.

GRADY COTHEN: I think the gentleman answers his own question. The criteria that we're riding for now, up to 150 or 160 miles an hour, is assuming a joint-use corridor with other passenger equipment, with freight equipment, and on the portions of those corridors where we're not operating in excess of 110 miles an hour, the existence of probably many highway rail

crossings. And under that set of assumptions, you try to put together a set of safety criteria. They may or may not be appropriate for higher speed operations on a wholly dedicated and grade-separated corridor. And that's specifically the difference.

Now, we are entering into a conversation on the issue of the current ultra high-speed rail project that the State of Florida is sponsoring. We enter into that conversation without preconditions in terms of whether that operation would be tied to standards for the general system of rail transportation with mixed passenger and freight and grade crossings or not. And with regard and with an open mind with regard to the technology that's proposed to be imported along with consideration of the operating conditions which may or may not be imported, given the difficulty of making us North Americans think in quite the same way that the French have through about high-speed rail. But we need to move more in your direction. Did I begin to answer your question, sir?

DANIEL NAUGHT: Yes, partly. But what I want just to point out is that the regulations, of course, have to give the condition of safety to provide good condition of safety. But it has also to provide a condition of economical condition of operation, for competitive condition of operation. Competitive condition of operation. And it's clear that for new infrastructure, if you build a new track, if you have to build a new track to create a new service in one state somewhere, you will not build the track for old criteria. You will not use the same kind of criteria used one hundred years ago. Or fifty years ago. And you will build a line which will be competitive with operation at very high speeds. And when I say very high speed, this operation is a range of 200 miles per hour, you know? And since there is a lack of regulation...

GRADY COTHEN: Right behind you, the gentleman is raising his hand, Mr. Philip Alexic, who's Deputy Associate Administrator, and my cohort. And I think there's a conversation needed there. But to answer your question, we have to tackle those issues. We need to take on those issues. And we are prepared, in fact, to do that.

DANIEL MCNAUGHT: Because we discuss the Texas project five years ago. [laughter]

GRADY COTHEN: There's a history there. Okay. Thank you for your comments; we agree.

JOHN BELL: Daniel, just to answer your question, we very much understand that the American Flyer meeting the specification that Amtrak has, is not a 200-mile-an-hour train. It's probably not even a 160-mile-an-hour train. It's a 150-mile-an-hour train specified around the 150-mile-an-hour definition by the FRA, and there were a lot of trade-offs that were very difficult to make to make it fit that criteria. And when we finally build dedicated right-of-way railroad, somebody's going to need to build a new train. Because the one we have won't go faster without tearing up the track under it.

HARVEY BOYD: I'm Harvey Boyd from General Motors. And let's talk a little bit about the value of risk assessment. And my comments concerning mainly locomotive crews, since we build locomotives. I'd like to separate it out a little bit. And including in this, of course, is the freight as well as passengers.

There's a lot of misconception out there. I believe that, and I've heard comments that this is the most unsafe railroad industry in the world. We've seen lots of bad press reports in the news. Even

Congress seems to think that nobody in the industry is doing anything to improve safety. And a lot of that is based on ignorance of what is out there and what's going on. And I think that proper risk assessments and getting that risk assessment out to the public will go a long way towards correcting that ignorance. Ignorance really is a lack of data. And unlike stupidity, ignorance is correctable.

In assessing risk assessment, it's easy to say what the risk is today; you simply count the numbers. But where is the risk ten years from now? It's a much more difficult problem to assess. You have a large fleet and slow replacement of that fleet. It may take something near 30 years for a total replacement of this fleet. So if you make some changes today, it may be 15 years before we begin to see the effects of that change. On the other hand, there are a number of things that are going on today which should be helping out and reducing the risk. And when you're making your risk assessment, are you taking those into account? Are you taking into account the fact that crews on trains have been reduced by a factor of two or more over the past six or eight years? That alone, in itself, will begin to show up in considerable reduction in the number of crew deaths. That's crews not only for locomotive but for total train crew. They've been moved out of the most vulnerable position of the train such as the caboose.

Other things which are going on, some of the new technology, such as higher horsepower, which is moving some of the mass out of the locomotive consist or mass that is a direct contributor to the severity of collision. AC technology, AC traction, which is moving more of the mass out of collision. Power distribution. The increased fleets of AARS58, which has increased collision strength. As the next ten years goes on, that fleet is going to grow, and you're going to begin to see more and more of its effectiveness, perhaps more so at the lower end, where there are more collisions. But when you're doing your risk assessment, are we considering all these things, and looking at where is this fleet going to be in the year 2005 or 2010? So that we can truly evaluate whichever scenario we tack to reduce collisions, are we evaluating the proper fleet?

JOHN BELL: If the caboose is the vulnerable point in a plane, how do you defend cab cars?

HARVEY BOYD: Cab cars actually are stronger than the caboose, and there's far fewer cab cars than there were cabooses 15 years ago.

JOHN BELL: One of the patterns in commuter services is for every locomotive, there's a cabcar at the other end. Their numbers keep growing.

BOB DORER: On the question of the actual risk assessment and factoring in future changes, I guess Alan or Mark or...

DUNCAN ALLEN: I'll say, from our point of view, that technology was not, although we reported some ten-year results, there was not an explicit extrapolation of the commuter. We were taking probably I'd mentioned the years '93 and '94, so as far as freight concepts was included, we were taking equipment that was representative of '93 and '94. So most of the equipment changes that you're talking about, we did not extrapolate into changes of that nature. And similarly, with the passenger equipment, we were looking at that point conventional equipment, both typical sort of bi-level commuter equipment they have here in Boston and the Heritage fleet. I'm sorry, not the Heritage. We wound up with the Horizon fleet for Amtrak, is what we used. We assumed certain equipment characteristic of today's operations.

But I also want to add in that we're not necessarily hard-wired into that, and that future changes in technology on all fronts, on operations, equipment, and signalling and control systems, can, with appropriate modifications to the methodology, be readily included. So we could look at future scenarios to assess, plan what we might want to do ten years out.

BOB DORER: And one last question, then we'll wrap it up.

BILL STRONG: Bill Strong, Long Island Railroad. Going back to some of the issues that came up a few minutes ago, I think, Frank Cihak, that your focus on specific hardware things that can be done to improve the crashworthiness to work on that inner circle are important. The 800,000-pound versus the European and Japanese standards, I've done some analysis; I'm sure some other people have. My vote goes to 800,000. But that's an area of focus. Yes, there's money to be saved by reducing that. And it seems like some philosophic discussion is going on, but hopefully behind the scenes there's some brass tacks stuff.

As far as the differences go, I really believe that managing the differences is important to the future viability of the passenger rail business. The diesel electric locomotive is certainly different than the cab car. Long Island operates 934 MU cars, and a bunch of locomotives on all terrains. And freight on top of that. And the investment in the infrastructure to try and change that is, you know. So I don't think the differences are unmanageable. Double or triple the weight of the locomotive? The collision posts need to be worked out and the corner posts need to be worked out. And the FRA requirements need to be worked out. And I don't think they're worked out yet, but similarity is, I think, a word that maybe shouldn't be taken literally in this business.

M: We'll take one last question.

LANCE SLAVIN: Lance Slavin, Simula Incorporated. Based on the agenda and based on the discussions this morning, most of the discussion has been about structural crashworthiness. But I suggest that once you start to either test or put real cars into operation, you're going to find that this structural crashworthiness is not going to help very much unless the interior has also been designed correspondingly to constrain the occupants. If you merely make the vehicle crashworthy and don't contain the occupant, you're merely transferring the collision from the train to the occupant, between trains to between the occupant and his own train. The collision will be just as severe unless his restraint is managed in some way.

BOB DORER: Wednesday afternoon, there is an entire session on interior crashworthiness, dealing with just the issues you mentioned.

BOB DORER: Well, structure isn't really getting three, because this was risk. So at least it was identified that risk is an issue with crashworthiness. But for the most part, the focus was crashworthiness. But you're right; it's two to one.

MARK SNYDER: Could I ask one more question? And I guess I'd like to address it to John, Frank, and Tom. Because we've talked about reducing risk on the accident-frequency side and also on the severity side. And we've got to come up with some agreement as to where we're going to put the dollars and do cost-benefit analyses. I'm a mechanical engineer, and even though I'm working in the risk field, I like to build things. And I'm still a little confused as to how we will be approaching the design of these new train sets. I mean, on the one hand, you could have a very,

very well-developed structural design basis doing design by analysis and very, very detailed design rules. But correct me if I'm wrong, but I thought that you were implying that you're advocating a fair amount of freedom, and that a design should be arrived at by, say, negotiation, but it meets certain general levels of safety that would be acceptable?

JOHN BELL: That discussion was really focused on making sure that the specification didn't call for a design that was not yet developed. I spent a great deal of time trying to keep the specification at a point where we knew it could be built. Contractually, if we specify something that cannot be built, the contractor goes down the alley, stops, tells us it can't be built, we pay him for all the time he went down the alley, go back to the start point again, give him a new specification, and pay him a second time to do the same job we just paid him for. It's not very attractive financially to do that inside of the procurement that's intended to be done for a known cost.

MARK SNYDER: Well, I guess what I was thinking in the back of my head that, say, pressure vessels, which affect the public safety, does the AS&E boiler and pressure vessel code, which is a very well-developed set of design rules. And if you meet the design rules and you meet the code allowables, you can blam! stamp your vessel as being certified. If you don't like the rules, you can set up a code case and appeal them. And now, there are probably fewer trains or would be fewer trains than pressure vessels in this country. And I guess that, as a mechanical engineer, I'm trying to get a feel for, from the industry side, would you feel more comfortable with a very, very detailed design basis? Or would it make more sense to just have general sets of requirements and let the owner and the builder show, in their own way, that their design meets these goals and objectives?

JOHN BELL: Let me volley at the town, but at the time that we started this process, Tom's opening statement was right; there were no passenger car safety standards. There were some loose requirements that were dated from the AAR that gave us just a smattering of things. There was a great collection of international work that had been both researched and, in many cases, empirically qualified, while we were writing the specifications, the French were crashing a car to confirm a massive amount of analysis that they had done in advance of that. That gave us a foundation upon which to build much of the risk control that's available in structures.

MARK SNYDER: Agreed.

JOHN BELL: Now, to fill you in on the process, which is stealing Frank's thunder for tomorrow, is we're going to be putting controlled crush zones strategically throughout the train, that creates a limit of deceleration, that allows the passenger leaving his seat toward the seatback in front of him to strike that seatback at a lower velocity than he would if it was a hard, two-million-pound strength locomotive that you see in a typical commuter service. Once he's up against the seat in front of him, his body can deal with a lot more than he could if he's either flying free or in a higher initial impact. Once you're up against the wall, you're pretty well just going to ride it out. And that's based upon a fair amount of research that's coming out of the military side applications. Therein lies the solution. And the automakers have been using it for a number of years. I don't want to get into any more of that, I'll just volley it to Tom in terms of the passenger car safety standards.

THOMAS PEACOCK: The way I see it evolving right now, it's kind of a hybrid situation in that there's a lot of specific requirements in there that specific strengths are required, in specific locations. But it also leaves a fair amount of freedom of design, so that there isn't just one solution to this set of requirements. There could be a large variation of sets of solutions to these requirements. So we tried to reach a compromise of comfort of specific things we could test for and look at and be sure it's what it's supposed to be, and yet not totally handcuff the designer and eliminate all creativity.

MARK SNYDER: Thank you. That's precisely what I was looking for.

BOB DORER: Well, I'd like to thank the panelists and speakers. I think they've done an excellent job. And fielded all the questions with honesty. And Grady has a comment.

GRADY COTHEN: If I could just put a few wrap statements on this here, Bob, so that we could keep them in mind as we go forward over the next two days, picking up on things people have said. First of all, we do prefer performance standards. And we've started this discussion at a rather high level in terms of performance standards and practical considerations have caused this to become more specific about strengths of particular locations, because John just will not loan us two American Flyer train sets to test; I don't know what it is! But...

JOHN BELL: I'll call my banker and ask him.

GRADY COTHEN: Yes. But that is where we start from, anyway. And we all do need to be practical about this. Secondly, I think that as you hear more about the discussion we're having at the Federal Railroad Administration with our partners from labor, management, passenger associations, suppliers, states, that you will see that we're in an interesting phase. We're looking at, on the one hand, conventional speeds, if you will, which I would describe as 110 miles an hour or below, and looking at what marginally we can do to improve on a very good North American standard. We're also looking above 125 miles per hour, basically without anticipating it, perhaps, just as shorthand to codify some of the things that we agreed with in our discussions with Amtrak, again, regarding the train set that's going to be in service on a joint-passenger freight corridor, with exposure in the terminals, and at least part of the background of the discussion was some of these train sets, a couple of them originally were going to be operating off the Northeast Corridor, where we might have more grade crossings than they faced on the Corridor.

You notice there's a gap in between there? One of the issues that arises is that commuter authorities and others tell us the equipment they're procuring, they'd like to see operate above 110 miles an hour. We believe that international concepts regarding crash energy management have application in that speed range, between 110 and 125. We do not yet have, I think it's safe to say, consensus on that point. And certainly there are a number of very interesting and difficult technical issues, most of which I personally probably don't even understand, but which hopefully Mr. Peacock does, that we need to get past. And during this five-year rulemaking period, so that as opportunities do present themselves to improve conventional equipment, we take advantage of those opportunities. And that's one of the reasons that I've urged that we not enter this discussion with a sense of complacency, and we enter into it with an open mind and that we look for opportunities to improve safety over time. And certainly, maintaining the basic compatibility of

the passenger equipment that exists out there today with what we order in the future and compatibility of that equipment as best we can with freight equipment.

The issue keeps occurring regarding an occupied vehicle passenger occupied vehicle in the lead, cab car. FRA has this issue posed squarely to it as a result of the three commuter accidents that I mentioned to you, all three of which occurred outside of cab signal territory. And the obvious solution would appear to be cab signals, positive train separation, whatever you want to call it. That hero is not yet visible riding over the horizon on a grand stallion, and so I think we need to be thinking about what we do in this area. What other alternatives may exist. Certainly, at a minimum, we have a responsibility to the National Transportation Safety Board and the Congress to respond to their recommendations on cab car in strength at the corner. You will hear before the week's out, I'm sure, that that's easier said than done. Particularly at the higher closing speeds. We need somehow to keep that issue to the fore, and see what's possible given the existing configuration of the physical facilities that we have out there and the needs we have to serve our customer, the passenger.

There's also the point that, although we talk about refinements that we can make with regard to corridor risk, the risk on individual corridors, very often the reality is that the equipment that's ordered for passenger service in this country may be used in a variety of ways. Treated somewhat as fungible, sometimes sold from property to property, sometimes moved from line to line. For instance, some operators on the Northeast Corridor want to use that equipment on the corridor and on their lines off the corridor. And therefore, if we talk about isolating improvements, small subsets of the fleet, in some cases we may not be talking about making improvements at all.

If we assume all equipment is fungible in terms of its use, it's going to be in joint operations with freights, that they're going to be lowboys stuck on the crossing, then we need to perhaps and operating, by the way, on facilities that are not maintained with the same attitude that may exist in portions of Europe and Japan, in terms of the investments that are made front-end and the maintenance philosophy. Again, the premium is placed again, not as a result of choices that the Federal Railroad Administration has made on finding opportunities to improve the crashworthiness of the vehicle. So these are the hard kind of public policy choices that we've been wrestling with. I believe it's safe to say that most of the policy concerns, as opposed to the technical concerns, perhaps, that have been raised here today, have been raised very vigorously across the table, with all of us listening to one another in the past year of equipment safety standards working group. Hopefully you'll see some of the flavor of that in the advance notice. But certainly not all of it, because much conversation has transpired since that document was initially drafted.

And again, one of the reasons that this symposium was held was to get a good focus on the opportunities that do exist as a result of international innovations and notions that have been brought to the table domestically to improve the next generations of rail passenger equipment. I hope over the next two days that we'll have further very productive discussions about that, recognizing that we'll probably not be able to do everything we identify as attractive to do. Nevertheless, we need to do what we can. Bob?

BOB DORER: Okay, with that wrap-up, I'd like to give the panelists and speakers a hand, and then Dave has a few things to say about the reception. [applause]

Structural Crashworthiness Design Practice

MS. SEVERSON: I work for the Volpe Center and I'd like to welcome everybody back to the Volpe Center again this morning for another day of presentations. I'm sure we'll be apt to generate even more good conversation following. This morning we'll kick off Part A of the Structural Crashworthiness session. Part A deals with the design considerations for structural crashworthiness. After lunch, Part B of the session will cover the new trainset designs. At the end of the day, there'll be another panel discussion like yesterday, covering the first two parts of the structural crashworthiness session.

The lead-off speaker this morning is Dr. Clifford Woodbury III, of LTK Engineering Associates. Cliff Woodbury is a Ph.D mechanical engineer educated at Swarthmore College, University of Pennsylvania, and University of Massachusetts. In June of 1972, Dr. Woodbury joined the Philadelphia firm of Louis T. Carter and Associates, now LTK Engineering Services. Dr. Woodbury's firm has specialized in the planning and design of transportation systems since the early 1920s, and is probably best known for its vehicle design work. Dr. Woodbury has worked on all mechanical subsystems of vehicles and has specialized in structural design for over 20 years. During that time, he had the privilege of associating with rail car designers, who were active car designers as far back as the development of the light-weight streamliners in the 1930s. Dr. Woodbury has participated in the gradual development of rail car crashworthiness requirements over the past two decades, culminating recently in the requirements for Amtrak's new high-speed trainsets. Dr. Woodbury.

DR. WOODBURY: Good morning. I truly am very pleased to be here and particularly honored to be placed among the people that I respect very highly for having done some of these very excellent developments in crashworthiness in the recent years. My assignment from Dave Tyrell was to discuss the current North American design practices for railroad passenger equipment. Of course, I will do that. I'll also be discussing what the present requirements are, as reflected by the Amtrak high-speed trainset specifications. As Kris said, I was involved in those. And I'll also be discussing the design practices from the perspective of the future. And in that regard I'll be discussing and commenting on a few of the proposed requirements and FRA's Advance Notice of Proposed Rulemaking, which was recently published last Monday, I believe-but it's been under discussion for some time now. I was finally able to have a chance to greet Grady Cothen this morning in the hall and I mentioned to him that I did intend to be frank with my comments in that regard. However, this is a technical conference and I will limit my comments to the technical merits of the requirements that I see in the advanced notice. And in finishing up the preparation, my remarks last night in my room, it was apparent to me that it's now time for me to put up or shut up. All the world's experts are here-the experts for the design of rail vehicles for crashworthiness. They need to hear your frank opinions about what you believe to be achievable, given the state of development of crashworthiness today. That's really the underlying purpose of this symposium. So I hope that you will do the same.

In his wrap-up remarks yesterday, Grady Cothen used a phrase-this is not a direct quote and if I've gotten this way off, please correct me-something to the effect of "the good North American standard" or "the excellent North American standard" or words to that effect. Well, I agree with that on two counts: I agree that one, there is a standard and two, that it is a very good one. It's important to keep in mind that there are two things going on right now: one, an effort to revise

and update the regulation; the second, which will start soon, will be an effort to revise the standards. The regulation is under the care of the FRA. The standards will be under the care of APTOR or perhaps APTOR with one of the professional societies. There is a current regulation for the design of railroad passenger equipment. It has problems, primary among those the fact that its scope is very limited, being applicable essentially only to EMU's. However, regarding the standard, and with apologies to our international friends here, who are probably puzzled by why we can't seem to agree on something that's so basic, I'd like to state without reservation that it is my position that there is a current standard for the design of North American passenger railroad equipment, in the sense that there is a design practice. And I'll be discussing those things this morning.

Our design practice is based on about 150 years of hard work and hard lessons learned from accidents. The basic proposition here is that there is something deficient or defective about what we're doing now. If that's too strong a way, then what we're doing now needs to be looked at and carefully revised. In either case, it would be my vote that if nothing else comes out of this symposium that we could at least agree that there is a standard or there is a practice for the design of railroad passenger equipment now, and then to agree on what that practice is. So that will be the focus of my remarks to define the practice. Where it's appropriate and where I know enough about it, I'll make comparisons to international standards.

This will not be a complete discussion of the current North American practice, of course; my remarks will be limited to those requirements that are related to collision and derailment, which of course is appropriate for this forum. So the subjects I'll be discussing are the ones that are shown on this slide. Frank Cihak in his comments yesterday has addressed some of these, the first in particular. But since I've prepared my remarks, I'll go ahead with them, and I'll be talking about our use of the tight-lock coupler, our bus strength requirements, our end-frame collision post and corner post requirements, and truck connection strength requirements. I'll briefly talk about NU and cab car corner post strengths. I realize this is a somewhat sensitive issue at this point with the recent accidents, but what I have to say I believe is factual, and it will help to define the current practice. I'll also be talking about side strength and rollover protection, and yes, finally crash energy management, which is what the acronym CEM stands for. In the end, I'd like to leave you with some appreciation that the current North American practice does in fact, in some fashion, in some way, address each of the concerns that are in the FOA's Advance Notice. So, again, that in my view makes our current practice the right place to start in the efforts to revise and update the regulations and standards.

So the title of this slide is backwards; it should be anti-climbing and anti-telescoping, of course. And if you look at the things that are on the slide there, perhaps you recognize that the philosophy for anti-climbing and anti-telescoping includes several lines of defense. The first, of course, is the tight-bar coupler, which has a very high strength and is built into the ends of the cars, and is backed up by cars with a high bus strength. Next, if the anti-climbing arrangement which is provided by the tight-bar coupler built into the end of the car is overcome, we have the substantial end-frame collision post and corner post constructions. That failing, and telescoping in, and there is climbing and telescoping is underway, the trucks are required to be locked to the car body with a very high horizontal strength, and if the telescoping proceeds that far, the truck attached to the overriding car will strike the underframe of the overridden car, and prevent further telescoping, at least up to the ability of the truck connection strength to do that.

For the tight-lock coupler, I quite frankly don't know if they've ever been actually tested to destruction. I don't think they have. They have been tested, however. In one case, the test rig failed, rather than the test article. In any case, the tested bus strength is somewhere in excess of one million pounds; in draft, it's about half that. The torsional strength is about 200,000 foot pounds and the bending strength—I haven't mentioned bending up there—is somewhere in excess of 300,000 pounds in either direction, that is vertically or laterally. Now the torsional strength is available to prevent rather than protect against, but prevent rollover. And the bending strength in the vertical direction against climbing and in the lateral direction against bypassing of the ends of units—those two together, if you think about it, are effective in keeping units in a train in line when also passing very high forces due to collision or derailment. That's another concept that's addressed by the FRA's Advance Notice. The Amtrak high-speed trainset will use a shear-back coupler with a release value of something on the order of 450,000 pounds. If that's the wrong number, there are people from the consortium here who can stand up and correct me on that. This is a practice that's familiar to us in North American transit, of course. But I believe that this is the first application of this in railroad practice in North America, at least in modern times.

And having said that, I'm sure there's several historians in the audience who will stand up and correct me on that one as well. The coupler has an energy-absorbing cartridge in it to begin the process of controlled energy absorption in the event of a collision. This essentially constitutes a return to the practice of sharing high buff load between the underframe and the center island draft, which was prevalent before the introduction of the tight-lock coupler. It has the effect of reducing the offset of the very high buff load with respect to the center of resistance in the car body structure, and this apparently is going to be necessary for designs with structural zones for controlled crushing. So if that's true, then this type of coupler will probably become standard practice, at least for equipment designed with crushable zones in the structure.

All right, moving on to the buff strength. This is in my paper—I apologize, the font size is too small here, but if you can't quite see this, it is in my paper, which is available. This slide compares current North American buff strength requirements with the European standard. The intent here is that you're to visualize that these loads apply to these heights due to proxy for a type of regional rolling stock, which is a label that I've used that I think most people will understand. For us in North America, of course, here's our 800,000 pound buff load on the center line of draft. The standard also includes a requirement for 400,000 pounds, halfway between the coupler and the buffer. This is at an approximate factor of safety of two, so I've simply put another value at 800,000 pounds right above here, and drawn a line straight up. Incidentally, there is no functional requirement in our practice which is the line, this is simply connecting the dots in order to make the illustration, really, that the difference between these two is a little clearer. In any case, moving up here's 500,000 pounds which is required to be applied to the buffer. I believe this is a holdover from the Railway Mail Service specification, which was in effect before the issuance of the AR in 1939. In that specification prior to the tight-lock coupler, it was permitted to share the high buff load between the center island buff load and the center island coupler.

For those who here are really, for us who are not buff loads, however, I've shown them here because in the standard for the Europeans, they are actually called "buck loads," these loads above the floor. So I've shown them on this diagram, even though I'm really talking about buff loads. Here's our 300,000 pound shear value with collision posts at the floor times two posts. At

eighteen inches above the floor, the posts are required to be designed for 300,000 pounds at ultimate. Now this results from an NTSB recommendation following the collision in Chicago in 1972 that Frank Cihak talked about yesterday. This is not the value that you find if you go back and look in the AR standard SO-34. I said 300,000 pounds; well, that's an ultimate, so I've estimated the yield load up two-thirds of that or two hundred times two is four hundred. As Frank mentioned yesterday, posts are required to be designed such that the connections at top and bottom and the supporting structure on the roofing interframe are sufficient to support the post at its ultimate capacity loaded here. This is a reaction that designs currently, the reaction at the roof that is currently produced by designs with which I am familiar. Actually this number, 120,000 pounds, is high. It's probably the highest that I know of. A more typical range would be somewhere around 80-100,000 pounds.

One other note here: on the collision posts, typically it's required that the load here at 18 inches be applied anywhere within 15 degrees of longitudinal. Now that's a way to essentially require that the post be stable enough to take a hit, not only just straight on but from some angle, and essentially it ends up requiring that the post be a closed sectional with some torsional stability. These requirements are taken from a draft standard by the Committee for European Standardization, or CEN. I believe these are the same as the requirements that we were familiar with before under the UIC. Anyway, the buff load requirement there is 450,000 pounds, and I believe that that standard says that it can be applied either to the buffer or the coupler, as appropriate. I assume that that's a way to allow various different types of buffer and coupler arrangements between units. Ninety thousand pounds, 6 inches above the floor and 67,500 pounds applied to the waist rail butler for us, and cantrail, roofer for us. Now as I said, these are labeled buff loads in the standard and they are to be applied to the end row, which means that essentially they're resisted by the body profile. There is no requirement in the standard lease as far as I can determine from the translation that I have of it, for discrete posts to resist these loads above the floor, which is typical of our practice. Anyway, one last comment here, and this graphically shows the difference between the two, and is an indication of where the problems have been in the past for us in procuring equipment designed by international builders.

Moving on to high speed, I've attempted to represent over here what I believe to be the design requirements for the TGV double-decker. Again, the designers are here, and if I'm wrong on some of these values, please correct them. Again these are in pips or thousands of pounds. Note here, these requirements as far as I understand are intended to apply to the entire structure of the power car from end to end, except for this one, this 670,000 pound strength is applicable only to the strong floor under the cab. For the Amtrak high-speed trainset, we have a similar concept here. The cab is designed as a very, very strong substructural module similar in concept to the road cage around a race car driver. These loads that I've shown here are applicable to that module, which is designed to be a safe refuge in the case of a collision. You can see there's really a tremendous difference here, increase in the loads compared to these, but keep in mind that they are on a different basis. These apply only to the cab module. And here's the requirements for the nose, which is a reflection of the implementation of crash energy management for this design. This applies to the very carefully designed crushable structure on the nose. Note here that this constitutes a departure from our current practice, which is 800,000 pounds period from the end of the car. It's necessary in this case, however, in order to implement the crashworthiness technology in the right way.

I think I've been over each point on there, except for perhaps the last. The number is incorrect. I believe that for Japan Railways the buff load requirement is 100 metric tons, which would be 220,000 pounds. And our information is, in a letter from them in May of this year, that they are currently implementing the latest concepts of crashworthiness in their equipment.

Some of this was discussed yesterday by Frank Cihak; I won't go into a lot of detail here. Currently our anti-climbing arrangement is required to have a 100,000 pound strength up and down at yield. The high-speed trainset trailers, it's a little bit more now, it's equal to the weight of the heaviest trailer, which is currently about 130,000 pounds. The power car is required to be designed to ARS-580, which is 200,000 pounds, vertically, but in this case, it's at ultimate. A particular concern that I have is a requirement for anti-climbing strength as stated in the FRA's advance notice for Tier II. The way to describe it is basically, it's related to the crash energy management system design. And what that comes down to in my opinion is the scenario that's eventually selected for design and evaluation, and I'll talk about that more in a minute.

I probably talked about most of these enough by now. Anyway, for the end frame, our practice is substantial collision posts and corner posts. In the past a requirement for total section modulus in end-frame posts has occasionally been met by including some of that in quarter posts, either at the extreme corners of the cars or at the body corners in cars within vestibules. There is the counterpart, not the exact counterpart, but a similar practice in the European standard, which I've explained. One thing I did not mention in the slide about high-speed buff strength was that the high-speed trainset power car does use the concept of a unitized crash wall at the front of the cab module instead of discrete posts. The crash wall is made up of an array of about five posts below the windshield, all tied together and acting, more or less, as a unitized structure. Three of those posts, the one in the middle and the two at the sides, proceed on up to the roof. And here is another concern that I have in FOA's Advance Notice, the suggested requirement in there is that such designs where you have a unitized crash wall in front of a cab produce a load at the roof of 400,000 pounds applied uniformly to the roof. This is well above current practice, it's well above the value for the high-speed trainset, which again is on a different basis. My understanding of this one is that it's intended again, to apply to the entire structure. The value for the high-speed trainset, which is lower than this, 310 or whatever the number was, is intended to apply only to the cab module. That's an entirely different problem, easier problem. I simply don't see the need for such a high load. My recommendation is that it not go forward, that we stick with the current practice in the high-speed trainset, if you will, but that a value of 400,000 pounds at this point is simply not within the realm of the possible.

I've already briefly mentioned this; however, this is an important part of our anti-telescoping philosophy. It's not well understood, so perhaps just a few minutes on it would be a benefit. It was implemented after a very serious wreck in 1938 where a heavyweight car jumped up the bolts that attached the center plate to the underframe of the car, sheared off and the heavyweight telescoped most of the length of the lightweight car to which it was coupled. Ever since then we've had a requirement for the trucks to be locked to the car body and to have the very high horizontal shear strength that you see there. It also has the benefit of keeping the trucks attached to the car so the mass of the truck is available to hold the car down in case it wants to tend to rise up in a collision. And in a derailment, the trucks stay attached to the car as they plow, ballast and turn; they can transmit a very high returning force to the cars in the train and bring the train to a safe stop. There's no problem here. The requirement is basically the practice in the

high-speed trainset specification, and as far as I can determine based on my reading of it, in the Advance Notice.

Corner posts, they are included in our current practice for cab cars. The one that I think started us off was the 1966 specification for the original Budd-built Metroliner for the Pennsylvania Railroad, which had a requirement for extra-heavy corner posts, each to be two-thirds of the strength of the collision posts. In other words, they had 200,000 pounds shear value at the floor. For the high speed trainset trailers, what I've said there is a bit confusing. For high-platform-only designs, there is one corner post at the extreme corner of the car. It's required to have the same 200,000 pound strength value at the floor. In case the design did have load platform steps and end vestibules, then there would be a requirement for two posts, one on either side of the vestibule, the one at the extreme corner having 150,000 pound strength at the floor. By top reaction, I don't mean the biggest reaction, I mean the reaction at the top. For the high speed trainset trailers it's 20,000 pounds. That's about double, a little more than double current practice. For the power cars, it's 80,000 pounds, well above current practice. But again, that applies only to the cab module. But these values have been confirmed as achievable by the bidders. In the Advance Notice, those values respectively are proposed at 80,000 pounds and 133,000 pounds. Once again, these are two values the need for which is simply not clear to me. It's not been shown that that sort of level is achievable, or if it were what the benefit would be. And I think those things should be established before we go forward with requirements like that. My recommendation is that we stick with current practice in this area as well.

Rollover protection, which is the next slide, again this is addressed by our current practice. Again, perhaps not in the way that is being envisioned by the Advance Notice, but it is addressed. I've mentioned the tight-lock coupler. We're having a very high torsional strength available to prevent rollover. In my paper I've discussed the belt rail, and how it's been used in North American practice over the years, to protect passengers in side-swiping incidents and in rollover incidents. We are all familiar with the purlines in the roof of lightweight stainless steel cars, which act to support the tops of collision posts, their full length running between the tops of the collision posts. What these were originally intended to be—and they were called skid rails, to protect the roof from gross failure in the case of overturning—were to help resist very high loads applied from above. The current standard has requirements for sheeting thickness on the roof and the sides and minimum section properties of the side frame and the roof framing members and sideloads. In the high-speed trainset, the side loads have been increased, the side sails are doubled. But again, this has been confirmed as achievable by the bidders. In the Advance Notice, my concern here is the dynamic scenario that is being proposed for the purpose of designing and evaluating side loads. It's going to be subject to tremendously widely varying interpretations, and also in the case of rollover protection the requirements that are stated also are going to be subject to interpretation. And my recommendation here is that we start with what we are doing now, perhaps refine it—not perhaps, but do refine it; look very carefully at what's called for in the Amtrak high-speed trainset specifications in this area; and not go any further than that, unless it's clear what the benefits are. Next slide, please.

Okay. Here's an area where there have been efforts in the past. In my paper I describe two specific things that are evidence that in the past engineers and car designers have been concerned about preserving occupied volumes. The Amtrak high-speed trainset incorporates the latest developments, and I'm going to leave that for the developers themselves to discuss later today. In the Advance Notice, in my view there's a very critical need to keep the requirements for crash

energy management reasonable and practical. In the past the discussions have included scenarios with trainset-to-trainset collisions at high speed and even very high speed-90, 100, 140 miles an hour. These may be an interesting exercise; however, the assumptions that have to be made simply go out the window at such high speeds. Also, using that brick fixed barrier collision assumption, the energy that's available in trains operating at that speed is some order or two of magnitude greater than what's currently achievable in the trainsets for absorption. So we're worlds apart here on this particular requirement, and we simply can't be because this one's critical. We have to leave it at a level which we know can be achieved. Next slide, please.

So in conclusion, I think I begin to have you understand what the concerns are, and therefore raise Advance Notice on, somehow or in some fashion in our current practice. That's not to say that refinements are not necessary; they are. They're possible and they're necessary. However, it's my view that we should start with what we're doing now; determine what's practical, what's achievable, and what's of benefit; and then go from there. And this is particularly so, as I said, for crash energy management.

Finally, responding to a comment made yesterday by Tom Peacock, I think it's really a communication gap rather than a credibility gap. What this all will come down to will be structural requirements in specifications for the procurement of new equipment at some point in the future. These requirements have to be concise, subject to the minimum amount of interpretation, and capable of design and analysis and tests by ordinary humans—that is, if structural engineers are in that class. So it's my plea that nothing go forward in the Advance Notice to the next stage—whatever that is—without showing the need for it, and without showing that it clearly solves some problem that we're currently having, and can be achieved at acceptable weight and cost. That concludes my remarks. Thank you very much. [Applause]

MS. SEVERSON: Are there any questions for Cliff at this time? I can't believe there aren't. Okay.

AUDIENCE ATTENDEE: Thank you. That's a very good talk. It's probably the clearest I've seen this situation we're in being described in one place at one time. And you hit several nails on the head. Most of the places where you questioned what's in the ANPRM have already been brought into the more reasonable realm, maybe not as reasonable as they need to be, but certainly we have moved on. You probably should see George Pins; he's involved in the group that's taking the next step forward from the ANPRM to the NPRM. And he has a draft that has the new values in it. And I would appreciate it if you would take a look at it and see how far your concerns have been alleviated.

DR. WOODBURY: Thank you. I assume you're referring to the TIER II group. I've not been involved in that. If you wouldn't mind, explain what the purpose of the appendices in the published notice is, because the values that I've mentioned are in there.

AUDIENCE ATTENDEE: Okay. My view is the current practice that Cliff was describing probably is one bound to where our standards need to be, it's the lower bound. I would view the proposed appendices in RENPRM as an upper bound, and in some cases probably beyond an upper bound. And where we end up needs to be between those two limits. That was my view of the purpose. And the appendices were supposed to get people to react like Cliff did. In some cases we knew the numbers were probably beyond achievable, but that's how you get people to

react, to put something in that they know is wrong, and then they'll come and tell you what's right. [Laughter.]

DR. WOODBURY: Anybody else?

FRANK DUSHINSKY: Cliff, in your paper you mentioned that on several occasions the FRA required higher strength in certain zones. And this for a cost of weight. Frank Cihak yesterday said that weight has to be considered especially in high speed. What is your understanding of the reasons for it? Would it be because it is just new equipment or would it be that some scenarios for a crash at higher speeds were considered?

DR. WOODBURY: The simple explanation of that is that there was a desire on the part of FRA for-for the lack of a better way to say it-for something better, something superior to what we're doing now for this new high-speed equipment. And each of the requirements suggested by the FRA was their view of how to achieve that: something better, something superior. That's not a fair statement of the reason for it. Does that answer your question, Frank?

FRANK DUSCHINSKY: Yes and no. What is better is not, I mean you cannot look only at one aspect. I guess rebuilding high-speed trains, manufacturers have to be waiting, I think, someone explained yesterday that there are some considerations to be made, and weight is one of the very important. And in other words, the benefits must be demonstrable, like you said before.

DR. WOODBURY: You're preaching to the choir. I think we agree on that point. What I said was, "better in their view." These things were argued quite strenuously over a period of several meetings. And we tried our best to introduce arguments about weight and so forth. But again, the desire was to achieve the next level, a higher level, a superior set of requirements for this equipment.

MS. SEVERSON: Any other questions? Okay. Thank you very much, Cliff.

PRESENTATION

STRUCTURAL CRASHWORTHINESS DESIGN PRACTICE

**Volpe National Transportation Systems Center
Symposium on Rail Vehicle Crashworthiness**

**North American Passenger Equipment Crashworthiness
Past, Present, and Future**

Clifford A. Woodbury, 3rd
Senior Engineer
LTK Engineering Services
Blue Bell, Pennsylvania

Introduction

This is another in a series of papers about the current North American passenger equipment design standards.¹ The underlying message in all of them is that we think the railroad passenger equipment design standard we have in this country now is a very good one. It is best appreciated, however, in the context of the railroad experience - meaning the designs that were produced, the operating environment, and the accidents that happened - during the century and a half it has taken to develop it. Therefore, wherever possible, we have researched the background of the requirements in the current standards. This has also led to a greater appreciation for the tremendous effort that has been devoted over the years to each part of the current standard.

The FRA has published its Advanced Notice of Proposed Rulemaking (ANPRM)² covering aspects of passenger equipment design related to safety, including structure. There will eventually also be a longer-term effort to revise and update standards for railroad passenger equipment. The discussions in this paper are primarily related to the requirements proposed in the ANPRM. But, our suggestion is that any new regulations or standards which are ultimately developed should

¹References 6, 7, 8, and others.

²Reference 2.

North American Passenger Equipment Crashworthiness (continued)

start with what we have now, and systematically update them and add the new ideas, while keeping the new requirements in practical bounds.

Our part in the Symposium is to discuss in some detail the current North American design practices, and compare them, where possible, to other international standards. The discussions are, of course, limited to emergency loads that result from collisions and derailments. The current practice is compared with the requirements developed with the FRA for the Amtrak high speed trainset (HST), and with what is being proposed for the future in the ANPRM.

Subjects Discussed

The cornerstones of the North American passenger equipment design practice have been compatibility, high anti-climbing and anti-telescoping strength to protect the occupied space from the loads applied at the ends, and requirements for strength and toughness of the sides and roof to protect the occupied spaces from the sides and above. Stated this way, it is perhaps clearer that the North American practice, which has been in effect for some 60 years, and parts of it more than twice that, has an underlying purpose of protecting and preserving occupied volumes, the label being applied to these practices today in the context of the latest developments in crashworthiness.

The discussion begins with anti-climbing and anti-telescoping design practices in North America. This discussion, as are all of them, is from the perspectives of the past (the development leading up to the current practice), the present (Amtrak HST), and the future (the ANPRM). These will be followed by discussions of cab corner post strength, roll-over protection, and collision energy absorption by controlled crushing of structure, or crash energy management (CEM) as it is being called.

North American Passenger Equipment Crashworthiness (continued)

Anti-climbing and Anti-telescoping

It's been said before, but it bears repeating; telescoping is the primary cause of injury and death in the event of a collision. North American railroad passenger equipment design has been based on providing several "lines of defense" against telescoping:

- High body end-compression or "buff" strength, to resist loads applied to the underframe and the coupler;
- An "anti-climbing arrangement", which, for railroad designs, has been provided by the tightlock coupler built into a strong pocket at the ends of the underframe to provide high levels of resistance to climbing (vertical) or bypassing (lateral) of coupled units;
- As part of the anti-climbing arrangement, the tightlock coupler, with high tensile, shear, bending and torsional strength;
- End frames consisting of strong posts to resist penetration if the anti-climbing arrangement is overcome; and, ultimately
- The horizontal strength of the attachment of the truck to the car-body, which is available to resist further penetration if all else fails and telescoping proceeds from the end of the car to the truck.

Coupler

The standard AAR Type H tightlock coupler has ultimate buff strength in excess of 1,000,000 lbf, and somewhat more than half of that in draft. Its torsional strength is in excess of 200,000 ft-lbf even for Grade C steel, but the ultimate torsional strength of an installed coupler is probably defined by the strength of the draft-gear pocket. In any case, given the typical height of the center of gravity of a fully-loaded coach, there is likely to be sufficient torsional resistance in the two couplers on a unit to resist any conceivable level of forces that would tend to overturn a coach in a train.

North American Passenger Equipment Crashworthiness (continued)

The Amtrak HST design will take advantage of a provision in the Specification for a shear-back, energy absorbing coupler. Although common in transit, this type of coupler has rarely, if ever, been used on North American railroad passenger equipment. Shear-back, energy absorbing couplers begin the energy-absorption process in a collision, and permit, after release, direct transfer of loads from unit to unit without the difficulties introduced by the offset of the coupler from the main longitudinal members in the underframe. Minimizing the effect of the offset is necessary for the proper functioning of energy absorbing zones in the body, and, for this reason, the use of shear-back couplers will probably be standard practice in the future for equipment with CEM.

Buff Strength. North America

The much-discussed, not to say despised, 800,000 lbf buff strength on the line of draft has been in effect for most of this century. It appears in the AAR passenger equipment standard, first issued in 1939.³ Before that, in the Railway Mail Service (RMS) Specification, there was four tiers of end strength from 125,000 lbf to 400,000 lbf, depending on the type of equipment and service. It is important to keep in mind that the RMS end strength values were at an approximate factor of safety of 2 on yield, so that the top category was equivalent to the AAR's 800,000 lbf, for which the failure criterion is no permanent deformation.

The AAR also requires the following buff loads:

- 500,000 lbf on the buffer beam, without permanent deformation; and
- 400,000 lbf halfway between the buffer beam and the center line of draft, at an approximate factor of safety of 2 on yield.

³Reference 1.

North American Passenger Equipment Crashworthiness (continued)

These are apparently hold-overs from the RMS, which allowed end load to be shared between the buffer beam (which is directly in line with the main underframe structural members), and the line of draft, according to their respective capacities. Interestingly, the second is required to be resisted by the center sill construction only, and so obviously can not be met by designs without center sills (absent some free thinking about what constitutes a center sill). This "back-door" requirement for a center sill should not be perpetuated.

The only one of the three buff load requirements that is traditionally subject to test is the first, because it is the most severe. The difficulty in meeting this requirement is compounded, especially for lightweight designs, by a "recommended" 1-inch limit on upward deflection of the body when subject to the 800,000 lbf load on the line of draft. This has always been treated as a requirement rather than a goal, and the design of lightweight stainless steel equipment is greatly affected by this requirement.

The Amtrak HST is required to meet these same buff load requirements. Power cars must also meet AAR S-580 for locomotives, and, in addition, the cab is required to be designed as a super-strong "crash refuge", similar in concept to the roll cage around a race car driver. Considered with the crash energy management (CEM) requirements, extraordinarily high buff strengths will be required in certain zones of the trainsets:

Trailers will have passenger compartments (between end vestibules) of strength substantially greater than 800,000 lbf, so occupied spaces will not be damaged before the ends, which are designed for controlled failure at slightly more than 800,000 lbf. The units must still withstand a static end load of 800,000 lbf, but applied directly to the underframe rather than the centerline of draft, because of the use of a shear-back, energy absorbing coupler.

North American Passenger Equipment Crashworthiness (continued)

- Power cars will be strong enough to support the bottom reaction of two collision posts which together provide one million pounds of resistance at a point even with the top of the underframe, at ultimate.
- There's more when it comes to the power cars, however. The floor of the cab crash refuge, when all the various loads are added up, must withstand 2.1 million pounds. Understand, this applies only to the cab considered as a sub-structure, not to the entire body structure of the power car.

These loads, formulated in discussions with the FRA while preparing the specifications for the Amtrak equipment, represent several significant steps up the buff strength scale, but satisfied the FRA's desire for superior strength for this 150 mph equipment.

The future still holds the promise of lower buff strengths, at least at the ends of units in zones designed for controlled crushing and energy absorption. Some research or at least investigation is necessary to determine where to place the substantial end-frame posts which have been such an integral part of North American anti-telescoping design practice for so long. Their strength, along with the strength of the connections and supporting structure at their tops and bottoms must be rationalized with the strengths of the roof and underframe which are necessary for CEM.

Buff Strength. International

European equipment has been designed to a UIC standard which specifies the equivalent of about 450,000 lbf buff strength. This now appears in a draft European Standard by the European Committee for Standardization (CEN),⁴ which permits the strength to be at coupler or buffer level

⁴Reference 9.

North American Passenger Equipment Crashworthiness (continued)

"as appropriate". A lower buff strength, about 340,000 lbf, is permitted for equipment not subject to humping or loose shunting (a note indicates this is appropriate for "fixed units"). A compressive strength of 90,000 lbf is required 6 inches above the floor, 67,500 lbf at waist-rail height, and 67,500 lbf at cant rail height.

European high speed designs are, at least in some cases, designed to loads significantly greater than required by the CEN. For example, the cab end of the TGV-2N power car has been designed to a requirement for 340,000 lbf compressive strength below the windshield, and 160,000 lbf at roof level. The cab floor is required to have not less than about 675,000 lbf compressive strength.

Our research has indicated that the Japanese "Bullet Train" equipment has been designed to a buff strength requirement of 220,000 lbf. The JR is applying the concepts of CEM to its equipment.⁵

The buff strength values discussed above are shown on Figures 1 and 2.

Anti-Climbing Arrangement

The practice has been that anti-climbing protection is afforded by tightlock couplers built into pockets at the ends of cars. The vertical anti-climbing strength on coach-type equipment is a minimum of 100,000 lbf at yield, provided by the coupler bearing on the buffer beam in the upward direction, and the coupler carrier in the downward direction.

With such arrangements, anti-climbing at the impact zone in a collision involving MUs or cab cars is provided by the couplers either mating, or lodging under the opposing car's buffer

⁵Reference 10.

North American Passenger Equipment Crashworthiness (continued)

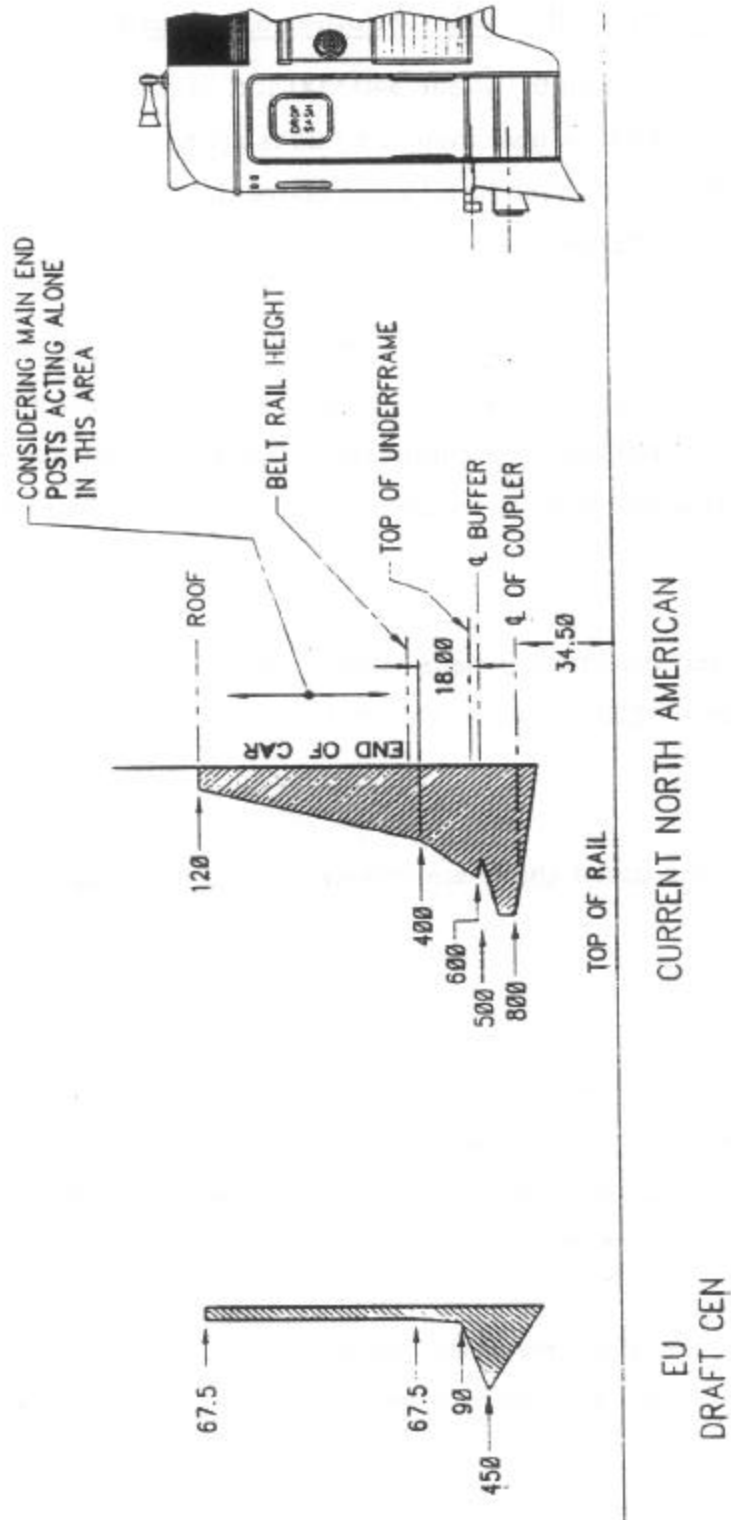

Figure 1

North American Passenger Equipment Crashworthiness (continued)

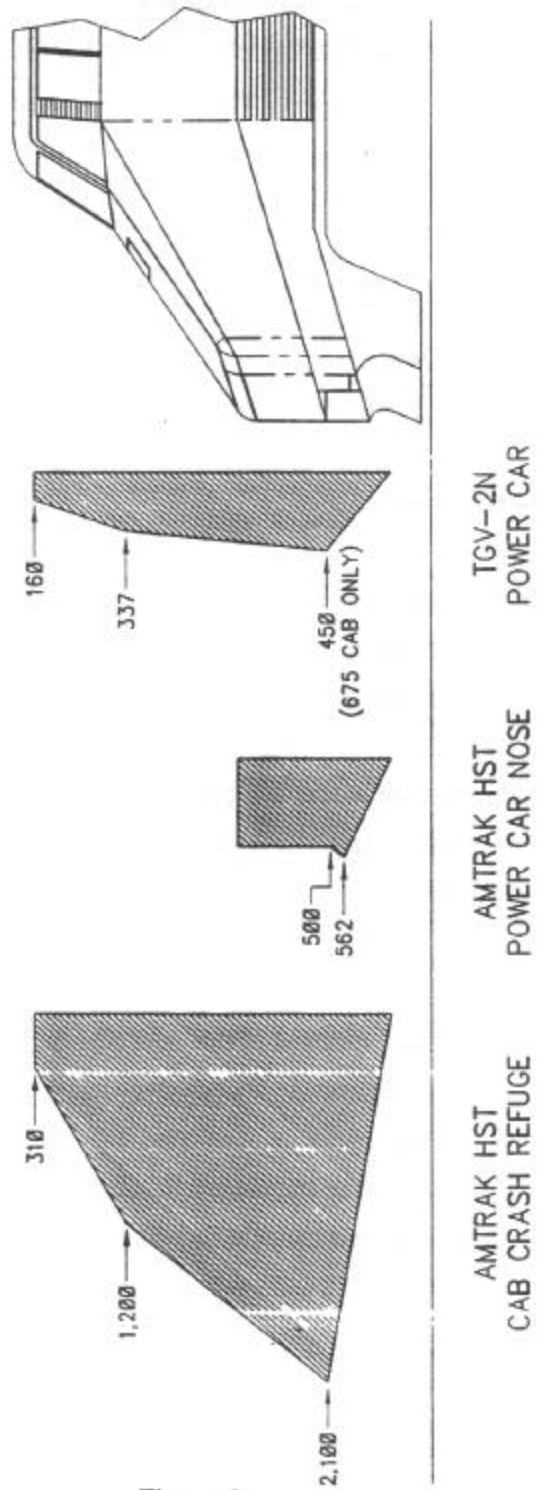

Figure 2

HIGH SPEED ROLLING STOCK

North American Passenger Equipment Crashworthiness (continued)

beam, or by the buffer beams directly. The Amtrak HST power cars and high speed electric locomotives will also have ribbed anti-climbers. This is a familiar transit practice, but represents a reappearance on US railroad locomotives after a 30-year hiatus.

With the advent of AAR Standard S-580 in 1990, locomotives have been required to have a vertical anti-climbing arrangement with a vertical strength of 200,000 lbf at ultimate. This is a more severe requirement than the one for coach-type equipment, but the difference in the failure criteria (yield for coach-type equipment, ultimate for locomotives) reduces the apparent difference indicated by the strength values.

For the Amtrak HST, the vertical strength of the anti-climbing arrangement on the trailers will be equal to the weight of the heaviest trailer, or about 130,000 lbf, a 30% increase over the previous value from AAR Standard S-034. A vertical strength of 100,000 lbf is sufficient to lift the end of a coach, MU, or cab car with the truck attached at the lifted end, and resting on the truck at the other end, even including a significant dynamic augment that might result from a collision. The 30% increase represents additional margin for dynamic augment at the costs of some added structure and, therefore, weight, but the increase satisfied FRA's desire for improved strength for Amtrak's high speed trainsets.

For the future, the levels proposed in the ANPRM for Tier I equipment are essentially the same as the current AAR requirements for locomotives and cars, which is considered appropriate. However, the effects of what is being proposed for Tier II equipment are not possible to determine without their being further developed to establish requirements which are shown to be practical, achievable, effective, and capable of being evaluated.

North American Passenger Equipment Crashworthiness (continued)

End Frame Strength

North American design practice has included significant "vertical end members" or collision posts, securely connected to and supported at the bottom by the underframe and at the top by the roof. The AAR Standard has required each of two collision posts to have an ultimate shear strength of 300,000 lbf at the floor. The strength above the floor is not specified, but, if designed to the minimum requirements of the Standard, a calculation based on a pinned-end assumption indicates a strength of about 50,000 lbf at yield when loaded 18 inches above the floor. For the past 20 years (approximately), design specifications have required 300,000 lbf at 18 inches above the floor at ultimate, per post, a significant increase over the minimum requirements of the Standard.

The AAR Standard includes a requirement for a minimum total section modulus for all vertical end members, and the minimum portion of the total section modulus that must be in the collision posts. Designs with collision posts just meeting the minimum requirements typically met the requirement for total section modulus by distributing the difference in "corner posts" at the extreme body corners, or the body corners for designs with end vestibules.

This North American practice has a counterpart in the European Standard in the requirements in the latter for the loads above the floor mentioned in the discussion above about buff loads. The major difference is that, in the draft European Standard, the loads are to be resisted by the "end wall" (and thus the body shell profile); there is apparently no requirement for discrete vertical end members with sufficient strength to resist the specified loads. As far as we know, this is the only counterpart in international practice to the North American collision post.

Amtrak HST trailer collision posts will be designed to the current North American requirements, except that the reaction at the top must be a minimum of 60,000 lbf. The

North American Passenger Equipment Crashworthiness (continued)

requirements for the power car are increased significantly above the current values, as has already been mentioned above as part of the discussion of buff strength. The loads apply to a substantially-built wall at the front of the cab, with five posts across the width of the cab. Three posts, one in the middle, one on each side, continue from the top of the collision wall to the roof. The total strength available in the end frame structure at the front of the cab is from two to three times the strength of typical designs to the current North American standard. On the other hand, the strength of the nose of the power car is less than would result by application of the current standard, which is necessary to maximize the benefit of the crushable, energy absorbing structure in the nose of the power car.

In the FRA ANPRM, the proposed collision post requirements for Tier I equipment can be generally described as the current practice for non-cab ends, and AAR S-580 for cab ends. Tier II requirements are formulated around the unitized collision wall concept for power car cabs. For articulated or otherwise permanently joined units, it is proposed in the ANPRM that collision posts only be required at the ends of the trainset, and not at ends of units interior to the trainset.

The capability to transfer a minimum of 400,000 lbf from the end frame structure to the roof is proposed. This is well above any value that has been achieved or specified to date. This and the other the collision post requirements proposed in the ANPRM, particularly the ones for Tier II, are undergoing further analysis regarding their benefits and for their effects on weight and cost.

Truck Connection Strength

This has been another cornerstone of North American practice since the issuance of the AAR passenger equipment standard in 1939. The requirement is a simple strategy for safety in derailments and collisions, achievable with very little weight increase. It was included in the AAR Standard as a result of a disastrous telescoping in a wreck in 1938, where a heavyweight

North American Passenger Equipment Crashworthiness (continued)

telescoped most of the length of the lightweight to which it was coupled. The center plate attaching rivets on the heavyweight sheared, and the truck dropped to the ground. If the truck had stayed attached, its mass would have helped keep the car from rising up. Also, if all else failed, the truck, still attached to the bottom of the car, would have struck the end sill of the lightweight, and prevented further telescoping up to the point where the strength of the truck attachment was overcome. Also, in a derailment with the trucks plowing ballast and dirt, they can apply a high retarding force to the cars to bring them to a safe stop while, with the assistance of the tightlock couplers, maintaining the car upright. So, ever since that time, trucks have been required to be locked to the car body so they remain attached if the car rises up (or is raised), and the connection must have a 250,000 lbf ultimate horizontal strength. This requirement, with a few refinements, has been applied to all railroad equipment since the first issuance of the AAR Standard in 1939, and is required for the Amtrak HST. The proposed requirement in the ANPRM is essentially the same as current practice. As far as we can determine, there is no counterpart in the draft European Standard, or in Japanese design practice.

MU Car and Cab Car Corner Posts

There is no specific requirement for corner post strength in AAR S-034, AAR S-580, or the current FRA regulation for "MU locomotives". As explained above in connection with end-frame collision post design practices, the AAR S-034 requirement for total section modulus in vertical end members was often satisfied by including some of it in extreme corner or body corner posts. In spite of there not being a specific requirement for corner posts in the Standards or the existing FRA regulations, substantial corner posts have been part of North American practice, and have been consistently applied to MU and cab cars for at least thirty years.

Requirements for "extra-heavy" corner posts were included in the 1966 specification for the cab ends of the original Budd-built Pennsylvania Railroad Metroliners. Each cab corner post was

North American Passenger Equipment Crashworthiness (continued)

required to have 2/3 the strength of a collision post, and a shear strength at the top of the floor of 200,000 lbf, was specified. This should have been relatively easy to achieve because the cab ends of the original Metroliners did not have a vestibule with low-platform steps, and the side sill could be used to effectively support the bottom of the corner posts. Several designs since that time with low-platform steps interrupting the side sill have achieved 150,000 lbf shear strength at the bottom by using extra-heavy buffer sills, and by reinforcing the edge of the trap door over the steps to transmit the corner post bottom reaction load into the side sill.

The Amtrak HST trailers may eventually have one low-platform step on each side, but the rest of the side doors will be high platform, with the side sill extending all the way to the buffer sill. Metroliner-style corner posts will be used at all extreme body corners. If a low-platform side door is eventually incorporated, there will be structural posts on both sides of the opening, with 150,000 lbf and 200,000 lbf shear strength at the floor for the one at the extreme corner and body corner, respectively.

Corner post specifications have typically included a load at 18 inches above the floor, and a requirement that the connections at the top and bottom be capable of supporting the posts loaded to ultimate capacity at the specified points. For the first time that we are aware of, the Amtrak HST specification includes a minimum reaction load at the top of the corner posts of 20,000 lbf. This is about double what has been achieved in existing designs in service, but was confirmed by the bidders as being achievable.

In the ANPRM, the proposed corner post concepts are generally in line with current practice, but, in some cases, the specified design loads are well above current practice. A "unitized type of end structure" is permitted for Tier II, but if discrete posts are used, for trailers they must be able to resist 80,000 lbf, four times the Amtrak HST reaction load value, and roughly eight times the reaction load currently developed by existing designs at the tops of corner posts.

North American Passenger Equipment Crashworthiness (continued)

The proposed requirement for the strength of power car corner posts at top is 133,000 lbf, compared to 80,000 lbf for the Amtrak HST power car. The difference here is even greater than indicated by the numbers, however. The 80,000 lbf requirement for the Amtrak HST power car applies only to the cab crash-refuge module, but the higher value proposed in the FRA ANPRM is apparently intended to apply to the entire structure of the power car. To explain, a requirement for a high corner post strength at the top is a more severe requirement for the structure supporting the post than it is for the post itself. It is relatively easy to achieve a high shear strength in a post using high-strength materials. There is no value in having such a strong post unless the supporting structure, in this case, the roof, and more specifically in North American parlance, the roof rail, can also withstand such a load. This is another area in the FRA ANPRM where a significant increase in the requirements compared to current practice is being proposed. It is strongly recommended that the values in the ANPRM for corner post strength at the top be replaced with values which have been shown to be achievable, and to postpone any further escalation in strength values until sufficient R & D can be performed to establish the benefits of greater strengths.

Roll-Over Protection

This is another area addressed by current passenger car design practice in part by a set of requirements that add up to strength and toughness in the sides and roof. In the past, the requirements have not, at least in any specifications we are aware of, been consolidated under the heading "Roll-Over Protection", and thus it may not be generally understood that the current practice does, in fact, address roll-over protection.

A substantial rail below the windows, called a belt rail, has long been used in the construction of cars in North America. Years ago, heavyweight, girder-type steel cars used a wrought section which was custom rolled just for that purpose. Lightweight designs of stainless

North American Passenger Equipment Crashworthiness (continued)

steel duplicated the strength of the hot-rolled section with a rail built in the side frame, and gusseted at intersections with full-height side frame posts to act as a continuous member. This helps resist end loads, and also provides a substantial member at an ideal location to protect passengers in side-swiping and side-impact incidents, and if the car rolls-over on its side in a collision or derailment. If the best method of protection is prevention, then perhaps the primary method of roll-over protection is the tightlock coupler, which has sufficient strength to withstand several g's lateral force at the c.g. height of a typical railroad coach.

Perhaps another little known fact is that the full-length purlins in the roof of some existing stainless steel cars were incorporated as a result of roof damage in a wreck on the New York Central on April 19, 1940, at Little Falls, New York. This was a disastrous wreck, where some cars came to rest on their sides, and some were catapulted onto the roofs of other cars. The wreck took a high human toll, with 30 people killed and far more than that injured. Getting back to the changes in roof design as a result of this wreck, while it is true that the purlins are in line with and assist in supporting the tops of the collision posts in such designs, they were labeled "skid rails" by their designers because they were intended to minimize the chance of gross failure of the roof in rare cases of complete overturning.⁶

In addition, AAR Standard S-034 has requirements for minimum side and roof sheathing thickness, and minimum side and roof framing member section modulus. These requirements assist in minimizing the chance of penetration and collapse of the sides and roof in case of roll over.

For approximately the last 10 years, some specifications for railroad passenger equipment have specified static lateral loads to be applied to the belt rail and side sill. For the belt rail, these were intended to emphasize the need for a stable, continuous-acting belt rail to help resist and

⁶Reference 2.

North American Passenger Equipment Crashworthiness (continued)

distribute loads that might be applied in side-swiping, side-impact, and roll-over incidents. The underframe of a rail car, including the sub-floor pan and the floor panels, is, in the horizontal plane, a plate girder, and can be used to resist lateral forces without change except perhaps for improvements in connections. One connection that may need improvement is between the major underframe transverse members ("cross bearers") and the side sill. These connections are designed primarily to transmit vertical shear. The lateral load requirement at the side sill requires that some thought be given to designing those connections to also be effective in transferring axial loads into the underframe transverse members, so that, for example, side-swiping loads can be more effectively resisted by the underframe considered as a plate girder.

The Amtrak HST Specification contains all of these requirements. The load at the side sill has been increased compared to current practice, to 80,000 lbf over any 8 ft length of the side sill. A section titled "Roll-Over Strength" was added, giving specific methods of evaluation and failure criteria for the conditions of a car rolled over on its side, and on its roof. These were also confirmed by the bidders as being achievable.

The FRA ANPRM contains proposed requirements for roll-over and side-impact strengths. The requirements as stated will have to be interpreted for the purposes of designing structures to the requirements, and showing by calculation that the requirements have been satisfied. Regarding roll-over strength, it is stated in the ANPRM that it is believed "existing North American designs will likely meet this requirement". They may, but it should be known whether or not they meet the requirement, and, if they don't, the scope, cost, weight increase, and benefits of modifications necessary for compliance should be known. And, compliance will depend on agreement with the interpretations that were applied during design and stress analysis.

A side impact strength requirement based on a impact by a loaded highway tractor trailer is proposed in the ANPRM. While it may be possible to eventually develop a requirement on this basis, this goes well beyond current methods of specifying side impact strength, and the benefits

North American Passenger Equipment Crashworthiness (continued)

to be gained from such a development effort are not clear to us. This much is clear; if it is absolutely necessary to specify side-impact strength on the basis of a dynamic scenario such as is being proposed, then further development is absolutely necessary, because the requirement as stated in the ANPRM is again subject to interpretation, even more so in this case than in the case of the proposed roll-over strength requirement.

Crash Energy Management

This is another area of car design which has been addressed in the past in North American practice in spite of the fact that it is not specifically covered by the applicable the standards and regulations. Car designers have been concerned about "protecting occupied volumes" without necessarily applying that label to their efforts. E. J. W. Ragsdale captioned a photograph of some Budd lightweight equipment after a wreck as follows: "The resilient yielding of the car ends saved the rest of the structure and, incidentally, also the passengers".⁷ Designing cars for crushable, energy absorbing ends is mentioned in a 1926 publication of the Railway Training Institute: "The structure, above all the ends [meaning the body ends in a car with low-platform end vestibules], has been so developed as to be as nearly indestructible as is possible. The platform, vestibule, and its hooded covering are often so constructed that they will collapse under a less shock than is required to crush in the end of the car itself - this "give" tending to absorb the shock of collision, and prevent damage to both car body and passengers." An illustration in the book shows the end-vestibule platform mounted on sills that are apparently separate from and of lower strength than the main body sills, so that they will crush back and absorb energy well before any damage is suffered by the "occupied volume", *i.e.*, the body.⁸

⁷Reference 2.

⁸Reference 4.

North American Passenger Equipment Crashworthiness (continued)

For years, specifications have required static car body buff strength to progressively increase from the ends to the middle of a car to help avoid structural collapse in the occupied volumes in the event of a collision. With the exception of one in the mid-1980s for a transit car that was never built because the project lost political support, the concept of controlled crushing has not been included in specifications for North American rail equipment until recently, in the Amtrak HST specification and now others.

Crash Energy Management has been discussed often enough by now that there is no need to dwell on it here. There have been many informative presentations concerning the CEM requirements in the specifications for the Amtrak high speed trainset and electric locomotive. The automotive industry has performed considerable research on these ideas, and has incorporated the results of the research in successful designs for many years now. For rail cars, there have been excellent developments in Europe and the UK recently, and they truly deserve much praise for developing practical ways to implement these ideas. In these cases, the benefits are clear; they have been demonstrated.

The ANPRM includes a proposed requirement for CEM design. It is imperative that the requirement be kept within achievable bounds. That comes down to the evaluation scenario which is ultimately selected and included in the eventual regulation. The scenario must be realistic, and the CEM requirements must be achievable and of proven benefit. The high speed trainset-to-trainset collision scenarios which have been under discussion in connection with the ANPRM go well beyond what has been developed to date, and are not capable of being achieved without considerable further development, if at all. It is recommended that the scenario be the same as or similar to the ones currently in existence as a result of the work in this area internationally, or as it appears in the Amtrak specifications, which has been ratified as achievable by these same international developers of the concept. Regarding high speed trainset-to-trainset collisions, the best, if not the only method of protection is prevention, by safe system design and operation.

North American Passenger Equipment Crashworthiness (continued)**Conclusion**

We have attempted to once again demonstrate that North American railroad passenger equipment design practice has developed to the point where all of the issues in the ANPRM are already addressed in some fashion, as described in this paper. What we have now is known to be achievable. There is no question that refinement is possible, and perhaps even necessary. We have indicated areas where the requirements in the ANPRM represent significant leaps forward in the technology. These should not be implemented in a regulation until sufficient R & D is performed to establish that they are achievable and will return benefits that make the necessary development worthwhile.

Probably the area of most concern in the collision scenario for the purpose of implementing CEM. From the perspective of the structural designer, it is unfair to charge them with the responsibility for safety of passengers and crew in a high speed trainset-to-trainset collision, especially because the book of design guidelines for preserving occupied volumes and limiting peak accelerations in such collisions has yet to be written, and because, as has been stated many times, high speed collision simply must be avoided. Whatever is ultimately included in the new regulation must be known to be achievable and of benefit. Better yet, the regulation could be in general terms, so that the industry can apply CEM technology at the state-of-the-art level when the regulation becomes effective, and at higher levels as time goes on and further developments are made.

North American Passenger Equipment Crashworthiness (continued)**References**

1. American Association of Railroads, "Specifications for the Construction of New Passenger Equipment Cars", AAR Standard S-034-69, AAR Manual of Standards and Recommended Practices, Section A, Part III, Passenger Car Requirements. (Section A, Part III discontinued as of September 1, 1989.)
2. Ragsdale, E. J. W., Chief Engineer, Railway Division, Edward G. Budd Manufacturing Co., "A Summary Report of the Testing of Railway Passenger Cars and of the Materials of Construction," Edward G. Budd Manufacturing Company, 1941.
3. Russell, T. H., M.A., LL.D., Editor in Chief, "Car Shop Practice", Railway Training Institute, Chicago, Vol. II, 1926.
4. Smith, C. M., Senior Engineer, LTK Engineering Services, Memorandum of Research of AAR Tightlock Coupler Strength Testing, June 21, 1996.
5. US Department of Transportation, Federal Railroad Administration, Advanced Notice of Proposed Rulemaking, "Passenger Equipment Safety Standards", published in the Federal Register, Vol. 61, No. 117, June 17, 1996, p. 30672.
6. Woodbury, Clifford A., 3rd, "Rail Vehicle Structures and Their Crashworthiness", presentation at the 1991 Annual Meeting of the Transportation Research Board, January 1991.
7. Woodbury, Clifford A., 3rd, "Discussion of the Standards and Regulations Affecting the Design and Operation of Passenger Cars and Locomotives", presentation at the 1996 Annual Meeting of the Transportation Research Board, January 8, 1996.

North American Passenger Equipment Crashworthiness (continued)

8. Woodbury, Clifford A., 3rd, "Some Thoughts on Design Standards for Passenger Cars and Locomotives", presentation at the 1996 ASME/IEEE Joint Railroad Conference, May 1, 1996.

9. European Committee for Standardization (CEN), "Structural Requirements of Railway Vehicle Bodies", published by the Central Secretariat, rue de Stassart 36, B-1050, Brussel, draft of March 1995.

10. Takeda, S., Senior Engineer, LTK Engineering Services, Memorandum of Translation of May 9, 1996 Letter from Japan Railways, May 14, 1996.

Design Considerations for Rail Vehicle Crashworthiness

MS. SEVERSON: The next speaker this morning is Dr. Herbert Weinstock. He is the Chief of the Structures and Dynamics Division of the Volpe National Transportation Systems Center of the Research and Special Programs Administration of the United States Department of Transportation. In his position he is responsible for engineering and research programs and projects in the areas of structures and dynamics related to safety and performance of transportation vehicles, guideways, and structures. These projects include studies of vehicle suspension systems, vehicle guideway interaction, vehicle and guideway structural integrity, collision avoidance, collision energy management, structural stability, fatigue, fracture, and mechanics of wear.

A significant portion of the Division's work is in support of programs of the Office of Research and Development of the Federal Railroad Administration, which are directed towards establishing the technical basis for improved safety specifications and needed regulatory actions. Dr. Weinstock's contributions to the study of the dynamic interactions between rail vehicles and track have included the development of the two-point rail-wheel contact theory that resulted in an improved understanding of the curving behavior of rail vehicles, identification of mechanisms of dynamic instability in guided steering trucks that were not previously understood (this is called the Weinstock effect), and improved criteria for establishing safety from derailment during rail vehicle-track dynamic interaction testing (the Weinstock criteria) and approaches to track geometry specifications to assure safety from derailment.

Dr. Weinstock received his bachelor's degree in mechanical engineering from the City College of New York, and degrees of Master of Science in mechanical engineering, and Doctor of Science in mechanical engineering, with specializations in applied mechanics and control systems from the Massachusetts Institute of Technology. He is a member of the American Society of Mechanical Engineers and is registered as a professional engineer in the Commonwealth of Massachusetts. Dr. Weinstock's presentation this morning covers the design considerations for rail vehicle design.

DR. WEINSTOCK: First I'd like to thank Dr. Woodbury for giving us an excellent review of the current state-of-the-art in terms of the application of existing crashworthiness standards. At the recent ASME/IEEE Joint Railroad meeting he gave an excellent paper, which I suggest people look up, describing the history of these standards and criteria and how the requirements evolved. A good deal of the current standards and current practice was developed on a heuristic basis. Something happened, corrective action was taken. Assembled groups of wise engineers, wise manufacturers got together and said, "Look, how much bigger should we make this? How much stronger should we make this?" But the thing that is strongly missing in the history is a definition of the performance requirements and how these requirements relate to mechanics and design practice. We must still provide quantitative answers to questions like, "What closing speed can be developed before we achieve a climbing situation? To what level of speed can we control over-ride before it happens with a specified anti-climbing devices? How much protection is provided by a collision post of a given strength?"

In this presentation, we would like to step back and ask some fundamental questions relating to the mechanics of collision and design options available for controlling their consequences.

SLIDE 1

In many of our conversations on crashworthiness, we frequently enter into a discussion of the trade-offs between investments in accident avoidance and crashworthiness design. Each of our transportation systems have measures built into them and have operating practices which are intended to prevent collisions from occurring. Train accidents are not supposed to happen. We don't want them to happen. If I'm a designer of something, I don't want people breaking it; I don't even want to think about something like that happening. The difficulty is that they do. And the accidents do not limit themselves to closing speeds of five miles per hour or ten miles per hour, or even forty miles per hour. As noted in Slide 1, the accidents that we've seen this year had closing speeds of the order of seventy miles per hour. And the Chase, Maryland accident in January of 1987 happened at over one hundred miles per hour. In our design considerations and in our operating practices, are we doing as effective a job in terms of protecting people as we know how to do? Would providing increased levels of protection really cause horrendous increases in weight or cost? Our mission in this symposium and in part in my presentation is to see if we can develop some of the information and some of the trade-off data related to designing crashworthy railroad vehicles.

I would appreciate your indulgence while I attempt to review some of the fundamental considerations based on engineering mechanics related to crashworthiness design.

SLIDE 2

First, let's be sure that we understand some of our definitions. The situations we're out to control (that is keep fatalities from getting out of control in these situations), are conditions where we have an impact between the train and an obstacle. When there's an impact between two trains we do have the potential for an override. The override can be produced by a wedging action resulting from the geometry of the impacting structure. It could be produced by the pitch response of the vehicles. Even if override does not occur, we will develop structural failures which result in collapse and crushing of the vehicle's structures. People get hurt if they're trapped or impaled within the collapsed structure; and if they impact a device or an object that is capable of causing them injury as a result of the secondary collision.

SLIDE 3

Slide 3 illustrates the override potential produced by the wedging action. Here we have two locomotives after a recent collision. Our colleagues at Arthur D. Little Inc. did a very nice job of simulating this situation and developing tools and a methodology which we can start to use for predicting the consequences and predicting what the effects of modifications in the design might have. These have been explored partially, and there is a set of reports that are available on the studies that they did. Within that interaction, they had looked at some in terms of the kinematics and dynamics of the situation. So where we have the initial impact, the first effect is that the geometry shown in Slide 3 is likely. This geometry permits the two couplers to meet and ride over each other.

SLIDE 4

If events proceed as indicated in Slide 4 the coupler should become trapped in the structure. However, we found that the limitations were on the support structure of the coupler and the draft gear support. The Association of American Railroad's standard S-580 does specify the strengths of key structures involved in the collision. However, failures of supporting structures whose strength are not specifically specified in the standards provide the potential for an override situation. Our objectives have been to be sure that we understand these mechanisms and have developed appropriate predictive tools. Working with these predictive tools we hope to be able to quantify how much a change in design is going to affect survivability. In this case, the survivability of the person in the locomotive car.

SLIDE 5

Slide 5 illustrates the scenario of two trains meeting head-on. Since the impact point tends to be below the gravity center of the cars, they will tend to bow into each other. This produces an opportunity for an override of one lead car into the other leading car. While this pitch is occurring, we also have the opportunity for the rear car to come in underneath it. Prior to the '70s, this type of override was not uncommon. One of the things that has been successful at reducing the incidence of this type of override has been the tight-lock coupler.

SLIDE 6

As Frank Cihak noted in his talk, compatibility, similarity of vehicles, is extremely important. As shown in Slide 6, if we have mismatches between the sill heights, we have an invitation for override and the telescoping of one car into another. In some of our newer operations where we are operating commuter equipment in a mix with the general freight system, we have to be very careful that the equipment we're introducing is reasonably compatible in the event of collision. Otherwise, we are inviting telescoping and override conditions.

SLIDE 7

As noted in the literature and the discussions in this symposium, lines of defense against override include the tight-lock coupler between cars, use of improved anti-climbers, controlled crush characteristics, higher strength of superstructures and mechanisms that will cause entrapment within the collapsed structures. Our colleagues in England and in France, and Frank Cihak of APTA noted in their discussions that as far back as the '60s, people were talking about using controlled crush zones. They also proposed using a sacrificial volume and a careful design of collapse loads. The intention would be to provide a more gradual development of peak loads that would result in enough time for the anti-climbing devices to engage properly and produce an entrapment between the cars that will prevent an override from occurring and keep structures together.

SLIDE 8

In the event override has occurred, the effective use of collision posts may provide protection against intrusion into the occupied volumes of the car as shown in the top portion of Slide 8. Slide 8 provides a sketch of the type of crush zones that the researchers at British Rail have been studying and testing. They have designed the ends of the car structure to be sacrificial with

the collapse of the crush zones developing lower forces and providing a little bit more time and ability to control the interlocking of the anti-climbing devices. This approach appears to be quite helpful as demonstrated by the tests that they have conducted.

SLIDE 9

Slide 9 provides a list of options available to the designer for controlling the consequences of override. Using collision posts, integrated end structures, and potentially increasing strengths of superstructures may be sufficient to move the line of action of the forces closer to the gravity center to limit the pitching behavior. Strong collision posts and a very high strength occupant compartment which act to prevent intrusion into the passenger volume would be expected to reduce injuries and fatalities.

SLIDE 10

This slide shows a schematic of a recent collision. For this scenario, we have to ask some questions on the mechanics of the impact, the structural damage and the resulting derailment. A cabcar-led commuter train has passed through a stop signal and is traversing a switch and entering a main line track at a speed of 18 mph. A locomotive-led train was moving along the track at 53 miles per hour resulting in a closing speed of 71 miles per hour. Fortunately, the cab car led train had not fully entered this track. If it had been fully on the main line track, we would have had a head-on collision with much more damage. As shown in Slide 10, at the time of impact, it appears that the mechanics were such that a side force was induced between the locomotive-led consist and the cabcar-led consist. This side force succeeded in derailing the train moving along at 53 miles an hour, and also derailing the cab car. At the end of the collision, the cab car was at the side of the locomotive-led train consist, and the locomotive pulled its consist over the other side of the track the track. A recurring question for this type of scenario is whether the derailment acted as a safety valve on the situation, in terms of limiting the amount of damage that occurred. On the other hand, if you have a derailment in a place with a bridge or a place with parallel tracks, you can wind up increasing the consequences enormously. We are conducting analyses of the dynamics of this situation and trying to develop an understanding of the trade-offs.

One of the efforts that we're initiating now through contractor studies is developing better understandings of the mechanics of override, especially in dealing with cab cars. We are also considering what measures are available to keep cars in line and what the sensitivity to variations in design might be. The emphasis of all of these studies is establishing relations between parameters that can be controlled by the designer and safety performance as measured by survivability of occupants of the trains.

SLIDE 11

Let me review a little bit of mechanics and the behavior of cars when they do collide and they do crush. One of the things that characterize and still tends to characterize most of the passenger cars that are built currently is an essentially uniform crush force characteristic. This definitely has its limitations, as we will show. Concepts that have been explored by the French and explored by the English and explored by us in the discussions that we engaged in with AMTRAK and the FRA in the development of crashworthiness specifications for the American Flyer

specification include crash energy management concepts. In applying crash energy management concepts we are trying to distribute the deformations throughout the train to minimize crush of occupied volumes and to maintain survivable environments.

SLIDE 12

So now we'll get back to some fundamental physics. If I'm out to limit the crush of the car, what I do in an automobile (what I do in almost any vehicle) is try to decelerate the vehicle as fast as I can without injuring people. People can tolerate for a well-designed seatback an impact velocity with the seatback surface of the order of 30 kilometers per hour. Slide 12 shows the impact velocity that a seated unrestrained passenger would experience in a train, undergoing a constant deceleration as a result of a collision, for several assumed seating pitches. The train deceleration for a constant crush force characteristic is the ratio of the crush strength of the train to its mass. That would mean that if we had—and taking the situation of a uniform deceleration—a nice tightly packed compartment, we might be able to safely decelerate about something like 9 or 10 g's. If we loaded the car to minimize the space available for the passenger (and this might be an option that people may consider, saying that we packed the seats closer for your safety and we can put more passengers in the same volume) we might be able to sustain higher decelerations. However, I'm not sure that would sell too well. When we start getting into more comfortable seat spacing as Amtrak is planning, what we're saying is that we probably would want to keep the deceleration below, say, 6 g's. The design target would be between 4 and 6 g's for the average deceleration on the initial train impact to minimize the crush and keep the impact speed with the seat in front to within 30 km/hr.

SLIDE 13

If we look at a train with a uniform crush strength that is meeting another train that's identical to it, the amount of crush that we're going to need to absorb the collision is controlled by the ratio of the crush strength to the effective weight. If we're talking about eight 100,000-pound cars designed that way, and if we were talking about a uniform strength of 800,000 pounds, that would translate to 1g. As shown in Slide 13 this means that with a collision speed of just 30 miles an hour you'd wipe out 25 feet of volume; and with a collision speed of 50 miles an hour you'd wipe out something like 75 feet. Accordingly, our recommendation in the 1978 Symposium on Rail Car Crashworthiness was that if you have to be involved in a crash, sit in the middle car. Stay away from the ends.

SLIDE 14

In terms of physics, there's relatively little you can do about the total energy that must be dissipated in a collision. You have to absorb this much energy. But now people have looked at what kinds of things can be done to distribute the energy that must be absorbed by structural deformation. And if we're ready to introduce some sacrificial zones having a lower crush strength than the occupied volume there is a potential to improve passenger safety. As shown in Slide 14, for the sake of argument, I used four times the weight of the car, eight times the weight of the car, and twelve times the weight of the car for different segments of each car. If we also introduce a breakaway coupler as done by the English, the cars will engage in effectively independent collisions and we maximize the use of the sacrificial volume that you have in that design condition. (I've called this the privatization or free enterprise approach to occupant

protection in that each car is individually responsible for its own survival.) In Slide 14 we scaled the length of the front sacrificial zone for a 22-mile-an-hour collision into a train traveling an equal 22 miles an hour in the opposite direction, for a closing speed of 44 miles an hour. What happens is that as the lead car is engaging in its collision, the trailing car doesn't know too much about it. As each car is engaging in its collision, it is unaffected by the other cars in the consist. Just as the first car finishes its collision, the next car in the train comes up, kisses it at the end and starts its collision. This will produce your most efficient use of the sacrificial zone.

The reason that Slide 14 shows stepped force-crush characteristics is that we might want to create situations with a second line of protection. We might desire to make the initial collision deceleration 4g's and limit it to that for low impact velocities while being willing to decelerate occupants at a higher acceleration than the 4g's in more severe collisions. This kind of strategy could be used.

SLIDE 15

We also considered what would happen if we take that same set of cars and put them in a train with no gap between cars as shown in Slide 15. As shown in Slide 15 we get a lower deceleration to start off, with all of the cars decelerating at $4/3$ of a g.

SLIDE 16

Slide 16 shows the stages of the crush of the crush zones of these cars for the case of a closing speed of 50 miles an hour. The two trains are moving towards each other at 25 miles an hour. In the first stage we lose some speed and we wipe out the crush zone at the front of the first car. If the speed were much lower, this sacrificial zone would be the only zone affected. As the crash proceeds we wipe out this sacrificial zone and we start moving back in the consist, and we have the crush being transferred to the other cars in the consist. The effect, as shown in Slide 16, is that as we proceed the crush gets transferred from the front to the next sacrificial zone to the next sacrificial zone, so that the front cars to a degree act to protect the cars following, and we have gradual crash. One of the advantages of the step crush is in the minor collision you only have to repair the first car; you don't have to repair all the cars. With the gap in each car acting independently, any collision requiring repair of one car will require repair of all cars. So there are some trade-off considerations there.

SLIDE 17,18

The sequence of crush for this train configuration for a closing speed of 76 miles per hour is shown in Slides 17 and 18.

SLIDE 19

However even for the extreme 76-mile-an-hour collision shown in Slide 17, if the distance between the head of the occupant and the seat in front is less than about two feet, as shown in Slide 19, we've kept the secondary impact speed to the range that we know how to handle with interior padding and with good seat back design.

The major point of this discussion is not necessarily that either one design approach or another should be used, but that the options are available to the designer. By considering the results of simulations and by the use of some of the modern design and analysis tools that we currently have available, we can decide where we want the car to crush; how we want the cars to crush, and how the energy is to be dissipated. So we now have a potential to control this situation. These were some of the considerations when we started to do some of our analyses in to support the discussions related to potential crashworthiness of trains for Amtrak's high speed applications.

SLIDE 20

Slide 20 provides a listing of some of the work that we have been engaged in over the last six or seven years. This work was partly inspired by the potential for the introduction of high-speed equipment being built to different specifications from those in the United States and partly inspired by the increase in commuter operations, particularly commuter operations entering the general railroad system. The work was also motivated by a need for the FRA Office of Safety to provide Congress with an evaluation of the degree of effectiveness (what degree of protection is being given to people) in improving crashworthiness which is provided by the use of the AAR's S-580 standard in locomotive design. Congress also required a study of the sensitivity of potential injury, potential cost, potential impact to modifications or changes in the design.

SLIDE 21

To facilitate the conversations that we had on the American Flyer, David Tyrell and Kristine Severson of the Volpe Center have performed analyses of options for employing a crash energy management concept within constraints and within judgments where we felt that sacrificial zones could be introduced into the car or into the train. Since this train is an integral trainset, the philosophy employed here is fairly similar to that used by the French. We have regions of unoccupied volume. We have a need to protect the operator (protect the locomotive engineer), so we want to be able to provide a crush zone to at least reduce his impact. We have a bit of space in the locomotive where we could readily sacrifice volumes, and we have vestibule areas that could be used for crushes.

SLIDE 22, 23

These are the simulation results that you've seen in the paper that Dave Tyrell presented at the ASME Winter Annual Meeting this past November and in several reports that you may have had copies of. In these analyses we have been performing parametric studies. We're doing a "what happens if," study. Where we are doing sensitivity studies, we do want to go through the full range of potential speeds to see what happens if an event should occur and what kinds of improvements we could effect. Whether it makes economic sense to do this starts becoming another set of considerations, but in order to make those decisions you need the kind of information we are developing to be able to exploit the tradeoffs.

SLIDE 23

Here we have the constrained crash energy managed design, and what you see is a distribution of the crush. You haven't reduced the energy that had to be dissipated; what we have done is to

move the crush energy around in a way that starts to reduce the amount of occupant volume that is lost. And in terms of secondary impact, the ability to at some level control and manage the energy provides an ability to provide much better protection for the passenger occupants. The analysis also does show (if this kind of approach is being used) that we want to do something special for the operator of the vehicle in terms of his protection. Since he is the operator in a much more constrained environment, we have potential for giving him more protection. I'm not sure anybody would be seriously ready for it yet, but air bags and specially designed seats would not be totally out of this world or totally unreasonable in this situation.

SLIDE 24,25

Some things you'll hear more about tomorrow are some of the sled testing, shown in Slide 25, that Kristine Severson with MGA Research has been doing on AMTRAK seat designs making use of the Hybrid-3 anthropomorphic dummies that National Highway Traffic Safety Administration has been kind enough to let us abuse. The results of these tests are being compared with simulation results using some fairly detailed models of the occupant in the interior. Some results of analyses using models developed by our colleagues at SRI International of the Occupant Secondary Impact Response are shown in Slide 26.

SLIDE 26, 27

SLIDE 27 illustrates the results of structural impact simulations performed by SRI International as part of efforts contracted for by the Volpe Center. This particular simulation shows the start of a potential override (telescoping) situation. Our colleagues at SRI International will be telling us more about some of the finite element models that they've constructed, and the essential results of their studies.

SLIDE 28

Slide 28 is also a chart I borrowed from SRI, which illustrates an analysis approach.

The major point I have been trying to make in these discussions is that we do have tools, we do have capabilities and techniques which can be used to make assessments of what the sensitivities of design changes and design options are, and what kind of fatalities can be prevented. The next step is developing the kind of costs and weight impacts they produce. This provides us a means by which we can solidly make the economic and social decisions that we have to make as to what becomes a reasonable crashworthiness specification and what can be done by design. There are uncertainties in terms of the actual ability to build equipment having the characteristics that we can glibly draw or design on the computer. The concepts must be proven in terms of actual hardware. We are looking forward to the experience of the French, the English and the people that have constructed crushable structures. We've been looking at some of the innovations that have been very effectively used in the automobile industry, where they are being extremely effective at designing crumple zones, causing the failures to occur in the way that they want them to occur, and to provide maximum protection to the occupant. And there's been a very dramatic change in automobile design practice over the past 40 years, particularly as it concerns crashworthiness: they are using the kinds of analytic tools that we're working with, and hopefully we'll hear a little bit more about similar potentials. Have I run over?

MS. SEVERSON: Thank you. [Applause] Any questions for Herb at this point?

FRANK DUSCHINSKY: Frank Duschinsky, Bombardier. I think I'd like to express concern about continuing showing the consideration for head-on crashes at a speed of 140 miles an hour. I think this possibly leads to a lot of distraction on the actual subject, and that's about it. What I'm saying is that I believe that considering that crashes of 140 miles per hour—head-on crashes—and showing the results and comparing them for the current design and design with the crash energy management approach included are distracting. I don't believe there is a sound basis for it. What is shown here are the results of very simplistic one-dimensional models. I guess you know; that's about it. Sorry, did you understand my comment?

DR. WEINSTOCK: I think what you said was the results that we showed were the results of very simplified one-dimensional models, and that was one statement. You questioned what the realism of those one-dimensional models are in terms of actual behavior. And then there was another thing that was essentially independent, although related: Is it reasonable to talk about 140 miles an hour? I think what you're saying is maybe as long as I kept my speeds down to 5 miles an hour or 10 miles an hour where the motions are relatively small, maybe I can get away with my one-dimensional models; but once I've got a lot of crush, the one-parameter models are starting to break down. Is that what you're saying? This is one of the reasons that we are having the type of finite-element models that I showed in Slide 27. SRI constructed this model with the Dyna 3-D program, which takes a lot more detail than the one-parameter characterization. It takes account of the distributions and mass, and other factors. The models we have used are a simplification but they become a starting point for an analysis, and something that can readily be refined where we have the tools to start refining the extent of the analysis.

When we've had collisions that have occurred of closing speeds of greater than 100 miles an hour, I cannot say that a collision of 140 miles an hour will never occur in any universe—I don't know how to do that. I can not close my eyes and say if it happens, I divorce myself from responsibility because terrible things are going to happen. I have to at least analyze it; I have to ask the question of what happens, and then I have to let your customer and you decide what's buildable, what is it you're ready to pay for, and I have to ask the FRA and other people's customers, the public, as to whether it's an acceptable condition. But we should be developing the information and the data. I'm not saying that we should necessarily implement on that basis.

MS. SEVERSON: A question back there?

ED LOMBARDI: Ed Lombardi of Amtrak. Herb, if you could just go back to slide 17 where you showed the closing speed of 76 miles an hour, I've got a question on some of the numbers. You're showing after the first car hit the wall at zero g—it's slide 18 on the handout if that'll help you.

DR. WEINSTOCK: That'll help. I have 18.

MR. LOMBARDI: Okay. I've just got a question of interpretation. The very top, that first car, zero G, I'm sure it had a lot more than zero g—another 4g's, I'm sure, are maximums.

DR. WEINSTOCK: Oh, no, what's happened is this one, as it came to a stop—in order to understand this one, we need the viewgraph before, so now all I have to do is find 17. And I'm

afraid I did start to move a little bit too quickly. Our closing speed of 76 miles an hour corresponds to 38 miles per hour into a brick wall, and we go through the structural collapses in stages. So at the end of the first stage being crushed, you've gotten down to a speed of 28 miles an hour, but this first car had-at the initial condition, this thing behaves like a train, everything's connected, and it's a uniform deceleration of $\frac{4}{3}$ of a g, until all of this zone collapses. At the point that this zone has collapsed, we've gotten down by a speed, we've reduced speed by 2 miles an hour, so 36 miles.

DR. WEINSTOCK: Then on the next stage what's that done with this 4g deceleration, it's brought this guy's speed down to 28 miles an hour. And we've depleted this zone, we've depleted a good part of, we've started to crush Zone 3. And at this point as a result of the 8g deceleration, this car is has been brought to a stop. So it's at zero miles an hour. Beyond that it has no incentive to go anyplace, because the forces that are pushing on it are less than the forces that are capable of being developed on this side. So the effect is a zero g acceleration to the next stage.

ED LOMBARDI: Thank you, sir. That answered it exactly. But one other follow-up question. In actual practice, each car would have a crush zone or crush zones on each side of it. It's a very simple diagram. You know, you'd put up a wall.

DR. WEINSTOCK: You'd do up the front and backs together.

ED LOMBARDI: But would that change any of the numbers you just put up?

DR. WEINSTOCK: The numbers would essentially be similar. I'd have to take a second look at the behavior at the interface.

ED LOMBARDI: Well, but between two intermediate cars, you would have two of the four W's up against each other instead of one up against.

DR. WEINSTOCK: Right. What effectively you could imagine is half of this guy being on this car.

ED LOMBARDI: Okay. So you've accounted for it.

DR. WEINSTOCK: It would be the same kind of distribution.

ED LOMBARDI: And the g levels would be the same as you've showed us.

DR. WEINSTOCK: Right.

ED LOMBARDI: Thank you.

DR. WEINSTOCK: For again these dimensions, which are pulled out of the air, and although the motivation was for a single-car collision to keep the deceleration level at about 4g's.

ED LOMBARDI: Thank you.

MS. SEVERSON: One more question in the back before we break. That was you with your hand up.

CLARENCE SCOTT: Clarence Scott, Electromotive. I've some concern about the modeling simplifications. And those of us that model understand that you have to simplify. But it seems like we're coming up with a philosophy of design based on a very pure head-on crash, where the end structures can capture each other. And yet even in the accident examples you gave, at least two of the three that I'm familiar with, I don't believe an end structure would have captured either one of them; and even with crush zones, they would have still passed by each other, and when they did pass by each other, the decelerations, the way they slowed down were much more severe than this, even with the crush zones. So it would seem that we're in danger of imposing a design philosophy based on something that very rarely happens. Even rarer than the so-called head-on crash is the pure head-on crash. Should we be expanding this or looking at whether this would have really prevented the crash and actually slowed the deceleration rates?

DR. WEINSTOCK: I think we should be asking the question and doing the level of analysis that defines what kinds of options are available. Then in terms of translating it into practice, there are definitely design phases, experimental phases, that somebody would have to go through in order to go into complete reality. But I think we should be asking questions.

CLARENCE SCOTT: Why choose the pure head-on crash for that analysis?

DR. WEINSTOCK: The pure head-on crash is chosen for the analysis because that is your most severe condition and it is the likely condition of two trains coming into a head-on collision.

CLARENCE SCOTT: Two trains being exactly on a tangent track, heading at each other, no switches, no curves, no nothing almost hardly ever happens.

DR. WEINSTOCK: On a tangent, close to a turn out, somebody who has completed a maneuver; in that figure, the difference between what did happen, which was the side collision, and what could have happened.

MS. SEVERSON: Herb, while you're looking for a slide, I think Dave had something he wanted to say.

MR. TYRELL: Dave Tyrell of the Volpe Center. A couple of comments. There was a collision I believe in either '81 or '82 outside of New York City—two trains led by AEM-7'S held by AmFleet coaches. The collision speed was a little over 60 miles per hour is my recollection. The two trains did stay in line, it was a dead head-on. At least in a general sense or a qualitative sense the model agrees quite well with what happened in that collision. I'd also like to defend the single-degree-of-freedom model a little bit. It is extremely similar to the model that SNCF used to evaluate what happened at Varonne. That model corresponds very well with that accident. Some of the implications of what Frank Duschinsky was saying is that at higher speeds, you're going to have override lateral coupling. If you are wise enough, if you are smart enough, you have some prior knowledge of what the final collision condition is like, you could indeed apply a single-degree-of-freedom model. If you do it right, you should get a very good correlation. It's a matter of what you're looking for out of the model, whether you're getting appropriate information or not. If you're looking for some detail and some impressions about the structural

deformations, you're not going to get it from a single-degree-of-freedom model. If you're looking for gross crush, it is appropriate.

DR. WEINSTOCK: Coming back to this picture, the difference between this situation and the head-on situation is just car length. Just one car length. Had this car moved just a little bit further in terms of time, and occupied that situation, you would have had a head-on collision. So a head-on collision is worth looking at. Whether or to what degree it becomes the controlling situation does get into your risk trade-offs and your economic decisions and your design decisions; but developing the information and developing the parts to make the trade-offs from, that I will defend. Whether you should buy a train or look for a train to survive the 1,000-mile-an-hour head-on collision, I couldn't tell you. But if it took very little to provide the protection, I'd go for it.

MS. SEVERSON: At this point I'd like to take a break. If there are further questions, they can be raised or addressed at the panel discussion at the end of the day. If we try to reconvene about 10:10? Thanks, Herb.

PRESENTATION

***DESIGN CONSIDERATIONS FOR RAIL VEHICLE
CRASHWORTHINESS***



**SYMPOSIUM ON RAIL VEHICLE CRASHWORTHINESS
Cambridge, Massachusetts, U.S.A
June 24 - 26, 1996**

Design Consideration for Rail Vehicle Crashworthiness

**Herbert Weinstock
David Tyrell**

**Volpe National Transportation Systems Center
Research & Special Programs Administration
U. S. Department of Transportation
Cambridge, MA 02142**

DESIGN CONSIDERATION FOR RAIL VEHICLE CRASHWORTHINESS



**TRAIN COLLISIONS ARE RARE AND SHOULD NOT BE
PERMITTED TO OCCUR, BUT...**

February 16, 1996 Silver Springs, Maryland,
Closing Speed 70 mph

MARC Cab Car into AMTRAK
Locomotive

January 09, 1996 Secaucus, New Jersey,
Closing Speed 71 mph

New Jersey Transit, Cab Car
in to Locomotive

January 4, 1987 Chase, Maryland, Closing Speed 105 mph

Amtrak Locomotive into Conrail
Locomotive

**WE MUST DESIGN VEHICLES TO ANTICIPATE COLLISION AND
LIMIT CONSEQUENCES...**

Slide 2

DESIGN CONSIDERATION FOR RAIL VEHICLE CRASHWORTHINESS



DEFINITIONS:

IMPACT BETWEEN TRAIN AND OBSTACLE

- ✓ Over ride produced by wedging action resulting from geometry of impacting structures
- ✓ Over ride produced by vehicle pitching response
- ✓ Structural failure, collapse, and crushing of vehicle structure

SECONDARY COLLISION:

IMPACT BETWEEN PASSENGER OR OPERATOR AND VEHICLE INTERIOR

- ✓ Occupant trapped in collapsed interior
- ✓ Occupant impacts interior surface

Slide 3

DESIGN CONSIDERATION FOR RAIL VEHICLE CRASHWORTHINESS



VERRIDE PRODUCED BY WEDGE ACTION

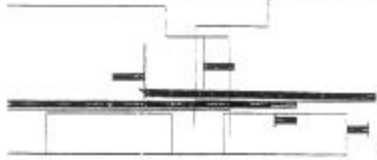

SIMULATION MODEL

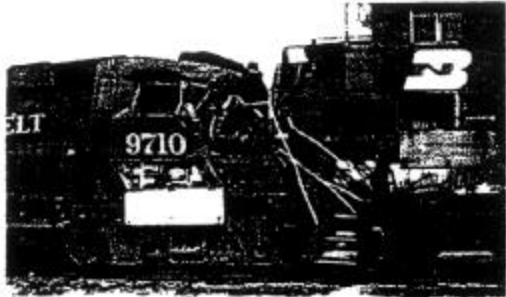

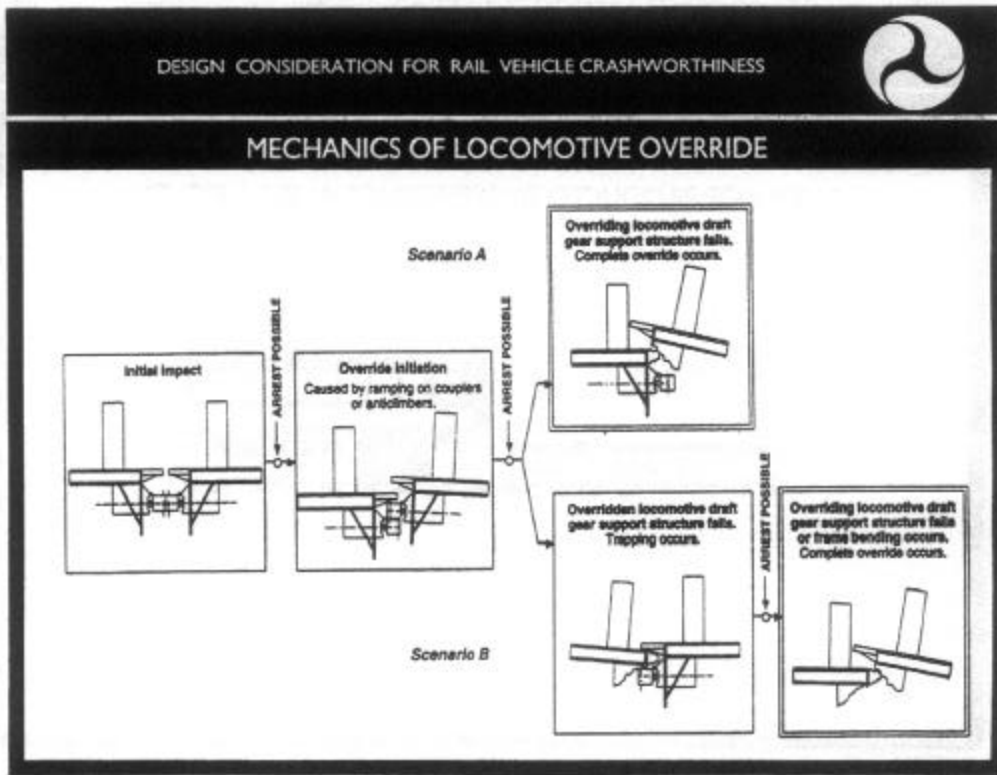

Slide 4

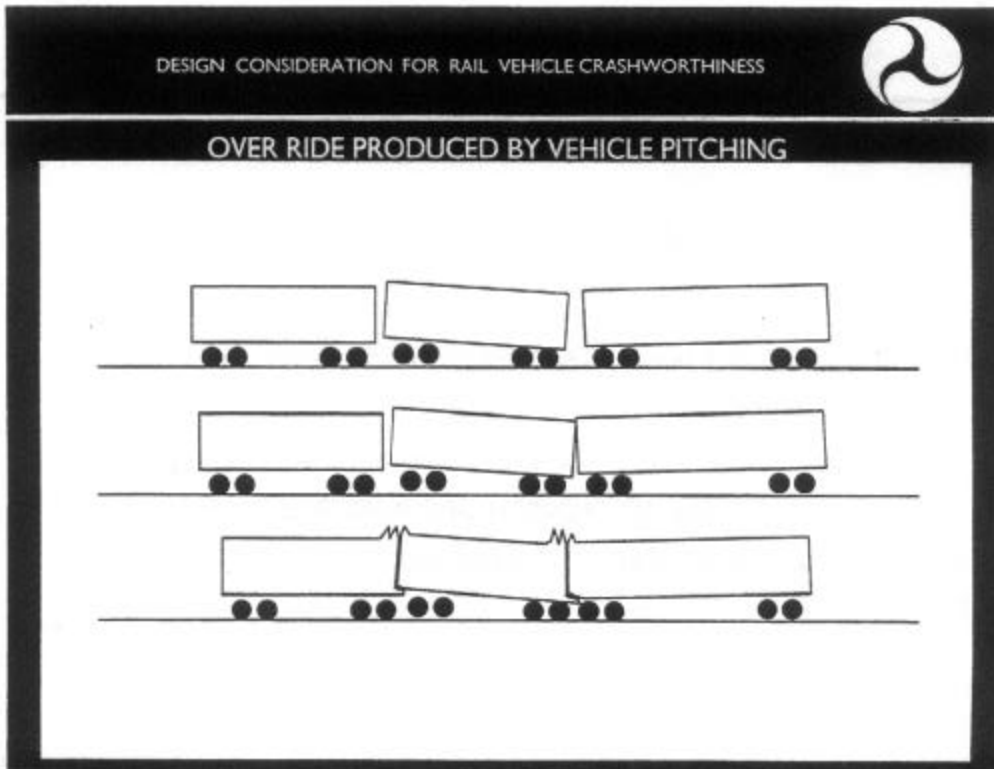

Slide 5

Slide 6



Slide 7

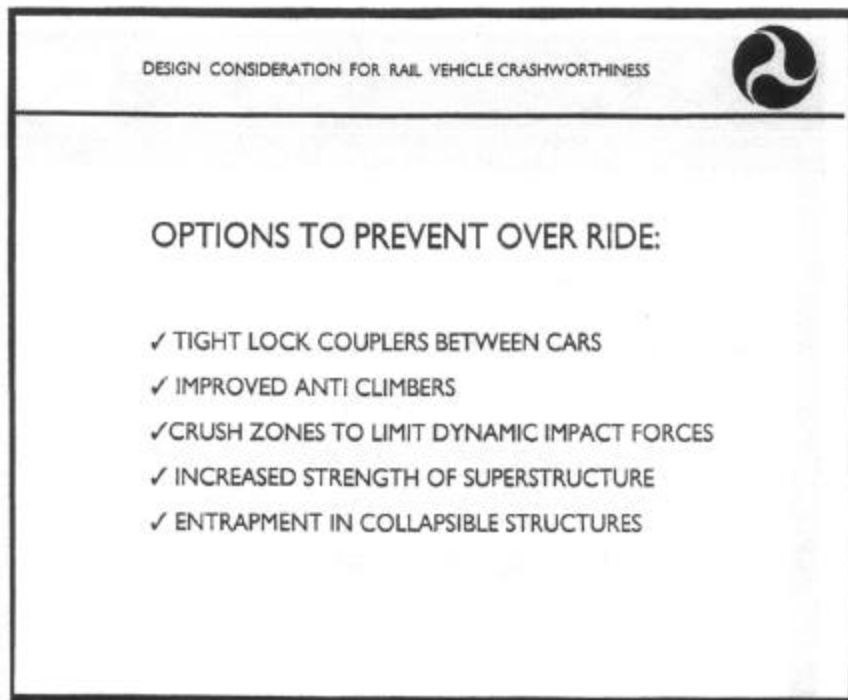

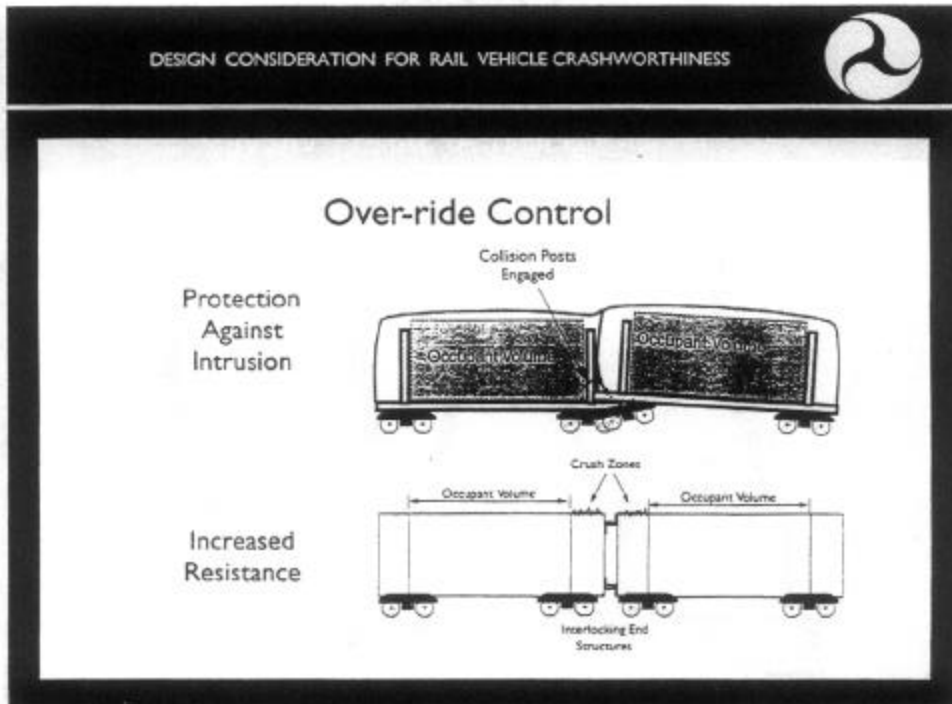

Slide 8

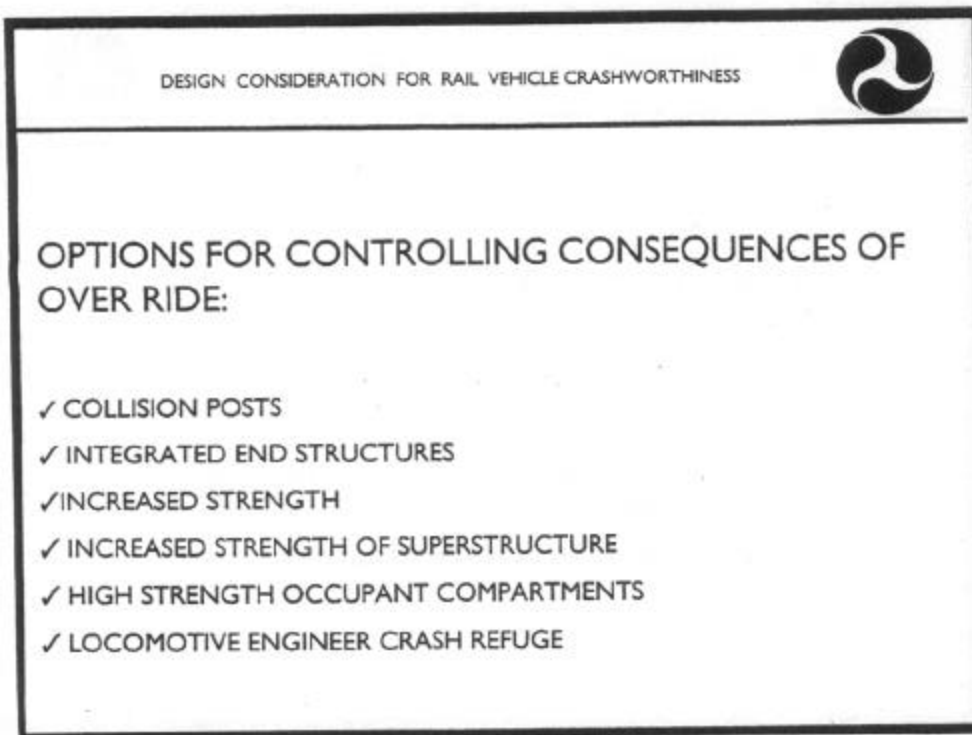

Slide 9

Slide 10

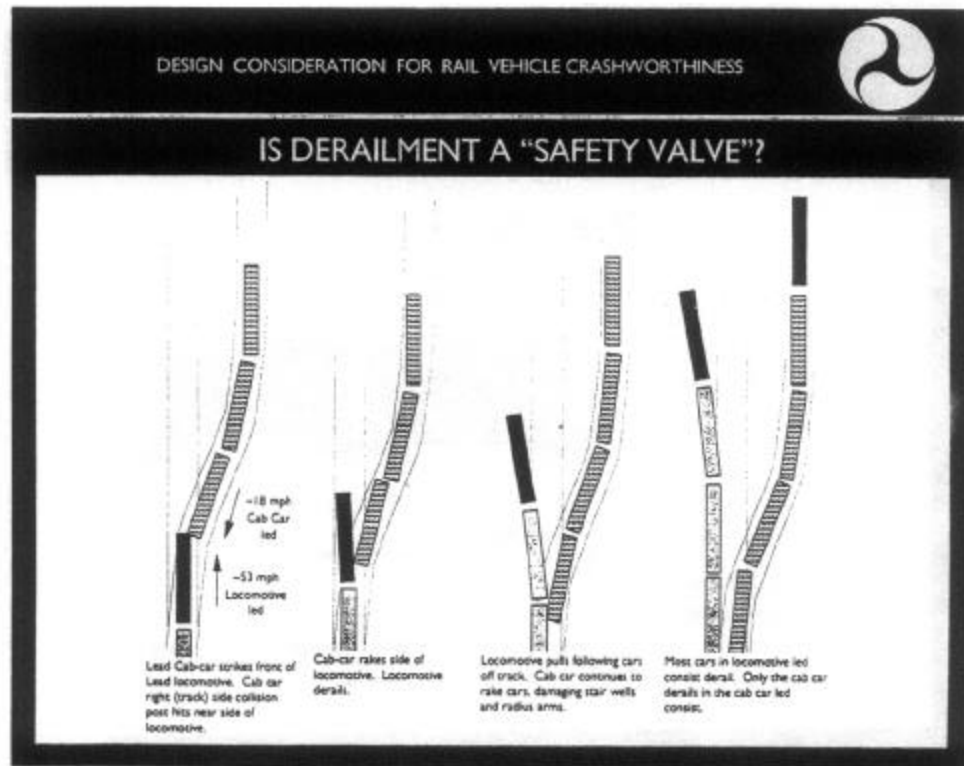

Slide 11

DESIGN CONSIDERATION FOR RAIL VEHICLE CRASHWORTHINESS

RAIL VEHICLE CRUSH BEHAVIOR

- UNIFORM CRUSH STRENGTH
- CRASH ENERGY MANAGEMENT CONCEPTS
 - ✓ "GAP" BETWEEN CARS TO EQUALIZE CRUSH BETWEEN CARS
 - ✓ STEPPED CRUSH CHARACTERISTIC

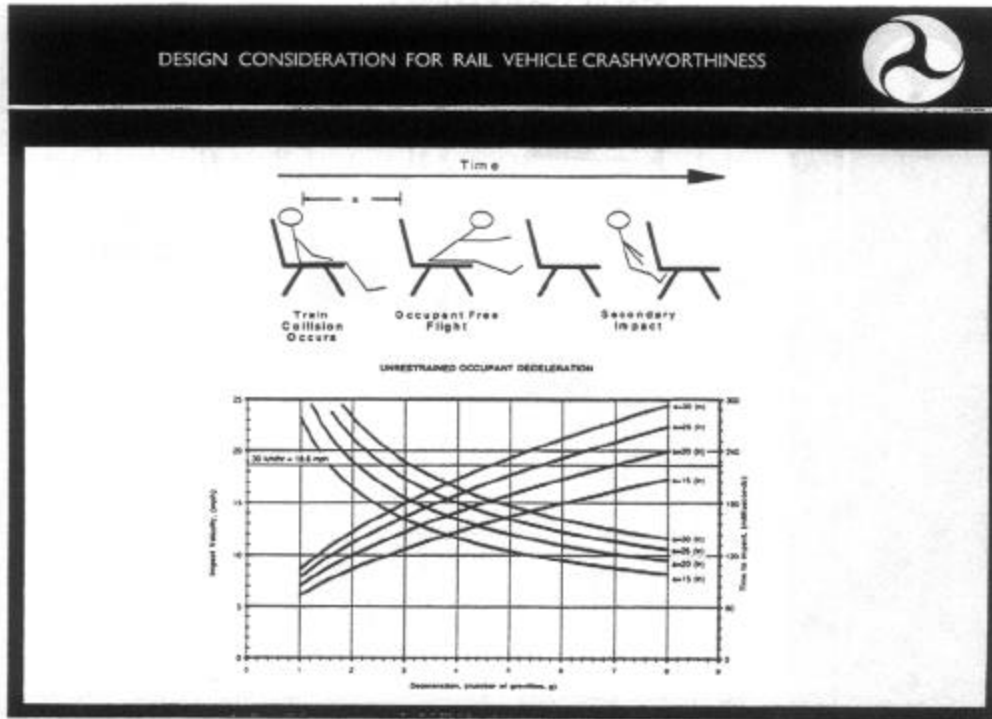

Slide 12

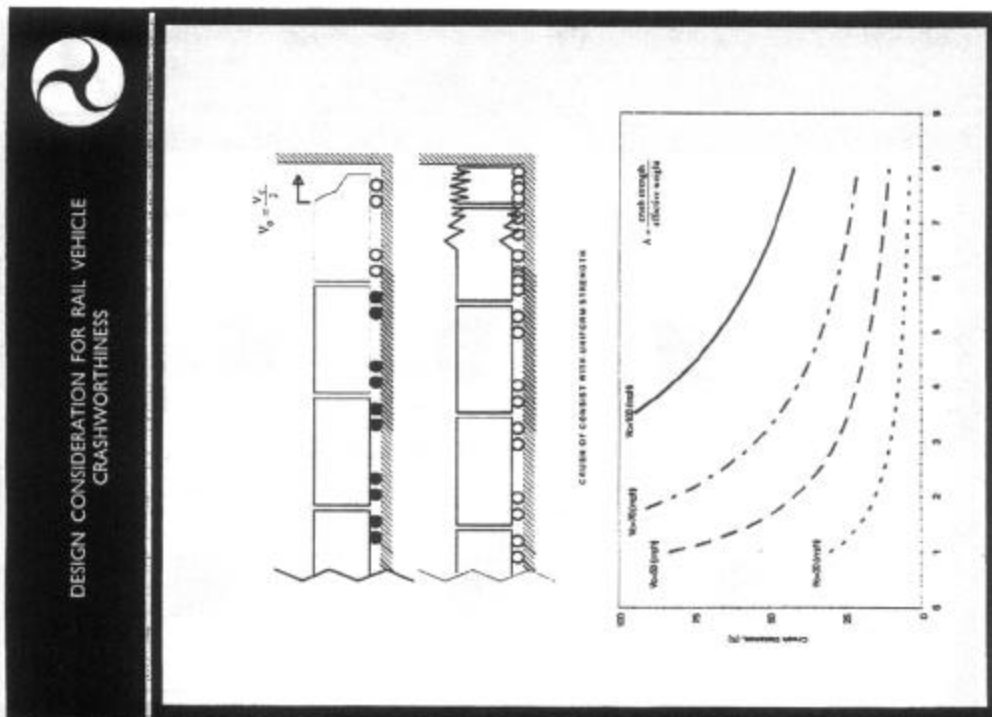

Slide 13

Slide 14

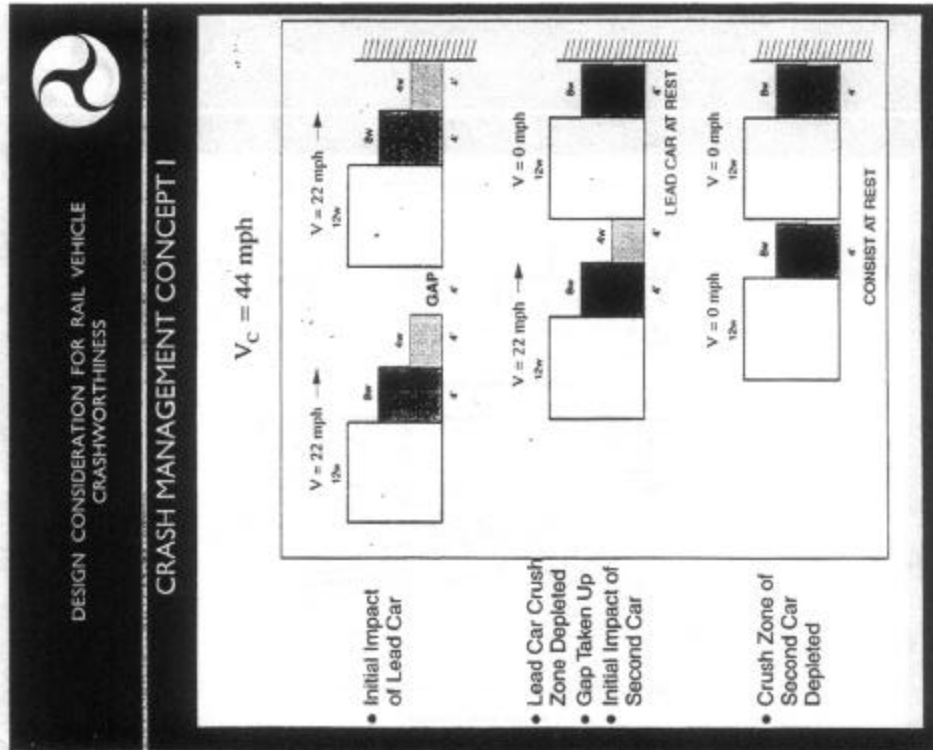

Slide 15

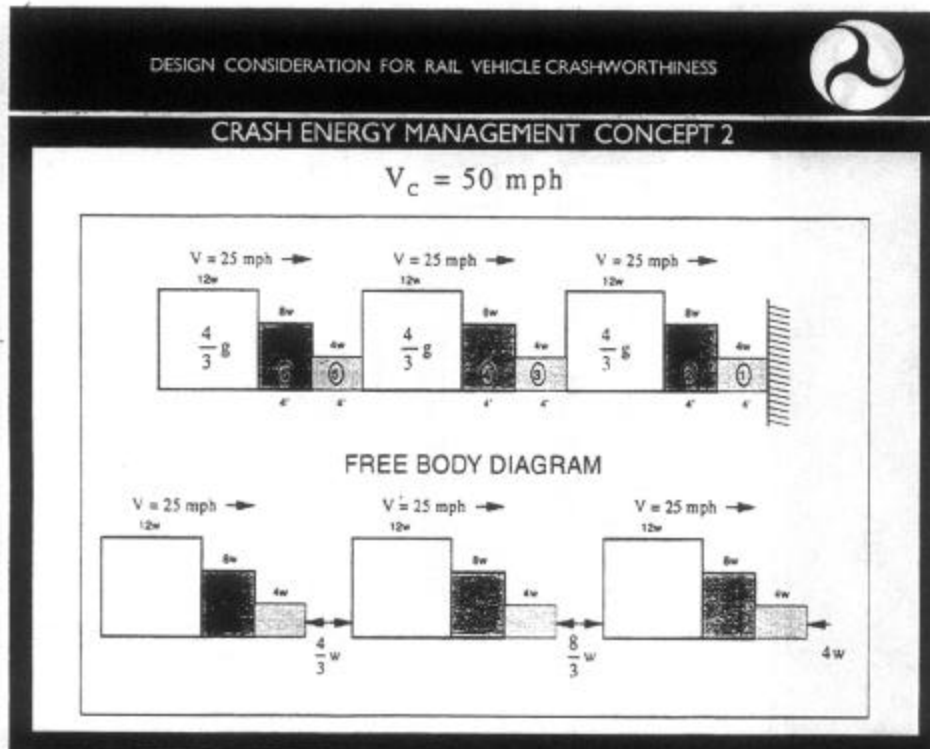

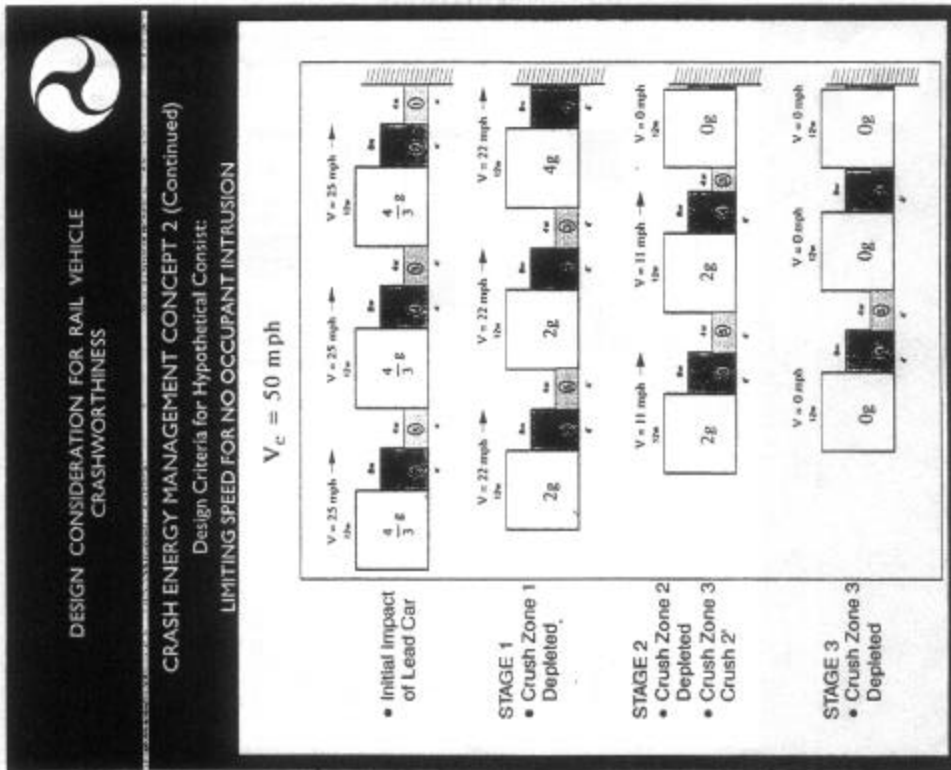

Slide 16

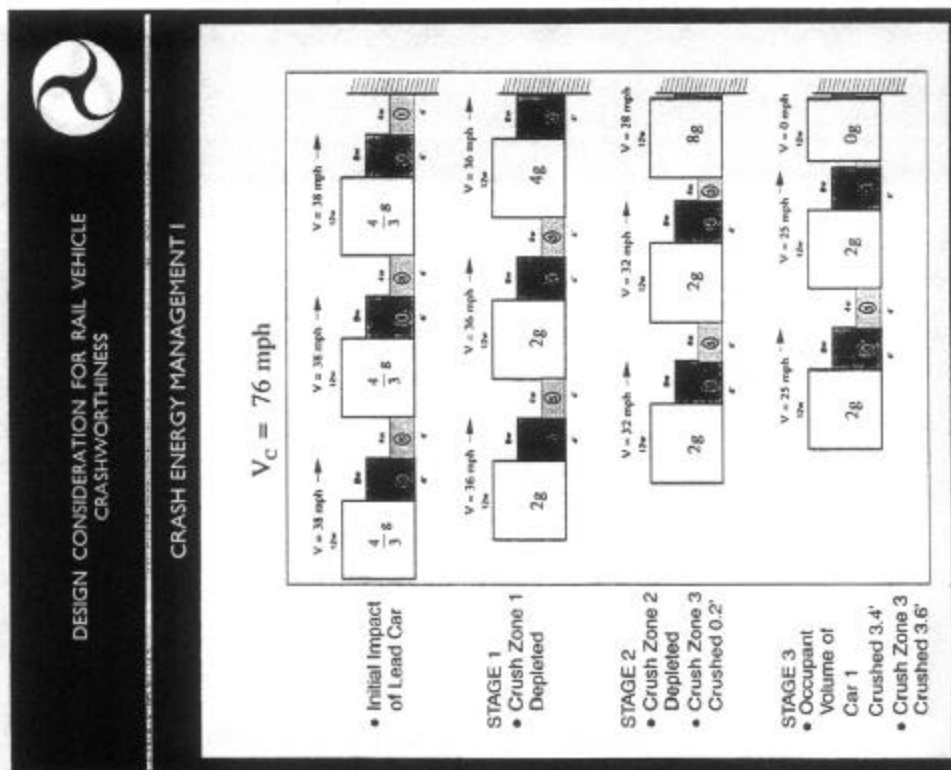

Slide 17

Slide 18

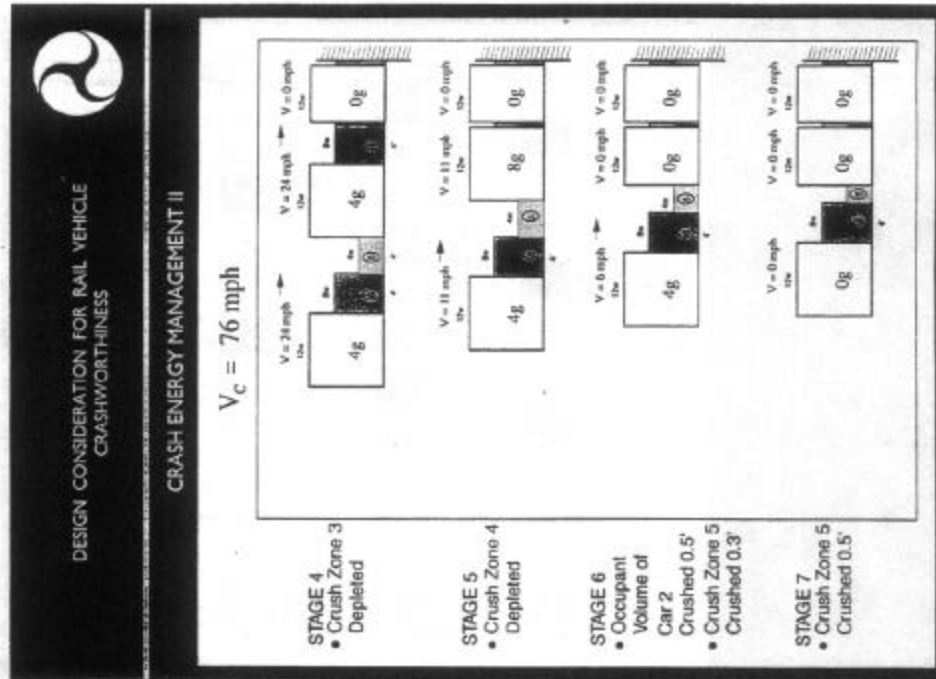

Slide 19

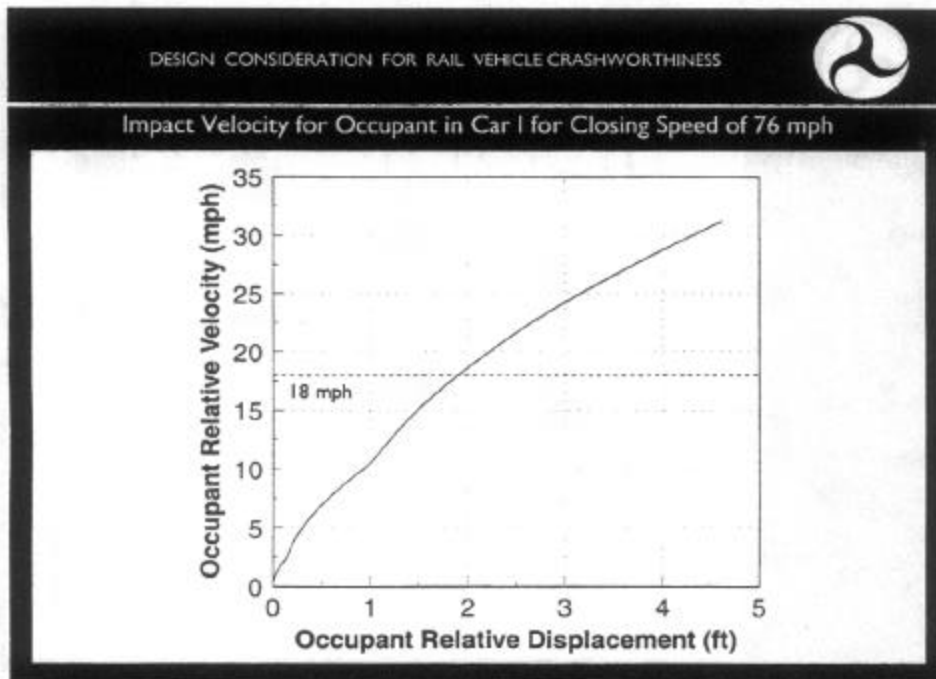

DESIGN CONSIDERATION FOR RAIL VEHICLE CRASHWORTHINESS



RECENT U.S. CRASHWORTHINESS RESEARCH:

- ✓ Assessment of the State of the Art
- ✓ Analysis of High Speed Crashworthiness Options
- ✓ Locomotive Crashworthiness Research
- ✓ Dynamic Sled Testing of Passenger Seats
- ✓ Case Studies in Collision Safety
- ✓ Modifications for Improved Cab Car Crashworthiness
- ✓ Crash Energy Management Preliminary Design Study
- ✓ Override/Lateral Buckling Study

1989



1996

Slide 20

DESIGN CONSIDERATION FOR RAIL VEHICLE CRASHWORTHINESS



Constrained Crash Energy Management Design

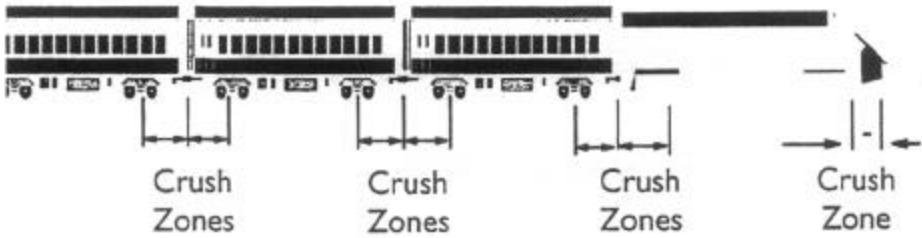

The diagram shows a side view of a train with three passenger cars and a locomotive. Below each car and the locomotive, there are horizontal double-headed arrows indicating 'Crush Zones'. The first three cars are labeled 'Crush Zones' and the locomotive is labeled 'Crush Zone'.

Slide 21

Slide 22

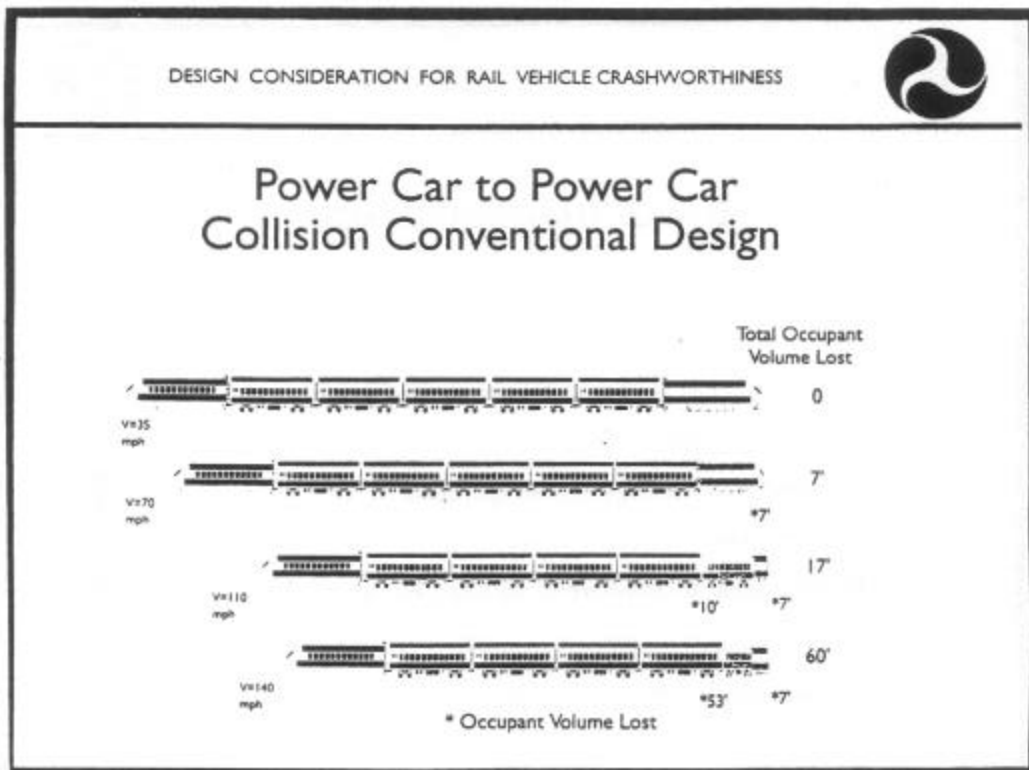

Slide 23

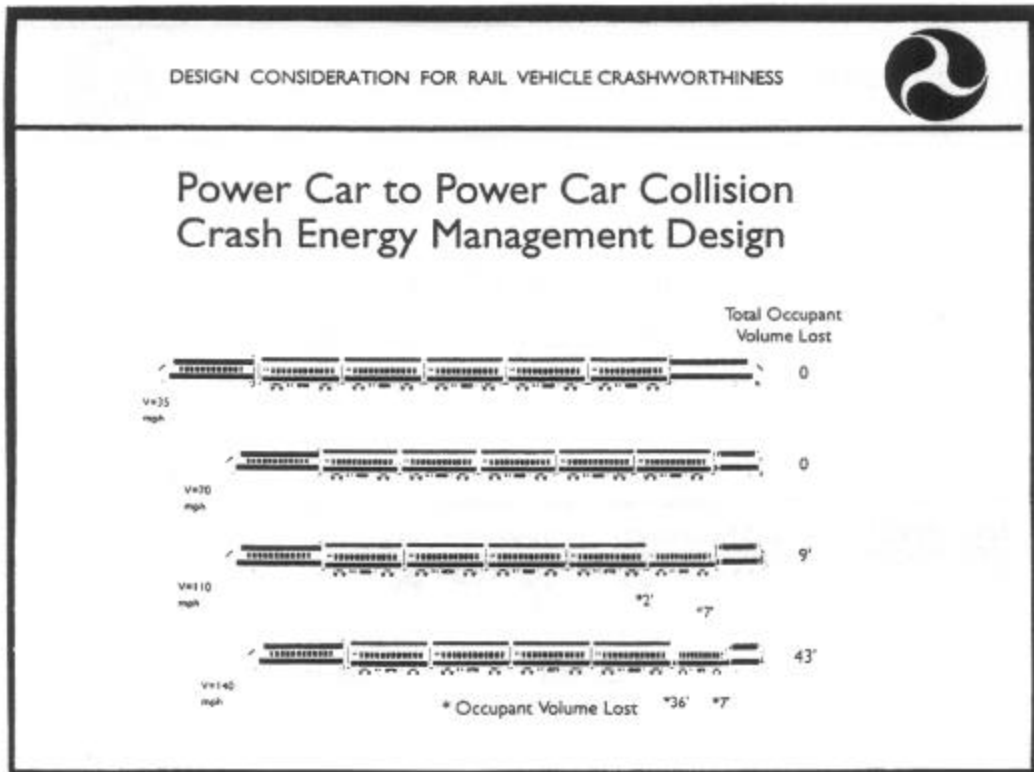

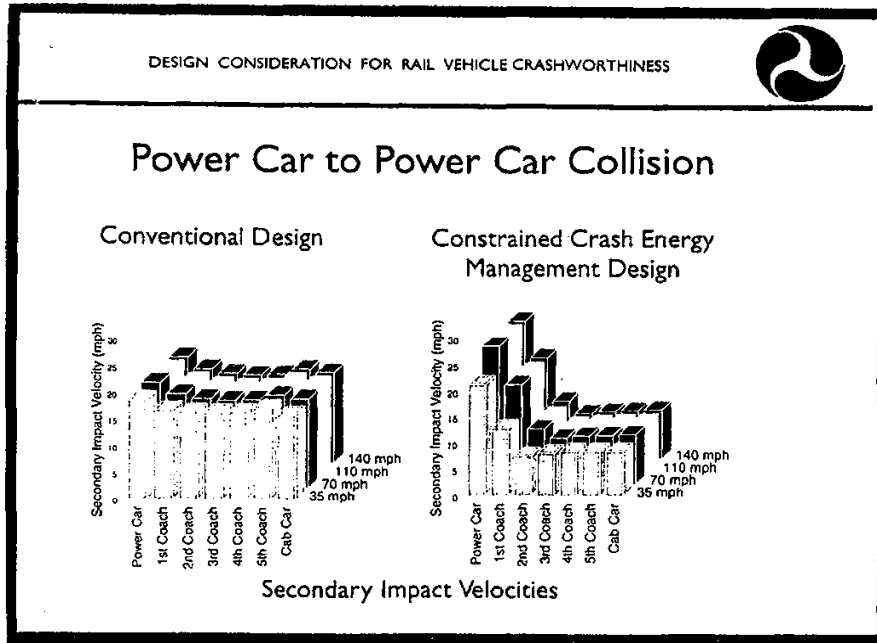

Slide 24



Slide 25

Slide 26

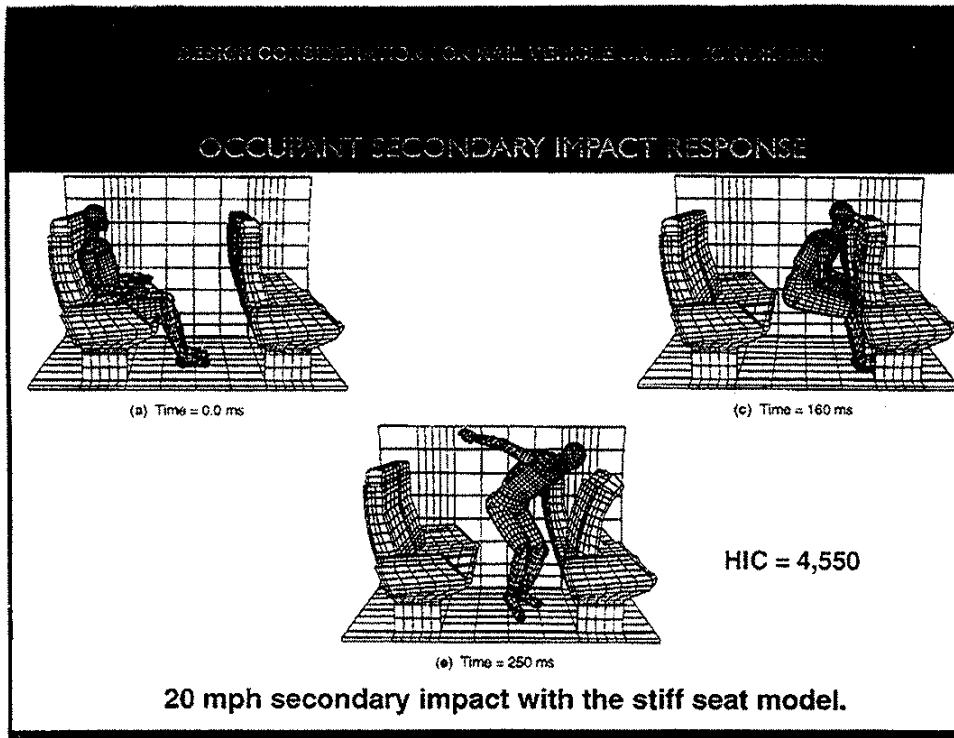

Slide 27

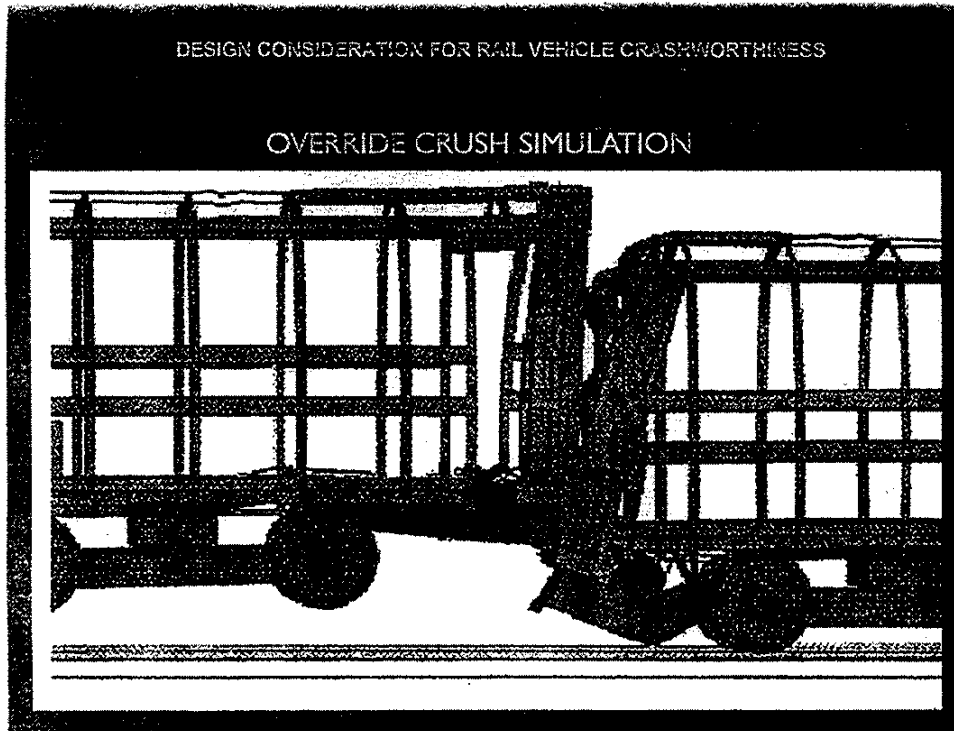

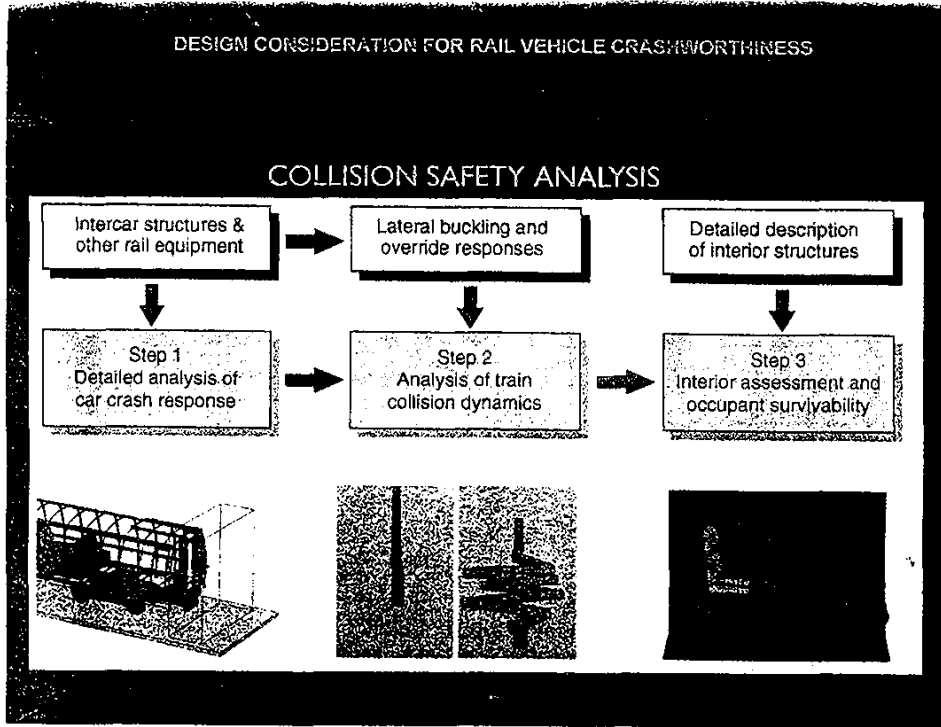

Slide 28

HIGH-SPEED RAIL COLLISION SAFETY

DR. WEINSTOCK: We'll next discuss work we've done and some of the analyses that we've been doing to assess the severity of the collision event. SRI International was part of the Foster Miller team in doing the case studies in collision analysis. And their role was going through some detailed models of car designs, detailed models of secondary impact conditions, with a bit of emphasis on the use of DYNA3D program, that was developed by Lawrence Livermore. The presenter will be Steve Kirkpatrick, who's been with SRI International as a research engineer for about the past dozen years, and he's been doing computational and experimental investigations on dynamic response and failure of materials and structures to impact and glass gloating, which seems appropriate to the high-energy collision situations that we're dealing with. Some of the typical programs that he's been involved with have included dynamic buckling of thin shell structures, impulsive loading, ductile fracture conditions, dynamically loaded developments, structures used by the Navy. And he's going to talk about some of the crashworthiness analyses that he's done in work related to rail car crashworthiness. Steve.

MR. KIRKPATRICK: I'm going to talk about the work we've been doing on the high-speed rail collision safety program. This is work that I've been doing with my colleague, Jeff Simons, who is also here. First, a brief overview of the program. A lot of this was discussed yesterday by Mark Snyder and Duncan Allen. Overall, we're looking at the collision safety of high-speed rail systems. This is a program that was originated by the FRA and administered through the Volpe Center. At SRI International, we're looking at crashworthiness and accident survivability, along with our prime contractor, Foster Miller. The other part of the program, discussed yesterday, is the collision avoidance and risk analysis.

It's helpful to remember the real problem we want to analyze, and that's what this slide shows. This is an illustration of the Silver Springs accident in February. What you need to remember about this is that the collision response has a lot of complicated aspects. If you look at individual cars, you have large crush deformations. If you look at the overall consist, you see that lateral buckling has occurred. There are large rotations and large displacements in the response which are difficult to analyze. In addition, you have to follow through from the train and consist response to the occupant response inside where a secondary collision of the occupant occurs. Thus, you have various phases of the response, which makes the overall analysis quite complicated.

If you look at the previous work that had been done, considering North American rail equipment, much of the analysis is relatively old. It applied limit-load analyses, or simplified frame analyses. This slide shows an example of an analysis that was done by the Boeing Vertol Company for the ICG Highliner, in the mid-'70s. It's for a case of an overriding car. The plot shows a calculated crush load of 0.6 million pounds in override and then once the trucks engaged, then you obtain something like 1.2 million pounds in bulk compression. This is the kind of information we had as a starting point. What we wanted to do was to apply more state-of-the-art methods for analysis of the North American equipment.

The other analyses that have been done for train car crashworthiness are the determination of static buff strengths, because that was one of the design conditions. In terms of the detailed finite-element analyses, there are simulations going on in the European community, SNCF and

GEC Alstom for the TGV and British Rail. I'm sure we'll hear more about those research programs later.

The modeling technique that we wanted to bring to program this was to apply the DYNA3D finite element code. This is a code that's been used extensively within the crashworthiness community for automobiles. It's a dynamic, nonlinear, three-dimensional finite element code with an explicit integration. This type of explicit finite element simulation is very well suited to analyzing the nonlinear dynamic crash response with large displacements. DYNA3D also has features built in so that it does a very good job of modeling contacts and impacts required for crash simulations.

In addition, to understand the overall response, we thought it's important to look at the entire car as a single structure. In that way, the various structural members all interact with each other, and you don't have to make assumptions of how individual components, such as the collision post interact. By analyzing the entire structure, I think you can do a better job of modeling the complete crash response.

This slide illustrates the overall approach that we set up. This approach is one of the things that we wanted to emphasize. You can't do the entire range of crash response and occupant safety analysis with any one single calculation. It's too large a problem to do that. You need to break it down into the various portions of the problem that you need to understand and can analyze. We started with an analysis of the detailed crash response of an individual generic coach car. This required building up a detailed model from which we're able to learn about the characteristic crush behavior and crash response of an individual car. The next step is analysis of the overall consist and the consist collision dynamics using a more simplified model. By doing that, you're able to get the acceleration histories of each of the cars in the consist. These car accelerations give you initial conditions for doing the third step, which is the occupant response and the interior safety assessment.

At this point, I'd like to show a video that illustrates those various types of simulations. [Plays video.] This video just quickly steps through those three phases of response. The first thing you need to do is understand the detailed responses of an individual car. What you're seeing here is the model we built of a generic coach car using North American design practices. The simulation that I'm showing here is an impact of that generic car at 60 miles an hour into a 50-ton rigid but moveable mass. You see the mass is represented by the outline shown here. The car model being shown has approximately 50,000 elements. The outer skin is removed in this view to show the various sills, stiffeners, and the overall structural design. The collision being shown here is for a duration of approximately 50 milliseconds. At 60 miles an hour, this produces a crush of 30 to 40 inches. You can see that the whole front end of the car is severely crushed and the side doors are pushed closed by the crush deformations. You can also see dynamic buckling forming in the outer skin, fairly noticeable back in this region. This example illustrates the complex response that you need to be able to analyze for this severe collision.

To illustrate the individual car crash response further, this animation has a transparent outer skin and floor panels, so you can see the type of buckling that occurs within the structural frame. The draft sill forms plastic hinges leading to a dynamic buckling a collapse mechanism. This analysis gave us a lot of insight into the collision responses for this type of structure. In addition, it allowed us to define what the characteristic crush strengths were for the generic coach car, and that information feeds into the simplified models for the collision dynamic simulations. An illustration of that type of collision dynamics response is shown next.

Here, we have three cars impacting a 50-ton mass at 60 miles an hour. What's illustrated by the colors in these car end crush regions are contours of crushing or damage, and you get a fair amount of crushing at the front of the first car as well as some crushing in the interaction between the first and second car. If we look at a close-up of the interaction between the first and second car, it shows some details of the mechanisms that can lead to an override-type response. The deformations of the simplified couplers, mixed in with the overall kinematics of the response, leads to a lifting response of the second car. Had this been a more severe collision, the car end lifting could have led to an overriding behavior.

This simulation illustrates is that even though this is a simplified model, by doing it within the framework of a finite element code, like DYNA3D, you analyze the overall three-dimensional dynamics including the mechanisms of override and buckling.

The final stage of the train crash problem is the interior response, and here's a representative calculation: you have a seated occupant, and we apply an acceleration history to the seats that leads to a 15-mile-an-hour secondary impact with the forward seat row. This calculated response is very similar to the sled tests that we'll see in a presentation tomorrow.

For this secondary impact analysis, the overall motion of the occupant and the seatback is such that the head has a very light impact with a fairly compliant seat. In this case, we calculate a head injury criterion (HIC) on the order of 100, which corresponds to a low injury probability and you'd expect that this occupant would survive that collision. (Can we have the slides again?)

To summarize again, our overall approach for the collision safety analyses is to break the problem up into a three-stage response, where you first do a detailed analysis of the car crash response. This helps us develop an understanding of the detailed collapse mechanisms for the car. These analyses also calculate crush curves which feed into the next step: the analysis of the overall collision dynamics. These are simplified models that allow us to analyze the crushing response and have the ability to build in lateral buckling and override. These simplified models calculate the interior crash environment, which feeds into the interior assessment and occupant survivability analyses. Using the crash environment with an interior and occupant model, we calculate the secondary collision response and obtain an injury assessment.

Developing a model for the detailed car crash analyses requires the train car structural definitions. You can obtain this with either drawings or by looking at the actual hardware. Foster-Miller helped us quite a bit in defining a generic train car structure. From the structural definition, we created a detailed model that had on the order of 50,000 elements. The resulting simulations of the individual train car crash response would take on the order of 40 hours on an engineering work station.

The different collision scenarios we looked at, 30- and 60-mile-an-hour impacts into 50-ton rectangular masses; as well as looking at more complex mass geometries. The more complete geometries were used to study the effect of various impact conditions, such as hitting the underframe initially and then engaging the superstructure later, on the overall crush strength. These detailed crash simulations then calculate the corresponding response mechanisms in about 40 CPU hours for 100 millisecond duration. That is representative of 105 inches of travel at 60 miles an hour, so that duration allows you to calculate the significant crush response for an individual train car.

This slide shows the car model as pictured in the video. You can see that we have modeled the side doors, collision posts, and the other significant car structures. If you look at the model with

the floor and walls removed, you can see the roof sills, side sills, all the stiffeners within the wall structure, the draft sill and body bolsters shown there. This slide of the draft sill and body bolster show the mesh resolution that's included in the model. This slide shows the calculated 60 mph crash response which was shown in the video. The response is dominated by dynamic buckling. In this case, one of the responses that is calculated, and observed in some collisions, is that side door is closed up by the crush response. If you look at that side door response, you might think that that's potentially a weak point in the structure that is lowering the amount of crash energy that could be absorbed in the crush response. We'll look at that effect in a couple more slides.

This is a close-up of the draft sill response that we calculate for that 60 miles per hour collision. The draft sill forms plastic hinges from dynamic buckling at these points. That response dramatically reduces the loads being transmitted to the rest of the structure and limits the overall crush loads for this type of structure. That's very important in understanding the response of this train car structure.

This slide shows the crush curve that we predict. This curve is for the 60 miles per hour collision and shows the crush force as a function of crush distance. What you see is that in the initial impact you have some fairly high forces, on the order of two million pounds. A lot of that initial load is the inertial force of the car end structures as they impact the rigid mass. You have a lot of weight in the car end that needs to be stopped. That results in a high initial force against the mass. After you get on the order of 10 to 20 inches of crush, the calculated response settles down to a near-steady state crush force that's on the order of half a million pounds.

Having defined what our characteristic crush behavior is, there are other things you can do with this type of detailed model. You can look at what types of modifications can be made to the car structure to strengthen it or improve crashworthiness. As I mentioned before, the side door looked like it might be a weak point, so you can model the car with and without that side door, or with a side door modification, to see what effect that has on the crush energy and crush strength. You could increase the thickness of the structural members, make thicker and stronger draft sills, and calculate the effect on the crash behavior. You could look at other collision scenarios, such as override, and calculate the car forces at initiation of override, or similarly the car forces and moments with lateral buckling. That's something that we think really needs to be done in the future, to apply this type of model to investigate the lateral buckling in the overall collision dynamics, as well as looking at offset impacts, which addresses a comment made in the last talk.

Here's the comparison that I mentioned of looking at the crush strength of a car with and without the side doors. It's hard to distinguish the colors, but the yellow curve is the car without the side doors and the white curve is the car with side doors. These are again plots of the crush force versus crush distance. These additional curves are obtained by integration to calculate overall crash energy absorbed as a function of crush. What we see is that the difference between not having doors and having doors is less than five percent. Therefore, the side door collapse looked like it might be important, but the model shows that it does not have that large of an effect in the overall collision response and energy absorption.

Here's another example simulation of the detailed train car model impacting a partial barrier. In this collision, you crush the corner of the coach car, and you get a lot of deformation of the corner structures. However, the draft sill, which is a major structural member and a significant load path, really isn't interacting and involved in this collision. As a result, with this type of collision, you get much larger intrusion into the occupant volume of the car for the same energy collision.

Here's the final example with the detailed model where we calculate the deformations and responses of the structural members for the case of developing override. In this simulation, we had initial vertical offset between the impacting cars. You can see the deformations developing, the collapse of the draft sill, and the eventual rotation in defeat of the collision posts for this collision. So this type of simulation allows us to investigate the override response and determine the best way to strengthen the structure to prevent this override-type deformation.

To summarize what we've seen out of the detailed car analyses, they're very helpful for understanding the overall response mechanisms, and very useful in learning about the interaction of the structural members. The detailed car analyses also were used to determine the characteristic crush curve, that was found to have a steady state crush strength of on the order of half a million pounds. One observation is that it would be very helpful to add to this model a similar detailed representation of the coupler, so you can better calculate car-to-car interactions to learn more about what happens in the development of override and lateral buckling.

The next step in the train crashworthiness study is the collision dynamic analysis. To perform this, we again developed DYNA3D model. This model is simpler and uses the effective car crush behavior. This produces a lower fidelity model but with much shorter run times that allow simulations of complete consists for a variety of collision scenarios. The shorter run times are important for performing that. Again, the model is capable of analyzing override and lateral buckling. However, to accurately model these responses, you need to define the appropriate moment-angle and force-deflection relationships at this point aren't known. The appropriate relationships could be obtained by detailed analyses of these responses. The collision dynamics analysis allows us to define a range of car interior collision environments which feed into the occupant response.

What this slide shows is the simplified car model for the same crash conditions that we analyzed with the detailed car of 60 miles an hour into a 50-ton mass. In this case, rather than 50,000 elements, we brought it down to on the order of a couple thousand elements. The calculated car end crush behavior similar to what we saw with the detailed model, and you can compare the forces and deflections as a validation of your simplified model.

This is the type of interior crash environment obtain from the collision dynamics models. This example is a 65-mile-an-hour impact of a seven-car consist into an 80-ton mass. What you see in this slide are the acceleration time histories of each car along the consist. This defines the environment that occupants in the various cars will experience for the secondary impact response. In this example, the train remains inline.

Here's an example of collision dynamics calculation we performed to investigate lateral buckling. It's a 13-car consist with two locomotives in the front that have derailed. This calculation uses an even simpler level model where each one of the cars is just an individual rigid element attached with couplers and elastic hinges to form the consist. What we calculate is that you develop this large-scale lateral buckling response from the derailment deceleration with the loads being applied by the trailing cars. This example shows the capability model to analyze complex buckling responses. However, to do this accurately, you need to go back and do the detailed simulation of the rotation moment relationships at the couplers.

So, to summarize, the simplified collision dynamics models helped us to define the interior crash environments and the crush regions for the inline crush behavior. An important observation is that the calculated crash environments (acceleration time histories) in the cars are well within the

human tolerance limits for a fully restrained occupant. Thus we have the potential to protect the occupants in those environments. Another feature of this analysis approach is that the collision dynamics models are capable of predicting lateral buckling and override. However, more information is needed about the inner car forces and interactions to be able to validate the prediction of those train collision response mechanisms.

The final component of the train crash safety assessment is the analysis of interior and occupant responses. To perform this, a DYNA3D occupant model was developed, based on previous work on modeling anthropomorphic test devices (crash dummies). This modeling approach is helpful in that you're able to draw on a lot of experience and developmental work that was done on crush dummies for the automobile environment. The strength of going with this type of a detailed occupant model with DYNA3D for the interior assessment is that you can do an excellent job in modeling the seats and the interior structures and calculating the occupant secondary impacts. This is because again you're using a code that is designed for this type of response that allows you to simulate contacts, impacts, and the dynamic response. I think this leads to a potential for much higher fidelity occupant response simulations than some of the rigid body type of models such as MADYMO or ATB. These rigid body models represent the interior structures using force deflection behaviors that are specified by the user. The requirement in using the rigid body modeling approach is that you do need to have an accurate representation of the interior structure nonlinear stiffnesses to properly model the secondary impact response and injury potential.

This slide shows the setup that we're using for the interior assessment. We're looking at a single occupant and two rows of seats. In this case, we didn't have a structural definition of the seat down to level of structural materials and thicknesses, so we had to make some assumptions. The approximations of the seat structure were made based on static force deflection measurements of seats. To determine the effect of the seat approximations, we also studied the effect of variations in the seat model using both a more compliant model and a stiffer model to look at the effect on secondary impact response. With our occupant model, each simulation requires on the order of 4-8 CPU hours on a workstation.

Calculations were performed for secondary impacts at velocities of 15 and 20 miles per hour. The two examples I'm going to show are at 20-miles-an-hour secondary impact velocity. What you see is that initially the occupant with applied deceleration is uncoupled from the interior structures and he just translates forward until his knees impact the seatback in the forward row. For the compliant seat model, shown here, the impact pushes the seatback forward and out of the way. The overall response is such that only a very minor impact occurs between the occupants head and the seatback. For this case, we calculate a head injury criterion (HIC) of 77. This is a very low value with a HIC of 1000 considered the threshold of significant injury. However, this is a little misleading because the occupant still has a significant forward velocity relative to the interior. Thus the occupant would probably still be thrown over the seat, producing a tertiary impact that needs to be considered. Simply using a very compliant seat doesn't mean the occupants are protected. However, in this study we only analyzed the prompt response of the occupant and two-seat rows.

This slide shows the secondary impact response with the stiffer seat model. In this case, the seatback is not pushed out of the way, and the occupant hits his head on the top of the seatback. This produces a severe deceleration of his head, and we calculate a HIC of over 4000, indicating a high potential for injury for this response.

To summarize the interior assessment simulation, injury potential was found to be very sensitive to the stiffnesses in the interior structures. This shows that you have potential for protecting unrestrained occupants in these types of collisions if you design your interior structures to be friendly to the secondary response. However, there's also potential for occupants to be injured in secondary impacts if you don't design the interior structures properly. In addition, the calculations show that to assess interior safety accurately, you need to know the detailed design of the existing car interior structures and be able to model those structures with the occupant interactions.

To conclude, we chose a three-step methodology to analyze overall train collision safety response that we believe successfully solves the entire range of responses. These three response analyses are: (1) the detailed car crash response, (2) the overall train collision dynamics, and (3) the interior assessment and occupant survivability. But, to finish, we also wanted to address the future needs for this approach: the first thing is that the detailed model needs to have the couplers added and perform more simulations of the inner car forces interactions. That will tell you more about the detailed response of the cars in the consist, and it also feeds into the simplified model so that you can do a better job of lateral buckling and override. Another need for future analyses is in the third step, the occupant assessment and interior model, where more detailed descriptions of the interior structures is needed.

DR. WEINSTOCK: Sara?

SARA LYMAN: Thank you, Steve. I'm Sara Lyman from Bruce Allen & Hamilton. I think you've shown that DYNA modeling can model interesting scenarios in a practical amount of time. I would like to caution, however, that based on my work when I was at Livermore, when you're doing models of detailed end structures collapse, the buckling and crush behavior can differ greatly from what actually happens; and in fact small differences in modeling assumptions can make significant differences in the behavior. So although this is really a useful tool for capturing qualitative behavior and finding out how things in general behave, I would caution against using this as a predictive or design tool, especially for detailed structural behavior, without testing as well.

MR. KIRKPATRICK: Yes, I think you make a good point. In the past, we've done work in other areas where we studied dynamic buckling of shell structures. In that case, we had a big advantage in that we were doing experiments in parallel. This allowed us to examine how different features such as structural imperfections influence the response. We found that for those structures, thin cylindrical shells, structural imperfections made a big difference, and that if you don't model those imperfections you're not going to predict the right behavior.

The train collision problem has some advantages in that the car geometry, and the collision scenario, produce areas where localization would naturally occur. I think the simulations we performed allowed us to learn a lot about these responses. However, I agree that we would really like to have some experimental work. I think that's a good subject to bring up here: it is a good time to start thinking about performing some well-instrumented train collision validation experiments.

DR. WEINSTOCK: Ron? Please remember to identify yourself and your organization.

RON MAYVILLE: I'm Ron Mayville with Arthur D. Little. Just a couple of questions: One, did you look at fracture as a limiting criterion for crush in your analysis? And the other one is: What did the load crush curve look like for the barrier impact, the corner impact? What was the peak load, for example, and how much energy was absorbed?

MR. KIRKPATRICK: On the second question about the corner impact: that simulation was done fairly recently, and we haven't carried it through to the same levels of deformation. The simulation was not part of the original study that was presented here, and I haven't done a direct comparison. However, by looking at the gross decelerations, I would say the crush force is fairly small fraction if the force calculated for the barrier impact, maybe 20 percent. However, I'd have to go back and look at that in more detail to be certain. And the first question again was-

MR. MAYVILLE: Did you see a fracture?

MR. KIRKPATRICK: No, we didn't include that. I think it's an area that we need to look at more: At what point do you get failure of the members? This could be added to the simulations however it adds significant complexity. Also, to model failure properly, we would need some test data to determine appropriate failure criteria.

DR. WEINSTOCK: Song?

SONG SING: Song Sing from the AAR. One question: in your video you showed the initial impact and the rebound, and I thought that those two parts were separated. The parts remain connected, I think so, because the way you had the picture...

MR. KIRKPATRICK: You're talking about the collision dynamic simulation, where you have the...

MR. SING: ...they bump and then separate. That would not happen because the cars would be coupled, right?

MR. KIRKPATRICK: Well, that depends on the severity of the collision and the strength of the coupler. In that case, those couplers underwent a lot of rotation and failed in our model. However, that brings up one of the points that I tried to make, we need to do a better job of modeling the couplers and interactions of cars. This requires doing a detailed analysis of the couplers to develop a better representation coupler response.

MR. SING: In the same comment, you're talking about the buckling. Once you get to that point, and then you have to worry about how many of the cars are still trapped on the track and how many have dropped on the ground. Right now you are just assuming they're kind of free floating...

MR. KIRKPATRICK: Yes, it's a very difficult problem determining the appropriate amount of constraint that would be provided to cars by the track during a derailment. In our simulations we neglected this effect. The consequences of this assumption needs further analysis.

DR. WEINSTOCK: In terms of your side impact analysis, did you include any lateral degrees of freedom, or what it strictly longitudinal degrees of freedom?

MR. KIRKPATRICK: All six degrees of freedom were allowed for each train car.

DR. WEINSTOCK: So it had to touch to move collaterally.

MR. KIRKPATRICK: Right.

DR. WEINSTOCK: Kris, you have a question?

MS. SEVERSON: Kris Severson, Volpe Center. I'm wondering how you defined a compliant versus a stiff seat. You said you used static test data—just because the disparity between 77 and 4500 for the HIC seems huge. I would expect to see, even for a more rigid seat, HIC's that are much lower. And I understand that it's extremely sensitive to the stiffness. I wonder how you define this stiffness.

MR. KIRKPATRICK: The stiffness of the baseline compliance was done by looking at the static force deflection for the high load application. And then by that we basically built in an elastic plastic hinge at the bottom of the seatback to match that kind of force deflection characteristic. When we did the simulations on that, it looked fairly compliant compared to the videos of the sled tests; and as a result, we doubled that value to look at the variation in response.

NICOLE POWERS: Nicole Powers. I'm wondering how do you take the materials characteristics into consideration for the global model? What do you consider work hardening, for example?

MR. KIRKPATRICK: Yes, there are several different materials involved in that structure, and for each one of those, we defined the plastic behavior using both a yield stress and hardening modulus, so elastic-plastic behavior with linear hardening was used.

MS. POWERS: What kind of model did you take—an existing rail car?

MR. KIRKPATRICK: We were looking at existing rail car designs and using them to design a generic car, so we looked at standard design practice and then used that. We wanted to stay away from any one design from a specific manufacturer. Instead we wanted to analyze the behavior for this class of cars.

MS. POWERS: Did you look at a difference of response of different materials?

MR. KIRKPATRICK: We didn't analyze different materials directly, although we did look at the effect of changing thickness of certain components, such as the thickness of the outer skin and analyzed the effect on the overall crush force characteristics.

MS. POWERS: Are you saying that you used different materials, say aluminum, stainless steel...

MR. KIRKPATRICK: No, there were...

MS. POWERS: ...have different characteristic behavior...

MR. KIRKPATRICK: Yes, the materials were all steels, and we used representative properties for steels that are used in rail equipment fabrication.

MS. POWERS: Thank you.

DR. WEINSTOCK: Are there any more questions? Okay, thank you very much, Steve.
[Applause]

PRESENTATION

HIGH-SPEED COLLISION SAFETY

High-Speed Rail Collision Safety **Approach to Crashworthiness and Accident** **Survivability**

Steven W. Kirkpatrick
Jeffrey W. Simons

SRI International
Menlo Park, CA

June 25, 1996

Rail Crashworthiness Complexity



**Collision response includes large displacements and deformations,
complex consist collision dynamics, interior secondary collisions.**

Previous Crash Analyses

- Design analyses of North American rail cars primarily for static buff strength.
- Detailed finite element simulations of European rail equipment.

analyzing the nonlinear dynamic crash response.

- Understanding the crash response requires modeling the entire train car **structure**.
 - eliminate assumptions on the B.C. and include the structural component interactions.

Approach for Collision Safety Analysis

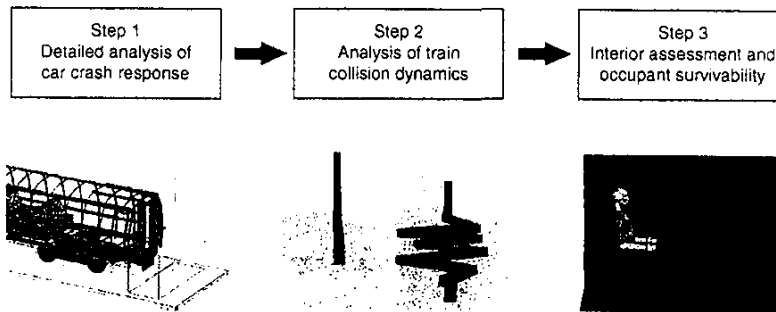

Approach for Collision Safety Analysis

- **Detailed analysis of car crash response**
 - Develop understanding of the car collision response
 - Develop crush curves for the generic car
- **Analysis of train collision dynamics**
 - Simplified models using effective crush response
 - Simulate response for various collision scenarios
 - Determine interior crash environments for occupants
- **Interior assessment and occupant survivability**
 - Occupant and interior interaction in secondary collision
 - Injury assessment for various crash environments

Detailed Car Crash Analysis

- **Structural model definition**
 - Approximately 50,000 elements
 - Structural definition provided by Foster-Miller

- **Collision scenarios**
 - 30 and 60 mph into various 50 ton masses
 - Mass representative of a second train car

- **DYNA3D crash simulations**
 - Accurate representation of crash response mechanisms
 - Approximately 40 CPU hour for simulation to 0.1 second
 - 105 inches of travel at 60 mph.

Detailed Car Model

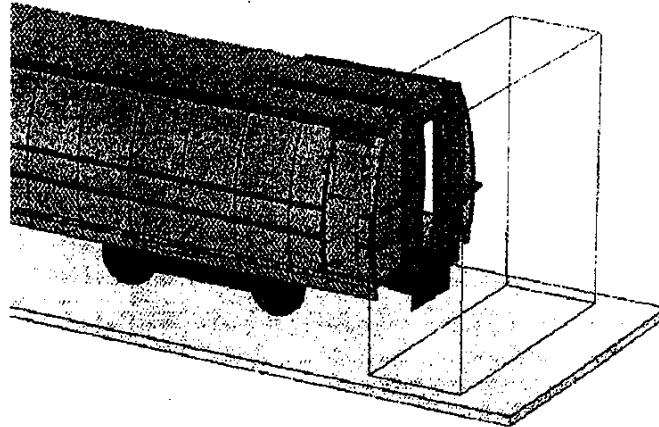

Detailed Car Model

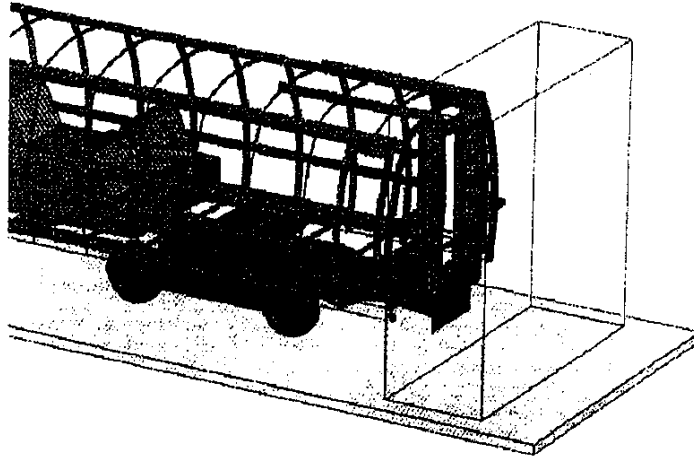

Detailed Car Model

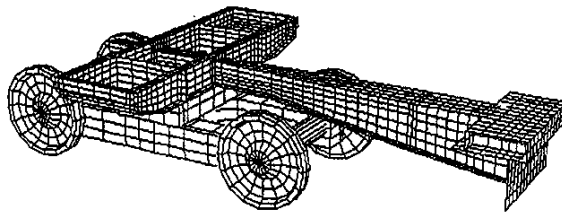

Mesh resolution in body bolster and draft sill

Calculated Crash Response

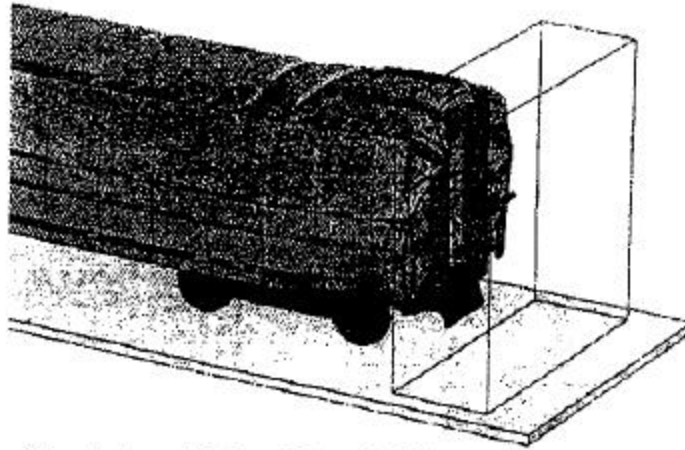

60 mph impact into a 50 ton rigid but movable mass

Calculated Crash Response



60 mph impact into a 50 ton rigid but movable mass

Detailed Car Crash Analysis

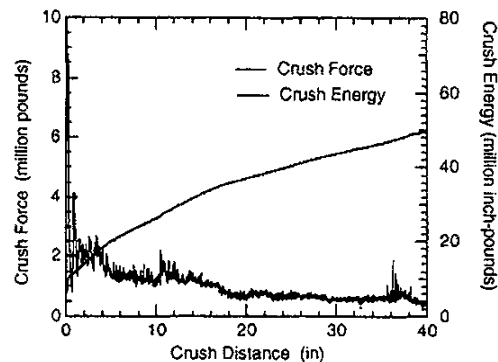

60 mph impact into a 50 ton rigid but movable mass

Detailed Car Model Applications

- Define characteristic crush behavior.
- Investigate design modifications for improved crashworthiness.
 - Effect of the side doors on the car end crush behavior.
 - Effect of increased thickness of structural members or other structural design modifications.
- Investigate other collision responses.
 - Intercar forces and initiation of override.
 - Intercar forces and moments and coupler response in lateral buckling.
 - Oblique or offset impacts such as could occur at switches.

Detailed Car Crash Analysis

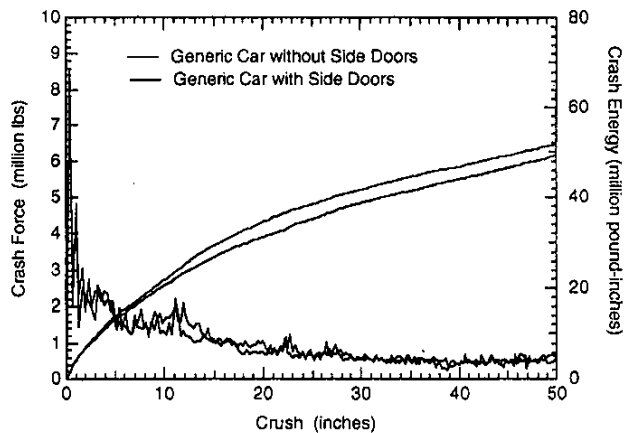

60 mph impact into a 50 ton rigid but movable mass

Detailed Car Model Versatility

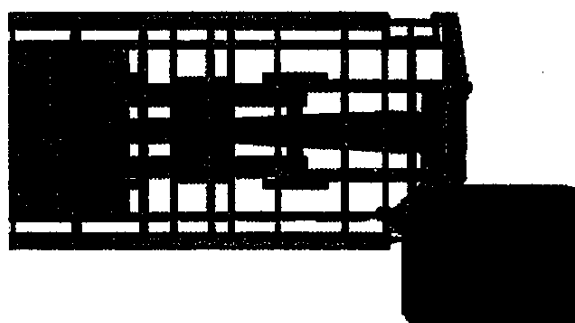

Partial Barrier Impact Simulation

Detailed Car Model Versatility

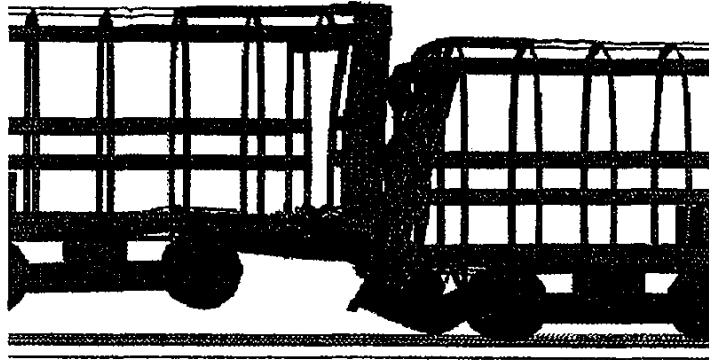

Override Crush Simulation

Detailed Car Analysis Summary

- Detailed car model simulations were very helpful for understanding the collision responses of the generic coach car.
- A characteristic crush curve was obtained with a “steady-state” crush strength of approximately 500,000 lbs.
- Addition of the coupler and draft gear to the model is needed for calculating car interactions.

Train Collision Dynamics Analysis

- **DYNA3D model of consist with effective crush behavior.**
 - Model of lower fidelity but with much shorter run times
 - Used in crash scenario parametric studies
 - Capable of incorporating three dimensional crash responses
 - override
 - lateral buckling
- **Used to define range of crash environments for occupant response.**

Simplified Car Model

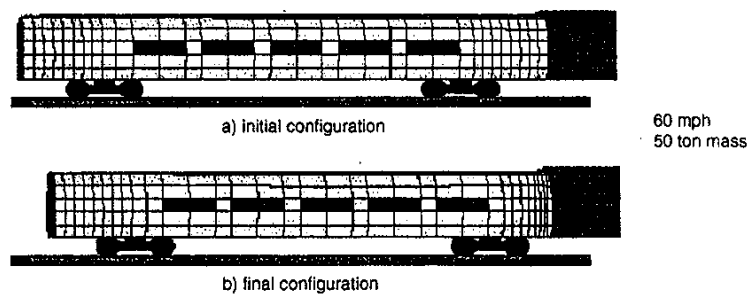

- **Simplified car model with effective crush behavior**
 - Model of lower fidelity but with much shorter run times
 - Several simplified cars used to create train models

Train Collision Dynamics

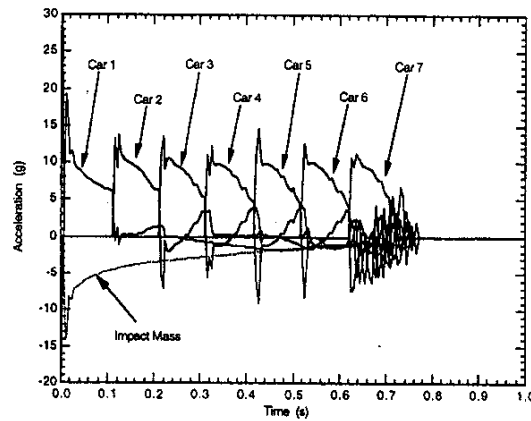

65 mph impact of a 7 car consist with an 80 ton mass

Train Collision Dynamics

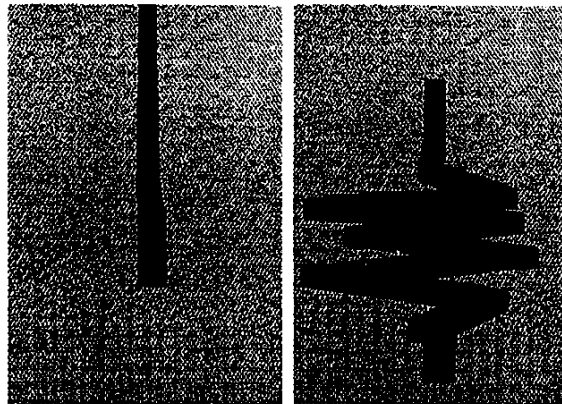

Lateral Buckling of Derailed Consist

Train Collision Dynamics Summary

- **Simplified collision dynamics models defined interior crash environments and crush regions for in-line crash behavior.**
- **Crash environments well within human tolerance for fully restrained occupants.**
- **Models are capable of predicting lateral buckling and override but additional information is needed on intercar forces and moments for validation of model.**

Interior & Occupant Assessment

- **DYNA3D occupant model development based on anthropomorphic test device structures.**
- **Interior assessment model strengths:**
 - **Excellent for modeling seats and interior structures and calculating occupant/interior interaction.**
 - **Potential for higher fidelity occupant response simulations than rigid body occupant models.**
- **Interior assessment model requirements:**
 - **Requires accurate simulation of the car interior to model the true secondary impact response.**
 - **4-8 CPU hours per simulation on workstation.**

Interior & Occupant Model

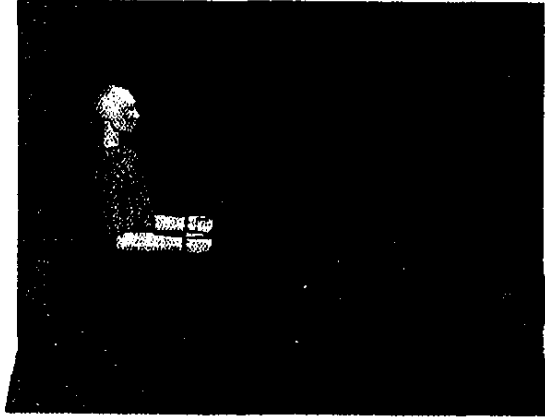

- 2 Seat Models:
 - Compliant
 - Stiff

50th percentile male occupant model with simplified interior configuration

Occupant Secondary Impact Response

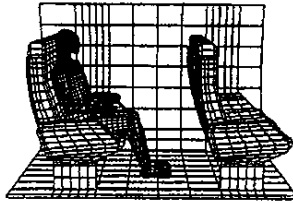

(a) Time = 0.0 ms

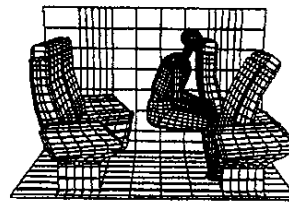

(c) Time = 160 ms

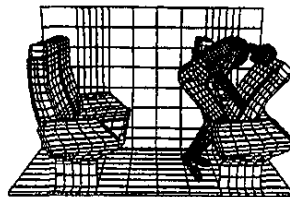

(e) Time = 250 ms

HIC = 77

20 mph secondary impact with the compliant seat model.

Occupant Secondary Impact Response

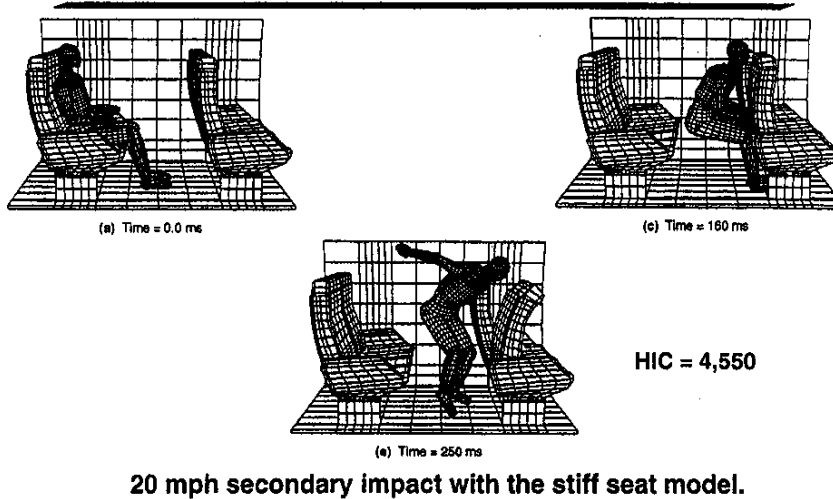

Interior Assessment Summary

- Calculation of head injury criterion (HIC) found to be sensitive to the stiffness of the car seat model.
- There is potential for significant safety enhancement with crashworthy interior structures.
- Accurate assessment of existing car interior safety requires detailed modeling of seat and interior structures.

Conclusion

- Approach successfully solves the entire range of the collision safety problem.
 - Detailed car crash response
 - Train collision dynamics
 - Interior assessment and occupant survivability

Collision Safety Analysis Future Needs

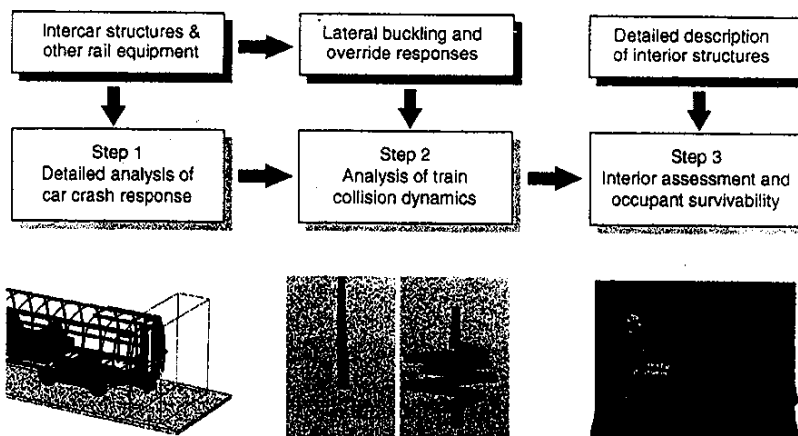

Crush-Zone Development

DR. WEINSTOCK: And to retaliate for my quip on privatization and free enterprise conditions, we've asked Professor Rod Smith to join us. Professor Smith is the Royal Academy of Engineering British Rail Research Professor resident at the University of Sheffield, and he's been at Sheffield for about the past eight years and he is also the chairman of the Advanced Railway Research Directorate at the university. He's been very active in research with British Rail. His area of expertise is most heavily in the areas of fatigue, fracture, structural integrity. He received his doctorate from Cambridge University and his first degree from Oxford University (that's in England). He was very heavily involved and heavily instrumental in working with British Rail on definition of the crush characteristics of the crashworthy cars that they just completed design and research on. So let me present Professor Rod Smith. Dr. Smith.

DR. SMITH: Good morning, ladies and gentleman. The topic of my talk is crush-zone development. I want to introduce you to just a few general ideas about crashworthiness of vehicles, and trains in particular. And a lot of the work will be discussed in detail by John Lewis from British Rail Research, an organization which conducted a lot of this test program over the last few years.

Watching television last night, there was a program about the history of the automobile in America since the last war. And there was a section on the fierce debate you had at the time Ralph Nader wrote the book Unsafe at Any Speed. And Lyndon Johnson, then President, appeared and said, "We are going to assure our citizens that every car is as safe as modern knowledge can make it." He said that in 1969. And it seems to me that that is really what we're about in this debate about crashworthiness of trains. The automobile industry has responded. This is an advertisement taken from a newspaper a couple of weeks ago; it illustrates crush zones, survival spaces; the language of side impact bars, air bags and so on, have all been introduced in our vocabulary since 1970.

The railway industry, of course, has a much greater time scale for change. Many of the vehicles that are running around are 20, 30, 40 or even more years old. The pace at which they're replaced is much slower than automobiles. The technological window through which we can operate is much, much longer. That opens in fact a completely new debate about the philosophy we should have in designing railway vehicles. In the past, they've been designed to be extremely strong, rugged, and to last as long as possible. Their maintenance costs have been very high. One wonders in the future it might be better to build them to last shorter with considerably reduced maintenance costs so their life cycle costs are much more effective. As an added bonus, of course, the technological window will be much shorter, and we can put into them much more modern developments.

The automobile industry has responded to demands for safer products and crashworthiness designs, and I've mentioned the vocabulary that they've introduced: it doesn't work at any speed. If you hit something hard enough fast enough, a car will disintegrate badly. Kinetic energy is a product of mass times velocity squared, and if you push up the velocity too much you will have great difficulty in protecting the occupants. But mention has been made of the importance of

mass; if you calculate one of the efficiencies of the transport system to minimize fuel consumption and infrastructure damage as the structural mass per passenger, then conversely the more mass you have around you, the safer you're likely to be in a collision.

If you're wearing a pair of roller skates and you're hitting an automobile, then your one kilogram of mass per passenger doesn't protect you against the automobile. If you want to make a train that will withstand 500-mile-an-hour collisions, you ought to build it like a Sherman tank.

Clearly, engineering is a compromise between the conflicting requirements of mass for protection and lowering mass for energy usage, acceleration, and so forth. We're talking about a dramatic engineering compromise here, and since engineering is the art of being approximately right rather than exactly wrong, I think we ought to enter this debate in that sort of spirit.

The fascinating history of railroads is littered with spectacular accidents. Here is an engraving of a wooden coach being completely disintegrated in an impact at about the turn of the century. All the early railway passenger vehicles were made of wood, and they suffered very badly in impacts. Overriding of the vehicles was very difficult to avoid because the vehicles had rigid underframes and very flimsy superstructures which collapsed in collisions.

We relatively recently, in terms of the history of railways, started building vehicles from steels. Steels produce much more rigid structures which don't crumple in collisions in quite the same way. It's still possible to get gross overriding. This picture from Bangladesh illustrates the point: a relatively low-speed collision, and quite a lot of people were killed in this accident.

To carry on with the theme that if you hit things hard enough they disintegrate, this spectacular accident occurred in France not too long ago: complete overriding of one vehicle and disintegration of the vehicle. I think the speeds were up to about 100 miles an hour at this collision; perhaps our French colleagues could tell us more. It's there as a warning that really there are limits to what we can do.

The incidence of grade crossings was mentioned several times yesterday as high risk in the railway industry. In the UK, we call them level crossings, but the principle is the same: the drivers play a game with the trains, trying to get in front of the trains just before or just after the barriers have closed. This particular accident was taken as a publicity shot to warn drivers about the danger of driving in front of trains. Depending on the size of the vehicle, of course, if the vehicle is a small one like this, then the train can happily override it and crush the vehicle underneath its front wheels. Not too good for the driver and passengers in here, but good for the train. If it's a heavy truck, then the situation is considerably different. It's an accident which is extremely common in the U.S. and in Japan, and a lot of work has been carried out in Japan to reinforce front end structures against the collision of trains and heavy goods vehicles.

In the U.K., an accident occurred six or seven years ago at Clapham Junction. The stock was very old; you will notice the doors of this train, it has many doors on the side because it's commuter stock. This superstructure is very flimsy; the stock was over 30 or possibly 40 years old, and this accident created great consternation about the strength of old railway stock. Another accident happened not too long after that at Cannon Street Station in London, and one coach in the middle of a consist was destroyed and you can see the flimsy nature of the construction of the coach. The point about this accident was that it prompted a call to examine

the strength of older rolling stock and to make some proposals about the strength of new built rolling stock in the future.

And this really was the origin of BR's expensive program that's been conducted over the last five years or so. John Lewis will say more about that program and how its various parts were put together. The program came about because of the pressure for reassessment of carriage safety. It was very obvious we will have to be moving away from rigid underframes and light superstructures, for the reasons I've already shown you. It was decided to introduce the concept of crumple zones to reduce injuries instead of lives, in effect technology transformed from the automobile industry. And it was recognized, of course, that prevention of override was crucial, and the counter-climb devices, which had been in use in the end of the last century in the U.S. and in Britain, should be introduced again to stop overriding as far as possible.

It shouldn't be necessary to say that all this was conducted in an atmosphere of "these developments mustn't cost any money," because of the need for cost efficiency in the railroad system. I see no reason after having gone through this exercise why crashworthy design should cost any more money than any other sorts of designs. Most of the work is done on the drawing boards and in the minds of the engineers who are making the concepts. There's no particular reason why the design should be any more expensive. If it comes to modification of existing stock, than the picture is quite different in retrofitting of crashworthy features into existing stock may well be an expensive and possibly fruitless exercise. We ought to take notice, again, of the automobile industry. Since 1970, the introduction of crashworthy designs hasn't added significantly to price. It's done through good engineering and cost effectiveness.

The figures that were the outcome of BR's very careful study of accident statistics over a number of years were that in moderate collisions at about 40 miles an hour, most deaths and injuries occurred from end-on collisions and most saving of lives in injuries could be made by protecting vehicles through good crashworthy design at those sort of speeds. And a criterion was developed, which in round figures says that the ends of the vehicles should crush by a meter, and in that crushing absorb one megajoule of energy. Clearly at different speeds they will have different characteristics, but the compromise response would still be, we're making an improvement. The whole idea of this crushing distance and absorption of energy is of course so that the decelerations transmitted to the passengers in the train are substantially reduced. And it is here that I have a great worry about the debate that's been going on at this meeting, about designing for strength on proof-loading of the vehicle, presumably proof-loads which must be resisted without any permanent deformation. That says nothing about the subsequent behavior at higher loads. And we can pass a proof-load test and build an absolutely rigid structure, but it wouldn't do anything for the passengers in the event of a collision. So I think we've got to move away from that single-value proof-load that must be passed, to a more sophisticated criterion which at least acknowledges the possibility of permanent deformation at higher loads than the proof-load and makes some estimates of the energy that will be absorbed at those higher loads.

This idea isn't new. One of the speakers this morning mentioned somebody in the 1920's who was talking about crush zones. A gentleman in the UK in about 1850 designed a crashworthy train with crush zones between the carriages. You'll see from the slide why the things were called carriages; these were really horse-drawn carriages on wheels. And here are the special zones which he designed between the carriages, which were encased in leather to make them

airtight. And he had some longitudinal strength, so here was a rigid survival zone for the passengers, with rigid cast iron tubes holding that interval to make a survival space. And here were the leather-covered crush zones, airtight, which when the collision occurred, compressed the air inside the carriages and absorbed the energy.

Now you can do a little calculation, presumably an adiabatic pressure changes over a small period of time, and you can work out, knowing the dimensions of the vehicles, the likely forces involved, and it looks reasonably practical. What they haven't done is to look at the discomfort caused to the passengers when this sudden compression of air takes place in the coaches. I think there would be quite a lot of burst ear drums in quite minor accidents. But I show you this just to show you that there's nothing quite new in the world. As early as 1850 these sort of ideas were being thought about.

The concept that BR developed, as has been mentioned already by Herb in his presentation of each carriage looking after itself, is such that there's a gap between the carriages. The first carriage completes its crushing and reduces its speed to nearly zero before the next coach impinges on the back this interface. And so on down the line. So instead of having one big collision absorbing all the energy, the energy is partitioned between the carriages and each one absorbs a certain amount of energy in a sequence of collisions. That concept has been tested experimentally and my colleague John Lewis will talk to you at greater length about the tests this afternoon.

The central idea, of course, is that we can crush elements of the structure of the vehicle and we can control what the crushing load is by controlling the plastic deformation. We can integrate the area underneath the force/crush curve and calculate the absorbed energy. Typically, these sort of simple structures need a high load to initiate the crumpling, and then the geometry of these crumples causes an oscillation on the load-crush distance response curve. And that's the sort of thing we need to control by geometry and structure.

This example is rather interesting. This slide shows a water bottle. You are perhaps familiar with the brand of the water bottle. And this was an advertisement in the Metro system in Paris. The train I was on was passing this advertisement, and the next stage of the advertisement shows the bottle crushed and collapsed with these wrinkles in it to save space in the garbage can. Well, I had taken my wife to Paris for our 20th wedding anniversary. We were on the Metro train. I saw these advertisements and I was so excited scientifically, that I thought that there was bound to be a presentation in the future that I could show pictures at. So I jumped out of the train and took these pictures and then realized that the train had gone on with my wife inside it. [Laughter.] We had no method of communication, no portable phone or anything like that. It was some time before we were reunited in our hotel. I ought to tell you that the next 20 years are looking quite difficult. [Laughter.]

It is worth studying basic physics because, whatever we do, we can't beat the laws of physics. We've got to operate within the parameters that they dictate. I've looked here at a very simple collision: an object of length l with average density ρ and area a impacting with a velocity v against a rigid wall. And during the collision it is crushed by an amount δ , so its overall length after the collision is $(l - \delta)$. Now the same sort of stress crush /distance characteristic--the load divided by the area -- will follow some experimentally determined curve,

but let's call the average value of that, the cushioning stress, y . The equation of motion for this object during this collision—the force, which is the stress times the impacting area at the end—is simply the mass times the acceleration, where the mass is the density times the volume.

So the deceleration is given by y , material property, divided by the density, a material property, divided by the length. So the deceleration is proportional to the reciprocal of the length. The longer the length, the less severe we can make the deceleration. And that's an important physical point. Automobile manufacturers haven't got great lengths to operate with, and they've managed energy dissipation rather well. We in railways have got greater lengths to play with, and we should be able to do better.

If we equate the kinetic energy before the collision, which is simply half the mass written as ρ (a, l) times the velocity squared, and equate it to the work done during this crushing process, which is the force, the area times the crushing stress, times the crushing length; then you can reorganize that equation in a non-dimensional form: the product of the density times the velocity squared divided by the crushing stress is equal to 2Δ times l, which is a measure of the crushing strain, the crumple zone length. And so this is a damage number in the collision. Two of the properties—the density and the crushing stress—are material properties; and the velocity, of course, is what we're trying to design against.

Taking this very simple approach, reorganizing that expression here, and plotting out crushing strength against density for all the engineering materials we know, we obtain this rather complicated plot which is explained in detail in one of the papers in the handout. So this is a logarithmic plot of strength against density. And the balloons on here are typical engineering materials: steels, aluminum alloys, composites, and so on.

We can plot straight lines on this logarithmic plot which are the velocities and crushing strains that we are prepared to design for. I have indicated two on this plot: the top line is a large velocity of 100 meters per second and a crushing strain of one-tenth; and typically a steel bullet will undergo that crushing strain when it hits an object at that sort of speed. And we see a line of equal performance along this top line here that a wooden bullet would at the same velocity have the same crushing strain. So you can move along this line and pick out materials that will behave in the same way.

Now the lower line, indicated by the bottom of this red overlay, is a velocity of 16 meters per second and a crushing strain which is typical of the 1 meter in the length of a railway coach. And anything along this line will operate in the same way, but of course we are constrained by the construction of the coach and the density that we make it to operate at these sorts of levels down here. A bit lower at the bottom is the typical density of a railway coach, and these crushing strengths indicated by the blue line on that overlay are the typical crushing strengths that we would achieve for a railway coach. And if you translate these into experimentally observed forces and areas that we've observed from crushing tests, these are about the ballpark we work in. If you want to play about with different velocities, then you can shift these lines and make some predictions of the sort of structures and materials you need to make things out of.

If you are observant, underneath all this overlay you can see that we appear to be operating in an area which, if we built the coach out of solid material, it would be a polymer foam. And at first

sight that's not a particularly good material to make a railway coach out of, but it's a good material to stop a railway coach, and I've got some interesting references with some experiments with our high-speed train in Britain-experiments conducted 15 or more years ago-where an arresting device was made out of polymer foam to stop the train if something went wrong during testing and the brakes failed.

Of course, because of the density of the constructed material, we have things like steels converted through the geometry to tubes of different thickness-to-diameter ratios, which bring us down to this region down here. Similarly, aluminum honeycombs, change the density of solid aluminum by several orders of magnitude and the strength by perhaps one order of magnitude.

So the graph really serves to illustrate the point that the form of the geometry and the construction of the vehicle gets us into the area that we're operating in, and the detailed collapse is something that was dealt with in the last presentation. I'd like to just show how we built up modeling skill without going into too much detail. We started off by taking simple tubes-this is actually a polymer tube-and we've applied crushing with our three-dimensional models and we've followed the geometry of that tube. Perhaps a better picture is this color sequence of the deformation of the tube. And we've actually tied all these simple finite-element tests into experiments with the material. That was the comment that was made at the last presentation: the need to tie the finite element results to experimental results and fine-tune and close the loop all the time. Unless that is done, the finite element results appear to be producing plausible results, but they might be a long way from reality.

So we close this loop all the way through, starting with very simple geometries like this round tube. With BR's experimental facilities we take slightly more complicated square tubes and rectangular tubes, where the geometry of the buckling was not quite so well defined. We looked at simple structures; here's some substructure underneath the floor of a train, and we looked how that performed in the finite-element models, and we tied that to experiments that were done by BR at Derby. So all the time this loop between the finite element predictions and experiments was being closed.

More complicated still are tests on full-scale vehicle ends. John Lewis will talk about this in more detail. And of course this is an expensive business, and one doesn't want to have to do it too often; but one wants a modeling capability that you are convinced models what's happening in reality. Hence the need for doing some testing and validating the FE models and tuning them and understanding how these structures really work.

The collapse of these structures is controlled by the geometry and the joints, not really the material, although the joints are dominated by the material that these are made out of. The strength of the welds in these materials can dominate the bending and fracture behavior of all the components in this structure. What we've found is that we have considerable difficulty with aluminum structures because the heat-affected zones near the welds were much less strong than the surrounding material and therefore, concentrated strain locally; it took very high loads to initiate the fracture at the welds, but then the welds tended to zip open with very little energy absorption after the initial fracture. And that's quite different from the behavior of welded steel. We might expand on those ideas in a moment.

Here's the finite-element modeling of this sort of test, the sequence of the collapse of this test leading to the buckling of the floor and so on. Here are some experiments conducted on a deceptively simple little bin structure with a weld in the middle, one of the bins being made out of structural steel and one out of aluminum. And you can see even with the weld in the center, the steel bends absorbing a lot of energy; the aluminum alloy bends elastically. Nothing appears to be happening, a very high load is attained; the weld pops and fractures with no subsequent energy absorption leading to a completely different moment-force relationship.

So the detailed understanding of the joints in these materials is absolutely crucial to this finite-element modeling, as well as the geometry of the structure. I also should say we've had some difficulty with stainless steel and spot welds in stainless steel which appear to pop open in a similar way to these difficulties in aluminum. Here's an example of the splitting of such a weld in an aluminum structure. You can see the sharp lane where the weld is fractured with very little deformation in the area of the world. The overall response of the end of the cab is, of course, that you get high load to initiate the fracture; so we've passed the proofload test okay-the load increases further then, bang! something goes and with very little energy absorption the rest of the structure collapses, leaving in its wake very sharp and aggressive edges, which, of course, are not an advantage for a crashworthy design.

To emphasize the geometry, the last speaker talked about the effect of doors and openings. All these things need careful design if the end of the structure is going to be designed successfully. BR conducted a lot of tests on cabs of current design where crashworthiness hadn't been a design criterion. It also carried out tests on new designs both in steel and aluminum to show that these crashworthy designs could be successfully made and built without any additional cost. And I think that's a very important bottom line that John Lewis will talk about more afterwards. If in the initial design stage these considerations are made, and an understanding is available about how the materials, joints and geometries behave, then crashworthy design can be achieved and it can be done relatively easily and cost effectively.

I ought to say that we also conducted some unintentional experiments, that is real railway accidents, during this program. And anytime an accident occurred over this four- or five-year period, John's team would examine the detailed structural response of these vehicles. And this provided an additional feedback loop to bring reality into the program all the time. This was a very interesting accident involving one of the first-generation aluminum vehicles, rather similar to the one which you've seen in the crush test: a runaway diesel locomotive, a very substantial locomotive, impressed its presence on the front of this vehicle with some effect, as you can see here.

I haven't said anything about the response of passengers inside, because that's a completely different topic from the crush zone development. I did say at the beginning that the idea of the crush zone was to limit the decelerations seen by passengers. I would add one comment: the finite-element models of dummies are very good at modeling the behavior of dummies. Real people take evasive action, and in general their response is quite different.

We need to build intelligence into the dummies so they can take some protective and evasive action. John will talk this afternoon about the fullscale tests that were carried out on crashworthy

ends of trains and he will tell you about how the idea of the gap works and the sequencing of the collisions.

At the risk of appearing too complicated, it's worth trying to get some overview of the sort of activities that are involved in this crashworthiness modelling. We're looking at the structure of a train which typically is ten's of meters to hundred's of meters long. The object of looking at that big vehicle is to protect a passenger who has a typical size scale of one meter. And our engineering strategy is to design a crush zone of the order of a meter in the ends of the vehicle to protect the passenger. But the development of that crush zone is controlled by detailed microscopic behavior of the material. For example, at the heat-affected zones of welds. For example, at defects near welds and I mean metallurgical defects, not defects in the legalistic sense. And so the fracture processes can be controlled by incredibly small size scales in the order of microns or even down to atomic scales, since that's what fracture is about, separating materials atomistically. I find our finite-element models are quite good at coping with these microscopic events at this size scale, but to give them the input that we require to these microscopic scales, needs a really firm understanding of the fracture processes that are taking place inside the collapse zone. We shouldn't be afraid to mix theoretical predictions such as a mass/spring/damper lumped parameter models with laboratory tests, observation from accidents and any ties back to reality so that we can be sure that our theoretical predictions are in fact predictions of real behavior and not just fantasies.

[Applause]

HERBERT WEINSTOCK: Thank you. Do we have some questions?

HARVEY BOYD: I think I'll have to take a little bit of an issue with your comment that controlled crash energy management should not add any costs and you justify that by talking about the automobile and the great job they have done. Yet we're talking about crash energy management showing at least a 50 percent survivability at the speeds the equipment's going to be operating at.

If we apply that same thing to the automobile, 70-mile-per-hour collisions on the highways, do we show that type of survivability or if we're required to show that type of survivability will those costs indeed rise considerably from where they are presently?

DR. SMITH: I think you're saying what level are we designing vehicles for, in rail vehicles. At what level of potential survivability. I think that is a matter of debate. I thought I indicated clearly at the beginning that the higher the speed, the more difficult it is unless you add a lot of mass and that will add a lot of cost. I think the reasonable engineering compromise is to look at your accident statistics, as BR has done, and to decide where you can make most impact, perhaps an unfortunate term to use in this circumstance, where you can make most improvement to those figures. And BR decided that it was in relatively moderate end-on collisions.

Judging by the discussion here at this conference, it might be, and John has suggested this to me, that your accident statistics differ considerably from ours. I think you've got to look at those statistics carefully and decide where you can make most improvement. Generally speaking if you can make an improvement there, it will make an improvement in every other situation as well.

But if you start with the idea that you must design for 150-mile-an-hour collision and 98 percent survival rate, you're in a mess. An expensive mess.

JOHN LEWIS: The only point I was making is that within the UK, most of our accidents occur at speeds less than 40 miles an hour. I'll be presenting a few statistics first thing this afternoon to show that. I'm not sure what happens in the States. There were three accidents this morning that were sort of talked about, two at 70, one at 105 miles an hour. Now I don't know of any accidents in the UK that's happened at 105 miles an hour, or above 100, in the last 50 years. Our accidents tend to be very much below that speed. And so perhaps the requirements in the U.S. are going to be different from those in the UK, in that respect.

DR. SMITH: Yes, Sir?

GEORGE FEINSTEIN: George Feinstein, New York City Transit. From what I see I think that the problem is in definition. I think you're defining your accident speed in terms of the speed of the individual train. Here they're trying to define the accident in terms of the closing speed. That's why you're getting these monstrous speeds where they aren't actually the speeds of the train.

DR. SMITH: The point is yes, you might have one accident at very high closing speeds. But how many accidents do you have at slower closing speeds? So where is your design? You don't design for the extreme rare event. You design to have most effect on the most numerous events.

MIKE KLEINBERGER: Mike Kleinberger, National Highway Traffic Safety Administration. I'm not sure if I'm the only automotive representative here but I'd like to make a general comment which kind of ties into all of this. In the automotive industry, we can certainly document crashes well in excess of 100 miles per hour. That is not the way we design cars, that would be certainly expensive, if not impossible. We know from statistics that the vast majority of the accidents are under 30 miles an hour, and that's typically where we're designing our cars—30, 35, maybe 40 miles per hour. I mean we could design cars that could protect people at much faster speeds, it would be expensive, and again, you don't get the maximum benefit for your dollar.

DR. SMITH: Exactly the philosophy I was mentioning.

HERBERT WEINSTOCK: Are there any more questions on the design methodology? Yes?

PHIL STRONG: Phil Strong, Long Island Railroad. A couple comments. One, the cost of carrying extra weight, at least in our situation, the total operating cost is dominated by the maintenance cost of the vehicle, not by the fuel and the electricity costs, in the case of the MU. Secondly, the low speed collision damage that we note, derailments near station platforms and things like that, by and large don't result in passenger injury or at most, minor passenger injury, but they're very expensive in terms of repairs. We have 16 cars laid up now for having what we call long-term collision damage. So I would suggest that careful consideration be given to the tradeoffs of reducing the weight of the vehicle, at the expense of possibly incurring other costs.

DR. SMITH: Fair point. I'm very interested in the real drivers for reducing mass. I mean there are some fairly obvious benefits, not the least of which is reducing track damage if you have

lighter vehicles and reducing maintenance costs of the track. Surely, energy costs are a significant part of your operating costs. If you're saying your maintenance costs are dominating your operation, that's where you should be targeting some research.

PHIL STRONG: Just to repeat. If the three segments of operating costs were vehicle maintenance, fuel or electricity costs, and track maintenance, of those three in our case, vehicle maintenance is the highest. And maybe you're right, that does deserve some research. I'd be curious to know whether that's a common occurrence on other railroads. Is the vehicle maintenance cost their dominant cost?

DR. SMITH: We're having a big debate about vehicle maintenance costs and this whole idea of the lifetime of railway vehicles. If you look again at the automobile industry and think of a vehicle that you bought in the early 1960's, and the maintenance it required, and how frequently you had to have it serviced, and oil-greased nipples and goodness knows what. Modern vehicles, you basically forget them. Put a bit of oil in occasionally, but the maintenance requirements have changed, been reduced drastically. That doesn't appear to be the case in railway vehicles, partly because most of our vehicles are so old. But in our new designs, I really do feel we should be building for shorter life and zero maintenance. Because in the future, maintenance costs with people involved are going to be very expensive. If you want to cut costs, cut maintenance.

HERBERT WEINSTOCK: We say thank you again for an excellent presentation. And I think we'll close this morning's session and we should have a chance to get to rail designs this afternoon with the French experience and the English experience. Thank you very, very much, and we'll resume at one o'clock.

PRESENTATION

CRUSH-ZONE DEVELOPMENT

**Symposium on Rail Vehicle Crashworthiness
Volpe National Transportation System Center
Cambridge, Mass. 24 - 26 June 1996**

CRUSH ZONE DEVELOPMENT

RODERICK A. SMITH

Royal Academy of Engineering/British Rail Research Professor
Department of Mechanical and Process Engineering
The University of Sheffield
Mappin Street
Sheffield S1 3JD
UK

These notes serve as an aide-memoire for this presentation. The two published papers are attached (Railway Gazette International 151 No 4, April 1995, pp 227-230, ASME, AMD-Vol 210/BED-Vol 30 pp 79-88) which cover considerably more background than this presentation which concentrates on the development of crush zones in railway vehicles and considers materials aspects relevant to the problem.

Ideas about crush zones

The idea of including crush zones at the end of railway carriages is not new. Appendix 1 is an illustration from a pamphlet published by M A Garvey (c. 1850), called 'The Patent Spondyloid Life Train', which had the object "To secure perfect safety to passengers by railway on case of collision, by entirely dissipating the shock before it can reach the passengers by rendering it impossible for the carriages to mount over one another, to be thrown off the rails, or to be crushed together". This is a satisfactory objective for our designs of the 1990's! (Delegates may care to study Garvey's figures to try to understand how the system might work).

In 1958 K Swarup (J. Inst. Loco. Engrs. 48 No 264, pp 477-509) discussed the design of lightweight coaches and observed that his proposed coach, "possesses an extraordinary high compression rigidity, particularly over the entire length of the passenger compartments. This ensures a greater protection in the case of accidents, still further increased by the fact that the sections located at the ends i.e. lavatories, etc., possess lower compression rigidity than the passenger accommodation. In case of accidents these

parts would be destroyed first and this absorbs the collision energy. This is borne out by the behaviour of these light-weight coaches in an accident which took place on the Swiss Federal Railway".

In recent years crush zones for rail vehicles have received considerable attention, particularly by BR Research (described elsewhere at this meeting) for crush zones between vehicles in a rake and by S.N.F.C. for large crush zones at the front of a locomotive heading a rake.

- The main purpose of such a crush zone is to achieve a controlled deceleration force acting over a suitable distance and time, to bring the vehicle to rest, without transmitting damaging decelerations to the passengers.
 - Clearly the longer (physically) the crush zone, the more gentle the acceleration can be. There are obvious practical limits
 - The strategy of force/time/deceleration characteristics can be determined to the first order by simple mechanics (spring/mass models) and from a knowledge of the biomechanical responses of the occupants.
 - There remains the practical implementation of the strategy, through the detail design of the vehicle structure.
 - An important stage in this latter process, is the choice of material from which the crush zone is to be made.
 - Furthermore, the choice of the geometric configuration of the material is critical (tube, bar, rod).
- and
- The methods of joining the structure may well completely control the collapse mechanisms and hence the forces generated.

Expanding on the latter points

Our knowledge of materials under impact loadings is still largely confirmed to simple shapes of a given material. A standard reference is N Jones, *Structural Impact*, CUP 1989, which contains many details of tests on the simplest of structures such as the crushing of tubes, impact on plates and simple beams, etc., but joints and welding are not mentioned in the index! Faced with a more realistic and complex structure, our prediction capabilities of load/crush distance are severely tested.

Although large non-linear finite element packages are now routinely available, in a particular programme some feedback between experiment and prediction is necessary to tune the modelling used. Broadly speaking, structures made from steel are 'better behaved' than structures in aluminium and stainless steel. (It is worth noting that S.N.C.F. have banned the use of stainless steel in critical areas after a collision in Paris where the spot welds in a stainless vehicle appeared to shear with little or no energy absorption - static tests conducted in the UK have shown that heat affected zones in aluminium sections have failed in a globally brittle manner, leading to a characteristically high load to initiate failure, followed by rapid structural collapse at falling load levels).

These are examples of vehicles with steel ends on aluminium bodies - the rationale is that steel is 'better' understood and has more reproducible collapse characteristics and that the crush zone is a bolt-on which can be easily replaced in the event of damage. Some discontinuity of property between the crush zone and the main carriage body is desirable.

The appropriateness of size-scale is extremely important. This point is emphasised in Figure 3 of the attached ASME paper and will be the subject of considerable discussion during this presentation.

APPENDIX 1

The Patent Spondyloid Life Train

M A Garvey (c. 1850)

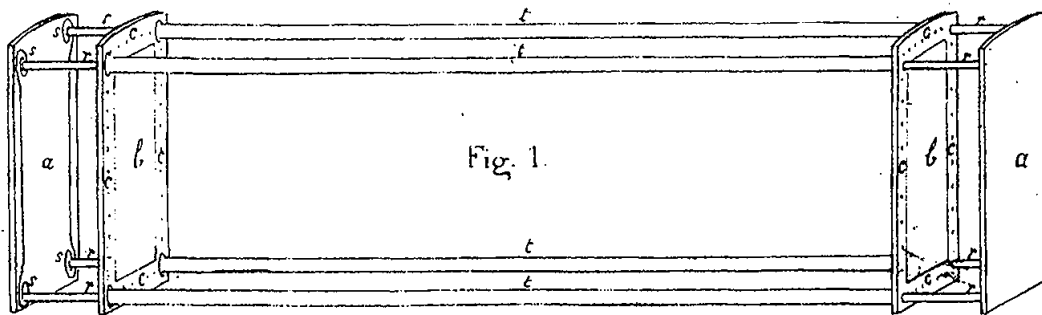

Fig. 1.

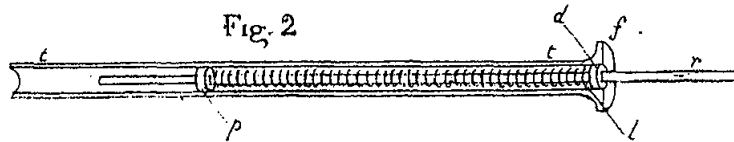

Fig. 2

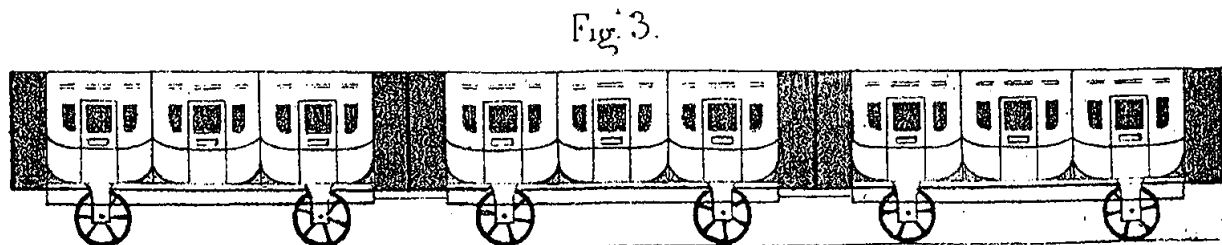

Fig. 3.

SAFETY



Crashworthiness moves from art to science

Up to now, strength standards for passenger coaches have been defined in terms of resistance to deformation by static loads. Now the emphasis is switching to energy absorption in zones designed to collapse in a collision at deceleration rates which passengers can survive

PASSENGER EXPECTATIONS, materials availability and construction techniques have changed enormously since the days of wooden railway coaches. Nevertheless, some of these changes are surprisingly recent. Large numbers of wooden-bodied vehicles were built after the second world war, and they continue to operate in many countries, particularly on commuter services. The introduction of steel underframes merely served to emphasise the fragile nature of a wooden superstructure, which often disintegrated completely in accidents, causing many fatalities.

Modern stock made from steel or aluminium

Professor R A Smith
Advanced Railway Research Centre
University of Sheffield

is perceived to be 'strong', and its ability to survive some major collisions or derailments relatively unscathed has been a testimony to this strength. Why then is a radical change of design philosophy needed for railway vehicles?

Current UIC and AAR standards are based on minimum compressive proof loads which must be resisted without permanent deformation, for example 200 tonnes end load in Europe, reduced to 150 tonnes for multiple

units. These standards are necessary to avoid damage in normal operation. Excess strength above these minima simply adds mass, and therefore kinetic energy to moving vehicles.

What is required in crash situations is a standard based on the ability to absorb energy, by relating imposed loads to a crushing distance. Ideally, the load to initiate this crushing should be just above the UIC minima. Indeed, there may well be a case for revising the required static end proof loads downwards once the principle of controlled collapse has been accepted.

EXPECTATIONS HAVE RISEN

Crashworthy design features of private cars now form a key element of their commercial advertising. The public is informed through newspapers and television about crumple zones, survival spaces, passenger restraint, airbags and side-impact bars. All these developments became necessary because accident statistics clearly demonstrate that car travel is substantially more dangerous per passenger-



Top: Despite a relatively low impact speed, BR's 1991 buffer stop collision at Cannon Street caused significant injuries when two commuter EMU cars telescoped; the heavy steel underframe scythed through the old bodysell of the adjacent vehicle

Left: The cab end of this Class 158 DMU buckled when hit by a Class 47 diesel loco near Stockport in June 1992, but other damage was minimal

SAFETY

km than competing modes such as buses, aeroplanes and trains.

However, rail accidents generate adverse publicity quite out of proportion to their seriousness in terms of risk exposure, and the pace of change of technology in rail vehicles is considerably slower than in the motor industry. Apart from the fact that the car market is both international and an order of magnitude larger, the economic life of rail vehicles is much longer.

Serious accidents in France during the 1980s, and more recently in Britain at Clapham Junction (1988) and Cannon Street (1991), have spawned investigations into crashworthy design for rail vehicles. The studies have many similarities, although the tests may have been addressing different aspects of the problem.

It is the professional duty of engineers to incorporate best practice into their designs, commensurate with cost and likely safety benefits. This last point is particularly important. If safety expenditure means increased fares, causing passengers to choose a more dangerous mode (usually their car), the end product of a safety programme may be increased deaths and injuries. This is a good example of the need to look at transport systems as a whole, rather than concentrating on particular elements. Readers will be aware of the inability of governments to understand this fundamental point!

A prime constraint on crashworthiness programmes is that any proposed changes must be cost effective. It can be argued that avoidance is our primary concern and that enhanced 'active' safety measures such as better signalling or ATP would help ensure that collisions do not occur. But by their very nature, accidents will continue to happen—the landslide that causes one train to derail into the path of another, for example. Hence the need for crashworthy vehicles. Nevertheless, the low probability of a collision and the likely consequences must be related to the cost of additional protection, especially if the retrofitting of older coaches is contemplated.

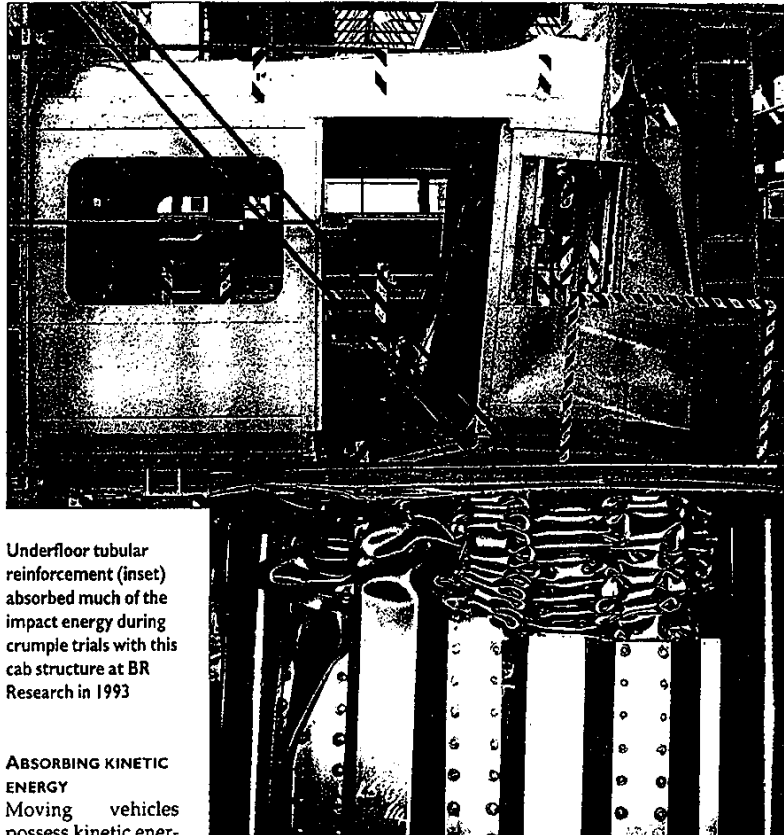
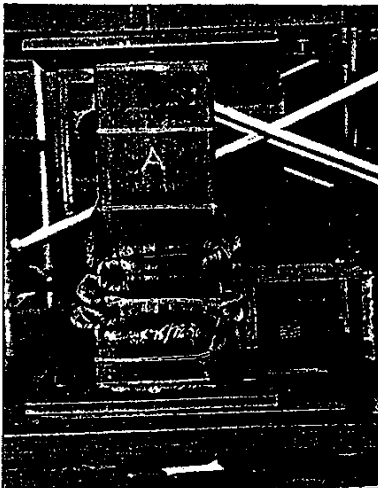

Underfloor tubular reinforcement (inset) absorbed much of the impact energy during crumple trials with this cab structure at BR Research in 1993

ABSORBING KINETIC ENERGY

Moving vehicles possess kinetic energy, calculated as half the product of the mass times velocity squared. The basic objective of a crashworthy design is to manage the rapid conversion of this energy into other forms (such as structural deformation) in ways that reduce the effects of rapid velocity changes on passengers. This means that the kinetic energy has to be absorbed by the collapsing structure in a way which seeks to reduce both vehicle and passenger deceleration rates.

The collapse must also ensure that a survival space remains within the collapsed vehicles, into which the deformed structure does not penetrate. Passengers must be retained within this space and not ejected from the vehicle; measures must also be taken to ameliorate secondary impacts between passengers and the vehicle interior, as well as loose objects like luggage.

LARGE MASS AT HIGH SPEED

Two key differences between trains and cars are immediately apparent.

Firstly, trains have considerably more mass than cars and move at much higher velocities. A typical car of 800kg mass moving at 50km/h possesses 0.078MJ of energy. A two-car Pacer railbus of 48tonnes has 4.7MJ, 60

times more, at the same speed. A Eurostar, at 752tonnes and travelling at 280km/h, multiplies the energy a further 500 times to 2344MJ. At this speed, the kinetic energy possessed by a train is almost exactly that required to raise it from ground level to the 318m height of the TV aerial at the top of the Eiffel Tower! Clearly the energy management of massive trains moving at high speeds presents considerable problems.

Secondly, passengers in trains are not restrained by seat belts, nor discouraged from moving around. Injuries at Cannon Street arose at an impact speed estimated to be between 15 and 20km/h, mainly because many passengers were standing prior to alighting.

With the demise of traditional compartments in favour of open saloons, the distance passengers might be projected subsequent to a collision (the 'flail distance') can be considerable, with consequent risk of serious injury on impacting interior fittings. Studies of interior design are particularly important, because opportunities for improvements on refurbishment will occur more frequently than major design changes at first build.

Two distinct philosophies of energy management in train collisions have been developed by British Rail and SNCF. Studies on crashworthiness at BR Research,

DIFFERENT PHILOSOPHIES

Two distinct philosophies of energy management in train collisions have been developed by British Rail and SNCF.

Studies on crashworthiness at BR Research,

SAFETY

Derby, began with a careful study of accident statistics over a long period to discover what areas might be most cost effective in improving safety. It was concluded that 64% of fatalities and 60% of serious injuries occurred as a result of end-on collisions, and that almost all fatalities (94%) occurred in end-on collisions at impact speeds below 60km/h. Furthermore, over-riding or 'telescoping'—when one coach rises above buffer level of the adjacent coach and slices through its superstructure—was the single most common cause of fatalities; 80% of fatalities resulted from the 5% of collisions where telescoping occurred.

With multiple-unit trains in mind, a criterion was developed in which all interfaces between coaches share a part of the energy absorbing process. The criterion reduced to providing a total of 1MJ of energy absorption capability in a deformation length of 1m at the end of each unit, and 0.5MJ at each side of each following interface between coaches within the unit. For a multiple-unit vehicle of 24 tonnes travelling at 60km/h, this leads to an approximate deceleration of 60m/s², about 6g, which is thought to be a reasonable figure for survival of passengers.

A key feature of this strategy is that each coach, as it were, looks after itself. To make this possible, the gap between adjacent coach bodies must be of such a size that the time taken in a collision for this gap to close is equal to the time taken for crushing and energy absorption to take place at the interface immediately in front (Fig 1). Thus a single collision is replaced by a succession of impacts, each absorbing the kinetic energy of a single coach rather than the total energy of the whole rake.

The approach in France has been dominated by studies involving the TGV. The essential feature is that these trains are headed by relatively massive power cars with long noses which are capable of being collapsed over much larger distances than 1m.

The TGV also has articulated bogies at all interfaces except between the power car and the first coach, which means that the coach bodies are very close together. This limits both the scope for sequential collisions, and the energy absorption capabilities which con-



ventional buffers and drawgear provide between adjacent vehicles.

SNCF has therefore developed nose designs which absorb as much as 6MJ at the front end and first interface.

PLASTIC DEFORMATION

How then is energy absorbed in a collapsing structure? The key principle is by permanent plastic deformation, as opposed to the elastic recoverable deformation produced by normal service loads.

The principle of plastic deformation is easily demonstrated by the collapse of an end-loaded tube into a series of concentric rings; each of the multiplicity of hinges so formed is bent through a large angle, thus absorbing large quantities of plastic work. The interested reader can test this concept by axially crushing an empty beer can (Fig 2).

A difficulty will become apparent: a high load is needed to initiate the collapse, but successive hinges form at lower load levels. As the energy absorbed is the area under the load/deformation curve, a specific amount of energy can be absorbed by a high collapse load over a small distance or by a low load over a larger distance. Ideally, 1MJ over 1m can be absorbed by a constant load of 1000kN.

In practice, crushing tests performed on full-scale cab ends initially produced load/deformation curves similar to that of the ideal tube, with high initiating loads.

Aluminium cabs proved to be particularly difficult however, because the welds failed at low local strains, precipitating a collapse of the structure without further plastic hinge formation. This problem arises because the grades of aluminium used in rail vehicles were chosen for properties needed to produce long extrusions, rather than for weldability. Welding this kind of aluminium produces a local region of diminished mechanical properties adjacent to the welds, known as the

BR Research conducted a full-size trial in October 1994, using two five-car trains of Mk1 stock fitted with anticlimbers at the ends (orange), and crumple tubes under the floor; the test proved highly successful with little or no damage to the passenger saloon areas

heat-affected zone. The problems of geometry and joints have much exercised engineers, but successful designs in both aluminium and steel have now been produced.

PREDICTIVE MODELS

It is obvious that full scale tests are expensive, so the capabilities of theoretical predictive models are important. In many countries, but principally in Britain, France and the USA, computer models using the finite-element technique have been used to predict load/collapse characteristics.

Initially, these models had to be 'tuned' using feedback from experiments, but knowledge—particularly of joint behaviour—has now improved to the extent that these models are now capable of making reasonable blind predictions. Full scale collision tests have been undertaken in France, Portugal, Japan and most recently and extensively in Britain.

In October last year, BR conducted a collision test between two rakes of five coaches each, one stationary, the other impacting at a speed of approximately 60 km/h. Old Mk1 coaches with separate underframes and body structures were used, but with the ends modi-

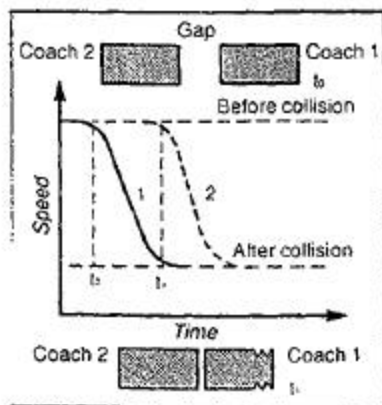

Left: Fig 1. Speed-time graph showing the concept of energy absorption through sequential collisions along the train

Right: Fig 2. Plastic deformation absorbs energy at the hinges as an end-loaded tube collapses into a series of concentric rings

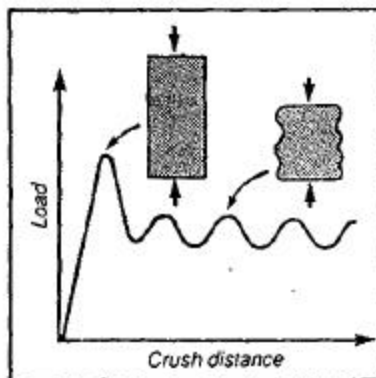

SAFETY

fied to absorb energy in successive deformations as outlined above. The test successfully demonstrated that the concept of energy sharing at the successive interfaces of the rake had been achieved without derailment and the effectiveness of ribbed anti-climb devices, fitted to prevent overriding. The experiment also demonstrated the capability of several predictive modelling techniques which have been developed, and showed that the integrity of the passenger survival spaces had been maintained.

INTERIOR DEVELOPMENTS

Considerable progress has also been made in the design of crashworthy interiors. Some features are obvious: elimination of aggressive corners on seats, grab-handles and partitions. Seat stiffness and head supports need careful design, as do tables and luggage storage spaces. Seating layout, with its many variations of unidirectional, forward or backward facing, bay-type or longitudinal, is a primary determinant of possible flail distances.

Much useful information has been obtained from investigations after accidents. Injuries to passengers have been correlated with their positions just before an accident, and severities of injuries have been related to particular types of secondary impacts. Clearly this is a sensitive area, which requires considerable tact, but it can lead to the accumulation of much valuable knowledge and plays an important role in crashworthiness development.

Accident information has been coupled with computer simulation of dummies in accidents, which as far as railway studies are concerned is still in its infancy for quantitative injury criteria predictions. This is because the models are of dummies rather than real people, and dummies have no intelligence to react in an instinctive protective manner on the onset of an impact event. Too little is yet known of the mechanical response of the human body to incorporate realistic features in the dummy models, but considerable work is being carried out by the automobile industry in this area.

The dummies leave their forward facing seats or standing positions with the velocity of the train immediately prior to impact, and with an acceleration determined by the severity of the collision - hence the aim of progres-

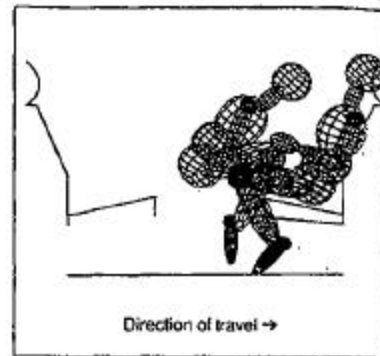
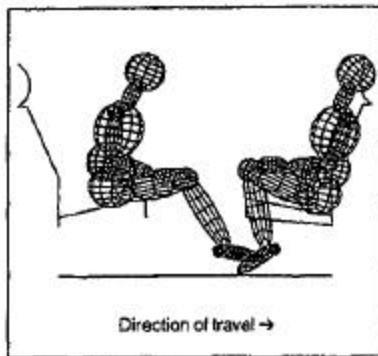

Fig 3. Computer simulations of passenger flail trajectories, 100 and 200 ms after impact

sive energy absorption to decelerate the vehicle more gently. The old adage 'it is better to sit with one's back to the engine' is graphically demonstrated (Fig 3).

The glaring conclusion to emerge from passenger/impact interaction studies is that seat belts would prevent injury. However, the number of deaths and injuries in train accidents is very low, and by no means all would be avoided by seat belts, so it is unlikely that adverse passenger reaction to such constraints could be overcome. A major selling point of the comfort of rail travel is 'quality time', in which the freedom to take a walk, get a drink from the buffet, and so on, is a major component.

DRIVERS AT RISK

It is clear that in the event of a collision, the driver is at high risk, particularly if he remains within the crumple zone. Approximately one third of fatalities which occur as a result of rail collisions in Britain are cab occupants. Netherlands Railways has also been studying this problem, in a bid to minimise the risks from collisions on its many level crossings.

Vigorous efforts are now being made to reduce the risks. Cab and desk fittings are being redesigned to reduce the likelihood of injury, and separate survival spaces which move backwards are being investigated. Also under study are the possibilities of air bags, burst-through doors and other means of rapid egress. Recent theoretical studies at BR Research indicate the effectiveness of such measures at collision speeds of up to 60 km/h; full-scale validation tests are planned for the near future.

INTERNATIONAL DEBATE

Discussions with colleagues in Japan reveal their astonishment that 'passive' safety measures for crashworthiness are a major issue. Accident statistics from Japan reveal that the number of people killed or injured inside trains is remarkably few, particularly on the Shinkansen, which has an unblemished safety record in its 30 years of operation.

Nevertheless, there is concern over level crossing accidents on conventional lines, which has led to strengthening of the front end of trains and improved driver protection.

Similar provisions have existed in the US for some years, but recent increased interest in high speed rail has led to several studies. A recent report from the Federal Railroad Administration suggests that 'maximum use of vehicle body crushability to absorb collision energy shall be made by designing the operator's cab and the passenger compartments to be significantly stronger than unoccupied equipment spaces in power vehicles, and vestibules or equivalent spaces at the ends of passenger vehicles and vehicle sections'.

Work is in progress in a wide range of countries that will change the design philosophy of rail vehicles. Instead of simply 'make it as strong as possible', we are now looking to 'make it as strong as necessary to withstand normal service loads, but use clever engineering at the ends of vehicles to disperse energy by structural collapse whilst maintaining the integrity of the occupied zones'.

LA RESISTANCE AUX ACCIDENTS PASA A SER CUESTION CIENTIFICA

Hasta ahora las normas de robustez para los coches de pasajeros han venido definiéndose en términos de resistencia a la deformación producida por las cargas estáticas aplicadas a los extremos del cuerpo. En lo sucesivo, la énfasis recae en la absorción de energía en las zonas de abollamiento, y de aquí en adelante se trata de una locomotora o de un vagón de ferrocarril. Estas zonas se diseñan ahora para que se deformen de forma controlada durante una colisión con el fin de producir velocidades de desaceleración que den a los pasajeros una buena posibilidad de supervivencia.

LA RESISTENCIA A LOS ACCIDENTES PASA A SER CUESTION CIENTIFICA

Hasta ahora las normas de robustez para los coches de pasajeros han venido definiéndose en términos de resistencia a la deformación producida por las cargas estáticas aplicadas a los extremos del cuerpo. En lo sucesivo, la énfasis recae en la absorción de energía en las zonas de abollamiento, y de aquí en adelante se trata de una locomotora o de un vagón de ferrocarril. Estas zonas se diseñan ahora para que se deformen de forma controlada durante una colisión con el fin de producir velocidades de desaceleración que den a los pasajeros una buena posibilidad de supervivencia.

LA RESISTENCIA A LOS ACCIDENTES PASA A SER CUESTION CIENTIFICA

Hasta ahora las normas de robustez para los coches de pasajeros han venido definiéndose en términos de resistencia a la deformación producida por las cargas estáticas aplicadas a los extremos del cuerpo. En lo sucesivo, la énfasis recae en la absorción de energía en las zonas de abollamiento, y de aquí en adelante se trata de una locomotora o de un vagón de ferrocarril. Estas zonas se diseñan ahora para que se deformen de forma controlada durante una colisión con el fin de producir velocidades de desaceleración que den a los pasajeros una buena posibilidad de supervivencia.

CRASHWORTHINESS OF TRAINS: PRINCIPLES AND PROGRESS

Roderick A Smith

Advanced Railway Research Centre
University of Sheffield
Sheffield
UK

ABSTRACT

This paper describes why crashworthy designs for rail vehicles are necessary, even though railways are a comparatively safe mode of transport. The concept of energy absorption is studied using a non-dimensional damage number which is shown to be useful in comparing situations of different materials, geometry, velocity and crushing strain. The importance of geometry and joints in real structures is identified.

A brief discussion is made of British Rail's energy absorption philosophy and the progress that has been made towards its realisation. The various important size scales which dominate different facets of this problem are considered.

INTRODUCTION

The public are well informed through commercial advertising of developments which have occurred over the last decade or so to improve the crashworthy design features of automobiles. The use of terms such as crush zones, survival spaces, passenger restraint systems, air-bags and side-impact bars is commonplace, and, even if the public do not necessarily understand the details of the design of such items, they perceive that considerable attempts are being made to improve their chances of survival or escape without serious injury should they be involved in an automobile accident.

These developments are necessary because statistics clearly demonstrate that automobile travel is considerably more dangerous than competing modes of transport, see Table I (Royal Society Study Group, 1992).

TABLE 1: DEATHS PER 10⁹ KM TRAVELLED, UK

	1967-71	1972-76	1986-90
Railway passengers	0.65	0.45	1.1
Passengers on scheduled air services on UK airlines	2.3	1.4	0.23
Bus or coach drivers and passengers	1.2	1.2	0.45
Car or taxi drivers and passengers	9.0	7.5	4.4
Two-wheeled motor vehicle drivers	163.0	165.0 }	
Two-wheeled motor vehicle passengers	375.0	359.0 }	
Pedal cyclists	88.0	85.0	50.0
Pedestrians*	110.0	105.0	70.0

* Based on a National Travel Survey (1985/86) figure of 8.7 km per person per week.
Source: Department of Transport.

Although this table refers to the UK, worldwide trends are similar. The most recent figures for rail travel in the table above show an increase which reflects two major accidents in that period - a fire at Kings Cross Underground Station and a collision at Clapham railway junction. The most recent annual report on UK railway safety (HM Railway Inspectorate, 1994) which states that no passengers had been killed in a railway accident for the years 1992-93 illustrates the care which must be exercised in interpreting the influence of a small number of incidents, contrasted to the much larger numbers incorporated in road statistics. The reduction in risk for car travel over the 25 year time period of Table I reflects many factors, including the introduction of compulsory wearing of seat belts, increased awareness of drink/driving and slower traffic in town caused by congestion, as well as improvements in crashworthy design. Even though rail accidents are relatively few, they generate massive adverse publicity, which may, at least temporarily, cause potential passengers to switch from trains to a more dangerous transport mode. (It is worth noting that all accidents on public transport induce debate. A recent coach accident in the UK, in which 10 passengers were killed, generated immediate calls in the press for the compulsory fitting of seat belts to all coaches.)

INCREASES IN RAILWAY SAFETY

It is clear that the most effective contribution to railway safety is through active measures aimed at reducing still further the relatively small number of accidents. This avenue has been vigorously pursued throughout the history of railway development. The introduction, for example of improved signalling systems, continuous brakes, block-working and more reliable rolling stock and track have made significant improvements to safety: in the years 1859-60 (Anon, 1862), the rate of deaths on Britain's railways was 301/10⁹km travelled, ie. some 300 times greater than the figures shown in Table 1. At the time, these figures were used to illustrate the relative safety of rail travel, by comparing them with the 70 persons killed in horse drawn carriage accidents in London in 1859, the average deaths of 1000 per annum in

coal mines and the fact that a British sailing vessel was wrecked on every tide throughout the year. Acceptable safety standards are clearly relative to contemporary rates!

These improvements in active safety are still continuing, but accidents, by their very nature, will still occur. It is the professional duty of engineers and designers to incorporate best knowledge and practice into their products and, driven either by conscience, or legislation, or fear of litigation, pressure continues to increase to improve passive safety in order to decrease the risk to passengers should accidents occur. An additional factor is that many railway systems throughout the world are moving from national government control to some kind of private system, making cost effectiveness in all aspects more important. In the field of safety, it is necessary to judge the cost/benefit of any suggested safety improvements. If the costs are passed directly to the customers through increased ticketing prices, then the elasticity of price/demand could cause mode switch to more dangerous forms of transport, resulting in the undesirable consequence, for the transport system seen as a whole, of increasing risk.

With this background in mind, this paper seeks to review the principles behind crashworthiness developments for railway vehicles and to briefly review the significant advances made to date.

CHANGES IN MATERIALS OF CONSTRUCTION

Early railway coaches were built of wood. The first accident, involving major loss of life, occurred on the Versailles railway in the suburbs of Paris on 8 May 1842 (Smith, 1990). The wooden coaches were locked and became death traps when set on fire by burning coal from the locomotives involved. More than 55 people perished, including Admiral D'Urville, a circumnavigator who early in his career had brought the famous Venus d'Milo statue to France from the Greek Island of Milos. As with all accidents, there were lessons to be learned. Scientific investigation of metal fatigue was started by the discovery of the broken wrought iron axle which caused the accident; carriages were subsequently left unlocked. (The trains on which I travel to London have recently been fitted with door locks activated when the train is in motion, to prevent passengers falling out!) Wooden coaches still continue to be in service in many parts of the world but throughout this century increasing use has been made of steel, both structural and stainless and aluminium. The key design principle has been strength: standards exist throughout the world to define a minimum longitudinal compressive strength for rail vehicles. Indeed, the robustness of modern stock has been judged by the absence of deformation of stock after it has been involved in accidents, and a 'stronger the better' philosophy has been arrived at, in line with the long service life expected for rail vehicles; a life sometimes considerably in excess of 40 years. If, however, the strength of rail vehicles concentrates the effects of a collision at a particular location, over-riding - one vehicle mounting an adjacent one and cutting through its superstructure - can occur and, away from the main collision site, passengers in undamaged vehicles can be injured by the effects of the sudden deceleration to which they are subjected causing them to impact with the interior of the carriage. The realisation has grown that the most effective approach to minimise risk is by controlled energy absorption.

ENERGY ABSORPTION

How is energy absorbed in a collapsing vehicle? The key principle is by permanent plastic deformation of the structure. Figure 1 illustrates the derivation of a 'Damage' number (Johnson, 1972), associated with a measure of the degree of collapse of the structure. Figure 2

is a plot of compressive strength against density for engineering materials. Note that on the logarithmic scales used, for a given crumple 'strain', A , and a constant impacting velocity, $p/\dot{\sigma}$ is a constant and lines with gradient I on the plot are lines of equal performance. Thus, a steel bullet impacting at 100 ms^{-1} would be expected to undergo the same deformation (eg. $\ddot{a} = 1/20$) as a wooden projectile, or a nylon pellet. Now in practice we are interested in impacting speeds of up to, say, 30 ms^{-1} and it is evident from the plot that solid materials, with the exception of polymer foams and elastomers are not practical energy absorbers. The average densities of some typical vehicles have been added to the plot - a just floating ship being approximately 1 Mg m^{-3} , an average car in the order of 0.8 Mg m^{-3} and a passenger railway vehicle of the order of 0.2 Mg m^{-3} . Because these densities are much lower than those of most solid engineering materials, we need to investigate how the geometry of a component may move its position on Figure 2.

A simple example is the use of steel in the form of a thin walled circular tube of thickness t and diameter D . The density of the overall structure, p , that is the mass divided by the enclosed volume, is related to the density of steel P_s , from simple geometrical considerations, by:

$$p = \frac{4t}{\pi D^3} P_s$$

The tube collapses in a bellows shape by the formation of plastic hinges with the mean collapse load, P , determined by, for example, Alexander's (1960) approximate formula:

$$P = 6 \sigma t^{3/2} D^{1/2}$$

where σ is the flow stress of the material and $D/2t < 15$.

Note now that on Figure 2 a huge spread of values can be achieved for the strength/density relationship for steel tubes. In a similar manner, a point has been plotted for a dense aluminium honeycomb using manufacturer's data (3003 Al, 6.4 mm hexagonal cells, between Al sheets). These two examples are chosen to illustrate that the strength can be greatly varied with relatively little density change (the tube) or alternatively, the density can be much varied with smaller change in strength (the honeycomb). Both techniques can be used in crashworthy design.

Turning again to Figure 2, a line of equal material performance has been plotted for a speed of 16 ms^{-1} and a collapse strain of 0.09, corresponding to design parameters for trains (see later discussion). At a typical rail coach density (200 kg/m^3), the required strength is found to be -0.57 MPa . Converting this to a force (area $\sim 8.5 \text{ m}^2$), we obtain a crush load of the order of 2.4 Mn , a value which will later be shown to correspond well with both experimental and theoretical values. Clearly in a real structure, the collapse behaviour is largely determined by the geometry and joints within the structure, and not only by the material behaviour of the component parts.

ENERGY MANAGEMENT

Two distinct philosophies of energy management in train collisions have been developed by British Rail (Scholes & Lewis, 1993) and SNCF. Studies on crashworthiness at BR Research, Derby, began by a careful study of accident statistics taken over a long period, in order to discover what areas might be most safety and cost effective. It was concluded that most fatalities (64%) and serious injuries (60%) occurred as a result of end-on collisions and that

almost all fatalities (94%) occurred in end-on collisions at speeds less than 60 km/hour. Further overriding - that is one coach rising above buffer level of the adjacent coach and slicing through its superstructure - was the single most common cause of fatalities. With multiple-unit types of trains in mind, a criterion was developed in which all interfaces between coaches share a part of the energy absorbing process. The criterion reduced to providing a total of 1 MJ of energy absorption capability in a deformation length of 1 m at the leading end, and 0.5 MJ at each side of each following interface. For a multiple unit car of 24 tonnes at 60 km/hour ($= 16 \text{ ms}^{-1}$, hence the line plotted on Figure 1), this leads to an approximate deceleration of 60 m/s^2 ($\sim 6g$), thought to be a reasonable figure for passenger survival. A key feature of this strategy is that in order for each coach to, in effect, look after itself, the gap between each coach should be of such a size that the time taken in a collision for this gap to close is equal to the time taken for crushing and energy absorption to take place at the interface immediately in front. Thus a single collision is replaced by a succession of impacts, each involving the kinetic energy of a single coach rather than the total energy of the whole rake.

The approach in France has been dominated by studies involving the TGV. The essential difference is that these trains are headed by relatively massive locomotives, which are capable of being collapsed over much larger distances than 1 m. The train also has articulated bogies at all interfaces except between the locomotive and the first coach, which means the coach bodies are very close together, thus limiting both the scope for sequential collisions and the energy absorption capabilities of the buffers and drawgear. SNCF have therefore developed designs which absorb as much as 6 MJ at the front end and first interface.

EXPERIMENTAL FULL-SCALE TESTING

In practice, crushing tests performed on full-scale cab ends have initially produced load/deformation curves of similar magnitude to the order of magnitude predictions made above. Aluminium cabs have proved to be particularly difficult because the welds fail at low local strains, precipitating a collapse of the structure from a relatively high initiating load without further plastic hinge formation. This problem arises because the grades of aluminium used in rail vehicles have been chosen for properties needed to produce long extrusions, rather than for weldability. Welding in this kind of aluminium produced a local region of diminished mechanical properties adjacent to the welds, in the so-called heat affected zone. The problems of geometry and joints have therefore much exercised engineers, but successful designs in both aluminium and steel have now been produced.

It is obvious that full scale tests are expensive, so that the capabilities of theoretical predictive models are important. In many other countries, but principally in the UK, USA and France, computer models using the non-linear large deformation finite element technique have been used to predict load/collapse characteristics. Initially these models had to be 'tuned' using feedback from experiments, but knowledge, particularly of joint behaviour, has now improved to the extent that these models are now capable of making reasonable blind predictions.

Full scale collision tests have been reported from France, Portugal, Japan and most recently and extensively from the UK. In 1994 BR conducted collisions between two rakes of five coaches each, one stationary, the other impacting at a speed of approximately 60 km/hour (16 m/s). The stock used comprised Mark I coaches, modified with ends designed to absorb energy in the way outlined above. The tests successfully demonstrated that the concept of energy sharing at the successive interfaces of the rake had been achieved without derailment and the effectiveness of ribbed anti-climb devices, fitted to prevent overriding. The experiment also demonstrated the capability of several predictive modelling techniques which

have been developed, and that the integrity of the passenger survival spaces had been maintained. Further, the crushing strain, A , was of the order predicted (~1 m in a 23 m coach) and illustrated on Figure 2. The details of the considerations leading to these crashworthy designs and both the laboratory and full scale testing programme are described in papers by colleagues from British Rail.

DESIGN OF INTERIORS

Considerable progress has been made in the design of crashworthy interiors. Some features are obvious: the elimination of aggressive corners on seats, grab-handles and partitions. Seat stiffnesses and heat supports need careful design, as do tables and luggage storage spaces. Seat layout, with its many variations of unidirectional, forward or backward facing, bay-type or longitudinal, is a primary determinant of possible 'flail' distances. Much useful information has been obtained from investigations after accidents. Injuries to passengers have been correlated with their positions just before an accident and severities of injuries have been related to particular types of secondary impacts. Clearly this is a sensitive area, which requires considerable tact, but it can lead to the accumulation of much valuable knowledge and plays an important role in BR's efforts on crashworthiness. This information has been coupled with computer simulation of dummies in accidents, which as far as railways studies are concerned, is in its infancy for quantitative injury criteria predictions. This is because the models are of dummies rather than real people, and dummies have no intelligence to react in an instinctive protective manner on the onset of an impact event. In computer simulations, the dummies leave their forward facing seats or standing positions with the velocity of the train immediately prior to impact and with an acceleration determined by the severity of the collision, hence the aim of progressive energy absorption to more gently decelerate the vehicle. Progress is being made to link the deceleration time histories applied to these models derived from spring/mass model predictions and eventually from experimentally observed values in full-scale tests, to injury criteria after subsequent motion and impact on interior features. The old-adage "it is better to sit with one's back to the engine" has been graphically demonstrated by computer modelling. Too little is yet known of the mechanical response of the human body to incorporate realistic features in the dummy models, but rapid advances are being made by the automobile industry in this area. The glaring conclusion to emerge from passenger/impact interaction studies is that seat belts would prevent injury, but the number of deaths and injuries in train accidents is low and by no means all would be avoided by seat belts so it is unlikely that adverse passenger reaction to such constraints could be overcome; nor has the cost effectiveness of such constraints been demonstrated.

In the absence of new-build, attention can be given to the improvement of interior design when refurbishment opportunities arise. Further, in view of the longevity of railway rolling stock, cost-effective modifications to existing structural designs may prove worthwhile. This point was made in a very recent official report of an accident at Cowden in the UK involving 38 years old stock and in which five people died.

SIZE-SCALES OF THE CRASHWORTHINESS PROBLEM

Finally, Figure 3 attempts to summarise some of the activities relevant to crashworthy design and to emphasise the huge range of size scales encompassed by the problem. Many of these activities are intimately interrelated: for example, overall modelling of the energy sharing process may be achieved by mass/spring/damper models, but the non-linear

characteristics of the spring needs to include information about the couplers between coaches and the force/crush characteristics of the vehicle. Whilst theoretical finite element predictions can be made of the latter, they are unlikely to be successful unless both macroscopic and microscopic details are known of joint behaviour, particularly in welds. Problems arise when this detail, typically on micron scale, is incorporated FE models of the gross geometric layout of the vehicle: considerable ingenuity is needed to marry these apparently incompatible size scales.

CONCLUDING REMARKS

Crashworthy designs for rail vehicles are being developed in several countries. British Rail Research at Derby in the UK are leading the approach based on shared energy absorption along the vehicle rake and the avoidance of overriding. This approach contrasts strongly with the traditional 'as strong as possible' design for rail vehicles. The links between vehicle and passenger decelerations are being studied and related to injury criteria. Detailed design of interiors to promote passenger friendliness is being pursued.

It is important to recognise that these 'passive' approaches to safety must be advanced without cost penalties to rail vehicle builders; that 'active' approaches to safety must still be pursued to minimise rail accidents and that rail travel remains a much safer mode of transportation than most of its competitors.

REFERENCES

Alexander, J.M., 1960, "An Approximate Analysis of the Collapse of Thin Cylindrical Shells Under Axial Loading," *Quarterly Journal of Mechanics and Applied Mathematics*, Vol. 13, pp. 10-15.

Anon, 1862, "The Influence of Railway Travelling on Public Health, Report of the Commission," *The Lancet*, January 4, pp. 15-19 (see also succeeding issues).

H M Railway Inspectorate, 1994, "Railway Safety: Annual Report 1993/94", Health and Safety Executive Books.

Johnson, W., 1972, "Impact Strength of Materials," Edward Arnold, p. 303.

Royal Society Study Group, 1992, "Risk: Analysis, Perception and Management," The Royal Society, London.

Scholes, A., and Lewis, J.H., 1993, "Development of Crashworthiness for Railway Vehicle Structures," *Proceedings Instn. Mech. Engrs.*, Vol. 207, Part F, pp. 1- 16.

Smith, R.A., 1990, "The Versailles Railway Accident of 1842 and the Beginnings of the Metal Fatigue Problem," *Proceedings Fatigue '90*, H. Kitagawa and T. Tanaka, eds., Materials and Component Publishing, Birmingham, UK, Vol. 4, pp. 2033-2041.

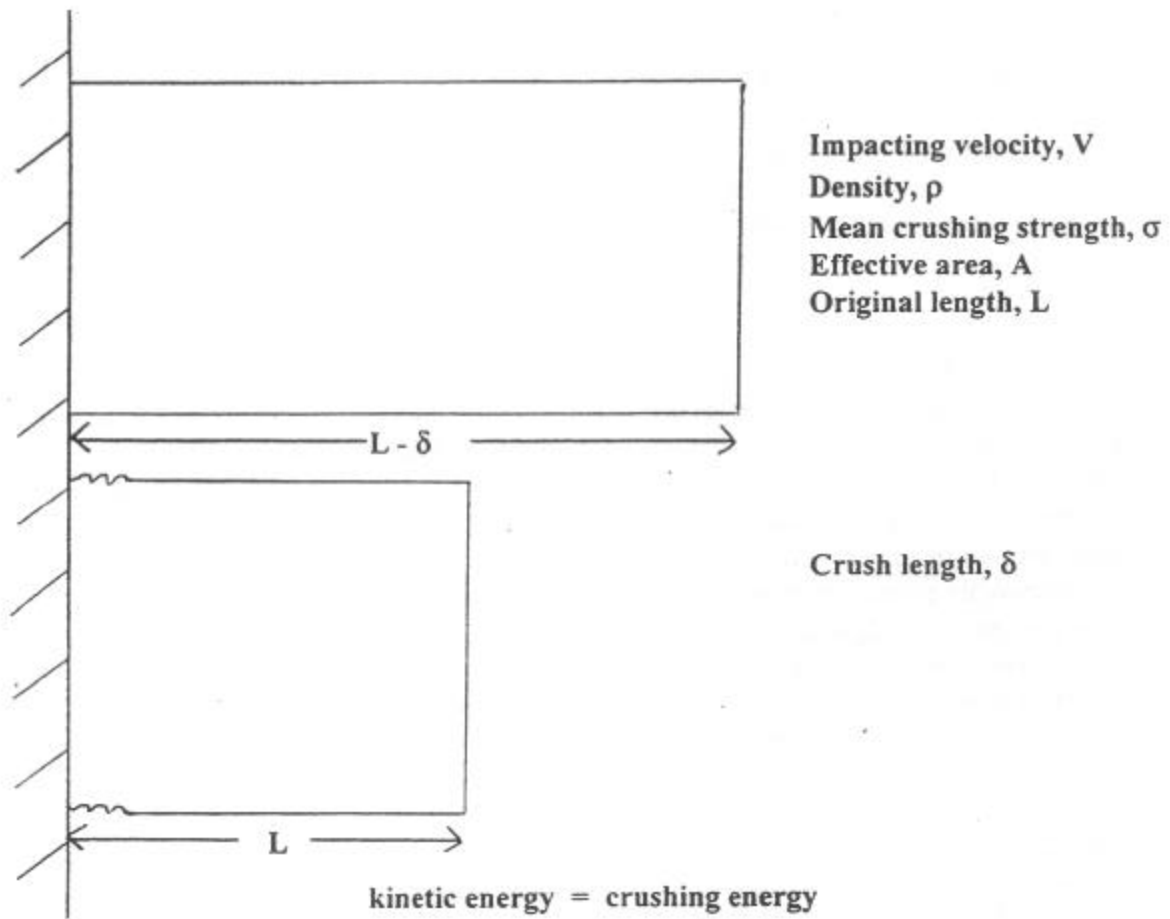

$$\frac{1}{2} (\rho AL) V^2 = (\sigma A) \delta$$

$$\rho \frac{V^2}{\sigma} = \frac{2\delta}{L} = \Delta$$

'Damage' number

Deformation or crushing strain

FIGURE 1: DEVELOPMENT OF THE CONCEPT OF A 'DAMAGE' NUMBER (JOHNSON, 1972)

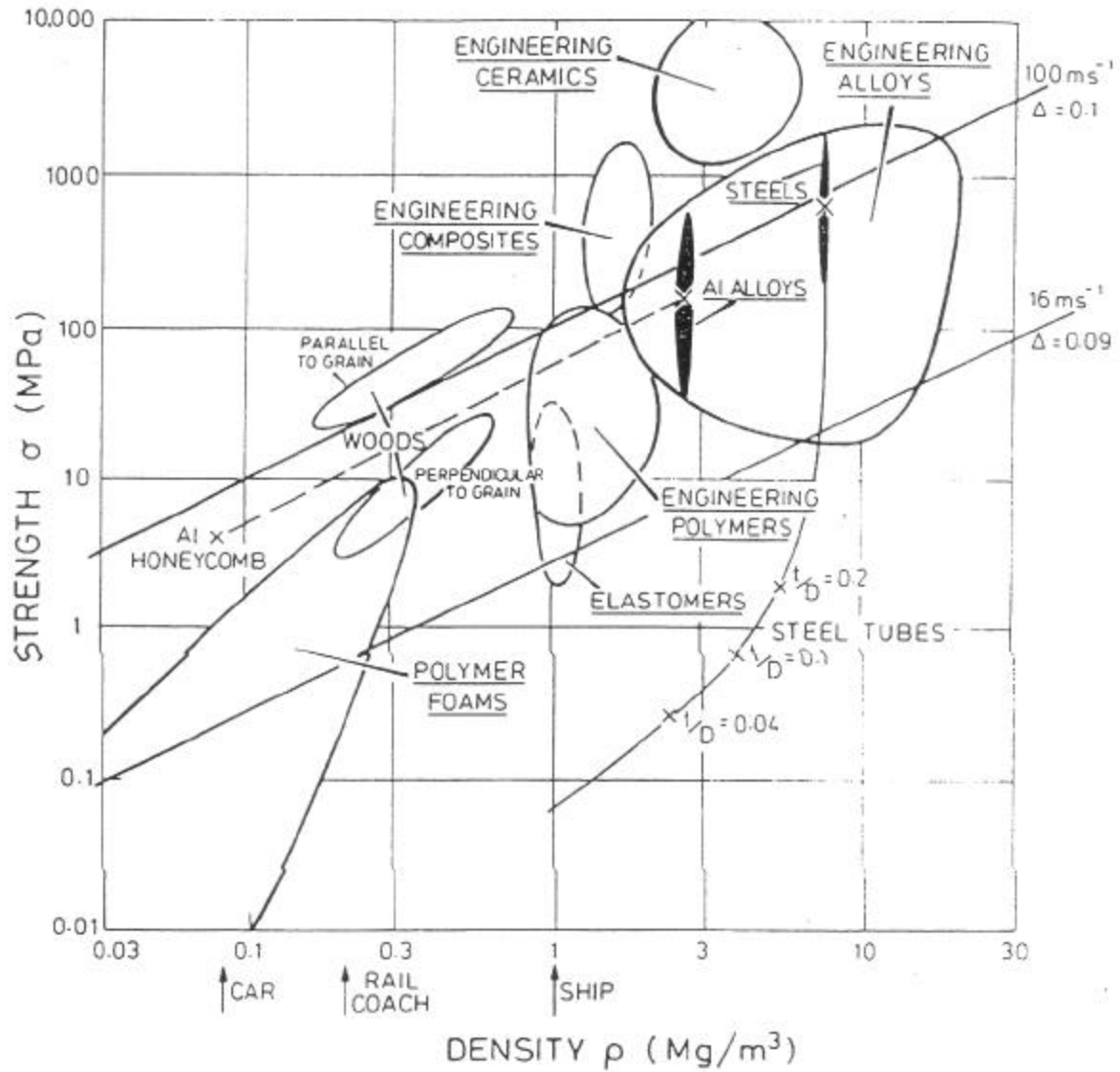

FIGURE 2: STRENGTH/DENSITY ENERGY ABSORPTION CAPABILITIES OF MATERIALS AND STRUCTURES (ADAPTED FROM MATERIALS SELECTION IN MECHANICAL DESIGN, ASHBY, M.F., PERGAMON, 1992)

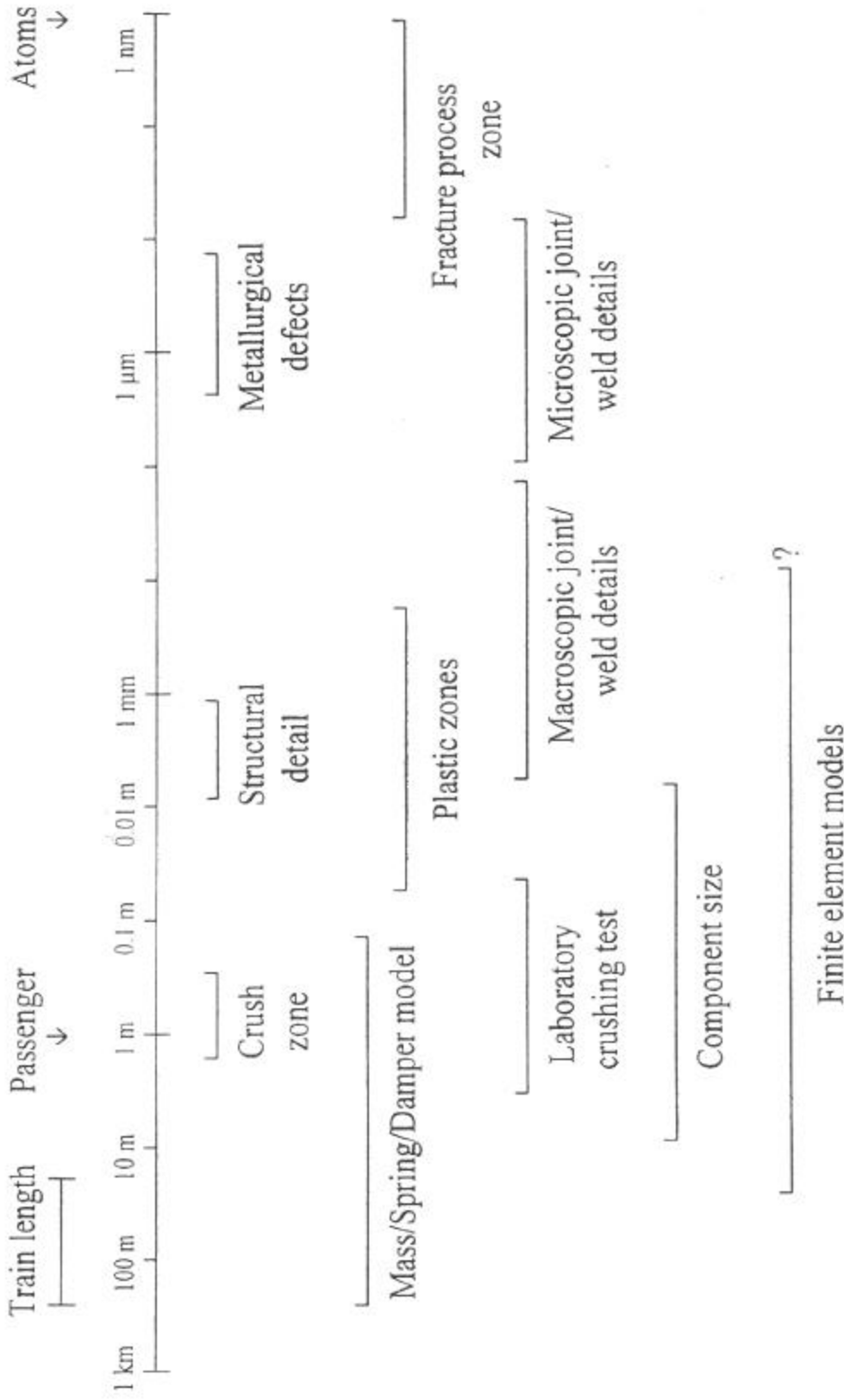

FIGURE 3: CRASHWORTHINESS SIZE SCALES

Structural Crashworthiness Overview

STEVEN DITMEYER: Our first speaker this afternoon is John Lewis, from the soon-to-be privatized British Rail Research. John has his bachelor's degree in mechanical engineering from the University of Suffolk, is a chartered engineer and he's worked for 25 years in the field of structural engineering, the last 20 of those years with British Rail Research. For the last 10 years, he has been researching rail vehicle crashworthiness and is currently team leader in charge of structural development and crashworthiness studies.

JOHN H. LEWIS: Good afternoon ladies and gentlemen. I'd really like to thank the Volpe Center for inviting me here. It's not very often I get the chance to come to America and I've really enjoyed the stay in Boston, although it's been very short.

I don't know really why I'm here because Roderick said what I'm going to say, so why repeat it? But I will do anyway. Before I do start, I'll just mention one slight coincidence. He talked about his wife in Paris. I took my wife to Paris for our 25th wedding anniversary, it was about the same time. I didn't know Rod was going to be there. And I noticed that self-same advertisement. This is where I've got to sort of take my hat off to Rod. I didn't have the courage to get off the train. I stayed with me wife and I'm glad I did because I kind of look forward to the next 25 years. [Laughter]

I think I need to just put one thing straight. Mention was made yesterday of 40 miles an hour and how we've carried out a risk assessment and come to this figure of 40 miles an hour for train crashes. We did no such risk assessment. The BR has only been looking at risk assessment over the last three to four years and once we did look at historical data to get some feel for what we should be doing in the field of crashworthiness, but we didn't carry out a proper risk assessment.

I would also say in this introductory remark that I will be repeating one or two things that have already been said. I make no apology for that really, because I think some of these issues are very, very important and warrant repetition. So the presentation will, I hope, give a general structural crashworthiness overview, particularly an overview of what's been happening at British Rail in the UK over the last few years.

Now railways throughout Europe have been striving continually for increased safety for 150 years. What we're discussing now is not new, it's been going on ever since the first accident occurred. And there have been many, many continuous improvements, some of them, sort of safety issues of real risk have been eliminated all together. For example, we don't have wooden boilers blowing up on BR any longer, they've been eliminated. And, as time moves on, what was yesterday's safety issue becomes sort of today's non-event, really. But we have been striving for continuous improvement.

And most of this improvement has been in the field of active safety. As we said yesterday, it is very important to try and stop the accident happening and that's where most of the effort should be put. However, accidents still do happen. This was a train that went into a station and didn't realize there was another train parked on the station. It was wrongly signalled into the station. This was an empty train on its way to the sidings for maintenance after it had finished its tour of duty and the side at the maintenance depot, it was at the end of a tunnel, it came out of the tunnel,

not knowing there was another train on the track and it hit it head on. And this train was severely overridden, as you can see.

This particular case was as a direct result of cost-cutting measures. We have two tracks, which were very safe, but they're expensive to maintain. So one track was ripped up and we had double way working on the track that was left. One driver passed a signal at red and drove straight into the front of another train. And this was the result. So we still do have accidents and we need to think very carefully and intelligently about what we're going to do in terms of passive safety.

Now the current European specification for the safety of vehicles was written about 30 years ago, or came into force about 30 years ago and is enshrined in a leaflet called Leaflet 566. And this requires the vehicle to be able to sustain proof loads, the loads, again, we talked about this morning. And within Europe, these loads are 1500 to 2000 kilonewtons at underframe level and the 1500 is for fixed formation sets and the 2000 for variable formation. And then lower levels of load at a superstructure from just above the underframe, going up to the roof level.

Now, as I said these are proof loads, and they are loads which the vehicles must sustain with no permanent deformation. Now, again, as Rod said this morning, at high speeds, it is impossible to sustain the concept of no permanent deformation. There comes a point when you have to consider energy absorption. And so at BR, some years ago, we were looking into an alternative philosophy for designing vehicles against collisions. Now to insure that this philosophy was founded on good data and we did sensible things, and that the things that we were doing were cost-effective, we carried out an accident review. And we looked at accidents over the last 20 years and what we found was that two-thirds of fatalities and about half the serious injuries that occurred in all accidents on BR, both to passengers and crew, occurred in end-on collisions. These were straight head-on or rear-on collisions between two trains.

What we also found out was that more than 9 in 10 of those accidents, which resulted in fatalities, occurred at less than 40 miles an hour. We have very, very few accidents above that speed. And finally it became very apparent that we must avoid overriding. If overriding does occur, this slide shows the consequences. Fatality rates can be 30 to 60 times higher in accidents at the same speed if overriding occurs. And serious injury rates can be five to eight times higher. The reason we get these variations is as someone yesterday coined the phrase, that I've not heard before but I enjoyed the phrase, it was "a chunk of history." According to which "chunk of history" you take, you can get 30 to 60 or 5 to 8. So these are the sort of studies of general accidents over 20 years.

We also studied specific accidents. We've gone out to approximately 25 major accidents in the last 15 years and studied each one in detail to see what we could learn. The first thing that we learned is that vehicles do have disproportionate end strengths. And this is crucial in what happens during an accident. And it's not surprising to have disproportionate end strengths. They're actually designed this way. If you look at the USE loadings, the underframe loading is very much higher than the superstructure loading. Now, as I said these are proof loads.

And what tends to happen with vehicular designers, is at the underframe they have lots of materials to play with and they can make things very strong and in fact they meet that proof load very, very easily. And vehicles generally collapse at loads much higher than those, typically of the order of 3000 to 4000 kilonewtons. The load just above that, 400 kilonewtons is just more

difficult to meet. And so they try and just meet this. And so what you end up with in reality is a vehicle when it collapses having an almost 10 to 1 ratio of strength between the underframe and just above it. So it's hardly surprising that overriding happens.

Another thing we found is a huge variation in forces and energy absorbed between different vehicles. We actually took three vehicles and loaded them at this point just above the underframe and measured the force displacement characteristic. And we can see from there that we get quite a variation in peak loads and quite a variation in energy absorbed. So some vehicles are going to collapse preferentially to others.

We also found that we get very unstable collapse. The vehicles meet the proof loads but because there's no specification requiring what happens when the proof loads are exceeded; vehicles collapse in a very unstable manner, they form ramps, members bend and all of these are very conducive to vehicle overriding. This is a collision that happened at—it's one of the few that was greater than 40 miles an hour—this was 55 between two trains. This shows the leading vehicle of one of the trains, both trains are moving by the way. And you can see the whole of the superstructure was completely sliced off, almost like a knife going through butter.

Fortunately, and I say fortunately because if this accident had happened 48 hours later, we would have been talking 40, 50, 60 fatalities. As it turned out, fortunately, there were only four people on board that train, including two crew. All of them were killed. That sort of accident is almost unsurvivable. And one of the main problems with it was the overriding caused by unstable collapse.

And finally, we need to consider very, very carefully structural joints. Again, as Rod said this morning, it's the details that start to go first and a small detail collapsing can lead to a major structural collapse, can lead to overriding and all that that entails. This is the bottom end of a crash pillow or collision post I think you call it over here. And it was loaded just above the underframe and there we can see the weld cracking and that collision pillow is pushed back with very, very little force. Some better design would have stopped that happening. So we need to pay attention to design.

So what the accident review indicated really was that we need to concentrate on end-on collisions. And within BR end-on collisions below 40 miles an hour was a good target, because that's where most of them occur and it's also the region that we can actually do something about. It's economically feasible to make improvements to vehicles in accidents with that sort of speed.

We do need to consider structural behavior beyond proof. The old UIC proof load requirements were no longer adequate. And we do need to control overriding. Without doubt, it is the most crucial effect that we have in end-on collisions, certainly with BR and I suspect probably within the U.S. and the rest of Europe as well.

So following this accident review, BR formulated a new structural design philosophy for vehicular loading, which took into account energy absorption. The objectives of this proposal are—they're probably pedantic. But I think they're worth stating, because we sometimes forget really what we're trying to do with crashworthiness. We can get so wound up as engineers with our modelling, with our theories, with the laws of physics, that we forget really what we're trying to do. And so I think we need to be very clear what the main objectives are. And they are to

minimize passenger and crew injury. Not only minimize the number of people injured, but those that we're killing at present, can we stop killing them, perhaps still injure them, but at least not kill them. Those who we're dealing serious injuries to, can we perhaps still injure them, but only get them to sustain minor injuries. Or better still, can we stop them being injured at all.

We need to minimize vehicle damage. It's costs are important. Operators do need to make profits. And as BR moves into the private sector, this is becoming more and more important. And we need to minimize costs. We cannot go for the theoretical idea of saving everybody if the cost is so high that nobody will be able to afford to travel on trains. What will then happen is they'll all go back into the cars and they'll be far less safe than they were if they had stayed on trains where we did nothing.

So we developed this new philosophy with these main objectives. And we did try to validate this philosophy with some simple tests. Somebody mentioned yesterday, please on track, give us two trains to crash and we'll do some tests. You don't need two trains to crash, you can get a lot of information by simple tests. This is a static test on a cabin and a lot of information can be derived from this sort of test. And it's very, very much cheaper.

We also did dynamic tests. This was a test that we did in collaboration with French, German, and Polish railways as part of a European research piece of work. And, again, it helps to reduce the costs if you can share the work with other organizations. But this was a dynamic test carried out in Poland.

Now all that I've talked about so far is history in a way. But I've included it after yesterday. It wasn't in my original presentation. Because it became clear after yesterday that much of what we've sort of gone through and the struggles we've had and the debates we've had are the sort of debates that I'm hearing again now. And I offer these, not as solutions, but really just to sort of give you some comfort that you're not alone, these debates do go on. And just because they're still going on in the U.S. doesn't mean that you're missing out on something that everybody else knows about. We've thought and argued long and hard about what we should do on BR so I think it's important to get it right. But that's our history. I offer it and I hope it's helpful, but your situation may be very different.

We got to this point in about 1991 and from there we had a three-year research funding for a series of collision tests. And these collision tests culminated in October 1994 with the actual tests themselves. And really we wanted to look at two specific areas on this three-year program.

One was the train collision behavior. We spent a lot of time and effort looking at how individual vehicles behaved but we wanted to translate that into actual train behavior. And we wanted to get to the bottom of the causes and how we were going to prevent override from happening.

So turning first to train collision behavior. We need to absorb energy and if we're going to do this, we really have two main options: We can either have a collapse zone at the end of a train or we can have a number of collapse zones at various positions down the train. It's shown here at each vehicle end down the train, but they could be anywhere. The first solution is very appropriate for fixed formation trains where there is sufficient room to have fairly long collapse zones. Again, as Rod said this morning, you do need the length of collapse to absorb energy.

This sort of solution has been adopted by TGV, by the French. And I'm sure the next presentation will sort of say what they've been doing.

But for BR, we have a particular problem with that kind of solution. In that we have long trains and short platforms. And with our commuter stock, we like to cram as many people as we can into the trains. And for most of the London termini stations, if we put a 12-car set into the platform, we can just get it in. If we create even a two-meter long collapse zone in front of the train, the back end of the train is poking off the end of the platform, or worse, it's piling a set of points. We really are that tight for space. And so for the BR, for commuter stock, a second solution is much more appropriate.

And you can't change the laws of physics, much as you'd like to. And I need to briefly sort of explain how the physics fits into train collision behavior. When two masses, two trains, two vehicles collide mass M_1 and M_2 , the energy that has to be absorbed, assuming there is no rebound, is the product of the masses, divided by the sum of the masses times the velocity squared. And for the special case, where the vehicles are the same mass, this reduces to MV squared over 4.

Now in the privatized case where each vehicle looks after itself or the Thatcher train as we call it, the two impacting vehicles have to absorb MV squared over 4. Subsequent collisions down the train, only MV squared over 8 has to be absorbed. It's purely a question of conservation of the momentum and energy. I won't attempt to prove it, but please accept it as a fact for those of you who are not sort of working on mechanics and collision area. You need to absorb twice as much energy at the impact point as you do further down the train. But what we're trying to do when each vehicle absorbs its own kinetic energy, is to distribute the energy all the way down the train, rather than have it piled up at the impact point.

Now this idealized behavior is only possible if each vehicle collision is independent of every other vehicle collision and this occurs when the gap between vehicles is set at a certain value. And the value of that gap is the product of the mass and the velocity squared divided by 8 times the collapse force and this is seen as a constant collapse force between vehicles. So in other words, if the gap is smaller than that, you will tend to try and pile more energy up at the impact point. If the gap is equal to or larger than that you can distribute the energy all the way down the train.

Now clearly this kind of ideal behavior is valid for uncoupled trains only. Only practice trains need to be coupled and resiliently coupled at that. And what happens then is the minute you apply couplers to trains you put more energy towards the front end. And you can imagine that in the extreme limit, if the couplers are completely rigid, all the energy will be absorbed at the impact point. So we're looking for some sort of compromise. And what we found was that high velocity sensitive breakaway couplers provided this compromise. So at slow speed, the couplers absorb the energy, at high speed they broke away, allowing the vehicles to effectively become separated and then we have this series of separate collisions.

Now such an arrangement provides a good approximation to the ideal. And if you look at the thin dotted line, that's what happens if you have a rigidly coupled train. All the energy's absorbed at the impact point-sorry what we're plotting here is impact energy against the interface of two five-car trains colliding at 60 kilometers an hour. So all the impact energy is piled up at the front

end if we have rigid couplers and the thick dotted line is the idealized case and we can see that as a ratio of two to one at the impact point and subsequent interfaces. And the full line is what we can achieve using velocity sensitive breakaway couplers. And this is a theoretical calculation. So that's for train collisions.

Looking briefly at overriding, we stood at a number of overriding accidents and what we found was that most of them were caused by the buffers—I understand that the American term buffers is very different from the English term—when I talk about buffers I'm talking about two pads which are on either side of the coupler and these are resiliently mounted and take most of the buffing force when two trains sort of come together. Or two vehicles are coupled together. And we can see these, these are the red pads. Most overriding accidents in the UK occur when the buffers bend in this manner, forming a ramp. And one vehicle then has the ramp to climb or slide over the other one and overriding occurs. So, from an overriding point of view, we need to provide some sort of vertical and shear restraint to stop this happening.

So these are the sorts of ideas and concepts behind the test program that we carried out. So coming to that test program, we actually carried out four tests. The first one was between two five-car trains and it was at 15 kilometers an hour. Well that was the proposed impact speed. And the concept was that this would demonstrate that the couplers at that speed could absorb all the energy and the train remain intact and serviceable.

The second test was designed to take place at 60 kilometers an hour and was designed to demonstrate our ideas about energy distribution down the train. And the final two tests were single vehicle tests. Test C was between unmodified vehicles with buffers and really was a benchmark test to demonstrate how overriding occurred. And the final one was a similar test to demonstrate that overriding could be prevented.

So looking first at the test conditions for the two trains—again I apologize for using slides from a previous lecture in England—but a rake is just a consist if people are not familiar with the term. So the conditions for the two train collisions were that one consist is stationary and the other one impacted at it at 15 or 16 kilometers an hour. There was five vehicles in each consist and each vehicle weighed 35 tons. And all the vehicles have modified crashworthy ends designed to absorb energy.

The override test conditions, again we had one vehicle stationary and the other vehicle impacting at 60 kilometers an hour, again the two vehicles, each weighed 35 tons. But the stationary vehicle was set to be 100 millimeters higher and this is the two vehicles before the test. Vehicles are naturally variable in their height, this is due to manufacturing tolerances, different heights at the sink, the springs, wheel wear, variations in track, variations in wheel wear. We allow more than 25 millimeters of wheel wear before we have to change wheels and so we can have a new vehicle with a vehicle ready to have its wheels changed. You've already got 25 millimeters of height difference. For our override tests, we set the height difference between the two vehicles artificially at 100 millimeters, which is well above what we would normally find in practice. But it's conditions which are very conducive to overriding.

All the vehicles were built from steel, using standard sections. We had no special sections made and this primarily because we needed to keep the costs to an absolute minimum and demonstrate

that we could build crashworthy vehicles from standard sections which were available off the shelf from steel stockets.

The vehicles were actually manufactured from redundant old vehicles which were sort of salvaged from the scrap yard. The old ends were cut off and the new crashworthy ends grafted on and this is a typical crashworthy end, which shows the affected part which was grafted onto the old vehicle.

I said the draw gear was a velocity sensitive hydraulic unit which fitted into the tube and the tube was attached to the vehicle by means of a series of shear bolts and the concept was that when the load reached a certain point, in fact it was at 1200 kilonewtons, the bolt sheared, the coupler broke away, and was pushed back into the underframe.

The underframe itself comprised a series of rectangular tubular sections and some very coarse steel honeycomb. Both the honeycomb and the tubes were stiffened as collapse progressed because it's very, very important to retain lateral stability as well. There's always a variation in strength between materials and between sides of vehicles due to manufacturing variations. We need to avoid is when the two vehicles come together, the sides collapsing asymmetrically and therefore leading to a sort of sideways angle which could push the vehicles off the track sideways and lead to derailment. So we have a care in this point, having an increased forced displacement characteristic. So, as soon as the two vehicles try to collapse asymmetrically, the force increased and they were brought back to symmetry again. And these sorts of small details are important because these are the sort of details, if you get them wrong the whole experiment goes wrong.

That's a better closeup of the tubes. The two tubes are at the left and right-this is a plunger, you're looking down at the floor-and the two tubes form the sole bar in the sense of longitude and you can see the honeycomb and that was stiffened by having different sections, or more sections coming in, as collapse progressed.

There were two tubes on the vehicle-the impacted end, which has to absorb twice as much energy as the trailing ends and this shows the impacted, up front of the impacting vehicles and it's a two-stage collapse. One stage before the trapezoidal plate, which you can see, and one stage after. For intermediate vehicles, only one of these stages was included. At the impact end we designed a trapezoid, one-and-a-half megajoules and at each intermediate end, three-quarters of a megajoule. And that was the train before the full impact.

One thing that's worth noting is the anticlimber part, these are the red pads on the front of the train. And the idea was that if the coupler broke away and was pushed back, these serrated pads would come into contact and provide the vehicle vertical restraint. They're not a new idea. I was at a museum some years ago and saw those on a freight wagon dated 1875 so I repeat what I said this morning- nothing's new. What is new about this is they've actually been put on a vehicle with a controlled collapse mechanism as well.

So looking at the test results, the first test—I won't dwell on this-but effectively we didn't get up to 15 kilometers an hour, we only got as far as 11. We had a very short testing program and we were concerned that we would shear all the bolts and get the couplers to break away before the high speed test and we only had two days to do both tests. And so we stopped at 11 kilometers an hour. Talking to the hydraulic capsule manufacturers, they were convinced that we

could get up to 15. But this really wasn't possible because of the crashworthiness of the program. However, what it does demonstrate is that up to 11 kilometers an hour, we can absorb all the energy within the coupler with no damage to the train. And this is at higher speed than we can with any of the present couplers on BR.

Looking at the train results, the two trains that collided at 60 kilometers an hour, we did get a series of separate collisions. And we can demonstrate this if we look at the vehicle speed against time for each of the vehicles. And this is for the impacting rake. So it impacts the stationary rake at 60 kilometers an hour and then both trains move off at 30 kilometers an hour, the law of conservation of momentum. And we can see the first vehicle, which is vehicle number 5, it comes in at 60, is emphatically decelerated down to 30, and reaches that speed before the second vehicle, vehicle number 6 starts to decelerate. And that is decelerated from 60 down to 30 before vehicle number 7 starts to decelerate. And what this demonstrates is that each collision was in fact separate.

The total collision between the two trains lasted about 0.8 seconds and there was control of energy absorption all the way down the train. In fact 12 megajoules of energy were absorbed between the two trains. And the collapse was distributed.

Ignore the red for the time being. What the green histograms show are the collapsed distance at each vehicle end against the interface. And we can see that at the impact point, approximately twice as much collapse occurred at each subsequent interface but those subsequent interfaces were reasonably constant, at least they were the first three vehicles. So the objective of distributing the energy down the train was achieved.

The peak force on the coupler was around 1500 kilonewtons. It was designed to be 1200, so it's slightly higher than designed. There was no overriding, which is very rare for a collision of that speed on BR between trains. And the peak acceleration with the vehicles down the train varied between about 7 and 10g.

If you look at the forced displacement characteristic at the impact point, we can see that a first peak, peaking at just about 1000 kilonewtons and that's to cut the shear out. Thereafter the force dropped back to zero as the vehicles close with no effective connection in compression after a coupler sheared out and then after about 0.5 meters, the two vehicle ends come together at the anticlimbers, the force rises rapidly and we get collapse at a constant force of between 2 and 3000 kilonewtons until all the energy is absorbed and then the force drops back to zero. So this is the two impacted vehicles.

And this is what actually happened to the two impacted vehicles during the test. And as I said, at 40 miles an hour the damage to those two vehicles is considerably less than anything we've ever seen in any genuine accident. And that's the whole train after the collision. I've got a video, a very short video, which will demonstrate this far better than these slides.

Turning to Test C, which was the benchmark overriding collision, we did in fact get overriding, very clear overriding, as you can see from that slide. The overriding vehicle derailed and penetrated the other vehicle by about one-and-a-half meters. Again, you can see the angled buffers, which were the main sort of instigator of the override.

Again, looking at the forced displacement characteristic, we see an initial peak that the couplers made contact and then bent out of the way. We see the secondary peak as the buffers made contact. But, thereafter as the buffers bent and overriding occurred, the force dropped dramatically and continued at a very, very low level as the underframe of the overriding vehicle sheared through the very flimsy structure of the overridden vehicle and that is a very low load. I should point out that these vehicles were not designed to the RC requirements. And the strength differential between the underframe and the superstructure was even greater than 10 to 1.

If you look at what happened with the crashworthy vehicles under the same override conditions we find that we did not get any override, as seen by that slide and, looking at the forced display characteristic, we get the very similar characteristics with what we got with the two trains in the rates test. The initial coupler shear-out you see, followed by a period of zero load and then as the anticlimbers make contact, the force rises rapidly and collapse occurs at a constant force.

If you compare the vertical forces between the two vehicles for each test, these are very, very heavily filtered results. But we can see from the unmodified vehicle we get high vertical forces greater than 500 kilonewtons, but for short duration. Once overriding's occurred, that's it, there's no vertical force measured. But for the modified crashworthy vehicles, the duration of the force is very much longer, but the magnitude is very, very much lower. As I said I've got a video which perhaps demonstrates these more graphically than I can with the slides. Can you show that please?

This is the first override test, the benchmark. And we can say that is a classic override. We've seen the results of that many, many times on BR. The same sort of thing's happening in the States. The buffers don't bend because you don't have them in the same form that we have, but the couplers bend. But the results are the same.

This is the same test between the two modified vehicles. And you'll see the collision is much less dramatic. And that's with 100 millimeters of vertical offset. And so the condition's far more severe than we would ever expect to find in practice.

And this is the train test, this is at 60 kilometers an hour. Again, not very impressive when you look at it, but bear in mind, this is the sort of speed where we're talking about massive loss of life in typical accidents. And it's difficult to imagine that anybody would have ever been crushed to death in this particular accident. We'll stop at that.

So we were quite pleased with the results of those tests. What they actually did was validate and give us confidence that what we're trying to achieve was achievable and that is important because if you're going to put these requirements into specifications, we do need to demonstrate that they're practicable and can be achieved at reasonable costs.

In fact, just very briefly, I'll mention a little bit about some of the theoretical techniques that we've used, much of it was mentioned this morning. But I think perhaps it's worth reiterating the areas that we've used them in. We've used them to determine optimum vehicle parameters. If we have different types of forced collapse characteristic how will this affect what happens in train behavior. And the first two are really part and parcel of the same thing. We do use very simple nonlinear models to analyze train behavior. It's very important that we know what's likely to happen under different scenarios.

We've studied energy absorbing components. I'll come back to that in a minute. And we studied complete structures. Theoretical techniques are very, very useful for one main reason: they are very much cheaper to test. And they allow you to look at a number of different options without the expense of testing. Looking at train behavior, the red histogram is our prediction of that train test that we've just seen on the video. What we can see there is that we actually predicted far more deformation than we actually got and the reason for that was in our original predictions we didn't include strain rate effects. And these are far more pronounced at the sort of between the first two impacted vehicles than elsewhere. So we did overestimate the amount of deformation at the impact point.

The agreement is fairly reasonable and they do show that these models can be used quite accurately to predict what's going to happen to trains. We use them to predict detailed behavior of crashing components. Rod actually showed this slide this morning and that's this tube under test. And this is what happens if you look at the FA analysis. Those FA analysts would immediately spot that as being an absolute load of rubbish, which it is.

This is the one that didn't predict that we wanted to. And I put this slide in deliberately because we do need to validate any FA analysis that we do. Tubes do not collapse in that manner. What we've done was set up the model wrongly and we didn't put the right triggers in to get the collapse mode going in the correct way. As I say, I put this up as a sort of salutary lesson in that if you're going to use FA analysis, you must validate it before we use it in earnest and spend money on structures based on FA analysis.

We looked at complete cab structures. This was the actual cab that was used in the test and I think there's about 30,000 elements in that. This is the static force displacement characteristic of that particular cab and please take my word for it, but we actually did the analysis before the test. I've been to many presentations and actually given them myself, where we've presented wonderful results and these are always done, the analysis is done after the test. It's very, very easy to analyze tests. It's much more difficult to predict them.

But I think the reason that we got good results there was that we validated the various components. The tubes, which we initially got wrong, we went back and changed the model until we got good validation with tests. And then when we put these validated components into the full model we got a good model, which agrees very well with tests.

And finally, this is the modelling of the override test and again, please take my word for it, this analysis was done before the test. Agreement's not perfect but it gives a very good representation of what we would expect to happen.

So, in conclusion, accident analysis has shown as where on BR we should be putting most of our efforts to improve passenger and crew safety. And on BR that is on end-on collisions and we can do a lot on end-on collisions below 40 miles an hour. And that's really where we should be aiming most of our efforts on BR. Theoretical analysis, validation testing, testing in small details, going around, testing the bigger details is very, very important if you're going to get any sort of confidence and belief in the sort of structures that we're advocating.

In particular, we showed with this series of tests that energy distribution along the train can be achieved if we use breakaway couplers, which are velocity sensitive, and if we have controlled

vehicle in collapse. And we can prevent overriding by use of very simple anticlimb devices, avoiding high longitudinal forces, by having these collapse zones and avoiding the high vertical forces that lead to override.

I would suggest that what we've done is nothing extraordinary. It's just basic engineering applied to a particular problem. In terms of vehicles, it should actually add very little extra costs to a vehicle, because we're using standard materials, standard manufacturing techniques, it's just good design. And we would expect to significantly reduce casualties.

Finally I will just repeat a slide which you saw this morning. And incidentally, it happened just outside London on December 13, 1988. Thirty-five people were killed and over 400 injured when these two trains- ignore the train on the left, that arrived afterwards and really played no part in the accident. But the two trains on the right collided at 35 miles an hour. I believe that with the work that we've done in the last few years, if that accident occurred with a vehicle designed to be crashworthy, that accident could have resulted in certainly less than 35 fatalities and hopefully down to zero.

Thank you very much indeed.

[Applause]

JOHN LEWIS: Yes, I'm happy to answer any questions.

BOB GILGANCY: I'm Bob Gilgancy from CALSPAN SRL Corporation. On those full scale crash tests, is the acceleration time data you recorded, is that available, is it published somewhere, so we can look at it? There are so few crash pulses around you know. They just want to get their hands on it.

JOHN LEWIS: The crash pulse is very, very important, in fact we've used the crash pulse on those tests to develop crash pulses for vehicle interior specifications. Yes, it's around.

BOB GILGANCY: Is it published in available literature or do we have to go directly to you to get it?

JOHN LEWIS: I'm not prevaricating. I'm trying to remember. I think it is, yes, in one of the papers we've published the acceleration time crashes has been published. So it is available, yes. But I can send you a copy if you see me afterwards.

BOB GILGANCY: Thank you.

RON MAYVILLE: Ron Mayville, Arthur D. Little. I noticed in the photograph, one of the photographs of the damaged vehicles for the trains that were designed to absorb energy throughout the rake as you call it, that one of the lead ends didn't deform as much as the other end. Did your model predict that?

JOHN LEWIS: No, because in our model we had both vehicles of similar strength. I mean that sort of behavior is almost inevitable because two vehicles are never the same. After the test, we did go back and have a look at what happened if one vehicle is 10 percent stronger than the other.

Because for this very point, we want to distribute the energy and not pile it all into one train. And if you have this 10 percent difference we get about a 30 percent difference in deformation between the two trains for that particular characteristic of forced displacement.

AUDIENCE ATTENDEE: First, that's an excellent study. I think that's a real state-of-the-art type of project there. I have a question, you mentioned you have to be very conscious of the design of joints and structures for stability failures and so forth. And you mentioned the strain rate effects, some effect on deformation expected, analyzed in what you saw in the test. Strain rate effects also can have an effect on the strength of joints and stability structures at times. Did you see any of that, any differences between what you expected based on static tests, as far as failure modes in the structures compared to what you saw during the full-scale test?

JOHN LEWIS: The full-scale dynamic tests produced a collapse in the vehicle structure exactly the same as we found on the static tests. But the forces were higher. It's almost as if we'd just translated the force displacement characteristic up, upwards of the force axis by between 15 and 20 percent.

AUDIENCE ATTENDEE: The failure modes were consistent down the structure also?

JOHN LEWIS: Sorry?

AUDIENCE ATTENDEE: The failure modes of the individual elements, that was consistent also?

JOHN LEWIS: Yes.

STEVEN DITMEYER: Thank you very much, John.

PRESENTATION

STRUCTURAL CRASHWORTHINESS OVERVIEW

STRUCTURAL CRASHWORTHINESS OVERVIEW

by

J. H. Lewis

Paper to be presented at Symposium of Rail Vehicle Crashworthiness, Volpe National Transportation Systems Centre, Cambridge, Massachusetts, June 24-26, 1996.

BR Research
PO Box 2
London Road
DERBY DE24 8YB
ENGLAND

1. INTRODUCTION

Railways throughout Europe are constantly striving towards increased safety. Throughout their history, there has been a continuous improvement in the area of active safety, that is the improvement of signalling, track layout, operating systems etc with a view to preventing accidents occurring. Despite these improvements, accidents do still occur and passive safety, that is the enhanced performance of vehicles in accidents, has also been receiving attention. Extensive programmes of work have been carried out by SNCF in France (Cleon and Lagneau), British Rail Research in the UK (Scholes and Lewis) and by the European Rail Research Institute. The principal objective in each case has been to minimise passenger and crew injury and, where possible, to minimise vehicle repair costs.

Within the UK, a new design philosophy was proposed which took structural design beyond the proof stage to include progressive collapse and energy absorption. This philosophy was initially validated by means of static and dynamic crush tests and resulted in British Rail issuing a mandatory specification for structural design which, for the first time, specified vehicle performance beyond proof loading.

Despite the extensive development programmes preceding the new specification, further work was required to study the behaviour of complete trains in collisions; all tests to that point had been carried out with single vehicles. Additionally, the causes and prevention of vehicle overriding, known to result in a high casualty rate, required further study. Accordingly, a three year programme of work was initiated by British Rail; the issues of train collision behaviour and overriding formed the principal elements of the programme. The work culminated in October 1994 with a series of instrumented collision tests. This paper summarises the background to and the work undertaken during the development and test programme.

2. BACKGROUND

2.1. Current Requirements

All passenger vehicles built for running on British Rail have to satisfy the structural loadings specified in UIC leaflet 566 OR. This is derived from a specification introduced over 30 years ago to ensure compatibility of longitudinal loading requirements for vehicles running on European Railways. The leaflet specifies a longitudinal load of 2000 kN applied at buffers or couplers (1500 kN for multiple units) and lesser loads applied at various points on the vehicle superstructure as shown in figure 1. The loading requirements are proof loads ie. applied loads which should result in no yielding of the vehicle structure and hence no permanent deformation. Similar requirements apply for the design of locomotives.

In designing for dynamic resistance in collisions at higher speeds, the concept of no permanent resistance cannot be sustained and, to provide passenger and crew protection in such collisions, a new concept based on controlled energy absorption needs to be developed. To ensure that any new philosophy is grounded on well-founded data, a review of train accidents on British Rail was undertaken.

2.2. Review of Accident Data

A summary of train accidents on British Rail over the 20 year period 1973 to 1992 is given in table 1 and provides the following conclusions:

- (a) The largest proportions of fatalities (66%) and serious injuries (50%) occur in end-on collisions. The largest proportion of the remaining fatalities and serious injuries occur in derailments; more detailed analysis indicates that these injuries almost all occur in high speed derailments with typical kinetic energies of 200 MJ or more.
- (b) Almost all fatalities in end-on collisions (>90%) occurred at speeds less than 18 m/s (40 mph). This is primarily because there is usually warning of an impending collision enabling a brake application to be made and therefore reduce the trains' speed. Also, many collisions occur in close proximity to busy stations where line speeds are lower.
- (c) Further analysis of the end-on collisions demonstrates the need to avoid vehicle overriding (table 2). It is clear that in such accidents the fatality rate is 60 times greater and the serious injury rate 8 times higher if overriding occurs.

The above conclusions are generally reflected by other railway administrations (Cleon & Lagneau, 1993) and indicate that the most effective means of reducing passenger and crew injuries is to concentrate on protection against end-on collisions and to avoid overriding. The programme of work carried out by British Rail, therefore, concentrated in these areas.

2.3. Review of Vehicle Behaviour in Accidents

To complement the review of accident data, all serious collisions on British Rail since 1988 have been examined at the site of the accident. In addition, crush tests on several vehicle body ends taken from vehicles of past and current designs have been undertaken. The principal conclusions from this work are:

- (a) Current vehicles have disproportionate vehicle end strengths at underframe and lower superstructure level. The ratio of the collapse loads at the two levels is, in some cases, as high as 10:1 thereby exacerbating the likelihood of override.
- (b) Vehicles loaded beyond their proof loads show a considerable variation between the peak force sustained, energy absorbed and energy absorption effectiveness, ie. the energy absorbed divided by the product of the peak force and collapse distance.
- (c) Underframes designed with stiff longitudinal members to meet the proof load requirements can, under collision conditions, collapse in an unstable manner. High longitudinal forces generate vertical components resulting in relative vertical movements and vehicle overriding.
- (d) The design of joints between structural members is of particular importance; they should be designed to fail plastically without failure.

This further review confirmed the need to consider structural behaviour beyond the proof load requirement and highlighted some of the dangers of uncontrolled, unpredictable collapse behaviour.

3. OBJECTIVES AND CONCEPTS

3.1. Objectives

To minimise injuries to passengers and crew, the collision energy needs to be absorbed in a controlled manner at defined collapse zones. If the train consist is fixed, the energy to be absorbed at a given speed is also fixed. In this case, the collapse zones may be located in the end vehicle or vehicles and provide all the energy absorption deemed necessary at the defined design speed. Where no passengers are located in these areas (eg in fixed formation high speed trains), this is a feasible and practical way of implementing structural crashworthiness. This principle has been adopted for the TGV double deck trains.

Where trains are of variable length (and hence the energy to be absorbed at a given speed depends on the number of vehicles in the train) or, where, for operational reasons, it is required to locate passengers in the end vehicles of trains, a more appropriate solution is to locate limited collapse zones at the end of each vehicle thus distributing collapse along the length of the train. A variable amount of energy absorbing capability can thus be supplied. This is the case that is more appropriate to BR vehicles, particularly high density commuter stock.

It is clear from analysis of the accident data that, no matter which energy absorption principle is adopted, overriding must be prevented. The collision tests, therefore, had two main objectives:

- (a) To demonstrate the practicality of the proposal that, in collisions between trains, each vehicle can be designed to absorb its own collision energy, thereby distributing collapse along the train and reducing the risk of injury from loss of survival space for passengers and crew.
- (b) To prove the effectiveness of various measures in preventing over-riding.

3.2. Behaviour of Vehicles in Trains

If a single vehicle mass m_1 collides with a single vehicle of mass m_2 at a closing velocity of v , the collision energy absorbed E is given by

$$E = \frac{m_1 m_2 v^2}{2 (m_1 + m_2)}$$

If the masses are equal, mass m , $E = mv^2/4$.

In case of colliding trains, it can be demonstrated theoretically that, if the interface between two vehicles can be design to absorb the collision energy associated with the impact of those two vehicles, the collision energy can be absorbed along the train rather than at the impact interface. In the special case where each vehicle in the rake has the same mass, it can further be shown that the collision energy at the impact interface is the same as for single vehicles i.e. $mv^2/4$ and at subsequent interfaces reduces to $mv^2/8$.

The idealised behaviour can only be attained if each vehicle collision with the train is independent of other collisions, ie the energy absorption at each interface is complete before the subsequent vehicle impacts. The parameters which control this behaviour are the vehicle masses, the impact velocity, the gap between the vehicles which must be closed up before any substantial inter-vehicle force is established and the collapse characteristic of the colliding vehicles. Assuming vehicle collapse occurs at a constant load (F), the minimum gap between vehicles (G) is given by

$$G = \frac{m^2}{8F}$$

The above theory for the ideal distribution of energy is valid only for idealised rakes of vehicles which are uncoupled. In practice, vehicles are resiliently coupled and the collision dynamics result in more than the ideal proportion of the collision energy being absorbed at the impact point. A compromise is found using a velocity-sensitive coupler which breaks away on overload. In slow speed collisions (up to say, 15 km/hr), the coupler is designed to absorb all the collision energy; at higher impact speeds, the load rises rapidly causing the coupler to break away, the vehicles then becoming uncoupled. Whilst such an arrangement cannot fully meet the ideal, it provides a good approximation. A comparison between the idealised behaviour and that using velocity-sensitive couplers is shown in figure 2 for two colliding 5 car trains; also included is the assessed behaviour of trains with traditional fixed couplers with rubber springs.

3.3. Mechanics of Overriding

An investigation into 34 overriding accidents over the accident review period indicated the importance of couplers and buffers which, deforming under the influence of high longitudinal forces, formed the necessary inclined contact surfaces which are a precursor to overriding. This type of behaviour has been confirmed by tests carried out in the US using freight vehicles (Tong, 1983). Any vertical misalignment between colliding vehicles exacerbates this structural deformation and hence propensity to override.

Possible means of reducing the likelihood of overriding include devices to provide vertical shear resistance between colliding vehicles, the provision of break-away couplers to allow engagement of these devices and the provision of collapsible structure which reduces the compressive collision force between vehicles and hence prevents the generation of the high vertical forces and bending moments necessary to initiate overriding.

4. TEST PROGRAMME

Four tests were proposed to validate the train behaviour and avoidance of vehicle overriding:

- (a) Collision of 15 km/hr between two five-vehicle trains to determine the behaviour of the hydraulic couplers and to ensure satisfactory measuring and recording of all signals.
- (b) Collision at 60 km/hr between two trains to validate the expected energy absorption behaviour.
- (c) A benchmark overriding collision at 60 km/hr between two single unmodified coaches fitted with standard buffers and couplers. One vehicle was raised on its secondary suspension 100 mm relative to the other to promote overriding. This height difference was well beyond any likely difference found in service, and overriding was expected.
- (d) Collision at 60 km/hr between two single vehicles modified with ribbed anticlimber pads, break-away couplers and energy absorbing end structures to demonstrate the efficacy of these measures in preventing override. Again one vehicle was raised by 100 mm to encourage overriding.

4.1. Vehicle Design Specification

A pre-requisite to the demonstration tests was the specification, design and manufacture of suitable test vehicles. The following collapse requirements were specified:

- (a) Heavy shunt (up to 15 km/hr) - the collision energy to be absorbed in the hydraulic drawgear. Above 15 km/hr, the drawgear to break away at a force of 1200 kN allowing ribbed anti-climbers on adjacent vehicles to come into contact.
- (b) Accident (up to 60 km/hr) - the collision energy to be absorbed by structural collapse, the collapse force rising progressively from 2000 kN to 2500 kN with an allowable peak force of 3000 kN. The impacting cab ends to absorb a minimum of 1.5 MJ over a maximum collapse distance of 1 m and all intermediate ends to absorb 0.75 MJ over a collapse distance of 0.5 m.

Additional requirements comprised:

- (a) The vehicle ends to be built from steel using standard sections wherever possible; manufacturing costs to be no more than conventional vehicles.
- (b) The vehicle ends to feature a corridor connection and appropriate windows and doors. Non-structural items such as windows and doors not to be included.

4.2. Test Vehicle Design

The modified test vehicles used redundant BR coaches with their ends removed and collapsible ends to the new requirements grafted on. A typical leading end is shown in figure 3. The drawgear comprised hydraulic capsules attached to the drawbar and coupler and mounted in a housing attached to the vehicle underframe by means of shear bolts designed to fail at 1200 kN and allow the impacting vehicles to come together making further contact at the anti-climbers. The drawgear attachment is shown in figure 4; space was provided behind the attachment to allow

the drawgear to be pushed back during collapse.

The anti-climbers comprised a pair of ribbed blocks welded to the headstock at the buffer position as seen in figure 3.

The vehicle underframe included a series of rectangular steel tubes forming the solebars and centre longitudes. The tubes were designed to collapse in a series of asymmetric buckles typical of rectangular tubes and were triggered to initiate the desired collapse mode and to reduce the initial peak load normally associated with crushing tubes. The tubes were also progressively stiffened to provide an increasing collapse force. Between the sole bars and centre longitudes, large cell steel honeycomb sections were located to supplement the energy absorbed by the tubes. As collapse progressed, more honeycomb sections were introduced, again to progressively increase the collapse force. A section showing the tubes and steel honeycomb is shown in figure 5. The tubes and honeycomb provided the principal means of energy absorption as the vehicle collapsed and considerable development work including finite element calculation and component testing was undertaken to optimise the individual components. The superstructure comprised rectangular hollow section pillars and cantrails with light gauge stiffeners providing support for the panels. Notches were cut into the longitudinal members to encourage failure by bending, thereby absorbing further energy.

Two designs of vehicle end were required, one for intermediate vehicles (0.75 MJ energy absorption) and one for end or impacting vehicles (1.5 MJ energy absorption). Each was essentially the same with the end vehicles incorporating two energy absorption sections and the intermediate vehicles a single section.

Transition structure comprising fabricated sections was provided where the vehicle end was attached to the old coach structure to ensure an adequate load path; where required, additional bracing was provided. Finally, each vehicle was ballasted to 35 tonnes by welding steel plates to the floor structure.

4.3. Test Details

All the tests were carried out on straight track with the moving vehicle or train being propelled into the stationary vehicle or train. In each case the moving stock was accelerated to a pre-determined speed at a specific release point when a slip coupling was activated allowing the test vehicle(s) to run freely to the impact point. The release location was sufficient distance from the impact point to ensure that the propelling locomotive could stop even if the release were aborted at the last minute. Track mounted devices ensured the brakes on both moving and stationary stock were applied immediately after impact.

Impact speed was measured by track switches located a fixed distance apart 1m before the impact point and vehicle speed before and after the impact was measured by vehicle mounted Doppler radar devices and photocells viewing stripes attached to the side of the vehicles.

During the single vehicle tests, almost 50 channels of data, principally strain gauges and accelerometers, were measured and recorded (almost 100 channels for the train tests). All data were stored as analogue signals and subsequently digitised at a scan rate of 10000 scans/second

for analysis. Final results were filtered as required.

All tests were filmed using high speed cine cameras running at 400 frames per second. For each single vehicle test three side and one overhead camera were used at the impact part. Additional cameras at each vehicle interface were used for the train tests.

5. TEST RESULTS

5.1. Train Tests

To ensure the coupler shear out attachments were not activated, a series of slow speed collisions at increasing impact speeds up to 15 km/hr were envisaged. At 11 km/hr, the force in the leading coupler was almost 1000 kN and was considered sufficiently close to the shear out value of 1200 kN to preclude any further increase in impact velocity. Shear out would probably have occurred at a little over 12 km/hr.

The achieved speed is still above that which would result in permanent vehicle damage with current couplers and the hydraulic system metering pins can be further adjusted to provide a non-damaging 15 km/hr collision.

The 60 km/hr impact comprised a series of separate collisions. Such separation can be seen in figure 6 and was crucial to the principle of distribution of collapse over the whole length of each train instead of collapse being concentrated at the impact point. It shows the speed changes in the five vehicles of the moving train against time during the whole collision which lasted approximately 0.8 sec. The speed changes of the vehicles in the stationary train are a mirror image, each vehicle being successively accelerated from rest to 30km/hr.

The result was a controlled absorption of collision energy with structural collapse limited to the vehicles ends only (the rest of the vehicle being undamaged) and distributed along the whole length of each rake. The total energy absorbed was approximately 12 MJ.

The largest deformation occurred at the impacting interface, a total of 1040mm shared between the cab ends; the least deformation, amounting to approximately 150 mm, occurred at the last interface on each train. The variation in the amount of crush at each interface is shown in figure 7, where a comparison with theoretical predictions is also made. The actual amounts of crush at each interface are generally less than predicted primarily because the energy dissipated by structural damping, frictional effects etc. was not accurately modelled.

The couplers at each interface sheared from their mounting bolts at forces between 1100 and 1500 kN. The combination of anti-climbers and crashworthy vehicle ends prevented any overriding and there was no derailment. Collapse modes of the cab and intermediate vehicles ends were very much as designed; force levels at each interface remaining at a fairly constant level of between 2000-3000 kN. The force-displacement characteristic for the cab end of the moving train is shown in figure 8. Peak acceleration levels on the ten vehicles varied between 7g and 10g. The moving train after the test is shown in figure 9.

5.2. Override Tests

In the first test using unmodified vehicles, initial contact between the vehicles was at the couplers followed immediately by buffer contact. As high compressive forces, in excess of 4000 kN were developed, the 100 mm relative height difference between the vehicles induced bending of the buffer shanks and coupler drawbars with a resultant inclined contact. Override initiated once the inclination of the buffer heads was sufficient for slip to occur, allowing the stationary vehicle to ride up the ramp formed by the buffers.

High vertical forces were generated during this process sufficient to lift the stationary vehicle into the air by 1m and to bend down permanently the underframe of the moving vehicle, thereby separating it from the vehicle superstructure.

The override progressed to approximately 1.5m of penetration, shearing the body of the moving vehicle from the underframe, before the stationary vehicle fell back onto the track. The bogie of the stationary vehicle nearest impact was severely damaged and derailed all wheels. The vehicles during the impact are shown in figure 10.

In the second test, between the modified vehicles, initial contact was again at the couplers. These sheared at both vehicles at a compressive force of approximately 1100 kN and were pushed back into the vehicle underframe allowing the anti-climbers to engage. The initial collapse force of the vehicle ends was 2500 kN and subsequently varied between approximately 2000 kN and 3000 kN (corresponding to acceleration/decelerations of 5.7 to 8.6g). The total collapse was asymmetrical with the lower of the vehicles suffering the largest proportion of the damage. The two vehicles ends after impact are shown in figure 11.

The combination of anti-climbers and collapsible vehicle ends ensured a controlled energy absorption with no overriding or derailment.

6. THEORETICAL TECHNIQUES

In order to specify with confidence a vehicle performance or train performance or to design a vehicle structure which collapses in a predictable way and absorbs a specified level of energy, theoretical analysis is essential. The analysis may comprise a simple lumped mass model with non-linear connecting springs to describe the vehicle coupler and/or end structure collapse characteristic; such models are successfully used to predict the behaviour of colliding trains (figure 7). To describe the detailed collapse performance of individual vehicles, a more detailed model comprising several thousand non-linear elements describing the structure member plasticity is required. BR Research uses the proprietary program OASYS DYNA3D in crashworthiness applications. The program has been used extensively to:

- (a) determine optimum vehicle parameters such as coupler performance, collapse force-displacement characteristics, gap between vehicles etc to enable colliding train behaviour to be predicted.
- (b) analyse train behaviour in specific accidents.

- (c) study of behaviour of collapsible energy absorbing elements such as honeycombs and tubes.
- (d) predict the collapse mode and force displacement characteristics of complete structures.

In the programme of work described in this paper, DYNA3D was effectively used to predict the global behaviour of the colliding trains (figure 7). The measured amounts of crush at each interface are generally less than predicted, primarily because energy dissipated by structural damping, frictional effects etc was not included in the model. It was also used to predict the collapse mode of the vehicle end structure in the train collision and override collision (figure 11) where fairly good correlation was obtained.

As part of the crashworthy structure design, DYNA3D was used to confirm the required force-displacement characteristic to ensure adequate energy absorption and force levels. The principal energy absorbing members were critically analysed and validated by test before incorporating them into a full model of the vehicle end structure. The predicted performance of the complete structure was confirmed by means of a quasi-static crush test which provided excellent correlation with predictions (figure 12).

Theoretical analysis is considerably less expensive than testing and the work undertaken has proved its usefulness in allowing vehicle collapse behaviour to be predicted with confidence.

7. CONCLUSIONS

A series of tests have been carried out to demonstrate the effectiveness of measures to improve the safety of rail vehicles in end-on collisions. In particular, the tests addressed the problems which cause most of the fatalities in end-on collisions, namely extensive vehicle collapse at the impact point and vehicle overriding.

Break-away, velocity sensitive couplers and careful design of the vehicle ends to provide a controlled collapse during collision may be used to distribute the collision energy among a series of unoccupied sacrificial collapse zones along the length of the train. By this means, the extensive collapse of the vehicle structure at the impact point and corresponding fatalities due to crushing should be avoided. Similarly, a simple ribbed anti-climber attached to a collapsible vehicle end structure may be used to prevent vehicle override, again with a large potential reduction in fatalities.

The above measures should result in very little extra vehicle cost and should significantly improve vehicle safety.

8. ACKNOWLEDGEMENTS

The author is grateful to the British Railways Board for supporting the work described and to the Managing Director of BR Research for permission to publish this paper. Thanks also go to his colleagues for their invaluable help in the work.

9. REFERENCES

1. Cleon LM & Lagneau M, 1993, "Physique du Choc et Accidentologie", Revue des Chemins de Fer.
2. Cleon LM, 1994, "Tolerances a la Collision des Materiels Ferroviaries: Optimisation de la Securite Passive de Structures de Vehicule", World Congress on Railway Research 1994.
3. Scholes A & Lewis JH, 1993, "Development of Crashworthiness for Railway Vehicle Structures", Proceedings, Institution of Mechanical Engineers Vol 207.
4. Lewis JH, 1994, "Development of Crashworthy Vehicle Structures for Railways", World Congress on Railway Research 1994.
5. ERRI (ORE) Question B165, 1991, "Dynamic Resistance of Drivers' Cabs to Frontal Impacts", Report RP 10.
6. Tong P, 1983, "Rail Vehicle Structural Crashworthiness", Structural Crashworthiness edited by N Jones & T Wierzbicki, Butterworth and Co (Publishers) Ltd, 1983.

TABLE 1 SUMMARY OF STRUCTURALLY SIGNIFICANT ACCIDENTS 1973-1992

Accident Type	Number of Accidents	NUMBER OF CASUALTIES		
		Fatal	Serious	Minor
End-on collision	651	104	290	2917
Side-on collision	80	6	50	233
Buffer stop collision	705	2	115	1952
Level crossing collision	1230	3	6	200
Passenger train derailment	409	42	115	713
TOTAL	3075	157	576	6015

TABLE 2 EFFECT OF OVERRIDING IN END-ON COLLISIONS AT IMPACTS SPEEDS ABOVE 10 MPH

	With Overriding	Without Overriding
Number of Accidents	43	608
Fatalities	83	21
Serious Injuries	110	180
Minor Injuries	1001	1916
Fatality Rate	1.93	0.03
Serious Injury Rate	2.56	0.30
Minor Injury Rate	23.3	3.15

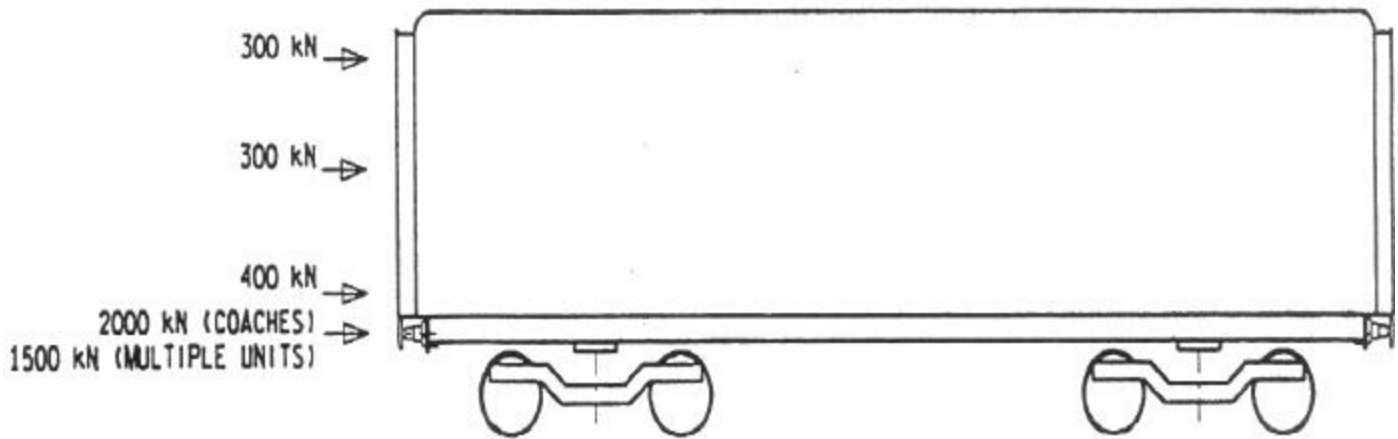

FIGURE 1 - CURRENT UIC PASSENGER VEHICLE PROOF LOAD REQUIREMENTS

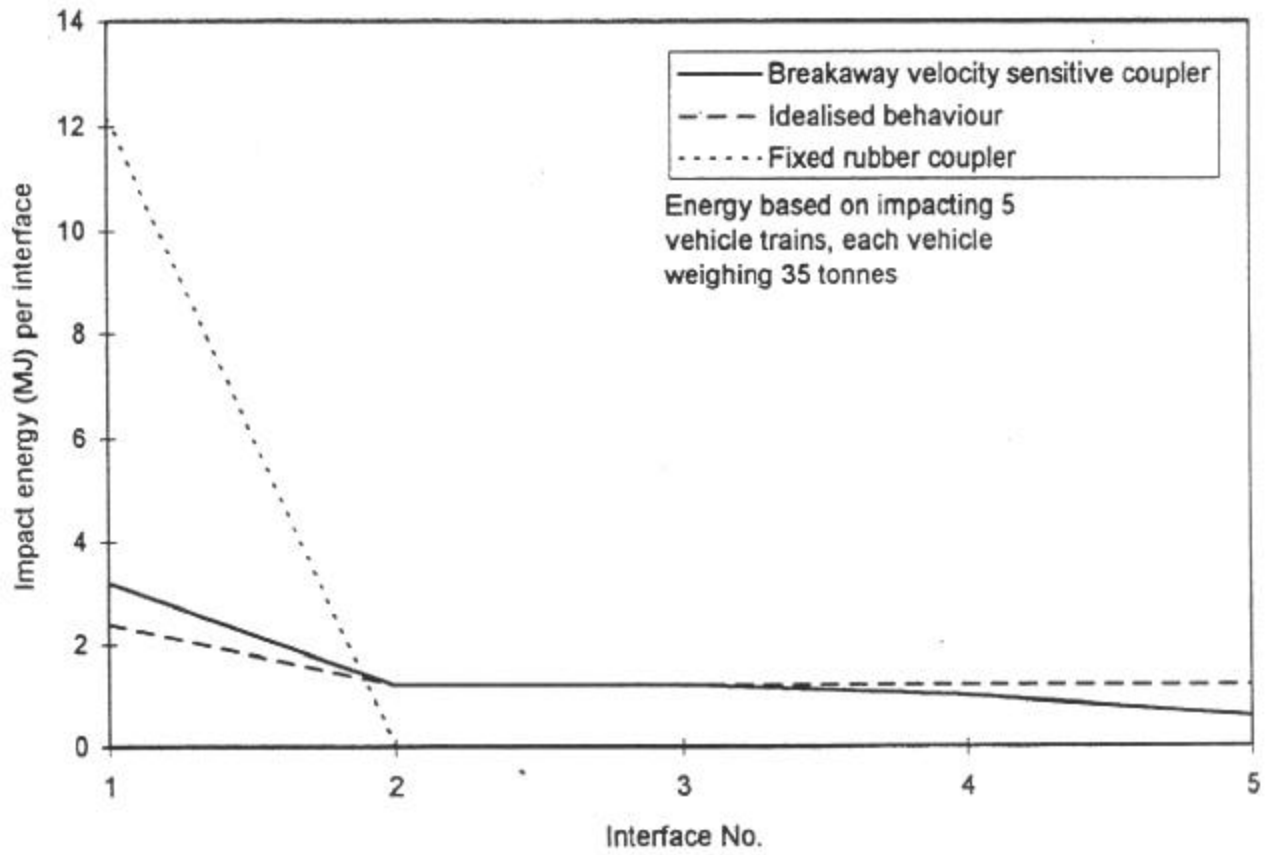

FIG. 2 - COMPARISON OF IMPACT ENERGY ABSORPTION BEHAVIOUR

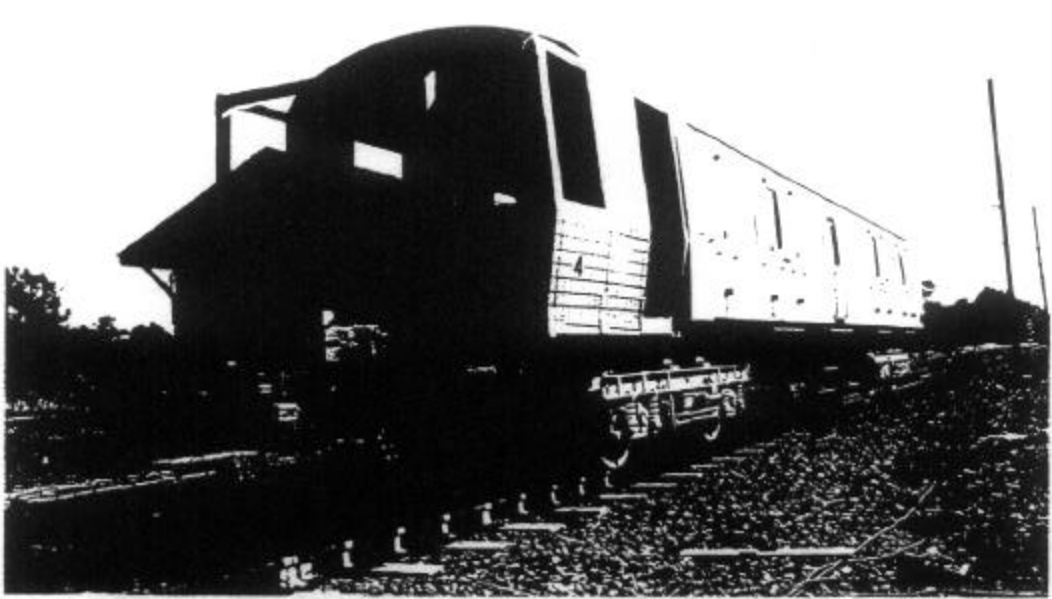

FIGURE 3 - MODIFIED CRASHWORTHY VEHICLE LEADING END

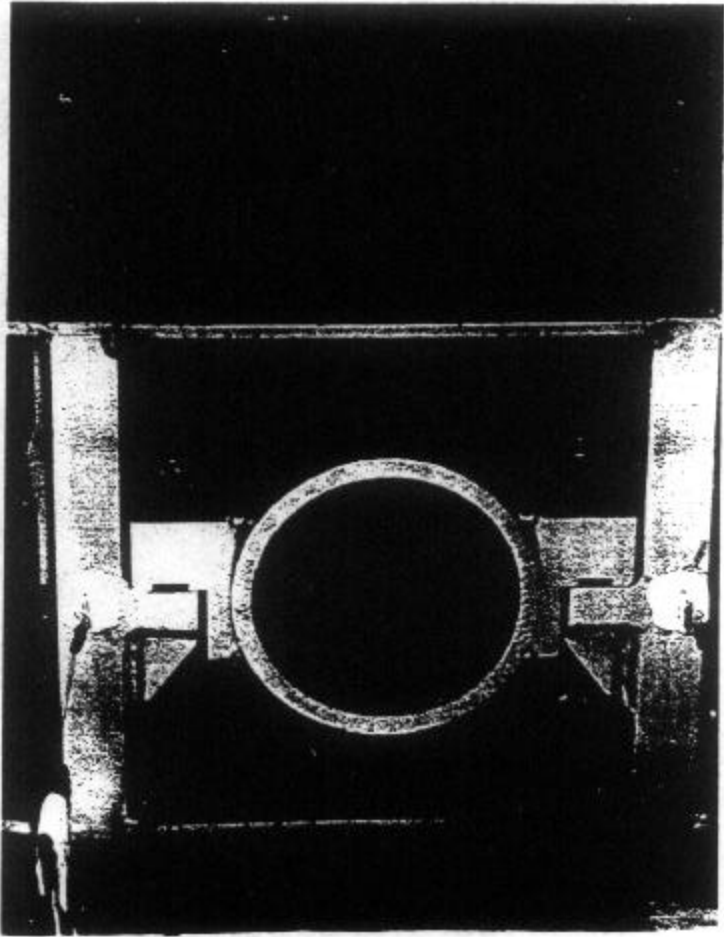

FIGURE 4 - DRAWGEAR ATTACHMENT

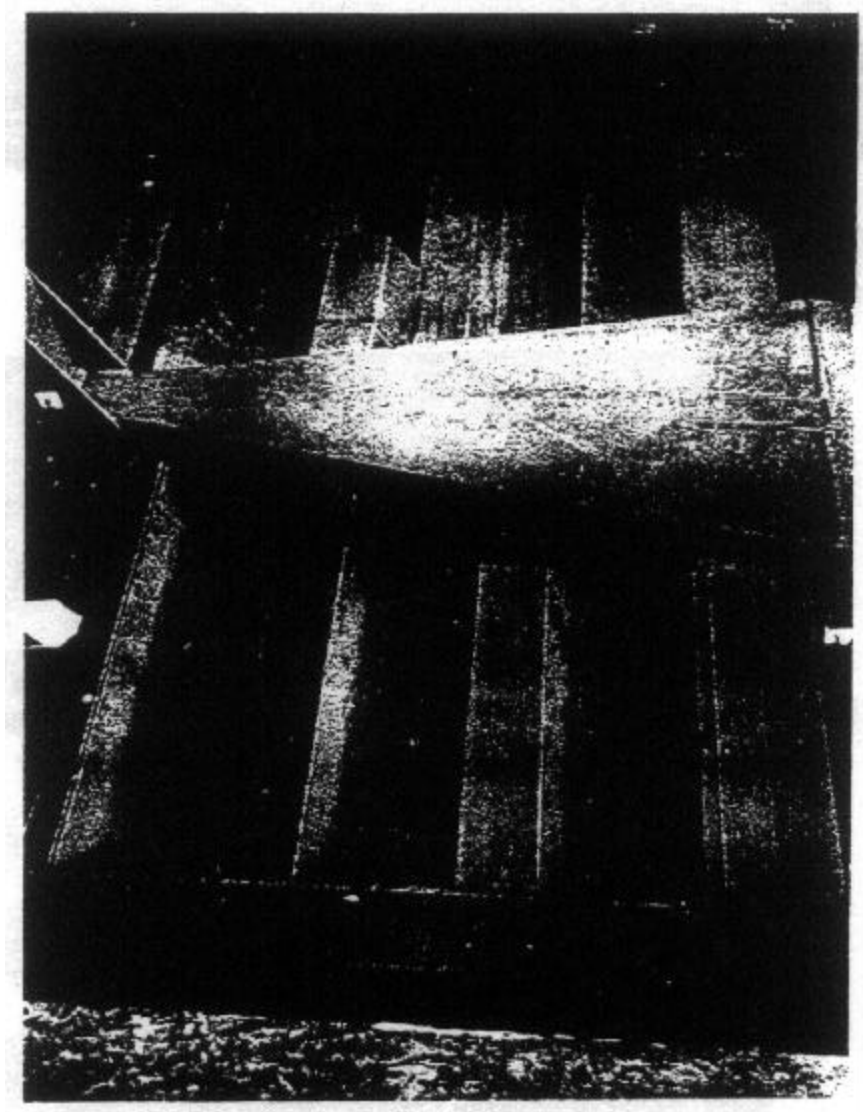

FIGURE 5 - MODIFIED VEHICLE END - SOLEBAR
CENTRE LONGITUDE AND HONEYCOMB

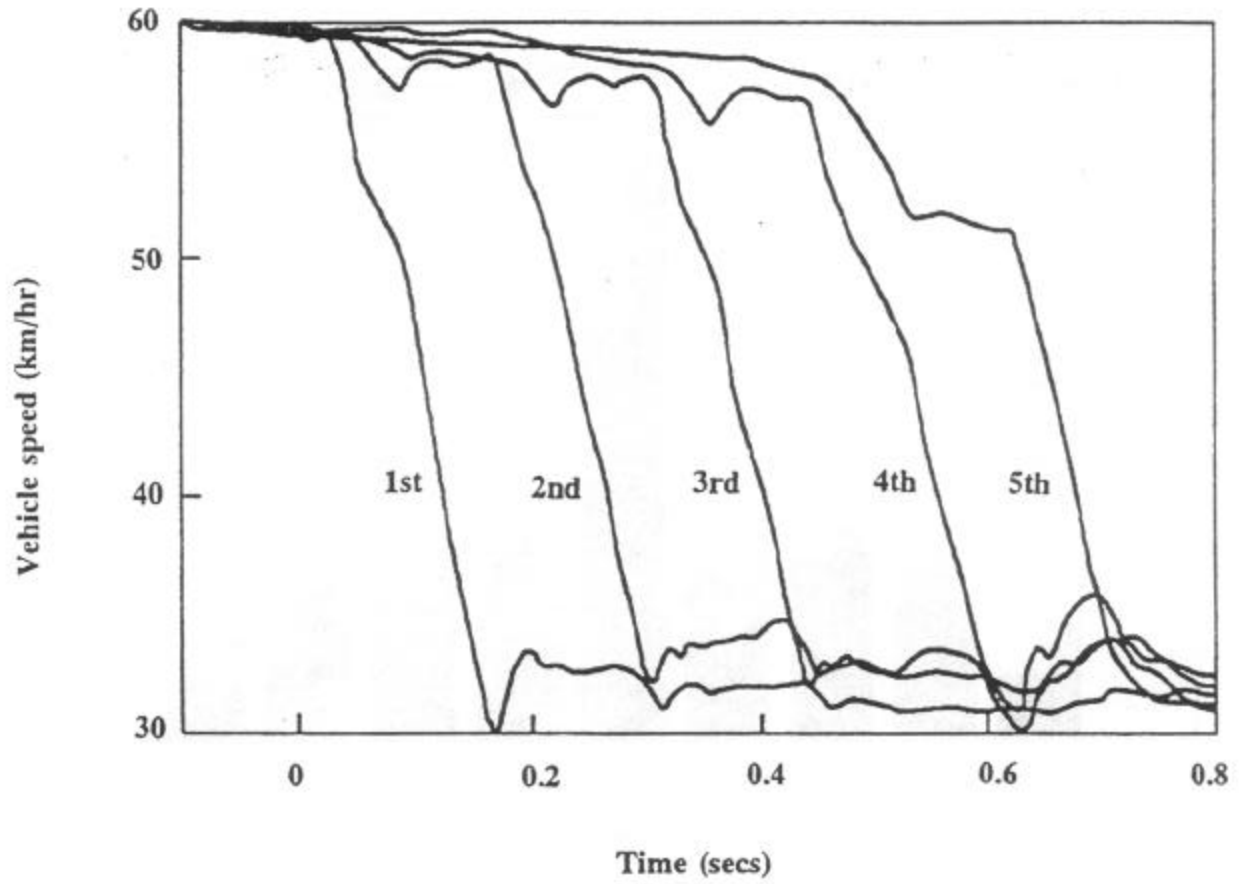

FIGURE 6 - SPEED-TIME PROFILES FOR VEHICLES IN MOVING TRAIN

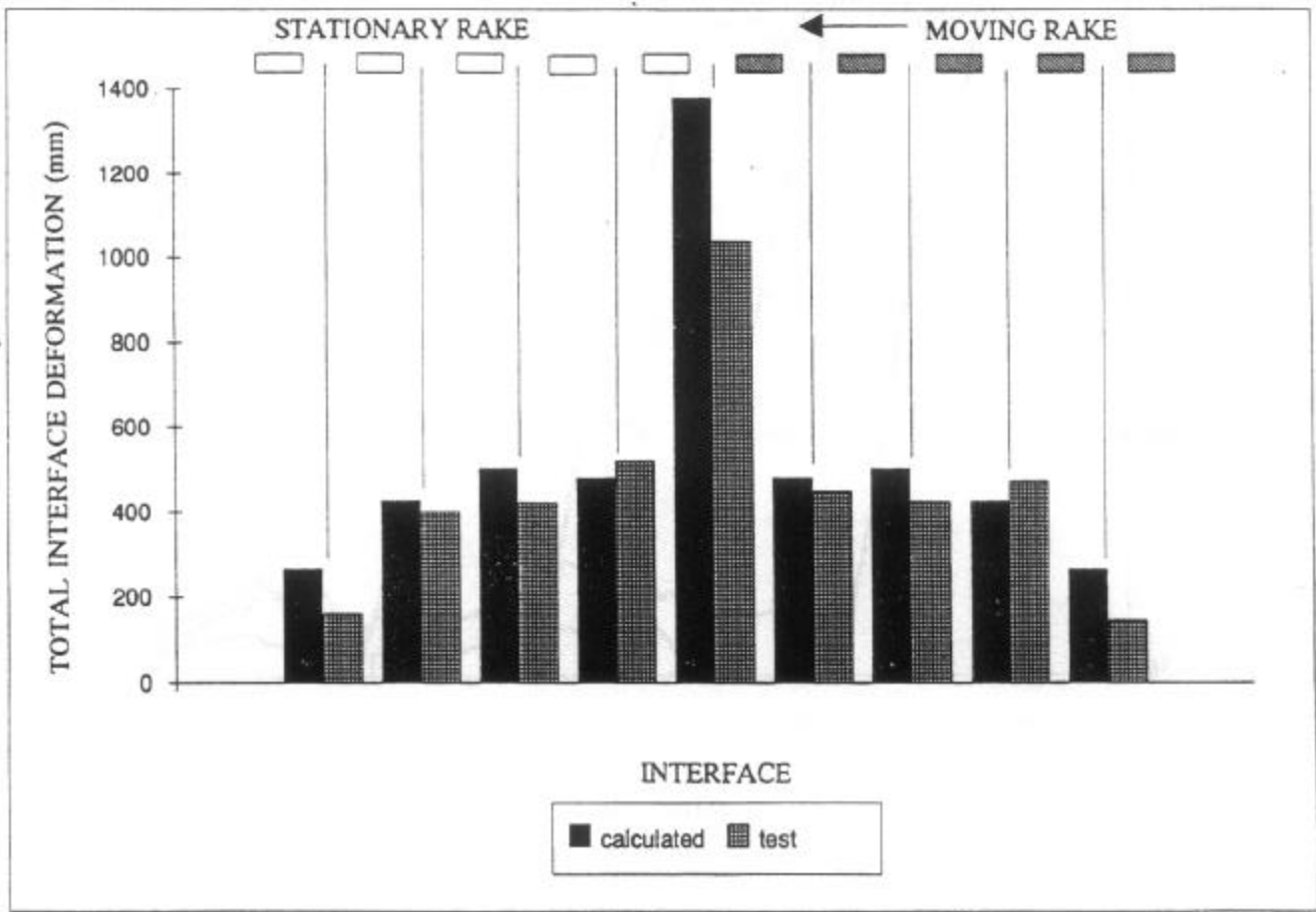

FIGURE 7 - INTERFACE DEFORMATION FOLLOWING TEST (b)

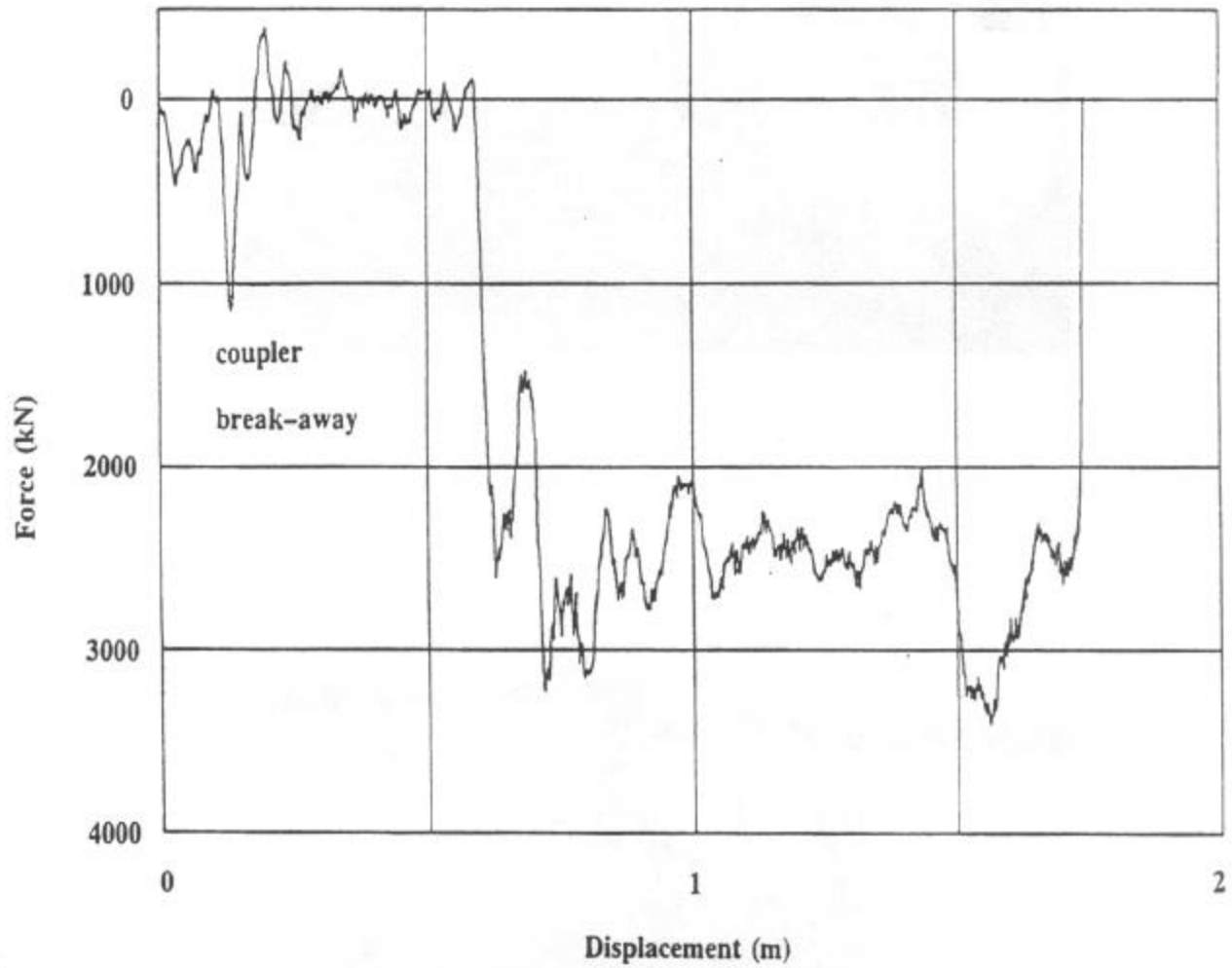

FIGURE 8 - MODIFIED VEHICLE CAB END FORCE DISPLACEMENT CHARACTERISTIC



FIGURE 9 - MOVING TRAIN AFTER TEST (b)



FIGURE 10 - UNMODIFIED VEHICLES IN OVERRIDE TEST (c)

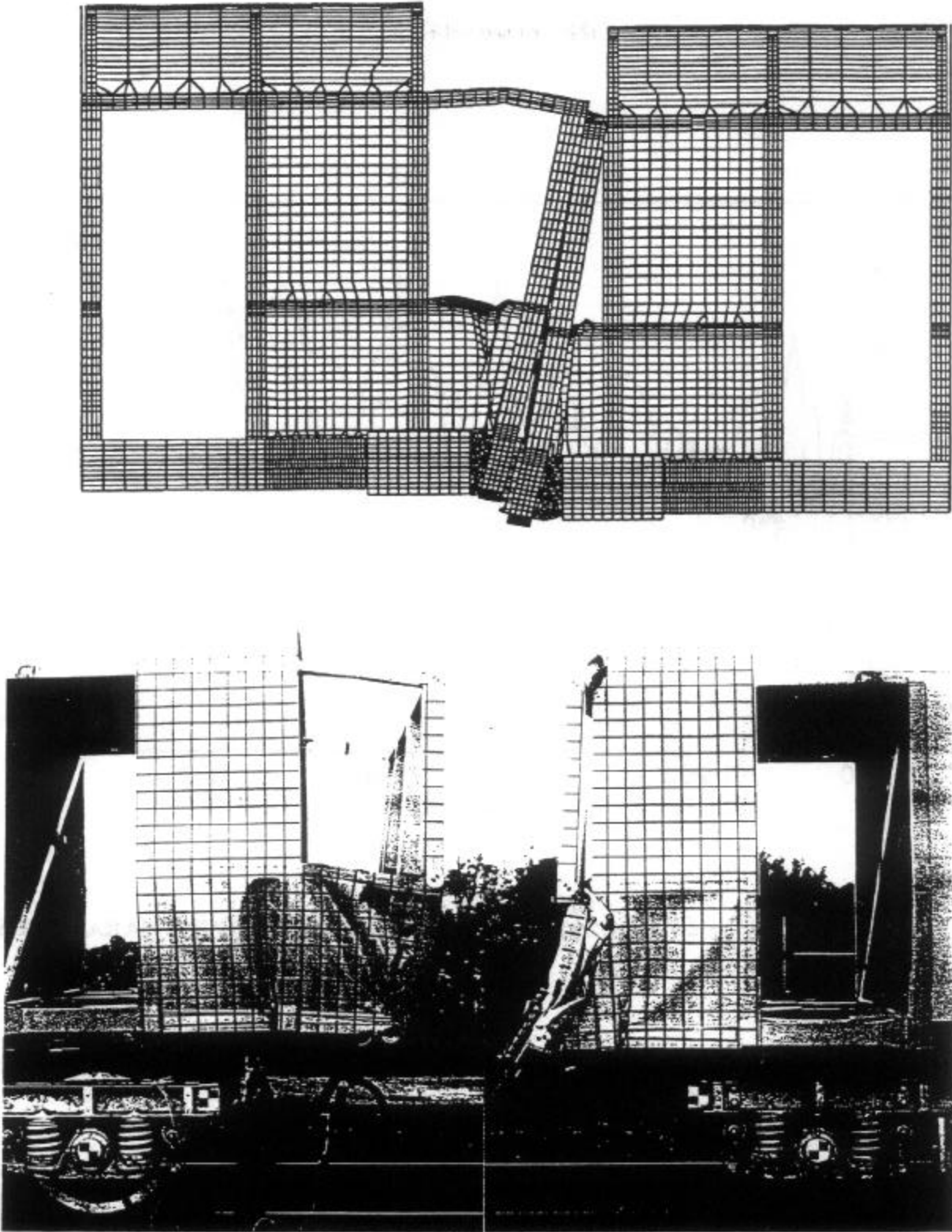

FIGURE 11 - OVERRIDE TEST (d) COLLAPSE MODE

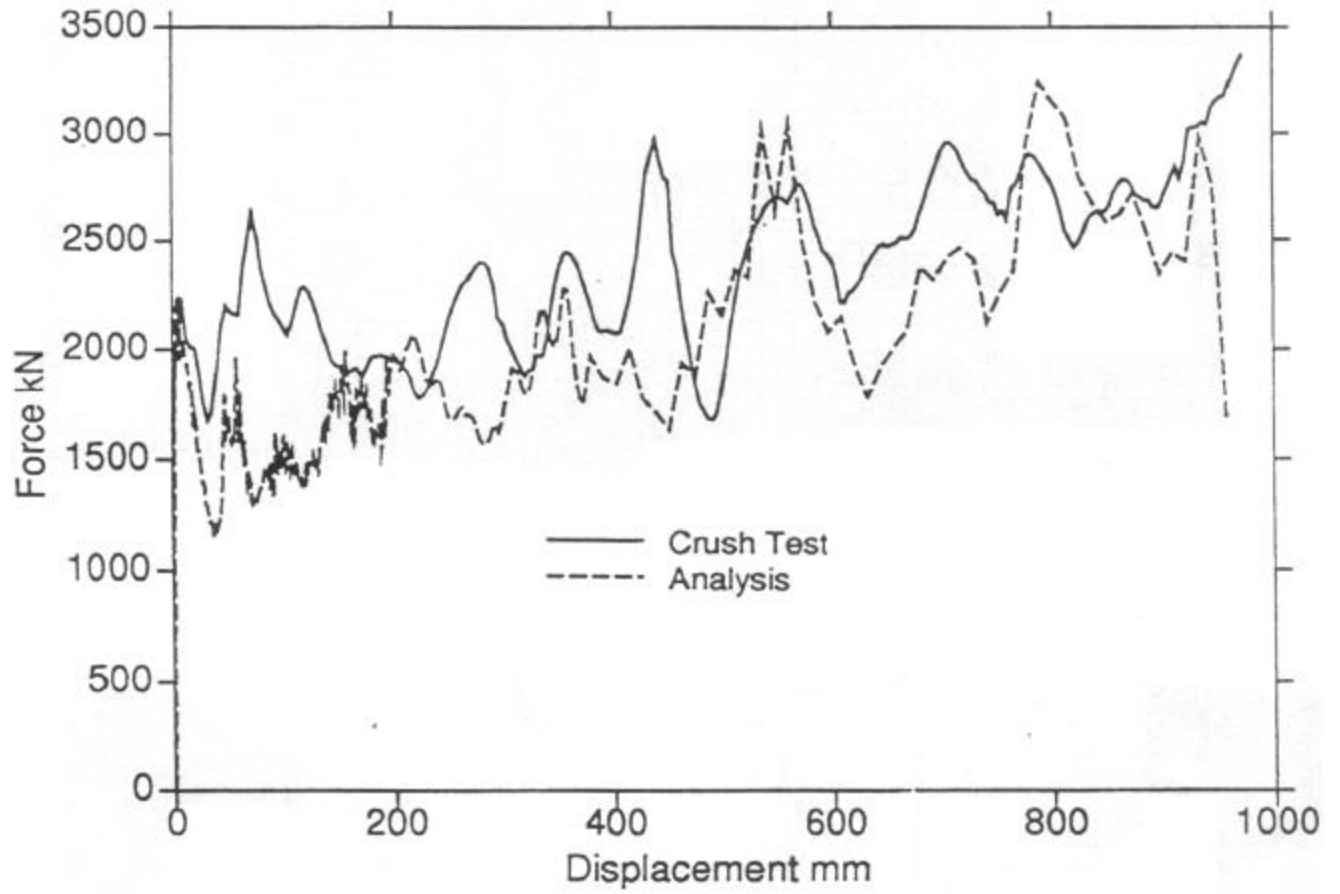

FIGURE 12 - QUASI-STATIC FORCE DISPLACEMENT CHARACTERISTIC

Crashworthiness of TGV 2N and the TER

STEVEN DITMEYER: For our next presentation, we have three speakers. Allow me to introduce Louie Marie Cléon from SNCF who has a degree in numerical analysis in chemistry and a postgraduate degree from the prestigious French School of Mines. Monsieur Louis Marie Clé on has been with SNCF since 1972 and was head of a rolling stock maintenance shop for six years and joined the Rolling Stock Structure Design Department in 1978. He is now head of rolling stock car body design, passenger comfort and interior fitting department for the last five years. Monsieur Clé on is also leader of the European study group for crashworthiness standards. Joining him also from SNCF is Monsieur Jean Legait, who also has a graduate degree from the French School of Mines for his thesis in material science on turbine engines. He has been with SNCF for two years, responsible for crashworthiness numerical simulations.

The third speaker is Monsieur Mark Villemin from GEC ALSTHOM, where Mark was Project Manager for the design of power cars at GEC ALSTHOM, worked on the TGV RESEAUX power cars and is currently in charge of the design and development for the power cars for the new TGV DUPLEX. He is also responsible for the design of the crushable zones of the new American Flyer trainsets.

So, gentlemen, welcome.

[PRESENTATION TEXT]

corresponding to every slide of this lecture

(86 slides: 25 Clé on, 27 Legait, 34 Villemin)

LMC represents Mr. Louis Marie Clé on

JL represents Mr. Jean Legait

[1-LMC1] LOUIS-MARIE CLÉ ON: Mr. Chairman, Ladies and Gentlemen, first of all let me thank you for inviting us to this crashworthiness symposium. This presentation is shared by me, Mr. Villemin working for GEC ALSTHOM and Mr. Legait for SNCF.

[2-LMC2] It aims at giving you the very best achievements of the SNCF in collaboration with one of its main rolling stock supplier, i.e., GEC ALSTHOM, in the field of crashworthiness. An introduction sets the background of passive safety field. After that, the basis of SNCF passive safety approach is made through reference accidents which have governed designs of trainsets.

Two rolling stock design examples are detailed; DUPLEX TGV and XTER Diesel Multiple Unit. Prescribed designs need to be validated by collision tests, which are always prepared with intensive numerical simulations. The validation of crashworthiness ability of single absorbers to full scale car bodies is explained. In particular, correlations are drawn between collision tests and accidents.

Feedback is given on previous rolling stock examples. Now that design is over, time has come to wonder on how well protected passengers will be in an accident. And how well absorption areas can work together? This is done through numerical simulations.

A video which sums up all collision debts will be shown. A conclusion is drawn which give some hints of future design trends and summarizes five years of achievement.

[3-LMC3] If Guided Ground Transportation System is a very safe mode of transportation, collision risk is still considered as a major risk for trains. Active safety is always enhanced in order to constantly lower collision risk. Obstacles can still exist on a track, which cannot be taken into account by active safety systems, how accurate they may be. This is, for instance, a track, at a level crossing. That is why safety has to be completed by passive safety.

[4-LMC4] Technical breakdowns on material developments and accurate numerical tools have made passive safety designs possible with reasonable investments. As a comparison, these investments are comparable to the one railways do for passenger comfort in spreading air conditioning on all their rolling stock fleet.

[5-LMC5] Let us focus on SNCF approach for designing trainsets. DUPLEX TGV was the first rolling stock to include passive safety concepts. Later, XTER has benefitted of DUPLEX experience.

[6-LMC6] The starting point is the study of the last 10-year accidents. Two main feature are retained. Front end collisions, with one vehicle climbing on the other, account for 80 percent of fatalities. These same collisions were within 50- to 70 kilometers-per-hour speed range.

[7-LMC] A tradeoff must be found between a set of dependent parameters like accelerations, strength and length of deformation. Based on these findings, SNCF have decided upon the two following improvement objectives: First, to prevent climbing; second, to organize deformations in the trainset.

[8-LMC8] We consider now reference accident used as a start to crashworthiness design of DUPLEX TGV.

[9-LMC9] In Voiron accident, a PSE TGV struck a rigid 80-ton block left on the railroad crossing by a truck, at a speed of 110 kilometers per hour. Power car buckled at the front and driver cab was crushed. The driver being killed.

[10-LMC10] DUPLEX TGV was designed such that, for an accident under similar conditions, the set of trailers behaves at least as well, with a further objective of substantially improving the power car's behavior.

Double decker trainsets have necessitated the use of aluminum for body structure. Full redefinition of trailer architecture has allowed to design end trailers with a large absorption capacity in the luggage compartment.

In the beginning, DUPLEX TGV trainsets were to be powered by RESEAUX TGV power cars. It is only later in the project that SNCF has decided to order DUPLEX power cars. Therefore, energy absorption areas have been introduced provided minor changes were done to the existing traditional power car body.

This diagram summarizes energy objectives for the design of DUPLEX TGV in reference to the Voiron accident.

[11-LMC11] Energy absorption areas have been located all over the trainset, in every vehicle end. Passenger and driver areas are reinforced to avoid deformation.

[12-LMC12] Let us consider reference accident used as a start to crashworthiness design of an XTER multiple unit. Contrary to DUPLEX TGV reference accident, here it is not related to any past accident.

[13-LMC13] XTER Deisel Multiple Unit, two or three coach version, is dedicated to regional traffic and runs on tracks containing a high number of grade crossings.

SNCF has taken the collision of an XTER trainset with a 15-ton truck on a level crossing at 110 kilometer per hour as a reference accident against which XTR is designed.

[14-LMC14] From train-and track-masses, 10% of the initial kinetic energy is dissipated into deformation. Fifty-five percent of collision energy is dissipated into structure deformation. Forty-five percent of collision energy is dissipated in removable device (buffer and so on...).

[15-LMC15] Energy absorption areas are located in every vehicle end. Passengers areas are enforced. Driving cab can deform and a crash refuge is made for the driver. Front ends are designed with a very high absorption capacity.

[16-LMC16] Previous energy absorption schemes and design examples have been turned into precise technical specifications. TGV and XTER body structure must withstand the compressive load of 2,000 kilonewtons on the frame specified in current UIC standards.

Maximum compression loads have been prescribed to end underframes and end vehicle structures beyond which they undergo predefined crushing with optimum energy absorption. These maximum compression loads result of a compromise between mean crushing levels, possible deformation length, energy absorbed and decelerations to which passengers are submitted. A look is done on both DUPLEX TGV and XTER car body structures.

[17-LMC17] Let us talk about DUPLEX TGV at first. Here is a view of the whole trainset with energy absorption areas.

[18-LMC18] Anticlimbing devices exist between every vehicle end. Anticlimbing device between power cars and end trailers is shown. For normal running.

[19-LMC19] Climbing can be prevented by means of the buffer retraction and the design of buffer brackets. Buffers are secured within steel brackets by means of special rivets. If the impact force exceeds a given force threshold, rivets shear off and the buffer begins to slide within brackets until the end walls come into contact. The bracket geometry is such as to stop vertical movements between cars. They consist of male support fitted to the power car and female support fitted to the end trailer. During buffer retraction, steel absorbers can absorb some energy.

[20-LMC20] An anti-climbing system, with different deformation steps, also exists between every trailer. Fusible bolts fail to allow vehicle end walls gap to close. During closing of intertrailer gap, a structural absorber absorbs some energy. Overriding is not possible anymore thanks to these previous two devices.

Let us now discover how design principles have been applied to end trailer.

[21-LMC21] Trailer underframes must withstand the compressive load of 2,000 kilonewton. Passenger accommodation area have to withstand 5,000 kilonewton for the end trailer and 4,000 kilonewton for the intermediate trailer.

[22-LMC22] End trailer is made of extruded aluminum frames. Elementary aluminum absorbers with thick section (30 millimeters) has been designed in 5754 aluminum grade. A weakening in their middle cross-section make them buckle with a virtually constant crushing force.

[23-LMC23] Four rows of three absorbers joined together by cross beams, and two side sills constitute the luggage underframe architecture. Side sills are designed to collapse very rapidly in order not to disturb the underframe deformation process.

Overall stability is achieved longitudinally by beams and laterally by the position of basic structures in two planes.

[24-LMC24] Here is a split view of luggage compartment area. Aluminum absorbers are also integrated inside of the roof rail. Rigid arches A1 and A2, which delimitate passenger area and the end of the car remain vertical while deformation progresses because of a good balance between mean crushing force of the underframe and of the roof. Mr. Villemin who is in charge of the power car design at GEC ALSTHOM will now give us a closer look at power car structure.

MARC VILLEMIN: As Mr. Clé on said, the TGV DUPLEX structure is directly stem from the TGV reservoir. This structure just meets the USA requirements. There's no crushable zones, no crash device, anything. And we are going to tell you how we arrived at the design of TGV DUPLEX.

First of all, we built criterions of the static loads. First, to improve the security of the driving car, to become a kind of shelter for the driver, to withstand dynamic stresses that occur during collapse so we can increase the stresses load in front of the cab to withstand a uniformly distributed 5,000 kilonewton load. And absorb the rest of the driving cab, and the load in the cab trailer.

From this criterion it is how you could begin. The purpose was to say the first step was to find room in the structure or to leave the structure collapsed. This was to show the different arrangements between the rear of the two cars, the TGV was the one with the DUPLEX. You can't see anything, but you have to move electrical blocks and equipment to give room to the structure, and everything that is located in the structure, for example, here we have the air condition system. This device has been fixed with shearing bolts so that the air condition system slides in the corridor during the collision.

Second step was to choose between the different kinds of principles of energy absorption. As Mr. Cléon explained, the trailer is of aluminum. But for steel frames it was not quite adapted firstly because of the weight.

A second principle that could be used with steel was the tiering. But the tiering needs much room around the absorbers, and there was not any more place in the structure to be able to take this principle. So we chose the local plastic, in spite of its difficulties to master.

The third step was to choose between the material we had, and we have chosen E-24, E-26, E-490 with the U.S. equivalent, just to have an idea of what it is. We did much work on the materials with the supplier. We did lab tests, both static and dynamic compression, friction to calibrate the material, and to feed the software for calculations for everything.

This is the rear part of the car body. We can see that everything here has been studied. There are energy absorbers on the side seams, in the center seams, in the sidewall absorbers, and also in the cab frame.

To explain to you how the design has changed, this is the TGV RESEAUX, and this is the TGV DUPLEX. And how did we come from this one to the other one? A lot of iterations between the machine calculations, tests, both static and dynamic and all this alteration gives the design equivalency so.

But it was not enough. The other problem was to reach the requirements of the static load, and to withstand with the dynamic efforts, and we have to put different materials in the structure. Of course, with keeping the stability rate to put the strength of materials, the strongest, we have the strength of the highest. Optimize the comportment, the behavior of a structure.

But one thing that is perhaps one of the most important is the connection between the absorbers and the structure. This, I think, is as much importance as the absorber itself. Here is the center seam, and this is the connection we have studied here with many iterations to allow the stresses to come along properly in the absorber.

It is very important for the stability of the whole structure, but can lead to completely change the shape of a structure. For example, towards the end of the rear part of the car body, without any absorption energy it could have had this shape. Without absorbers the shape becomes like this.

This photo is to show you that it is not only a question of design, but we had so many industrial programs to solve, everything is important to succeed. The welding, the tooling, the jigs. Everything must be taken into account.

Every part of the construction, the collapsible zone have been studied. This is the front part of the underframe, with its free arms. This is designed to be able to resist the collapse even in the non-straight non-inline shots. This is the center seam, that I have previously talked about.

This is the side seam, where we can see here again, there are two materials. The assembly must be very precise. And the door profile here is not connected to the upper structure.

This is the sidewall absorber. You can see that the shape is nearly the same as this previous one, but the way that it is built is totally different. We had all the problems to reach stability, because of its very small section versus its length, and we had to set up this structure so that this structure is completely symmetrical. It's just with that shape that we had to reach stability.

The center rail has been treated too. We have weakened the center rail. It is not an absorber. It's a fuse that's important, but it does not transferring the crash. And the roof it is aluminum has been weakened too with this corrugated shape. And the holes absorbing the roof rails.

[25, 45- Mr. Villemin] Let Mr. Jean Legait now explain to us the detailed design of XTER.

[47-JL1] JEAN LEGAIT: Well let us see how safety concepts apply to XTER trainsets. This design was made by DE DIETRICH. Continuously welded stainless steel is used for the car body.

[48-JL2] Here is a split view of the driving cab of the leading vehicle. Following our design principles, the formations are banned from passenger areas. Therefore a high energy absorption is necessary in the front of the train for two reasons. The first one is that no space is available between the two coaches. The second one is that passengers are situated right after the driving cab, and their protection requires a very high energy absorption capacity at front ends.

The desirable length around two meters required for energy absorption is found from the front of the coach to the crash refuge situated inside of the driving cab. The driving cab participates to the deformation process, and the driver has to find shelter in the crash refuge.

Stress is put on energy absorption modules that can easily be replaced after a collision. That is why, as will be described later, four energy absorption steps are distinguished.

The first three steps are provided by replaceable modules, leading to minor repairs, the fourth one being the crushing of the driving cab. Pole vault effect is avoided by the retraction of the coupling bar or automatic couplers inside underframes, and ribbed anticlimbers.

[49-JL3] On that slide here, you see the first deformation step, which is made by the buffing characteristics of the automatic coupler in yellow. It allows reversible deformation up to a collision speed of seven kilometer per hour (4.3 mph).

[50-JL4] The second one for a collision speed up to 18 kilometer per hour (11 mph) implies the fracture of fuse bolts, and the crushing of a central composite absorber. During this step the automatic coupler glides into a drawer containing the composite absorber.

[51-JL5] The third step is the deformation of two sides steel absorbers here in green for collision speeds up to 32 kilometers per hour (20 mph). This deformation step allows full clearance of the coupler, and the anti-climbing is made by the ribbed shape contact surface of the step three absorber. Until step three, the driving car body remains fully intact, with minor repairs to the front of the leading vehicle.

[52, 53-JL6, JL7] Step four, the deformation process is the deformation of the cab underframe. This underframe is made of a combination of thin and thick stainless steel sheets. The roof rail

contributes also to the deformation process of step four which ensures the global stability of the cab.

[54-JL8] The deformation is stopped by the densification of the underframe absorber which leaves room to a crash refuge for the driver. That's the end of the step four process.

[55-JL9] Here we come now to the validation of the previous structures, either for exterior and for DUPLEX structure. Before we show all collision test results, let me explain our methodology.

[56-JL10] Every absorber behavior and its energy capacity are validated by full scale tests, prepared with intensive numerical simulations. After that, integration of the absorbers in the underframe is tested. Then driving cab or rear end car bodies are tested before the full scale car body is crashed.

In those tests we are using real vehicles, you will see it later in the video. Numerical simulations have proved necessary in order to prepare all our collision tests, which are required for the optimum energy design of the car bodies.

Good software tools, like PAMCRASH or RADIOSS or DYNA3D of radios will allow the modelization of most of our test boundary conditions, and lead to good predictable results, provided they are fed with accurate data.

An eternal come and go is made between tests, and numerical simulations, which give a very good estimation of the car body behavior under a collision. This knowledge is very important when one wants to extrapolate from car body collision tests to accident simulations.

[57-JL11] This diagram models most of our collision tests. For multiple reasons, like safety, a speed limit on the test track, the need to get accurate measurements and so on, it is impossible to reproduce a real accident.

The SNCF approach for testing a car body with an energy absorption capacity W_1 at its front end is to reproduce a collision with that vehicle that allows that energy W_1 that we would want to be dissipated in it. It is done through a collision test that differs from an accident by a different collision speed, and different masses, but which dissipates the same energy W_1 in the vehicle. In other words, we say that **collision tests, and accidents are energy equivalent.**

A single vehicle or a single ballasted wagon with a mockup welded at its end, having a total mass M_1 at a speed V_1 , striking ballasted wagons weighing M_2 at a speed V_2 . W_1 is the deformation energy that we want the car body to absorb during the collision. Energy absorbed during the collision test is approximated by a mass ratio times initial kinetic energy.

We aim at finding ballasted wagon masses and collision speed so that W_{\max} is as close as possible to W_1 . Most of the time a good balance between multiple criteria we impose is to have an initial kinetic energy a bit higher than W_1 , and to impact into a heavy ballastic wagon trainsets, sometimes 400-ton trainsets, at collision speeds around 40 kilometer per hour (25 mph).

[58-JL12] These features characterize our collision tests. Eighty to ninety percent of kinetic energy is transferred into the formation. An average collision speed of 40 kilometer per hour (25 mph) is realistic for car body ends like end trailer of the TGV rear ends of power cars, which are concerned, with what I call secondary collisions.

Car body ends being situated in the front will, of course, undergo higher accident collision speeds. Nevertheless, a collision test gives us very good hints about its crushing behavior, and is very helpful for further numerical simulations at higher collision speeds. During these tests, effort, measurements and decelerations and so on are made that allow us to compare test results with previous simulations.

[59-JL13] We are now presenting XTER collision tests, and we are going to tell a bit more about them.

[60-JL14] Recalling that a great deal of XTER energy dissipation in front ends is made via easily replaceable items, which we call step number one to step number three.

All these three items have been tested separately. You can see features of a composite absorber and steel absorber after or before sometimes impacted. And their ability to work together is checked on the right with a full scale collision test.

[61-JL15] The deformation of step four is made by a structural deformation of the driving cab. In that driving cab two types of absorbers are present. The first one is the underframe absorber on the top, and underneath, the roof rail absorber. Those two absorbers have been separately tested before the overall cab behavior was checked.

[62-JL16] The collision test of the driving cab underframe. The underframe was welded at one end of the moving wagon, which strikes a standard wagon. Those two pictures show you the view of the underframe before collision, and after collision.

[63-JL17] Three point five (3.5) megajoule are absorbed by the driving cab underframe, with a good overall stability, and the perfect behavior of the weldings.

[64-JL18] Now we come into the driving cab collision test. The driving cab body fitted with the steel absorbers, our deformation step three. And, of course, the full driving cab was welded to ballasted wagon trainsets (M_2), and impacted by a 60-ton wagon (M_1) at a speed of 46 kilometer per hour (28 mph). The collision occurred in July, 1995. Three point eight (3.8) megajoule were absorbed by the structures, and we can see the very good overall stabilities.

[65, 66-JL19, JL19] Of course, these tests were prepared through numerical intensive simulations on the left and different structure on the right, you can see a red dotted line, which shows the crush refuge here which is intact after the crashing of the driving cab, and the next slide shows you the picture of the driving cab itself during the test. On the left undeformed, and on the right deformed.

The crash is in the yellow. You can see it here all right. So we found a very good-in these Tests-we could verify the very good balance between underframe, and roof rail crashing efforts,

which lead to an overall stability of the driving cab. The driving cab crashing efforts matched very well the simulation predictions.

Now, we are coming to the validations of these structures, and Mr. Villemien will tell us a bit more about it.

[67-Mr. Villemien] MR. VILLEMEN: As far as test for the DUPLEX TGV has been fully tested. To give you an idea, the center I show you before is a final design. Now let's look at the end trailer.

The first test we did was on the underframe. Indeed it's the underframe that gives stability to the whole structure. So it was very important to test it individually. First of all, of course, we did a calculation. These are the results.

We can see here the... that appears on the structure. Designed to absorb energy, and the global buckling that are designed to evacuate during the crash.

This picture shows you the results of a crash test. The underframe is bolted on the wagon. That is ballasted, and it is....

This picture shows you the different absorbers that have collapsed as forecast. And the side seams here at the crash. The purpose of this test was also to confirm the results of the calculations with it. It did it perfectly.

This was not enough to be sure that our structure has a good behavior in case of crash. So we did a test with a full scale, and a real structure of an end trailer. This end trailer was composed of the trainset with the ballasted wagon, and it was pushed by a locomotive at the speed of 45 kilometers per hour against a standing trainset of 480 tons.

The kinetic energy was six megajoules. And the energy absorbed by the structure has been four megajoules, and 0.8 megajoules has been absorbed by the anti-climbing devices. The rest of the energy has been taken to move a standing trainset.

This is a picture of the calculations we did before the test, to have an idea that kind of calculation needs 300,000 finite elements, needs powerful computers. And, of course, we had to do many calculations to be sure that the tests would succeed.

This was calculation results, and this is the test results. You can see the end trailer with the collapsible zones before and after the crash. You will see a short video at the end of our presentation that shows you how it happened.

In case of crash, I remind you that the end trailer is in aluminum was the first step. Another step was to master the deformations, the behavior of steel in case of collision. And we did it with the power car.

We first test the front end of the front of the frame. Remember here the free arms. This is the calculation that shows you what appears. And we are going to see now the result of the test.

Scale One. You are seeing from the vehicle. Before and after the test. The view here is exactly the same as the calculation. Then we had to test and to validate the behavior of the rear part of the power car. So we built a mockup that represents the real structure of the rear of the power car. It has been bolted on a ballasted wagon, and the consist that composed the trainset that was standing on the tracks. It has been impacted by the ballasted wagon at a speed of 26 kilometers per hour.

The energy absorbed by the structure was 1.5 megajoules and the buffers absorbed 0.8 megajoules. This represents the calculation forecast that we want those or the possibility of a structure with such a speed and we see as being this way. This is the result of the test. You can see the real structure here with the fitting of the couplers. Here you have the roof, side wall absorbers, side seal, and then after the crash, the roof that has collapsed, the baggage room. I remind you it's just a fuse. The cant rail that is also a fuse that has collapsed. You have the sidewall absorbers that have collapsed. You can see well a side seam has also collapsed. What we can see here is that a set of calculations only for the four zones that are possible.

MR. VILLEMIN: It was difficult to adjust the speed. So it was a bit lower than we expected, and it shows that we made just three-fourths on five possible. That means that 1.5 megajoules were three-fourths leads to understand that the structure is capable of 2.5 megajoules.

The next step is to test the whole structure of the power car. We are now doing preparations and the test is forecast in 1996. The calculation we did needs models of 500,000 finite elements. The test will be so that a standing ballasted wagon trainsets of 240 tons, and we will push the trainset composed by our power car of 40 tons and the ballasted wagon of 400 tons. Our power car is ballasted with its equipment, its track, its roof.

Now Mr. Legait is going to talk about the repartition energy along the trainsets. Both in front of collision, and in the collision that occurs on the grade crossing.

[79-J121] MR. LEGAIT: Well DUPLEX TGV and XTER Diesel Multiple Unit projects are nearly over. The time has come to analyze what we've been up to. Enormous time has been spent on the designing of absorbers on the elimination of any welding failure, on their integration inside of the car body, respecting different criteria like static strength loads and so on, making numerical simulations based on an accurate meshing of the car body and preparing validation collision tests.

One must keep in mind that the vehicle presented earlier have to be considered on the whole inside the trainsets. We must give convincing proofs that the deformation areas can work together or one after the other with no deformations in between.

Most of the time the deformation of energy absorption zones two and three are due to impacts between second and first cars or following cars together. Therefore, these secondary impacts, as I call them, depend very much on collision speeds, on the distance between the two car ends, and on the energy buffers absorb, making things very difficult to design. And even with different energy absorption area capacities, and their location inside the trainsets, one can wonder how far we are from being protected against different types of accidents.

[80-J122] That paragraph aims at giving energy absorption capacities for both DUPLEX and XTER trainsets. For both rolling stock we have made accident simulations with a very close look at energy repartitioning trainsets, and we have studied very closely the links between the first collisions, and the other collisions.

Lever crossing collisions and also front end collisions, even if the occurrence probability for such a collision is very small are assimilated. The table here summarizes the main difference between collision tests that we are doing, front end or grade crossing collisions.

That's to say the percentage of kinetic energy dissipated in the car body, which for collision tests it's something like nearly 90 percent; front end collision is 50 percent. While levered crossing collisions come to an amount from five to twenty percent, depending on obstacle and train masses.

[81-J123] What kind of simulations we are doing? We are using lump mass-spring models like this one for instance. Here it's demodelization of an extra trainsets in red. For instance, you see the different steps; step one to step three that are used before the driving cab is working and so on, all modelization is made of trucks for instance.

This model is related to every test we made, therefore, our tests have allowed us to evaluate forced displacement curves, which are used in those models for every part of the trainsets. These models need very accurate modeling and a good deal of experience not to be misled. Although they allowed fast simulations, results are bound to initial discretization and modelization assumptions.

Front end collisions are simulated with a moving trainset striking the same standing trainset. The standing trainset has brakes applied at full-service rate, and the moving trainset has brakes supplied at emergency rates. On both trainsets, brakes are represented with a friction coefficient of 10%

Grade crossing collision is harder to model. A friction coefficient of 10% is taken into account which is probably not enough to model the friction energy dissipated by the truck pulled by the trainset.

Two types of trucks are used for level crossing collisions: 38-ton or 15-ton truck. Here you see a picture of a 38-ton truck, some 10 to 20 percent of the collision energy is absorbed by the deformation of those tracks.

[82-J124] Now I will focus on DUPLEX TGV trainsets. DUPLEX TGV can absorb five megajoule in a power car; 2.5 in the front end before the driving cab, and 2.5 in the rear end. Four megajoule can be absorbed in the front end of the end trailer, and 0.8 megajoules in buffers at every vehicle ends. The table below summarizes energy dissipated.

Finite element calculations performed on a fully equipped power car body have shown the possibility to absorb another 2.5 megajoule in the equipment area here. This deformation though not organized as it is in the other energy absorption areas leaves the power car very stable with an undeformed driving cab.

The energy deformation repartition in trainsets found by numerical simulations is compared to the estimates given by that formula here, which is mass ratio times the kinetic energy, and you will see how complicated trainsets effects may be, but simple estimation allow very good estimation balance of energy repetition on every deformable areas.

In those simulations we will focus on the first collision between the power car, and the power car in the case of a front end collision or the power car and the obstacle and so focus on the first collision, and secondary collision, that's to say collision between the end trailer, and the rear end of the power car.

And secondary collisions are mainly dictated by first a related speed here, you see V_1 minus V_2 , which is quite small, and with a high collision speed, this relative speed is very, very small. And also that secondary collision is dictated by the mass ratio here with mass M_2 and M_1 . The mass M_2 is the mass that the end trailer impacts. In the case of a level crossing collision, M_2 is the mass of the leading vehicle, plus the obstacle. In the case of a front end collision, M_2 are the mass of the two power cars in front of it.

Therefore, it is more detailed than the article, and you will see it in the article here I took out only small details. But mass ratio are very different from first collision to secondary collisions and lead to a very different mass energy repetition in the trainsets.

[83-J125] As I told you before, two accident simulations are made. They both lead to a collision energy around eight megajoule. The first one is a level crossing collision against a 38-ton truck at a speed of 100 kilometer per hour. The second one is a front end collision at a speed of 50 kilometer per hour. A front end collision against the same standing trainsets I recall. You see in those diagrams here that level crossing collision simulation results in a concentration of energy in the power car front end, whereas front end collision energy on the right leads to a more even energy distribution in the train sets.

We also noticed that there is a decoupling between first and secondary collision. Most of the time the end trailer collides with the rear parts of the power car, whence the first shock is over. Therefore, when first collision energy exceeds front end absorption capacity, energy has to be dissipated in the equipment area.

Of course, the results I'm talking about are only applicable to articulated trainsets and for front end collisions up to 50 kilometers per hour. In the case of TGV, contrary to what I've shown Mr. Lewis, we have very, very strong links between trailers, and the end trailer cannot be considered as a single vehicle.

[84-J126] Now we are coming to trainsets, which can absorb a total of 5.8 megajoule, and five megajoule can be absorbed in the front in the driving cab, and 0.8 megajoule at the interface of the two coaches in the coupling bar.

Again, two accidents are simulated, which both lead to a collision energy of nearly five megajoule. This is a level crossing collision against a 15-ton truck at 110 kilometer per hour, and the second one is a front end collision at 60 kilometer per hour. On the two diagrams here you see that there is hardly any difference between the two collisions here. The article explains why it seems to be related with the mass of the train, and the mass of the track.

For level crossing collision there is a very high first collision energy that nearly needs 100 percent of the driving cab to be crushed, and there is a very negligible secondary collision energy.

For the front end collision there is what I call an average first collision energy needing only 80 percent of the front end absorption capacity. The secondary collision is also with a very low amount of energy, and since nothing is done for structural deformation at the interface, but energy is dissipated again in the driving car in the front.

Therefore, the front ends of the vehicle here in that case are designed to absorb first collision energy, and even all of the secondary collision energy, which is the case of front end collisions only. This works well, of course, if the first collision does not exceed the front end's capacity.

[85-J27] The conclusion on those level crossing and front end crossing simulations, we have seen that a level collision results in the very high percentage of energy located in the front of the leading vehicle.

Front end collisions allow collision energy to be more evenly distributed in the trainsets because of collision speed mass ratio and so on. We have seen a decoupling of the first and secondary collisions, which could lead to different consequences. To design a vehicle with many absorption areas located through the train is a valid approach. Being sure that deformations are only located in these areas is a very difficult task. It is untrue to think that a trainset's designed with 10 megajoule of energy absorption capacity throughout the trainsets can face every 10 megajoule collision energy accident.

Trainset mass leaks between coaches lead to various energy repartitioning in the trainsets, depending on the accident type. The two rolling stock design examples XTER and DUPLEX TGV have been designed with reference to a level crossing accident, produce simulations have shown that front end collisions up to 50 kilometer per hour could also be faced by these trainsets without redimensioning energy absorption areas.

SNCF through its experience from past accidents, and the development of DUPLEX TGV and XTER favors trainsets with strong front end energy absorptions capacities. An amount of five megajoule in the front end of the leading vehicle is thought necessary.

And it seems to be a maximum of what it is technically possible to design. Other areas have to be dedicated to energy dissipation with variable capacities, depending on the type of the trainsets.

Now before showing you a video, and before the conclusion of Mr. Cléon, I will show you some simulations of behavior of the power car that simulation we've been doing before the tests, and some simulation also of different accidents. We are going to have a look on the power car, and see how the model is made. Well, you can see underneath the picture of the outside look of the power car, and here above is the meshing of the structure, which was made by a Shell Machine, and it's quite an important work, because we came up to 500,000 shells.

In that model just above you can see the simulation of the collision test that we are preparing in the coming months of this year. For the first time you will see results before tests. In the front of the power car, you can see the aluminum honeycomb in front of the cab shield.

Here you can see the driving cab that you will remain intact after simulation. Just after the power car you see the 100-ton ballasted wagon, which models the end trailer following the power car, between the power car, and the wagon, which are coupled together, there is an anti-climbing device.

One important feature of this model is what you can see inside the structure, which is the structure in itself that all electric appliances have been modeled. This is a very, very important work. You can see also the tracks underneath, and everything has been modeled.

As Mr. Villemin stated, in order to get such modelization, we are coming from every single absorber modelization and so on up to that structure, which, of course, in order to keep very good results have to be validated through simulations, producing all collision tests that we have previously done. That's a very important model, and on a CRAY C90 for instance which requires 120 hours of computer time, which is very, very important.

Then you will see an animation of the calculations so that's quite short. You will first have a closer look at the structure in front of the driving cab here, and after that the wagon will impact the rear end of the power car, and you will see some deformations in the side wall absorbers here.

It's only two seconds on the video here, but it's something like 116 milliseconds which are very, very long too. Let's have a closer look at the power car front end. See how it works, and how the driving cab is well protected? You can see the shield in front of the driving cab. And the honeycomb that protects it, and you will see the crashing of the underframe in front of it, and the crashing of the aluminum honeycomb as well.

All right. Now we come into the rear end of the power car, which is a bit more interesting. It is a cross-section here, and maybe you can recall the sidewall absorber, and different absorbers on the underframe like the roof rail, the side seal absorber.

Here, near the arrow you have the anti-climbing device. On the left here you have got the female parts of the anti-climbing device, and the male parts on the power car. And you will see that in that test especially in that area, you will see a vertical movement that is restrained by the anti-climbing device. There it is.

Now we are coming to simulations showing one demobilization, and it's the front end simulation I was talking about in the previous slides. It's not very spectacular compared to the other one. So it's the DUPLEX TGV at 50 kilometer per hour impacted the other one. Here the color shows you the speed so there's one which is standing, and the other one coming, and here you will be able to see how it works.

Back to XTER now, and the driving cab is also simulated. There is also the test, and here you see the numerical simulations. You can see the steel absorbers in the front, which are the step three absorber, and you may see the crushing of the underframe of the driving cab, and of the roof rail.

And you see the dotted line, which is the crash refuge, which is intact to simulation. For the XTER we have front end simulation, and level crossing simulations. We are beginning by front end simulations.

On the same toward the DUPLEX TGV there's a standing trainset, in particular a moving trainset at 60 kilometer per hour.

We come to level crossing collisions, and you will see the modelization of the level crossing collision simulation with an XTER trainset at 110 kilometer per hour impacting a 50-ton truck on the level crossing. Here is the track, and impact.

These are simulations. We are doing one every time we have got an accident that occurs, and we want to check every time if the new design of the XTER can face in a better way an accident that we have had a couple of years ago. The accident occurred in Morcenx, and it's XTER trucks were very heavy loaded at a track on the level crossing, and the collision speed was 110 kilometer per hour, and it was something like a 25-ton truck.

That truck was full of stones, which damaged quite a lot the first coach of the XTER. You see the animation of the accident. It's a first simulation and we have got to do some more about it. You'll see from another angle.

That type of simulation is a first step, because I wanted to by those simulations to try to find the good obstacle behavior before doing some more simulations with a full 3-D mobilization of the trainsets, which is not the case in that simulation. That ends our simulations, and we are going to show you a short video summarizing all the collision test we have been doing over the last three years. That will be commenced by Mr. Villemin.

MR. VILLEMIN: This is the first TGV DUPLEX 26. It's the third generation one. The trainset is composed by two power cars and eight double decker trailers. There are three first-class coaches, one bar coach on the upper level, the lower level being occupied by equipment, and four second class coaches.

This train can transport 540 people. That means that it is 40 percent more than a simple flow trainset, and this we weren't increasing the load per axle. Thanks to the use of aluminum. The power car is new too because of the passive safety device of course, but also by its aerodynamics. Its central driving cab, its disk brakes that reduce the emission of noise. We are now going to present you the different cross checks we did on full scaling. First, the front end on the frame of the power car.

The speed of the impactor was 12 meter per second. The behavior restructure confirmed perfectly the calculation results. More ambitious was the cross test of the whole rear part of the power car. More ambitious because of the size, of course, but also because of the numerous different absorbers and fuses it involved.

The aim of this cross test was to confirm the good interactivity between all the components, and the stability of the structure, happening last October. This is the rear part of the power car. It is bolted on the trainset, but it stands on the track.

This is the impactor wagon that is pushed by locomotives. Before the crash, speed is 10 meters per second. You can see here the perfect behavior of the structure. And as I told you before that appears. Three out of five possible. The structure can absorb 2.5 megajoules. You can see here the sidewall absorbers. And down the side seam. Now some pictures about the variation of the

anti-climbing system. This test involved two wagons on which were fitted our system. You can see the shearing of the rivets.

The structure of the first trailer is in aluminum. It was necessary to validate the calculations with such a material. This is the calculation. This behavior has been reproduced in the tests you are going to see. This is the first trailer full scale impact. You can see on the underframe the side seals. The crash, the absorption by the center seals.

All these tests prove that a DUPLEX TGV is the safest test in the world. The first commercial circulations will be this winter on the Paris line.

A few words about the XTER. It stays for a new generation of diesel multiple units of SNCF. It is dedicated to general traffic. It is composed by either two or three vehicles, an anti-climbing device is fitted between each car in the front of the cab cars which are designed to absorb energy.

This is again tests with a one-quarter scale model on the front of the baby shell. The purpose of this test is to confirm the scenario of the deformation, and not the quantity of energy. Of course, a full scale test is necessary.

So here you have the driving cab. The test reproduced exactly what the computer had forecasted. The speed was 12 meter per second. You can see the folds of the structure. This trainset will be able to transport 160 people in total safety at a speed of 160 kilometers per hour. The first trainset is forecast for 1997. Now, Mr. Cléon is going to tell you our conclusions.

[86-LMC-25] LOUIS-MARIE CLEON: In conclusion, the definition of one reference accident or several accidents is a difficult task. In addition, this definition may very likely evolve with the years. Therefore, we need to filter past accident database, because of active safety in improvement planning.

An early design of passive safety is necessary which does not lead to us a cost increase. SNCF has made a great number of collision tests, prepared with intensive numerical simulations. The evolution of numerical tools allow an accurate modeling of car bodies.

Future rolling stock crashworthiness ability could only be checked thanks to numerical simulations, and crash tests could only be done upon absorbing components.

Decelerations levels are an important feature to consider, and design concepts aim at lowering them. A biomechanical criterium injury must be defined to measure the consequences of a collision on passengers and crew. This is why the field testing includes modeling of interior fittings. A subject on which SNCF is planning to put the stress on. Thank you for your long attention. [Applause.]

CHAIR: We have time for a couple of questions before we take a break. Because our speakers are not native anglophones, they have asked me to ask you to please speak slowly and enunciate clearly when asking questions. Do we have any questions from the floor? Some.

AUDIENCE ATTENDEE: First, I would like to congratulate them. That was an excellent presentation. I have a question. Most of their presentation they had talked about the amount of

energy absorbed different collision, different designs. Nowhere you have said what acceleration levels you were targeting all those energy levels to be absorbed by designing different features.

LOUIS-MARIE CLÉON: In fact by prescribing maximum loads to be sustained by the structure, and for instance, you saw on the end trailer, we set a maximum of 500 kilonewton. That's to say that we aim at having decelerations not more than something like 5 J in the passenger areas. For instance, in each stair trainsets, the first passengers just close to the driver end panel will be submitted to decelerations around 5 J on the average.

For the DUPLEX, TGV passengers are something like 20 meters away from the impacts, and they will also be submitted to the same kind of decelerations. Of course, we are aiming at lowering those deceleration levels. But as Mr. Cléon tried to explain when we want to have a certain amount of energy in a certain space that sometimes sets some crushing force levels, which you relate very easily to the deformation, and that's a very difficult compromise, which on average it's something like 5 J.

CHAIR: Do we have any more questions? Yes?

AL EAGERS: Al Eagers, MTA Baltimore. Do you have any calculations on the additional cost or weight that you incurred by incorporating these designs?

AUDIENCE ATTENDEE: The only answer I could tell would be on the DUPLEX TGV. That was maybe not mentioned here, but we usually mention it in other presentations. The additional cost put by passive safety was something around one percent of the total cost of the project. With that amount of cost increase, we very deeply think that passive safety can be afforded.

CHAIR: Thank you. I think-well we will be able to take more questions and answers in the course of our panel discussion at the end of the afternoon. Let us take a break, and if everybody could be back in their seats by twenty minutes till four. Thank you.

PRESENTATION

CRASHWORTHINESS OF TGV 2N AND THE TER



DIRECTION DU MATÉRIEL ET DE LA TRACTION

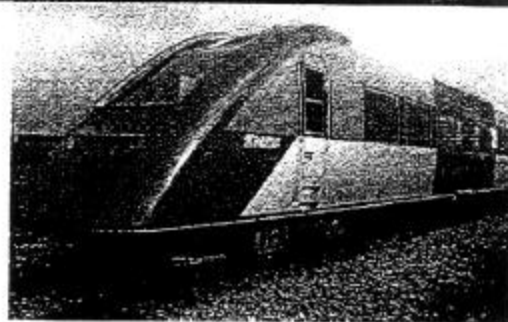
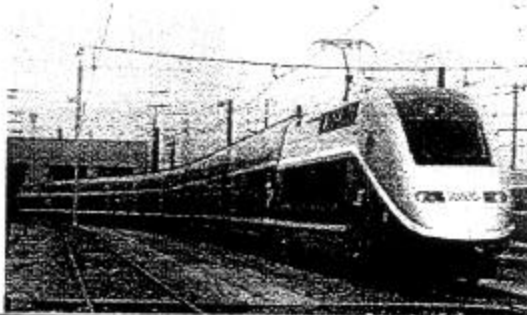

SNCF
STRUCTURAL CRASHWORTHINESS
DESIGN STRATEGY

Symposium on
RAIL VEHICLE CRASHWORTHINESS

Boston, June 24-26 1996

IIB-2-21

Summary

1. INTRODUCTION	2
2. SNCF APPROACH FOR DESIGNING TRAINSETS	2
2.1 BASES OF THE APPROACH	3
2.2 DUPLEX TGV TRAINSET	4
2.2.1 Reference accident	4
2.2.2 Energy distribution along the trainset.....	5
2.3 XTER DIESEL MULTIPLE UNIT	5
2.3.1 Reference accident	5
2.3.2 Energy distribution alongthe trainset.....	6
3. ROLLING STOCK DESIGN EXAMPLES	7
3.1 DUPLEX TGV TRAINSET	7
3.1.1 The anti-climbing device of the TGVDUPLEX	7
3.1.2 Design of DUPLEX TGV end trailer car body	9
3.1.3 Design of DUPLEX TGV power car body	11
3.2 XTER DIESEL MULTIPLE UNIT	13
4. VALIDATION OF THE CAR BODIES	15
4.1 METHODOLOGY.....	15
4.1.1 Numerical simulations	15
4.1.2 Collision tests.....	15
4.1.3 From collisiontests to accidents	16
4.1.4 Conclusion	18
4.2 DUPLEX TGV	18
4.2.1 End trailer car	18
4.2.2 Power car	20
4.3 XTER DIESEL MULTIPLE UNIT	22
4.3.1 Step 2 and 3 absorbers.....	22
4.3.2 Driving cab underframe	22
4.3.3 Driving cab	22
5. FEED BACK ON DUPLEX TGV AND XTER.....	23
5.1 ACCIDENT SIMULATIONS	24
5.1.1 Type of accidents considered	24
5.1.2 Obstacle modelling	25
5.2 DUPLEX TGV	25
5.2.1 Energy distribution along the trainset.....	25
5.2.2 Front end collision.....	26
5.2.3 Level crossing collision.....	28
5.2.4 Comparisons between DUPLEX TGV behaviour under level-crossing andfront-end collisions	30
5.3 XTER DIESEL MULTIPLE UNIT	31
5.3.1 Energy distribution along the trainset.....	31
5.3.2 Level crossing collision.....	31
5.3.3 Front end collision.....	32
5.3.4 Comparisons between XTER behaviour under level-crossing andfront-end collisions	33
5.4 ACCIDENT SIMULATION CONCLUSION AND FUTURE DESIGN TRENDS	33
6. CONCLUSION	34

**SNCF STRUCTURAL
CRASHWORTHINESS DESIGN
STRATEGY
DESIGN EXAMPLES OF DUPLEX
TGV AND XTER DIESEL
MULTIPLE UNIT**

Symposium on RAIL VEHICLE CRASHWORTHINESS
Volpe National Transportation Systems Center
June 24-26 1996

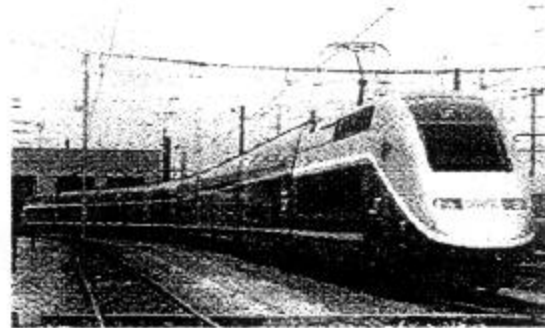

Louis Marie Cléon, SNCF
Jean Legait, SNCF
Marc Villemin, GEC ALSTHOM

1. Introduction

Guided Ground Transportation system is a very safe mode of transportation but collision risk is still considered as a major risk for trains. If active safety is always enhanced in order to constantly lower collision risk, obstacles can still exist on a track which can not be taken into account by active safety systems, how accurate they may be. We think, for instance, of a truck at a level crossing ... That is why, active safety has to be completed by passive safety.

Passive safety justification comes from the implicit acceptance that a train collision is still possible. For this reason, it has always been a very controversial topic to deal with. The definition of a reference accident is not easy. It could well lead to never ending arguments in order to define how far we should go.

Nevertheless, above mentioned problems must not refrain ourselves from introducing passive safety design in trains. Technical breakthroughs on material developments and accurate numerical tools .. have made passive safety designs possible with reasonable investments. As a comparison, these investments are comparable to the one railways do for passenger comfort in spreading air conditioning on all their rolling stock fleet ...

DUPLEX TGV was the first trainset to ever benefit of passive safety concepts. Because of 17 ton axleload maximum requirement on high speed tracks, double decker trainsets have necessitated the use of aluminium for body structure. Full redefinition of trailer architecture has allowed to design end trailers with a large absorption capacity in the luggage compartment. In the beginning DUPLEX TGV trainsets were to be powered by RESEAUX TGV power cars. Later on SNCF has decided to order DUPLEX power cars with a further objective of substantially improving the power car's behaviour. Therefore, energy absorption areas have been introduced provided minor changes were done to the existing traditional power car body.

This paper deals with the design description of two rolling stock: DUPLEX TGV and XTER Diesel multiple Unit.. All design stages are described from the very beginning to the construction of the first trainset. A feed back is given on previous rolling stock examples to understand how well protected passengers will be in an accident. and how different energy absorption areas can work together? This is done with numerical simulations and a conclusion is drawn which gives some hints of future design trends and summarises 5 years of achievements.

2. SNCF APPROACH FOR DESIGNING TRAINSETS

The approach taken by SNCF and its equipment suppliers to advance in this area by adopting new principles of car body design and then applying them to the rolling stock has been a gradual and pragmatic one, advancing in stages, each stage being consolidated by engineering calculations and tests on full scale vehicles.

2.1 Bases of the approach

All the parameters of a shock are related by physical laws and a designer has no alternative but to effect trade-offs between speed, acceleration, strength of materials and structures, and deformation. It is necessary in particular to remember that to stop a mass requires a certain distance and that no artefact or device can replace the sufficient length that it is essential to allow for in both the buffing and draw gear and the body deformations.

Moreover, the combination of the mass and force applied gives an acceleration. It's no use guaranteeing the integrity of the vehicles if the occupants receive serious injuries from too great an acceleration or from trainborne equipment or fittings that have broken loose,

The second basis, which is also of the essence, is the systematic analysis of all known events relating to the field under consideration, to learn as much as possible from them, even if they are "disturbing", by accepting, among other things, the risk of making explicit, through the analysis and the future consequences it implies, the recognition of shortfalls in design that were hitherto merely implicit. In fact, isn't there a symmetrical risk in hiding these shortfalls and carrying forward the same construction principles ?

Two particular conclusions have been drawn from the analysis of the accidents having caused fatalities or serious injuries in the last ten years (*1982-1992 period*), focusing in particular on the morphology of the impact and the energy involved:

- front-end collisions with one vehicle climbing on the other account for 80% of fatalities,
- these same collisions were within the 50 to 70 kph (30 to 40 mph) speed range.

Based on these findings, SNCF set the following improvement objectives:

1. Prevent climbing,
2. Organize the deformations in the trainset, by reinforcing the passenger areas and the driving cabs and by arranging deformable areas without passengers or personnel, intended to absorb the energy of impact while at the same time peak-limiting the accelerations to which passengers are subjected.
3. Balance the strengths, of the upper and bottom parts of the car body.
4. Improve the assembly modes, especially the rigid fitting of the wall on the frame and the welds of the stainless frames (continuous welds required for all frame parts).

2.2 DUPLEX TGV trainset

2.2.1 Reference accident

The only answer was to base ourselves on the investigations conducted after a real accident with a TGV-PSE train. We will briefly outline the circumstances surrounding that accident. The collision occurred on a grade crossing in Voiron (French department of Isère), between the Paris south-east TGVset N° 70 providing a service between Grenoble and Lyon and an "exceptional consignment" truck transporting a rigid, 60-ton block, the truck itself weighing 20 tons*. The speed at the moment of collision was 110 kph (70 mph). The grade crossing (on which this type of oversized traffic was actually prohibited) was located at the end of a curve. It was visible from about 250 m - too short a distance for the driver to be able to evacuate the cab. The impact caused the rigid block to be ejected 30 m from the crossing, between Track I and Track 2. The damage suffered was as follows: the power car buckled at the front; the power car frame was hardly deformed; the driving cab was crushed and the back of the power car also buckled. The set of trailer cars behaved well, both in respect of the frames and of the interior fittings. The front of the leading trailer suffered very slight deformation. Unfortunately, this accident was fatal to the driver, who was crushed in the driving cab. The circumstances surrounding this accident can no doubt be considered to be the worst that can be envisaged, hence our choice of it as a "reference collision".

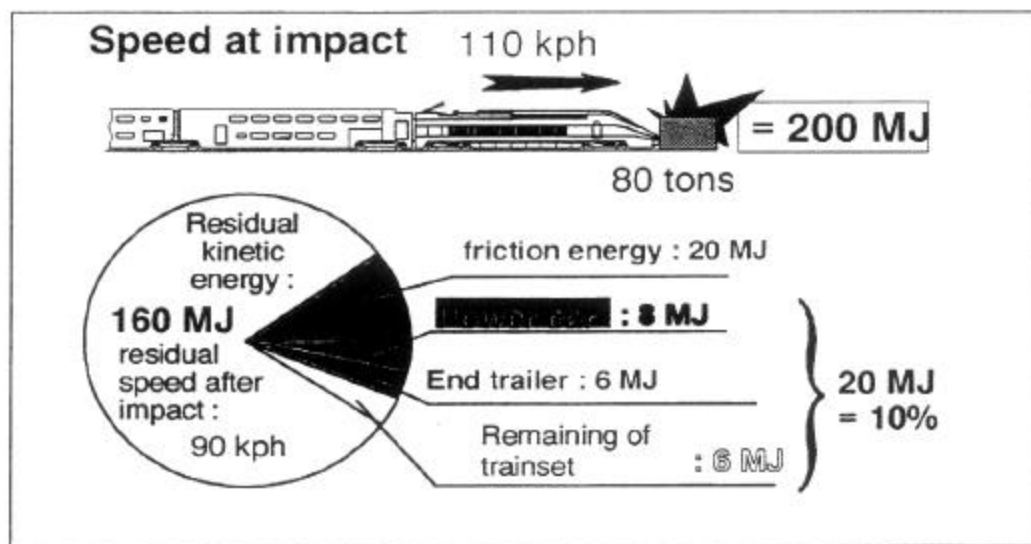

The technical specifications of the TGV DUPLEX were therefore written such that, for an accident under similar conditions, the set of trailers behaves at least as well, with a further objective of substantially improving the power car's behaviour.

(*) Translator's note: weight figures are in metric tons.

2.2.2 Energy distribution along the trainset

The contractual load that must be withstood by the car body of the TGV-SE is the compressive load of 2000 kN on the frame specified in current UIC standards. These are minimum forces and no maximum force has ever been prescribed either by SNCF or the UIC. In fact though, what do we have? The front part of the power car framework, between the headstock to which the automatic coupler is fitted and the driving cab, is extremely stiff. All the areas through the length of the power car are also highly reinforced, given the heavy electrical equipment (transformers, motor block, etc.) installed there. The rear portion of the power car is a bit less rigid because of the lesser density of such type of electrical equipment. The weak points are all the areas of the cab up to the access door and the rear portion. The logical conclusion was to propose a better distribution of impact strength over the whole power car. It is on the whole impossible to modify the center portion due to the dual need to secure the electrical equipment and provide frames stiff enough to support them. There are therefore three areas remaining: the front of the power car, the driving cab and the rear of the power car.

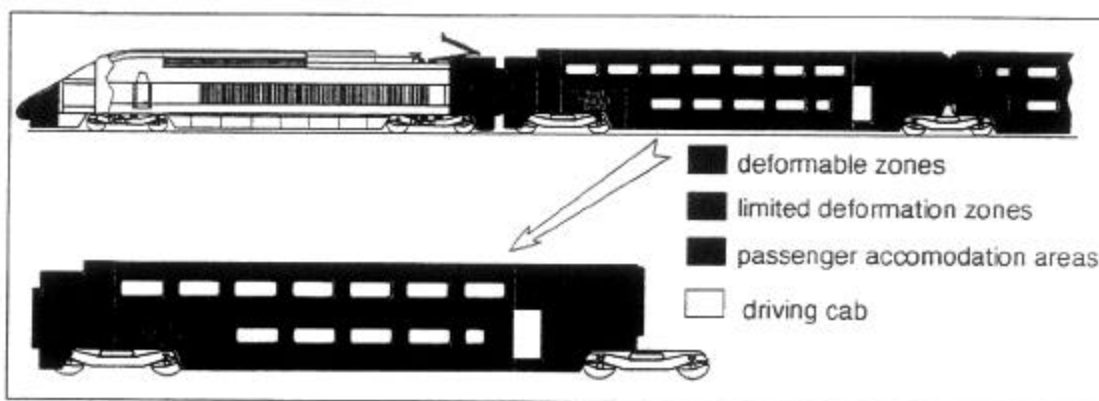

In the beginning of DUPLEX TGV project, passive safety concepts were only to be applied to end trailer cars, i.e. the trailers coming right after the power cars. The use of aluminium instead of steel has allowed a new design of the trailer car body. Therefore, from the very beginning end trailers cars were designed with the objective of absorbing 6 MJ.

DUPLEX TGV trainsets were to be powered by RESEAUX TGV power cars. Later on, SNCF has decided to order DUPLEX power cars. Therefore, energy absorption areas have been introduced provided minor changes were done to the existing traditional power car body.

2.3 XTER Diesel multiple Unit

2.3.1 Reference accident

XTER is dedicated to regional traffic and runs on tracks with a high number of grade crossings. SNCF has taken the collision of an XTER multiple unit, composed of two 64 ton coaches, striking a 15 ton truck on a grade crossing at a speed of 110 kph (70 mph) as the reference accident. Contrary to DUPLEX TGV, this reference accident is not related to any past accident.

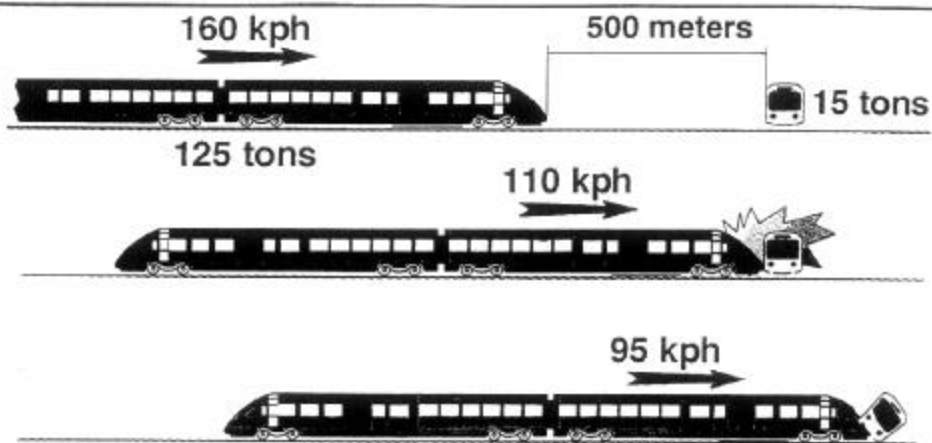

It is assumed that an XTER driver sees the obstacle on the grade crossing, then pulls the emergency brakes before he goes into the crash refuge. From a normal commercial speed of 160 kph (100 mph), the trainset slows down to 110 kph (70 mph) when it impacts the truck.

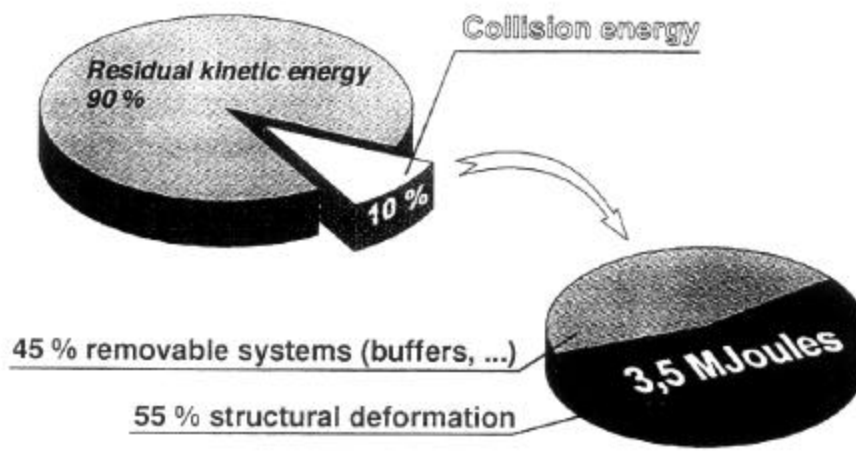

From train and truck masses, 12% of the 48 MJ train kinetic energy is dissipated into deformation. Assuming, that the train takes all of it, 5.8 MJ is necessary to be absorbed in the trainset.

2.3.2 Energy distribution along the trainset

XTER Diesel multiple unit is composed of two or three coaches for regional traffic. In that type of train, with passengers located all throughout, little passenger free space remains for energy absorption. Hence, energy can only be absorbed in two locations, at the front end and between the two coaches. Coming back to the reference accident against which XTER is designed, 5.8 MJ need to be dissipated in the trainset. It has been decided to share the 5.8 MJ in 5 MJ absorbed in the front and 0.8 MJ between the two coaches. Clues will be given later about the advantages of this uneven energy balance between these two energy absorption areas.



Energy absorbing areas Driver's survival zone Passenger areas

Following our design principles, deformations are banned from passenger areas. Therefore a high energy absorption is necessary in the front of the train for two reasons. The first one is that no space is available between the two coaches for the dissipation of a large amount of energy, which leads to the necessity of absorbing most of the collision energy in front ends. The second one is that passengers are situated right after the driving cab, and their protection requires a high energy absorption capacity at front ends.

Desirable length required for energy absorption is found from the front of the coach to a crash refuge situated inside the driving cab. The driving cab participates to the deformation process and the driver has to find shelter in the crash refuge. Stress is put on energy absorption modules that can easily be replaced after a collision. That is why, as will be described later, four energy absorption steps are distinguished. The first three steps are provided by replaceable modules, leading to minor repairs, the fourth one being the crushing of the driving cab. Pole vault effect is avoided by the retraction of coupling bar or automatic couplers inside underframes, and anticlimbing via ribbed shape contact surfaces of coach ends and front absorbers.

3. ROLLING STOCK DESIGN EXAMPLES

Passive safety design concepts have already been applied to three different types of rolling stock. Firstly on DUPLEX TGV, then on MI2N, double-deck electrical multiple unit commuter stock, and lately on XTER Diesel Multiple Unit for regional services.

How to transform the principles and objectives into precise technical specifications allowing the rolling stock to be defined and built ? Initially, TGV and XTER body structure must withstand the compressive load of 2000 kN on the frame specified in current UIC standards. In addition, maximum compressive loads have been prescribed to end underframes and end vehicle structures beyond which they undergo predefined crushing with optimum energy absorption. They result of a compromise between mean crushing levels, possible deformation length, energy absorbed and decelerations to which passengers are submitted

3.1 DUPLEX TGV trainset

The DUPLEX TGV is the first build rolling stock which conforms to these new principles of improvement in the field of passive safety.

3.1.1 The anti-climbing device of the TGV DUPLEX

The buffing and draw gear between the power cars and the end trailers of the previous generations of TGVs are UIC-type. In other words they have side buffers and a draw hook in the middle. This arrangement allowing, among other things, to quickly uncouple the power cars from the set of trailer cars, is indispensable.

The accident analysis as well as various full scale tests have shown that during a powerful impact the buffers, at the end of their stroke, can act as levers, lifting up one vehicle relative to the other and, due to this, offset the vehicle frames, so contributing to the above-mentioned climbing effect.

These two unavoidable facts prompted us to steer the technical solution of the anticlimbing device for the double-deck TGV (TGV-DUPLEX) to integrate the buffing and drawing function with the anti-climbing function.

The anti-climbing device diagrammed below fulfils the four following main functions:

- **Buffing while running.**
- **Buffer retraction.**
- **Energy absorption.**
- **Maintaining the vehicles vertically :** To limit the vertical displacements of one vehicle relative to the other, two types of buffer supporting parts were defined so as to provide mechanical stops additional to the body-to-body action, consisting of:
 - "male" supports fitted to the power car,
 - "female" supports fitted to the end trailer.

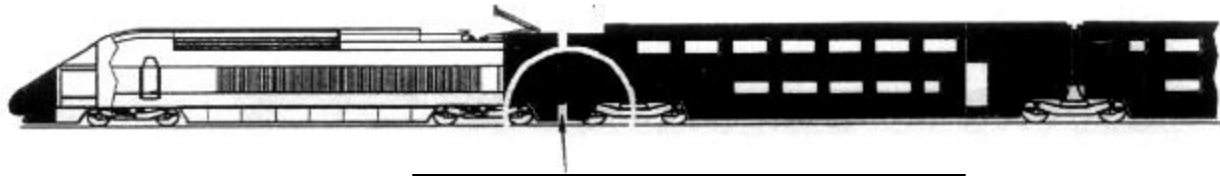

Anti-climbing device localization

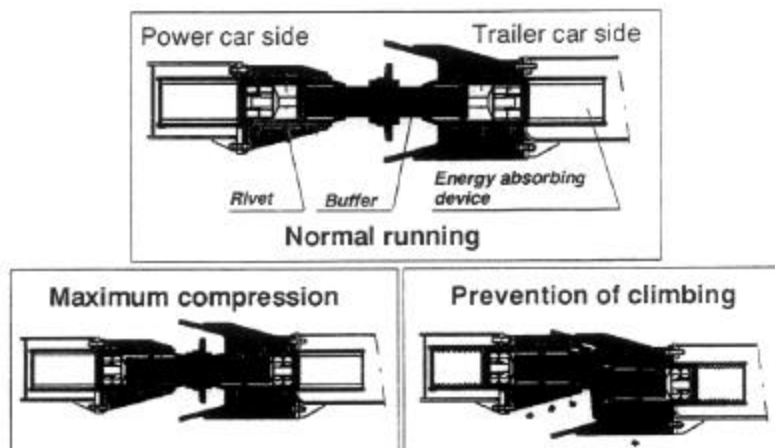

The clearance between male part and female part was engineered to allow for the maximum possible displacements of one vehicle relative to the other (to make up for sagging, wheel wear, etc.)

Different tests (with a press, on a buffing ramp, on line, under fatigue) were carried out by SNCF to validate all the functions of the new design. The tests established that the above-described anti-climbing device perfectly fulfilled all the specified functions. It will thus equip the double-deck TGV trainsets.

An anticlimbing system, with different deformation steps, also exists between every trailer. Fusible bolts fail to allow vehicle ends to get closer. The closing of the intertrailer gap crushes a structural absorber that absorbs some energy.

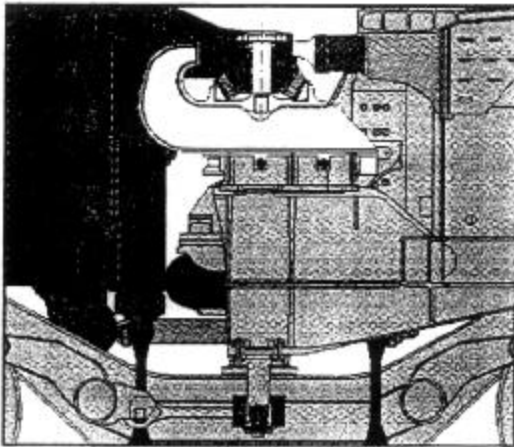

Intertrailer

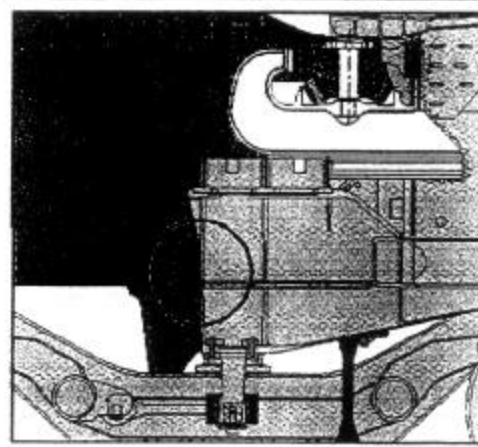

Closing of intertrailer gap

3.1.2 Design of DUPLEX TGV end trailer car body

In respect of the behaviour of the set of trailers of the crashed TGV-SE, an equivalent or better behaviour was required for the TGV-2N set of aluminium trailers. The TGV DUPLEX advantageously has a luggage compartment at each end trailer end, helping the introduction of energy absorption areas.

These two passenger-less areas are entirely suited to become energy absorption areas and hence to substantially improve the overall impact behaviour of the trainset. In the same way as for the power car, a minimum compressive strength was specified for these areas, that is the UIC contractual effort, and maximum forces beyond which these areas deform in energy absorption fashion. Likewise, the passenger area has been made into a sanctuary by on the one hand better distributing the mechanical strength over the total cross-section (this distribution being obviously easier given the double-deck design and the extruded aluminium frame) and on the other hand specifying a greater total strength over the passenger area as a whole: 5000 kN for the end trailer and 4000 kN for the intermediate trailer.

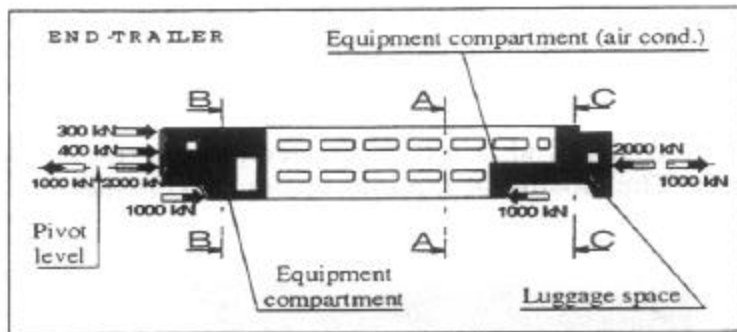

End trailer static strength loads

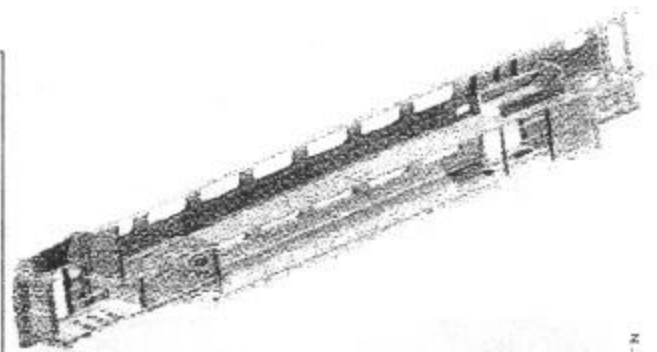

End trailer cross section

Elementary aluminium absorbers with thick sections (30 mm) have been designed in 5754 aluminium grade. A weakening in their middle cross section make them buckle with a virtually constant crushing force. Four rows of three absorbers, joined together by cross beams, and two side sills constitute the luggage underframe architecture. Overall stability is enhanced by different positions of the elementary absorbers in the luggage compartment underframe, rotated of 90 degrees.

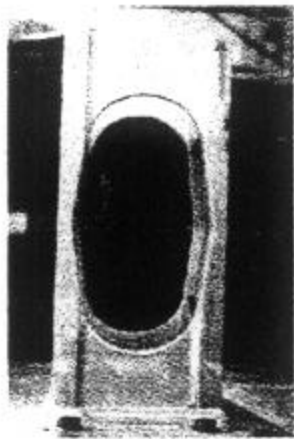

Aluminium absorber

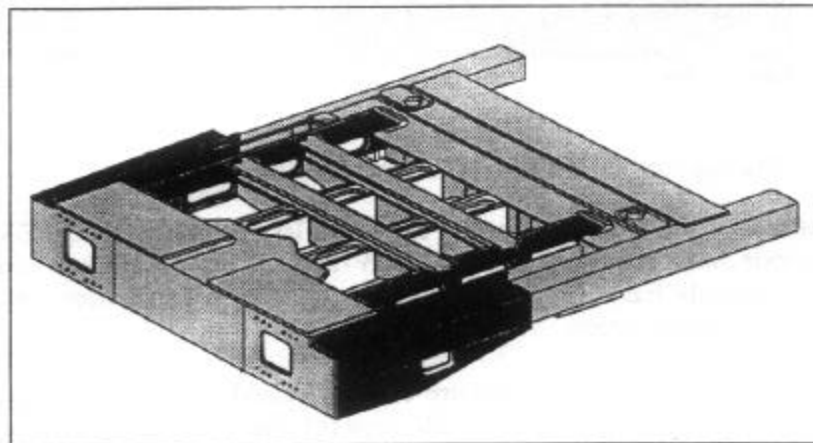

End trailer luggage compartment underframe

Side sills, designed to withstand static strength loads, could not absorb energy. They collapse very rapidly in order not to disturb the underframe deformation process. This is achieved by using 6082 aluminium grade, a material easily damaged when deformation starts.

Roof is made of thin aluminium plates which easily buckle. Aluminium absorbers are also integrated inside roof rails which allows some energy to be absorbed in the roof. Thus, rigid arches A1 and A2, which delimitate passenger area and the end of the car, remain vertical while deformation progresses because of a good balance between mean crushing force of the underframe and of the roof.

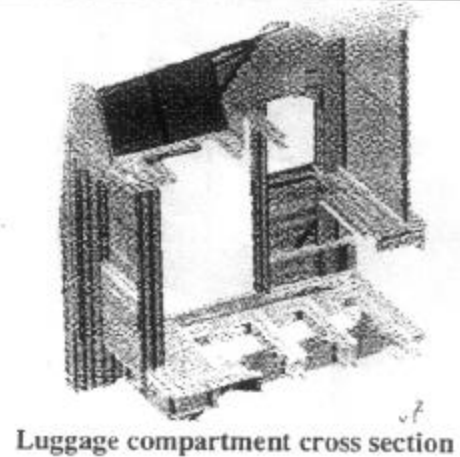
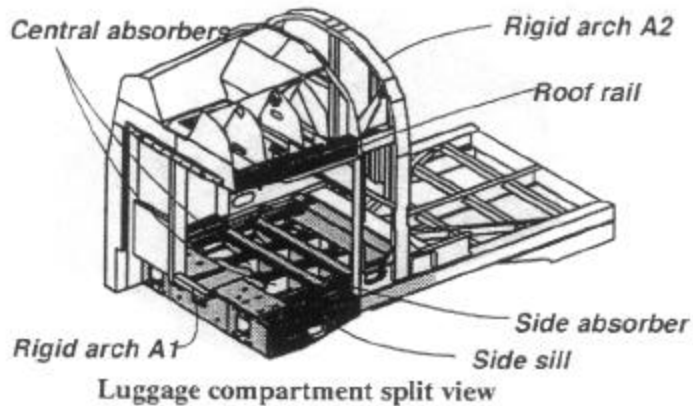

3.1.3 Design of DUPLEX TGV power car body

The driving cab has been designed as a protective zone for the driver, by adopting a certain uniformity in the proof loads it must withstand without deformation: frame built to withstand 3000 kN, load capability increased along the waist (700 kN to 1500 kN) and the rail (400 kN to 700 kN), overall compressive strength of 5000 kN between the energy absorption shield in front of the cab and the access door.

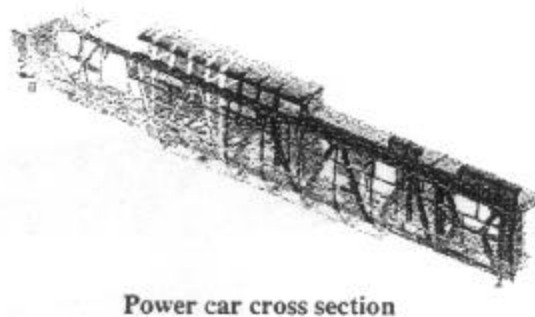
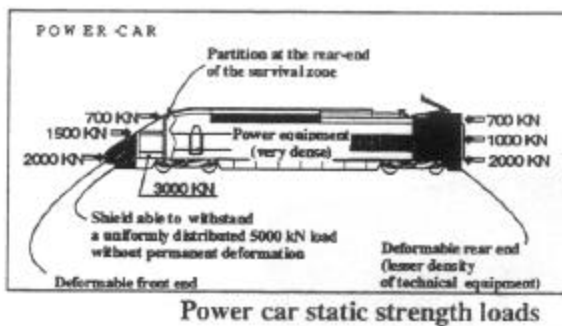

The new design obviously amounts to lowering the actual strength of the front and rear end of the power car and reinforcing only the driving cab.

Power car body is composed of three main steel grades E490D, E24 and E36. The two last steel grades are mainly used in deforming areas because of their lower yield stress and their ability to deform easily. Opposite to the deformation process retained in the end trailer design, i.e. global buckling behaviour, absorbers of the power car deform with local plastic buckling to absorb energy.

3.1.3.1 Driving cab

In front of the driving cab, energy is absorbed both in the underframe and in a honeycomb block. Three square tube absorbers with diagonal stringers constitute the underframe. The aluminium honeycomb block is protecting the whole surface of the cab shield..

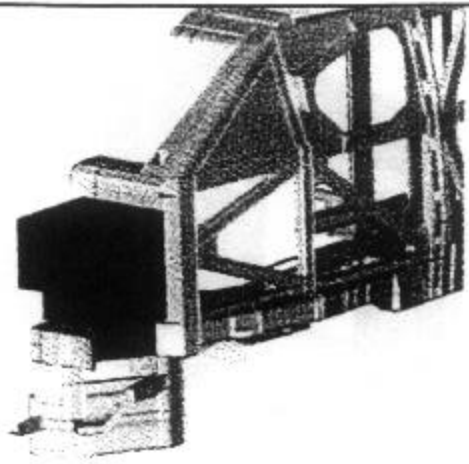

Driving cab cross section

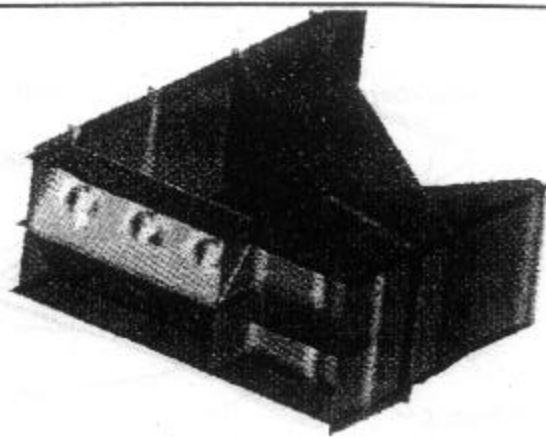

Central absorber of front end underframe

The driving cab is designed to withstand compressive efforts of the underframe and of the honeycomb block above it.

3.1.3.2 Rear end

The non cab end of the power car deforms only when end trailer strikes the power car. This end allows more space for energy absorption. Figure below of rear end cross section is helpful to understand the location of the three elementary absorbers in the car body. The anticlimbing device can also be seen.

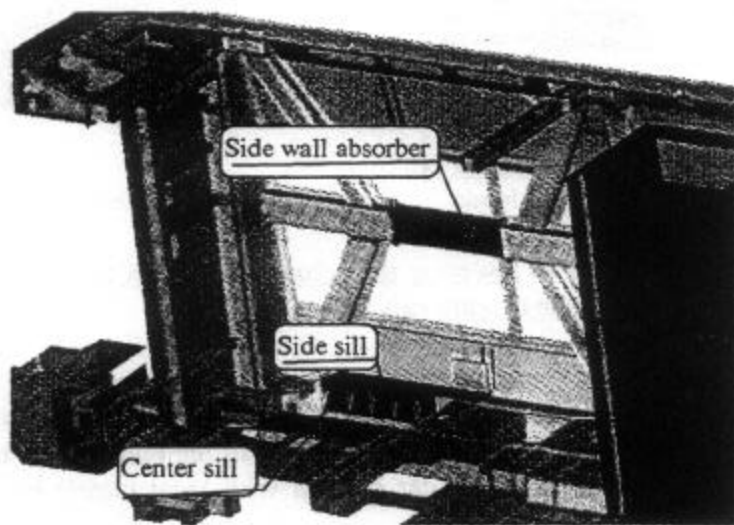

Power car rear end body

700 mm of side and center sill of rear underframe are designed to deform and absorb energy. These absorbers are composed of E24 and E36 steel grades. They result of a compromise between static strength loads requirements and suitable criteria for energy absorption. A side wall absorber is also integrated in the body.

Roof rail can not be designed to absorb energy, that is why it is weakened thanks to three holes guaranteeing its global buckling. Same applies to horizontal rails, which will easily buckle because of their open cross section, and will not stop the deformation process.

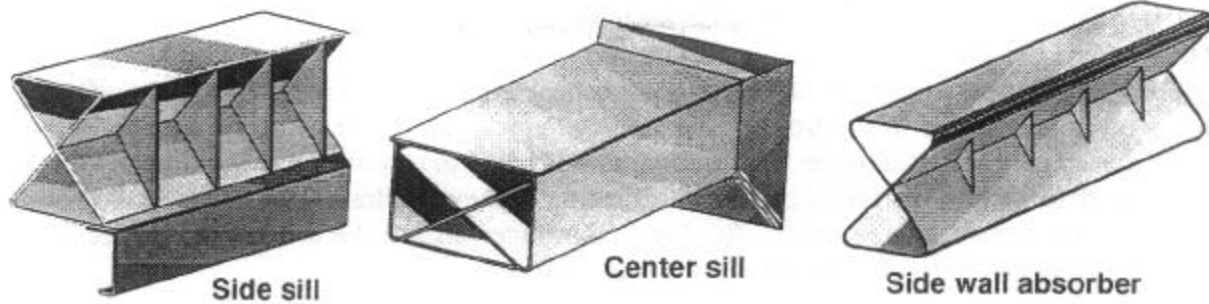

Great attention has been given to the location of weldings between the different sheets of an energy absorber, for them to remain intact when deformation progresses. Their design have been validated little by little, thanks to numerous impact tests. Any welding failure or too high mean crushing force have eliminated promising designs.

Rear end of the power car is designed in full compatibility with the end trailer. A same balance between mean crushing forces of underframe and roof, which is sustained by two side wall absorbers, ensures that vertical posts surrounding deformable areas stay vertical when deformation progresses. By doing so, whole car body stability is enhanced.

3.2 XTER Diesel Multiple Unit

XTER car body is made of stainless steel. continuously welded. Protection of the driver crash refuge and the passenger area is provided by a high energy absorption front end. Deformation process of this area is organised in 4 steps. The first one is made by the buffing characteristics of the automatic coupler. It allows reversible deformation up to a collision speed of 7 kph (4.3 mph). The second one, for speed collision up to 18 kph (11 mph), implies the fracture of fuse bolts and the crushing of a central composite absorber. During this step the automatic coupler glides into a drawer containing a composite absorber.

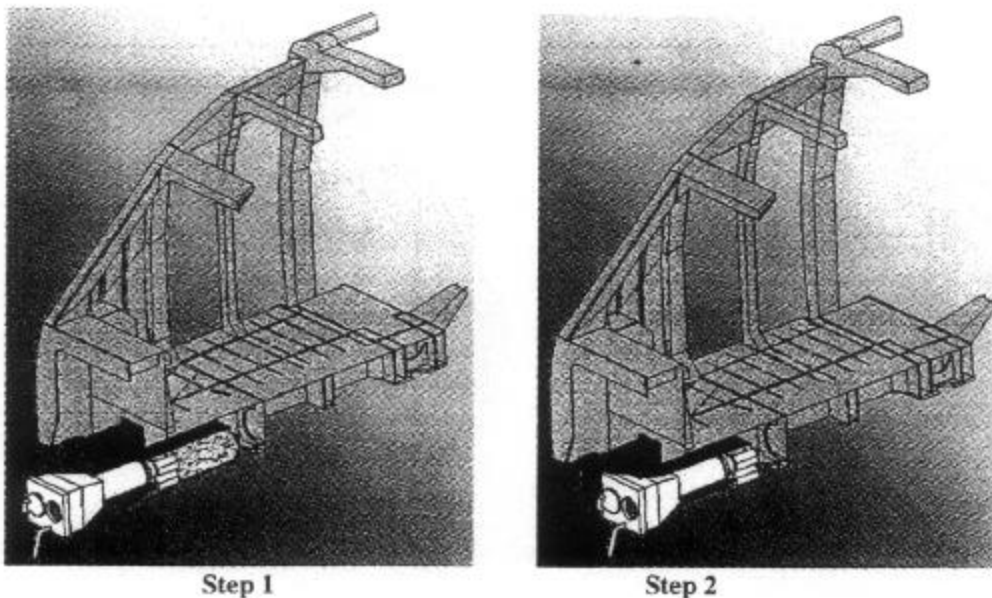

Third step is the deformation of two side steel absorbers for collision speeds up to 32 kph (20 mph). This deformation step allows full clearance of the coupler and anticlimbing is made by ribbed shape contact surface of step 3 absorbers. Until step 3, driving cab body remains intact, with minor repairs to the front of the leading vehicle. Step 4 deformation process is the deformation of the cab underframe. This underframe is made of a combination of thin and thick sheets. The deformation is stopped by the densification of the underframe absorber which leaves room to a crash refuge for the driver. Roof rail contributes also to the deformation process of step 4 which ensures the global stability of the cab.

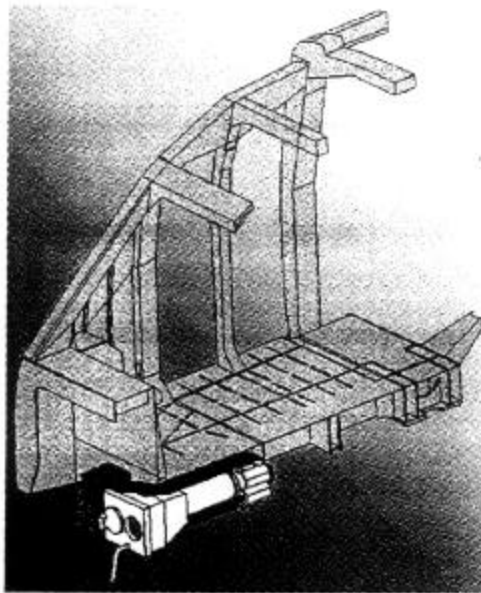

Step 3

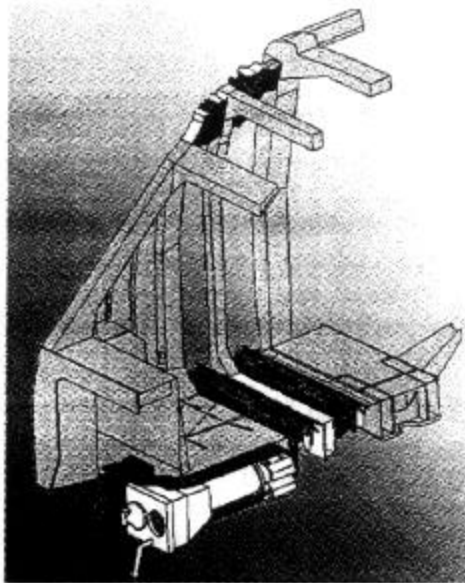

Step 4

The crash refuge can be seen in these drawings below, close to the panel between the driving cab and the passenger area.

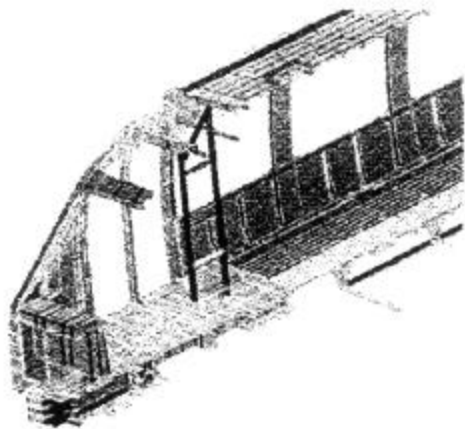

XTER half body

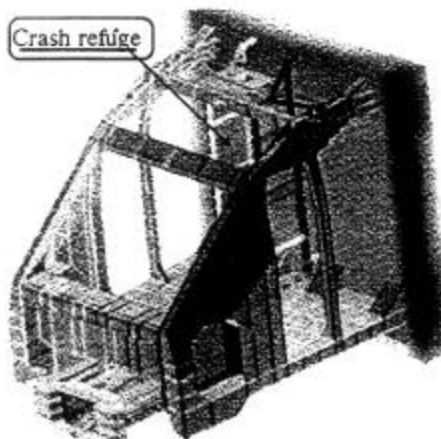

XTER Driving cab body

Coupling of the two cars is made by a bar. Anticlimbing is provided with the clearance of the coupling bar, in a two step scenario, so that car end walls come against each other. The coupling bar clears under rear car underframes when fuse bolts fail (step 1), then a composite absorber is crushed (step 2).

4. VALIDATION OF THE CAR BODIES

4.1 Methodology

SNCF in collaboration with rolling stock suppliers (GEC ALSTHOM, DE DIETRICH) have applied a step by step approach to test its design principles. Every absorber behaviour and its energy capacity are validated by full scale tests prepared with intensive numerical simulations. After that, integration of the absorbers in the underframe is tested. Then driving cab or rear end car bodies are tested before the full scale car body is crashed.

4.1.1 Numerical simulations

Numerical simulations have proved necessary in order to prepare all the collision tests required for the optimum design of the car bodies. Good software tools, like PAMCRASH or RADIOSS ..., allow the modelisation of most of test boundary conditions and lead to good predictive results ... provided they are fed with accurate data.

The initial step is the car body modelisation. It is a time consuming process, with car body discretisation up to 500 000 shells. This modelling has to start early and must adapt rapidly to any change of the car body design that unavoidably comes.

The most difficult thing is to find accurate data in order to model materials' behaviour. Static load stress-strain curves can easily be found for every type of materials. Most of the time these materials are strain rate dependent and stress-strain curves under strain rates loadings around 100s^{-1} are required. This strain rate level, situated at the upper limit for classic hydraulic testing machines and at the lower limit of Hopkinson bar technique, shortens the number of laboratories able to provide tests. Little is known about buffers or springs behaviour at different collision speeds. Honeycomb behaviour, which is very much dependant on the collision speed, is also an unknown to take into account.

An eternal come and go is made between tests and numerical simulations which give a good estimation of the car body behaviour under a collision. This knowledge is very important when one wants to extrapolate from car body collision tests to accident simulations.

4.1.2 Collision tests

This paragraph aims at presenting car body collision tests realised by SNCF on both DUPLEX TGV and XTER multiple unit.

Elementary absorbers are tested with an impact rig of 0.5 MJ capacity. Unfortunately this impact rig capacity does not allow to test the behaviour of underframes or bigger mock ups. That is why driving cab or a complete car bodies have to be tested on a rail track with stiffened ballasted wagon trainsets.

For multiple reasons, like safety, a speed limit on the test track, the need to get accurate measurements ... it is impossible to reproduce a real accident. SNCF approach for testing a car body with an energy absorption capacity W_1 is to reproduce a collision with this vehicle that allows the energy W_1 to be dissipated in it. It is done through a collision test that differs from an accident, by a different collision speed and different masses, but which dissipates the same energy W_1 in the vehicle. In other words, we can say that **collision tests** and **accidents** are **energy equivalent**.

Measurements of different parameters, like speed, force levels, accelerations ... allow to better understand a collision test. We also check that passenger areas remain intact after the test.

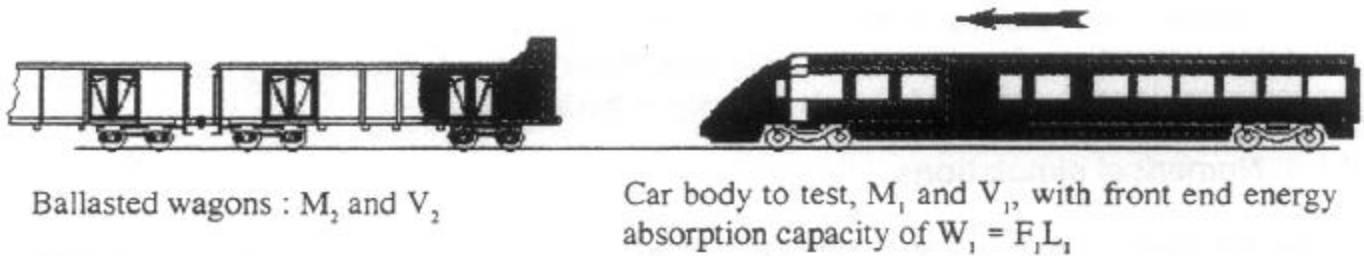

The above diagram models most of our collision tests. A single vehicle or a ballasted wagon trainset propelling a vehicle or a single ballasted wagon with a mock up welded at its end, having a total mass M_1 at a speed V_1 , striking ballasted wagons weighting M_2 at a speed V_2 . W_1 is the deformation energy that we want the car body to absorb during the collision. This energy W_1 can be simplified in a mean crushing force F_1 times a stroke L_1 . Energy absorbed during the

$$\text{collision test is } W_{\max} = \frac{M_2 / E_{cl}}{M_1 + M_2} = \frac{M_2 / M_1 + M_2 \cdot 1/2 M_1 (V_1 - V_2)^2}{M_1 + M_2}$$

We aim at finding ballasted wagons masses and collision speed so that W_{\max} is as close as possible to W_1 . Most of the time a good balance between multiple criteria we impose is to have an initial kinetic energy higher than W_1 and to impact a heavy ballasted wagon trainset (400 tons) at collision speeds around 40 kph (25 mph).

4.1.3 From collision tests to accidents

Although collision tests and accidents are energy equivalent, correlations have to explained between them. A first approach giving some clues about differences in force, acceleration levels... is done through a very simple modelisation that does not pretend to model an accident.

A comparison is drawn with a bodyshell structure, which is a power car center sill absorber submitted to two collisions. The first one is a collision at 145 kph (90 mph), modelling an accident, and the second one a collision at 50 kph (30 mph), representing an average collision test speed. Masses are chosen so that 0.2 MJ is absorbed by the center sill absorber, in order to fasten the simulations, though it can absorb a higher amount of energy.

Kinetic energy	Obstacle mass M_2 (t)	Obstacle mass M_2 / impacting	Collision energy W_1 / kinetic	Collision energy W_1
----------------	-------------------------	---------------------------------	----------------------------------	--

	(MJ)		mass M, (%)	energy ratio (%)	(MJ)
Accident	2	0.25	10	10	0.2
Collision test	0.27	6	250	70	0.2

The center sill absorber(80 kg) loaded with 2.4 tons (M₁), strikes a 6 ton (M₂) rigid obstacle at 50 kph (30 mph) or an 0.25 ton rigid obstacle at 145 kph (90mph). In both collisions the obstacle has no speed. Simulations give the same compressive force level applied to the absorber. At 145 kph shock duration is shorter but leads to a lower variation of speed, whereas at 50 kph we obtain a longer shock duration and a higher variation of speed. Shock duration and speed evolution combined together lead to a same deceleration during the two collisions. The very small absorber mass (2.48 tons), chosen only to provide an example, leads to high deceleration levels that are of course unrealistic. Independently of collision speed, the absorber undergoes same compressive forces and decelerations.

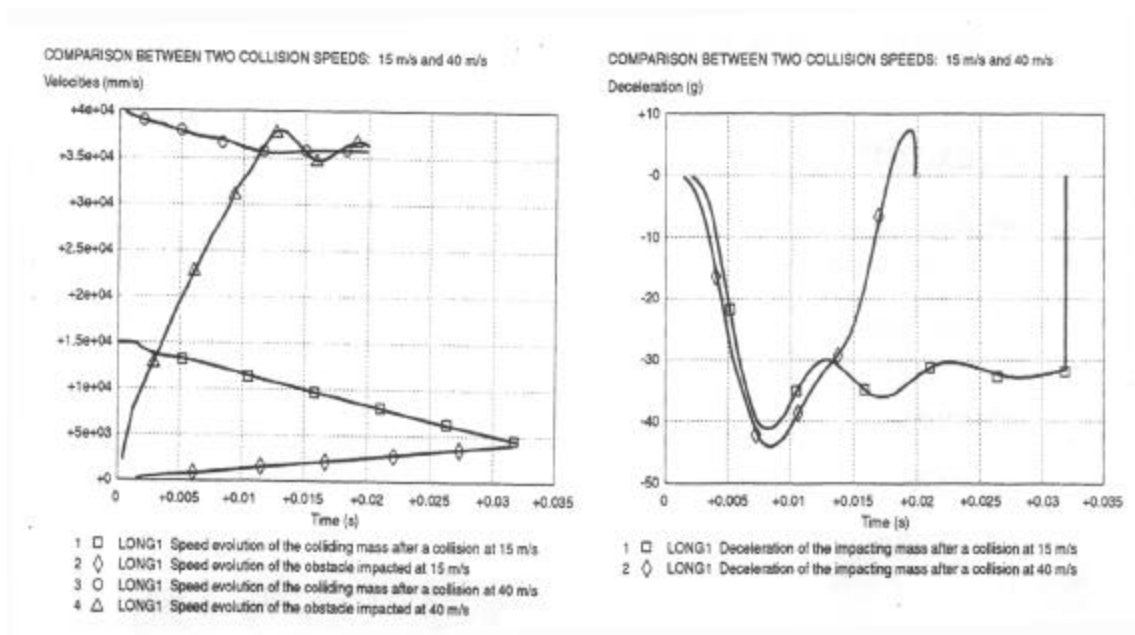

This example aims at proving that collision tests allow a good prediction of a car body behaviour in an accident, since force levels applied to it are the same. Deceleration levels depend on the mean force levels F_1 and on car body mass M_1 : $y_1 = F_1/M_1$. Therefore collision tests and accident deceleration are fully comparable when M_1 mass used in a collision test is representative of a real car mass or a real trainset mass. Most of the time lighter masses are used leading to higher decelerations during a collision test than in an accident, therefore adjustments have to be made to relate the two.

Nevertheless, one has to keep in mind that it is only a first step to accident simulations, next chapter will show other modelisation of accident, through lumped mass-spring models of trainsets. The final step being a full 3D modelisation of a trainset striking a real obstacle (train, truck....).

4.1.4 Conclusion

As a conclusion about our collision tests, we can keep these features in mind:

- 80 to 85% of the initial kinetic energy is converted into deformation.
- An average collision speed of 40 kph (25 mph) is realistic for car body ends, like end trailer of TGV, rear end of power cars ..., which are concerned with secondary collisions.
- Car body ends being situated in the front will of course undergo higher accident collision speeds. Nevertheless a collision test gives us very good hints about its crushing behaviour and is very helpful for numerical simulations at higher collision speeds.
- During the collision the car body is submitted to mean decelerations $Y_1 = F_1/M_1$.

4.2 DUPLEX TGV

This paragraph summarises all tests realised from single absorbers to full scale car bodies. Only final validations tests are detailed.

4.2.1 End trailer car

4.2.1.1 Absorbers

Impact tests were done on a test impact rig.

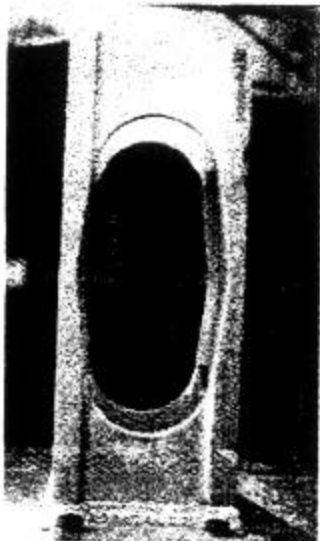

Undeformed absorber

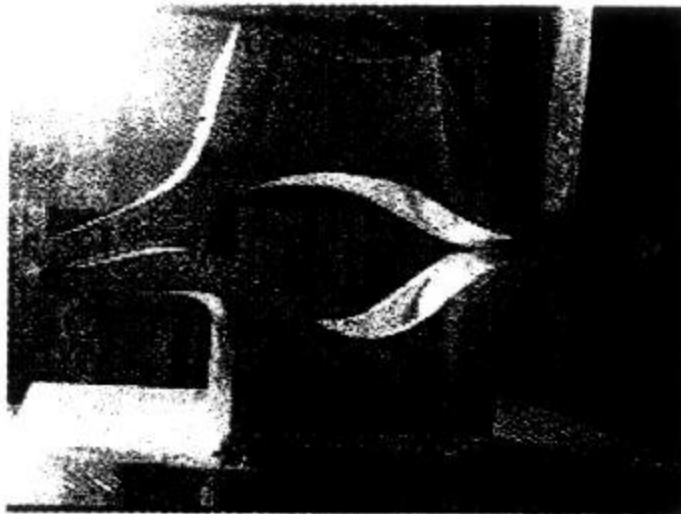

Deformed absorber

4.2.1.2 End underframe



Deformed end underframe

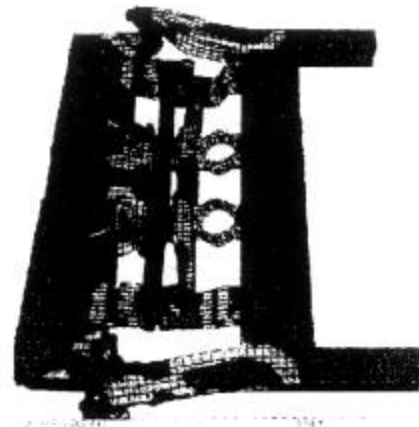

Numerical simulation result

4.2.1.3 Full scale car body

The collision test was made in February 1994.

	Kinetic energy (MJ)	Obstacle mass M_2 (t)	Obstacle mass M_2 / impacting mass M , (%)	Collision energy W_1 / kinetic energy ratio (%)	Collision energy W_1 (MJ)
Collision test	5.4	480	686	87	4.8

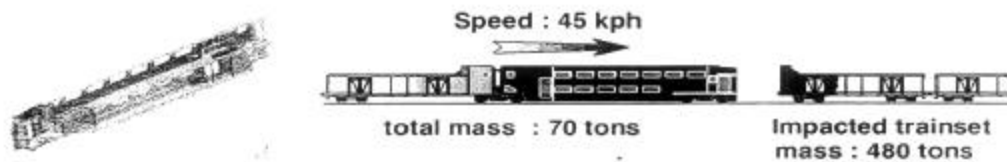

This collision test has demonstrated that the end trailer could dissipate 4 MJ in the luggage compartment with no deformation in the passenger area. Anticlimbing devices absorbed 0.8 MJ.



Numerical simulation result



Deformed luggage compartment

TGV intertrailer connections are very strong, therefore one can not consider an end trailer TGV car as a single vehicle. The mass of the 7 trailers has also to be taken into account. In that collision test, though the end trailer was loaded to its real mass, the 70 tons was 4 times less than the real mass of the 8 TGV trailers. It has resulted in a deceleration, only due to our mass configuration, that was chosen for the kinetic energy to be close to the collision energy, 4 times higher than the one we can foresee in an accident.

4.2.2 Power car

4.2.2.1 Front end underframe

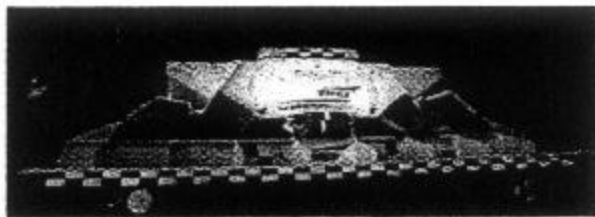

Deformed front end underframe

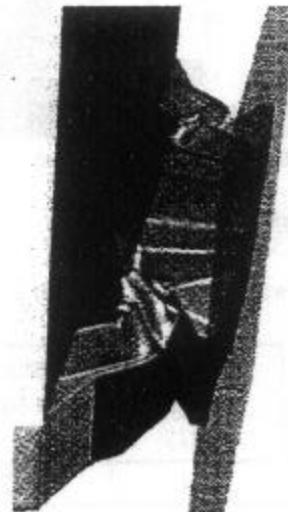

Time - 8.00832
Numerical simulation result

4.2.2.2 Rear end

This collision test, which took place in October 1995, reproduced the secondary impact of the power car rear end struck by the end trailer.

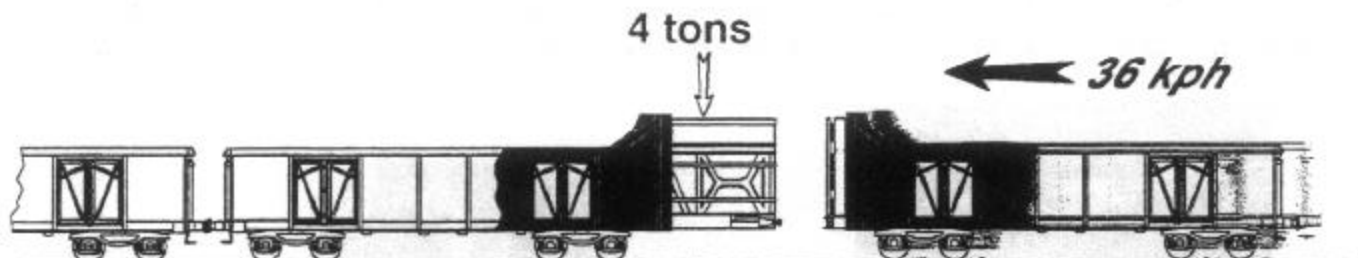

The rear end of the power car to be tested was welded to a standing ballasted wagon coupled to a wagon trainset. The standing trainset, of 404 tons (M_2), was impacted by a single wagon ballasted at 55 tons (M_1) at a speed of 36 kph (22 mph).

	K inetic Energy (MJ)	Obstacle mass M_2 (t)	Obstacle mass M_2 / impacting mass M , (%)	Collision energy W_1 / kinetic energy ratio (%)	Collision energy W_1 (MJ)
Collision test	2.7	404	720	87	2.3

Power car rear end absorbed 1.5 MJ and the anticlimbing devices 0.8 MJ.

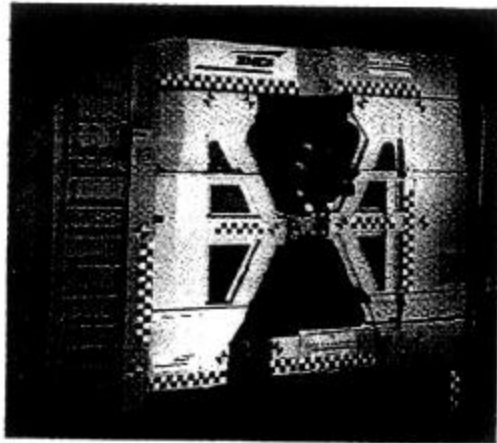

Deformed rear end

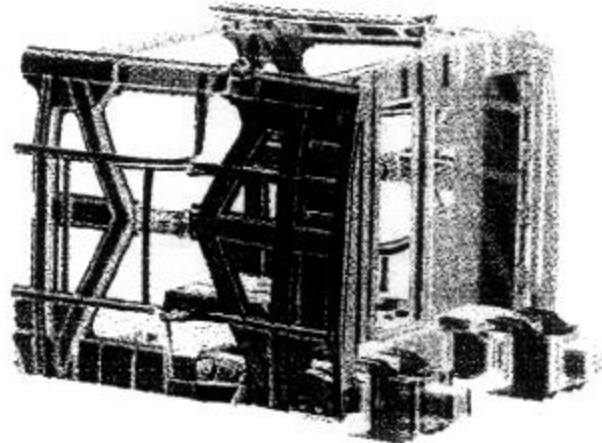

Numerical simulation result

The above view of the deformed power car rear end shows its good stability. Power car rear end could dissipated even more energy.

4.2.2.3 Full scale power car body

A power car body collision test is planned in 1996, where front and rear ends will be tested.

$V=36kph$

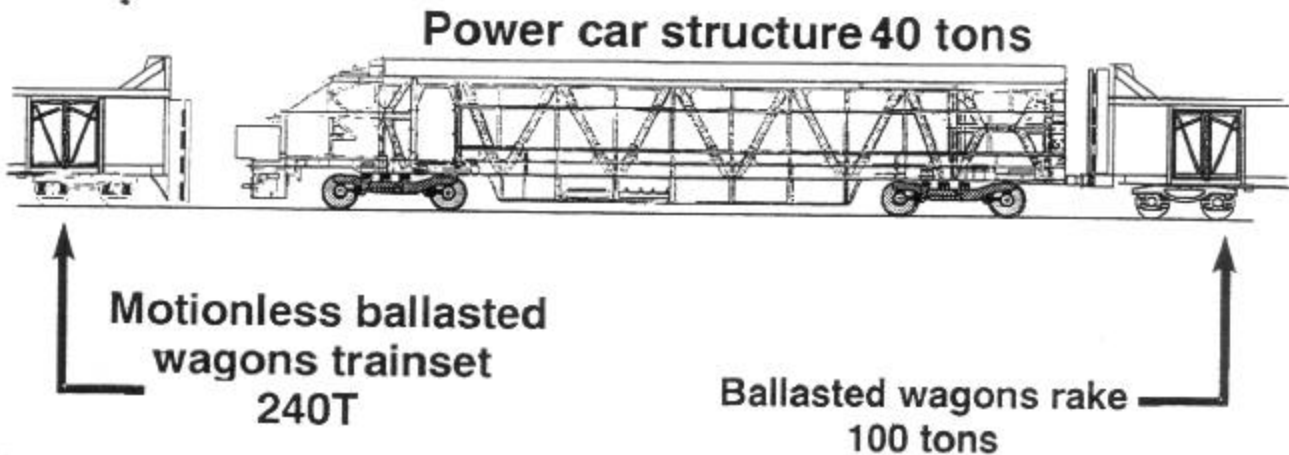
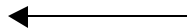

Power car body loaded to 40 tons coupled with a 100 ton ballasted wagon via an anticlimbing device will impact a standing 240 ton ballasted wagon trainset at a speed of 36 kph (22 mph).

4.3 XTER Diesel Multiple Unit

4.3.1 Step 2 and 3 absorbers

Step 2 deformation process is made by the crushing of a composite absorber. Contrary to steel absorber where residual length is close to 75%, residual length of this composite absorber is nearly 90 %. This ensures the full clearance of the automatic coupler inside the driving cab underframe.

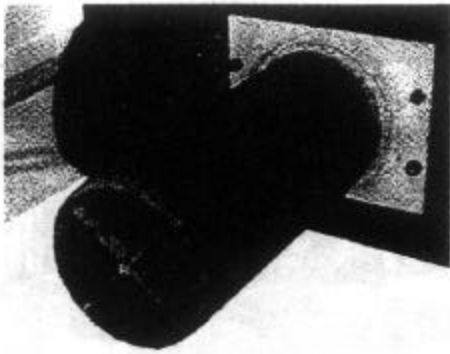

Step 2 composite absorber

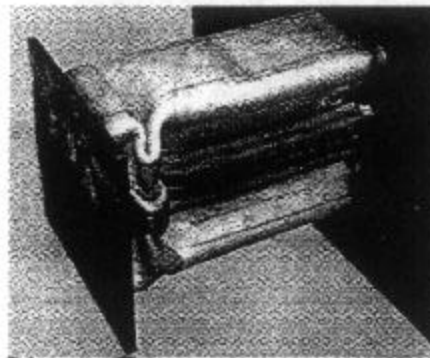

Step 3 steel absorber

4.3.2 Driving cab underframe

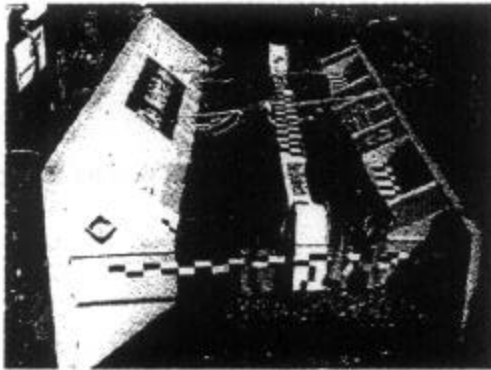

Deformed driving cab underframe

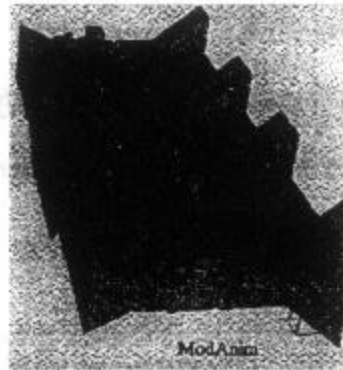

Numerical simulation result

4.3.3 Driving cab

A driving cab body with deformation step 3 and 4, welded to a 320 ton ballasted wagon trainset (M_2), was impacted by a 60 ton wagon (M_1) at a speed of 46 kph (28 mph). The collision test was made on July 1995.

	Kinetic energy (MJ)	Obstacle mass M_2 (t)	Obstacle mass M_1 / impacting mass M_1 , (%)	Collision energy W_1 / kinetic energy ratio (%)	Collision energy W , (MJ)
Collision test	4.8	320	500	80	3.8



Deformed driving cab

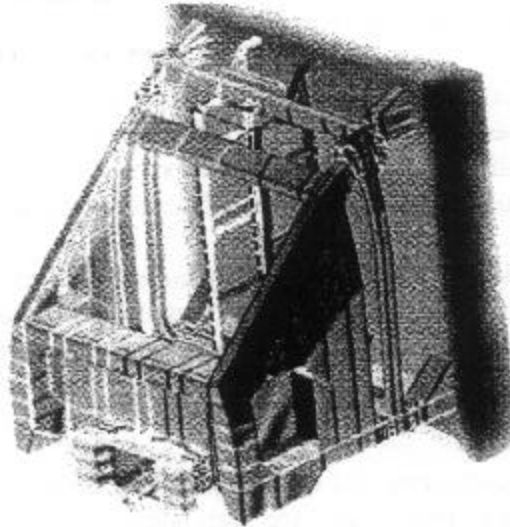

Numerical simulation result

4.3.3.1 Full scale car body

A car body collision test is planned in 1997, where front and rear ends will be tested.



5. FEED BACK ON DUPLEX TGV AND XTER

Two rolling stock projects DUPLEX TGV and XTER Diesel Multiple Unit are nearly over and time has come to analyse what we have been up to. Enormous time has been spent on the designing of absorbers, on the elimination of any welding failure, on their integration inside the car body respecting different criteria like static strength loads ..., making numerical simulation based on an accurate meshing of the car body .., preparing validation collision tests ... One must keep in mind that vehicles presented earlier have to be considered on the whole inside a trainset. We must give convincing proofs that deformation areas can work together or one after the other with no deformations in between. Most of the time the deformation of zone 2 and 3 are due to a secondary impact between second and first cars. Therefore secondary impacts, depend very much on collision speeds, on the distance between the two car ends and on the energy buffers absorb... making things difficult to design. Even with different energy absorption area capacities and their location in the trainset, one can wonder how far we are from being protected again different types of accidents?

5.1 Accident simulations

Numerical simulations, fed back by every test results, are the only way to do that sort of analysis. Lumped mass-spring models are used to discretise trainsets. These models need very accurate modelling and a good deal of experience not to be misled. Although they allow fast simulations results are bound to initial discretisation and modelisation assumptions.

Energy repartition in trainsets found by numerical simulations is compared to estimates given by mass ratio times kinetic energy. How complicated trainset effects may be, we show that a simple energy estimation allow good estimations of energy repartition.

5.1.1 Type of accidents considered

Level crossing collisions and also at front-end collisions, even if the occurrence probability for such a collision is very small, are simulated. The table above summarises the main difference between test, front-end or grade crossing collisions, i.e. the percentage of kinetic energy dissipated in the car body.

	Collisions tests	Front end collisions between same trainsets	Grade crossing collisions
Percentage of initial kinetic energy dissipated $\frac{M_2}{M_1 + M_2}$ (%)	80 to 85 %	50 %	5 to 15 %

Rigid obstacles like ballasted wagons are replaced by a truck in case of a level crossing collision. A simple modelisation of a truck is made which allows to absorb some energy in the obstacle. Though there is no reason for having different truck masses for DUPLEX TGV and XTER level crossing collisions, two truck masses are used which represent the same trainset-truck mass ratio.

	DUPLEX TGV	XTER
Grade crossing collision	A moving DUPLEX TGV trainset at 100 kph (60 mph) striking a 38 ton truck crossing a track at 20 kph.	A moving an XTER trainset at 110 kph (70 mph) striking a 15 ton truck crossing a track at 20 kph
Front-end collision	A moving DUPLEX TGV trainset striking a standing DUPLEX TGV trainset at 50 kph (30 mph).	A moving XTER trainset striking a standing XTER trainset at 60 kph (40 mph)

The following accident simulations aim at knowing the repartition of collision energy among the different energy absorption areas. We call first collision the collision of the front vehicle with the obstacle. Secondary collisions mean the collision of the second vehicle striking the first one. Focus is made on the collision energy repartition between first and secondary collisions.

5.1.2 Obstacle modelling

Front-end collisions are simulated with a moving trainset striking the same standing trainset. The standing trainset has brakes applied at full-service rate. The moving trainset has brakes applied at emergency rate. On both trainsets brakes are represented with a friction coefficient of 10%.

Grade crossing collision is harder to model. A friction coefficient of 10% is taken into account, which is probably not enough to model the friction energy dissipated by the truck pulled by the trainset. Two types of trucks are used.

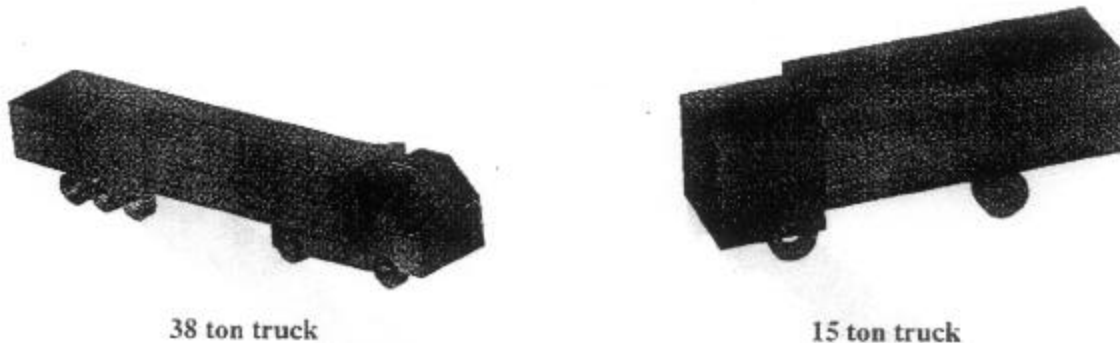

The 38 ton truck is composed of an 8 ton driving cab and a 30 ton trailer. In past accidents with such a truck, the trailer was impacted on one side and the link with the cab was quickly broken. This type of scenario is reproduced in the simulations.

Truck modelling is very simple and only devoted to absorb some of the collision energy. Other modelisations must be done with a finer truck discretisation. In particular, no attention is given to underframe heights differences between trucks and trainsets.

5.2 DUPLEX TGV

5.2.1 Energy distribution along the trainset

DUPLEX TGV can absorb 5 MJ in the power car, 4 MJ in the front the end trailer and 0.8 MJ in buffers at every vehicle end. The table below table summarises energy dissipated by different areas in the DUPLEX TGV.

	Power car front end	Power car rear end	End trailer car front end	Buffers or energy absorption between vehicle ends
Energy (MJ)	2.5	2.5	4.0	0.8

Finite element calculations performed on a fully equipped power car have shown the possibility to absorb an other 2.5 MJ in the equipment area. This deformation, though not 'organised' as it is in other energy absorption areas, leaves the power car body very stable with an undeformed driving cab.

5.2.2 Front end collision

A front end collision is considered between a 400 ton DUPLEX TGV trainset, composed of two power cars (68 tons) and eight trailer cars (30 tons), striking the same standing trainset at 50 kph (30 mph).

	Kinetic energy (MJ)	Collision energy / kinetic energy ratio	Collision energy (MJ)	Energy absorbed by moving train (MJ)	Energy absorbed by standing train (MJ)
Collision data	38.5	50 %	19.3	9.6	9.6



DUPLEX TGV front end collision

The key of the trainset behaviour is given by the repartition of the 9.6 MJ collision energy. The table below helps to understand how collision energy is shared between different vehicle ends, the collision being seen until the fifth vehicle in each trainset.

	Power car front end	Power car rear end	End trailer car front end	Buffers or energy absorption between vehicle ends
Energy (MJ)	2.2	0.8	3.2	3.4

Let us focus on the first collision, power car against power car, and on secondary collisions, end trailer cars against power cars.

5.2.2.1 First collision

Power cars ($M_1 = M_2 = 68$ tons) are coupled with the rest of the trainset via a hook. Side buffers fitted with anticlimbing devices leave the power car quite independent from the remaining of the trainset. Therefore first collision can be considered as a collision between two single vehicles.

The table below summarises the parameters of the first collision.

	Kinetic energy (MJ)	Collision energy / kinetic energy ratio	Collision energy (MJ)	Energy absorbed by moving power car front end (MJ)	Energy absorbed by standing power car front end (MJ)
Power car first collision data	6.6	50 %	3.3	1.65	1.65

Collision energy calculated above is 1.65 MJ whereas simulations find 2.2 MJ absorbed by power car front ends. This discrepancy indicates that a portion of trainset mass should be added to power car mass to make the two energies match together. Anyway, we understand that power car / power car collision, at 50 kph, is fully covered by front end energy absorption capacity of power car front ends

5.2.2.2 Secondary collision

Secondary collision between end trailer and power car rear end is even more tricky to evaluate, since rigid links between trailers do not allow to consider end trailer cars as single vehicles. Experience from end trailer collision test demonstrates that end trailer mass suitable for calculation must be increased of the mass of the seven following trailer cars. Secondary collision can be understood as a collision of eight trailers (M₁= 264 tons) on an obstacle being two power cars (M₂= 128 tons). Energy dissipated in car body ends and kinetic energy calculation are estimated by:

$$W_{max} = \frac{M_2}{M_1+M_2} E_{c1} = \frac{M_2}{M_1+M_2} \cdot \frac{1}{2} M_1 (V_1 - V_2)^2$$

Relative speed between M₁ and M₂ has to be estimated. Power cars V₂ residual speed is half collision speed. Trailer car has been decelerated to V₁ via the 0.8 MJ dissipated in the anticlimbing device. At that point simulation gives better estimates of speeds since they are non uniform of both power cars and trailers. Curves below show speed evolutions of end trailer and power car ends and give an estimate of 28 kph (18 mph) as a relative speed.

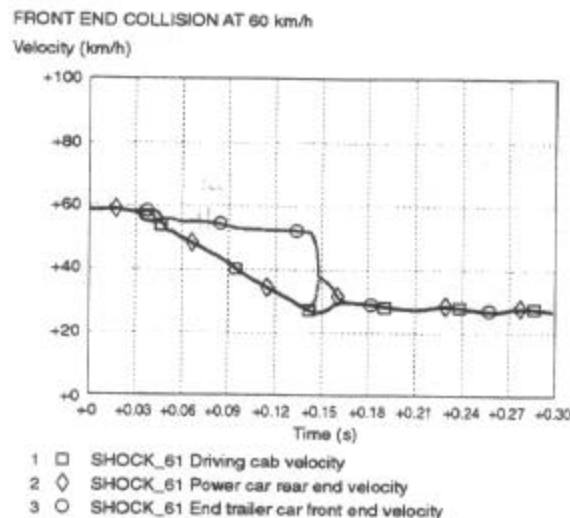

The table below summarises most data of the collision. We find 8.5 MJ of kinetic energy which are transformed in 3 MJ dissipated in power car rear end body and end trailer luggage compartment, where simulations find 4 MJ.

	Kinetic energy (MJ)	Collision energy / kinetic energy ratio (%)	Dissipated energy (MJ)	Energy dissipated in each power car / end trailer secondary collision (MJ)
Secondary collision data	8.5	35	3	3

Energy dissipated in each power car / end trailer secondary collision, 3 MJ, is well below 6.5 MJ maximum energy that is possible to dissipate in the rear end of the power car (2.5 MJ) and in the end trailer luggage compartment(4 MJ).

5.2.2.3 Conclusion of front end collision simulation

Four main features can be taken out from this simulations:

1. Deformation of front end and rear end of power cars are disconnected, the latter starts 50 ms after the first one finishes.
2. In secondary collisions, the articulated architecture of the trainset requires a high amount of energy to be dissipated in the rear end of the power car and in the end trailer luggage compartment.
3. Ratio between the energy absorbed in the first collision and the energy absorbed by the secondary collision is 0.70.
4. Energy, though concentrated in vehicle ends, shows an homogeneous repartition throughout the trainset.

In conclusion, DUPLEX TGV is well designed for a frontal collision at 50 kph since the energy which needs to be dissipated never exceeds the different energy absorption area capacities.

5.2.3 Level crossing collision

A level crossing collision is considered between a DUPLEX TGV trainset (400 tons) and a 38 ton truck at a speed of 100 kph (60 mph). TGV power car impacts the side of the 30 ton trailer which makes the links to the truck cab immediately break. Therefore DUPLEX TGV trainset only impacts a 30 ton mass.

	Kinetic energy (MJ)	Collision energy / kinetic energy ratio	Collision energy (MJ)	Energy absorbed by the moving train (MJ)	Energy absorbed by truck(MJ)
Collision data	151	7.0 %	10.5	8	2.5



View of the DUPLEX TGV impacting a 38 ton truck

5.2.3.1 First collision

Following the same reasoning applied to front end collision simulation example, first collision between power car ($M_1 = 68t$) and the truck trailer ($M_2 = 30$ tons) leads to a collision energy of 8 MJ. It is very difficult to set a realistic ratio for the repartition of collision energy between the truck trailer and the power car. We have made the assumption that 70 % of the collision energy is absorbed by the power car.

	Kinetic energy (MJ)	Collision energy / kinetic energy ratio	Collision energy (MJ)	Energy absorbed by power car front end (MJ)	Energy absorbed by trailer truck (MJ)
First collision data	26	30 %	8	5.5	2.5

It can be seen that the 5.5 MJ the power car has to absorb exceeds front end absorption energy capacity. This causes trouble when rear end of the power car and the luggage compartment of the end trailer can not relay the front power car end, as soon as absorption capacity of that area is outpassed. This is what happens here, therefore energy has to be dissipated in the equipment area.

5.2.3.2 Secondary collision

Secondary collision can be understood as a collision of eight trailers ($M_1 = 264$ tons) on an obstacle being one power car and the truck trailer ($M_2 = 98$ tons).

Energy dissipated in the car end bodies and kinetic energy calculation are estimated by:

$$W_{max} = \frac{M_2}{M_1 + M_2} E_{c1} = \frac{M_2}{M_1 + M_2} \cdot \frac{1}{2} M_1 (V_1 - V_2)^2$$

Relative speed between M_1 and M_2 has to be estimated. Power car/ truck trailer V_2 residual speed and trailer car speed V_1 can be found on the curves below. A relative speed of 18 kph (11 mph) is a good estimate.

LEVEL CROSSING COLLISION AT 100 km/h against a 38 t truck

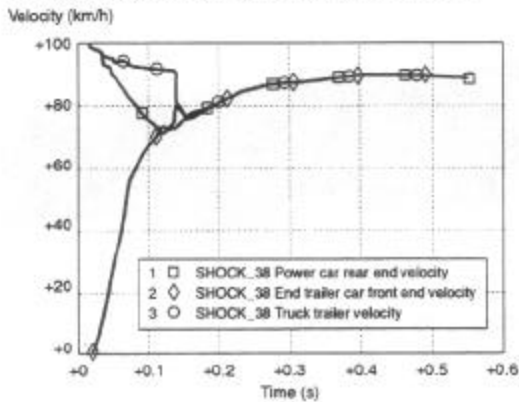

Velocity evolution

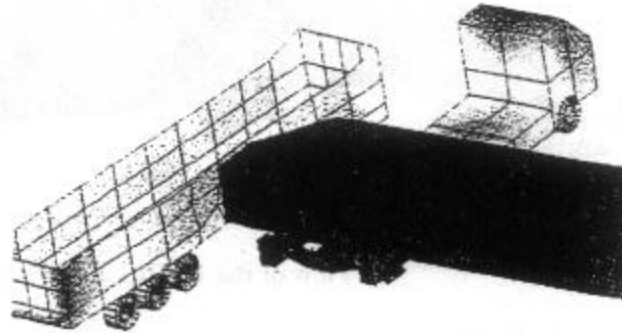

View of DUPLEX TGV driving cab

The table below shows that secondary collision does not require much energy to be dissipated compared to the situation of front end collision. It comes from a lower relative speed, due to a higher initial collision speed, and a lower mass to impact (98 tons instead of 136 tons).

	Kinetic energy (MJ)	Collision energy / kinetic energy ratio (%)	Dissipated energy (MJ)
Secondary collision data	2.6	27	0.7

Secondary impact energy is easily handled by car end bodies which are designed with higher energy absorption capacities.

5.2.3.3 Conclusion of level crossing collision simulation

Three main features can be taken out from this simulations :

1. Energy is concentrated in power car front end. Ratio between energy absorbed in the first collision and the energy absorbed by the secondary collision is 7.8
2. Secondary collision between end trailer and the power car does not require a lot of energy to be absorbed compared to what these areas can absorb.
3. First collision and secondary collisions are decoupled.

5.2.4 Comparisons between DUPLEX TGV behaviour under level-crossing and front-end collisions

The two previous simulations help us to understand the differences between front-end and level crossing collisions. They both imply approximately the same amount of energy to be dissipated in the trainset (8 and 9.6 MJ) with different repartition among energy absorption areas. Level crossing collision simulation results in a concentration of energy in the power car front end, whereas front-end collision energy is more evenly distributed in the trainset. These results are only applicable to articulated trainsets and for front-end collisions up to 50 kph.

	Level crossing	Front-end
Collision energy (MJ)	8	9.6
First collision energy ratio (%)	70	23
Secondary collision energy ratio (%)	10	41
Ratio of energy absorbed elsewhere (%)	20	35

Decoupling between first and secondary collision pleads for a higher absorption capacity on the front vehicle. This is true for level crossing collisions, where energy absorption must be concentrated in the front vehicle, and for front-end collisions at higher speeds (60-70 kph).

High collision speeds, for level crossing collisions, imply low secondary collision speed which combined to low obstacle mass result in a very few absorption need between first and second vehicle.

5.3 XTER Diesel Multiple Unit

5.3.1 Energy distribution along the trainset

An XTER trainset can absorb a total of 5.8 MJ. Only 3.5 MJ is made by structural deformation, the remaining 2.3 MJ are absorbed by couplers or removable devices.

	Total	Front end	Coupling bar
Energy (MJ)	5.8	5	0.8

5.3.2 Level crossing collision

A grade crossing collision between an XTER (123 tons) trainset and a 15 ton truck at a speed of 110 kph is considered.

	Kinetic energy (MJ)	Collision energy / kinetic energy ratio	Collision energy (MJ)	Energy absorbed by moving train (MJ)	Energy absorbed by truck (MJ)
Collision data	55	11. %	6	5.5	0.5

Energy absorbed by XTER trainset in this collision matches exactly the trainset absorption capacities.

5.3.2.1 First collision

First collision between front vehicle ($M_1 = 61.5t$) and the truck trailer ($M_2 = 15$ tons) leads to a collision energy of 4.9 MJ. We have made the assumption that 90 % of the collision energy is absorbed by the front vehicle.

	Kinetic energy (MJ)	Collision energy / kinetic energy ratio	Collision energy (MJ)	Energy absorbed by power car front end (MJ)	Energy absorbed by truck (MJ)
First collision data	27.6	20 %	5.4	4.9	0.5

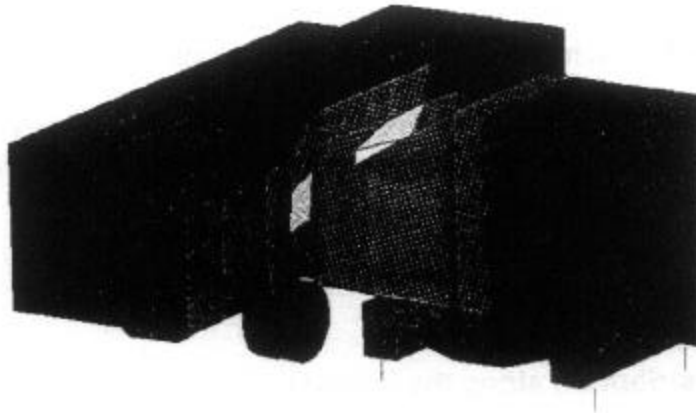

View of XTER driving cab striking the 15 ton truck

5.3.2.2 Secondary collision

Secondary collision of the second vehicle ($M_1 = 61.5$ tons) on an obstacle being the leading vehicle and the truck trailer ($M_2 = 76.5$ tons) at an estimated relative speed of 12 kph (8 mph), dissipates 0.2 MJ.

	Kinetic energy (MJ)	Collision energy / kinetic energy ratio (%)	Dissipated energy (MJ)
Secondary collision data	0.4	50	0.2

Each vehicle end has to absorb 0.1 MJ which is negligible. Secondary collision which occurs when first collision is over hardly generates any energy.

5.3.3 Front end collision

A front end collision is considered between an XTER trainset striking the same standing trainset at 64 kph (40 mph).

	Kinetic energy (MJ)	Collision energy / kinetic energy ratio	Collision energy (MJ)	Energy absorbed by moving trainset (MJ)	Energy absorbed by standing trainset (MJ)
Collision data	20	50 %	10	5 MJ	5 MJ

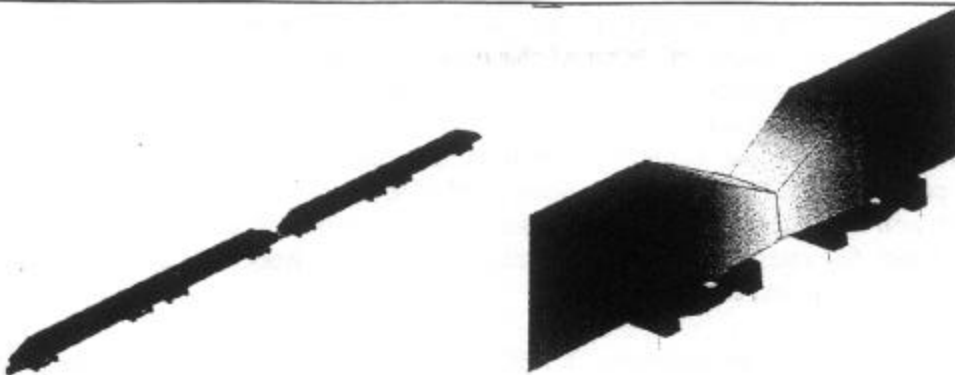

View of a front end collision of two XTER trainsets

The first collision does not exceed absorption capacities of front ends of leading vehicles. Because of a lower collision speed, compared with previous level-crossing collision speed, secondary collision occurs with a high relative speed of 16 kph (10 mph). This relative speed combined to an obstacle mass of 123 tons leads to a secondary collision energy of 0.5 MJ. Therefore each vehicle rear end has to absorb 0.25 MJ. Since no structural deformation is programmed in this area, deformation starts again in front ends of the leading vehicles to adapt secondary collision energy.

This simulation provides an example of a secondary collision which results in the deformation of front vehicle ends in order to absorb secondary collision energy. This is only possible when front end of XTER vehicle has got some energy absorption capacity left after the first collision.

5.3.4 Comparisons between XTER behaviour under level-crossing and front-end collisions

These two simulations develop nearly the same collision energy, 5 MJ to 5.5 MJ.

	Level crossing	Front-end
Collision energy on XTER trainset (MJ)	5.5	5
First collision energy ratio (%)	83	74
Secondary collision energy ratio (%)	2	10
Ratio of energy dissipated elsewhere (%)	15	16

No difference between the two collisions are seen in the above table. Front end of the vehicles are designed to absorb first collision energy and even all of secondary collision energy, which is the case of front-end collisions only. This works well if the first collision does not exceed front end capacities, which is the case of our examples.

5.4 Accident simulation conclusion and future design trends

To design a vehicle with many energy absorption areas located throughout the train is a valid approach. Being sure that deformations are only located in these areas is a very difficult task. It is untrue to think that a trainset designed with 10 MJ of energy absorption capacity throughout the trainset can face every 10 MJ collision energy accident. Trainset mass, links between coaches lead to various energy repartition in the trainset depending on accident type.

Apart from front end energy absorption areas, other energy absorption areas of the trainset are activated by secondary collisions. Most of the time, secondary collisions which also generate some energy to dissipate, occur very late. Thus deformation does not naturally switch from the front end of a vehicle to its rear end as soon as front end energy absorption capacity is exceeded. If it is difficult to be sure that rear end deformation can relay front end deformation, the contrary is always possible. In XTER trainset secondary collision energy is absorbed in front end area. This works well if the first collision energy does not exceed front end capacities. Therefore, in order to warrant full integrity of passenger areas of a vehicle, front ends must be designed to absorb a bit more than first collision energy.

The two rolling stock design examples, XTER and DUPLEX TGV, have been designed with reference to a level crossing accident. Previous simulations have shown that front-end collisions up to 50 kph (30 mph) could also be faced by these trainsets without redimensioning energy absorption areas. On DUPLEX TGV, if the level crossing accident considered underlines a lack of power car front end absorption capacity which has been explained, passengers situated 20 meters away from the collision are well protected.

SNCF, through its experience from past accidents and the development of DUPLEX TGV and XTER, favours trainsets with strong front end energy absorption capacity. An amount of 5 MJ on the front end of the leading vehicle is thought necessary and it seems to be a maximum of what it is technically possible to design. Other areas have to be dedicated to energy dissipation, with variable capacities depending on the type of trainset.

6. CONCLUSION

The definition of one reference accident, or several accidents is a difficult task. In addition, this definition may very likely evolve with the years. In fact, we need to analyse past accident data base through planned active safety improvements. By doing so, some accidents can be eliminated provided active safety measures have been taken, which guaranty this accident never to happen again. Nevertheless, several reference accidents will probably still be worth accounted for instead of a single one. Since every accident type requires different need for energy absorption, compromises have to be found.

An early design of passive safety is necessary, which does not lead to mass or cost increase. Maximum compressive loads have been prescribed to sanctuary areas beyond which vehicle ends undergo predefined crushing with optimum energy absorption. Reinforcement of passenger accommodation areas or driving cab are balanced by a lower vehicle end resistance through deformation controlled process.

SNCF has made a great number of collision tests prepared with intensive numerical simulations. Evolution of numerical tools allow an accurate modelling of car bodies. Future rolling stock crashworthiness ability could only be checked thanks to numerical simulations, and crash tests could only be done upon absorbing components.

Deceleration levels are an important feature to consider, and design concepts aim at lowering them. Biomechanical injury criteria must be defined to measure the consequences of a collision on passengers and crew. This is wide field including modelling of interior fittings or airbag integration for driver protection... a subject on which SNCF is planning to put the stress.

NEC Trainsets - Practical Considerations for the Introduction of a Crash Energy Management System

FRANK CIHAK: We're a bit behind our schedule so we'll pick up right away. The concluding presentations this afternoon will be on the Northeast Corridor Trainsets, Practical Considerations for the Introduction of a Crash Energy Management System and Bombardier has organized a superb team of presenters for this.

The three presenters are: Frank Duschinsky, Bombardier transportation equipment group, he is the Director of Engineering for the Northeast Corridor project and he has a master's degree in mechanical engineering from the Czech Technical University of Prague and brings 30 years of engineering experience, over 15 years in the railway industry and has five years as being responsible for coordination of Bombardier's engineering activities on the Eurotunnel shuttlecars, which are quite innovative designs and merit your attention.

Second, will be Daniel Palardy, Bombardier structural manager for the Northeast Corridor High Speed Trainsets. Comes with a Bachelor of Science from Sherbrook University, 15 years of experience and 10 years with Bombardier and there he's worked on such different things as the Disney Mark VI monorail, Eurotunnel tourist cars and commuter cars.

And thirdly, Larry Kelterborn, who graduated from the University of Waterloo with a Bachelor of Applied Science and Mechanical Engineering and has a Master of Applied Science in Mechanical Engineering, where he majored in materials and stress analysis. Larry had worked previously at Defasco as design engineer from 1976 to 1982 in the product development department. He since has started his own consulting business in 1982. He is currently president of LDK Engineering, Inc. Larry has been a technical consultant for Bombardier for many years and he currently represents Bombardier on the FRA Committee for Passenger Equipment and Trainset Standards for both Tier 1 and Tier 2 equipment and is also working with Florida DOT Fox and the FRA on establishing a rule of peculiar applicability [laughter] for the TGV system in Florida. So I'll let Larry explain what all that's about.

And now we'll start with Frank Duschinsky.

FRANK DUSCHINSKY: Good afternoon, everybody. As carbuilders, we are very pleased to be here. Bombardier's the largest North American carbuilder and has also an important presence in Europe. Today we are going to speak about Northeast Corridor Trainsets and Practical Considerations for the Introduction of Crash Energy Management. Our presentation will have three parts. I will start by describing the industry context, a lot of which has been touched on by different speakers today and yesterday.

Daniel Palardy will address the design approach for the Northeast Corridor Project and Larry will conclude with some comments on the process of setting standards for CM, for crash energy management.

Crash energy management from the carbuilder's perspective is seen as an important aspect of the overall system safety design of the trainset. At this particular time we find ourselves in the midst of heightened awareness of crashworthiness concept benefits and a rule- making process which

will have significant consequences on the industry. It is therefore especially important not only to review the pure technical but also to review the practical consideration of its implementation in the context of the railway industry.

When addressing the objective of improved safety of transportation systems, it is self-evident that the prime solution lies in accident avoidance. We have heard it many times over the past two days. Originally this field was outside of the traditional carbuilder's sphere of activities. However, with the current trend towards the turnkey DOT type projects where new transportation systems are put in place, the number of carbuilder's which have become system providers are actually aware of accident avoidance as the principal system safety element. This element must remain in the forefront of any safety improvement thrust, including for existing nondedicated railway systems.

It may be appropriate to repeat some well known traits of the North American railway industry as a whole and of passenger railway equipment in particular. It is likely that even important changes in rolling stock equipment, especially in North America would have to be classified as evolutionary. And for good reason, revolutions are not a staple for this industry. Off-the-shelf products, especially for passenger equipment, are practically nonexistent. Even the most similar two acquisitions have an arm-length risk of changes.

Important series are usually intense, exception in hundreds of cars, suddenly not thousands or millions. Conservatism and service proven have served the industry for years and can be considered as a part of the tradition. The difficulties in raising capital for transportation systems or for rolling stock in North America are tremendous, a part of the game. And also, it does not matter how long it took to develop specification, raise the capital, or just decide to go ahead, deliveries were always required yesterday.

In this general context of industry where the lowest cost is a necessity, not only to win a contract, but also to insure the viability of passenger railway service, I would send two messages towards the rule-making process are extremely important: The regulations should be a consensus of achievable and proven requirements; and the second, the rules or standards should be clear with well-defined measurable criteria.

Just to give an example, to say that cars in an accident should stay upright and shall not jack-knife for instance, it's not really a rule. It is rather a desire or it can be considered as an assumption. These subjects will be addressed in more detail in the following sections.

Focusing on the high speed trainsets for the Northeast Corridor Project, we can appreciate the considerable challenge Amtrak had to have in order to reconcile the need for the immediate specification structural requirements with the impending rule process. Even so, the Amtrak specification requirements in our opinion, exceed the actual state of art in crashworthiness. A commendable effort to keep the requirements and criteria clear has been expanded. And actually, it is this quality of requirements which has permitted the necessary evaluation leading to our commitment to the specified levels of crash energy management. Daniel Palardy will explain to you now the design approach for the Northeast Corridor Trainsets.

DANIEL PALARDY: Good afternoon. As you all know by now, Bombardier and GEC ALSTHOM have been recently selected by Amtrak to provide 18 American Flyers' trainsets to be

used on the Northeast Corridor. Bombardier and GEC ALSTHOM will design the American Flyers as a custom design, according to Amtrak's specification requirements.

We therefore have the task to develop the first crash energy management system for North American application. As you all know, crash energy management system is there to maximize crew and passenger safety in the event of a collision. The crash energy management system for the Northeast Corridor will be based on the technology developed on the TGV 2N or the TGV DUPLEX like presented by the SNCF people earlier.

Although materials and shapes are different, their approach will be used. So the trainsets will be configured with a power car at each end, this helps to provide more crashworthiness for the unprotected passengers' compartment. The trainset will also use semi-permanent coupler arrangement with shearback drawbars. This is an antidote to the anticlimbing arrangement and also to minimize the possibilities of jack-knifing.

This trainset will have high structural strength in occupied passengers' areas and crew cab and control crushable zones in the unoccupied space or low-density passenger space of the car body. These zones are designed to absorb a portion of the kinetic energy associated with collision. The American Flyer trainset will be built in accordance with the Amtrak specification, which defines both the minimum structural static load as well as the minimum amount of the energy to be absorbed by controlled structural deformation in the various parts of the trainset.

The Amtrak specification is really a mix of the French and the British experience, and also the North American rolling the way they are today. The current North American requirements we have to meet are 49 CFR 229.141, the ARS 034, which is 800 kips buff load, and the ARS 580 crashworthiness standards for locomotive. In this specification, there's also a collision scenario that has to be met. We're talk more about it later.

Dr. Cliff Woodbury talked quite in detail this morning about different loadings that have to be applied, the static loading that has to be applied on the cab refuge structure in front of the power car. Just to maybe come back to one of the points he mentioned, is we have to meet a total of 2.1 million pounds at the bottom of the collision post and corner post and this without exceeding the yield limit of the material. Same thing, at the roof level, we have to meet 310 kips of load and both those load cases will have to be tested.

For the power car rear structure, those are pretty standard requirements, with 300 kips at the bottom of the collision post and 150 kips at the bottom of the corner post, longitudinally and transversely.

If we look at the passenger car and structure, again we have the 300 kips load at the bottom of the collision post, also at the inner corner post we have to meet 200 kips compared to 150 kips at the extreme corner post. This requirement here is something new, so it's exceeding the regular requirements.

In terms of crash energy management systems, in terms of megajoule to be absorbed in a controlled manner in the different locations of the trainset, we need to absorb eight megajoules in the power car, five of which are located in front of the cab refuge and the other three megajoules is in the back of the power car. Five megajoules has to be absorbed in the front of the cab

adjacent to the bar car and for all the other ends, we have to meet the requirement of two megajoules. All these megajoule have to be absorbed in a controlled manner, which means that there will be structural elements specifically designed with known force displacement characteristic, in order to prove that these megajoules are met.

Now, as I was mentioned earlier, there's also a collision scenario to meet. If we consider at 30 miles an hour a moving trainset impacting a stationary trainset, the maximum acceleration that the passengers could feel is 10g and the secondary impact that the passenger will have with the back of the seat in front of him, the speed has to be less than 25 miles per hour.

In order to meet these requirements we have to produce a trainset collision survivability plan. The objectives of this plan are mainly, in order to maximize the safety of the crew and the passengers, we have to properly locate the absorption zones, minimize acceleration levels, and as I was mentioning earlier also, we have to maintain anticlimbing capability all the way through the collision and also try to minimize the risk of jack-knifing.

If we now talk about the design process as an overview, obviously we first review specification requirements. We go and develop the train layout and configuration, we'll identify areas for crash zone, from that we'll do preliminary analysis on a force of 1-D models. Then we'll do design of car bodies and energy absorbing components. Later on, we go into a phase of optimization and integration of the car body and absorption structure and finally evaluation of the design.

If we look a little bit more into details of the design process, in addition to meeting the structural and crash energy management demands, consideration must be given to providing a trainset that is functional. Such limitation as a restraint on vehicle weights, drop banking clearance requirements, location of passenger and crew space, positioning of doors, windows, roof-mounted units, all impact on design and location of crash zones.

So in the design process, as I mentioned earlier, we first go through the location of crash zones, we'll define force displacement characteristics for each one of those zones and then we'll do 1-D model solutions. This usually takes quite a few reiterations, but since this stage is fairly simplistic, we usually do it over a time stretch of maybe a month or two.

In the second stage of design we'll go into design of the car body and absorption zones. The design of the absorption zones has to take into account all the considerations mentioned earlier. But it's when we'll define where absorbing elements will be located, fuses member will be located, and for that we'll do 3-D linear finite-element analysis, in other words, static analysis to make sure that all those elements meet the static requirements North American wants. And also, in parallel to that, we'll do nonlinear analysis of each one of the absorbers. Throughout this process, we have to make sure that our arrangement is done in a way that the cross-section will be stable all the way through the crashing.

In the final phase, we go through a final validation stage. We'll do impact testing of full scale or as scale models of each one of the absorbers. Same thing with the fusible elements and we'll make sure that there's subsequent good correlation between tests and three-dimensional model analysis. This will be the base of the validation for a detailed model collision analysis.

After that we'll be conducting detailed three-dimensional nonlinear analysis of the car body extremities that comprise absorption zones to insure the adequate integration of each absorber with the surrounding structure, similar to what SNCF was showing earlier, as well as the people from British Railways. And obviously we'll go through the typical car-body static structural testing, in order to verify compliance with structural load requirements. So the above validation process bring us to a comfortable level of confidence as to the safety benefits arising from a trainset incorporating this crash energy management system.

The evolution of this methodology has been the result of the Amtrak specification, defining realistic and mostly, verifiable, requirements for a finished product. It is important for any future standards or specifications to follow this lead in providing practical and achievable guidelines for the industry.

LARRY KELTERBORN: Thank you Daniel. I guess the first comment I should make, just to clarify something--in Florida we're working on a rule of particular applicability and if it ends up as a rule of peculiar applicability we're going to be looking for a scapegoat. [laughter] But at this time, I would like to talk about setting standards for a crash energy management system. As most of you are aware, the reason that this symposium has been organized, and it was discussed by Grady yesterday, it was at the request of the FRA to bring the industry specialists together to provide answers to the many outstanding technical questions that have been raised in the area of crashworthiness. These questions have been raised by the industry to the structural and crashworthiness requirements outlined in the proposed standards that are currently being developed.

There is little doubt, as we have seen in the two previous presentations, that crash energy management can provide improved safety for some specific accident scenarios and up to some speed. However, quantifying the specific needs by which to specify such crashworthiness requirements in a new standard, consistent with the minimum structural requirements that are also being required by that standard, has proven to be a difficult task.

As previously stated by a number of people, a standard must be based on validated concepts that have proven to be effective. This requires all the steps and reiterations previously outlined in the crash energy management plan that Daniel just showed us and also that we saw from the SNCF this morning--it must be completed in order to demonstrate that such requirements can be indeed be met before making these requirements a law.

The most significant areas that have created major concern during a process of developing the new standards are firstly, and this has risen a number of times in this conference, the speeds of the accident scenario that we designed for and hence the amount of energy that we're looking to absorb by the structure, the ability to verify that the requirements are met, and finally the compatibility of these energy-absorbing requirements with both the static structural requirements proposed by the standards, and also the unoccupied space that's available in a trainset to absorb such energy.

I believe that we must be able to reach agreement on what can be achieved regarding these fundamental issues with today's know-how to help direct the approach that will be taken during a process of developing new standards in this country. Let me talk about each one of these briefly.

The first one, for what speed can the crash energy management system be designed to be effective? As we see in this slide, the kinetic energy of a trainset is proportional to the square of the velocity. So if we're looking at a trainset like the Northeast Corridor trainset operating at 150 miles an hour, we're looking at something like over 1200 megajoules of energy. Now to put this in perspective to something that most of us deal with, that's over 900 million footpounds of energy. So this amount of energy is equivalent to that which would be required to lift an entire trainset over 750 feet in the air. So except for small losses due to breaking or aerodynamic resistance, this entire energy would have to be absorbed in a trainset with a head-to-head collision of two trainsets running at 150 miles an hour. It's quite evident that there's insufficient capacity within the unoccupied areas of a trainset to absorb such enormous energies and it has been stated on a number of occasions all measures must be taken to insure that collisions cannot occur at these speeds. Our colleagues in France and the UK have based their crashworthiness specifications such as to protect passengers from much lower speed impacts and to provide protection at grade-crossing accidents where their studies indicate that the majority of all collisions occur. This has resulted in the requirement in the UK for about 1 1/2 megajoules of energy absorption at both ends of a trainset and 0.75 megajoules at each end of all intermediate passenger cars providing a total controlled energy absorption between 9 and 12 megajoules depending on how many cars on the consist.

Similarly, the most recent TGV trainsets in France, as we saw in the previous presentation, are designed to absorb about 14 megajoules of energy in the power car and the end trailer. About 8.5 megajoules of this is in controlled energy absorbers. In both of these cases it has been demonstrated through modelling and full-scale testing at speeds up to about 35 miles an hour that such magnitudes of energy can, indeed, be absorbed in a controlled manner.

To date, the proposed structural energy absorbing requirements for the new standards have been based on results of one-dimensional modelling analysis, using simplified assumptions and estimated crush characteristics. Extreme caution must be taken in using such models to make quantitative evaluations, particularly when the actual crush characteristics of the trainsets are not known.

The next slide shows the ideal force versus displacement characteristics for a trainset used in a recent analysis to support the new standards. I should just make a comment right here when I'm thinking of it, the paper refers to reference eight, which in our paper here, which is actually John Lewis's paper and we're not referring to John Lewis' paper, it actually should be reference eight, not reference seven, as the paper says.

The red-sheeted area, under this curve represents the energy that a one-dimensional model would assume could be absorbed by structural deformation in that model. It's extremely large. As a reference, the yellow curve on this figure over here shows the approximate force deflection characteristics in the corresponding controlled energy that's being built into the Amtrak high speed trainsets.

This next line shows a comparison of the energy absorbs versus the crush distance for the trainset analyzed in support of the standards and for the Amtrak high speed trainsets. Obviously, the model predictions show a tremendous difference in what can be absorbed by the trainset. It should be realized that the conclusions reached with the type of one-dimensional modelling that was used doesn't put limitations on how much deformation you can get. These were done so,

assuming that existing conventional North American equipment can also absorb up to about 180 megajoules of energy, as shown on this slide. These were the results of the one-dimensional modelling using the same input characteristics that were used to support the FRA standard. And this was for 100-mile-an-hour collision, with a similar stationary trainset.

This slide shows the amount of energy absorbed by a trainset and also by a lead power car, using this 1-D model. So here we can see that the model predicts that the power car, the locomotive, absorbs almost 140 megajoules of energy, which is about 78 percent of the collision energy. In order to absorb this magnitude of energy, with conventional North American equipment, enormously large distances of the trainset must be able to be crushed in a controlled manner, as shown on these slides. Again, these are the results from that 1-D modelling. Here we see that such a model predicts that the power car crushes a total distance of almost 80 feet, and this was modelled for an 85-foot car, so the Avion water cannon that we saw this morning, this is what's being modelled.

However, in reality the actual crush distances available in even the most advanced rail vehicles, as we saw this morning, are many, many times smaller due to the location and securement of relatively incompressible equipment in the vehicle. While this type of lump mass 1-D modelling conducted can be effective in demonstrating the relative benefits of implementing the crash energy management system, as Dave Tyrell rightfully said this morning, and as was previously mentioned, we do use it in the modelling of the trainsets, we must be careful in trying to draw quantitative results using such forced deflection characteristics. It must be remembered that such models are based on simple physics, not the complex nonlinear stress analysis and tests needed to verify the structural feasibility of the design of the crush zones as we saw in the previous two presentations.

This is particularly true when estimates of structural behavior are made for areas outside the controlled deformation zones. In the past there has been confusion between forced deflection characteristics that are input to these models and location versus buff strength characteristics of the equipment. I've seen modelling done where we assume a car is 800,000 pounds buff strength, which means that in some local place that power in that area will yield at a load of 800,000 pounds, it doesn't mean it'll continuously crush at 800,000 pounds down to the full length of the car.

Any standard developed today must therefore recognize the magnitudes of energy that can be successfully absorbed in a controlled manner and base any collision analysis and structural requirements on collision speeds consistent with these values.

The next area of concern raised was the proposed approach for new standards-the ability to be able to verify that a requirement can be met. The proposed new regulation would require that the equipment be designed to limit the maximum acceleration in the cab to 24g's max or 16g average for 250 milliseconds or 6g max or 4g average for 250 milliseconds in the passenger compartment. As stated previously, there must be a means by which the requirements of any standard can be measured to determine compliance.

How would the industry ever verify compliance to such a requirement without an enormously expensive full-scale test and for what accident scenarios and maximum speed would this occur? The use of simplified one-dimensional models are inappropriate for such evaluation. The results

of these models are highly dependent on the specific details of the force deflection characteristics that we input, the damping, and even the filter characteristics and frequency used for the analysis.

The simplified crush characteristics assumed as input for such models can only be validated through full-scale testing. And then full-scale vehicle collision tests would be required to verify compliance to insure that we meet the g levels. Due to the difficulty of accurately quantifying the magnitude of peak acceleration levels over such a small time base, it would be impractical to specify crashworthiness requirements by such means alone.

On the contrary, the approach used by Amtrak to define minimum structural requirements, along with the minimum energy levels to be absorbed in specific sections of the train is a much more practicable and enforceable means to define a standard. It must be recognized that the other countries in the world that are currently implementing or in the process of implementing crash energy management systems also define requirements in this manner. However, we must caution if the magnitude of the energy absorption required by such a standard is significantly higher than the industry has already demonstrated is achievable, then full-scale trainset collision tests will be required to verify compliance.

Another comment that should be made regarding the limitations of the 1-D models to estimate the effectiveness of the crash energy management system for a high speed collision is the validity of the assumptions used to conduct the analysis. This point has also been raised several times during this symposium so far. Simplified assumptions, such as the trainset remains in line and upright throughout the collision scenario has proven to be a good assumption for low speed impacts. However, the validity of these assumptions for high speed impacts is highly questionable.

As previously stated, the total energy that can be absorbed through practical structural deformation is very small in comparison to the kinetic energy of the high speed collision. This can be seen in the following slides, which show an approximate breakdown of the magnitudes of energy dissipation by the various mechanisms involved in high speed collisions.

This slide shows the distribution of collision in a trainset hitting an immovable wall at 150 miles an hour, essentially two trainsets colliding at 150 miles an hour. We have the controlled crush energy in green in the trainset, we have some energy taken out by breaking and aerodynamic resistance, but these are all very small. About 96 percent of the energy still remains to be absorbed by some means.

This energy, which is referred to as the remaining energy in this figure, must be absorbed through crushing of the trainsets outside the controlled cross-sections and by vertical and lateral buckling of the trainset. It is therefore understandable why there is no means of accurately predicting the resulting complex collision dynamics that will occur in order to dissipate the remaining energy, once the practical energy absorbing limits of the structure have been exhausted for such a high speed collision.

Another scenario to consider is the case of a high speed trainset colliding with a similar stationary trainset at 150 miles an hour, which is similar to cases we've talked about in the symposium. The estimated energy distribution at the instant that both trainsets begin to move off together at the same speed is where we've taken the pie chart here, it's shown on this slide.

Here it can be seen at one-half of the kinetic energy of the collision, which is basically this term here, and what we term, it's a conservational momentum term, it brings one trainset down from 150 miles an hour to roughly 75 and accelerates the other one from zero up to 75 miles an hour. This is essentially half of the energy. In this scenario, the remaining energy, which is over 500 megajoules, which is here, remains after the controlled energy and absorbing structure has been exhausted.

Now if we assume that the trainset stays in line and upright during this mechanism here, which is a very ambitious assumption, then the remaining energy can only be absorbed by either moving both trainsets backwards to stop, by crushing the trainset in the areas outside the controlled crush-sections or the other obvious solution is to cause a train to jack-knife or buckle or override. So even in this case, this residual energy is sufficient to lift an entire trainset over 350 feet in the air. This would be completely unrealistic, to assume that the trainsets would remain in line throughout such a high speed collision.

These concerns are also valid for any collision analysis of conventional North American equipment, particularly for a trainset using a standard AAR coupler, which has a natural tendency to buckle laterally under high compressive loads. Previous analysis for the conventional North American trainsets assume that they have shearback couplers, but the equipment it's running now doesn't.

The other area of concern that requires comment regarding the proposed approach to the development of standards is the compatibility of the energy-absorbing requirements with the static structural requirements and the practical space that's available to crush. Where there is merit in defining the minimum structural requirements, in addition to the amount of energy that must be absorbed, both requirements must be developed in unison to insure they are compatible.

In many cases, a high static strength requirement can be in conflict to the requirement needed to provide controlled collapse and energy absorption. At present, the proposed standards, as stated previously by Frank, are requiring both significantly higher structural strength and energy-absorbing capabilities than any equipment which has been built to date. It will therefore be necessary to insure that any such values specified are not in conflict with each other and can be achieved before being required by a standard.

In conclusion, I would like to make several comments. The first that significant research and development has been conducted over the past three or four years in the area of crash energy management in rail vehicles. That was very evident by the two previous speakers. Analysis and full-scale tests have verified the benefits of incorporating such features into trainsets to increase safety for train-to-train collisions with closing speeds of about 35 miles an hour and for grade-crossing collisions with very large object at speeds less than 65 miles an hour. Researchers have demonstrated the feasibility of incorporating controlled energy absorption structures in the limited unoccupied areas of the trainsets.

Much research and testing would be required before any standard could incorporate more stringent requirements than that which has already been shown to be feasible. As research efforts in these areas will continue in order to develop structures with greater energy absorption capabilities, any new standards should provide the flexibility to incorporate such new features as they are developed. The requirement to incorporate energy-absorbing structures into the rail

passenger industry has the potential to significantly affect the approach to the design, the manufacture, and the test of rail vehicles in this country. This new approach may vary significantly with different car body materials and types of rail cars. I believe that the excellent presentations given previously by both British Rail and the SNCF and GEC Alsthom has clearly demonstrated the complexity of incorporating a practical crash energy management system into a rail vehicle and have shown us exactly where the state-of-the-art in this area is for rail vehicle design.

Again, we must be careful not to mandate a specific crash energy management requirement in our new standards that would be required for all types of rail vehicles until sufficient research is completed to verify that such requirements are achievable, they're practical, that we have a means to verify them, and that they have proven to be effective.

[Applause]

STEVEN DITMEYER: Thank you, Larry, and I'm sorry I mixed up peculiar and particular there. But I'm glad you straightened that out. We'll have time for a few questions right now and then we'll assemble our entire panel up here for questions. So David, do you have a question, perhaps, or a statement?

DAVID TYRELL: I have numerous questions. I have a question that was related to one that was asked Herb earlier. Larry, why did you consider a 300-mile-an-hour closing speed collision?

LARRY KELTERBORN: We've considered two collisions here to analyze. One was, which was the first question that was asked of the group that we were working on the high speed TGV project in Texas, which when we're operating at 200 miles an hour, the first question that was asked was obviously we have to design this train to run 200 miles an hour. It doesn't make sense, does it. So people said, well if they both run at that speed, why is it not possible to have that collision scenario. And once we had realized that this is not a realistic situation, then we looked at the case that was being analyzed originally in the Northeast Corridor, which was assuming one is stationary and the other is running at the maximum speed. Got that, David?

DAVID TYRELL: Yes, I got that. I was debating whether to ask another question, perhaps I'll wait.

MARK SNYDER: Mark Snyder, Foster-Miller. I have a question for Mr. Kelterborn. I guess I have to take some issue with your comments about one-dimensional modelling. As a mechanical engineer, who is I guess, has stretched a single mass and a single spring through levels that probably would be considered absurd on occasion, I have to say that I think one-dimensional modelling is an appropriate design tool.

I think the question to be asked is not whether standards or limits are based on one-dimensional models, but on what goes into the one-dimensional model. And I don't think anybody here would say that, based on what SRI presented and what British Rail presented and what the gentlemen from SNCF presented, usually there's a fair amount of detailed modelling on say an individual vehicle to determine force displacement characteristics, that then goes into one-dimensional models and these one-dimensional models allow you to do consist modelling collisions. They

also allow you to tweak parameters and do a lot of what-if studies that would probably be exceedingly expensive or time consuming.

The other thing that I think is of interest that was raised during the presentations is whether or not you can design for a dynamic event on the basis of static force displacement characteristics. On the one hand, the British Rail results seem to have had very good success based on static tests. Some work that we did with SRI on conventional rail vehicles seem to show that there were dynamic buckling effects of the center sill, which would not be observed in a static strength test. So, I think we should be fair about this.

LARRY KELTERBORN: I appreciate your comment. I think we are being fair about it, you must appreciate where we're coming from. First of all, as designers, we use one-dimensional modelling a lot. As mentioned by Daniel, one of the first steps that we do in analyzing something is do a 1-D model. We have enormous amounts of 1-D modelling. But we don't rely a lot on the output of these models before the inputs to them are validated. Dave mentioned a comment the other day that the SNCF used a 1-D model to predict the accident at Verone and I say that backwards, after the accident at Verone occurred, a 1-D model was tuned with the inputs that were measured from the trainset so that you could predict it with the 1-D model. And in this sense, it's very, very valuable.

Now the problem comes when we as an industry try to say, "now if we use those force deflection characteristics and the speed of impact wasn't actually 60 miles an hour, it was 200 miles an hour, what's the result?" And I think that we have to be very, very careful in doing that and relying on these one-dimensional models and I'm concerned, personally, that because this type of modelling was used early in the process, which I think was the right thing to do, but the results which showed that the possibility of 140-mile-an-hour head-on collisions were achievable and that 70-mile-an-hour collisions with existing equipment, North American equipment, were achievable, gives the industry a false sense of what we can do. And that's my concern with one-dimensional modelling.

Just to sum up, we used them extensively, but I caution on how you use them and under what conditions.

STEVEN DITMEYER: Then I guess I would ask you what you would propose as an alternative for use in engineering design of new trainsets?

LARRY KELTERBORN: I'm going to let Daniel handle that, but first I would say that when we're working as we are on the Northeast Corridor equipment and the collision scenario that we're looking at is 30 miles an hour, they're quite valid. But when we're looking at, extrapolating them to 140 miles an hour, 150 miles an hour, so many other things happen before that, the model doesn't mean anything.

STEVEN DITMEYER: Perhaps we can talk about this afterwards. I don't think the issue is with the 1-D model. I think the issue is what goes into that model for forced displacement characteristics. And they should be representative of your 140-mile-an-hour collision. Not representative of the 20-mile-an-hour or 10-mile-an-hour static event. I don't think anybody is asking to take something that is determined in a static situation and take it way out into a regime

that is heavily dynamic. But I think we could talk about this all afternoon. I just don't think that it was fair to condemn one method of engineering analysis out of hand, that's all.

LARRY KELTERBORN: No, I don't think we're condemning that method, we're condemning some means that it can be used or misused.

DAVID TYRELL: I'd like to clarify a couple of things that I think I've been quoted as saying by yourself, Larry. One, I believe I said yesterday, or earlier today, that SNCF used a 1-D model to evaluate the collision. I did not say predict a collision. That's one clarification.

Another clarification is I believe the paper that you're referring to says nothing, absolutely nothing, about feasibility. It only says that you must have this kind of force crush characteristic if you wish to survive the collision. It says absolutely nothing about whether that can actually be achieved.

LARRY KELTERBORN: Absolutely, David, and I agree with that. And my concern is how the information--

DAVID TYRELL: With all due respect Larry, that's not exactly what you said.

LARRY KELTERBORN: No, it is. The concern I have, Dave, is how the information is used. That is the information that has been used to support a standard. So it's been the interpretation of that--the initial works on the standard. And what, as an industry, we're hearing back is that it's--you people should be able to design trainsets for these high speed collisions. Look at the analysis that's been done. And when I read the papers that are done by the Volpe Center they don't say that, I agree with you. But the interpretation based on that analysis is that we can.

STEVEN DITMEYER: Allen, do you have a question?

ALLEN BING: Allen Bing, Arthur D. Little. This is more of a comment than a question. But in some work I did awhile ago, I looked at a number of serious past accidents, the ones that got detailed reports from the NTSB so you could figure out a few details of what actually went on. And did ask the question that Larry asked in his pie chart there of where does all the energy go. And I can't remember the exact figures, I can give you the reference, the report in which I did this, but I have a feeling of the order of 50 megajoules and please don't tie me down to this number. Accidents up to that energy dissipate in the accident, the trains tend to strain in straight line and the energy was absorbed in crush usually. Beyond that the trains jack-knifed, rolled over, all those kinds of things, and the energy clearly went into that whole process and, in fact, the energy dissipation rate was a whole lot lower, because the rear vehicles in such a train slowed down very much more slowly when leading vehicles are jack-knifing. And it was a fairly consistent pattern among all these different accidents.

It may be worthwhile, since it's some time since I did it and it doesn't have all the benefit of the research that's gone on since and it's really a little sidebar to another piece of work--that sort of forensic examination of past accidents might be very useful in understanding where the energy goes and therefore designing ways in which to manage energy in the future.

STEVEN DITMEYER: One more question there?

LANCE SLAVIN: First of all, I'd like to say that I agree very much with the point you made about specifying the static load and the g level. You can't specify the static load of the structure and then specify g level, unless you've made sure that they're compatible. In trying to design for crashworthiness, I think the first step is to decide what is an acceptable g level in the coaches. Once you've decided that, and you've taken into account the mass of the vehicle, then you must decide what delta v you want to manage. And that delta v could include the change in velocity from initial velocity to zero and perhaps a negative velocity. If a train hits another train, it's more mass going in the opposite direction, you could end up backing up. And the total delta v must be taken into account. Once you've decided those parameters, then you can determine how much crush distance you have and what it will be required and whether that's reasonable or not. If it turns out to be 200 feet, maybe that means that you haven't a sacrificial car in front of the engine and you may say well, no, it doesn't look like a train anymore. Well, I agree, it doesn't look like a train anymore, but it might work, up to the point where buckling sets in.

So you have to decide in a rational, logical order what your criteria are if you're going to design for crash energy management. And then the distances will come out and then you have to find out where those distances are. If you actually have to create distance by adding lengths to the front of the train, then that's a viable approach. It may not be one that people find aesthetically pleasing, but it will work, up to the point where the train buckles.

STEVEN DITMEYER: I agree with that, with just one comment. When we added equipment on to the front of the trainset, particularly when we want to couple another trainset, do we have a limitation of how far we can go out so that in corner we don't pull the trainset off the track? Again, a practical consideration that we have to look at.

STEVEN DITMEYER: Grady, do you have a comment?

GRADY COTHEN: You could even put express packages in that car [laughter] in front of the trainset. Something we discussed. Without rearguing about that dead dragon over there that Larry has successively slain for the 43rd time, which was the set of initial scenarios that we've challenged the engineers with over these many months that have almost caused them to be as peculiar as we are. The issue has recurred today and we had some good experts up there and I'd like you to address it. Regarding the issue of static strength, as specified in UIC and U.S. standards, and I've noticed even as a nonengineer, recurring references to the fact that-I suppose the correct term is that engineers in working with designs and static strengths will consider how the structures collapse and therefore will consider the ductility of the materials that are being used--something that is not in any of the official standards. This assumes that there's a wise choice of materials, that an analysis is conducted with regard to the manner in which the structure will collapse, and therefore uses up additional energy as it collapses. I wonder if you all could comment on how we get that concept into a regulation without usurping the role of the design engineer.

PRESENTATION

***NEC TRAINSETS - PRACTICAL CONSIDERATIONS FOR
THE INTRODUCTION OF A CRASH ENERGY
MANAGEMENT SYSTEM***

NEC TRAINSETS - PRACTICAL CONSIDERATIONS FOR THE INTRODUCTION OF A CRASH ENERGY MANAGEMENT SYSTEM

PRESENTERS:

Frank Duschinsky, M.Eng.

Bombardier Transportation Equipment Group

Daniel Palardy, B.Sc.A.

Bombardier Transportation Equipment Group

Larry D. Kelterborn, M.A.Sc., P.Eng.

LDK Engineering, Technical Consultant to Bombardier

1. INTRODUCTION

Crash Energy Management from the carbuilder's prospective is seen as an important aspect of the overall System Safety Design of the Trainset.

At this particular time, we find ourselves in the midst of heightened awareness of crashworthiness concept benefits, and a rule making process, which will have significant consequences on the industry. It is therefore especially important not only to review the pure technical, be it theoretical or experimental aspects of Crash Energy Management, but also to review the practical considerations of its implementation in the context of the railway industry.

When addressing the objective of improved safety of transportation systems, it is self evident that the prime solution lies in accident avoidance. Originally this field was outside of the traditional carbuilder's sphere of activities. However, with the current trend towards turnkey BOT type projects, where new transportation *systems* are put in place, numerous carbuilders which have become system providers, are acutely aware of accident avoidance as the principal system safety element. This element must remain in the forefront of any safety improvement thrust, including for existing non dedicated railway systems.

It may be appropriate to repeat some well known traits of the North American railway industry as a whole and of passenger railway equipment in particular:

- It is likely that even important changes in rolling stock equipment would have to be classified as evolutionary; for good reasons revolutions are not a staple for this industry.
- Off-the-shelf products are practically non-existent, even the most "similar to" acquisitions have an arm long list of changes.
- Important series are in tens or hundreds of cars not thousands or millions.

- "Conservatism" and "service proven" have served the industry for years and are part of the tradition.
- The difficulties in raising capital for transportation systems or for rolling stock in North America, are tremendous.
- It does not matter how long it took to develop specifications, raise capital or just decide to go ahead, delivery is required yesterday.

In this general context of industry, where the lowest cost is a necessity not only to win a contract, but also to ensure the viability of passenger railway service, two messages towards the rulemaking process are extremely important:

- Regulations should be a consensus of achievable and proven requirements.
- Rules should be clear with well defined measurable criteria.

These subjects will be addressed in more detail in the following sections.

Focusing on the High Speed Trainsets for the Northeast Corridor Project, we can appreciate the considerable challenge Amtrak had to face in order to reconcile the need for immediate specification structural requirements with the impending rule process. Even though the Amtrak specification requirements, in our opinion, exceed the actual state of art in crashworthiness, a commendable effort to keep the requirements and criteria clear, has been expanded.

This clarity of requirements has permitted the necessary evaluation leading to our commitment to the specified levels of Crash Energy Absorption.

2. DESIGN APPROACH FOR THE NEC TRAINSET

As you may be aware, Bombardier/GEC Alstom have recently been selected by Amtrak to provide 18 American Flyer Trainsets for use on the Northeast Corridor. In response to Amtrak's request for high speed Trainsets, Bomardier and GEC Alstom teamed together to develop the American Flyer, which will be custom designed to meet Amtrak's specifications. We therefore have the task of developing the first Crash Energy Management (CEM) System for North American application.

The Amtrak high speed Trainsets will incorporate a CEM system to maximize crew and passenger safety in the event of a collision. Working in conjunction with our partner GEC Alstom, the CEM system will be derived from the state-of-the-art TGV-2N crash management technology.

The Trainsets will be configured with a power car at each end of the consist. This improves the crashworthiness of the equipment by protecting both ends of the Trainset and eliminating unprotected passenger compartments.

The Trainsets will use a semi-permanently coupled arrangement with draw bars connecting each car. This arrangement is incorporated as part of the CEM system,

providing the required anti-climbing strength, and incorporating a shear-back feature to permit energy absorbing structures to engage in the event of a collision.

These Trainsets will have high structural strength in the cab and occupied passenger areas, and controlled crushable zones in the unoccupied space or low-density passenger space of the carbody, which are designed to absorb a portion of the kinetic energy associated with a collision.

The high speed Trainsets for Amtrak will be built in accordance with the Amtrak specification which defines both the minimum structural static loads, as well as the minimum amount of energy to be absorbed by controlled structural deformation in the various parts of the Trainset.

Most of the static carbody structural end loads defined by the specification for this equipment are summarized in figures 2.1, 2.2 and 2.3 for the cab structure, power car rear and trailer car vestibule areas respectively. As shown in figure 2.1, these requirements will lead to a very strong cab arrangement capable of carrying 2.1 million pounds through the cab at floor level, and 310,000 lbs through the cab at the roof level. In addition to these requirements, the carbody structures must comply with all current North American requirements defined by 49CFR 229.141 and AAR's Standard S-034, "Specification for the Construction of New Passenger Equipment Cars", including the 800,000 lb buff strength requirement. The strength of the power car body shells must also meet the requirement defined with AAR's Standard S-580, "Locomotive Crashworthiness Requirements"

The Amtrak specification requires controlled energy absorbing structures designed to dissipate in a controlled manner a minimum of 8 MJ in each power car (5 MJ immediately ahead of cab and 3 at the rear of the power car), 5 MJ at the end of each passenger car adjacent to the power cars, and 2 MJ at each end of all other passenger cars. The location of these energy absorbing zones may be seen in Figure 2.4.

At this point, it is important to clarify the meaning of "controlled manner". It simply means that the energy will be absorbed in crushable zones by structural elements specifically designed with known force-displacement characteristics. More energy will be absorbed by other structural or non-structural elements (side skins, roof, interior finish, etc) during a collision. Because the behavior and force displacement characteristics of these elements are very difficult to assess at the design stage, this energy is not taken into account. Nevertheless, the total energy absorbed during a collision will be the summation of both the controlled and uncontrolled form of energy absorption.

The specification also defines a crash scenario to be modeled. An analysis must be conducted to verify that the maximum acceleration in the passenger vehicles does not exceed 10g from a 30 mph impact of a Trainset with another stationary Trainset. This modeling must also verify that the velocity of an unrestrained passenger at contact with the seat back ahead, shall not exceed 25 mph in the collision scenario.

In order to meet the requirements of the Amtrak technical specification for crashworthiness, a 'Trainset Collision Survivability Plan' was developed.

The objective of this plan is to ensure that the Trainset will:

- Maximize the crew and passenger safety by the proper location of absorption zones.
- Minimize the acceleration level sustained by the passengers (function of the collision scenario).
- Continuously maintain the anti-climbing capability.
- Improve the stability of the train on the track by minimizing the risk of jack-knifing of cars. This is achieved by limiting the concentrated longitudinal loads in the drawbar and designing the structures of adjacent cars to mate and properly distribute the collision forces into the car ends.

The design process being followed to fulfill the mandate of the survivability plan is as follows;

- Review the specification requirements.
- Development of the train layout and configuration.
- Identify possible areas for crush zones.
- Preliminary force-displacement definitions for crush zones.
- One dimensional modeling to verify suitability of CEM design.
- Design of car bodies and energy absorbing components.
- Optimization and integration of car bodies and absorption structures.
- Validation of design.

The following discussions will provide additional details for each stage of this design process.

The review of the Amtrak specification includes defining the static structural requirements, and the dynamic requirements (energy absorption and g levels). In addition to meeting the structural and CEM demands, consideration must be given to provide a Trainset that is functional. Such limitations as the restraints on vehicle weights, truck/banking clearance requirements, location of passenger and crew space, and positioning of door openings etc., all impact on the design and location of crush zones.

During the development of the train layout and configuration, not only the above requirements must be taken into account, but also any additional features required must be integrated.

An iterative process employing various types of analysis and component testing is followed in order to optimize the performance of the CEM system and meet the customer's requirements. The first stage of the design process is to define the sizing and location of the crush zones. This is achieved as follows;

- Initial location of crush zones.
- Identification of the force-displacement characteristics to be used in the one-dimensional model collision analysis.
- Solution to the one-dimensional model in order to confirm energy dissipation, 'g' level and crushing length of dedicated absorption components and zones.

Once the crush zone location and strengths are defined, the process of designing the actual structures and components may begin. This stage progresses as follows;

- Proceed with the design of the carbody structure and the absorption zones, including the detailed configuration of the individual absorbers and fusing members.
- Conduct two and three dimensional linear finite element analysis to demonstrate compliance with static strength requirements.
- Conduct three-dimensional non-linear analysis of each absorber and fusing member in order to validate that their force-displacement characteristics are in line with the proposed values.

The iterative process between the design, the linear and the non-linear analysis leads to many versions of each absorber. There are many iterations before the process converges to a solution that is satisfactory for both the absorption and static strength requirements of the absorber.

After completion of the absorber designs, it is necessary to validate their performance through the following steps;

- Measurement of energy absorption capability of key absorbers by impact testing of half or full scale prototypes. Correlation between test and three dimensional model analysis results will be the validation basis for the detailed model collision analysis.
- Conduct detailed three-dimensional non-linear analysis of carbody extremities that comprise absorption zones to ensure the adequate integration of each absorber with the surrounding structures.

- Carbody static structural testing in order to verify compliance with structural load requirements.

The above validation process brings us to a comfortable level of confidence, as to the safety benefits arising from a Trainset incorporating this CEM system. The evolution of this methodology has been the result of the Amtrak specification defining realistic and verifiable requirements for the finished product. It is important for any future standards or specifications to follow this lead in providing practical and achievable guidelines for the industry.

3. APPROACH TO EQUIPMENT SPECIFICATION

As most of you are aware, the reason that this symposium has been organized to bring the industry specialists together to provide answers to the many outstanding technical questions that have been raised in the area of crashworthiness. These questions have been raised, by the supply industry, the National Transportation Safety Board, Labor Organisation and Operating Railways with respect to the structural and crashworthiness requirements that should be considered in higher speed operations.

There is little doubt that crash energy management (CEM) can provide improved safety for some specific accident scenarios and up to some speed. However, quantifying the specific means by which to specify such crashworthiness requirements consistent with the minimum structural requirements also being specified, has proven to be a difficult task.

As previously stated, a specification must be based on validated concepts that have proven to be effective. This requires all the steps and iterations previously outlined in the CEM plan to be completed in order to demonstrate that such requirements can indeed be met, before making these requirements a law.

The three most significant areas that have created major concern during the specification process are:

- 1) The speed of the accident scenario to be designed for, and hence the amount of energy to be absorbed.
- 2) The ability to verify that the requirements are met, and
- 3) Compatibility of the energy absorbing requirements with:
 - the static structural requirements proposed, and
 - the unoccupied space available in a Trainset to absorb such energy.

I believe that we must be able to reach an agreement on what can be achieved regarding these fundamental issues with today's know-how, to help direct the approach that will be taken during the current rule making process.

Let me talk about each one of these issues briefly. For what speed can the CEM system be designed to be effective? As we see in figure 3.1, the kinetic energy of a Trainset is proportional to the square of the velocity. Therefore, the kinetic energy of a Trainset like the new Northeast Corridor equipment for Amtrak, operating at 150 mph, is some 1,200 MJ (900×10^6 ft-lbf) of energy.

To put this in perspective, this amount of energy is equivalent to that required to lift the entire Trainset over 750 feet in the air. Except for small losses due to aerodynamic resistance and braking forces, this amount of energy would have to be absorbed by each train in a head-to-head collision of two Trainsets impacting at the same speed.

It is quite evident that there is insufficient capacity within the unoccupied areas of a Trainset to absorb such enormous energies, and all measures must be taken to ensure such collisions cannot occur.

Our colleagues in France and England have based their crashworthiness specifications such as to protect passengers for much lower speed impacts and to provide protection at grade crossing accidents, where their studies indicate the majority of all collisions occur. This has resulted in the requirement in the UK for 1.5 MJ of energy absorption at both ends of a Trainset, and 0.75 MJ at each end of all intermediate passenger cars, providing a total controlled energy absorption potential of 9 MJ in the Trainset. Similarly, the most recent TGV Trainsets in France are designed to absorb a total of about 14 MJ of energy (8.5 MJ in controlled energy absorbers) in the power car and end trailer. In both of these cases, it has been demonstrated through modeling and full scale testing at speeds up to about 35 mph, that such magnitudes of energy can be absorbed in a controllable manner.

To date, proposed structural and energy absorbing requirements have been based on the results of one dimensional modeling analysis, based on simplified assumptions and estimated crush characteristics. Extreme caution must be taken using such models to make quantitative evaluations, particularly when the actual crush characteristics of the Trainsets are not known.

It should also be realized that the conclusions reached in Reference 7 with this type of analysis were done so assuming that existing, conventional North American equipment can also absorb up to about 180 MJ of energy in a controlled manner for a 100 mph collision with a similar stationary Trainset.

In order to absorb this magnitude of energy in conventional North American equipment, enormously large distances of the Trainsets must be able to crush in a controlled manner. The actual crush distances available in even the most advanced of rail vehicles are many times smaller due to the location and securement of relatively 'incompressible' equipment in the vehicle.

While this type of lumped mass, 1-D modeling can be effective in demonstrating the relative benefits of implementing a CEM system, we must be careful in trying to draw quantitative results using such force-deflection characteristics. It must be remembered that such models are based on simple physics, not the complex non-linear stress analysis and tests needed to verify the structural feasibility of the design of the crush zones. This is particularly true when estimates of structural behavior are made for areas outside the controlled deformation zones.

Any specification of equipment today must therefore recognize the magnitude of energy that can be successfully absorbed in a controlled manner, and base any collision analysis and structural requirements on collision speeds consistent with these values.

The second area of concern raised with the approach is the ability to be able to verify that a requirement has been met. A proposed specification would require that the equipment be designed to limit the secondary impact deceleration of crew members to 24g max. and 16g average for 250 msec after initial impact under the condition of the collision scenario. In addition, those maximum acceleration levels are to be limited to 6g peak and 4g average for 250 msec in the passenger compartment.

As stated previously, there must be a means by which the requirements of any specification can be measured to determine compliance. How would the industry ever verify compliance with such a requirement without an enormously expensive full scale test, and for what accident scenario and maximum speed would this occur?

The use of simplified one-dimensional models are inappropriate for such evaluation. The results of these models are highly dependent on the specific details of the force-deflection characteristics, damping, and even filter characteristics and frequency used for the analysis. The simplified crush characteristics assumed as input for such models can only be validated through full scale testing.

Due to the difficulty of accurately quantifying the magnitude of peak acceleration levels over such a small time base, it would be impractical to specify crashworthiness requirements by such means. On the contrary, the approach used by Amtrak to define minimum structural requirements along with minimum energy levels to be absorbed in specific sections of the train, is a much more practical and enforceable means to define a specification. It must be recognized that the other countries in the world that have implemented, or are in the process of implementing crushable sections in rail vehicles, also define the requirements in this manner. However, depending on the magnitude of the energy required by such a specification, full Trainset collision tests and associated costs may be required to verify compliance.

Another comment that should be made regarding the limitations of 1-D models to estimate the effectiveness of the CEM system for a high speed collision, is the validity of the assumptions used to conduct the analysis. Simplified assumptions, such as the Trainset remains in line and upright, without vertical or lateral buckling, have proven to be reasonable for relatively low speed impacts. However, the validity of these assumptions for high speed impacts is highly questionable. As previously stated, the total energy that can be absorbed through 'practical' structural deformation, is very small in comparison to the kinetic energy of a high speed collision. This can be seen in figures 3.2 and 3.3, which show an approximate breakdown of the magnitude of energy dissipation by the various mechanisms involved in high speed collisions. Figure 3.2 shows an estimate of how the energy is distributed in a collision of a Trainset hitting an immovable wall at 150 mph. It can be seen that about 96% of the kinetic energy of the collision must still be absorbed by some means after the 'controlled' structural energy absorption has been exhausted. This energy, which is referred to as the 'remaining energy' in this figure, must be absorbed through crushing of the Trainset in areas outside the controlled crush sections, and by vertical and lateral buckling of the Trainset. It is therefore understandable why there is no means of accurately predicting the resulting complex collision dynamics that will occur in order to dissipate the remaining energy, once the practical energy absorbing limits of the structure have been exhausted.

Another scenario to consider, which is similar to that analyzed in Reference 7, is the case of a high speed Trainset colliding with a similar stationary Trainset at 150 mph. The estimated energy distribution at the instant that both Trainsets begin to move off together at the same velocity, is shown in figure 3.3. In this figure it can be seen that one half the kinetic energy of the collision is used to decelerate one Trainset to approximately one half of the initial speed, and also to accelerate the stationary Trainset to the same speed. This energy, which is essentially a conservation of momentum term, is referred to as 'Energy Transfer' in figure 3.3. In this scenario a 'remaining energy' of approximately 519 MJ (383 x 106 ft-lb) remains after the controlled energy absorbing structures have been exhausted. The various means by which this remaining energy can be dissipated can be split between structural deformation of the carbody outside the controlled crush sections, movement of the Trainsets to rest, and vertical and lateral buckling of the Trainset. As this residual energy is sufficient to lift an entire Trainset to a height of over 315 ft., it would be completely unrealistic to assume that the Trainsets would remain in line throughout such a high speed collision. These concerns are also valid for any collision analysis for 'conventional' North American equipment, particularly for a Trainset using a standard AAR coupler arrangement, which has a natural tendency to buckle laterally under high compressive loads.

The third area of concern that requires comment regarding the proposed specification approach, is the compatibility of the energy absorbing requirements with the static structural requirements and the practical space available to crush.

While there is merit in defining the minimum structural requirements, in addition to the amount of energy that must be absorbed, both requirements must be developed in unison to ensure they are compatible. In many cases, a high static strength requirement can be in conflict to the requirement needed to provide controlled collapse and energy absorption. The approach proposed in Reference 7 requires both significantly higher structural strength and energy absorbing capabilities than any equipment which has been built to date. It will therefore be necessary to ensure that any such values specified are not in conflict with each other and can be achieved.

In conclusion, I would like to comment that significant research and development has been conducted over the past 3 or 4 years in the area of CEM in rail vehicles. Analysis and full scale tests have verified the benefits of incorporating such features into Trainsets to increase safety for train-to-train collisions with closing speeds of about 35 mph and for grade crossing collisions with very large objects at speeds less than 65 mph. Researchers have demonstrated the feasibility of incorporating controlled energy absorption structures in the limited unoccupied areas of the Trainsets. Much research and testing would be required before any specification could incorporate more stringent requirements than that which has already been shown to be feasible. If major research efforts in these areas are conducted in order to develop structures with greater energy absorption capabilities, the new design specification should incorporate such new features as they are developed.

The requirement to incorporate energy absorbing structures into the rail passenger industry has the potential to significantly affect the approach to the design, manufacture

and test of rail vehicles in this country. This new approach may vary significantly with different carbody materials and types of tailraces. Again, we must be careful not to mandate a specific CEM requirement that would be applicable for all types of rail vehicles, until sufficient research is completed to verify that such requirements are achievable, practical, verifiable and have proven to be effective.

4. REFERENCES

1. National Railroad Passenger Corporation (Amtrak), "High Speed Trainset Program, Specification No. 558", 1996.
2. Federal Railway Administration (FRA), Code of Federal Regulations 49CFR-229.141.
3. Association of American Railroads (AAR), Mechanical Division, Manual of Standards and Recommended Practices, S-034, "Specifications for the Construction of New Passenger Equipment Cars".
4. Association of American Railroads (AAR), Mechanical Division, Manual of Standards and Recommended Practices, S-580, "Locomotive Crashworthiness Requirements".
5. Cléon, L. M., "Résistance Passive Application au TGV 2N", Revue Générale Des Chemins de Fer, #11, November 1993, France.
6. Lewis, J. H., 1995, "Development of Crashworthiness for Rail Vehicles", paper for IV Symposium on Crashworthiness and Occupant Protection in Transportation Systems. AMD-Vol. 210/BED-Vol.30, 1995 ASME Congress, San Francisco.
7. Lewis, J. H., 1995, "Validation of Measures to Improve Safety in Railway Structures", paper for IV Symposium on Crashworthiness and Occupant Protection in Transportation Systems. AMD-Vol. 210/BED-Vol.30, 1995 ASME Congress, San Francisco.
8. Tyrell, D.C., Severson, K.J., Marquis, B.P., 1995, "Train Crashworthiness Design For Occupant Survivability", paper for IV Symposium on Crashworthiness and Occupant Protection in Transportation Systems. AMD-Vol. 210/BED-Vol.30, 1995 ASME Congress, San Francisco.
9. Tyrell, D.C., Severson, K.J., Marquis, B.P., 1995, "Analysis of Occupant Protection Strategies in Train Collisions", paper for IV Symposium on Crashworthiness and Occupant Protection in Transportation Systems. AMD-Vol. 210/BED-Vol.30, 1995 ASME Congress, San Francisco.

**POWER CAR CAB STRUCTURE
STATIC LOADING REQUIREMENTS**

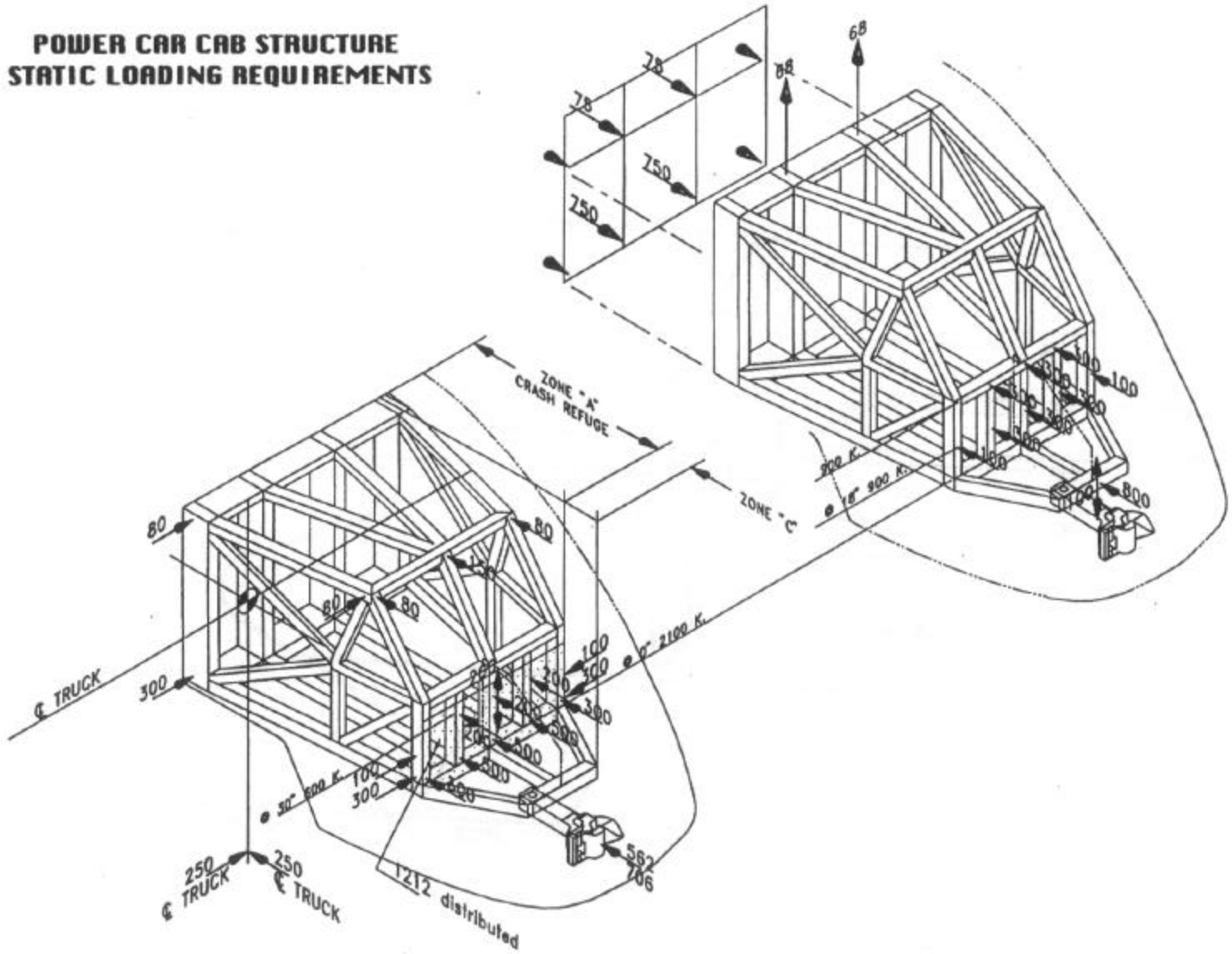

POWER CAR REAR STRUCTURE STATIC LOADING REQUIREMENTS

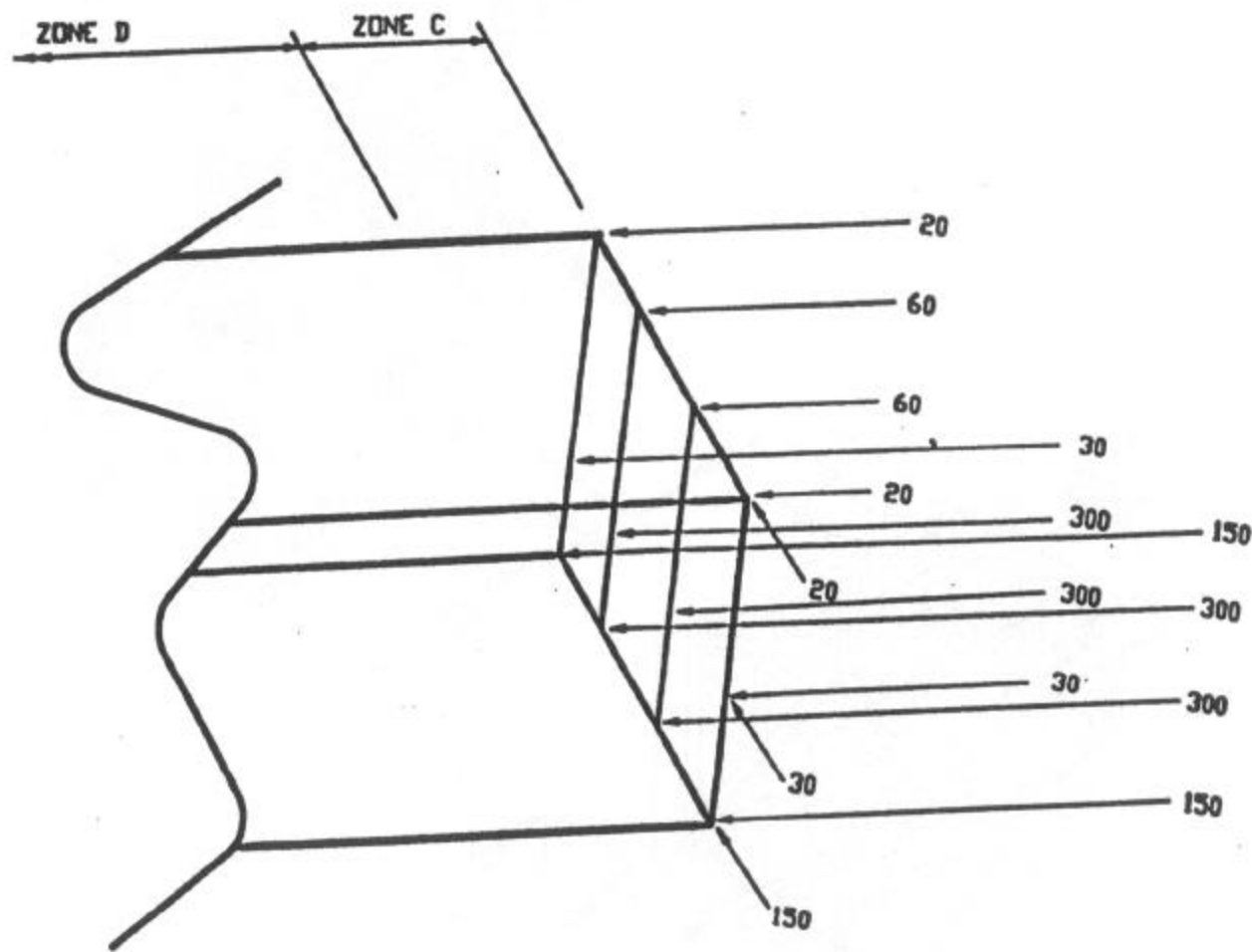

LOADS (KIPS)

IIB-3-28

**PASSENGER CAR END STRUCTURE
STATIC LOADING REQUIREMENTS**

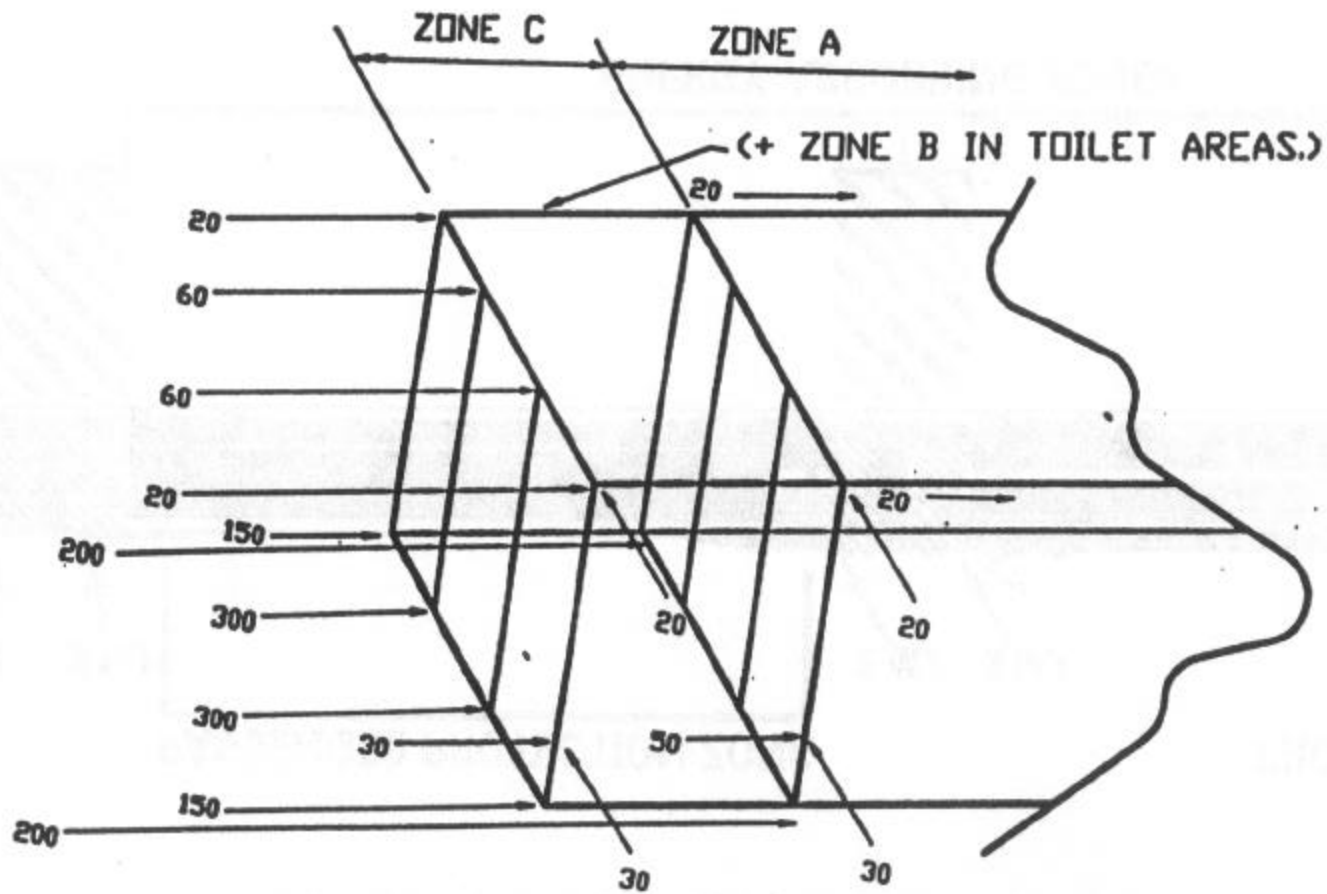

CRASH ENERGY MANAGEMENT SYSTEM

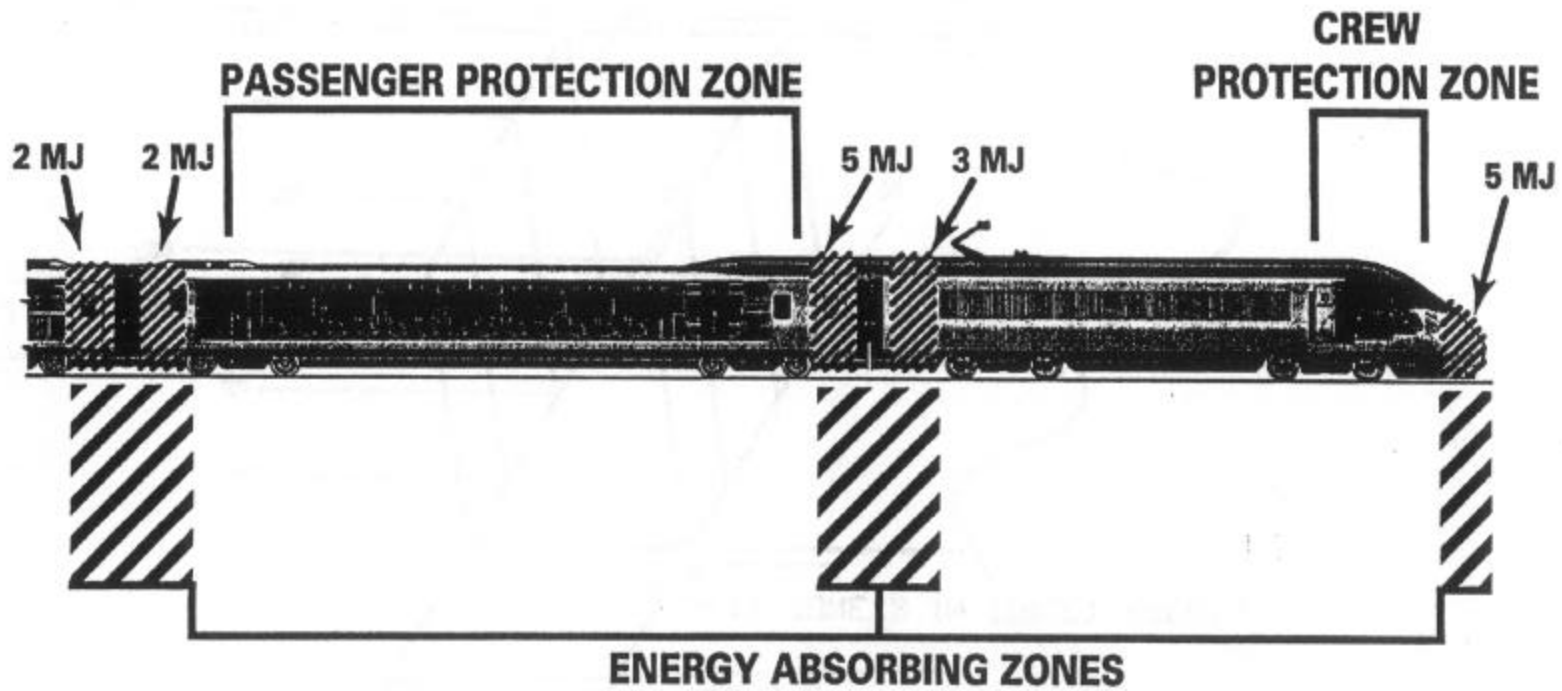

FIGURE 2.4

IIB-3-30

KINETIC ENERGY vs SPEED

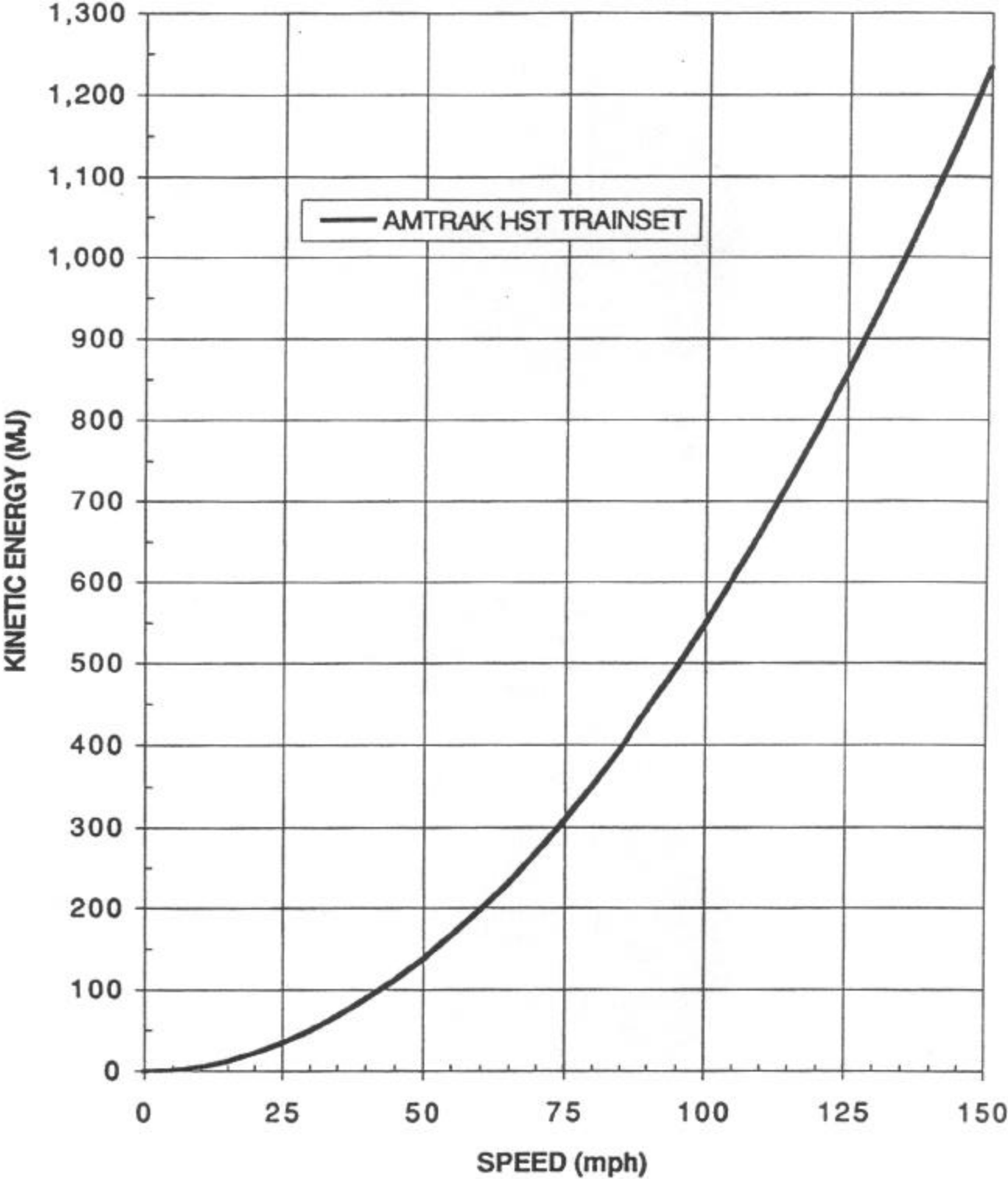

Figure 3.1

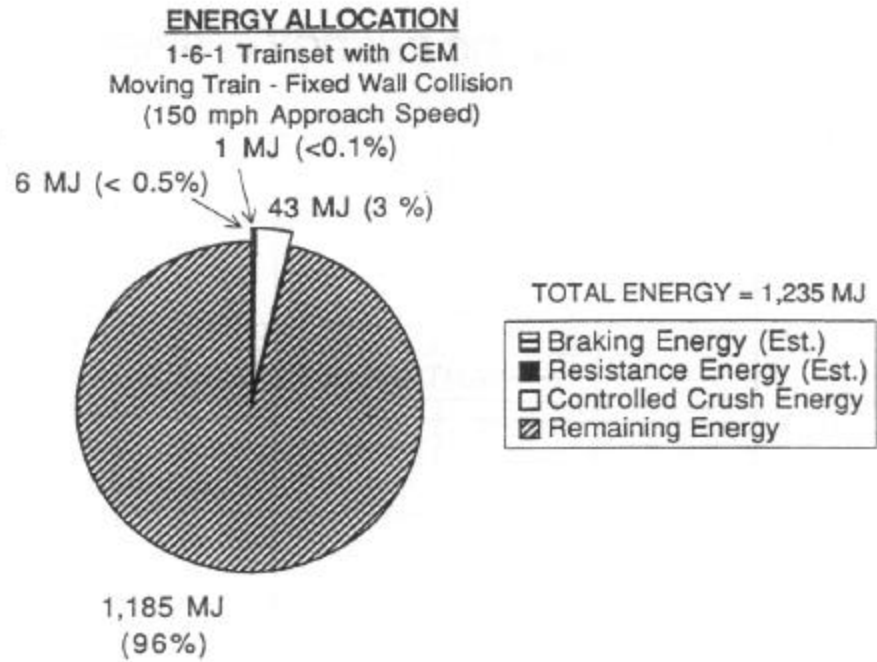

Figure 3.2

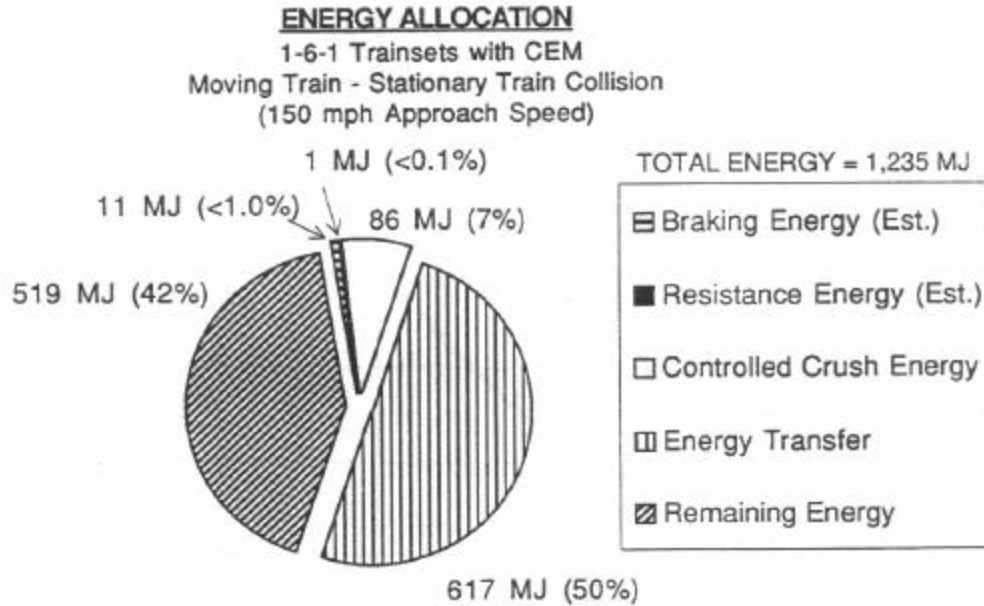

Figure 3.3

Structural Crashworthiness Panel Discussion

STEVE DITMEYER: Sorry. Grady, you think that question would better go to the entire panel?

GRADY COTHEN: Yes.

STEVEN DITMEYER: Because you asked a number of people. So why don't we get the other panel up here, and then restate the question again, and let's give it a shot.

GRADY COTHEN: Okay. I can imagine FRA specifying in-strength that is equal to or exceeds the current North American requirements for the resistance to a static load at the collision post, at the bottom of the collision post, for instance, or at the corner post, or some other place, the in structure of a vehicle. And somebody looking at it and saying, "Too much weight, so I'll use material that will withstand the static compressive force, but I'll use a new material. Let's say I'll use an aviation material. I'll use something that is very lightweight and therefore very brittle." And at some point, just above 800,000 pounds, it snaps. Is this the issue that's been raised, or am I misunderstanding the issue?

HERB WEINSTOCK: At the risk of playing moderator, I'm afraid I did a terrible thing, and I brought everybody up while you asked the question. Did everybody hear the question?

GRADY COTHEN: I'm looking at Dr. Cihak or one of these engineers here to restate the question in a way that the engineering community can understand it, but I think I have heard people talk about the fact that there's a deficiency in both UIC and North American standards to the extent that when we specify, for instance, 800 GIFs, that we are talking about something that assumes it's going to take that amount of force not to form. On the other hand, at 801, if it snaps, we have lost the ability to control the absorption of energy with the further deformation of that unit. That is a deficiency in the standard. How would we correct that deficiency in a way that does not constrain the imagination of the design engineer?

HERB WEINSTOCK: Can I ask people to comment on that starting from my left, starting with Frank?

FRANK CIHAK: I don't think I'm qualified to respond to that directly, but I'd just like to make a comment about modeling. I'm not a modeler, but I had some interest in engineering history, and I seem to remember that the principal designer of the Golden Gate Bridge designed the bridge, and they only had three iterations of the design. Of course, this took weeks and weeks and weeks of thousands of man hours of engineering, but it came out pretty good, and it only took three shots to do it. I think they had some experience base to operate from, though.

PANELIST: I can make a few comments. The concerns you expressed are addressed in various ways currently in specifications. Let me say specifications. There's nothing in the current FRA regulation and there's something but really very little in the collection of AAR standards that has been talked about. There is one thing in the old AAR passenger specification, which is a requirement that materials be ductile enough to have a certain spread between the point at which they break and the point at which they begin to permanently deform. There's better ways to address that particular thing now. The way it's addressed in specifications is the materials which

are permitted to be used to construct the cars are only materials which had been proven by experience to be tough as delivered and after all manufacturing is completed; that is, after all welding is completed. Basically, they're materials which can be welded to the various codes that are called out for welding.

Another point that comes to mind is, if you're thinking about the 800,000 pound buff load requirement, you're thinking about compressive load case. In general, in such cases the failure is stability-related. So the load versus deflection curve is likely to build up to a value and then, all of a sudden, because of stability-induced failures, level off and perhaps even decrease. And I think we saw that sort of behavior in one of the presentations today.

HERB WEINSTOCK: Brad, would you like to comment on that, the ability of using a single number, saying you shall not yield given that number to reflect the energy-absorption capabilities or crash management?

BRAD: Were you asking me or John?

HERB WEINSTOCK: You or John. Interested in an English viewpoint.

JOHN LEWIS: I might be a bit thick, but I'm still not sure I fully understand the question. I don't think the specifications should make any reference to what materials are suitable or unsuitable. As designers, we're far better at that than legislators. And what we should not be doing is stifling original and revolutionary, or even evolutionary design. What the specifications should do is make it very, very clear what the design is trying to achieve. For example, we've talked, or Ron talked this morning about aluminum welds snapping like carrots under certain situations. Now, if you build a vehicle from aluminum, and it may meet the crew load, if all the welds snap like carrots as soon as you exceed the proof load, it will not absorb the energy. And therefore, by specifying a certain amount of energy that needs to be acquired within a certain distance, you are sort of implying a certain requirement from the material. Within BR, we take our specifications perhaps a little bit further, and specify things like there should be no jagged edges; rumps shouldn't form that could cause override; there should not be any catastrophic failures during the energy absorption and this sort of thing. But I would suggest it would be very, very wrong to specify a list of acceptable materials.

HERB WEINSTOCK: How about a list of acceptable characteristics? Frank had noted in his discussion that one of the very important things was compatibility of vehicles on a common system. And I had noted that in a collision between two vehicles of unequal strength, it will be the weaker vehicles that will take all of the crush. So that becomes a rationale for potentially talking about a maximum or a minimum strength of the material, of the structure.

On the other hand, the other argument is, what we do want to do is absorb energy in the collision in a controlled fashion, which implies that a deformation must exist. So we may be, the question that I think Grady was asking is, we may be putting ourselves in a trap condition by specifying a minimum strength and only a minimum strength rather than also talking about a deformation capability at a strength level or at some level. Any thoughts from the SNCF, GEC on the subject? Sort of, yes sir?

LANCE SLAVIN: Well, perhaps I'm stating the obvious here, but if you want to have crash energy management, as I said before, once you've decided what the force is that corresponds to the acceptable deceleration for your particular train set, then maybe it's obvious, but the proof load that you specify has to be below that load. Otherwise the crashworthiness will never come into play. If you specify a proof load above the force that your crush operates at, the crush will never operate. So hopefully that's obvious.

HERB WEINSTOCK: So your thought is that one should be specifying from that standpoint is initial deceleration level. Is that right?

LANCE SLAVIN: Well, the deceleration level you wish to maintain inside the coach. If you specify a proof load higher, for whatever mass of train set you have, if you specify a higher proof load than corresponds to that deceleration rate, then you're going to get a higher deceleration rate.

GRADY COTHEN: And I think that we have been around the mulberry bush on starting with the deceleration rate, and Larry properly called us to task on that, in the sense that, while that is the ideal place to begin, from the point of view of current state-of-the-art in the engineering community, to translate that into impacts on individual designs, it seems to be a bit of stretch. I think everybody had to agree that's the place to start.

I'm going with a much more practical question here. If we traditionally are building rail cars, let's say, of steel construction, or aluminum of a certain grade, and we know what's going to happen once that front-end structure begins to fail and we know that it will continue to, as long as the force is uniform, continue to fail at a relatively predictable way. And in failing, it will absorb energy, we all have some degree of confidence, because we are now going to involve the center sill, for instance, in the collapse. It will begin to bend probably. In the locomotive crashworthiness research that we've done, probably before everything else ends up eliminating an occupied volume. Suppose we have creative substitution of materials, or inappropriate inattention to detail, which has been mentioned here. And beyond the proof loads, we have a sudden and complete catastrophic failure at some point. And we do not engage the rest of the structure in controlled crushing. I've heard several references to the fact that the regulators are deficient in not addressing that aspect of crashworthiness. And I've heard no suggestions as to how we might improve our performance. I agree we shouldn't be specifying materials. That's not our role. Nor should we be writing specification. That's not our role. Presumably there's a way by way of appropriately crafted performance standards, however, that we might address that need.

JOHN LEWIS: Might I suggest that you don't start with accelerations. I don't think that is the place to start, for the simple reason, if you have vehicles of widely different masses, you end up with widely different forces. And if you have vehicles colliding with widely different forces, you'll get one vehicle collapsing preferential to the other. Because you can have a range of collisions, you need to start with the force. Because that is, you need to ensure that one vehicle's collapse characteristic is reasonably consistent with another; otherwise, you'll always get the weaker one collapsing first. Now in BR, we have locomotives weighing 120 tons. And we have multiple units weighing as little as 35 tons. Now, that's almost a 4-to-1 ratio. If you start with accelerations and derive a force based on that, you've got a 4-to-1 ratio in force, and that could be disastrous.

HERB WEINSTOCK: How would Amtrak specification do on that, given that it does a combination of specifying minimum force capabilities that must be achieved without failure. It also specifies levels of controlled crush energy that has to be provided for. Could something in that form be phrased as a specification, that would do better than strictly saying 800,000 pounds buff strength?

DANIEL PALARDY: Well, I believe that some kind of buff load requirement has to be kept. First of all. The question is, does it has to be kept at 800 kps the way it is now? Okay? Second of all, I will believe, and I think it was shown this afternoon, that state-of-the-art length of crushable zones are about in the order of three feet today. The crush zone could be four feet at the start. You'll crush about three feet. I think both people from BR and from SNCF have been throughout the full cycle of designing, testing, and they both came out with that kind of length of crushing zones in the order.

HERB WEINSTOCK: So we've had a couple of discussions during the course of the day--

DANIEL PALARDY: Herb, I wasn't finished yet.

HERBERT WEINSTOCK: Oh, I'm sorry.

DANIEL PALARDY: This being said, we have state-of-the-art length where we could absorb energy. And now we have to define the force. The force is simply--not simply, but--could be defined if you want to start on a g level scenario for the particular train set, then you could come up and define the force in order to reach the g level. But this is only through, like Mr. Lewis was saying, for a defined train set. So my thinking is that people doing rulings should not put in g level. They should realize that state-of-the-art length of crushing is about three feet. And from that, they'll decide if they want it at 800 kps or if they want it at 450 kps or anywhere in between. And from that, you'll have a configuration of a train set.

HERB WEINSTOCK: We've gone through several kinds of discussions today. And in the organizing package, there was intended to be a little bit of method behind the organization of the papers, starting this morning with what represented North American design practice over the years in traditional requirements. We then went into discussions of how people might go about or what kinds of questions they would have to ask if they were to deal with performance requirements where performance is measured in terms of occupant survivability. We then moved on to analytic approaches, analysis approaches for being able to predict design capabilities. And we then proceeded into applications of current technology and of the state-of-the-art into the design of the most modern of our train sets, notably the American Flyer, the TGV, and the English crashworthy design. I'm wondering whether we might be able to comment a little bit about each of these areas, particularly predictive models, which was part of our discussion. And things like the energy that must be dissipated in the crash becomes strictly a function of collision speed. And the mass of the vehicles. This becomes fundamental physics, as I thought John had said. Bounding analyses, simulation models. Those are the right tools. With the analysis tools we were talking about, the criteria of survivability or prediction of survivability, the right kinds of approaches. We're okay on that discussion.

PANELIST: Well, I'll respond to that. I think the types of analyses that are being done, and the approaches, are certainly the right approaches to be asking the questions of what can we do,

what's possible. They're the right tools, as we've seen in this afternoon's talks, in terms of designing the train sets of the future and making those safer and more crashworthy. And I think some good points are made in this last one, though, in that you have to be very careful. And this is coming from my point of view as an analyst, of using those analytical tools within any sort of rulemaking or regulation, because it's so difficult to validate those without doing tests. And in that sense, if you're doing the tests, why don't you use that as your validation. So I think that there's a lot of very good analysis going on, but it's difficult to use that in terms of the rulemaking or regulation.

HERB WEINSTOCK: And in terms of test experience and design experience, currently there are definite changes in the state-of-the-art of design of passenger cars. And especially in terms of crashworthiness as evidenced by both the British experience, the American Flyer design, the French design. And I was wondering whether people might be interested in commenting on how this might affect commuter car design and transit car design. Frank, you want to take a crack at that?

FRANK CIHAK: Well, the major difference obviously being the maximum speeds and the average speeds. Average rapid transit train speeds schedule speeds over the entire route might only be 22 miles an hour in many cases, so the collisions occur in the range probably ten to fifteen, 20 miles an hour, most of them. And that's well within the range of existing modeling. And particularly existing equipment, to take care of those situations. Commuter cars, I think that's one of the reasons why we're here today. To ascertain the effect and response of all of this information we're gathering into the design of those kind of cars.

HERB WEINSTOCK: Yes, Alan? Robert, I'm sorry.

ALAN BING: I've very much enjoyed listening to all the very impressive research from Britain and France. I'd like to ask both those teams, for the benefit of those who plan and fund research here in America, roughly what all that work costs in terms of money or man years or person years of technical labor. That's question one. And the other one, more of a technical question, I wondered if either team had some thoughts on what happens when a vehicle designed with advance crashworthiness features collides with an older vehicle that doesn't have those features. My first guess is that it makes things a bit better, but I'd be interested in your thoughts on that situation.

JOHN LEWIS: Could I start off by answering the financial question? Is this working?

HERB WEINSTOCK: You might want to get a little closer.

JOHN LEWIS: As far as the British effort was concerned, the funding was as modest as our conclusions. The total funding was about 3-4 million pounds, including all the crashes that you saw, the full-scale testing, computing, manpower, instrumentation. And so on. So it's a pretty modest program in terms of funding.

HERBERT WEINSTOCK: That translates into seven or eight million dollars?

JOHN LEWIS: Yes. Seven, six million.

HERBERT WEINSTOCK: Six million dollars.

JOHN LEWIS: And as far as translating it to commuter cars is concerned, a lot of our work was directed towards commuter cars. And didn't have the scenario or had a locomotive hauling a collection of coaches behind it. So most of our work was directly applicable to commuter cars.

HERBERT WEINSTOCK: Mr. Cléon, do you have an estimate of the investment?

JEAN LEGAIT: Well, for the investment cost, I think we finalized it on DUPLEX TGV. And I said earlier, and maybe got a different point of view on that matter. But we, from the SNCF's point of view, feel that's all passive safety improvement, DUPLEX TGV with something like one percent of the total cost of the project. Which actually, myself, I don't know. But later designs lack XTER, for instance, because they were taken from the very beginning, resulted in very little designing cost compared to what we've been paying for DUPLEX TGV, for instance.

And coming back to your second question, between front-end collision that could occur between a conventional vehicle and a crashworthy vehicle, I actually haven't been making any simulations on that. I'm beginning to think about it, because, you know, the first one, we raised the question. And actually, for instance, on the exterior, I very strongly believe that's all I've been shown, like step one to step three, will collapse very quickly, and the conventional vehicle will hardly be deformed. After that, when structural deformation starts, the driving cab and the conventional vehicle that I cannot answer to your question very simply. But what I think is, by making crashworthy vehicles, we've been increasing static loads on passenger areas, but by doing some controlled deformation of the fronts and of the leading vehicle, that was not done by increasing very much efforts. And therefore I'm not sure that existing vehicle would suffer very much as people tend to think, after a frontal impact with a crashworthy vehicle. That's my personal point of view. I've got to do some further analysis. That's my point of view at the moment.

HERB WEINSTOCK: Thank you very much.

JOHN LEWIS: Can I answer that second part from BR's point of view, as well? Because it raises an important point that was raised earlier. We do traditionally have vehicles that are built 30 or 40 years, and so you can't suddenly introduce vehicles that are very much weaker than those running around. What we've tended to do is have the main passenger compartment strength of a similar magnitude to vehicles that are running around at the moment. And have softer ends. Now, the softer ends will have two effects. One, they will cause the new crashworthy trains to collapse at the ends first. But what they'll also do, hopefully, is stop the very large forces being built at the median level, which then lead to overriding, and therefore, by reducing overriding, one would expect casualties to be reduced. Now, the overall effect would not be as good as two crashworthy trains, obviously. But there will be a net beneficial effect.

FRANK DUSCHINSKY: John, I would have the following question. You have showed us the same goes for the SNCF, the many steps you went through over a number of years. Now, would you like to reflect a little bit, or tell us where is this some new regulations, or what would be the process? I believe these are still requirements which you put into the specification of BR, but they are not necessarily rules established rules for the country. Is that correct?

JOHN LEWIS: The work that we've completed has found its way into mandatory specifications for vehicles built for running on British Rail now. They have to be energy absorbent. And the collision energy management sort of basis has specified the amount of energy and the forces that the energy has to be absorbed at. The maximum deformations, all these are specified. And these are mandatory specifications, so you cannot produce a vehicle driven on BR which doesn't meet them. Now, that's just for BR. SNCF presumably will answer for themselves. But what we are working on at the moment, in conjunction with SNCF, the German railways, Portuguese railways, Polish railways, they're looking to set a similar sort of specification for the whole of Europe. And this will obviously take a long time, because there are national differences, there are national prejudices, and there are obviously great difficulties when you try to set these things over the whole of Europe. But we are attempting to do that, and we're hoping to get European Union Common Market funding to do some testing and development with the end result of trying to get the specifications together.

HERB WEINSTOCK: So I understood the answer to that being that in Great Britain, in the United Kingdom, you do have a set of standards specifications based upon your research and based upon the requirements you would develop from your tests?

JOHN LEWIS: Yes.

HERB WEINSTOCK: And in fact, UIC is working on a project now in order to develop some crashworthiness standards, but they're not ready to speculate as to how long it will take them to arrive at an agreement?

JOHN LEWIS: It's a four-year project. As I say, we're waiting at the moment to get the go-ahead from the European Commission who are going to pay for it. When we get that go-ahead, hopefully in September, there will be a four-year project.

HERB WEINSTOCK: I was wondering if SNCF could comment on how the crashworthiness research they did related to the TGV has influenced their other trains operating in France? Or has it been a separate, independent effort?

JEAN LEGAIT: I'm not sure I understand the question. How development we've been doing on crashworthiness research influences other trains?

HERB WEINSTOCK: In terms of the design requirements on trains for lines other than TGV. Has this crashworthiness research become, been used in other design specifications, passenger equipment?

JEAN LEGAIT: Yes, of course. While DUPLEX TGV was the first train set with passive safety concepts, after that, the second one was Dexter. There's another, a third one, which is a commuter train, an electrical commuter train, which was also designed for passive safety concepts.

And all those concepts are have got the same basis, but the standards that we are aiming are different, depending on the type of train sets. For instance, the electrical multiple unit train sets runs on a track with low-level crossing, for instance. Therefore, design concepts were totally different, would have been applied on other trains. No structural deformation, anti-climbers and small removable devices absorbing energy in different ends. That's a total difference, where we've been showing here. And therefore, yes, DUPLEX TGV and two other train sets have been

made after that. And also, we've got some new train sets coming. And every time passive safety is inside standards on these train sets.

HERB WEINSTOCK: Let's see. It's past 5:15, so I think unless there are pressing questions, I'd like to thank everybody for their excellent participation in these sessions, and the information and the forceful and informative expositions that we've had. And suggest that we adjourn for the evening and reconvene tomorrow morning.

[Applause]

Locomotive Crashworthiness Research

DENNIS RAMM: I'm Dennis Ramm and I'm the chair of the next session here of structural crashworthiness, locomotive section. I have three presenters here this morning, Ron Mayville, the manager of the Applied Mechanics Group at Arthur D. Little where he's been employed for about 15 years. His area of expertise includes fracture, fatigue, and wear. He has a P.E. in structural engineering. He did his graduate work at the University of California, Berkeley and spent two years at the Farmhauser Institute in Germany.

The next presenter will be Harvey Boyd. Harvey Boyd graduated from the University of Illinois in 1968 with a Bachelor of Science in Mechanical Engineering. He joined the electro-motive division of General Motors in 1969. After working several years in the traction systems area, Harvey transferred to the car body section where he's responsible for noise control, vibration and component design. For the past 15 years, Harvey's been involved in cab design, cab ergonomics, safety appliances and locomotive crashworthiness.

Our third presenter this morning is Alan Bieber from General Electric Corporation. Al has a Bachelor of Mechanical Engineering from Pratt Institute in Brooklyn, New York and a Master of Mechanical Engineering from Cornell University. His background is he worked in the General Electric engineering training program, rotating assignments in propulsion, diesel and locomotive engineering. He transferred from that area into truck design area for export locomotives and he is currently working in the locomotive mechanical design as a unit manager. With that we'll turn it over to Ron.

RON MAYVILLE: Good morning to everybody who came. My name is Ron Mayville and I'm presenting a work that was completed about a year and a half ago. It was about a year-and-a-half program. That included several participants and it's a little difficult to acknowledge them all but I'll try during the talk.

The title of the research we did was locomotive crashworthiness research and the primary impetus for this work was Public Law 102-365 which said among other things that the Federal Railroad Administration must consider the costs and benefits of equipping locomotives with various crashworthiness features. This effort was funded by the FRA and was administered by the Volpe Center here. Public Law 102-365 stated several components that needed to be looked at which included the anti-climber, collision posts, glazing, a number of components. Today I'm going to be focusing exclusively on some of the structural components that we looked at. The baseline to consider costs and benefits for improvements were locomotives that just satisfied S-580. As you'll hear as I talk a little bit more through the talk, one of the things that we discovered through some of our analysis were none of the locomotives that were built after August 1990 when S-580 went into place just satisfied S-580. They all exceeded the requirements of S-580 generally by quite a margin. One of the difficulties we had in the program was to come up with an idealized locomotive that just satisfied S-580.

The project team included several people, most notably CALSPAN Corporation and you'll hear later today from Bob Galganski. The contribution that they made was on the occupant's survivability modeling and analysis. Also Parsons Brinkerhoff who helped on some of the engineering side. I certainly would like to mention the Federal Railroad Administration staff and

the Volpe staff as well. This was very much a team effort project. Finally I want to also mention that we had fantastic cooperation from the locomotive manufacturers and other people in the industry. As part of the project, we visited the locomotive manufacturing facilities, repair facility. We even had the opportunity to go on-site to a freight train accident that occurred in Texas as a way of getting more information about the actual structural damage that occurs in these types of collisions.

Just a review of S-580. I know most of you are familiar with it. There are some other requirements not included on this sheet and apologize if the font is a little bit small for those of you in the back to see, but almost all of the slides that I'll present are included in the book, so you can look if you have a little difficulty. One of the requirements of S-580 is that the collision post have a shear strength at the deck of 500,000 for each collision post and an ultimate strength of 200,000 pounds at 30 inches above the deck. Another requirement is that it be equipped with an anti-climber with a vertical strength of 200,000 pounds and then a short hood structure the characteristic of which is that the product of the thickness times the yield strength is equal to 0.5 inches x 25 psi.

Over the last couple of days we've focused primarily on passenger vehicles. This study was geared exclusively except for a task toward the end of the project on freight trains and particular freight locomotives, and these are some of the biggest, heaviest rail vehicle objects. There are six-axle locomotives weighing 420,000 pounds. So when there's an accident at a high speed with a freight train, you can often see a lot of deformation as you can with passenger vehicles. This is a photograph from the accident that I mentioned that took place in Texas in 1994. This was actually one of the--this was not a lead locomotive but the second locomotive in one of the consists. At least one of the consists in this accident had five lead locomotives and then about 110 trailing cars. But you can see the enormous amount of deformation. By the way, the closing speed in this accident was about 65 miles per hour.

Another characteristic from this photograph, and I'll show another one later, is the degree of underframe bending. In our initial modeling, we didn't include underframe bending as a way of evaluating different features, but we modified the model later to include underframing.

I think it's useful and we've seen various graphs over the last couple of days like this one to get an idea of the order of magnitude of energy that we have to deal with in these types of collisions. This is a graph showing the kinetic energy in millions of footpounds, I'm sorry that it's not in megajoules as a function of closing speed if you had just single locomotives traveling at equal speeds colliding with each other. This would be the amount of energy that would have to be absorbed by one of those locomotives in many different ways possible. So for example if we take a closing speed of 30 miles an hour which means each locomotive going 15 miles an hour, we have about three million footpounds. If the closing speed goes up to 60 miles an hour, we have 12 million footpounds. Again, this is for a single locomotive. If you have, as you often do, multiple locomotives in a consist, then the energy goes much higher.

How can this energy be dissipated? There are a couple of different ways that one can think of right off the bat. For example, crush of the collision post, if you're able to get a crush strength of both collision posts of say five hundred thousand pounds and a crush of three feet, then you can absorb 1.5 million footpounds. If you can crush the underframe at a strength of five million pounds for just a foot, you get five million footpounds, and if the locomotive were to lift override

another locomotive so its center of gravity were raised ten feet, then you get four million footpounds. You can see that these are on the order, I think the conversion to megajoules from millions of footpounds is something like 1.35. So the underframe crush for example, is on the order of seven or eight megajoules. But all of these numbers are on the order of what you would see, this is just for single locomotives of around 30-mile-an-hour closing speeds. So it just tells one pretty quickly I think is not to expect too much as for the closing speeds way up here, 60 miles per hour especially when you have multiple locomotives in a consist.

This is a photograph from an accident that I'll be talking about a little bit later but it just shows a case in which a locomotive has overridden another locomotive and this is one of the ways in which energy was dissipated in that particular accident.

The approach that we used in this project, and again I just want to emphasize that the real objective of the project was to devise possible design modifications for improving crashworthiness and then evaluating those modifications to see how much they improved crashworthiness and how practical they were. That was the basic objective. But to do that we had to develop some models. It's primarily those models and their application that I'm talking about today, though I will be touching on a couple of modifications that we looked at.

Basically, the approach to the project was to do a lot of information gathering as we often like to do including looking at locomotive design and construction. Again, we had a lot of cooperation from the manufacturers. We got drawings. We got to go visit the plants to see how the things were put together. We had discussions with industry about their views on crashworthiness and what the constraints they had to deal with were. We reviewed lots and lots of accident reports although as you can imagine accident reports generally do not contain a lot of information about structural damage since their primary focus is to understand the cause of the accident and how to prevent it from occurring. But some of the reports did have some information. Then also looking at previous studies.

I think as most of you know, there was quite a bit of activity centered actually here in the Volpe Center in the mid-late 70's. We looked at that as well. Then we had parallel efforts in which we were developing a computer model both for looking at the train collision and the behavior of the occupant. I'm not going to be talking about this at all today, Bob Galganski will touch on that a little bit later, and validating the model using the accident reports. Of course, this is a bit limited, the ability to do this because as I said the accident reports don't include as much detail as one would like. Nevertheless it was of some value.

At the same time, and something that I'm not going to be talking about a lot today, we generated design concepts. We had idea generation sessions including people who are not very familiar with locomotive design and some people a little bit familiar with locomotive design. Then making layouts but not detailed designs, making strength calculations and weight and cost calculations, combining both the modeling and these ideas and evaluating them to see what benefit they seem to provide. This was very much done on a feasibility point of view more than trying to come up with detailed designs. In other words if you change the strength of the collision post and ductility, what effect could that have. But it was recognized early on, not being locomotive manufacturers although we did the best we could to understand all the constraints based by industry, we recognized that we might not see everything.

This overhead is difficult to see in the back. I tried it. Before I started the talk, I apologize but it is in the book if you need to look at it. What this slide describes is our overall modeling approach. It's not dissimilar to what you've seen before. We used finite element analysis to get the crush characteristics of the key front end components of the locomotive. I should have said before that our focus was almost exclusively on the head-on collision for the locomotives. There are many different types of collisions that can occur with a locomotive, but for expediency if you will, we chose the head-on collision between two freight trains as being representative of one of the most severe accidents that a locomotive will face and improving crashworthiness for this accident would have benefit for other accidents. That was an implicit assumption of what we did.

In this module, if you will, we used the finite-element analysis to get the crush characteristics of different front-end components and I'll get into that in a little more detail. These crush characteristics were then used in our collision dynamics analysis, not dissimilar from some of the things you've seen before, but instead of one-dimensional, this is a two-dimensional model and allows motion in the vertical plane. I'll get into more detail on this. But the complex crush characteristics of these components were included in simpler elements in this collision dynamics model. The output from this collision dynamics model was two things. One, the amount of crush of various components and the component whose crush we were most interested in. In this case, it was the short hood and collision post because that's the stuff that gets pushed back into the cab and threatens the operator of the locomotive. In addition to that, we also got the crash pulse out of the model and this was used in the program ATB that Bob Galganski will talk about to try to model what would happen to an occupant. Without going into this in much detail, one of the difficulties we faced here was what position to assume for the occupant. We had lots of discussions trying to decide what an occupant would do in the face of a collision. As you know, not an uncommon reaction is to jump. I might try to do that myself. But in a number of cases, of the few cases there are, an occupant will sometimes lie on the floor and ride out the collision and do so successfully in some cases. So that was the position that we used in most of our analysis.

Let me go into a little more detail of some of the individual steps. As I said we determined load crush responses for different components and the geometries that we modeled were derived from mechanical drawings supplied by the manufacturers. In order to keep this a little bit clean if you will, that is not to be looking at just one manufacturer's locomotive or another, we tried to derive some generalized components if you will by looking at different manufacturers' components.

We looked at four systems. One was the anti-climber looking at both vertical and longitudinal loading, the front plate draft gear support structure, the short hood structure and the collision posts, and the underframe. These were the different systems that we did finite-element analysis on to get the crush response. We used the program ABACUS and all the analysis for this particular project was quasi-static. As I mentioned before, the calculated strengths that we got for things like the collision post were generally substantially higher than what is required by S-580. So one of the things that we had to do was to idealize the load crush response in a way that would just satisfy S-580. So for example, this particular geometry is the collision post. It's one half the model so you have to use your imagination a little bit. This part right here is the collision post and this part right here is the short hood which is welded to it as well as other components. This shows a low crush curve that we got. It shows a peak which is sort of a buckling response to the short hood but eventually then the collision posts pick up. What I'll tell you is that our calculated low generally went above this and recall that the ultimate strength

requirement for the collision post, and this was loaded 18 inches above the deck. The S-580 requires 200,000 pounds ultimate strength. We generally calculated more than that but in order to satisfy our baseline of having a locomotive that just satisfies S-580, we capped it off at, in this case, 400,000 for two collision posts. That was something we had to do for most of the components, at least the components covered by S-580.

Here's another example which is not included in the book of the analysis for the anti-climber subjected to a longitudinal load. What you can see is that the load rises, and although we didn't calculate this far, eventually falls off as the different components buckle. But eventually the anti-climber gets completely compressed and then the underframe starts to pick up the load, so the load shoots way up as you apply a load through this anti-climber. You can think of this in a way as an energy absorber if you will. I haven't done the exact calculation of the area under this curve but it's not insignificant.

The collision dynamics analysis that we did was done with a commercially available computer program that some of you may be familiar with for other parts of engineering, called ADAMS. It's a multi-body system. I know that it's used heavily in the automotive industry and I think EMD uses it for some calculations as well. But the vehicles were simulated by three masses: the body and the two trucks. The body was allowed to move up and down and have pitch motion. The trucks were constrained to follow the track. There were elements between the truck and the body, both vertical and longitudinal springs and dampers. In addition, the spring characteristics were such that if the body moved down far enough, eventually the stiffness would become very high, representing what is a hard stop on an actual locomotive. Likewise if the body pitched up, eventually you'd have no load between the truck and the locomotives representing what can sometimes happen with the body separating from the truck.

One of the difficulties that we faced in this program was modeling override. We've heard a little bit about that over the last couple of days. If you look in the literature, you'll see a number of papers on this subject about override initiation. We recognize pretty quickly that it's a complicated phenomenon and that we could easily spend the entire project trying to deal with just this, override initiation. So instead what we did was to use a ramp, and we heard a little bit about how ramps can sometimes lead to override in passenger vehicles. We used a ramp to initiate override. So in other words, when these two elements come together, one is allowed to slide along this ramp. There's friction between that ramp. There are a couple of things that resist total override. So we allow override initiation to occur but the friction and just the inertia of the bodies can resist the override from progressing. In addition, these elements which I haven't described too much yet, I apologize, can be trapped. I'll get into that a little bit more as well.

Again, to summarize, we had a model that allowed override initiation to occur, just to start right away, but the model also included features that would allow override to be arrested. In some of the simulation it was arrested, in others it was not. I'll talk about that a little bit more. What I should have said before I got into that discussion is that the ADAMS model consisted of these bodies, but then also these, what we call, crushable elements. They're relatively simple elements, but they have a complicated load crush response that was derived from the finite- element analysis. In addition, they have the kinematic relationships that allow them to come into contact and transmit forces when they're within a certain distance. They can take both vertical and longitudinal forces, so you can get this trapping of say the underframe of one locomotive in the pocket here of the other locomotive.

In our original analysis, we did not allow any bending of this underframe, but in subsequent analysis which I'll describe a little bit later, we did allow some underframe bending which we think is an important deformation one. As I mentioned before, the output from these models include the degree of crush of each of the components in the acceleration history. But again, the component that we were most interested in in terms of crush was the short hood collision post. We estimated that if this were pushed back by about six feet then the material ahead of it would intrude into the cab and essentially result in a fatality for anyone who stayed in the cab.

Just quickly, a couple of things that we did in the beginning of the program was that we had to decide how we're going to deal with trains that can be as much as 100 vehicles long. Do we have to model every single one of those vehicles in our collision dynamics analysis? What we found is that we did not have to do that, that it was essentially satisfactory to predict the damage that occurred in the very first locomotive in head-on collisions by just modeling the lead locomotives, the heavy lead locomotives.

The first set of analysis that we did which is represented by the data in this curve was to look at the amount of crush, in this case the relative crush energy, in that first locomotive as a function of the number of locomotives. Really, what this says is the amount of crush in the first model vehicle is a function of equally heavy vehicles. What you see is that as you keep adding a heavy vehicle, a heavy locomotive, you get more and more crush in that first locomotive. One of the implications of this which has been pointed out I think already, if you have fewer lead locomotives such as you will with the new AC technology, then you're going to have less crush in the first locomotive.

The other analysis that we did was to look at the effect of trailing vehicles. In general, these trailing vehicles have a lower crush strength than locomotives. Box cars, trailer cars, lots of cars I don't know about, they have a lower crush strength which is represented by this dashed curve than the crush strength of the locomotive. What we see is that these trailing vehicles do not add much crush to the very first locomotive. Therefore, to a good approximation when you consider all the things that are approximated in this kind of model, it's reasonable to leave out those trailing vehicles. One can ask, where does all the kinetic energy go if you calculate the kinetic energy of a 100-vehicle train, you get very frightened very quickly because there's so much energy. What seems to happen is because of derailment effects and crush of some of these trailing vehicles, a lot of the energy is consumed by the work that is put into moving the vehicles off the track or crushing the trailing vehicles, and from breaking as well.

After developing the model, we needed to validate in some way and we did this by looking at three different accidents which we called scenarios. These are all head-on collisions and the first one, I'll just describe how this diagram works. What it shows in this dashed line is the interface between two trains. This train on the left has three locomotives, each 140 tons and zero trailing cars, moving at 18 miles an hour. This train also has no trailing cars with four locomotives of different weight that was standing. So this is an 18-mile-per-hour closing speed collision. There was no override in this particular case and no serious injuries, and also by the way, no S-580 locomotives.

In the second scenario, the closing speed we looked at was a bit higher, 30 miles an hour, and as you can see, the consists are bigger in this particular case and also in this case one of the locomotives was overridden, the cab was crushed, and there was one fatality.

In the third scenario we looked at, it had a locomotive that was overridden that was an S-580 locomotive. There were three injuries and again one relatively large train, a closing speed of 43 miles an hour.

One of the things that I should have mentioned is that as part of this project, this issue of override was, as you can imagine, a major one and there was a lot of discussion about the extent to which the anti-climber in locomotives satisfying S-580 really protects against override. As I'll show you in a few minutes, there are situations for which it does not prevent override, but I'm sure there are many situations for which it does.

So I'll go over this quickly because this is a relatively a simple scenario. Again, this is the 18 miles an hour and the model that we used predicted that no override would occur and there was actually a very limited amount of crush. In fact, the load just got up to the point where it was loading the underframes and crushing the anti-climbers, but no override and the crash pulse was relatively low, but a relatively easy test if you will.

The second more significant scenario was one in which the two trains hit head-on at a closing speed of 30 miles an hour. Neither locomotive satisfied S-580, but one of the locomotives as you can see here was overridden and there was substantial crush in the cab. In this case, the model predicted that override did occur and substantial crush in the cab occurred. I want to point out that the crush response that we used in the model validation was using the crush response of the actual components in these locomotives. So, for example, if it didn't satisfy S-580 or if the collision posts were stronger, we included that in our validation.

Now as I said, this locomotive did not have an anti-climber that satisfied S-580, but it was our feeling in the model suggested that even if it had, the override still would have occurred. I would just like to go into that for a few minutes. This is just another picture, since I know that one was kind of small, of the same accident. You can see the locomotive that did the overriding was quite a bit higher, lifted off the trucks. I guess one other thing I wanted to say that I meant to say in the beginning is that we recognized in this project that the direct in-line collision between two freight trains is one type of collision and there are many others. Perhaps we'll hear a little later today, for example, a not uncommon collision when collisions do occur are actually in curves or when locomotives are at angles to each other and where there can be much more of a glancing impact than the type that you see here.

This graphic which I'm going to show you, a little different form of in a minute was shown by Herb Weinstock yesterday, but it shows the different types of interactions that can occur. That's one of the difficulties in this type of analysis, deciding exactly how the interactions will occur. You can imagine the scenario in which override initiates and you get trapping of one of the draft gear support structure between the anti-climber and the draft gear support structure of the other locomotive. But a couple of things can happen. If you shear off this draft gear support structure which is strong and very stiff but not necessarily very ductile and it's not intended to be, if you shear that off then there's a ready path for this locomotive to continue overriding and to challenge the collision posts. On the other hand, if the draft gear support structure of this locomotive were to be broken first, then there's an opportunity for the underframe to be trapped between the anti-climber and the draft gear support structure of this locomotive. But as the speed keeps increasing, increasing, sooner or later you'll break off that draft gear support structure and then

have override and then be depending on the collision posts and other friction events to prevent total override and crush.

I want to show this little diagram which I used often in the project and I apologize to people who can't see, but these two viewgraphs turned out to be very useful for showing how override can occur and seeing how different interaction can occur between different types of structure. We've used the same device as probably other people have who are looking at the interaction between passenger vehicles and locomotives.

I think what I'm going to do instead of showing the picture that's in the presentation is show a little larger picture so they're a bit clearer because this is kind of confusing. This is a photograph of the locomotive that was overridden. Let me orient you a little bit. This is the coupler here of the locomotive and then we have the striker plate and then this begins the pocket of the draft gear support structure. This is where the deck top plate starts and then a lot of the equipment has been damaged back here. Part of the reason I'm showing this is what you see is a lot of shear deformation and while some people were maintaining that what the anti-climber does is prevent the coupler from just rising above, the coupler of the challenging locomotive is rising above the anti-climber and going by. In reality what appears to happen at least in this accident, there is so much shearing, things are being sheared off. There's really not a lot of lift.

In this top photograph, again it's a little difficult to see, but you have to look through. This is again the locomotive, but this is the locomotive that was overriding. If you look through here you can see right through the end here to the other side of the track which shows that the draft gear support structure was broken off of this locomotive. That same thing happened in the next accident that I'm going to show you.

The third scenario we looked at occurred at a closing speed of 43 miles an hour. In this case, the locomotive that was overridden did satisfy S-580. It also happened to have collision posts whose strengths were much in excess of what's required by S-580, the ultimate strength. What happened in this accident is that the collision posts arrested the override quite successfully. Again this is at a 43-mile-an-hour closing speed and the model predicted that relatively well. But the other point is that this was a case where the locomotive did have an anti-climber that satisfied S-580 yet it was overridden in this particular case.

This is just because I feel bad that the pictures don't turn out quite as well, this is larger picture showing that damage. You can see the shore hood structure here. This was evidently a little bit offset to one side. You can see the crush of the shore hood structure here but otherwise things do seem to be relatively intact and the collision posts seem to have done their job quite well.

I just wanted to say a few words about the features that we included for looking at underframe bending. Including this feature in the model became rather important as we started to look at a feature that was called interlocking anti-climbers. One of the things that came up in the project which is not a big surprise is that there could be more benefit by making sure that the underframes of the locomotives interacted more in a collision. One of the ways that this might be achieved is by making sure that the underframes could somehow lock together by using such things as ribbed anti-climbers. There are whole strength issues. But these types of interactions will never occur perfectly in line with the underframes. They're bound to be a little bit off inducing some kind of bending into the underframe. We've seen many photographs in the

accidents of how underframes of rail vehicles are bent. So we modified the model to include some rotation and some resistance to that rotation of that underframe as well as some axial crush. We did some analyses where we looked at different offsets of the collision force to see what would happen.

This is a curve showing the bending response of the underframe, in other words, it has a sort of elastic stiffness and it reaches a certain plastic collapse moment and then rotates, in this case if it rotates down, sooner or later it will strike the ground and not be able to rotate any further. It turns out that things like, sorry if I'm not following these things exactly, but when you think about increasing the strength of collision posts especially if collision posts are loaded above the deck, there is a practical limit to the strength of collision posts that you can have because sooner or later you will exhaust the bending strength of the underframe. So there's no sense making the collision posts stronger than what the underframe can take. That's important to recognize.

On the other hand, what will happen when you get underframe bending, if you get sufficient underframe bending, sooner or later if the collision speeds are high enough and there's enough energy in the whole system, that bending especially if it's down or up, can act as a ramp that will start having override progress.

Then one more photograph from that accident I mentioned earlier just to illustrate how underframe bending can occur. This is a locomotive in which you can see that the underframe has bent down. In this particular case, which I think is in the unusual set of collisions, the bending occurred actually near the beginning of the shore hood whereas normally it has occurred a little bit further back.

I said that I wasn't going to say very much about the features that we looked at, but two that I'm going to just mention in this talk are interlocking anti-climbers that we looked at. This is just a schematic illustration of what it might look like. We looked at different concepts. Then also stronger collision posts. When I see stronger collision posts, I want to add to that not just stronger, but also with a certain amount of ductility. One of the criticism that I think we've heard is the great emphasis on strength but not on ductility of components.

This is just skipping over a lot of detail, the addition of two of the crashworthiness features that we examined, appears to improve the crashworthiness of brake locomotives for the collision scenarios that we studied, again for these head-on collisions. What this graph shows is the collision post crush as a function of closing speed for that particular kind of configuration. This is a five-locomotive configuration colliding with a two-locomotive configuration, and this just shows the ratio of the velocities in this particular case. For three different situations, one for a locomotive just satisfying S-580 and our models predicted for this configuration at a closing speed of about 30 miles an hour, you would get sufficient crush to endanger the crew. By adding stronger collision posts, and in this case, substantially stronger rather than the 200 kips at 30 inches, 800 kips at 30 inches, that you get some improvement, not a lot, but some improvement in the closing speed at which you are crushing the cab. Finally, if you add an interlocking anti-climber, in other words insuring that in some manner the underframes interact with the strong collision posts, because sooner or later those interlocking anti-climbers will disengage because of a ramping effect and then the collision posts will be challenged. You get still a larger improvement in the closing speed for this scenario in which substantial damage occurs. You can see that these speeds are within the 30- 40-mile-an-hour range which is not dissimilar to what

one might say could happen in passenger vehicles under certain scenarios. So I realize that's going over the details of some of the features we looked at very quickly.

Just to have a few conclusions, the study that resulted in the development of a computer model which we have subsequently applied in other cases both to cab cars and light rail vehicles and we evaluated some alternative crashworthiness features for these freight locomotives. The model predicts that override and cab crush can occur in locomotives satisfying S-580's under certain conditions related to head-on collisions with closing speeds on the order of 30 miles an hour. Again, it depends very much on how the locomotives interact. We modeled some pretty idealized situations.

The current anti-climber specification does not appear to be effective in preventing override due to the physics of these head-on collisions for these particular kind of collisions. Again, it's a vertical strength where we think that there's a lot of shearing going on. The final conclusion for today is the addition of stronger collision posts with ductility and an interlocking anti-climber do appear to improve great locomotive crashworthiness significantly. Thank you very much.

PRESENTATION

LOCOMOTIVE CRASHWORTHINESS RESEARCH

Locomotive Crashworthiness Research

**Presented by
 Ron Mayville
 Arthur D. Little, Inc.
 Cambridge, Massachusetts**

**at the
 Symposium on
 Rail Vehicle Crashworthiness Volpe National Transportation
 Systems Center
 Cambridge, Massachusetts**

24-26 June 1996

Locomotive Crashworthiness Research Introduction

Arthur D. Little participated in a project that included the development and application of computer models to assess the crashworthiness of freight locomotives.

- The effort was funded by the FRA and administered by the Volpe Center
- Public Law 102-365 was the primary motivation for the study
 - consider the costs and benefits of equipping locomotives with various crashworthiness features
- Baseline locomotives just satisfied S-580
- The project team included Arvin/Calspan and Parsons Brinckerhoff
- We obtained ready cooperation from the locomotive manufacturers and other industry participants

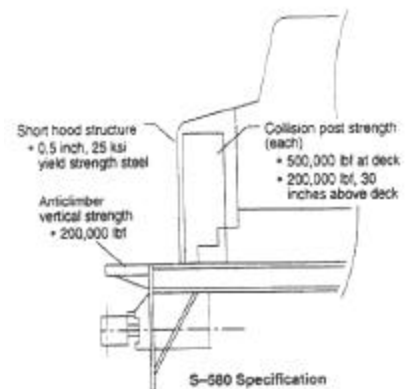

Locomotive Crashworthiness Research Energy Absorption Possibilities

The amount and manner in which a locomotive can absorb energy is limited.

- Collision post crush:
 $E = (500,000 \text{ lbf})(3 \text{ ft})$
 $= 1.5 \times 10^6 \text{ (ft-lbf)}$
- Underframe crush:
 $E = (5,000,000 \text{ lbf})(1 \text{ ft})$
 $= 5 \times 10^6 \text{ (ft-lbf)}$
- Override w/c.g. rising 10ft:
 $E = (400,000 \text{ lbf})(10 \text{ ft})$
 $= 4 \times 10^6 \text{ (ft-lbf)}$

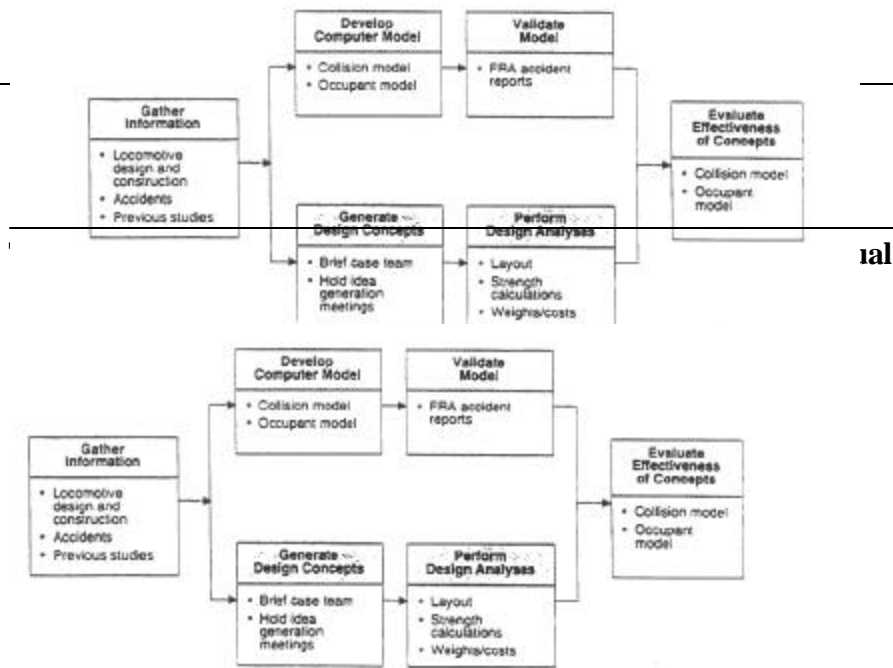
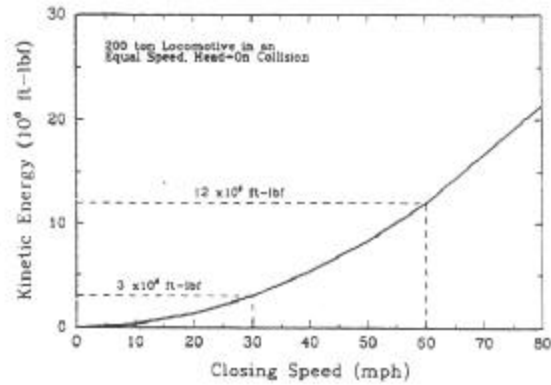

However, in this presentation we focus only on model development and application.

Locomotive Crashworthiness Research Computer Model

The consequences of a collision were simulated using three different commercially available computer programs.

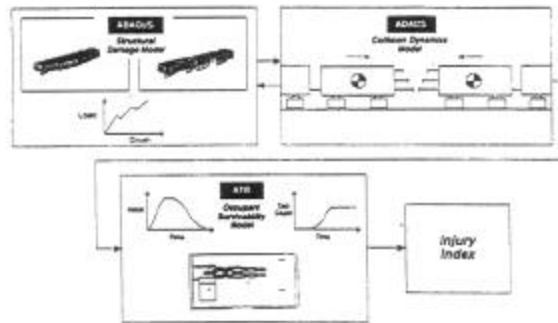

ABAQUS

- Nonlinear finite element analysis
- Quasistatic analysis used
- Crush of Individual components where necessary

ADAMS

- Lumped mass model
- Key structural components modeled as nonlinear, nonrecoverable springs
- Two-dimensional motion modeled

ATB

- Lumped mass model
- Occupant inertia and flexibility modeled
- Auto Industry injury measures used

Locomotive Crashworthiness Research Structural Damage Model

The load-crush responses of several front end components were determined.

- The component geometries modeled were derived from mechanical drawings supplied by the manufacturers
- Four systems were analyzed
 - i) Anticlimber: vertical and longitudinal loading
 - ii) Front plate/draft gear support structure
 - iii) Short hood structure/collision posts
 - iv) Underframe
- Calculated strength of components used on currently produced locomotives were greater than required by S-580
- The load-crush curves used in our collision dynamics analyses were idealized to just satisfy S-580

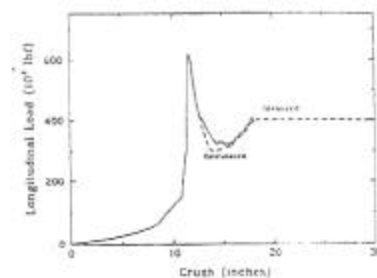

Locomotive Crashworthiness Research Collision Dynamics Model

The collision dynamics model employs relatively few elements but captures the key response of the lead vehicles.

- Vehicles are simulated by three masses (body and two trucks)
- The body can pitch and be detached from the trucks
- A ramp is used to initiate override but other components can interact to arrest override
- The output of the model includes the degree of crush of each of the components and the acceleration-time history (crash pulse)

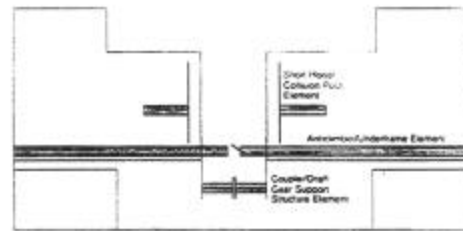

Locomotive Crashworthiness Research Multivehicle Effects

A number of studies were carried out to show that only the relatively heavy, lead locomotives need be simulated in order to predict the response of the first locomotive.

- Freight trains can have as many as 100 vehicles
- The number of lead locomotives has an important effect on first locomotive crush
- On the other hand, lighter trailing vehicles with lower crush strengths have little effect on first loco crush
- The enormous kinetic energy generally dissipated by movement of derailing vehicles and braking friction

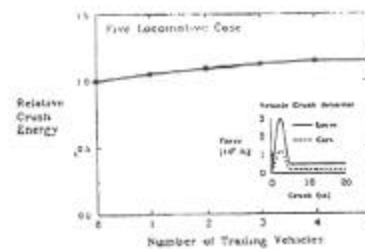
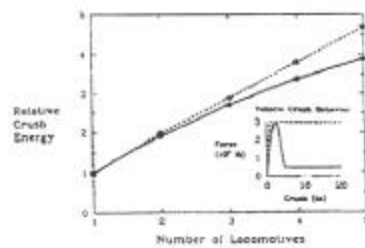

Locomotive Crashworthiness Research Crash Scenarios for Model Validation

Three head-on collisions were chosen for validation.

SCENARIOS MODELED

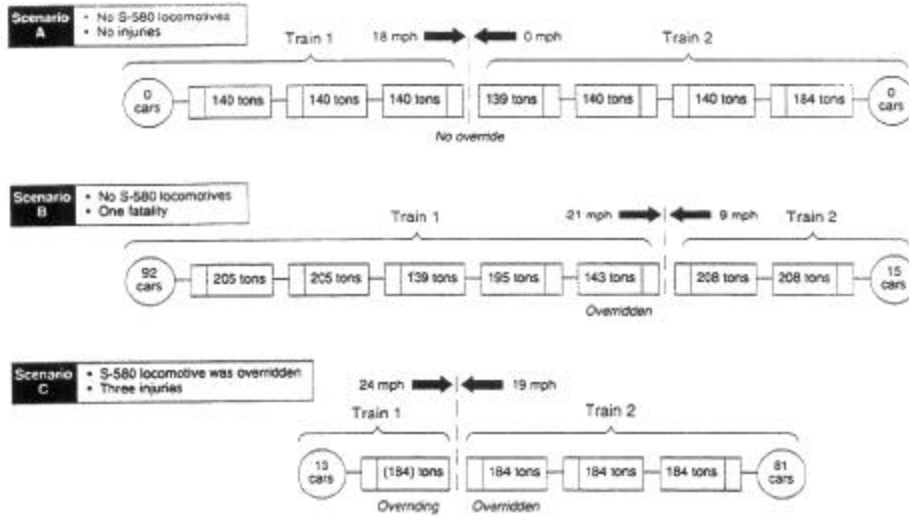

Locomotive Crashworthiness Research Crash Simulation Example Scenario A

Override is allowed to initiate, but it is arrested in this example.

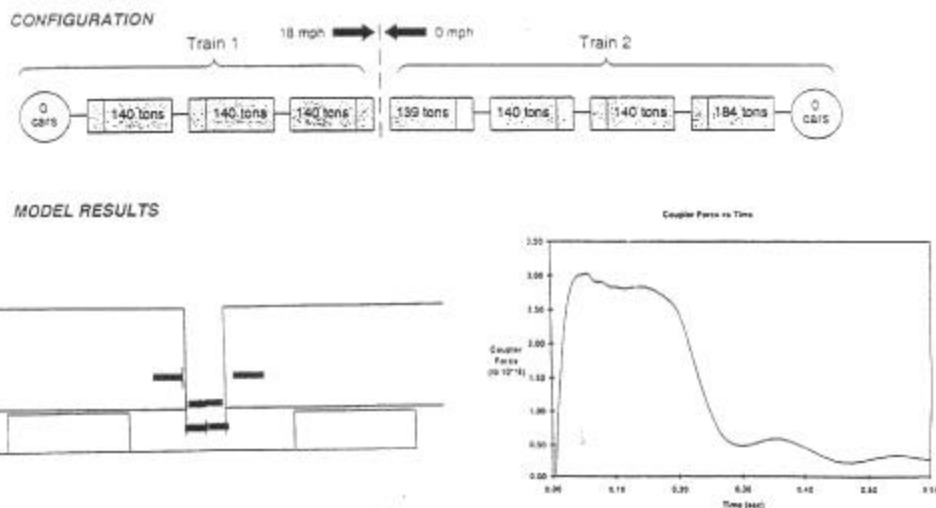

Locomotive Crashworthiness Research Crash Simulation Example Scenario B

The model provides a good simulation of a 30 mph closing speed, head-on collision.

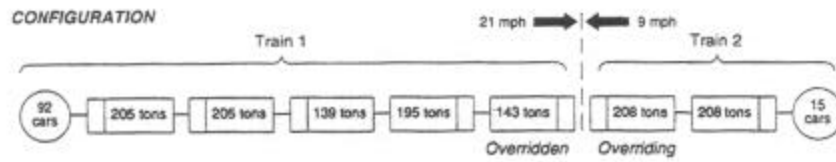

MODEL RESULTS

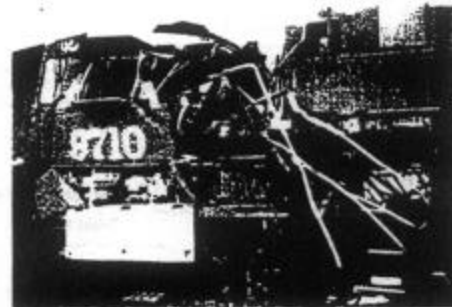
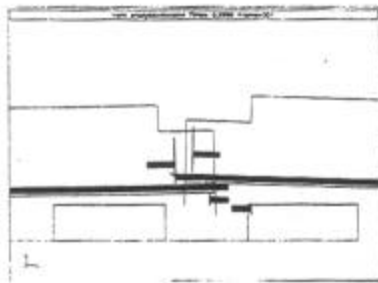

Locomotive Crashworthiness Research Possible Override Sequences

The particular sequence of override, if it occurs, has a large effect on the energy absorbed.

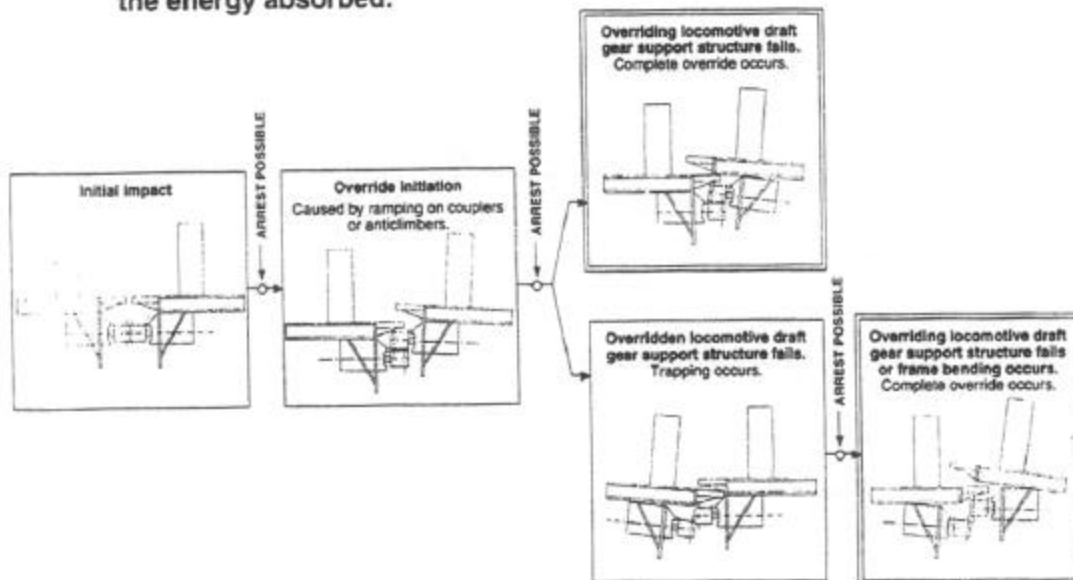

Locomotive Crashworthiness Research Scenario B Photos

Ramping between locomotives and failure of the overriding locomotive draft gear support structure occurred in this accident.

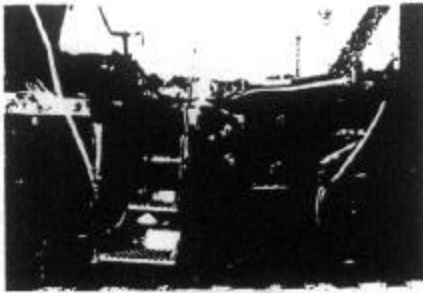

Side View of Overriding Locomotive's Fractured Draft Gear Support Structure

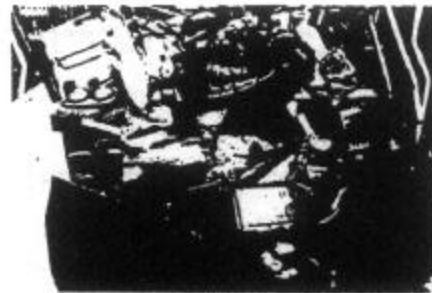

Front View of Overridden Locomotive's Short Hood End

Locomotive Crashworthiness Research Crash Pulse Example

The peak in the crash pulse is determined primarily by the peak crush force

$$\bullet \text{ Acceleration} = \frac{\text{Underframe crush force}}{\text{Mass}} = \frac{3 \times 10^6}{4 \times 10^5} = 8g$$

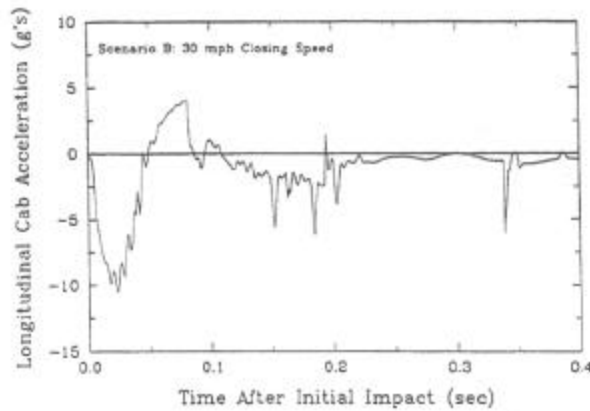

Locomotive Crashworthiness Research Crash Simulation Example ScenarioC
Override occurs, but it is arrested by the collision posts.

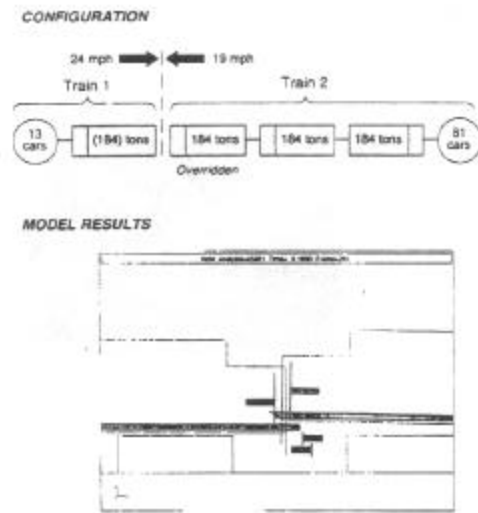

Locomotive Crashworthiness Research Underframe Bending

The collision dynamics model includes features that enable the simulation of underframe bending that is occasionally exhibited in collisions and that might occur for interlocking anticlimbers.

- Underframe interaction and bending occur at high closing speed collisions when pitch inertia provides the primary resistance to-override
- Practical limits on collision post strength are determined, in part, by underframe bending strength
- Underframe bending can eventually provide the ramp for override.

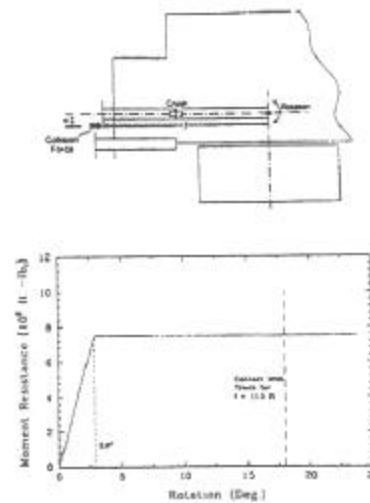

Locomotive Crashworthiness Research Anticlimber Concept

The primary goal in development of anticlimber concepts was to ensure that underframes interact.

- An interlocking anticlimber was envisioned
- The anticlimbers would interfere vertically before significant longitudinal load was transmitted



Locomotive Crashworthiness Research Crashworthiness Features Results

The addition of two crashworthiness features appears to improve the crashworthiness of freight locomotives for the collision scenarios studied.

- The Scenario B configuration was used
- Strong collision posts have a strength of 800 kips at 30 inches and substantial ductility
- Override occurs after some underframe rotation with the interlocking anticlimber

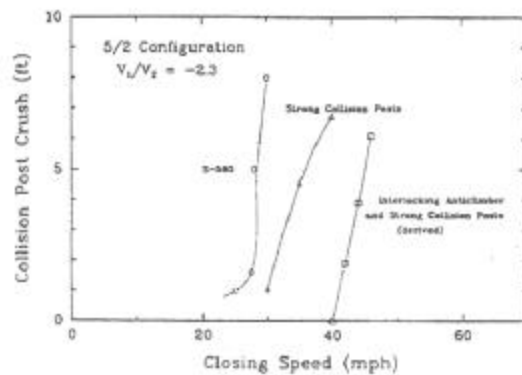

Locomotive Crashworthiness Research Conclusions

The study resulted in the development of a computer model and the evaluation of some alternative crashworthiness features for freight locomotives.

- The model predicts that override and cab crush can occur in locomotives satisfying S-580 involved in head-on collisions with closing speeds of 30 mph or greater
- The current anticlimber specification does not appear to be effective in preventing override due to the physics of head-on collisions
- The addition of stronger collision posts with ductility and an interlocking anticlimber appear to improve freight locomotive crashworthiness significantly

Locomotive Crashworthiness: A Builder's Perspective

HARVEY C. BOYD: Before we start, initially this conference was intended to cover just passenger locomotives and passenger trains in whatever crashworthiness philosophy was developed for one would be developed for both. At some point in time, the FRA has decided to take the structural crashworthiness of the locomotives and add that in with the crashworthiness of freight locomotives. So they'll be handled together as a system as opposed to the passenger train being handled together as a system. So you're going to find a lot of my presentation is going to include freight locomotives. I'm being assisted here by Tom Scott, my co-author of the paper.

Locomotive Crashworthiness-Definition

In order to begin a discussion on the subject of locomotive crashworthiness, we ought to spend a few moments trying to surround the issues. Certainly there is the initial damage from a crash. Survivable spaces, keeping foreign materials out of the cab, and control of the locomotive path are all very important. Then, the secondary impact issues must deal with whether crew members can survive being thrown around in the cab during a crash. Finally, there are the aspects of the crash that might be considered as subsequent damage and crew survivability issues. These might include the ability of survivors to get out of the locomotive, or the ability of rescuers to get into the locomotive.

Even with all these aspects of the crash to consider, the topic boils down to what happens to the energy of the moving trains and can the crew survive the dissipation of that energy. The amount of energy involved depends on speed, mass of the consist, and the type of object struck. It may be helpful to think of the items already mentioned in a matrix against some categorization of the type of accident.

A grade crossing accident in a modern locomotive probably poses the least threat to crew survivability and to the likelihood of significant damage to the locomotive. This is because the train energy is altered very little when a train hits a much lighter object. A modern locomotive design already considers the necessity of keeping foreign objects out of the cab. Therefore, normally the train plows through the object at the grade crossing, pushing it out of the way, and the train energy is dissipated in the brakes as the crew stops the train.

The opposite end of the spectrum occurs as we consider the case of two similar trains colliding head on. In this case, we must consider how we want to handle the vast amounts of energy that must be dissipated. Should we design the locomotives of the two trains to lock together or should we design the trains to pass each other in some fashion? This is an important question and has big implications on design strategies for protecting the crew and limiting the damage to the individual locomotives.

One approach to all of this would be to develop a set of generally agreed upon load cases for designing crew protection and schemes for designing in ways to handle the energy of the potential crash scenarios. Here are some thought starters:

Grade Crossing Accident - Develop a strategy of pushing aside vehicles struck at a grade crossing while keeping foreign material out of the cab. This is fairly well addressed by the AAR Standard S-580. We develop the full shear strength of the underframe at the collision posts to deflect the struck objects. Also, the front of the cab is sealed to keep out gravel, or fuel from a tank truck that may have been struck.

Massive Obstructive - This is probably something like a rock slide. A strategy could be to accept some damage to the underneath side of the locomotive in order to reduce the risk of the train buckling and piling a portion of the train on top of the crew in the lead unit. Therefore, a design strategy could be to design an end plate that would fold under, break-away trucks, and a break-away fuel tank to allow the locomotive to go over the top of these objects with minimal risk to their survivability.

Dissimilar Train Collision - This is where a locomotive-pulled train might hit the end of another stopped train or even be hit by an oncoming passenger train. It is an accident type where the amounts of energy and the structures of the colliding units might be quite different. There were some older tests of this kind of accident at the Transportation Technology Center in Pueblo, Colorado, and numerous examples in real life. Typically, the locomotive plows through the lighter cars and the energy is dissipated over several car lengths. This is good for the crew of the locomotive but often leads to a lot of damage to the lighter cars. In this sense, it is very similar to a grade crossing accident where the strategy should be to keep the lighter cars from intruding into the cab, as well as seal out the contents of the lighter cars, for instance, coal.

Single Train Crashes - This may be considered as a severe derailment, where the locomotives might be pushed quite a ways from the track by the following train. Design considerations here might include issues of locomotive roll strength and the likelihood of the crew being thrown into sharp, hard objects in the cab. Modern clean cab practices help significantly in these types of situations.

Similar Train Crashes - Luckily, this is a rare occurrence because the problems of dealing with the energy can be enormous. One strategy that has been proposed goes under the heading of "crash energy management." From the locomotive point of view, the crew probably stands a better chance of survival if the energy is dissipated by passing one unit by the other. The collision post structure should be designed to ramp one unit over the other in the case of over-ride being the course of energy distribution that "nature" chooses. It would be better to encourage through design that the two locomotives pass by each other. While this likely poses some threat to bystanders adjacent to the track, the proverbial school yard, those people are already at risk from the rest of the two trains as they buckle and the cars go every which way.

Locomotive Crashworthiness-Technology Updates

Recent studies (Locomotive Crashworthiness Research - Volume 1: Model Development and Validation DOT/FRA/ORD-95/08.1 A. D. Little) indicate that the severity of a head-on collision between two trains is directly related to the mass of locomotives in the lead consist with as little as 10 percent of the cab damage severity being attributed to the rest of the train. Technological advances recently introduced, or are about to be introduced take advantage of relationships of this type to increase crew survivability at greater closing collision speeds without additional structural changes to the cab or locomotive.

Higher Horsepower - Recent increases in locomotive horsepower from 4000 hp to 4400 hp in 1994 to 5000 hp in 1995, and 6000 horsepower to be introduced in 1997 will result in many more single-unit pulled trains being dispatched in place of two- and three-unit pulled trains as is present practice. Also, two-locomotive unit consist trains will replace three-, four-, and five-unit lead consists. This represents an immediate improvement to crew safety in head-on locomotive-to-locomotive collisions because of the reduced mass in the critical spot in the accident.

Power Distribution. - Power distribution is being introduced on high horsepower locomotives for improved train handling. Locomotives are dispersed throughout the train and are controlled via radio. The present day practice is for all locomotives in the consist to be clumped together for direct wire connection. With power distribution, trains will be dispatched with one or two locomotives in the lead in place of four or five in the lead. Considerable mass will thus be removed from the head-on collision equation.

AC Traction - The great leaps in tractive effort with the introduction of AC Traction in 1994 has already had a significant effect on reducing the size of locomotive consists on many trains.

Positive Train Separation - Using Global Positioning Satellites, test trains may soon be dispatched with electronic hardware and computer software to accurately locate, track, and prevent trains from intruding into another's territory. When fully implemented, this system should greatly reduce the number of train-to-train collisions. Anything that contributes to preventing accidents is inherently much more valuable than trying to limit damage.

End-Of-Train Device - Advances which remove the number of crew members from a collision will by its own virtue save lives. The end-of-train device has gone a long way to eliminating the caboose and two or more crew members from a very vulnerable position in train-to-train collisions.

Locomotive Crashworthiness-Design Constraints

Locomotive design cannot proceed unfettered by the real world. The locomotive designer must consider a number of constraints that limit his freedom to design according to a safety strategy, once we have such a strategy. Actually, the current lack of a consistent strategy is a hindrance in itself. What happens in an accident where one vehicle is meant to plow on through, or pass by, and the struck vehicle is meant to trap the impact and crush? The extent of the damage generated is likely to be much higher than if the vehicles were designed with a consistent philosophy. New designs will be on the rails with designs of up to 30 years old.

Size - Single cab high horsepower locomotives have reached a length of 80 feet over coupler pulling faces. Further increases in length will strain the ability of repair and maintenance shops to accommodate the locomotives. Increased length will adversely affect curb negotiation and jack-knifing. MU air brake hoses, couplers, MU jumper cables, fuel transfer hoses, and end-plate mounted equipment are affected by increases in locomotive length. Locomotives are presently built to the maximum width and height allowed by AAR Plate C. A new crash energy management philosophy must not add much to locomotive length.

Weight - Increases in horsepower result in corresponding increases in length and fuel capacity, both of which tend to increase locomotive weight. SD40-2 locomotives at 3000 hp and 4400

gallons of fuel built in the 1970's often had a maximum weight of 420,000 pounds (70,000 pounds per axle). To obtain the same range in 1997, 6000 hp SD90MACs will be built with 5800-gallon fuel tanks but must maintain about the same maximum weight. Locomotive builders are hard pressed to hold weights of higher horsepower units to 70,000 pounds per axle and maintain the same flexibility of service as older units.

Deflection - Increases in length are also accompanied by increases in vertical deflection on locomotives with a traditional strong underframe (2- 1/2 to 3 inches vertical deflection at one million pounds buff on SD80MAC). Excessive vertical deflection adversely affects side door attachment, equipment mounting, and equipment alignment. New designs must accommodate their possible deflections and certainly not add to the flexibility.

Vibration - Locomotive structures must be designed to avoid natural frequencies (i.e., first, second, and third bending modes) that would coincide with input frequencies of various equipment or the road bed. Other items on the locomotive (i.e., natural frequencies of an isolated cab) must be designed to miss the natural frequencies of the supporting structure. A new crash resistant cab support cannot bridge across cab isolation mounts. At risk is the crew's everyday operating environment that could be significantly worsened.

Manufacturability - As in all other aspects of locomotive design, manufacturability must be considered. Not only must someone be able to physically manufacture the parts, but they must be designed such that quality is repeated in every part. Furthermore, the ergonomics and safety of the builder's labor force must be considered in all designs.

Fatigue Design - Structural fatigue is a critical aspect of locomotive design and requires considerable expertise and attention to detail. Due to the requirement for large traction motors mounted in the truck, the bottom of the structural underframe is required to be well above the centerline of the coupler where the load to the train is transmitted. This results in large bending moments being applied to the structural underframe (or carbody) which reverses direction when shifting from buff to drag. Abrupt changes in section modulus (as may be required in crash energy management systems where controlled crush sections are connected to non-crush sections) not only increase static stresses but have deleterious effects on fatigue strength.

Visibility - To be effective, a collision structure must be out in front of the crew. A general rule-of-thumb seems to be "Greater collision protection requires a greater distance between the front of the locomotive and the crew." With full width short hoods to add protection directly in front of the crew, this generally means reduced visibility to the ground. Crews today are demanding increased ground visibility, not less. They feel visibility is an essential to safe switching practices, even with road locomotives.

Design Cycle Time - Computer models of structures for stress and modal analysis, acoustic analysis, and vibration analysis are beginning to outstrip the capacities of all but very large computers. The more the analyst is asked to evaluate, the more larger computers will be required. Also, the cycle time to build a computer model increases with each added complexity. Today's highly complex locomotive designs are dependent on high speed computers and huge software programs to reduce over-design and design cycle time. It is easy to see where each of the above constraints may be affected by a structure composed of multiple strength sections and the increased complexity of the analysis.

Locomotive Crashworthiness-Current Features

The locomotives being delivered today stand up very well to unfortunate incidences largely because of continuous improvements instituted since the 1970's. Crews of pre-clean cabs, pre-49 CFR Part 223 Glazing, pre-AAR S-580, pre-wide short hood locomotives were subjected to many types of dangerous situations in their cabs.

Cab interiors were littered with numerous sharp-cornered black boxes, glass bottle water coolers, and bare steel handled controls that became dangerous impact points. The impact of Clean Cab philosophy has nearly relegated these problems to the past. The Clean Cab concept also led to a "sealed cab front" concept to greatly reduce flammable and other harmful liquids from entering the cab after colliding with transport trucks at grade crossings.

The 1980 introduction of 49 CFR Part 223 Impact Resistant Glazing has minimized cinder blocks and other objects thrown at trains from severely injuring the crew.

Heavy duty full width short hoods first introduced in Canada in the 1970's and in the U.S. in 1989 have added penetration resistance directly in front of the crew to reduce intrusion by gravel and liquids at crossing accidents, and by shifted loads on passing trains.

AAR S-580 Locomotive Collision Standard introduced in 1990 with stronger collision posts, anti-climber, and penetration resistant short hood face has added considerable protection against crossing accidents of all types, preventing vehicles and freight cars from being thrown over the underframe and crushing the cab.

The above improvements have successfully reduced locomotive crew deaths to a point where locomotive-to-locomotive collisions stand far above other causes of crew collision deaths. Even though the number of these deaths have been reduced, the spectacular nature of the relatively infrequent but dramatic high speed collisions between locomotives serves to dramatize them. Little thought is given to the fact that today, locomotives seldom lose a battle with anything but another locomotive. Few vehicles are built with such mass and strength.

Locomotive Crashworthiness-A Systematic Approach

A systematic approach to locomotive crashworthiness design will have many features. Many are natural extensions of things that are already being done to keep locomotives safe. The design improvement process is keyed upon feedback about what is working and what is not working. This conference and the meetings that have led up to it have involved the manufacturers. However, in the past 10 to 20 years, the manufacturers have been pretty much excluded from accident investigations and distribution of accident analysis results. The feedback and systematic analysis of accidents is important to the manufacturers' ability to improve their designs.

Certainly the industry as a whole should focus on crash avoidance. The science exists to detect impending accidents in a variety of situations. However, the technology must be made practical, including cost effective. The very impressive safety records of the Japanese and French high speed trains is because they almost never have serious accidents. That is the real key to driving annual deaths and injuries towards zero. It is also the area in which technology can make the most significant contributions.

Crash Energy Management-Effect On Today's Locomotive Designs

FRA Crash Energy Management Model - One proposal is that the front end of the locomotive should be comprised of a collision structure assembly incorporating central collision posts, corner collision posts, anti-climbing device, and penetration resistant sheeting. This collision structure would be followed by a controlled collapse energy absorbent section (perhaps a six-foot-long section resisting 1,000,000 pounds force through collapse), followed by a sufficiently strong section housing the crew that will not collapse under 1.25 million pounds, followed by another 20 feet of 1,000,000 pound collapsible section or sections.

To survive, the crew must know the collision is about to happen and then react by quickly moving to a *crash pit* or *crash wall* where the impact will impart up to 20g's on their bodies. The crew survives the crash because there is no secondary impact and there is a guaranteed survivable space after the accident. There is no secondary impact because the person is already up against the surface and is not thrown against it. That surface may or may not need to be padded or otherwise conformal.

Design Problems With The Crash Energy Management - With the corner posts part of an end collision structure, the windshield will be placed about eight feet in front of the crew. Very large windows and poor crew visibility will result from this arrangement.

Isolated cabs introduced in the early 1990's have reduced cab interior noise db(A) levels from the mid-80's to the mid-70's and significantly lowered compartment vibration. This important crew safety and comfort feature is in danger of being lost in a Crash Energy Management System.

Electrical cabinets, alternators, engines, and other equipment will have to be much more rigidly attached to the main structure to prevent this type of equipment from ripping loose and crushing the crew from behind. With the g levels being considered, this may be nearly impossible.

Consider that the fuel tank must be designed to **not rupture** during controlled collapse of the superstructure. Therefore, it must not be part of the superstructure but must detach during collapse of the superstructure.

Locomotive Crashworthiness-Conclusions

Let us sum up a little of this rambling discussion. First of all, the industry needs a consistent design philosophy. The rudiments of one has been suggested based on the natural strength and mass of locomotives. Let the locomotive plow through, or over, or around, the struck object. The crew is safer because the train does not decelerate very quickly.

The second main point is that the locomotives have becoming increasingly safer for crews. The risk has been reduced by continuous improvement since the 1970's, such as the AAR Clean Cab. The risk is further reduced due to crew reductions and unit reductions at the front of trains. Great improvements in locomotive productivity have made much of this possible.

There are a number of design constraints that limit design flexibility to incorporate novel structures into locomotives. Many items, such as size, weight, and stiffness need to be optimized in every design.

Two important things that can be done for safety is to provide the manufacturers with up-to-date crash analysis information and to focus on crash avoidance.

Finally, crash energy management, as is currently envisioned, seems to be a difficult approach, compared to other philosophies, for improving locomotive crew protection. After all, 20g's is a very difficult design target and a very bumpy ride.

That comes close to concluding my presentation. There's one other little item which I think I would like to put up. I wasn't going to do it, but back at EMD it's kind of a standing joke whenever I'm involved in a meeting that I can't get by without putting up a chart of making one of my infamous sketches. I've tried to get through it but I'm not going quite do that.

While doing this paper I've tried to put together in my own mind where are we with crashworthiness. What are the effects of some of the things that have been and that we're doing? What are we trying to address with whichever philosophy we choose, we end up deciding on? So I needed a better look at the overall picture. So I put together a totally fictitious graph, one which I thought in my mind would help me put together what picture I'm seeing. So I put together these 3-D fatalities. On this axis, we have a closing speed of the collision in miles per hour. I put them in tens, 0-10, 10-20, 20-30, etc. Then across this scale we have death cases, 1960-1970, '71-80, '81-90. I said what happened during those years and have we improved and where are we going? What are we going to address?

I don't have the data so I said well initially perhaps across each of these closing speeds back in the area of the 60's. We are pretty much equal at each of the closing speeds. We have many more collisions in the 0-10, 10-20 but they weren't as severe. So on average, you may have killed as many people at that speed as you did in '61-70 where you had many fewer collisions but the collisions were much more severe in themselves.

Then we look at the next decade, we've made some improvements. Some of those improvements came about because the AAR Clean Cab philosophy and some of the other improvements that were made when we looked at safety. All of those improvements because the improvements of this locomotive fleet occurred in the '70s, you're still going to be seeing the effects of that bringing this down in the '80s and '90s as more and more of the fleet catches up. Then we'll see a much larger drop when we get into the decade of the '80s, 1980-1990. I attribute a lot of that drop to the end-of-train device and getting the crews out of the caboose and reducing the crew, cutting the crews in half. I think that may have made a 30% immediate change in total number of collision deaths. That's pretty much across the spectrum.

Then we begin to notice more down at the lower end, lesser at the higher end of improvements and reductions, and part of this is because of the introduction of the AAR S-580. That's in the decade of 1990-2000. It was introduced in '90. You're not going to see the full effects of it because again you don't have that large of a population. You're going to see much more of the effects of AAR S-580 in the year 2001-2010, but there are also other things that are going to be affecting this, bringing this down. That is a reduction of lead units in the consist, or units in the lead consist. Increases in horsepower, power distribution, AC traction is all going to affect this.

So if I come up with this curve and I say, "What are we going to be addressing with our crash energy management or whatever philosophy?" We have seen some things that have said we can

address crash energy up to 70 miles per hour or 80 miles per hour. I've seen other presentations today saying we need to look and find out what is practical, taking cost and other things into effect. So maybe we're addressing this area over the next with whatever philosophy we end up choosing. How large is that area? How many are included in there? Until we have a good set of data here and look at it in this manner, I'm not sure we know what the extent of the problem is that we're addressing or how well we're going to address it.

That's the extent of my graph, but I think this data is important. How do we get this data? There's a bill that's being proposed I saw the idea where someone in Congress wants to add 400 inspectors to the FRA's inspection force. From my point of view, that's the wrong way to go. We've learned lessons from the Japanese that you don't inspect quality. You work with a design and a philosophy and a quality process. When you find something wrong with the process, you fix the process. You should be monitoring the process. You can't monitor your process without statistics. I would rather see the FRA Office of Safety gather 20 statisticians and have the 400 inspectors they have in the field feeding data into them so they can produce charts such as this so they can find out where the real problems are and what the trends are.

Any questions? Thank you.

CLIFF WOODBURY: Cliff Woodbury, LTK, Engineering Services. I entirely agree with the last part of your presentation there. I think the data that you're suggesting be developed, that that effort be undertaken. However, it seems to me that it has to at some point include also an analysis of the data to determine, if the end result of this is to be what do we do to the structure to make things better, the data has to somehow be analyzed to reveal for the incidents what it was about the structure itself that was somehow deficient or would need improvement such that those incidents would have been different or better, produced less injuries and less fatalities.

HARVEY BOYD: I agree with you there. In fact, we tend to focus on the failures themselves and the NTSBA does a fairly good job of looking at those failures. But I don't think they look at the successes quite as well. By looking at the successes you can say this works. We have to improve on this particular direction. Maybe I should go into one of my infamous sketches here just briefly. A few years ago, I took an ergonomics course at the University of Michigan and one of the things they pointed out was be careful on how you look at data.

One of the things they talked about there was during World War II with the squadron planes and the commander kept losing a number of planes, and decided I've got to do something about that. I really should make my planes a little bit stronger. So he took some of his clerks and had them go out and categorize what damage was done to the planes. I want you to go out and look at them and see if you can find a pattern so that we can find out where we can strengthen these planes. So if we take a look of the plane here (great sketch). They went out and took these sketches and started plotting and sure enough they came back and yes, we have a pattern. We have holes here and some there. All right, if this is a pattern of what we have, so let's go ahead and shore up these areas.

They went and made some immediate changes to them and made those areas stronger and then started monitoring this fleet. As they went on their next several missions, lo and behold, there was no change in the survivability rate. The reason is they were looking at the survivors. These were actually the strong areas of the plane. That's why they came back. The ones that didn't

have any holes here, that obviously was the weak area and those went down. So they analyzed the wrong thing. We need to be analyzing just as carefully accidents such as Silver Springs and what happened there and why did we have survivors. Did the structure do something very interesting that we have to be pursuing just as much as we analyze when two structures come together and don't pass by. We need to analyze the entire situation. Any other questions?

DENNIS RAMM: Let's take an early break here and get back about five to please. Thank you.

PRESENTATION

***LOCOMOTIVE CRASHWORTHINESS:
A BUILDER'S PERSPECTIVE***

LOCOMOTIVE CRASHWORTHINESS: A BUILDERS PERSPECTIVE

by
Harvey C. Boyd
Senior Experimental Engineer
Cab Development Group
and
R. Thomas Scott
Manager, Carbody and Bogie Development

Electro-Motive Division
General Motors Corporation
LaGrange, IL

LOCOMOTIVE CRASHWORTHINESS-DEFINITION

In order to begin a discussion on the subject of locomotive crashworthiness, we ought to spend a few moments trying to surround the issues. Certainly there is the initial damage from a crash. Survivable spaces, keeping foreign materials out of the cab, and control of the locomotive path are all very important. Then, the secondary impact issues must deal with whether crew members can survive being thrown around in the cab during a crash. Finally, there are the aspects of the crash that might be considered as subsequent damage and crew survivability issues. These might include the ability of the survivors to get out of the locomotive, or the ability of rescuers to get into the locomotive

Even with all these aspects of the crash to consider, the topic boils down to what happens to the energy of the moving trains and can the crew survive the dissipation of that energy. The amount of energy involved depends on speed, mass of the consist, and the type of object struck.

It may be helpful to think of the items already mentioned in a matrix against some categorization of the type of accident.

A grade crossing accident in a modern locomotive probably poses the least threat to crew survivability and to the likelihood of significant locomotive damage. This is because the train energy is altered very little when a train hits a much lighter object. A modern locomotive design already considers the necessity of keeping foreign objects out of the cab. Therefore, normally the train plows through the object at the grade crossing, pushing it out of the way, and the train energy is dissipated in the brakes as the crew stops the train.

The opposite end of the spectrum occurs as we consider the case of two similar trains colliding head on. In this case, we must consider how we want to handle the vast amounts of energy that must be dissipated. Should we design the locomotives of the two trains to lock together or should we design the two trains to pass each other in some fashion? This is an important question and has big implications on design strategies for protecting the crew and limiting the damage to the individual locomotives.

One approach to all this would be to develop a set of generally agreed upon load cases for designing crew protection and schemes for designing in ways to handle the energy of the potential crash scenarios. Here are some thought starters:

Grade Crossing Accident - Develop a strategy of pushing aside vehicles struck at a grade crossing while keeping foreign material out of the cab. This is fairly well addressed by the AAR Standard S-580. We develop the full shear strength of the underframe at the collision posts to deflect the struck objects. Also, the front of the cab is sealed to keep out gravel, or fuel from a tank truck, that may have been struck.

Massive Obstruction - This is probably something like a rock slide. A strategy could be to accept some damage to the underneath side of the locomotive in order to reduce the risk of the train buckling and piling a portion of the train on top of the crew in the lead unit. Therefore, a design strategy could be to design an end plate that would fold under, break-away trucks and break-away fuel tank to allow the locomotive to go over the top of these objects with minimal risk to their survivability.

Dissimilar Train Collision - This is where a locomotive pulled train might hit the end of another stopped train or even be hit by an oncoming passenger train. It is an accident type where the amounts of energy and the structures of the colliding units might be quite different. There were some older tests of this kind of accident at the Transportation Technology Center in Pueblo, Colorado, and numerous examples in real life. Typically, the locomotive plows through the lighter cars and the energy is dissipated over several car lengths. This is good for the crew of the locomotive but often leads to a lot of damage to the lighter cars. In this sense, it is very similar to a grade crossing accident where the strategy should be to keep the lighter cars from intruding into the cab, as well as, seal out the contents of the lighter cars, for instance, coal.

Single Train Crashes - This may be considered as a severe derailment, where the locomotives might be pushed quite a ways from the track by the following train. Design considerations here might include issues of locomotive roll strength and the likelihood of the crew being thrown into sharp, hard objects in the cab. Modern clean cab practices help significantly in these type situations.

Similar Train Crashes - Luckily, this is a relatively rare occurrence because the problems of dealing with the energy can be enormous. One strategy that has been proposed goes under the heading of "crash energy management." From the locomotive

point of view, the crew probably stands a better chance of survival if the energy is dissipated by passing one unit by the other. The collision post structure should be designed to ramp one unit over the other in the case of over-ride being the course of energy distribution that "nature" chooses. It would be better to encourage through design that the two locomotives pass by each other. While this likely poses some threat to bystanders adjacent to the track, the proverbial school yard, those people are already at risk from the rest of the two trains as they buckle and the cars go every which way.

LOCOMOTIVE CRASHWORTHINESS-TECHNOLOGY UPDATES

Recent studies (Locomotive Crashworthiness Research - Volume 1: Model Development and Validation DOT/FRA/ORD-95/08.1 *A D Little*) indicate the severity of a head-on collision between two trains is directly related to the mass of locomotives in the lead consist with as-little-as 10 % of the cab damage severity being attributed to the rest of the mass of the train. Technological advances recently introduced or about to be introduced take advantage of relationships of this type to increase crew survivability at greater closing collision speeds without additional structural changes to the cab or locomotive.

Higher Horsepower- Recent increases in locomotive horsepower from 4000 hp to 4400 hp in 1994 to 5000 hp in 1995 and 6000 hp to be introduced in 1997 will result in many more single unit pulled trains being dispatched in place of two and three unit pulled trains as is present practice. Also, two locomotive unit consist trains will replace three, four, and five unit lead consists. This represents an immediate improvement to crew safety in head-on locomotive-to-locomotive collisions because of the reduced mass in the critical spot in the accident.

Power Distribution -Power distribution is being introduced on high horsepower locomotives for improved train handling. Locomotives are dispersed throughout the train and are controlled via radio. The present day practice is for all the locomotives in the consist to be clumped together for direct wire connection. With power distribution, trains will be dispatched with one or two locomotives in the lead in place of four or five in the lead. Considerable mass will thus be removed from the head-on collision equation.

AC Traction -Great leaps in tractive effort with the introduction of AC Traction in 1994 has already had a significant effect on reducing the size of locomotive consists on many trains.

Positive Train Separation -Using Global Positioning Satellites, test trains may soon be dispatched with electronic hardware and computer software to accurately locate, track and prevent trains from intruding into another's territory. When fully implemented, this system should greatly reduce the number of train-to-train collisions. Anything that contributes to preventing accidents is inherently much more valuable than trying to limit damage.

End Of Train Device -Advances which remove the number of crew members from a collision will by its own virtue save lives. The End-of-train device has gone a long way to eliminating the caboose and two or more crew members from a very vulnerable position in train-to-train collisions.

LOCOMOTIVE CRASHWORTHINESS --- DESIGN CONSTRAINTS

Locomotive design can not proceed unfettered by the real world. The locomotive designer must consider a number of constraints that limit his freedom to design according to a safety strategy, once we have such a strategy. Actually, the current lack of a consistent strategy is a hindrance in itself. What happens in an accident where one vehicle is meant to plow on through, or pass by, and the struck vehicle is meant to trap the impact and crush? The extent of the damage generated is likely to be much higher than if the vehicles were designed with a consistent philosophy. New designs will be on the rails with designs up to 30 years old.

Size -Single cab high horsepower locomotives have reached a length of 80 feet over coupler pulling faces. Further increases in length will strain the ability of repair and maintenance shops to accommodate the locomotives. Increased length will adversely affect curve negotiation and jack-knifing. MU air brake hoses, couplers, MU jumper cables, fuel transfer hoses, and end plate mounted equipment are affected by increases in locomotive length. Locomotives are presently built to the maximum width and height allowed by AAR Plate C. A new crash energy management philosophy must not add much to locomotive length.

Weight -Increases in horsepower have resulted in corresponding increases in length and fuel capacity, both of which tend to increase locomotive weight. SD40-2 locomotives at 3000 hp and 4400 gallons of fuel built in the 1970's often had a maximum weight of 420,000 pounds (70,000 pounds per axle). To obtain the same range, in 1997 6000 hp SD90MAC'S will be built with 5800 gallon fuel tanks but must maintain about the same maximum weight. Locomotive builders are hard pressed to hold weights of high horsepower units to 70,000 pounds per axle and maintain the same flexibility of service as older units.

Deflection -Increases in length are also accompanied by increases in vertical deflection on locomotives with a traditional strong underframe (2 1/2 to 3 inches vertical deflection at 1,000,000 pounds buff on SD80MAC). Excessive vertical deflection adversely affects side door attachment, equipment mounting, and equipment alignment. New designs must accommodate their possible deflections and certainly not add to the flexibility.

Vibration -Locomotive structures must be designed to avoid natural frequencies (i.e. 1 st, 2nd, 3rd bending modes) that would coincide with input frequencies of various

equipment or the road bed. Other items on the locomotive (i.e. natural frequencies of an isolated cab) must be designed to miss the natural frequencies of the supporting structure. A new crash resistant cab support can not bridge across cab isolation mounts. At risk is the crew's every day operating environment that could be significantly worsened.

Manufacturability -As in all other aspects of locomotive design, manufacturability must be considered. Not only must someone be able to physically manufacture the parts, but they must be designed such that quality is repeatable in every part. Furthermore, the ergonomics and safety of the builders labor force must be considered in all designs.

Fatigue Design -Structural fatigue is a critical aspect in locomotive design and requires considerable expertise and attention to detail. Due to the requirement for large traction motors mounted in the truck, the bottom of the structural underframe is required to be well above the centerline of the coupler where the load to the train is transmitted. This results in large bending moments being applied to the structural underframe (or carbody) which reverses direction when shifting from buff to drag. Abrupt changes in section modulus (as may be required in crash energy management systems where controlled crush sections are connected to non-crush sections) not only increase static stresses but have deleterious effects on fatigue strength.

Visibility -To be effective, a collision structure must be out in front of the crew. A general rule of thumb seems to be "Greater collision protection requires a greater distance between the front of the locomotive and the crew." With full width short hoods to add protection directly in front of the crew, this generally means reduced visibility to the ground. Crews today are demanding increased ground visibility, not less. They feel visibility is an essential to safe switching practices, even with road locomotives.

Design Cycle Time -Computer models of structures for stress and modal analysis, acoustic analysis, and vibration analysis are beginning to outstrip the capacities of all but very large computers. The more the analyst is asked to evaluate the more larger computers will be required. Also, the cycle time to build a computer model increases with each added complexity. Today's highly complex locomotive designs are dependent on high speed computers and huge software programs to reduce over design and design cycle time. It is easy to see where each of the above constraints may be affected by a structure composed of multiple strength sections and the increased complexity of the analysis.

LOCOMOTIVE CRASHWORTHINESS --CURRENT FEATURES

Locomotives being delivered today, stand up very well to unfortunate incidences largely because of continuous improvements instituted since the 1970's. Crews of pre-clean cab, pre-49CFR Part 223 Glazing, pre AAR S-580, pre-wide short hood locomotives, were subjected to many types of dangerous situations in their cabs.

Cab interiors were littered with numerous sharp cornered black boxes, glass bottle water coolers, and bare steel handled controls that became dangerous impact points. The impact of Clean Cab philosophy has nearly relegated these problems to the past. The Clean Cab concept also led to a "Sealed cab front" concept to greatly reduce flammable and other harmful liquids from entering the cab after colliding with transport trucks at grade crossings.

The 1980 introduction of 49CFR Part 223 Impact Resistant Glazing has minimized cinder blocks and other objects thrown at trains from severely injuring the crew.

Heavy duty full width short hoods first introduced in Canada in the 1970's and in the US in 1989 have added penetration resistance directly in front of the crew to reduce intrusion by gravel and liquids after crossing accidents, and by shifted loads on passing trains.

AAR S-580 Locomotive Collision Standard introduced in 1990 with stronger collision posts, anti-climber, and penetration resistant short hood face has added considerable protection against crossing accidents of all types, preventing vehicles and freight cars from being thrown over the underframe and crushing the cab.

The above improvements have successfully reduced locomotive crew deaths to a point where locomotive-to-locomotive collisions stand far above other causes of crew collision deaths. Even though the number of these deaths have been reduced, the spectacular nature of the relatively infrequent but dramatic high speed collisions between locomotives serves to dramatize them. Little thought is given to the fact that today, locomotives seldom lose a battle with anything except another locomotive. Few vehicles are built with such mass and strength.

LOCOMOTIVE CRASHWORTHINESS-A SYSTEMATIC APPROACH

A systematic approach to locomotive crashworthiness design will have many features. Many are natural extensions of the things that are already being done to keep locomotives safe. The design improvement process is keyed upon feedback about what is working and what is not working. This conference and the meetings that have led up to it have involved the manufacturers. However, in the past ten to twenty years, the manufacturers have been pretty much excluded from accident investigations and distribution of accident analysis results. The feedback and systematic analysis of accidents is important to the manufacturers' ability to improve their designs.

Certainly the industry as a whole should focus on crash avoidance. The science exists to detect impending accidents in a variety of situations. However, the technology must be made practical, including cost effective. The very impressive safety records of

the Japanese and French high speed trains is because they almost never have serious accidents. That is the real key to driving annual deaths and injuries toward zero. It is also the area in which technology can make the most significant contributions.

CRASH ENERGY MANAGEMENT - EFFECT ON TODAY'S LOCOMOTIVE DESIGNS

FRA Crash Energy Management Model

One proposal is that the front end of the locomotive should be comprised of a collision structure assembly incorporating central collision posts, corner collision posts, anti-climbing device, and penetration resistant sheeting. This collision structure would be followed by a controlled collapse energy absorption section (perhaps a 6 foot long section resisting 1,000,000 pounds force through collapse), followed by a sufficiently strong section housing the crew that will not collapse under 1,250,000 pounds, followed by another 20 feet of 1,000,000 pound collapsible section or sections.

To survive, the crew must know the collision is about to happen and then react by quickly moving to a *crash pit* or *crash wall* where the impact will impart up to 20 g's on their bodies. The crew survives the crash because there is no secondary impact and there is a guaranteed survivable space after the accident. There is no secondary impact because the person is already up against a surface and is not thrown against it. That surface may or may not need to be padded or otherwise conformal.

Design Problems With Crash Energy Management

With the corner posts part of an end collision structure, the windshields will be placed about 8 feet in front of the crew. Very large windows and poor crew visibility will result from this arrangement.

Isolated cabs introduced in the early 1990's have reduced cab interior noise db(A) levels from the mid 80's to the mid 70's and significantly lowered compartment vibration. This important crew safety and comfort feature is in danger of being lost in a Crash Energy Management System.

Electrical cabinets, alternators, engines, and other equipment will have to be much more rigidly attached to the main structure to prevent this equipment from ripping loose and crushing the crew from behind. With the g levels being considered, this may be nearly impossible.

Consider that the fuel tank must be designed to **not rupture** during controlled collapse of the superstructure. Therefore, it must not be part of the superstructure but must detach during collapse of the superstructure.

LOCOMOTIVE CRASHWORTHINESS - CONCLUSIONS

Let us sum up a little of this rambling discussion. First of all, the industry needs a consistent design philosophy. The rudiments of one has been suggested based on the natural strength and mass of locomotives. Let the locomotive plow through, or over, or around, the struck object. The crew is safe because the train does not decelerate very quickly.

The second main point is that the locomotives have become increasingly safer for the crews. The risk has been reduced by continuous improvements since the 1970's, such as the AAR Clean Cab. The risk is further reduced due to crew reductions and unit reductions at the front of trains. Great improvements in locomotive productivity has made much of this possible.

There are a number of design constraints that limit the design flexibility to incorporate novel structures into locomotives. Many items, such as size, weight and stiffness, need to be optimized in every design.

Two important things that can be done for safety is to provide the manufacturers with up-to-date crash analysis information and to focus on crash avoidance.

Finally, crash energy management, as it is currently envisioned, seems to be a difficult approach, compared to other philosophies, for improving locomotive crew protection. After all, 20 g's is a very difficult design target and a very bumpy ride.

GE Genesis Series Locomotives

TOM TSAI: As part of this morning's session, we have Mr. Al Bieber from General Electric starting the continuation of the locomotive crashworthiness. Al please?

AL BIEBER: Thank you Tom. Good morning ladies and gentlemen. It's a pleasure to be here today with you. As we have seen over the past couple of days, there has been a lot of good work, of course, on crash energy management, both analytically and experimentally and of course here in the U.S., in England and France and elsewhere. However, there are obvious differences of opinion on the approach to be used, as well as what criteria to design to. Today I'm here to talk to you very briefly about a fleet of locomotives that is in theory, it's practice, they're outrunning, they're pulling Amtrak trains and to let you know a little bit about some of the design philosophies that we used in this locomotive.

These locomotives run, of course, countrywide on Amtrak. And while meeting the applicable design standards in effect at the time, most of these have been mentioned before, but I'll highlight them. One major consideration, however, that we have to face is the reality of grade crossings and particularly, for some reason, Amtrak seems to suffer a greater percentage of them than maybe the freight railroads in general. It is a far too common occurrence in the United States, unfortunately. Now the Genesis Locomotive, which is what we named the series, was designed to be compatible with all of Amtrak's other equipment. Therefore it has top-operated, for instance, type F couplers. Head end power connections on the endplates, amule, electrical and air connections, snowplow, all of which pretty much dictate the end assemblies. So crash energy management, built on the front of a locomotive that has to exist with previously designed equipment is a little bit difficult.

The design was a combined effort with a close working relationship between GE, Amtrak and Krup over in Germany. Although GE was ultimately responsible for the product, a lot of good input was received from the Amtrak team and the analysts and designers that we contracted to at Krup. What I have to show you today though, however, is not an elaborate presentation but rather one that was done to satisfy your requisition.

First of all, I'd like to give a little bit of background on the order itself, the requisition. In 1990, Amtrak ordered a total of 74 locomotives from General Electric. Twenty of them were -840BH locomotives, which actually was a derivative of a freight locomotive, and we referred to those as early deliveries, the reason being that Amtrak was in need of power at the time, and to develop the monocoque structure in the Genesis Series locomotive was going to take longer than they wanted us to have at that moment. So therefore we produced 20 which are basically a derivative of a freight locomotive but with some modifications. The Genesis Series locomotive was the second quantity of a 44, and we called these single motor since they operated strictly in the diesel electric arena. And they were delivered in total in 1993. There is now 43 of them in service and one of them had a spectacular accident, as we all know, in Mobile, Alabama. The last set was the 10 dual-motor locomotives that were delivered to Amtrak just this past year in 1995. In addition, there are five dual motors that are now on Metro North of a very similar design except, you know, with some modifications to suit the Metro North operation.

All of these units were four axle designs with high speed gearing, up to 103 and 110 miles per hour. The -840BH, the early deliveries from the Genesis Series, were AC/DC type locomotives with integral head end power alternators coaxially mounted on the same shaft as the main traction alternator. The last series, however, the dual modes, they were AC traction locomotives with one inverter per axle and also a hep inverter with the capability that if there was a failure of the hep inverter, that a traction inverter could be converted and provide the head end power.

Now why did we select a monocoque design which is relatively uncommon today in the United States? Of course, there were many locomotives in the early 1940's built by General Motors known as covered wagons which were a monocoque-type of construction in that they didn't depend upon all this supporting weight to be carried by the platform alone. But anyway, we chose this because 1) Amtrak did specify a full width car body that was consistent with their appearance needs and their application. Also, lighter weight monocoque allowed for higher horsepower, 4,000 horsepower in this case, versus the 3,000 in previous locomotives, and also a greater fuel capacity: 2200 gallons versus 1800. Now those two things that we figured that by using the monocoque we were able to save about 20,000 lbs, so the decision to go monocoque was primarily driven, not necessarily crashworthiness or otherwise, but to save weight. And at that time, GE had a licensee in Germany, Krup, now called Siemens, and they were our licensee to build our export-style locomotives. And they did build quite a number of them in the 1970's and into the 1980's.

Krup had extensive FEA experience in designing lightweight locomotive shells because over in Europe, as was happening here in the United States, higher and higher power levels, particularly in electric locomotives, were straining the capability of the equipment and the size kept growing and growing, as was alluded to earlier, and so the structure had to come down and down in terms of weight, and so monocoque car shells with final analysis was the way to go. They had previously done the FEA work on the E120 crash locomotives for the Deutsche Bundesbahn, as well as the Intercity Express train, the ICE trains. We then had a contract with Krup to do our car body analysis, also the truck analysis by the way, under our direction.

The design approach that we took, of course, for crashworthiness was primarily the rules and regulations in effect at the time that these locomotives were being designed and two major areas were considered. Car body structural integrity of course is very key, and a spill-resistant fuel tank. And I want to emphasize that, in some of the trade press recently I've seen, especially after the Silver Spring accident, things have been referred to, or rather the fuel tank has been referred to as "crush-proof." I don't believe there is a crush-proof fuel tank, short of it being as strong as a battle tank and maybe being made out of 1.5 inch thick steel all the way around. So at some point, with some degree of severity in any accident, the fuel tank you will have a problem. But in this case, we designed it to be specifically spill-resistant. And I'll get into more detail about what I mean by that a little bit later.

The locomotive was to meet all the FRA, the appropriate AAR, and Amtrak's requirements and of course extensive final analysis was used. A complete half model of symmetry was generated, but I think something like 350,000 degrees of freedom. Now this is not nodes and elements, these are degrees of freedom. There were nine submodels of various major components, such as the draft gear housing, the collision post, the operator's cab, the main body of the locomotive and so forth. And there was confirmation over the design by an extensive strain gauge verification test over in Germany where we actually did apply 800,000 to the draft gear housings of the

locomotive, and we also tested the collision posts. Now, we didn't test them for their ultimate destruction because we didn't want to sacrifice a car body, but we did agree that if the FAA predicted satisfactory performance of the collision post and if we tested it up to at least a yield point, which is what we did, and the results of the test, and the modeling agreed, then we would agree that the collision post was satisfactory.

So that was a fairly elaborate set of tests. And what I heard yesterday was very interesting too because one of the key criteria was that there be no deformation on the car body or any buckling and there was one minor area at the back that Amtrak said we had to fix and we had to change that. It was around the hustle panel at the rear wall where there was a shearing action of the rear wall and a slight deflection and a little bit of buckling of the sheet metal. So we added some reinforcing to keep that from happening.

Now what did the model look like? This is probably not the best of pictures, but it gives you an idea of the extent of the model. As I mentioned, it was a half-model of symmetry, cut down the center. And of course the operator's cab was a very key part of the analysis and being able to withstand the loads that we had imposed upon it. And in the United States, 800,000 lb. compression is significantly higher than the 300,000 lbs that had been used for the other locomotives over in Germany. So it was a significant challenge, I think, to the analysts at Krup to come up with something that was very workable for us. You notice that there's very extensive amount of roof openings. A lot of the equipment packages amounted to what is called the cant rail which is the upper beam element. At this point, the dynamic braking package resides, the traction motor and alternator equipment area, engine hatches, engine air filter box and finally, the radiator package. All those are mounted on the cant rail and of course the main structure down below at the deck level supports the engine and the other platform-borne equipment.

So then to reiterate the specific criteria used, of course there's the compression of 800,000 lbs at the draft gear housing, collision post at the top, 200,000 lbs. At the deck, 500,000 lbs. An overall bus load of 2.5g's although Krup decided to go with 3g's because that was their standard over in Europe. Truck-to-carbody attachment to be able to withstand 250,000 lbs in all directions. And a couple of, carrying the vertical mode, 100,000 lbs.

Now one of the other interesting things that was done at the time, of course, was recognizing the grade crossing collisions that were very prevalent in the United States, as opposed to Europe. The European design is very rarely considered the strength of the car body from the deck down to the rails. If you look at a lot of European locomotives, you'll notice almost no end plate. And so in this case, we impose the requirement that the locomotive be able to hit a 4,000 lb. automobile at 60 miles per hour and not have any defamation to the front-end. We didn't want the vehicle to roll underneath the front and derail the locomotive which would have caused a major disaster. And so this was an additional requirement we put on. And this was 200,000 lbs per side. In other words, on either side of the draft gear housing, the impact of the vehicle could be up to 200,000 lbs without any deformation on the locomotive structure.

The end sheets themselves, and the collision posts, etcetera meet S-580. The windshields are FRA 223, Type 1 with spall shields which has proven to be a very effective means of protecting the crew. That is the spall shields.

Let me briefly just go over and show you some of the load cases that were included. This is the 800,000 lb. squeeze load and the Krup model obviously was a half plane of symmetry and of course they put the load on both ends of the draft gear housing stops and then analyzed the complete carbody that way. They then used the results of that to do some of the submodeling subsequent to this. This was the 800,000 lb. load for compression. This was looking at the collision posts. One of the decisions we had to make also when we tested the collision posts, the load we chose was to put the 200,000 lb. load on top of each collision post when we tested the complete carbody. But the question would be well, how do you apply this load. I mean, nowhere in the regulations do we say exactly how to do anything like this. And if you put it at a point, obviously if it's a zero or area, you've got an infinite force and it obviously can't withstand that. So we discussed this amongst ourselves and with the Amtrak engineers and we decided that about 10 square inches might be a reasonable way to apply this load. So we had 200,000 lb. hydraulic jacks, one for each of the collision posts, and we applied it over a 10-square inch plate that we welded to the collision posts.

Now these collision posts are not the same as we use on our freight locomotives, as you can see from this picture. This part of the locomotive is actually just sheet metal decoration. It really is not a major part of the collision protection. The main frontal sheet is this one, the one that meets the S-580. And in addition, that sheet is carried up forward, up about halfway past the windows. So it is not used at the lower level, actually transition is further up. And the collision post then is mounted outboard of that plate and actually comes down below the deck level a little bit. And this sloping surface, of course, forms the anticlimb feature of it. In addition, there is a diagonal bracing which goes down to the platform behind the collision post. All of this is a very effective structure for withstanding accidents.

The second piece of the collision post analysis obviously was at the deck. And once again, we looked at it, what is not shown here, there was also a horizontal member that ties the bottom of this collision post to the other end of this diagonal, and this was analyzed, of course, for the 500,000 lb. capability, to the ultimate limit of material.

Looking at the lower part of the end plate that I mentioned earlier, it actually can take a total across the front of the locomotive of 400,000 lbs, but the lower part of it or, excuse me, the part that they were modeling it was just one-half, 200,000 lbs and those were applied thus. We had 100,000 applied just to the outside of the draft gear housing. There's some diagonal bracing behind this point that was up for the draft gear housing and then along the outer edge where the other 100,000 could be taken. And this, what looks like it might be a decorative skirt, and it is a decorative skirt to some degree, is also a load-bearing member, which will take the load from the outer edge of the end plate up into the car body structure. So this has proven to be very effective in minimizing damage to lower end, at the many grade crossing collisions that Amtrak has had already.

Now how well did we do with all of this? When we actually ran the strain gauge test, the results look as follows. This is not the strain gauge results figures. These are the deflection results, but they're indicative of the analysis that was done by FEA. If you look at the vertical load piece of it, this is how the car body would deflect when the weight of the fuel, the engine, and the other pieces of equipment were mounted into the car body shell, calculated at the A position, which is the front end of the locomotive. They calculated 0.7 of a millimeter deflection, and we measured actually 0.8 of a millimeter deflection. At the center, they calculated a -4.3 millimeters, that is a

downward movement, measured at -4.4. Very, very close agreement. And at the other end, it was 0.4 millimeter and 0.3, respectively. When the 800,000 lb. buffing load was added at the draft gear stops, we then had the combination of the vertical load, which was all the dead weight that was put into the locomotive and actually measured. When you put on the 800,000 lb. buffer load, the calculated deflection was going to be 15 mm downward at the A position and we measured at 12.

At the middle of the locomotive, when you combine the vertical dead weight with the 800,000 lb., the calculated was 0.3 versus 0.2 downward and at the other end, it was 13 down versus 10. One other measurement that was made which was interesting was the compression of the locomotive due to deflection and otherwise, in the horizontal plane. That was calculated to be 12.4 mm of compression, measured at 11. So it's approximately 1/2 inch. That would be from this draft stop back to this draft stop.

Let me just briefly show a location of apparatus and highlight some of the things that I've talked about a little bit further. In fact, I'll just concentrate on this one right at this moment. Once again, the front piece is just decorative, right from here to here, and that is proven to be something that Amtrak, of course, has had in place periodically at the grade crossing accidents, because it is only made out of 2.5 mm steel. Now the frontal plate, the main plate that satisfies S-580 is a high-strength material, about 50,000 psi yield and about 3/8 inch thick. It uses the ratio effect from the 25 psi and 1/2 inch plate so that we could use a slightly thinner material. This same material is carried up at least halfway past the windows as well, so this whole frontal structure, from this point on down would satisfy S-580. Down below the platform at this level, of course we have the side skirt, which then takes the side loads into the car body, and of course everything done in between the two main cells was to distribute the load out to the side walls which were the main loadbearing members.

Okay, let's change directions a little bit and get to the fuel tank design criteria. This was one of the ones where we did have quite a bit of input from Amtrak as to what they wanted, what they would like to see in these new locomotives compared to their older fleet. And one of the things was that the fuel tank would be an integral part of the monocoque structure. It would be spill-resistant and divided into four equal compartments. The idea being that should any compartment be violated for any reason, that the amount of fuel contained would be, that would be the only amount that would be leaked onto the ground. The other three compartments would still remain intact. The bottom sheet is high enough above the rail, 29 inches so that minor derailments wouldn't contact the rails or any low-lying equipment along the right-of-way. A key criteria is that it can be filled from either side to all compartments. In other words, Amtrak at their fueling stations, just wants to be able to hook up to the fuel fill at one location and not run over to the other side to fill the other compartments. And in addition, it has to go both front and back into the four compartments.

There are individual suction and returning line shutoffs from each of these compartments. This would have the benefit that if one tank does leak, you can actually use the fuel transfer pump of the engine and pump the fuel into the other three tanks that aren't leaking if in fact there's enough space to do that. Now, if you've just filled the locomotive, obviously that couldn't be done right away. In addition, then, that particular compartment can, the fuel suction and return can be shut off. The fill and vent system is designed to minimize or eliminate fuel spill in a rollover and I'll show you a little bit more about that later. The fills and site glasses are recessed.

And if possible, anything that was attached to the fuel tank should have breakaway supports such that if there was an impact on accident, that that piece could break away without violating the fuel tank.

This is a diagrammatic of the patent that we filed on this that would indicate how the fuel fill system can prevent leaks. The main body of the locomotive structure actually has the tanks on either side with the center being non-structural, primarily. The fuel is put in from either side into a fill chamber. Now this chamber is not connected to the front or rear tank except through these fill holes. And so, as the fuel enters the fuel tank, or into this compartment, it fills up the chamber simultaneously spilling through the fill holes to the forward and to the rear compartment on this side of the locomotive. And then, at the same time, it's transferring to the other side, filling this chamber and doing the same thing. So that's the principle on which all four tanks are filled simultaneously from either side.

Now, should the locomotive be in a derailment and lay on its side, you would have what we see down below. Let's say that the left tank is up and the right tank is down. Obviously, if the left tank is up, the little fill chamber, of course, from this compartment was right here. So any liquid that's lying in the tank is just trapped within the tank. It will not come through fill pipes to the other side. Conversely, the side that's down, if it's lying on its side as shown, the liquid level is about here, and these are little fill areas right here. And so if one of the tanks, of course, is violated, yes the fuel from that particular compartment will leak out, but the others will not. There will be no transfer from this side to this side, even if there was a slight rupture at the lower part.

Now let's take a look at the vent system. The vent system is relatively simple in that the vent is not just a hole in the top of the tank, it actually is inside the tank at the innermost part, so the air has to vent out this way and then similarly, when the locomotive, if it's laying on its side for any reason, or even if it's upside-down by the way, this still holds true. If it's lying on its side, the liquid from this particular tank, of course, the only way it can get out through the vent would be to come down through this way. Well there's a little level on the right here too, obviously. So it wouldn't leak out. The liquid on this tank down below also cannot leak out. So the fuel is contained, in the event of a roll-over or if it's on its side.

Well, how well did we do? There have been a number of spectacular accidents and I noticed when I was putting this together, I obviously didn't include Silver Spring as such, but we can talk about that a little bit. The impact capability of this locomotive now has been well-proven. When they first went into service, people were concerned, you know, what is going to happen in a great impact and fortunately today, we still have not had a train-to-train and hope we never do, but nonetheless, in the impacts that it has had, it's done very well. There was a case, and I don't know the location, but at 55 miles per hour one of the units hit a tractor trailer loaded with sand and it split the trailer in half and threw the sand all over the place. It was in the radiator compartment, it was in the engine, the fuel fill area was on, all of the truck's bogies. It was every place you can imagine. It did not go in the operator's cab though, so there was no problem. The trailer itself supposedly was thrown over the top of the locomotive. And I think the sloping front sheet helps contribute to some of the safety because anything that impacts it does not have a direct head-on penetration, it's actually deflected, what the fellows from General Motors were mentioning earlier today. So I think that is of some benefit.

The other one that was very spectacular happened in Hudson, New York about maybe a year or so ago. The locomotive came around a curve and saw at an unprotected grade crossing there was a tractor trailer straddling the tracks and they hit it at 98 miles per hour. And this tractor trailer was loaded with 44 lbs of newsprint. Now that's the payload. I don't know what the trailer itself weighed. And some of these newsprint rolls went flying off into space pretty spectacularly, crushed a car, knocked bricks out of a building, and the trailer wound up wrapped around the front of the locomotive when it finally came in for repairs. The windshields were cracked, but the small shield prevented anything from getting into the operator's cab.

And there have been many other, I say various and various, accidents with automobiles. The first one occurring within less than a month of the locomotives going into service down in New Orleans. A driver waited for a freight train to pass. As soon as the freight train passed, he said I can go. Well unfortunately he went, but he went right into the path of this Amtrak locomotive and there was a little sports car, I understand, effectively a non-event for the locomotive. The car was split in half and obviously the driver didn't make it very well. And of course, we had a very spectacular accident in Mobile, Alabama, in which a train traveling at 72 miles per hour was thrown off the bridge and fell in a riverbank and I'll tell you a little bit about that in a moment. And in that case, of course, there was significant damage below deck. But the upper superstructure did quite well. In fact, some more damage occurred just trying to remove it from the river bank. So in all cases, other than Mobile, there has been relatively minor front end damage as a result of what has been done. All units are back in service. There hasn't been any true fatalities.

Let me put this in the way I actually took the picture. After the locomotive was pulled from the riverbank in Mobile, it was laid on a dock and this is how it lay, on its side, so that's how I took the picture. But let me just rotate it so you can see it better, you can see clearly the area which of course is sheet metal. This right here is the front thin sheet metal area that is removable and replaceable and it's actually stitch-welded to the car body and then filled in with a bonding agent to make it look like it's a continuous piece of material. But obviously this has allowed Amtrak to, in a relatively short time, take locomotives into the shop, repair them after a grade crossing accident and get them back out in the field.

Here's the collision post. It's very evident. As this locomotive was impaled in the river bank, it withstood I should say, about 1,300,000 lbs of frontal force, because it went from approximately 70 miles per hour to about zero miles per hour in about 50 feet. And so you can just kind of make the numbers. Besides that, the trailing F40 locomotive behind it helped drive it into the ground. And so after it got pulled out, this is what it looked like. Now similarly, laying on the dock, the bottom part was of course fairly heavily damaged and what you see here is this actually is the dividing line. From here forward, which is 45 feet, was the locomotive that was jammed into the earth, with just the back end sticking out. Back end being from here back. And what you see is a fire line. Several fuel tanks were separated from the locomotive, they ruptured, the fuel caught on fire, and there was a fairly significant fire involved. Now this locomotive was the lead locomotive in the consist, and when it hit the bridge girder, the bridge girder did violate this part of the fuel tank as well, as you can see. But that helped catapult the locomotive off to the side and into the river bank.

One thing that I mentioned earlier was designing supports that would not violate the fuel tank. Here we had had reservoir supports. The main air reservoir supports. And the reservoir was

ripped off by the girder over the bridge as well. But you notice the supports are pretty much intact and hadn't ripped the tank open. I think one of the key things for spill resistance is to make sure that anything you support in and around tanks can separate without violating the tank itself. In addition, you generally want to have internal ribbing backing this up too, so you don't flex oil can to plates.

And with that, I just want to mention one thing. In this seminar or symposium, we're all talking about crashworthiness, and where the interesting events or stories are heard was from one of Amtrak's train crewman. We were going along out West, about 90 miles per hour, I think it was on the Union Pacific. The locomotive was making a broad sweeping curve on a double track section and there was a headlight in the distance and this was at night and so one of our field service guys says to the engineman, of course his help is over there too, he says now, suppose you realized that that train coming the other way was on your track. What would you do about it? I mean, we've talked about crash refuges, we've talked about jumping, whatever. The engineman gets out of his seat he says well, son, I'll tell you what. I would just go back to the control compartment, I'd stand like this. And the field service guy says to him, why would you do that? He says well, I want to meet my maker with open arms. I think that at these high speeds, these enginemen are realists, they know it's going to be extremely difficult for anybody to do anything that absolutely guarantees their safety. And so with that, I'll conclude. Thank you.

PRESENTATION

GE GENESIS SERIES LOCOMOTIVES

***SYMPOSIUM ON RAIL VEHICLE CRASHWORTHINESS
GE GENESIS SERIES LOCOMOTIVES***

BACKGROUND

- IN 1990 AMTRAK ORDERED 74 LOCOMOTIVES
 - 20 DASH 8-40BH LOCOMOTIVES, DELIVERED IN 1991 (BASED ON DASH 8-40B)
 - 44 GENESIS SERIES I (SINGLE MODE) LOCOMOTIVES, DELIVERED IN 1993
 - 10 GENESIS SERIES II (DUAL MODE) LOCOMOTIVES, DELIVERED IN 1995
- ALL UNITS >> 4 AXLE DESIGN w/ HIGH SPEED GEARING
- DASH 8-40BH AND GENESIS SERIES I UNITS >> AC/DC WITH INTEGRAL HEP ALTERNATOR
- GENESIS SERIES II UNITS >> AC/AC w/ INVERTER PER AXLE AND HEP INVERTER

***SYMPOSIUM ON RAIL VEHICLE CRASHWORTHINESS
GE GENESIS SERIES LOCOMOTIVES***

WHY MONOCOQUE CARBODY FOR GENESIS??

- AMTRAK SPECIFIED FULL WIDTH CARBODY
- LIGHTER WEIGHT ALLOWED HIGHER HP AND GREATER FUEL CAPACITY
- GE HAD LICENSEE IN GERMANY (KRUPP) TO BUILD EXPORT LOCOMOTIVES
- KRUPP HAD EXTENSIVE FEA EXPERIENCE DESIGNING LIGHTWEIGHT LOCOMOTIVE STRUCTURES
 - E120 CLASS AND ICE LOCOMOTIVES FOR DEUTSCHE BUNDESBahn
- CONTRACT WITH KRUPP TO DO CARBODY ANALYSIS UNDER GE DIRECTION

***SYMPOSIUM ON RAIL VEHICLE CRASHWORTHINESS
GE GENESIS SERIES LOCOMOTIVES***

CRASHWORTHINESS DESIGN APPROACH

- TWO MAJOR AREAS CONSIDERED
 - CARBODY STRUCTURAL INTEGRITY
 - SPILL RESISTANT FUEL TANK
- MEET ALL FRA, APPROPRIATE AAR AND AMTRAK REQUIREMENTS
- EXTENSIVE FINITE ELEMENT ANALYSIS
 - 1/2 MODEL OF SYMMETRY
 - NINE SUB-MODELS
 - CONFIRMATION OF DESIGN VIA EXTENSIVE STRAIN GAGE VERIFICATION (CARBODY AND COLLISION POSTS)

***SYMPOSIUM ON RAIL VEHICLE CRASHWORTHINESS
GE GENESIS SERIES LOCOMOTIVES***

CARBODY DESIGN CRITERIA

- COMPRESSION 800,000 LBS
- COLLISION POST AT TOP 200,000 LBS
- COLLISION POST AT DECK 500,000 LBS
- BUFF 2 1/2 g's
- TRUCK TO CARBODY 250,000 LBS (ALL DIRECTIONS)
- COUPLER CARRIER VERTICAL 100,000 LBS
- GRADE CROSSING FRONTAL IMPACT 200,000 LBS / SIDE
(ON END PLATE BELOW DECK)
- END SHEETS MEET S-580 CRITERIA
- WINDSHIELDS MEET FRA 223 TYPE I GLAZING WITH SPALL SHIELD

***SYMPOSIUM ON RAIL VEHICLE CRASHWORTHINESS
GE GENESIS SERIES LOCOMOTIVES***

FUEL TANK DESIGN CRITERIA

- INTEGRAL PART OF MONOCOQUE STRUCTURE
- SPILL RESISTANT
- DIVIDED INTO FOUR EQUAL COMPARTMENTS
- BOTTOM SHEET HIGH ABOVE THE RAIL (29 INCHES)
- CAN BE FILLED FROM EITHER SIDE TO ALL COMPARTMENTS
- INDIVIDUAL SUCTION AND RETURN LINE SHUTOFFS
- FILL AND VENT SYSTEM DESIGNED TO MINIMIZE OR ELIMINATE FUEL SPILL IN ROLLOVER
- FILLS AND SIGHT GLASSES RECESSED
- IF POSSIBLE, USE BREAKAWAY ATTACHMENTS FOR EQUIPMENT SUPPORTS

***SYMPOSIUM ON RAIL VEHICLE CRASHWORTHINESS
GE GENESIS SERIES LOCOMOTIVES***

RESULTS

- IMPACT STRUCTURAL INTEGRITY WELL PROVEN
- ???? 55 MPH HIT TRACTOR TRAILER LOAD OF SAND
- HUDSON, NY 98 MPH HIT TRACTOR TRAILER LOAD OF NEWSPRINT, 44,000 LB LOAD
- VARIOUS VARIOUS MANY OTHER AUTOMOBILE GRADE CROSSING ACCIDENTS
- MOBILE, AL 72 MPH IMPALED IN RIVER BANK >> 45 FT SIGNIFICANT DAMAGE BELOW DECK

**IN ALL CASES (OTHER THAN MOBILE)
MINOR FRONT END DAMAGE
ALL UNITS BACK IN SERVICE
NO FATALITIES**

Structural Crashworthiness Panel Discussion

TOM TSAI: I think this morning we have three excellent talks on locomotive crashworthiness. These are North American locomotives. One is mostly EMT, mostly freight service but a lot of EMT service also come in rail and Intercity Service as well. And GE talk about essentially an Amtrak locomotive. We understand that the locomotive design shows as strong as possible, very strong, probably the strongest in the railroad at this moment. GE shows that the locomotive survive all those things. I think it's going to show that over the years, as Harvey's diagram shows, the fatalities of crews have been reduced dramatically.

Things are improving but why are we still talking about crashworthiness. Probably because we had a couple accidents early this year. In both cases, locomotives were involved. Also, unfortunately the cab car also involved. Sometimes the cab car, because they are designed not for crash with those kind of giant locomotives, they did not fare better. They got the worse end of it. In all presentations this morning we did not talk about any cab cars. But as far as regulation is concerned, cab car is also defined as a locomotive. Therefore, I think when discussing this panel, I'd like to keep that in mind. You can address the issue as well as cab car crashworthiness. Particularly the cab car versus locomotives. I know a lot of energies to ask for the cab car to survive. But maybe there's something, we can think about it. This symposium, it's a technique symposium. It's not a referendum, all right, what ought we to do, but it is a technical issue. Any issue you can come to, we address it, discuss about it, then we go back, hope that something can come out of it, make a recommendation to the Office for Safety at FRA.

We noted yesterday the panel session was a little bit fireworks going on, but let's keep quiet, address the technique issue. Anything we can do from the R&D side of the FRA, we will try best, try to do some research. So there are two things I'd like particularly to ask for your help. Tell us what the FRA ought to do, not for regulation only, but in the research need. If you think there's something FRA can do to support your ideas, let us know. We do something about it. FRA is not only for regulations safety. We work for safety, of course. We all do. But there are times, technology you have. So with this remark, let me open the floor first to the panelists. Anyone have more additional comment to cab car or anything first?

THOMAS PEACOCK: I'd like to take a shot at the cab car issue. In the case where cab cars running the locomotives, not the other way around. Somebody caught it. As I think about the Silver Springs, Maryland accident and what might have happened if it was truly head-on and the cab car and the locomotive had locked together, and thinking about the momentum of the locomotive, you see some of these, well we saw movies of what happens when basically two similar objects ran into each other and the amount of disintegration of the cars that was involved. I think of the locomotive would have been, just to have gone through the cab car and disintegrated it if you had forced them to lock together. Of course, that marked train would have come to a sudden stop because the mass of the locomotive was so much higher than the mass of the car. I think there would have been even more injuries and probably more severe injuries, maybe more deaths in the marked train. It probably would have not made a whole lot more difference to the Amtrak train. In thinking about that, and one of the things that prompted some statements in our proposal for design philosophy, then maybe you ought to design these things to collapse in such a way that they pass by each other rather than lock and stop, the idea that it is a lot easier to dissipate this energy in brakes and friction on the ground and digging trenches than it

is in collapsing. You get this big mismatch of energy, it isn't going to just stop and crush, it is just going to plow through.

TOM TSAI: Thank you, Tom.

AL BIEBER: I have a follow-on to what Tom was saying, but it is along a little different light. I remember seeing a paper a while back about high-speed trains and crashworthiness where the study was suggesting that you wanted to contain the train to be all in line in a right-of-way so of course it didn't spill over to an adjacent track and have a secondary impact from another train passing. That in itself I think is a very difficult challenge for absorbing the energy of that train where is if most, at least passenger trains accidents or freight train accidents, if the cars jackknifed and they go into the roadbed and so forth as Tom suggest, they can dissipate energy that way, and I think that is a clear way of doing it. If high-speed trains for instance were designed that had rights-of-way so that the tracks were not too close to each other but you allowed the cars to jackknife you might prevent more fatalities even that way because it would absorb energy in a different mode. I recognize that is an extremely expensive proposition to have wide rights-of-way to separate tracks, etc. Once again since we were talking theoretically, it's a possibility.

HARVEY BOYD: I think it is very difficult to conceive locomotives crashing together at fairly high speeds and not having a problem. And yet I see some definite advantages of passengers in passenger cars to work in Crisis Energy Management that may be very beneficial to them, and so now you have two different systems, so what's at the head of the train, versus what's in the middle of your train. And you have the large numbers of freight out there which may or may not be compatible with the passenger service. You're trying to bring two different possible philosophies together and make them work as one and I am not sure that's possible. You may be sacrificing crews at the expense of passengers and maybe sacrificing crews of freight trains at the expense of passengers. I am not sure if that is where the emphasis needs to be. I am not convinced at this point that Crash Energy Management is totally viable at 70, 80, or 90 mile per hour closing speeds for locomotive to locomotive, but in certain other situations it is. Locomotive to cab car, no, I don't think it is viable. How often does that occur? I think you need to take a look at the frequencies of the types of accidents and say, "Oh, I am going to tailor my philosophy to the larger number or to the specific number, I don't think there is a one philosophy that will be a panacea for all of these accidents." Again, from what we have been hearing, I don't think any of the philosophies are particularly wrong. I think they will all work to some extent. The question is, which is going to work better and I think the jury is still out on that. And that is where our real challenge is going to be is to take and separate out the load cases and the frequencies of those particular load cases and then decide from there where we want to go.

RON MAYVILLE: Make a few comments about what's been said. Tom, you asked about R&D. Thoughts about R&D that should be done related to cab car crashworthiness. A couple of thoughts there. Some research has already going on related to determining what is the feasibility of improving crashworthiness of cab cars. We have heard that same statement made many times during the last couple of days. What's feasible, and what's practical. And as I said, some of that work that is going on is sponsored by DOT. The other thing I would like to see more effort spent on is making the hard decision about what it is we're trying to protect against. What kind of closing speeds, for example, in configurations do we really expect to have protection against, are we after the 60-miles-per-hour closing speed or the 40-miles-per-hour closing speed and perhaps having the lower goals could still be very useful for making significant improvements in

crashworthiness while making it practical. That's a very hard decision to make, and I gathered in the little time I have spent in this area. The other comment I would like to make is in regard to the deflection issue, and Harvey, Tom and I talked about this yesterday, and that is the feasibility of deflecting one train past another, the whole issue is about rights-of-way and things like that. But, some of the calculations that we did, suggested at least for direct in-line collisions, and I know we talked about this yesterday, and that is a subset of all the types of collisions that occur, when two trains are directly in line it is very difficult to make the trains move side to side before substantial damage is occurred just because of the great yaw inertia related to vehicles. Now, as you pointed out yesterday, Tom and Harvey, there is a large percentage of the small number of accidents that occur at grazing angles and curves and things like that, and perhaps in some of those situations such strategy could be useful.

DENNIS RAMM: Well I can't disagree with really anything that anyone has said here. I think that the analysis of the crashes, and really, given that description, identifying the average speed ranges for various types of operations that we have out there this is where we really have to do some analysis and then take that analysis and really put that together with the researches that are necessary to analyze what we're really talking about. And that, to me, seems like the best bang for the dollar. We can be, as has been pointed out several times in several papers, we make the wrong assumptions here, we'll be looking at the wrong pieces and that doesn't help anyone. So I know as chairman of the Press Crash Group, one of the things that really is quite obvious to me is that a great deal of work done on Tier 2 and I was very, very impressed with the presentations yesterday to see how far along this type of research has gone, and I think we need to take that type of approach to a lot of different crash analyses that are out there and see how that fits, as we try to develop standards for the future. I think that from an industry, from the group that is working together, I think what we've taken, we've taken the approach that says that we know that there's a portion of crash energy management and there's a portion of the AAR S-580 standards that we know works well and I think that we're at a point where we can support that. Then it becomes what do we do next? And as we respond, as we work together with FRA to get this regulation going, I think that FRA will find and the industry can see that we've identified some things that we're calling global issues. These are things that we really don't have a good feel for or an answer for, and that's where we'd like to see some research put together so that we can make the correct decisions in the future.

THOMAS PEACOCK: I'd like to generate a little more discussion on where do we go from here. I think FRA has changed the way we do business with you a little bit and if we opened up and tried to make it work, you get more insight into our people and I think this conference has fulfilled about half of my needs in that I've learned an awful lot about what is impractical, what can't be done. However, I would like to see some of the thinking from here, the next three years we have before we have our second edition of the rules. Get your relationship with us not be so defensive. You don't need to defend yourselves from our proposals as strongly as you do. I think what you need to do is channel some of the energy you create, fit it into not what can't be done but what can be done. Start taking the offense with your own men. I'd just like to hear some response to this.

AUDIENCE ATTENDEE: I'd like to at least make a statement along those lines in that, as far as locomotive design people, kind of the lowest level of design criteria, the most basic level of design criteria is the federal regulations. Certainly you don't want to violate those but also, you pretty much don't want those dictating the actual design. There are too many other

considerations. I guess what we would like is very much the definition of the philosophy and what we would like to happen and some definition of the load cases to design for, and then let us do the designing. Don't put the design into law.

AUDIENCE ATTENDEE: I think if we just look at this problem from an outsider's point of view-

MIKE FEINBERG: Mike Feinberg from the National Highway Traffic Safety Administration. I don't work for the FRA, I don't work for the rail industry in any regard, but I do see a lot of similarities between the problems you're discussing and the automotive situation. In some crashes, I've heard a lot of talks over the last couple of days, talking about 30-miles-per-hour closing speeds, 150-miles-per-hour closing speeds. Those are clearly different situations. In looking for areas of research, R&D considerations, and one of the things that we're working on now is I think related, is looking at airbags and trying to protect people in frontal crashes. Now it's a very different situation whether you have a 10-miles-per-hour crash or whether you have a 60-miles-per-hour crash. The kind of technology that we're working on now is to determine very quickly when the crash occurs, what that speed is. If you have a 10-miles-per-hour crash, you don't inflate the airbag at all. If you have a 20- or 30-miles-per-hour crash, you inflate it slowly. If you have a 50-miles-per-hour crash, you inflate it very quickly to get it out before the occupant sets into it. I can see a similar kind of possibility for your application. In some cases, where you're talking about a 30-miles-per-hour closing speed, it might be most beneficial to keep the trains in line and to use your crash energy management in line, keep the trains on track. As you get to a higher speed, 60, 70, 80 miles per hour, it might be more beneficial to let the trains pass by each other using the energy consumption of the ground in breaking or whatever other friction is involved. So maybe you have some technological aspect you can look at as far as maybe you ought to handle different crashes in a different way and not try to handle every crash in one specific pattern. Just throw that out to the panel.

AL BIEBER: There needs to be a distinction between high speed train sets I think and maybe the general operating of the freight railroads themselves, which are kind of widely diverse. The locomotive builders have to provide equipment that will interface with all the existing equipment that's been built for the past 20 to 30 years. Those constraints are real, like having snow plows on the locomotives, The coupler height, the end connections, and so forth. And so all of that comes into play, whereas when you have a high speed train set being designed from the ground up, I think the option is to become a little more open at that point. The coupling method you use, the way you have the cars attached, etcetera, they can be looked at in more detail. The freight railroad side, there's a lot of history inherent that does have to be considered, unless someone wants to change all the existing freight vehicles that are out there.

FRANK CIHAK: Frank Cihak from the American Public Transit Association. I was really impressed by the progress made by locomotive design here and particularly protecting crew members. I was really impressed by this, particularly the very recent experience of the latest designs. It's pretty good. Tom, you mentioned the cab car issues and that's largely an issue of disparity between locomotives and cab cars in terms of mass. The question I have, or the point, is that maybe it should have been made yesterday when we had people that were talking about dedicated train sets, but if the locomotive at the end of the train is the problem, thinking about dedicated train sets in a more conventional situation, and I notice it had been done before, you

know, why not put the power unit in the center of the train and have all the ends the same. And then you can deal with the power unit downstream somewhere inside the train.

TOM TSAI: That sounded like something we had read this morning. The MBTA running right in the middle. Both sides, no operators. Any comment from the panel?

PANELIST: It seems to me that one reason might be that you have double the number of, more exposed ends if you put the locomotive in the middle.

PANELIST: The ends become less exposed because you don't have the mass at the end.

PANELIST: That's right, you'd be less likely to hit a locomotive, that's true. The question is, whether there are consequences for the kinds of collisions that would occur of having cab cars collide, versus a cab car and a locomotive. But there are certainly scenarios where there are big differences, but there may be some scenarios where there are not as big differences, and scenarios that are likely ones for real operations.

PANELIST: I suppose we don't have a lot of data on two cab cars colliding because obviously one train's got to be going out, one's got to be coming in to have a collision to begin with so, but I would think that there might be practical operations problems with that, having to do with platform length and how to get people on and off.

HERB WEINSTOCK: Herb Weinstock, Volpe Center. In the past couple days we've heard some different philosophies on the structural design. One dealing with the essentially self-propelled power front, self-propelled car, the passenger car, others dealing with the integral train set design and others dealing with the freight locomotive design and all locomotives. Although they're built for all purposes, should be, we're talking about different kinds of structural considerations for design in applications of passenger trains than in designing a locomotive or freight train.

TOM TSAI: For the purpose of this symposium, it is rather structured, and the other factor which was not discussed, let's concentrate on the issue today. Structurally, how do we make the safety better. Any other suggestions for that?

DAVE TYRELL: Dave Tyrell, Volpe Center. Let me ask a slightly different kind of question. In light of recent accidents, what kind of things can be done, I guess within the current philosophy in order to ensure greater compatibility between cab cars and locomotives?

PANELIST: One explicit thing is to make the locomotive as weak as a cab car. That's not very practical either. Or make the cab car as strong as the locomotive. I mean, those are your two extremes. Neither one of them is very reasonable, I don't think.

DAVE TYRELL: The condition that is kind of in the back of my head is in essence in Silver Spring, the cab car got overridden by the locomotive. What kind of things can be done to prevent that?

PANELIST: I would guess, as I think about the Silver Springs cab car, obviously we're not the ones analyzing the cab car, the NTSB is going to do a formal report and no, we aren't going to

second guess them in this conference. It would appear to me that the corner collision post structure of the cab car, I don't think there was much of anything there and that even the kinds of regulations that are in place today would probably have required some more structure at the corner of that cab car. The collision post structure of the locomotive stood up very well, compared to the cab car. I think that one thing I observed is, that again was not a head-on crash. There was a little bit of angle to it that designing, say, a strong structure behind the doors and behind the stuff on the locomotive wouldn't have allowed those front ends to collapse, for instance and provide lateral ramps that would have pushed the cab car out further faster, changing some of the momentum, the inertia, providing some force in that direction to make that happen. In the case of the deaths at Silver Springs, they were by fire, so we have to somehow get the fuel tank so it doesn't get hit. And maybe a structure behind the steps might help something like that.

DAVE TYRELL: To go back to something that was said earlier at Harvey's presentation, my understanding is that the Maryland coroner initially attributed five of the deaths to be essentially from crushing of the occupant volume and then later changed that to three. Other fatalities attributed the remaining eight to the fire. You can also argue that injuries sustained either due to crushing of the occupant volume or due to secondary collisions could be attributed to the other eight fatalities. That's one point. I guess what I'm really questioning is whose responsibility is it to ensure compatibility. There was a fair amount of override in cab car structure in that collision. Essentially intact. I agree it's a very tough situation. There seems to be something incompatible but I'm not sure whose responsibility it is to fix it, that incompatibility.

AL BIEBER: There definitely is incompatibility in the height of platforms. Harvey pointed out earlier to get a locomotive to pass over the truck assembly requires a certain physical height and there's no way of really lowering that. Then the alternative is raising the platform height of the other vehicle which also is not all that great and over the years there's been a lot of discussion between the other locomotive builders that used to exist about how high should platforms be. Such that when they do come together in a collision that we don't minimize the overriding tendency. Really the height of the platforms is dictated a lot more by means of strength of the car body, the need to carry the weight of the equipment, and so forth, as well.

PANELIST: If you raise the floor level of a cab car to be platform height of a locomotive, then the strength issues would be, the coupler being down low and the main structural numbers being up high. I think you would have wound up with cab cars that weighed as much as locomotives and maybe that cures your compatibility issue, but you can't afford to operate them. Small platform differences between their locomotives and our locomotives seem to get, those differences seem to wash out in suspension dynamics and the underframe flexibility issues and things like that that control who overrides whom. I don't know how to answer that, I don't think there is an answer.

PHIL STRONG: Phil Strong, Long Island Railroad. I thought the platforms were about 15 inches high. A lot of railroads operate some or all of their service in high level platform territory so that's a natural height for the floor of the passenger car. Locomotive underframes are, I think, are in the neighborhood of 68 inches high or thereabouts. I don't know that there's any easy, short-term answer to that. Raising the platforms 18 inches is pretty tough, in the short term. It sort of seems self-evident that, a close look, maybe a closer look should be given at the collision posts and the corner posts construction. So that they can carry, you know, the loads that are

equal to, or close to, what the locomotive will deliver so that they share equally in the crushing. Or more equally than they do now. The idea of jackknifing or climbing over will work sometimes, but it won't work all the time. It won't work as well in tunnels, for example, the jackknifing thing. It seems like that idea of looking at the increasing the design of the ends of cab cars and MU cars is something being closely looked at.

JACK HYNES: Jack Hynes, Florida DOT. I'll direct this to Tom. Your lateral pass by an idea seemed maybe an idea that has some merit. You've probably given some further thought to its implementation. What would you suggest to, implement such a strategy.

PANELIST: How we go about implementing such a strategy? I think it probably is not the answer to everything and we have to decide which conditions we want that to occur at if we're going to deal with just, as was suggested earlier, just the higher speed end of the not quite straight-on collisions or try to present-I see very few of these collisions where the couplers actually meet. So I think there's an opportunity to design pass-by kind of structures. Again, a conference like this, if there was some mechanism for reaching a philosophy and a kind of a general mode case would probably be enough for us to change the way that we design locomotives. And I assume it would have a similar impact on other people who are designing equipment. We're interested in making it safer, making it stand up better to these kinds of collisions. And what we were looking forward as a design organization would be a, for lack of a better word, clear statement and philosophy. When we want this to happen, what do we think the loads are. And where would they hit. So we need some help with this. I didn't know that platforms are at 15 inches. There's so much information out there to learn and what we're looking for is continuously getting educated.

GRADY COTHEN: I just wanted to mention something that's known to some in the room but not to others in the room. The last meeting of the Passenger Safety Standards Working Group, we asked for an effort to examine whether or not there are any ways of making incremental improvements in the instructure of cab cars. Part of the ADL work that was not presented today included an analysis of current performance of cab cars. There are some of us who have given the mass of the passenger or freight locomotive, actually are very, very skeptical of the ability to deal with closing speeds of 60-70 miles per hour. This is what we saw both in Secaucus and Silver Springs. However, we keep getting reminded by our colleagues that so many of these collisions are in fact, at low speeds. And there may be opportunities to prevent future events. Collecting data points once is a problem because there are not many events, however they are taken very seriously by all of us when they do occur. So the Volpe Center is working on a short-term effort to carry forth to a tentative conclusion the effort we undertook after the Gary, Indiana accident of January 1993 to determine feasibility of improving the instructure of cab cars. And we note that the specific issue raised by the NTSB at that point was corner post arrangements. Had there been a very definitive flexion plate kind of approach, however, in Gary, Indiana, it would have sent one or two loaded MU cars off the 50-foot embankment and onto the roadway below. As it happens, the corners of both MU vehicles crashed. Again, solutions are less evident than the questions.

In Silver Spring, the current FRA AAR standard collision post as well as the corner structure was completely sheared at the floor. So there was some engagement of collision posts in that accident. If anyone has ideas from their experience as to how at the lower closing speeds we can

make marginal improvements, that could be incorporated by our carbuilders in cab cars that will be ordered over the next 3-5 years, we would certainly welcome those ideas.

We also note that we always need to take a lesson from the crash energy management concept that was presented by the SNCF representatives which certainly can be applicable to diesel-powered equipment as they indicated, as well as electrically powered equipment with the possibility of putting a crush zone behind the operator. One of the barriers we've not gotten over yet, the Passenger Working Group is finding the willingness to discuss the use of crash energy management techniques for what may be described as conventional equipment. And it is in the conventional speed range where most of these accidents occur (as has often been pointed out here) current state-of-the-art technology permits us to take maximum advantage of state-of-the-art crash energy management techniques. Again, we hope that discussions like that, I'd like just to point out the difficulty associated with some of our wilder ambitions with regard to occupant protection, but also produce a certain convergence with respect to what can be done in the short-term. If you have ideas about what might be done with respect to cab cars instructure, do talk to Dave Tyrell at the Volpe Center here. I'm sure you'll be welcome.

ROBERT GALGANSKI: I'm Bob Galganski from CALSPAN SRL. On the issue of compatibility, collision compatibility between cab cars and locomotives, now I'm from the automotive safety world and back in the late 70's, we collaborated with Chrysler Corporation on the design of an RSV, that's a research safety vehicle. I don't know if anybody remembers that. But we basically had a three-step crash pulse. It was designed, the bumper was designed to take the parking lot impacts with zero damage. Also it was designed in case it hit a pedestrian to toss them onto the aluminum hood to minimize damage to the pedestrian. And then it had a secondary zone behind the bumper area in which case it would handle impacts with vehicles that were weaker than the RSV, a compatibility zone. And then behind that for real high speed impacts when you needed a lot of energy absorption, we had a structure that could absorb a lot of energy, it could generate a high force level.

Now why couldn't we take that concept and apply it to the nodes of the ends of the locomotive so that when you are hitting something softer like the cab car or the back of a passenger train, the locomotive is going to absorb some energy rather than place the burden of energy absorption on the softer structure. That's a possibility. You may have to increase the length of the locomotive, but weight again, but hey, you've got to do something. This is a possibility. A step crash zone for the ends of your locomotive. It may work. You may want to look at this theoretically and maybe do some simulations with it and then you'll want to do some experimental testing, either crush testing then perhaps, I hate to use the word full-scale, but I think we'd better get used to it. Full-scale crash testing and see what type of forces you develop and then maybe run some crash tests against a weaker vehicle. See what happens. Give it a shot. It may work.

TOM TSAI: I think that Crash Energy Management System we are working on the concept we borrowed from our friends in Europe is applied or has been tried but definitely can apply to freight locomotive. Not that two locomotives can hit each other, but if you have a softer nose, it can harm the cab car more. So that's probably possible.

PANELIST: Early on you asked what the agencies could do if they had anything and those kinds of studies would probably be worthwhile. Seeing if it really has any benefit for a cab car. Let's assume a locomotive has a three-foot crush zone between the car it crushes and then what

happens after that? How much of a benefit is it at 2 miles an hour, 10 miles an hour? How many people might be saved? I mean, that kind of a study is worthwhile.

PANELIST: If, like Silver Springs, the locomotive continues, the trains continue on for a hundred feet and the amount of energy dissipating in tearing up each of the structures and plowing new furrows, it doesn't seem like three feet of crush is going to make that much difference when there's that much mismatch in the inertias. But if we, I guess if we could define the location or maybe we're talking about a little bit of crush then will help a cab car, you know, we could probably find some way to do that.

LANCE SLAVIN: Lance Slavin. We're not involved in the railroad industry so we don't really have sides, but it strikes me that fixing the freight locomotive is a little bit like fixing the earth so that when a plane crashes, the people in the plane can be saved. It seems to me you want to put the protection of the passengers or, not what they might strike. So you go out and fix all the, you fix freight locomotives and the hit a station barrier or some other thing in the road, it doesn't help. It seems to me you ought to be able to put the protection of the passengers, not on what they might hit.

HARVEY BOYD: I think you also need to consider the fact that locomotives still have to do their job. They still have to pull trains and freight locomotives, pull some very large trains. And they transmit all their pulling power through the coupling. We're still going to require locomotives that can transmit up to 1 million lbs. buff load through a coupler. That means the undercurrent is going to be at least that strong. You might be able to make the shorter hoods and that adds some bulk mainframe, more crash energy absorbent. But I don't think we're going to find much change in the underframe. And that happens to be a critical height, unfortunately.

AUDIENCE MEMBER: Increasing the strength of the cab car to be equal to 800,000 or 1 million lbs., 18 inches above the floor of the car will then, probably well before that, either fail the anti-climbing at the trailing end of the climbing cab car or MU car, or jackknife or both of those things and then the crush may continue back between the second two cars. But if the strength of the cab car is significantly less than the locomotive, then the crush would be, you know, may be confined to the front end of the cab car. Secondly, increasing the corner post speed of the cab car to the point where if, the longitudinal load is well off the center line of track, the load can be carried up to the point where they almost derail, that the trailing truck of that car whether load car or the second car, then the encroachment into the passenger compartment of the leading car and you have a collision between the locomotive and the cab car, it seems to me to have less odds of occurring. So I would suggest again that having a closer look at what could be done to the end strength, and not only the end strength of that kind of a cab car, but the end strength of programs of all passenger cars, what can be done to those end strengths to better protect the passenger compartment.

TOM TSAI: Thank you. I think current projects of FRA and Volpe Center are looking at many of those options. One more?

JIM O'KELLY: Jim O'Kelly from Amerail. I heard this mentioned yesterday, and it also came up today with locomotives. I guess it's been a very interesting symposium, but one thing that's apparent to me and I think it's come up a lot in the questions is that if you take a look at what's been done in Europe and their philosophy. It appears to me that this cooperation is between the

end users, the government and the car builders. In the U.S. what I see is, a lot of the studies that have been done, they're with the Volpe Center, the FRA, and apparently what's resulting from, from what I heard, I think every single one of them said, "we don't have any transit experience, or didn't have the transit experience before we started this project." Here we have GEC ALSTHOM working in France, having their engineers doing the modeling, taking that modeling to full-scale crashworthiness testing and basically the British seem to have done the same thing. I don't get the sense that we're doing this in this country. And I think one of the things we're missing out on is the carbuilder's perspective. Most everything we do is low bid and you have competition. We don't have the funds to do a lot of R&D in order to come up with a vehicle that meets the crashworthiness. We need to meet the minimum specification requirements so we can get the job. But it seems that there's going to have to be some government funding working directly with the carbuilder, the two main locomotive suppliers for you to make a car built for the U.S. to supply them with funds and the direction to go out and do some of this testing. A lot of good ideas have come up here today, but I don't think the U.S. is going to be, I don't think they're going to be at the forefront of this if we don't get some government funding for projects to work directly with the carbuilders.

TOM TSAI: Okay, now that's a good question, it's a good comment. Working for FRA for so many years. Let's hold my question.

JOHN LEWIS: I would just like to wholly concur with that last remark. The thing I've observed while being here is the sort of scuffle that seems to be going on between manufacturers and the FRA. Now I don't know whether I've understood this correctly, but this is my perception of what's happening. In France what happened was the SNCF actually worked with one of the manufacturers to develop the TGV. In England, we have to work slightly different, we couldn't do that with big independent manufacturers. We couldn't seem to be climbing into bed with a single manufacturer. We had to deal with all the manufacturers the same. What we did, after we'd done the testing, we took out the first specification, we discussed it with the manufacturers and said what do you think here and their immediate reaction was absolute load of rubbish, why can't we leave things as they are? Because that's what manufacturers want to do. They're production people. They're not, they don't like change. They want to make things the same as before because that's how they make the most money.

But when you explain to the manufacturers the reasons behind this and what you're trying to achieve, and accept their point of view as well, then you start working together. Specifications which everybody agrees on simply emerge and there's a lot of compromise but you actually get things that people agree on. And I'll just pass that off as a comment. It's very important that the manufacturer is taken on board, no matter what country it is. Because if not, you'll just end up with arguments like we've heard over the last two days.

There's one more question as well. This idea of vehicles colliding at high speed, bypassing each other, or one going over the top. We would be horrified in Europe at such a thought. Basically, because we have high-tension overhead cables carrying 25 kv electricity which would fry the driver if he were to survive the initial crush. If they go off sideways, in Europe it's very, very populated and it would probably land on houses or schools or another train coming the other way. Now America at the moment has got much more space to be able to do things, but is this a serious proposition? And if it is, how do you overcome this problem of wiping out a school and then having to live with the consequences of the publicity following it?

TOM TSAI: There are only a couple of minutes left.

AL BIEBER: I'd like to respond to the last remark. I think at least from a locomotive builder's point of view, change is a constant. It's not like change is being resisted, but this being a very market-driven economy, we have to respond in a way that the railroad customers are willing to pay, pay us for what we do. And like AC traction has been a tremendous development because there was a tremendous economic benefit to the railroads to have that increased adhesion. And so change is not being resisted for change's sake by any stretch of the imagination, but it does have to be tied to the economics of the situation. And somebody does have to pay for these kind of developments.

TOM TSAI: That's the old question of bottom line of dollars. We saw technology yesterday which was very impressive of SNCF in France. Technology in U.S. is as good as anybody else. Just matter of commitment.

MARK SNYDER: I'm Mark Snyder from Foster-Miller. I'd just like to toss out a couple of comments or observations that, I know time is short but I just think this might stimulate it a little before discussion, at least in terms of short-term issues regarding cab car safety. And the first point is, I talked to Phil about this the other day and in at least looking around locally, the cab car operator is always off to one side and it seemed to me that an immediate short-term solution would be to position the operator behind the collision post which I believe is done in Europe.

The other thing is these oblique collisions involving cab cars and I think perhaps ADL looked at this in their study, the quadrants of the cars where the passengers are sitting was particularly vulnerable. You see pictures with the sides of the cars and people's backs. Since the load factors on these commuter operations I believe are, I don't know, 60-80%, it probably wouldn't be asking too much of the operator to give up several rows of seats at the end of the cars. And just leave that empty. That was my second point.

My third point is looking at all the double decker cars that are out there today in use, and then seeing the operator smack at the end of the car, I have to ask myself why isn't the operator seating in the upper level and just remove him from harm's way. So those are three things that I've been thinking about for some time and I'd just like to toss those out. Maybe the operators have some comment as to why the cab car operator couldn't be removed from one point, or placed behind the collision post. And also the car builders might have some comments about the viability of, say at least on double decker cars, moving the operator's station up to the second level. Where I don't think you'd be giving up that much in sight distance down the track.

TOM TSAI: I think time is very short, I want to cut off at this point. Just two more.

GEORGE NEWMAN: George Newman from the Brotherhood of Locomotive Engineers. I realize that we're dealing with a technical conference. We have to deal with the industry as it exists and the use of cab cars is widespread out there. As you just mentioned, the operator's in a very vulnerable position in the cab, much more so than in a locomotive. All the suggestions that we're hearing are worthwhile, but it seems to me at some point that you have to realize that a cab car is inherently more uncrashworthy than a locomotive. Why are carriers using cab cars? I would respectfully suggest the FRA consider doing away with cab cars. Let's put a locomotive up there, let's make the operator in a protected position. Cab cars can still be used as passenger

coaches. They're still a worthwhile piece of equipment as a passenger-carrying vehicle and let's get the operator in a locomotive. Thereby we eliminate these crashes of the cab car into a locomotive. Those crashes would be eliminated. And even in a cab car and a vehicle at a crossing, the operator is vulnerable as are the passengers in the front portion of the cab car. So, I know that the cab cars are out there, but maybe they shouldn't be.

TOM TSAI: Last question.

DAVID DYKES: David Dykes, Metro North. I think I can answer a couple of questions. When we run an MU fleet of about 800 cars, as well as push-pull of about 100 cars, we just don't have the physical space to run anything other than full cars. We run a four-track railroad into a terminal where we have to run 100,000 people in a two-hour window. And we've given up about 10% of our seating because of ADA. We're going to have to give up another 25% for the crashworthiness, for the sacrificial zones on the car, and that's putting a strain on our physical plant. It just doesn't work. We cannot run bilevels. We have a situation with a tunnel and it's too short. Additionally, we've got a rough MU experience. We have run what's known as our "N" series car. It's a monocoque construction. For 25 years, we've had 400 of them in service. We have another 250 that we've acquired in the previous 15 years. We have all but two of those cars able to be in service in short order. Two of them have been sacrificed in a single crash.

Those of you who want to know what happens when a cab car hits a cab car, can look at that one incident. We had two M-2s: a stopped train, and another train going 60 miles per hour hit it. One person died--the engineer of the operating train. Everybody else was ambulatory. Now this was two empty trains, but the other crews and the test people all walked away. I think one guy got a broken arm. We did however eat up two-thirds of the car that was moving and one-third of the car that was standing still. I knew what they were. They were scrap completely. There was so little left.

The other portions of the car were viable and people probably would have survived in them but the rest of the train would have had injuries with deaths. That's from the operating side we're looking at.

TOM TSAI: Any concluding remarks? Panel, that was a wonderful talk.

SESSION III: Interior Collision Environment

TOM PEACOCK: I'm Tom Peacock from the Federal Railroad Administration and I'm the Chairman for the final session which is Interior Crashworthiness. We'll have four speakers this afternoon. First will be Robert Galganski from Calspan and he'll speak on the Interior Collision Environment. Bob has a master's degree in civil engineering from the State University at Buffalo, New York. He previously worked for Pratt & Whitney Aircraft as an analytical engineer. He's taught engineering courses and worked for a structural engineering firm in the Buffalo area. Bob is currently Senior Engineer in the Transportation Sciences Center at Calspan SRL Corporation, where he has more than 20 years experience in vehicle crash safety systems research, development, testing and evaluation.

The second speaker will be Dr. Michael Kleinberger from the National Highway Safety Administration and he'll speak on Testing and Analysis of Occupant Vehicle Collisions. Dr. Kleinberger received his bachelor of engineering degree in mechanical engineering from the Cooper-Union in New York City. He received both master's degrees and a Ph.D in biomedical engineering from Duke. His dissertation research involved experimental determination of viscal elastic properties of arteries and the investigation of balloon angioplasty procedures using finite element modeling. Dr. Kleinberger is currently working with the biomechanics research division in the National Highway Traffic Safety Administration in Washington, DC. He serves as the team leader for Human Injuries Simulation and Analysis and he's also the director of the Neck Injury Research Program.

The third speaker will be Steven Soltis from the FAA. Mr. Soltis has been with the FAA for 20 years. He's a national research specialist in crash dynamics. He's actively involved in the agency's engineering and development programs and respective rulemaking activities that concern crash dynamics. Prior to joining the FAA, Mr. Soltis served more than 14 years as a structural design engineer on both rotary and fixed wing aircraft. He holds a bachelor's degree from St. Louis University and a Master's degree from California State University at Long Beach, both specializing in engineering. He's an active member of the SAES9 Cabin Safety Provisions Committee and the American Helicopter Society.

The final speaker will be Kristine Severson. Kristine has been working at the Volpe National Transportation Systems Center as a mechanical engineer since 1994. She's performed research in the areas of structural and interior crashworthiness of trains in support of the Federal Railroad Administration. She received her bachelor of science degree in mechanical engineering from the University of Minnesota, and she's currently pursuing a master of science degree in mechanical engineering at Tufts. And with that, I'd like to introduce the first speaker, Mr. Bob Galganski.

ROBERT GALGANSKI: My topic involves the interior collision environment for passenger-carrying rail vehicles. Basically, we're going to take a look and see what happens to people inside of a railcar during a train accident. Think of this, if you want to, as Car Interior 101.

Now I'm going to make some assumptions here to keep things clean and neat and simple with respect to the type of accident we're looking at. Consider a hypothetical accident scenario where it's assumed that the cabin has done its job. It's provided the protective envelope, the protective cell around the occupants. We don't have to worry about people being crushed to death by

intruding surfaces or the cabin superstructure being penetrated by narrow objects or structure. And finally, we're not going to concern ourselves with occupant exposure to hazards such as fire, toxic gas, water, things of that nature.

That said, the only occupant injuries to be concerned about are those caused by secondary collisions. Now, what are secondary collisions? Well the topic has been broached a number of times during these proceedings over the last few days, but for the sake of completeness, we'll go through it again. Occupant secondary collisions are for the most part occupant impacts with the cabin interior and to a lesser extent, impacts between occupants. This may seem surprising, but secondary collisions are the leading cause of serious injuries and fatalities in train accidents. Now they're certainly not as spectacular as being crushed to death, or being speared by something coming through the cabin, but they do constitute a significant problem.

What are some of the factors that affect the secondary collision severity? I've listed five of them and I guess they're in order of relative importance. First and foremost, the occupant velocity relative to the impacted object. This is by far the most important factor that influences the injury severity in a secondary collision. Other things affect occupant injury risk. The age, physical condition, gender, size of the person, and weight of the person are certainly a factor. The body regions involved. If you hit your head on something, that's more severe than hitting your leg or your arm. Body support and containment, in other words, what the person is doing at the moment of the accident. Is he in the seat, is he walking, things of that nature. Another important factor is the physical characteristics of the impacted object. Is it hard, is it soft, is it going to yield, is it sharp, is it rounded.

Now the magnitude of the secondary impact velocity depends primarily on two things. First is the vehicle crash pulse. You've heard the term before. A non-technical way of thinking about it is a measurable indication of how the vehicle comes to a stop during the collision. The other important factor is the distance the occupant moves before hitting something inside the cabin. These two factors offset the magnitude of the secondary impact velocity.

Now let's take a look at the crash pulse itself in a little bit more detail. If you want a more technical definition of it, it's simply the average or other representative acceleration-time response of the vehicle cabin. Now for any vehicle--I don't care if we're talking about a rail car, locomotive, airplane, automobile, or multi-purpose vehicle--the crash pulse will vary with a number of things. Obviously the vehicle's structural design plays a very important role. The accident or collision type. You could say there's a crash pulse for every type of impact imaginable. Usually in the automotive world when you talk about a crash pulse, you're talking about a full-frontal barrier impact. The impact speed, of course, enters into the definition of the crash pulse. Also, the cab location. The crash pulse actually varies depending where you are in the cabin. In the case of an automobile, it doesn't vary very much because you have a small cabin. But inside of a passenger rail vehicle of any kind, it's going to vary a lot. And to complicate matters more in the case of a train, the crash pulse of a vehicle forming a train will vary with where that particular car is in the consist. If a car is located at the crash interface, it's going to see a lot more acceleration than if it's located farther on down the line.

To illustrate that the crash pulse does vary, I borrowed some data from the automotive safety world. This is a top view of a subcompact automobile floorpan. Five accelerometers are mounted on the floorpan. They're within a few feet of each other. There are a couple near the A-

pillars, there's a couple near the B-pillar, and one on the tunnel. They're encased in a little structural tube and mounted rigidly to the floorpan. This particular car was subjected to an FMVSS 208 nominal 30-mile-per-hour flat frontal barrier impact.

I think you should be able to see five distinct curves. Differences exist because of localized happenings along the load paths through the automobile. Let me point out a few characteristics, a few signature qualities about a crash pulse. First of all, you notice there's a wave form to it. There's a shape. This one's got a shape like an isosceles triangle. There's a duration. This duration's about a hundred milliseconds-one tenth of a second. There's a peak magnitude. You can see the peak magnitude varies between -42g's and -34g's. There's also an average acceleration. If you wanted to average this out you could, using numerical integration. The average is somewhere on the order of -20g's or so. So keep this pulse in mind when I start to address the rail vehicle crash pulse. Remember what this looks like. Remember the numbers, remember the duration.

I don't have a rail vehicle crash pulse to show you. Not many crash pulses have been recorded in this country. Until the other day I didn't realize that the British have recorded crash pulses in full-scale testing. The last rail vehicle crash tests conducted at Pueblo, Colorado were in the late '70s or early '80s. I know there was a test in Portugal where they actually crashed a passenger car up against a rigid barrier. They got pretty pictures, nice video, but no acceleration data. That was unfortunate.

We have to rely on theoretical predictions for what a rail vehicle pulse would look like. Ron Mayville talked about the locomotive crashworthiness program earlier this morning. He didn't show it on his overheads, but on page 13 of Ron's hardcopy materials, there is a crash pulse that was obtained analytically. Now all the theoretical predictions in the world can't give us the wave shape. But the work-energy expression will tell you that a rail vehicle crash pulse has a low magnitude and a very long duration compared to a motor vehicle crash pulse.

Now, why is the crash pulse so important? Why have I spent so much time talking about it? Well, because this characteristic is the source of individual vehicle velocity change. It defines the delta V or velocity change for each particular rail car. And this delta V has a significant effect on occupant motion. It affects kinematics and the number of occupant interior contacts in the cabin. It's going to affect when that contact occurs. And the kinematics and the contacts will influence the occupant's secondary impact velocity, which we said before was very, very important. This velocity then ultimately determines the level of injury sustained by the occupant. So that's why the crash pulse plays a major role in secondary collisions. Of course, injury severity increases with increasing secondary impact velocity.

Now, people inside the cabin are not securely tied down to it. People inside an automobile, for example, have their belts on, but they're really not rigidly attached to the seat in the cabin itself. There's a bit of compliance. You can lean forward and turn on the radio, push things in, open the glove box door, whatever. So they're really not tied down. As a result, the occupant's acceleration environment is sort of a modulated version of what happens to the cabin itself. There's a difference there. In other words, the occupant doesn't feel exactly what the cabin feels. This metaphorical connection between the occupant and the vehicle is going to determine what happens to the occupant during an accident. This situation applies to any vehicle. How the person is connected, how he's tied down, is going to affect what happens to him ultimately.

From the automotive safety world, both full-scale crash test experiments and accident investigation data have shown that unrestrained occupants are usually worse off than their restrained or contained counterparts. I'll distinguish between restraint and containment later on. But if you're unrestrained, you're going to have a greater chance of dying or suffering serious injuries.

There are three translational components of the crash pulse that we should be concerned about. There's the horizontal component, the component in the direction of assumed longitudinal impact. You've also got a vertical component and a lateral component. All three can play a very important role in a collision.

Here's an example from the locomotive crashworthiness study that Ron Mayville spoke about earlier this morning. We're going to look at the kinematics of an unrestrained locomotive occupant in a 30 mile-per-hour closing speed head-on collision. I modeled the locomotive cab for the one that was going 21 miles per hour; the other one was moving in the other direction at 9 miles per hour. What you see here is an admittedly crude, but effective model of a locomotive cab. You're looking at it at floor level from the right side. The right side wall and the rear wall have been removed by the graphics program so you can see what's going on in there. And over here is the left wall. Here's the front wall. There's an opening which leads to a stairwell down to the nose of the locomotive. And here's a very crude model of the engineer's seat. Since we didn't have to model the seats on the other side, I just put in a couple of pedestals.

At time $t=0$, a crew member, sensing that an impact is imminent, has assumed a so-called defensive posture. He's thrown himself on the floor. He's going to ride this one out. He doesn't have much alternative. He can jump outside or he can ride it down. The horizontal component of the crash pulse is going to affect the occupant as the collision progresses because the occupant is "connected" to the floor by means of friction. He starts to move forward under the influence of the crash pulse after time $t=0$. In this particular collision, there's a vertical component to the crash pulse as well. I took a "snapshot" of occupant motion around 80 milliseconds. Notice that the floor's dropping away. Because of the vertical crash pulse component, there's a pitching action in this particular collision. So the floor's dropped away, and the guy's still moving forward.

At 112 milliseconds he strikes the floor. He gets a jolt on his head, upper torso, lower torso, and extremities. At 176 milliseconds, because of the nature of the pulse, there's another drop off, another lowering of the floor, and he rises above it again. At 224 milliseconds, he's still moving forward. At 272 he's coming down. At 320, he has another series of shocks transmitted to his body. And at 416 milliseconds, he winds up hitting his head against this right side cab wall; a little later, his lower torso and extremities hit the left side cab wall. The whole point of this illustration is to show that had the occupant been positioned differently in the cabin or had there been a lateral component, his head would have hit either the pedestal or the seat, and he would have been a heck of a lot worse off than he was in hitting the more compliant wall.

So basically then, this example illustrates that injury risk is highly dependent on what's inside the rail car. Again, that should be pretty obvious. But just to summarize it for the sake of completeness, the cabin interior configuration has a major influence on occupant accident injury risk. Now, as a familiar comparative baseline, let's go back to the automobile. Let's take a look at the cabin of an automobile. I've chosen a multipurpose vehicle, one of those sport utility

vehicles. You recognize everything in here, right? Steering wheel, seat, dash, side doors. Here's the rear of the cabin, here's the rear seat, that's the floor. I don't know if you can make out the side panels, they're there also.

Okay, now the point of this is that with the exception of busses, motor vehicle cabins have very small volumes. People are restricted to a certain posture. You have to be sitting on a seat facing forward. And as a result, the people who design restraint systems and the surrounding cabin surfaces for crashworthiness purposes really have to address only certain types of interior impacts. They have to consider collisions between the head and the steering wheel, head with the dash, head with the side door window, chest with the dash, etcetera. They don't have to worry about the head hitting the floor. So low-probability impacts really are not important here. They just concentrate on the statistically significant collisions that can occur.

For the sake of contrast let's take a look at different cabin interiors for rail cars. Here we have a coach. You can see people reclining at different angles. And there's a little kid on his daddy's lap and people are standing in the aisles. Here we have a dining car. There are nice plush seats and a table. It's like you're in a restaurant. Really nice. And then we have a lounge car. And there's even a young lad in a wheelchair. There's a lot of room to move around. I think this is another lounge car. You notice that people are sitting in all different directions having a jolly good time and facing this way and that way.

Here's a snack car. A lot of goodies on the racks out there, some countertops and maybe a refrigerator or a microwave or something like that. Here's a family bedroom with bunkbeds. Here's a couple options you have if you travel by Amtrak. Here's a very small compartment. The bunks are pretty close to the bathroom fixtures. In a special bedroom, though, the bathroom fixtures are partitioned off from the bunkbed. A little more room in there.

We're back to the coach again. Notice the baggage rack? It's open. You don't have to worry about opening a door to put your stuff up there, you just plop it in. It's not like an airline cabin. And finally, the end of the picture session. I think this is an early rendition of the American Flyer first class car. I want to point out a couple things here. There's face-to-face seating across a table. You can discuss your business or play cards or whatever. This, I think, was billed as an entertainment center, maybe a video game or something like that.

So let's summarize vehicle cabin interior features in a listing of what we saw. All kinds of different seat designs, sidewalls, partitions, and windows. I won't read the whole list. Beds, bathroom fixtures, unsecured or poorly secured food service equipment and utensils, open baggage racks.

Occupant configurations. Are they all seated facing forward? No. They're forward facing, rearward facing, sideways facing, facing each other, and angled. They're standing, walking, reclining, lying down. Okay, what's the common denominator? I've spent a few minutes going over all this. The common denominator is summed up in that bottom sentence. All occupants are unrestrained and have extensive mobility within large-volume cabins. Contrast that situation to the automobile cabin.

So the point of all this is that in a rail car, just about any part of a person's body can strike just about anything else in the cabin. There are no limits, there's no special impact condition you can

design for. You can hit anything. And the baggage racks are open. Things stored up in the baggage rack can become missiles in an accident and hit people. If you look at NTSB accident reports, you see that people have been struck by luggage. Luggage blocks the aisles and the exits. Microwave ovens have broken loose and have been propelled through the cabins. Seats have been ripped from their moorings. So there's a lot of potential for injury in rail cars. And the very thing that makes rail travel attractive, or at least is supposed to-the freedom to move around freely-can become a liability in an accident.

Now we get into the technical part of the discussion, again, at a very simple level. Let's take a look at a coach that's undergoing a colinear frontal collision. You can see what's happening to the cabin because of the impact force. It's starting to collapse, but we're going to provide enough occupant survival space. The cabin has an instantaneous velocity, V_v . The initial velocity at the time of impact is V_v . The crash pulse, consisting of a horizontal component only, is causing the vehicle to slow down. Let's take a look at what's happening to the unrestrained occupant. Well, his connection to the cabin is very weak-the seat of his pants with the seat cushion, and the soles of his shoes with the floor. These are the only two points that are transferring the cabin crash pulse to the occupant. As a result, he continues to move forward, his velocity V_v essentially equal to V_v . It's almost like a condition of free flight. So he's not feeling the effects of the crash pulse whatsoever.

Let's look at a plot of velocity versus time. Velocity is along the vertical axis, time along the horizontal axis. The vehicle cabin velocity V_v is the solid line. The occupant velocity is the dashed line, V_v . Now you can see the vehicle is slowing down because of the effects of the crash pulse. The occupant, on the other hand, at least for this phase 1 motion, is pretty much moving along at the initial impact velocity for a time. And while I have this particular graph up here, let me show you the secondary impact velocity. The secondary impact velocity is this gap, this difference between the two curves. At any point along here, at any time, it's the difference between V_v and V_v .

Okay, now something happened at time t . You notice it looks like the velocity really took a downturn. I guess you probably know what happened. Our good friend the passenger collided with the seat back, and as a result, his velocity took a precipitous drop. This occurred over a very small time interval, Δt . Typically Δt is on the order of 10 milliseconds, maybe a little more, maybe a little less. But if you divide the occupant's large velocity change by a small Δt , you're going to come up with a very large acceleration. And it is precisely in this phase, phase 2, that secondary collision injuries occur.

Now, if we close this gap, if we can bring the dashed line closer to the solid line, we could reduce by a substantial margin secondary collision injuries. The question is, how are we going to do it? I should point out here that once the occupant strikes an interior surface, he essentially becomes part of the cabin. He rides down the collision with the cabin, therefore the crash pulse has got to be mild enough so that the accelerations transmitted to the occupant don't exceed any injury thresholds.

All right now, how are we going to pull the occupant velocity down to that of the vehicle cabin. There are two basic approaches. One way you can do it is by the use of restraints. Restraints are nothing more than devices of some kind that try to prevent the occupant from colliding with the interior. They prevent you from lurching forward and from coming out of your seat. As an aside

here, a few years ago I probably would have been a bit trepidatious to use the word "restraints" in a gathering like this. But over the last few years, there's been a change. The term has actually appeared in mainstream technical articles dealing with rail vehicle crashworthiness.

There are two types of restraints. The first are called active systems. Their deployment requires some action on the part of the occupant to put them in place. You buckle your seat belt. You put a child in a child seat and buckle the belt. The other kind are passive systems. Their deployment doesn't require the occupant to do anything. Automatic safety belts, the kind that deploy around you as soon as you sit down, are another example. Those work if you don't disable them by cutting or disconnecting the wires. So are air bags. By the late 1990's all cars will be required to have both passenger side and driver side frontal air bags.

The other approach is called compartmentalization. It involves occupant containment; I'll get to that in a little while. But let me point out that there are other straightforward measures that can be taken to improve occupant survivability. Number one, close the baggage bins. Airlines do it. Simply close them. You also want better fixture retention. Keep seats from tearing loose. It's achievable in a high-g motor vehicle acceleration crash environment. It can also be done in trains, where the crash pulse is characteristically low.

All right, now let's go on to occupant containment. Occupant containment is concerned with preventing people from being tossed around in the cabin during a crash. You want to prevent occupant impact with the interior but do it in a passive way, without using a restraint system, per se. It's okay if you move a little bit and hit the interior surface, but you want to restrict this mobility so you don't travel too far before impact. You could go tumbling down the entire length of a railcar aisle and hit something. Instead, it would be better to restrict this motion to some reasonable length. As an extreme example, Harvey Boyd mentioned crash refuges, where crewmembers in a locomotive cab would throw themselves on the floor and be in contact with one of its surfaces. In this case, there would be no motion and no secondary impact velocity. The occupant would ride down the collision during the phase 3 portion of that velocity- time plot I showed you.

This transparency shows an expanded, more technical definition of compartmentalization. Again, you want to restrict the range of unrestrained occupant motion by partitioning the cabin into smaller zones. And you want to implement other passive motion-arresting techniques. That's a toughie. We need some more research on that. In the case of a dining car, maybe you could thicken the tabletop to prevent people from pitching over it. Not only does compartmentalization involve restricting occupant motion, but you also want these surfaces that the occupant eventually will come in contact with to be "friendly." That's a term that comes out of the motor vehicle safety community. Friendly contact surfaces.

They should be flexible so they yield and in the process eat up kinetic energy. Surfaces should be force limited. That way, we keep the accelerations and forces that are transmitted to the occupant below certain thresholds that the body can withstand. It's better to have the surface yield than to have the human body deform. The human body doesn't take too kindly to forces or accelerations at very high levels. And finally, friendly contact surfaces should be smoothly contoured to eliminate small-radius edges. The idea here is to distribute the impact force over a large area, thereby decreasing the applied pressure. That will help decrease injury risk.

So, in closing, let me say that yes, passenger train accident frequency is a lot lower than the carnage that goes on daily on our highways. The crash pulse for rail vehicles is considerably milder than those that are experienced in motor vehicle collisions. But there's no reason why the rail vehicle secondary impact problem should be ignored. It's a significant problem. We need to do some fundamental research. We can do better. Thank you very much.

DAVE TYRELL: I disagree with that previous statistical work. That is, the train collision model that we looked at, about 80% of fatalities are due to crushing of the occupant volume. About 20% are due to secondary collisions.

ROBERT GALGANSKI: Okay, I'm going to have to look to find that source or sources because I made a misleading statement. I should have said that most injuries in train accidents arise from secondary collisions. Drop the words "serious" and "fatalities" from the last line on my fourth transparency.

DAVE TYRELL: Well if you have a specific reference in the packet both Ron and I would be extremely interested to see it. I can certainly give you the specific reference and numbers.

ALAN BING: Just a couple of other little points. You elaborated at some length on the spacious nature of the interior of trains and there are other classes of trains such as commuter trains. There are people standing at the density of six per square meter, for example. Then you address, perhaps, a completely different set of problems. And I think your point got made yesterday. The models of dummies, the finite-element models of dummies are, they give a nice picture. They give some indications of what might happen, but they're not real people. Real people take evasive action, they change their posture, they do all sorts of things. So don't believe those pretty pictures.

ROBERT GALGANSKI: Oh no, definitely not. Modeling can serve as a means for qualitative comparison. In other words, you can look at different situations, but in no way should a model give any absolute answers. I agree with you totally on that one.

STEVE SOLTIS: Steve Soltis from the FAA. I think as everybody knows, the aviation community has a crash position defined, usually on the passenger seat. Can you show the prone position of laying on the floor perhaps as a maybe suggested or maybe not suggested crash position. I just have one minor comment on that. I noticed that he was lying down head first. I think my first line of defense would be feet first and not head first.

ROBERT GALGANSKI: First of all, let me say selection of a "typical" defensive posture was extremely nebulous. Maybe by default or however it happened, the prone, face-down position was selected as one of them. And the person was not facing head first. He was perpendicular to the longitudinal center line over here. In other words, he was, if this is the front of the cab, he was lying down like this. He wasn't head first. Again, the purpose of this study was just to show what can happen to an unrestrained person in the cab. He can hit a lot of things and he can get hurt. The timing and the pulse have a lot to do with it. As far as what position a person's going to take in case a collision is imminent, it's going to vary with the individual. He may actually try to get out of there. I don't know what else to say about that.

TOM PEACOCK: Thank you very much Robert. I'd like to introduce Michael Kleinberger.

PRESENTATION

INTERIOR COLLISION ENVIRONMENT

CALSPAN SRL CORPORATION

**Presentation for
the Symposium
of Rail Vehicle
Crashworthiness**

June 26, 1996, Cambridge, MA

*Calspan
Operations*

CALSPAN SRL CORPORATION

**Interior Collision
Environment**

Robert A. Galganski
Senior Engineer
Transportation Sciences Center

*Calspan
Operations*

Interior Collision Environment Premise

Hypothetical Train Accident Scenario

Assume that the cabin provides a protective envelope around the vehicle occupants:

- Cabin exterior provides adequate survival space
occupants are not crushed by intruding surfaces
- Cabin superstructure (skin and glazing) is not
penetrated - no relatively narrow objects or
structure that can impale or otherwise injure the
occupants enter the cabin
- The accident does not result in occupant exposure
to hazards such as fire, toxic gas, or water

Occupant injuries are caused by secondary collisions

Secondary Collisions

Occupant impacts with cabin interior:

- Surfaces
- Fixtures
- Other occupants

Secondary collisions are the leading cause of serious injuries and fatalities in train accidents

Secondary Collision Severity

Parameters that influence injury risk:

- Occupant velocity relative to impacted object (secondary impact velocity)
- Occupant features: age, physical condition, size, weight, etc.
- Body region(s) involved
- Body support and containment
- Physical characteristics of impacted object

Secondary Impact Velocity

The magnitude of this parameter is a function of:

- Vehicle crash pulse - a measurable indication of how the vehicle comes to a stop during an accident
- Distance the occupant moves before impact with something inside the cabin

Crash Pulse

- Definition: the average or other representative acceleration-time response of the vehicle cabin
- For any vehicle, the crash pulse varies with:
 - Vehicle structural design
 - Accident/collision type
 - Impact speed
 - Cabin location
- The crash pulse of a vehicle forming a train varies with vehicle position in the consist

Vehicle Accelerometer Locations: Cabin Area of Subcompact Automobile.

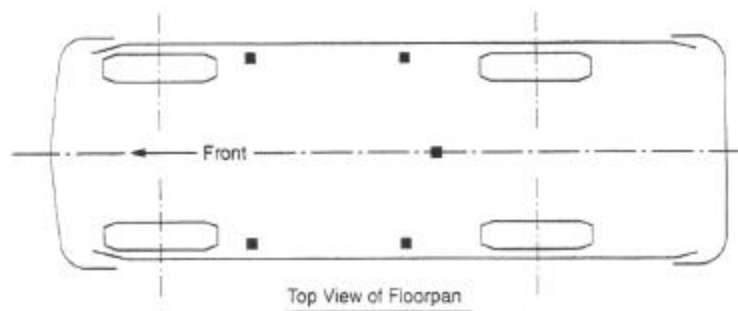

Impact-Direction Acceleration-Time Responses at Five Different Subcompact Automobile Floorpan Locations: 30.5 mph (49.1 kph) Flat Frontal Barrier Impact.

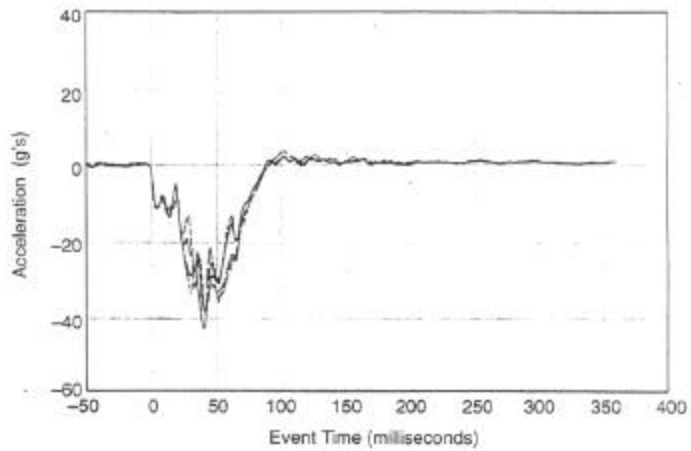

Rail Vehicle Crash Pulses

Theoretical Predictions

- Unknown wave shape
- Low magnitude
- Very long duration

Crash Pulse Dynamics

- Source of individual vehicle velocity change (ΔV), which
 - has a significant affect on occupant motion (kinematics) and the number and timing of cabin interior contacts, which
 - influences the occupant secondary impact velocity ($V_{o/v}$), which
 - ultimately determines the level of injury sustained by the occupant

Note: Injury severity increases with increasing $V_{o/v}$

The Vehicle/Occupant "Connection"

- The occupant's acceleration environment is a modulated version of the vehicle crash pulse
- The metaphorical connection between the occupant and the vehicle determines what happens to the occupant during any vehicle accident
- Unrestrained occupants are usually worse off than their restrained (or contained) counterparts -- they have a greater chance of dying or suffering high-severity injuries in a given accident scenario

Kinematics of an Unrestrained Locomotive Occupant in a Prone, Face-Down "Defensive" Posture: 30 mph Closing Speed Head-On Collision

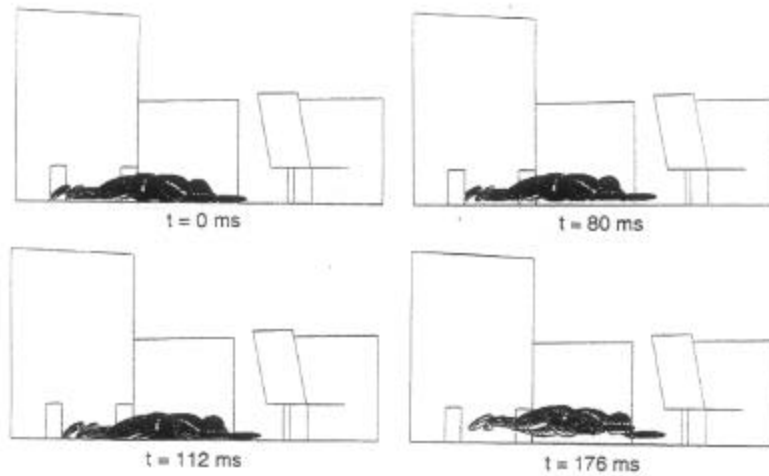

Kinematics of an Unrestrained Locomotive Occupant in a Prone, Face-Down "Defensive" Posture: 30 mph Closing Speed Head-On Collision (cont.)

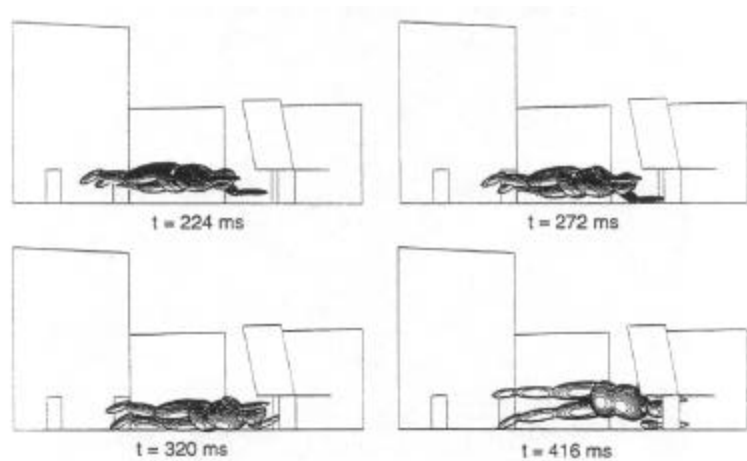

Vehicle Interior Layout Characteristics

The cabin interior configuration has a major influence on occupant accident injury risk

Multipurpose Vehicle Front of Cabin

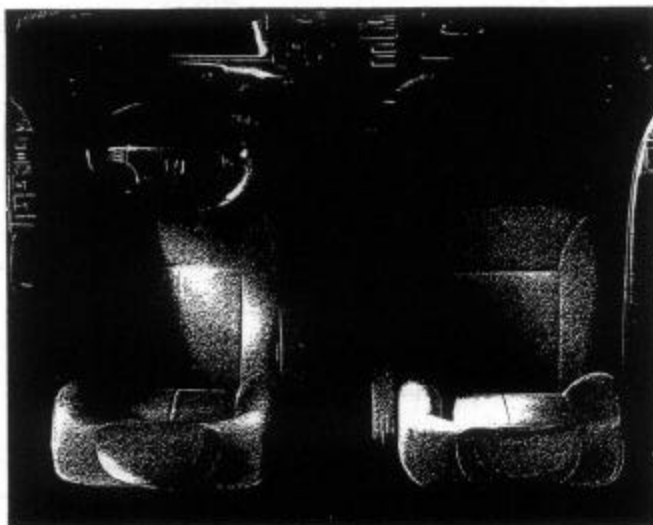

Multipurpose Vehicle: Rear of Cabin

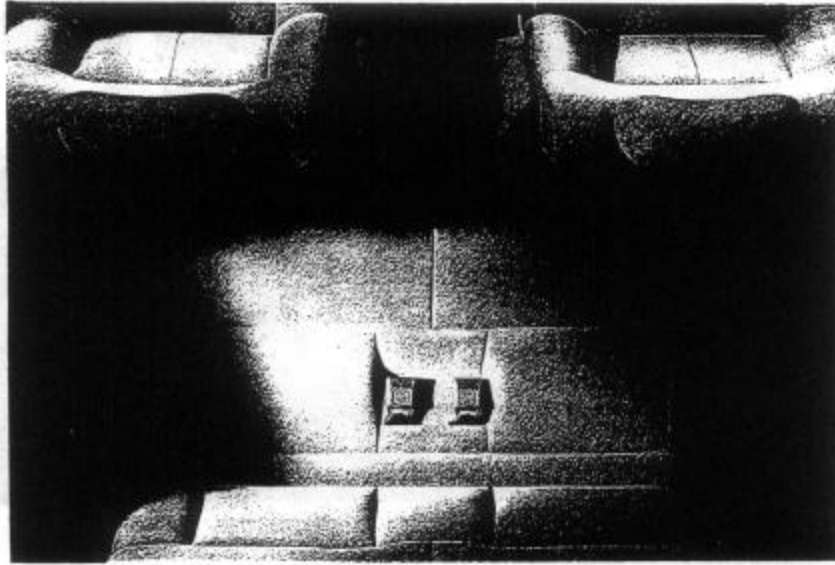

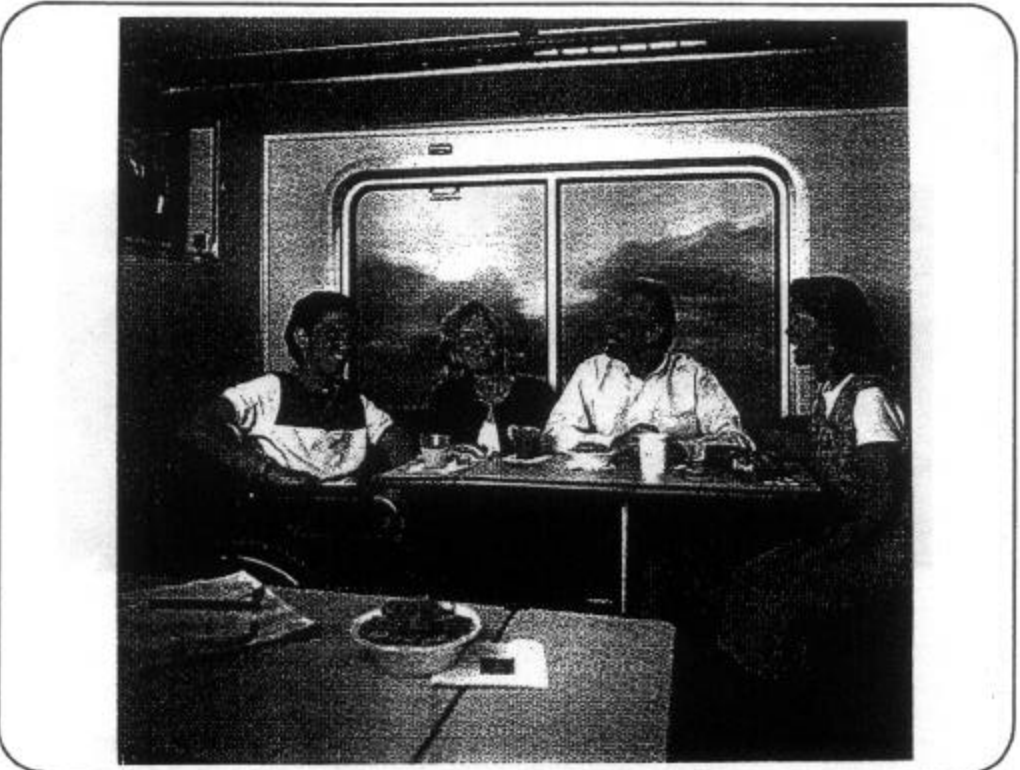

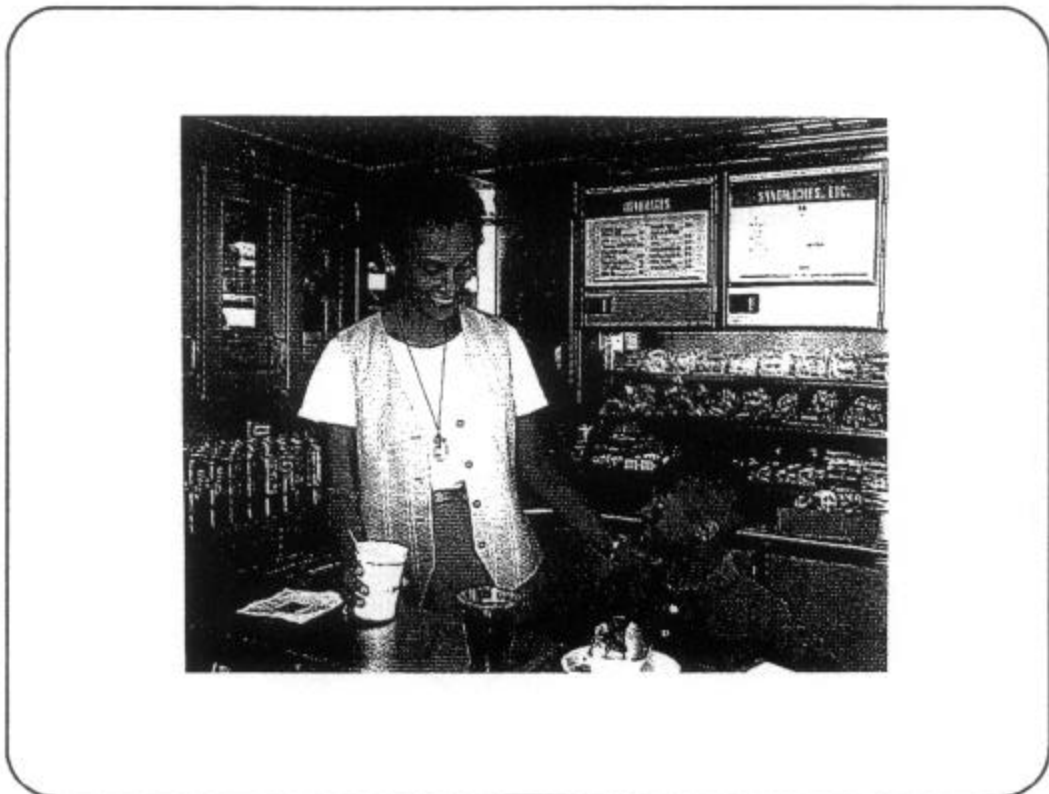
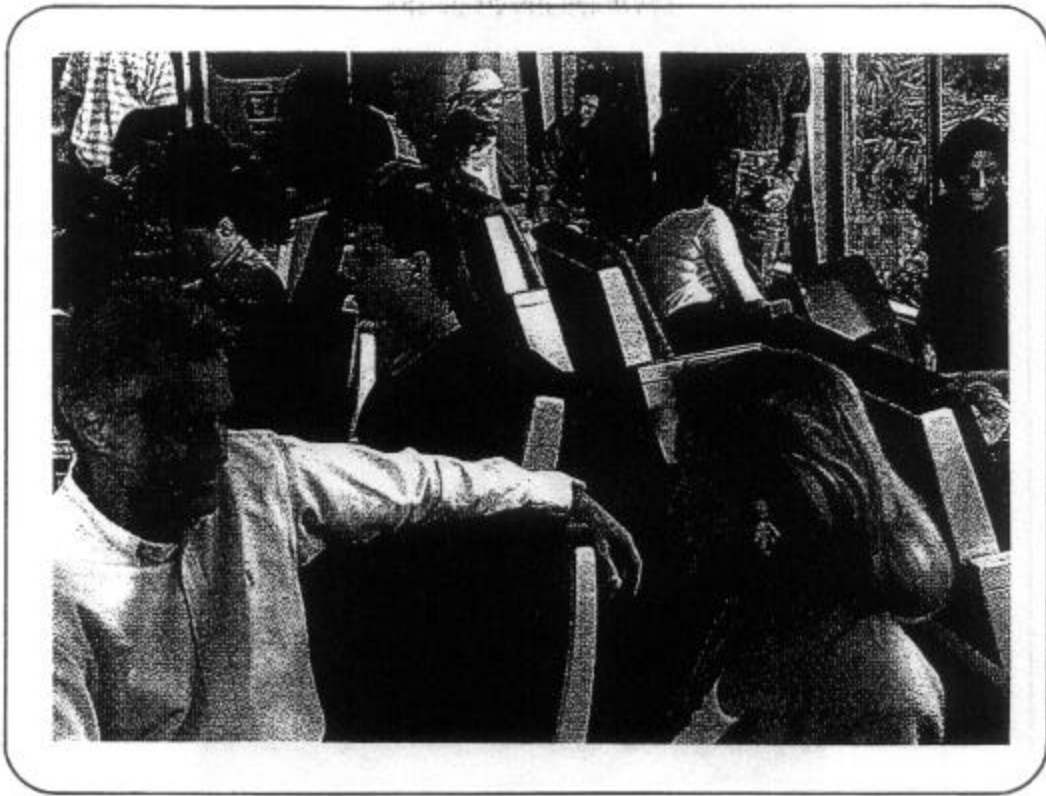

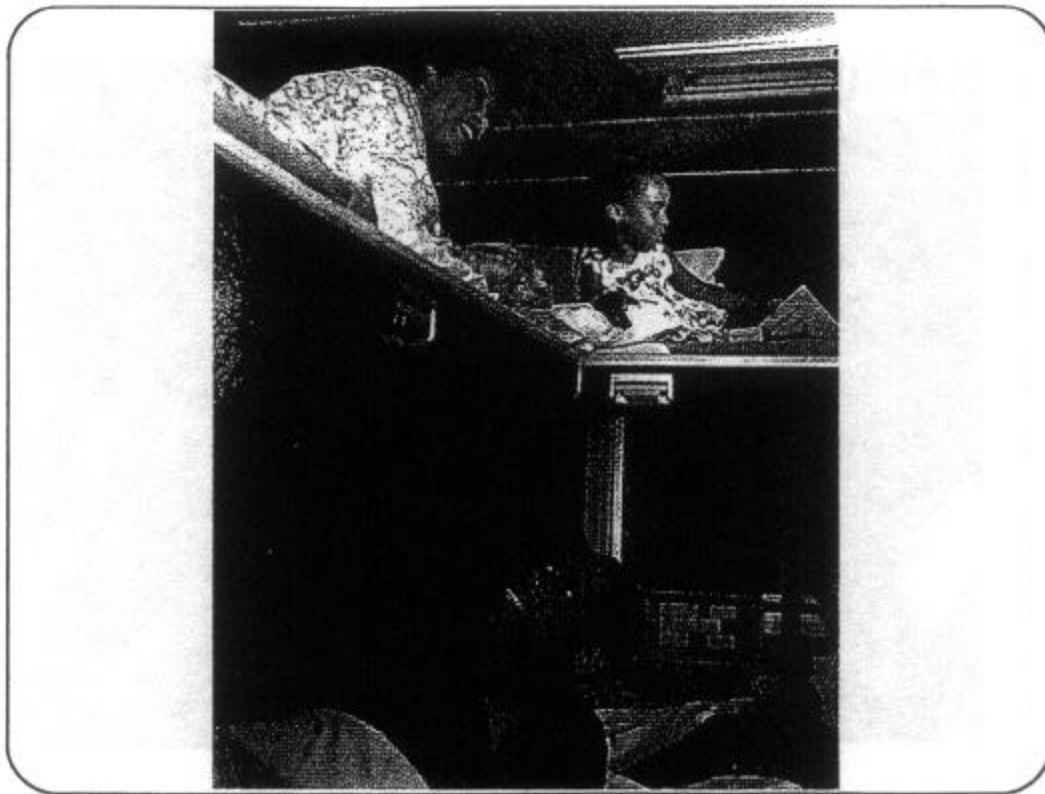

Viewliner Compartment



Viewliner Special Bedroom

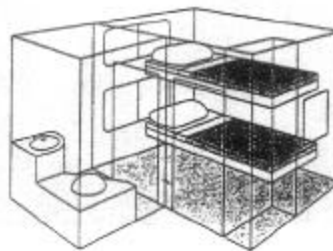

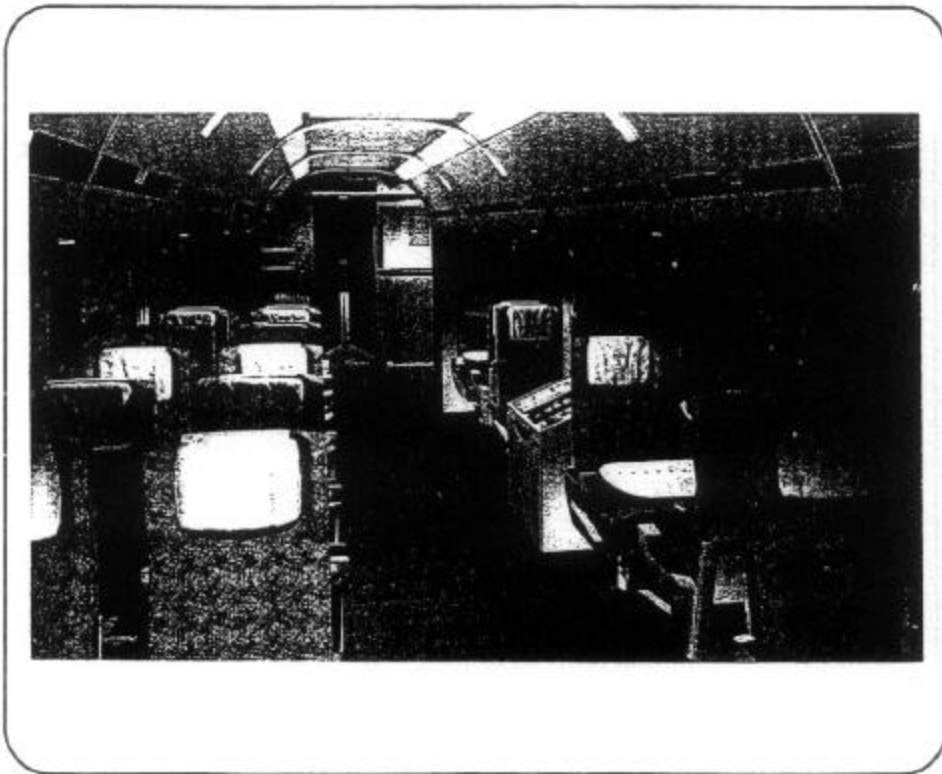

Rail Vehicle Cabin Interior Systems

- Seats
- Sidewalls/partitions/windows
- Floor/ceiling
- Tables/counters
- Dispensing machines
- Audio/video entertainment equipment
- Bunk beds
- Ceiling and lighting fixtures
- Bathroom fixtures
- Unsecured food service equipment and utensils
- Open baggage racks

Rail Vehicle Occupant Configurations

- Seated
 - Forward facing
 - Rearward facing
 - Side facing
- Standing/walking
- Reclining/lying down

Note that all occupants are unrestrained and have extensive mobility within large-volume cabins

Unrestrained Occupant Dynamics in a Vehicle Cabin: Hypothetical Frontal Collision

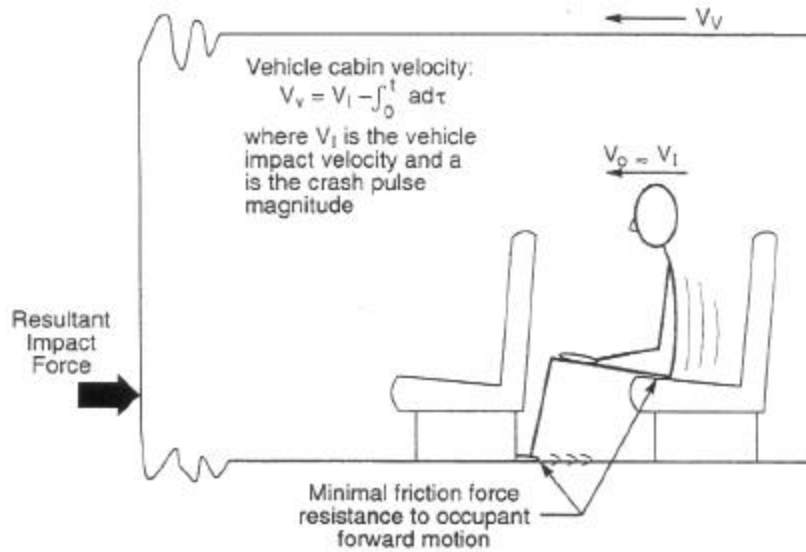

Hypothetical Vehicle and Unrestrained Occupant Velocity Profiles: Frontal Collision Mode

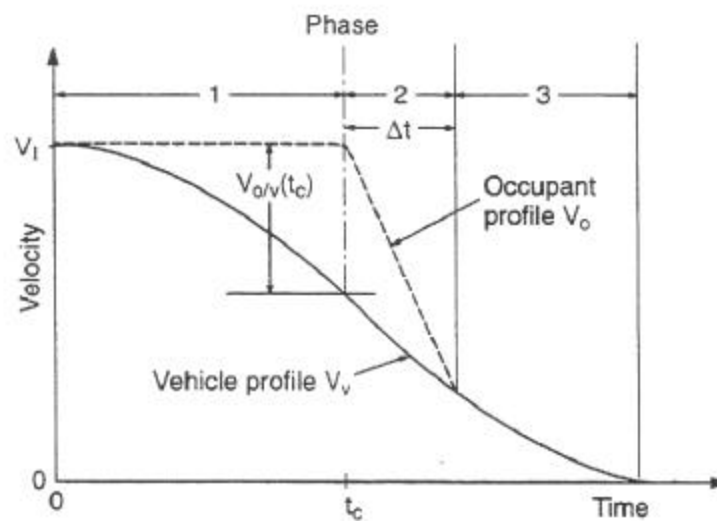

Reduction of Secondary Collision Injury Risk

Approaches

- Active Systems: deployment requires some action by the occupant
 - Safety belts
 - Child seats
- Passive Systems: deployment independent of occupant action
 - Safety Belts (if not circumvented)
 - Airbags
 - Compartmentalization
- Other straightforward measures can be taken to improve occupant survivability:
 - Enclosed baggage bins
 - Better fixture and equipment retention

Compartmentalization

- Restrict range of unrestrained occupant motion by:
 - Partitioning the cabin into smaller zones
 - Implementing other passive, motion-arresting techniques
- Provide "friendly" contact surfaces
 - Cushioned and collapsible to absorb substantial occupant kinetic energy
 - Force-limited to keep forces, accelerations, and displacements sustained by the occupant below maximum allowable body region tolerance levels
 - Smoothly contoured to eliminate small-radius edges, allowing impact forces to be distributed over a large area of the body

Testing and Analysis of Occupant Vehicle Collisions

MICHAEL KLEINBERGER: I'd like to take the occasion to thank Dave Tyrell for inviting me here. It was a very interesting meeting. I always like coming to meetings where I'm exposed to problems and technology of environments other than the automotive that I'm working in, so I have really enjoyed these last few days.

Let me just start out before I get into all my slides that the charter of the National Highway Traffic Safety Administration is to reduce the number of serious injuries and fatalities that occur on the highways in motor vehicles. As you work your way down in the organization in NHTSA, go down through Research and Development to Office of Crashworthiness and then Biomechanics Research Group, and what we look at in our group is the occupants in that vehicle. And we look very closely at the different parts of that occupant, different body regions. We try to characterize how they respond to some kind of insult and we have spent many years developing tools, analytical tools and experimental tools for determining how the body responds to these insults. And I think it's important as I go through my slides to keep in mind that what I'm going to say doesn't apply just to the automotive environment. It applies to any general situation where you have loads and accelerations being applied to the human body. This is more specifically a discussion of the human body mechanics and not just within the automotive environment.

Now as with a lot of the other talks we've heard, how do we go about collecting our data? Well we crash a lot of cars for one. We crash them from the front, we crash them on the side, we roll them over and we crash them in other configurations. All of these tests are very well-instrumented so we know exactly what the vehicles were doing, we know the accelerations, we know all the deformations. Basically, we know what is happening to these vehicles and also to the occupants inside these vehicles.

Now it's very difficult to get people to volunteer to sit in these cars while we crash them, so we have surrogates that we use. This is the Hybrid III family of dummies. They come in all different sizes from 6-year-old up to a 95th percentile male. There are also some new dummies out that go down to infant size, 12-month-old dummies, 6-month-old dummies. So we have a very wide variety of sizes that we deal with. Nice thing about surrogates is they don't mind sitting in situations that most people would not be willing to volunteer. So here's a 30-mile-per-hour frontal crash and they are not wearing their seat belts and what happened in that situation is definitely not very pretty.

Now we understand very clearly that the dummies that we use are not exact replicas of the human body. Again, we can't get volunteers to sit in these cars during these crashes so the next best step that we do is we use cadavers. In our group, almost all of our tests that we do are on cadavers. Either full body cadavers or parts of cadavers. This is just picture of a full body cadaver. We do sled tests typically. We get the crash pulses from real full vehicle crashes, and we can do the same thing in the lab in repeatable fashion. We also use some cadaveric component tests and this is just an example of one of the test setups that we had. This is being done at the Medical College of Wisconsin where we were looking at the response of the neck to various and virtual loading. Again, the inertia pulse that is applied to this test grade is generated from experimental data for full vehicle crashes.

If you're trying to follow along on the handout, good luck because last night I changed the entire order, so I'm not even sure what's coming next. And the last area where we get data from, which we do not want to forget about because it's very important data, is in the real world. People out there are every day they're volunteering, they're providing us with data and we like to use the data as much as possible. We have a very extensive accident data registry or database where we collect many thousands of cases of every year. We look at the injuries, what part of the body is injured, what is the seriousness of the injury. Basically measuring all of the body damage to the vehicle as we try to get all of the pre-collision kinematics and very important to determining what areas we should be working on, as far as where can we get the most benefit for our dollars. The statistics are very good at telling us, for example, that roughly half, don't quote me on these numbers, roughly half of the crashes in the real world are frontal crashes, about a quarter of them are lateral, side impacts, and the other quarter are either rear impacts or rollovers. Rollover accidents are a fairly low percentage of the total number of crashes that we see but they typically involve a much higher energy, so we see an unusually high percentage of fatalities associated with rollovers because it takes a little bit of speed to flip a car over.

I wanted to talk quickly about the trauma assessment scales. How do we characterize the severity of injury. One that is very often used is AIS, the Abbreviated Injury Scale. What it does is it looks at various body regions, it breaks the body up into head, spine, thorax, upper and lower extremities, etcetera. And for each of those body regions, it looks at the type of tissue you're dealing with. Is it bony, skeletal tissue, is it blood vessel, is it skin, is it some internal organ. The nature of the injury, is it laceration, is it burns, etcetera. And then finally, the severity of the injury, and by severity we're basically scoring on a scale of 1-6 the likelihood of fatality from that injury with one being a very minor injury, very little risk of fatality, and six basically by definition meaning that it would be fatal.

There are some examples here. If we look at head impact, you get a subdural hematoma, it would be AIS-4. That would have to be a certain likelihood of fatality. On the other side if you go to the bottom of this, you can see if you have general skin abrasion, that is AIS-1, most people don't die from just a scrape. Now AIS does not provide everything. We are starting to get away from just looking at risk of fatality. We're trying to look at the long-term disabilities associated with these injuries. As an example, if you were to characterize a whiplash injury from a rear impact, it would be an AIS-1. I don't know of anyone who has ever died of a whiplash injury, but people are very afraid of long-term disability. For the insurance companies, there's a tremendous cost associated with these injuries. Estimates in excess of \$8 billion a year are paid out, lost in job insurance claims, or lost work due to a basically AIS-1 injury.

AIS typically is looked at as the maximum AIS. You look at all the body regions and you pick the highest number and that is very often called the seriousness of that particular case. But what we see from statistics is that if you consider more than just the maximum AIS level, then you get a much different look at the fatality risk. This plot shows that if you consider not just the first highest AIS level, but the second, this line here represents the maximum AIS number of 5. So there's at least one AIS-5 injury. If there's no other injury, AIS-5 plus the next highest AIS number is 0, then you have a 30% risk of fatality. However, if you have an AIS-5 and you also have an AIS-2, the risk of fatality goes up to 40%. If you happen to have two AIS-5 injuries, the risk of fatality goes up to 80%. So obviously just looking at maximum AIS doesn't tell you the whole story.

As a first approximation to improve the situation there is another score developed called the Injury Severity Score or ISS. It's basically a root-mean-square summation of the top three AIS readings. So in this situation we have an AIS-4 head injury, an AIS-3 chest injury, another AIS-3 lower extremity injury, it gives you another, just another, it kind of takes into account the fact that there are multiple injuries.

Now if you talk to the doctors, the physicians and you ask how they categorize injuries, they do not look at the specific physical injury of the body. They don't care whether there is a fractured skull, whether there is a lacerated blood vessel. They don't look at that. They look at merely its functional assessment of the patient. They use something called the Glasgow Coma Scale and it basically scores three different functional abilities: basically, eye responses, motor responses and the ability to respond to verbal commands. They score each one of these basically from 1-5 so the total is 3-15. A low score in this scoring scale, you want high numbers, so if you have Glasgow Coma Scale 3-4, you have very high risk of fatality in the first 24 hours. If you have a higher number, that means that you are responding very well to the doctor's commands and you have a basically 90-95% chance for surviving the situation. We are trying to develop a similar index called the Functional Capacity Index which, again, it looks at various functional abilities of the person and categorizes everything on a scale of 0-1 as far as what the importance of these different abilities are. For example, being able to hear, being able to see, being able to keep feed yourself, being able to go to the bathroom, being able to think. A lot of these things. A bunch of experts got together and decided what rate each one of these should have and what we typically use this for, and this is still in development. The aim is to try to make an estimate for a particular set of injuries, what the cost to society is. What is the life expectancy which is lost due to these injuries. I don't want to dwell on this too much.

Looking at injury criteria, we regulate the automotive industry. We do not give them design specifications. We cannot tell them how to design their cars. We give them functional specifications. We tell them what the response of the vehicle must be and we leave it up to their designers who have much more expertise than we do on that topic. They design the cars as they see fit. Current injury criteria, we look at basically accelerations of the head, strictly translational accelerations of the head which are concocted into something we refer to as HIC, you're probably all aware of, we'll talk more about that later. As far as the neck goes, there are currently no injury criteria for the neck. In the thorax or the chest, we look at the spinal acceleration and the deflection or the compression of the chest cavity. The abdomen, like the neck, there is currently no new criteria available. These are injury criteria that are actually in the regulations. It's not that we don't have some thoughts about it but they're not in the regulations. The lower extremities, the only thing we are currently regulating is the femur compression.

These are just the numbers that we're using. HIC, it's basically 1,000. We require HIC to be less than 1,000. Again, if you're unfamiliar with what HIC is, it's just an integration of the translational accelerations over time in some time window. Head g's are required to stay below 80g's for interior impact, the upper interior of the car and dashboard. Chest g's should be kept under 60g's. Chest deflection should be less than three inches, and the femur load, I believe that number is wrong, this is not my slide, it should be 2250 pounds.

Now those are the current criteria that are in the regulations than what the auto industry is trying to follow. We, however, in our research group, we have very much separated the regulatory body from the R&D body. R&D supports the regulatory body, but we are nicely given some luxury to

look at some other ideas that we'd like to think about for the future. We see a lot of problems with HIC. Again, I'll talk about that a little bit later but HIC is very insensitive to rotational accelerations, so we have something a little better in mind. What we'd like to do, we're going to use finite-element technology and rather than looking at the translational acceleration of the head, we want to look at actually the strain that develops within the brain because head injuries are a function of brain injury, not skull fracture. If you could fracture your skull without injuring the brain, then that would really be of no consequence. But in the neck you want to look at accident compression of the neck. That's one of your more serious neck injuries. As far as some of the more minor neck injuries, ligament strain and that again would probably be approached using analytical techniques like finite-element modeling.

In the thorax, we're still going to look at spinal acceleration. We also want to look at basically the contours or the displacement of the entire chest wall as dynamically as it goes through a crash. I'll talk about all these a little bit later. In the abdomen, we're going to have a new dummy that we just released in the last couple of months and we have new instrumentations to measure abdominal pressure. And in the lower extremity, we have always been measuring femur compression and we have a pretty good handle on femur compression. That's a fairly straightforward measurement. It's a fairly straightforward mechanism, but we also want to look at what goes on in the ankle. Current dummy technology does not really make a lot of measurements in the ankle, and we're seeing a lot of injuries coming up.

I'll mention at this time that looking at injuries that occur in the automotive environment is that there's a changing problem because problems that were important 20 years ago in the automotive environment are no longer important now, where there are new problems arising. We have historically been very interested in trying to reduce head and chest injuries. That's where most of the fatalities were coming from. As you all know now with airbags in most every car out there, airbags are doing a wonderful job despite what you've probably heard in the press. Airbags are doing a wonderful job of saving people. They're significantly reducing the number of head and chest injuries and certainly the number of fatalities associated with those, but what we see is that people are being able to survive fairly serious crashes. And what we're seeing now is that there are a great number of lower extremity injuries that are coming out of these crashes. Now in the past, those are typically fatalities. Nobody every carried a corpse out of the body and checked to see if his ankle was broken. It really was not important. And now that these people are surviving, they've got terrible ankle injuries, typically AIS-2, they're not really high risks of fatality, but these people will basically be limping for the rest of their life and may never be able to work depending what their job is. So these are very important societal cost questions. And so again, the problems change as technology improves.

Now what we want to do is kind of go through the body. For no real reason I'll start at the top and work my way down and talk about a lot of the research that we're doing to understand how these bodies react and how we're relating measured parameters with the injuries that are being seen in that environment. Again, keep in mind while I go through this that these tools, these are just engineering tools, biomechanical tools that can be applied really to any situation whether it's aircraft or whether it's trains or whatever environment you want to put the body in. And it's the same body, whether it's driving the car or whether it's flying the plane, driving the train, it's the same people. So keep that in mind. Also, I'll do my PR bit right now and mention that the Secretary of Transportation has just approved us to expand the scope of our work in our Biomechanics Research Group and we're now allowed, or we're encouraged, to seek out

collaborations with others outside of the automotive community to do some collaborative research to try to understand how the body can be protected in other environments as in aircraft and trains and so on. So I've done my PR bit, I'll go on with the rest of these slides.

Okay, starting with the head. We have several different models of the head. This is one that's been around for awhile. Fairly simple model. This was developed by Frank DiMasi at the Volpe Center for us. It has a representation of the skull, again a fairly simple representation, it includes some of the major partitions that are within the skull cavity and for most of you that have never seen the inside of a skull so take my word for it, that is at least truly represented here. And this is the brain which fits inside of there and then you have the partition that separates the two hemispheres of the brain. We can do simulations with this model, we can look at our results one of two ways. We can look at kinematic output, look at the accelerations that the head sees, or we can actually look at the stresses or strains that are taking place within the brain. Again, we want to look at head injury. We are mostly interested in the strains within the brain, not necessarily the accelerations of the skull.

Now during an event, if you look at a picture like this, this shows the strains that are occurring in the brain for one particular point in time. Now, we have done some related tests that showed that at strain levels, tissues in the brain cease to function. Now let's just say for the sake of argument it's 10%. So let's say the red here is 10% strain, so this portion of the brain at this point in time has ceased to function. But at another point in time, there may be some other portion of the brain that reached 10%. What we'd like to be able to do is go over the entire event, we'd like to kind of map out which sections of the brain at any time during the event see that 10% level of strain. That's basically what this is. This is called the cumulative strain damage. Basically it's just finite-element post processing where we keep track of the maximum strain that each element in the mesh has seen during the entire event. And this is really what we use. We use this kind of output to compare it with autopsy data. We will run the cadaver test to be able to measure the acceleration profile, we can simulate that profile, then we can ask you to do an autopsy to determine whether the injuries occurred in the brain. And we can relate that to what the final element model predicted.

It's kind of hard to see over here but each of these lines is a different level of stress. This is basically the fraction of the brain, the percentage of the brain that saw a certain level of strain. It was a very small strain, let's say 1%, basically during the entire event, the entire brain has seen at least 1% strain. If you move up to a higher level, let's say 5%, then roughly half of the brain has seen 5% strain in some form during the event and as you increase your level of strain then obviously the less percentage of the entire volume of the brain has seen that stress. So that's basically what we're tracking here.

For each of these body regions, we are working three different areas in research. We do analytical modeling and that helps us to understand mechanisms of injury. To support the model development, we do a lot of cadaver experimentation and the cadaver work helps us, first of all, to develop the meshes of the models, to validate the models and give us the tolerances, the tolerance levels that we need to predict when the injuries occur. And after you've found the injury levels and you know roughly which parameters affect the potential for injury, then you could be able to get that into a useful engineering tool for the designers. We can't go to the car manufacturers and tell them to design their cars so that the strain on the brain is going to be less than 5%. That's not an engineering design tool. We need to be able to give them some kind of

tool that allows them to test their product. So what we have to do is get all the information that we've developed in our modeling and experiment with cadaver work and put that into a test device. Basically, our dummies, we are constantly improving the design of the dummies. In the last month or two which I'll talk about that later, which shows a great improvement in all the body regions.

This head model, again, is fairly simple but we use it really for qualitative analyses. It's not completely validated, but we use it to look qualitatively. What happens if we have an impact between the head and the A-pillar, the A-pillar is the structural member between the windshield and the side window. If the A-pillar is unpadding, which is the top case here, we have a certain situation. We call that the baseline case. If you put padding on that A-pillar, what happens to the accelerations or the strains that we see in the head? Again, this is just a qualitative assessment going to the baseline case, simulation means basically going from baseline to padding, it will cut the peak acceleration roughly in half. And again, the calculated HIC value will be cut roughly in half.

We did an experiment of the same thing using the modified Hybrid III head and launching it into an A-pillar with and without padding and we see very, very good comparisons. There was a greater drop in the head but very good comparisons. Qualitatively this tells us that just considering head injuries alone, that putting padding on the structures is probably a good idea.

I mentioned before that HIC is very sensitive to rotational accelerations. Unfortunately, strain in the brain and therefore brain injury is very sensitive to rotation injuries. So what we did is we took another simulation where we had a HIC of 854 which is a particular crash that we have done experimentally in the simulated kinematics of that impact and we ran it with the rotation and the translation of the model. We got the HIC of 854 and then we calculated this cumulative strain damage and we found that 52% of the volume in the brain reached the strain of 7%.

Now, to look at the problems with HIC, we decided to look at rotation only. The same test basically, but we didn't do the translation, we only did the rotation. So because there's no translation, HIC is zero because HIC is a function of translational acceleration. So HIC is zero. So this would predict no injury whatsoever. But if you look at just the rotation, we still get a cumulative strain damage of 32% of the volume. So you still get a fair amount of the brain strain just from the rotation of that, not the translation. You go the other way and turn off the rotation and look at only translation, what we get are HIC of 854 because that's the way HIC is calculated from the translation. But if you look at the strain that's developed in the brain, it's only 1.5%. So again, HIC does not take this into account. That's why we are, at least in the long term, we don't see HICs surviving very longer in the future. Again, that's the perspective of the research end of our agency, not from a regulatory body.

So with new technology, what we're looking at is trying to develop improved models. Again this is a fairly simple model. We're looking at improved models that can come straight from CT or MRI data. This is just a particular case where we did a CT or MRI on a particular subject and then we're able to generate a finite-element model directly from that data. You can get much more detail anatomical definitions from that data.

We move down to the neck and again, we have three areas that we cover. So we do our analytical modeling and again it basically includes all of these significant biomechanically

significant entities in the body region, it has all the vertebrae, all the disks and ligaments. There are associated experimental categoric studies that we do. We do two different sets of experimental studies. One is a compressive study which we do at Duke University where we're basically dropping heads and necks from cadavers onto force plates which allow instrumentation associated with high speed video and we can look at the response of the neck and head through primarily compressive loads looking at vertebral fractures and serious injuries. We can compare the finite-element predictions with the experimental data. Again, this is an inertia loading. This would be a case where you've got a restrained occupant and the head is not hitting any structures but the head, just through the inertia, the head is loaded the neck. And finally your rear-impact whiplash situation, on the side.

There is some volunteer data done by the Naval Biodynamics Lab. Whenever we can get our hands on any volunteer data, we try to use as much as possible because the cadaver data that we generate we understand is not a living human being. It's as close as we can get, but we know that there are differences between a living subject and a deceased subject. So this is basically a simulation of some volunteer tests that were done by the Navy, and what it shows, basically, is a frontal impact at over the first 40 milliseconds basically the neck rotates but the head stays horizontal and just translates forward. At some point in time, about 70 milliseconds, the base of the skull contacts the top of the neck so it's basically bone-to-bone contact there and it begins to rotate down together and that looks like a plot of the angle of the neck versus time. The yellow is the corridors that were generated by the Navy volunteers and the model gets in fairly well into those corridors.

Moving down again, we get to the chest. I will state right in front that I do not like statistics. It's a personal thing. I'm allergic to statistics, I don't like statistics. The data comes from someone else I will try my best to interpret this as much as possible. Basically we're looking at trying to relate varied and measured parameters with the probability of a serious chest injury. And we're looking at seat belt restraints and airbag restraints. And what you'd like to see in this kind of plot is that at some acceleration of the chest, we're plotting versus the acceleration of the chest, if I can say that at some point along this axis you have an acceleration level where everything to the left would be non-injury, everything to the right would be injuries, so what you'd like to see is a curve with a very steep rise somewhere along the plot. This basically is supposed to show that there is not a very good correlation between chest acceleration and the probability of injury. What we have done is we want to look at this problem a lot. We've been working on this one for a long time.

We have developed a piece of instrumentation which we'll call the chest band. It has a much longer name, but we just call it the chest band. It's basically a thin strip of metal that you wrap around the chest. It has a strain gauge that grades every inch. What you can do is dynamically, you can measure the change in curvature all the way around the body and then you can superimpose it on one another where you can develop basically cross-sectional maps of the chest dynamically during the testing. We typically run two of these, one up under the armpits, one a little further down. And these are the kind of responses we see for these tests. In a seatbelt situation, you have a fairly localized impactive chest. The load is not distributed over a very wide area. You get these localized indentations. This is the top band where the best is pretty much in the center and as it curves down it gets off to the side. If you compare that to what we see on the airbag restraint, you get much more of a well distributed low distribution over the front of the chest.

Now we understand, we're engineers, we know that stress is equal to force over the area, so if you increase the area, you can withstand more force. So what we've done is we've come up with something that we refer to as the dichotomous process where we take the data that we have and we just say okay, we have all these measurements. We have displacements measured, we're actually now looking at the full cross-section, taking measurements of five points on chest wall, we're going to measure displacement, then we're going to measure T1 acceleration and the chest acceleration. We're going to throw them into some kind of analytical sorter and that's going to tell us whether it thinks that the belt-like response or an airbag-like response. It doesn't mean it's a belt. It doesn't mean it's actually a belt or an airbag. It just means that the response looks like a belt whether it's localized distribution, or a distributive situation. And then we apply different injury criteria to those two situations and come up with a probability of injury.

This was kind of brought about because the auto industry was complaining that the 60g's that we had told them that they had to meet is not a good number to use for airbags and they're right. Because if you have an airbag and you're distributing the load over a much larger area, you can take more than 60g's. And there's currently kind of an argument that it should be raised to 80g's for an airbag. We're thinking about that. So these are the five locations that we're measuring displacements at. This just shows that along the top are actual belt tests and along the bottom are airbag tests. This just shows that the design of the analytical server does a pretty good job of actually distinguishing which ones really work, belts or bags. And when we feed that on through and come up with this plot of the probability of serious injuries, we see basically we get a much higher rise, a much higher slope in these plots, so we get a better predictive tool to look at chest injury related from any arbitrary loading on the chest walls. Don't ask me any statistical questions on that.

Again, we do analytical modeling on all of these. We have modeling of the finite-element model of the chest. Again, it includes all the important body kinds of tissues, all the bones, cartilage, muscles, ligaments, everything that is structurally important to human beings. What we do is we can subject this to a variety of insults. Again, this could be any automotive environment or any other environment. The tools, develop the tools available and we can put any loading condition you want on these models. This just is looking at a two-point belt restraint. Not a lap belt, just a shoulder belt. If you look at the displacements, you can see at this point, here in the lower right quadrant of the ribcage, should be much lower down. It gets pulled back quite a bit by the seat belt. This plot over here shows the stresses on the ribcage. Color scheme is set up so that whenever you see red, that's roughly the breaking strength of bone. So we see potential rib fracture along the seat belt here, but we also see, it's kind of hard to see in this figure, that there are some touches of red remote due to the, if you want to call it the croissant factor, if you press in one direction, it bows out in the second direction. This model predicts that you can see fracture of the bone remote from the belt. In our cadaver test that we conducted, we do in fact see fractures remote from the belt. It's a model, again, good well-developed analytical tools predict these fractures. Again, we can subject it to not only seat belt loading, but we can get airbag loading.

This just shows that for given deceleration pulse, that you have a change in velocity, a beginning change in velocity. An airbag will give you a much smaller deflection of the chest than the belt system does. So again, if you distribute the load over a larger area you can withstand a greater force and ride down the pulse of the car.

This just shows what we've done to look at full body kinematics existing model of the Hybrid-III dummies. It's a finite-element model but it's really based on rigid body dynamics model. What we've done is we've taken this fairly crude model of the body, we pulled out their chest and we put in our chest. So we can look at full body kinematics but then look more specifically at the chest, and look at the deprivation of the stresses and strains and try to predict fractures and other internal injuries.

Again, moving down to the lower extremities and this has become an important issue lately again since airbags have done a good job at preventing a lot of head and chest injuries. We're now moving our concerns further down. Again we do experimental testing. These tests were being done at the University of Virginia and they have put together a pretty good test apparatus, again we instrument the cadaver, similar to the way the dummy is instrumented. We have MHD which are basically angular velocity sensors, MHD types. We have two of those and the load cell and done basically the same thing on the cadaver. We attach these MHD angular velocity sensors to the bone. We actually cut away part of the tibia and insert right into the shaft of the bone, we insert a load cell there so we can measure the load directly through the tibia.

This is, I guess the title is off the screen there, but it's called Intrusion Sled Test System and what it does is that in addition to the sled deceleration profile, you can independently give a floor-pan acceleration. So the foot pan or the floor pan is independently driven from the sled so we can look at what happens in crashes when the floor pan gets intruded into the occupant space.

This is a picture of the dummy's feet. We do these typically with cadavers. Try to minimize the number of cadaver pictures I'm showing in this presentation so you're seeing mostly dummies in these slides. But what we do, again, is mostly cadaver testing. This shows that at the end of the test, our floor pan has intruded almost all the way up to the seat edge. So again, when we do the test with cadavers, we see a lot of ankle injuries. The ankle injuries are very similar to the ones we've seen in the real world. The motion of the floor pan is really derived from this experimental data. We do crash a lot of cars. We probably crash about 40-50 cars a year. We get a lot of good experimental data that can be used to feed the rest of these testing studies.

Again, an analytical model of the leg. This is fairly recent in development. We haven't done a whole lot with this. I'll show you a few pictures, again-

MICHAEL KLEINBERGER: -It's got a pretty good description of the anatomic components of the lower extremity. Some of the detail, as you can see in the knee you have collateral ligaments and the crucial ligaments. This a student that's working on his dissertation. He's putting together this model at George Washington University. It's a very detailed model of just the ankle looking at fractures of the bones. I mentioned a lot of academic development. This is the Hybrid-III as it exists and what we measure is basically head acceleration, chest acceleration, chest deflection at one point in the sternum and femur load, really essentially all that we regulate at this point in time. We've just released a new dummy, it doesn't have a name yet. We have basically improved every body region of that dummy, from the head all the way down to the feet, has more humanlike shoulders. It can move the shoulders around unlike the Hybrid-III. It has abdominal instrumentation where you can measure the pressure in the abdomen. It has a new pelvis. One of the problems with the Hybrid-III which I think will definitely play into a lot of the tests that you may be thinking about doing in the training situation is that the Hybrid-III pelvis does not bend. It's a fixed pelvis.

This new dummy allows rotation at the hip. The femur has more compliant, more humanlike response. The neck again is more humanlike in its bending characteristics as well as its actual compression. A lot more instrumentation is being thrown into this dummy. It has more instrumentation in the legs for measuring loads and angle, rotational displacements of the foot. A lot of instrumentation-I won't go through all of these but basically we have very significantly increased the number of channels of data that we're getting out of each one of these tests. I don't think our test facilities like that but they're already pretty much maxxed out. We also do some modeling of the vehicles. This is not done in my group but just for the sake of completeness I'll throw these up real quick.

We do finite-element modeling of the full vehicles. This was a model of a Ford Taurus which was developed by Easy Engineering. I think it's on the order of about 50,000 elements and we developed this model and we had some crash data to validate it against-we had crash data to develop the model, I won't say it was validated, but it was developed with this data. We then took the model that was given to us by Easy. We replicated it. We just duplicated it, turned it around and crashed into itself analytically. This is not a full frontal crash, it's an offset crash where they're not totally head on. And we got an analytical prediction as to what the acceleration forces would be on these vehicles in that type of crash. And then we went and we actually got a couple of Ford Tauruses and we crashed them in the same situation and I will state here that the analysis was done before the test was done and the data actually looks pretty good. We're pretty proud of that. That's pretty good correlation.

We also do some analyses of side impacts as well. We're not doing rollover quite yet but we'll get around to it. We do some rigid body dynamic analyses and again this is not my group so I'll just go through these real quickly. I think one of our next speakers will talk more about this MADYMO, it's similar to ATB or Adams, that's the kind of information you get out of these models. We can look at various restraint systems, seatbelt systems, airbag systems and how they work with each other. We can look at different occupant types. We can look at small females. We can look at children. One of the problems we're trying to work on right now is trying to understand how to protect small children in front of airbags. We tell the public not to put your kids in the front seat if there's an airbag. They do not heed our warnings. They're still doing it. It's a potentially dangerous situation. So we're working on ways to change airbag technology, to make it less harsh for children. We're also looking at some of the vehicles. This is just a quick study that was done on seat back strength. Trying to see in a rear impact how varying the properties of the seat back and the seat would change the injury predictions that are seen in for example, neck injury or whiplash. Thank you very much. I'll be happy to take any questions.
[Applause]

JOHN LEWIS: We use Hybrid-III dummies in the UK as well for testing in cars and railway vehicles. What I'm particularly interested in was the fact you said you have no neck vending criteria. We use a neck vending moment which I thought derived from work done in the States, as most of our dummy criteria area. Could you just explain why you think we have a neck vending moment. Consider it important whereas you seem to have discovered-don't think it's important?

MICHAEL KLEINBERGER: The way I should have stated that is that we do not have any neck injury criteria in our regulations. Our standards do not call for any neck injury criteria. There are some recommendations. Most of that came out of GM from Bud Mertz. That's probably what

you're using. Torque angle corridors basically. There are recommendations that are out there and a lot of it came from GM and they are not yet in our standard--well, they may never be in our standard but they are currently being used by us and by the industry in this country as well, but they are not regulated. They're not part of the standard. That's why I said that we currently don't have any injury criteria for the neck. That's just not in our standard yet.

MICHAEL KLEINBERGER: A lot of--some parts of the body and the neck is a particular example of that are very difficult to understand because there are so many different failure modes associated with it. And that's probably why we don't currently state any in the regulation because we're not very comfortable or confident with any of the ones that are out there. But in the meantime until we get something better we will use these recommendations that again typically come out of General Motors.

DAVE TYRELL: Dave Tyrell of the Volpe Center. I guess I have a related question. Am I to understand there's a wide disagreement about that criteria? That there are some people that strongly disagree I guess with the GM or the Mertz criteria, whatever you want to call it.

MICHAEL KLEINBERGER: I don't know if there's any tremendous disagreement about it but the problem with--I really don't want to stand up here and go on record as really pounding the Mertz criteria but I personally have problems with basing the agency's recommendations on I believe what came out of two or three tests on one individual. There was one subject that was tested a few times and all of that data and all of those recommendations from GM came out of one particular individual. And if that person happens to be not average or somehow not proper kinematics or mechanics I'd really hate to make that a standard. Now there are many more tests that were done, for example, by the Navy on their quote volunteers. And there's a longstanding debate between us and the industry as to whether we should be using that Naval data. Or whether we should be using this GM data. And we're trying to reach agreement on that but it's been going on for a long time.

KRISTINE SEVERSON: Kristine Severson, Volpe Center. You said you have a human body representation using finite elements and you talked a little bit about MADYMO. Do you compare the two for a similar collision? That finite-element human body model as well as the MADYMO in terms of predicting injury criteria and if so, how do they compare?

MICHAEL KLEINBERGER: We have different groups in crashworthiness research. Again, we have the biomechanics group and we have the safety systems or the vehicle group. In the biomechanics group we tend to do finite-element modeling and we are doing modeling of the human body itself. We have the various pieces. If we want to put them all together and run a full body we could, although I don't think there's a computer around that would actually run that problem. Some of these models are pretty big and take a long time to run. On the vehicle side they tend to do the MADYMO modeling, And they're looking at the vehicle structures. They're looking at the seat backs. They're looking at floor plan intrusion. They're looking at different things. So we haven't actually directly compared the findings from the finite-element models with the findings from the MADYMO models. We could do that. And we probably should do that but we just have done it yet. Anybody else?
[Applause]

MICHAEL KLEINBERGER: Steve Soltis please.

PRESENTATION

***TESTING AND ANALYSIS OF OCCUPANT - VEHICLE
COLLISIONS***

Testing and Analysis of Occupant-Vehicle Collisions

by

Dr. Michael Kleinberger
Biomechanics Research Division
National Highway Traffic Safety Administration
Washington, DC



Rail Vehicle Crashworthiness Symposium
Volpe National Transportation Systems Center
June 24-26, 1996



Current Injury Criteria

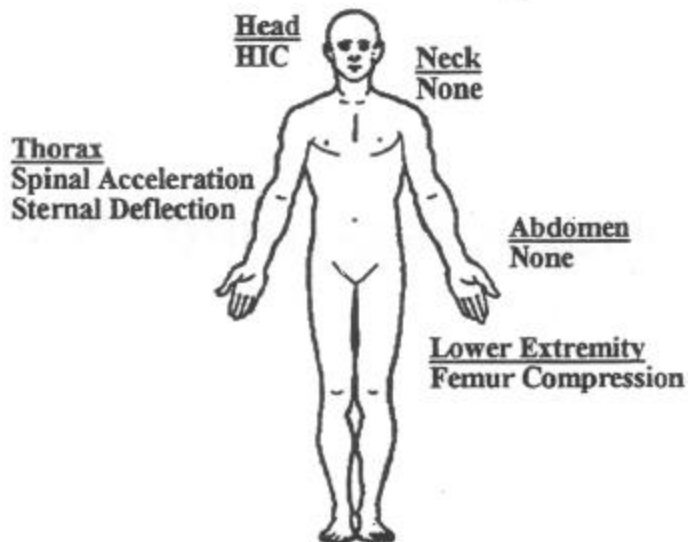

Advanced Injury Criteria

Head

Cum. Strain Damage (FE)
Volume Fraction
Facial Loads

Neck

Axial Compression
Ligament Strain (FE)

Thorax

Spinal Acceleration
Chestband Contour
Dichotomous Model

Abdomen

Abdominal Pressure

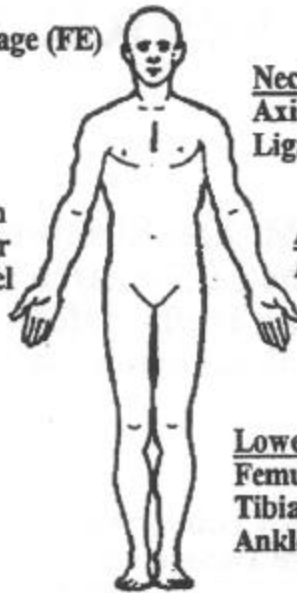

Lower Extremity

Femur Compression
Tibial Loads
Ankle Rotation

Trauma Assessment Scales

Abbreviated Injury Scale

(AIS)

Body Region

Head, Spine, Thorax, Abdomen, Lower Extremity, etc.

Type of Anatomic Structure

Skeletal, Organs, Nerves, Vessels, Whole Area, etc.

Nature of Injury

Abrasion, Laceration, Avulsion, Burn, Crush, etc.

Severity

Minor (1), Moderate (2), Serious (3), Severe (4), Critical (5), Maximum (6)

Sample AIS Coding

Body Region	Injury Description	AIS Code
Head	subdural hematoma (small)	4
	closed skull fracture	2
Chest	single rib fracture w/pneumothorax	3
Abdomen	minor liver laceration	2
Lower Extremity	femoral shaft fracture	3
Skin	overall abrasions	1

Fatality Risk from Multiple Injuries

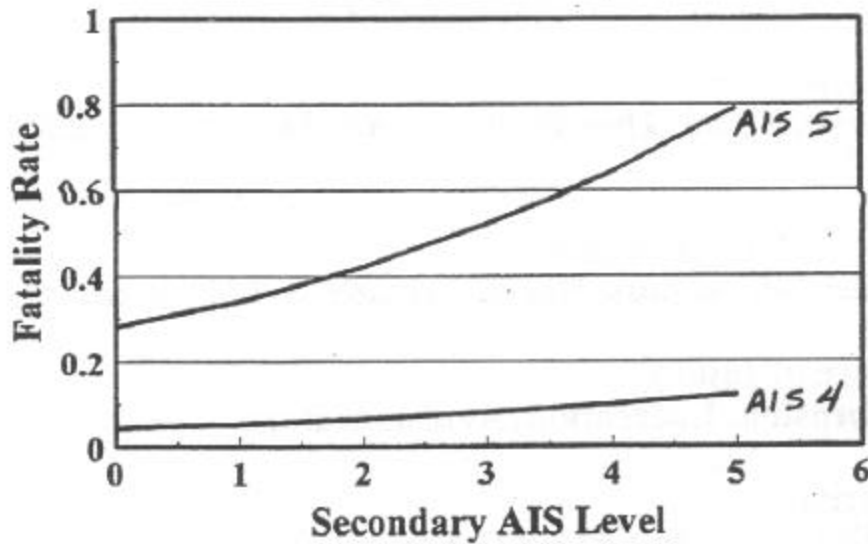

Injury Severity Score (ISS)

Body Region	AIS Code	Highest AIS	AIS Squared
Head	4	4	16
	2		
Chest	3	3	9
Abdomen	2	2	
Lower Extremity	3	3	9
Skin	1	1	

(ISS= 16+9+9=34)

Glasgow Coma Scale

Eye opening (1-4)

Best motor response (1-6)

Verbal response (1-5)

Total Aggregate = 3 - 15

GCS = 3-4 (85% fatality within 24 hours)

GCS = 11+ (5-10% fatality/vegetative state)

Eye opening

Spontaneous
To loud voice
To pain
None

Best motor response

Obeys
Localizes
Withdraws (flexion)
Abnormal posture (flexion)
Extension posture
None

Verbal response

Oriented
Confused, disoriented
Inappropriate words
Incomprehensible sounds
None

Functional Capacity Index

Based on functional capacity rather than specific injuries.

Panel of healthcare experts and population subgroups determined the relative values.

Life-years Lost to Injury (LLI) = FCI x (life expectancy)

Total hearing loss	0.35	Severe difficulty speaking	0.68
Total blindness	0.41	Severe incontinence	0.74
No sexual function	0.46	Tube feeding required	0.75
Cannot bend or lift	0.49	Paralysis, two upper limbs	0.75
Complete dep. Ambulation	0.67	Complete cognitive dependence	1.00

HEAD

Finite Element Brain Model

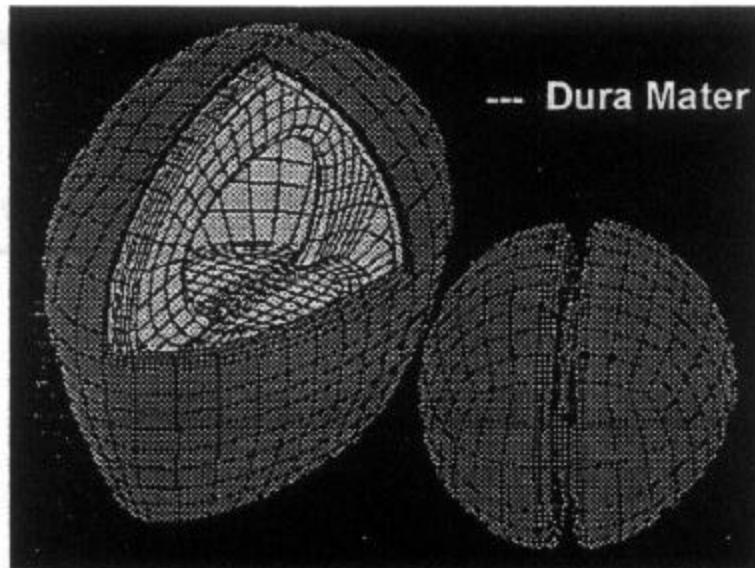

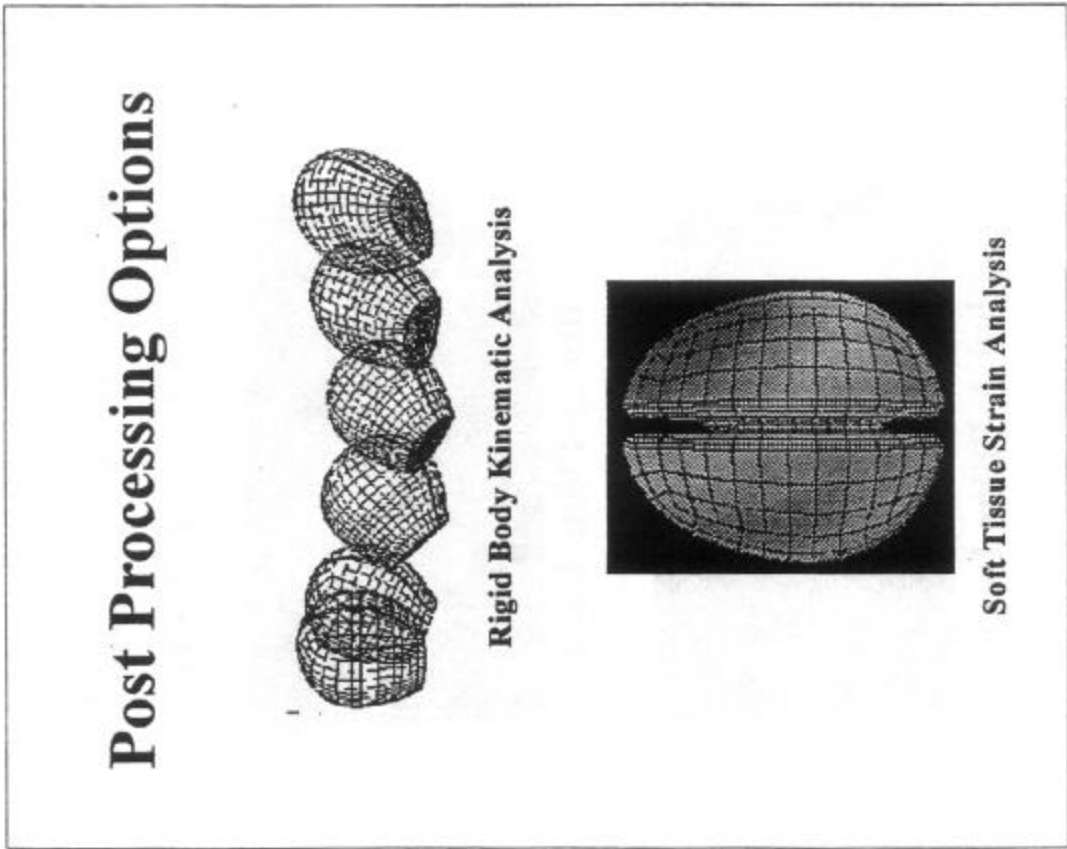
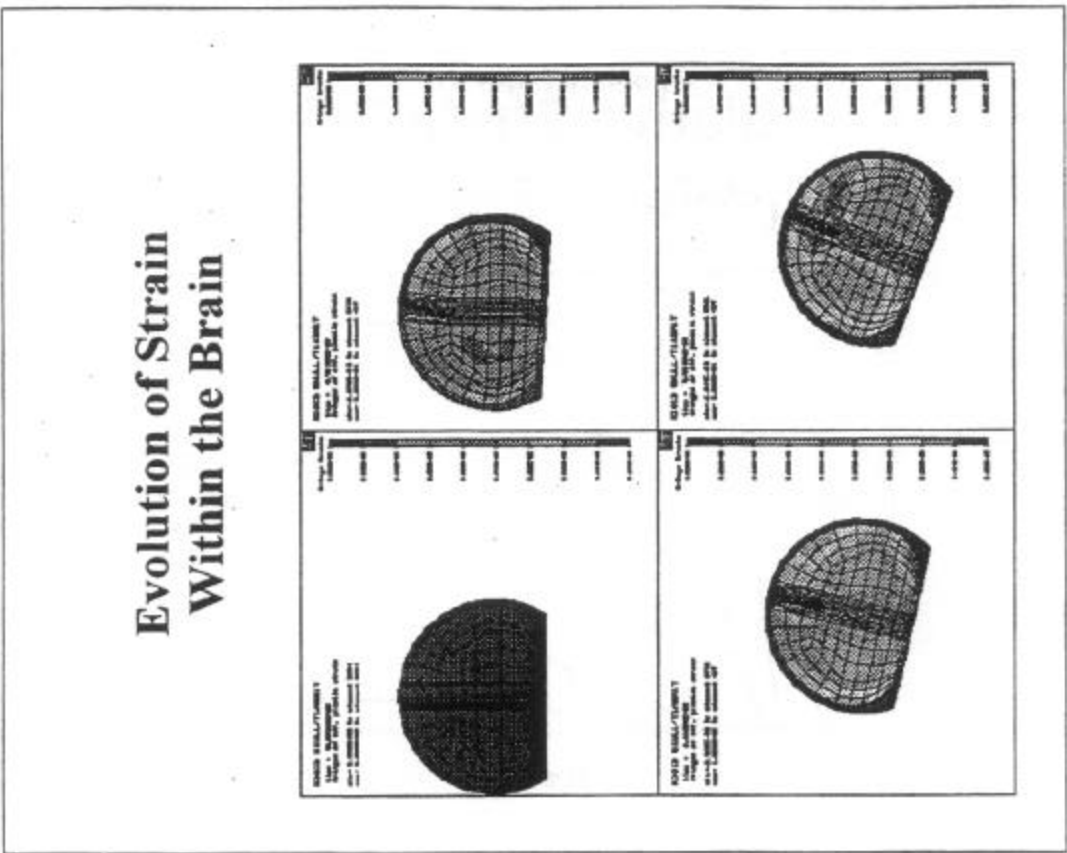

Cumulative Strain Damage (Volume Fraction)

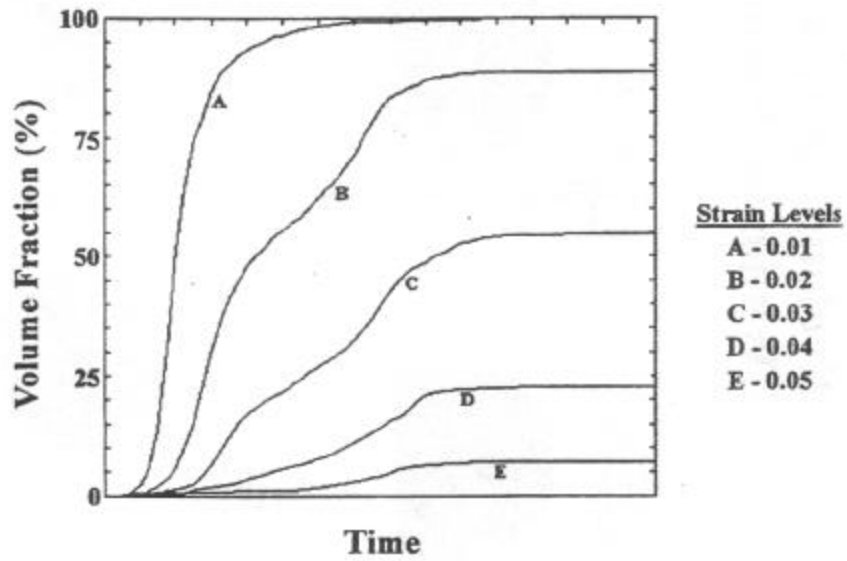

Comparative Simulation of A-Pillar Impact

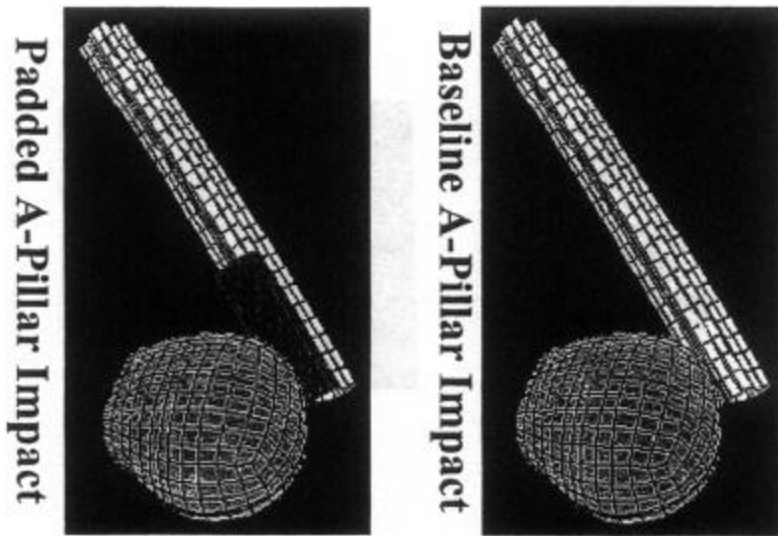

Qualitative Analysis of Padding Benefits

	Simulation		Experimental	
	Peak G's	HIC	Peak G's	HIC
Baseline	310	2475	312	2666
Padded	160	1113	165	973

A-Pillar Impact Simulation (Summary of Results)

Rotation and Translation

HIC Value = 854
CSDM = 52% volume

Rotation Only

HIC Value = 0
CSDM = 32% volume

Translation Only

HIC Value = 854
CSDM = 1.5% volume

CSDM = Cumulative Strain Damage Measure (percent volume above 7% strain)

**CT Image of Head
(Median View)**

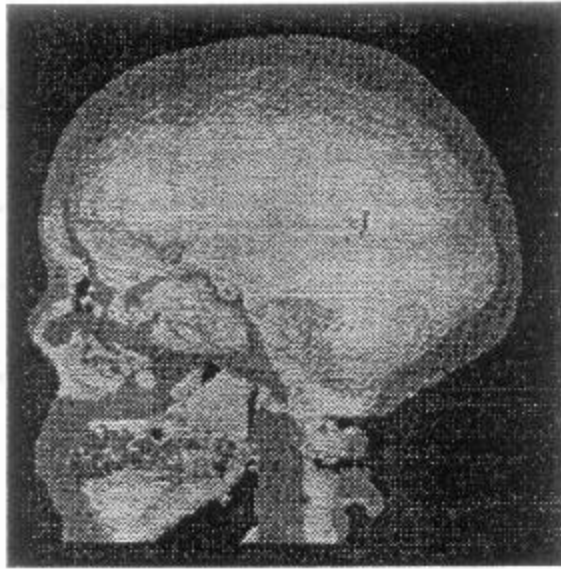

**Finite Element Model of Skull/Brain
Constructed from CT Image Data**

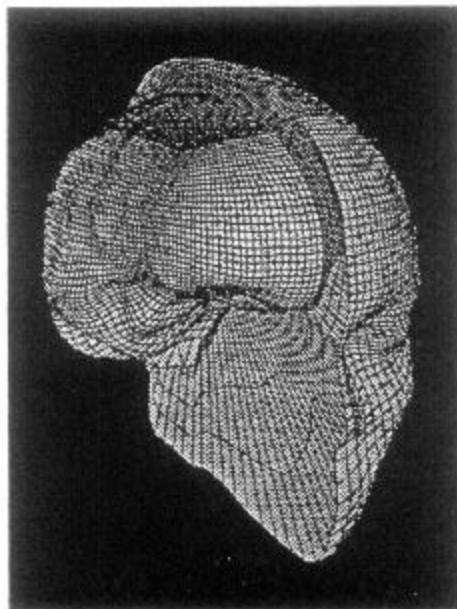

NECK

FE Model of Full Anatomic Cervical Spine

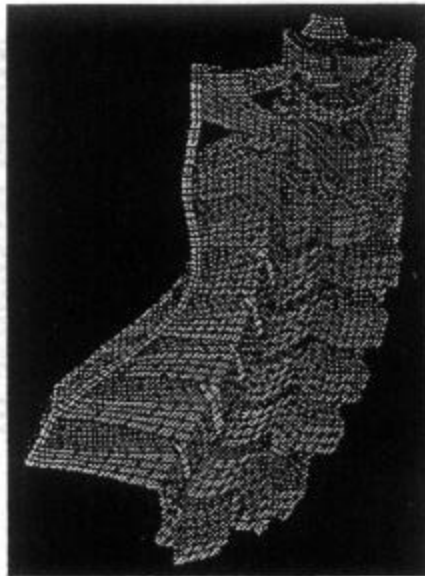

Experimental Neck Testing (Drop Track Assembly)

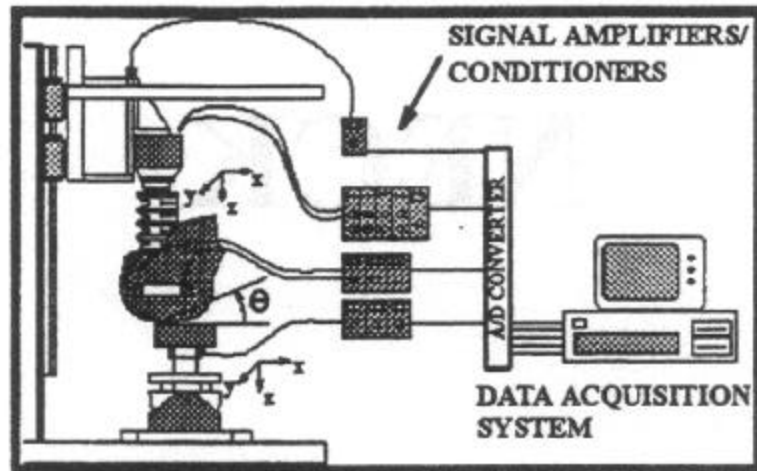

Courtesy of Duke University, Biomedical Engineering Department

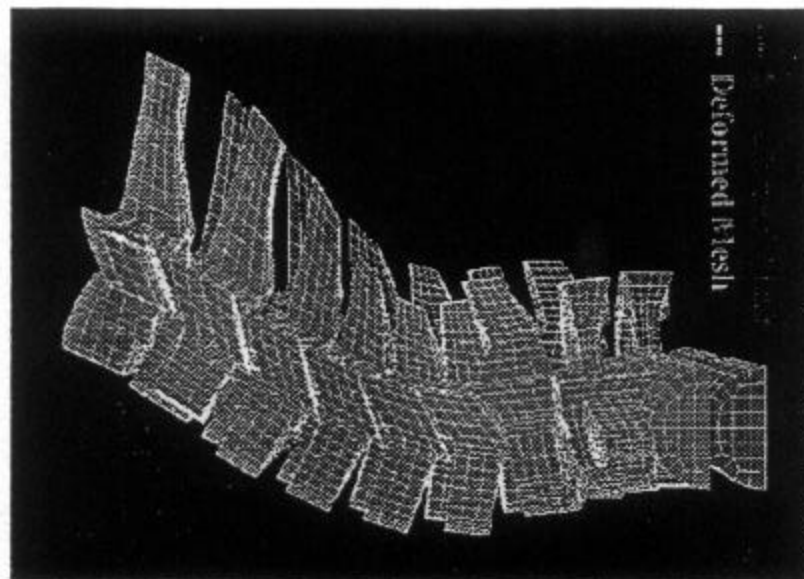

Experimental Neck Testing (Inertial Loading Test Frame)

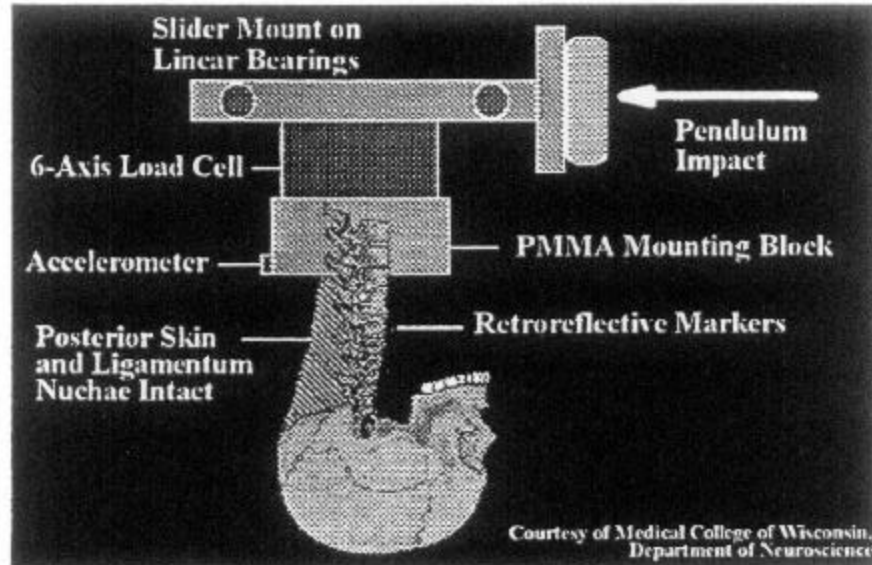

Kinematic Response of Anatomic Neck

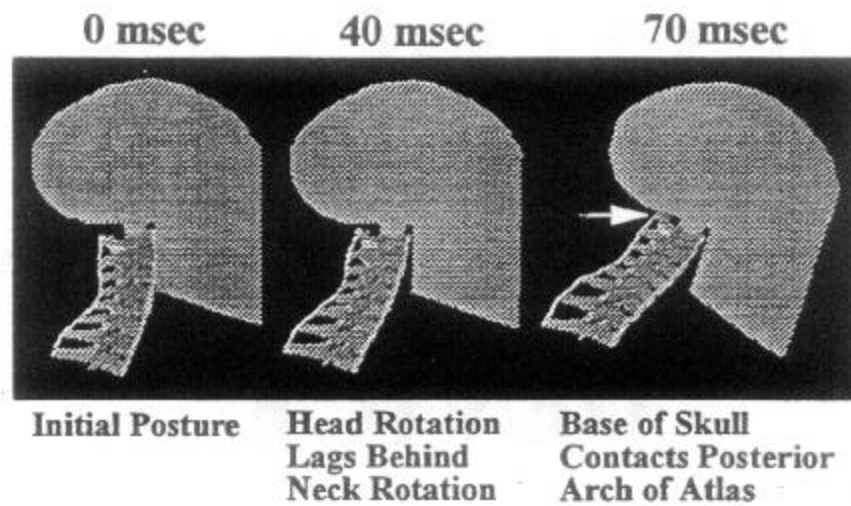

Comparison with Volunteer Data

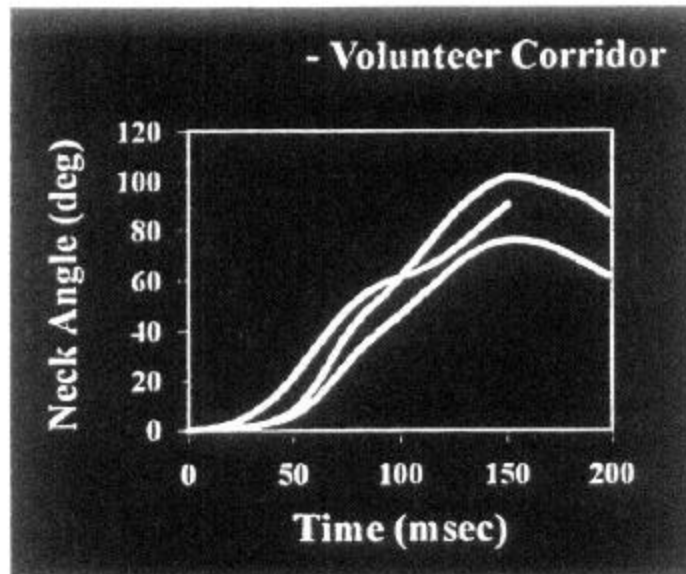

DEVELOPMENT OF IMPROVED CERVICAL TEST DEVICE

Kinematic Response of Prototype Neck 8g Frontal Crash Pulse

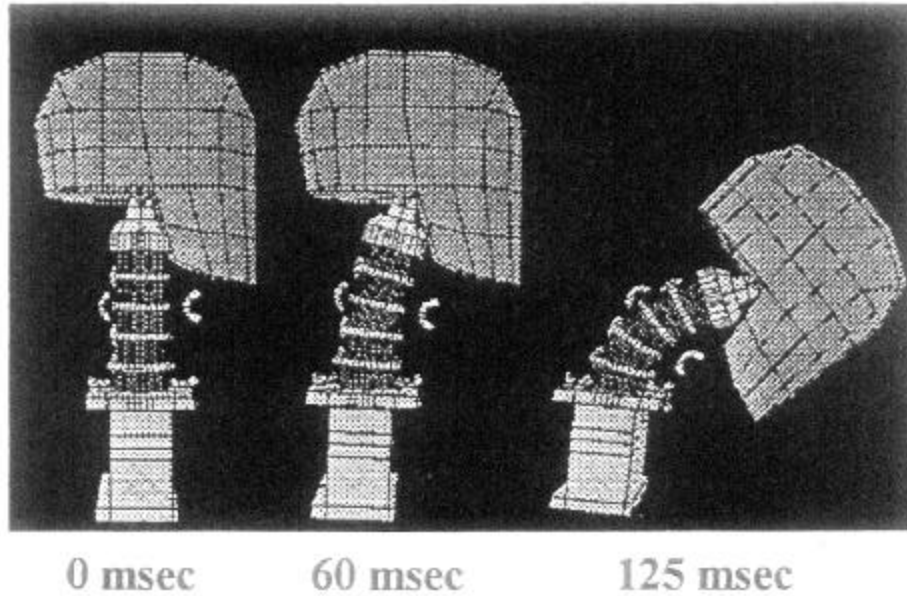

Comparison of Prototype Dummy Neck Response with Human Corridors - 15g

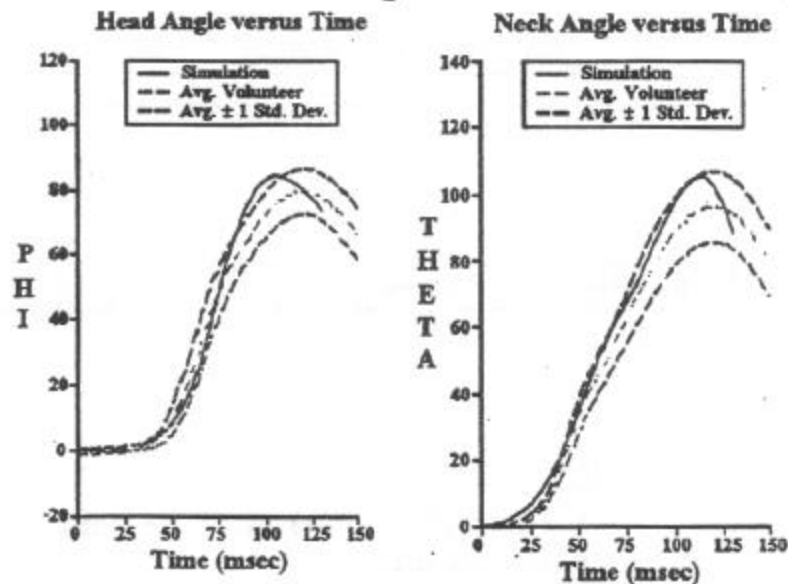

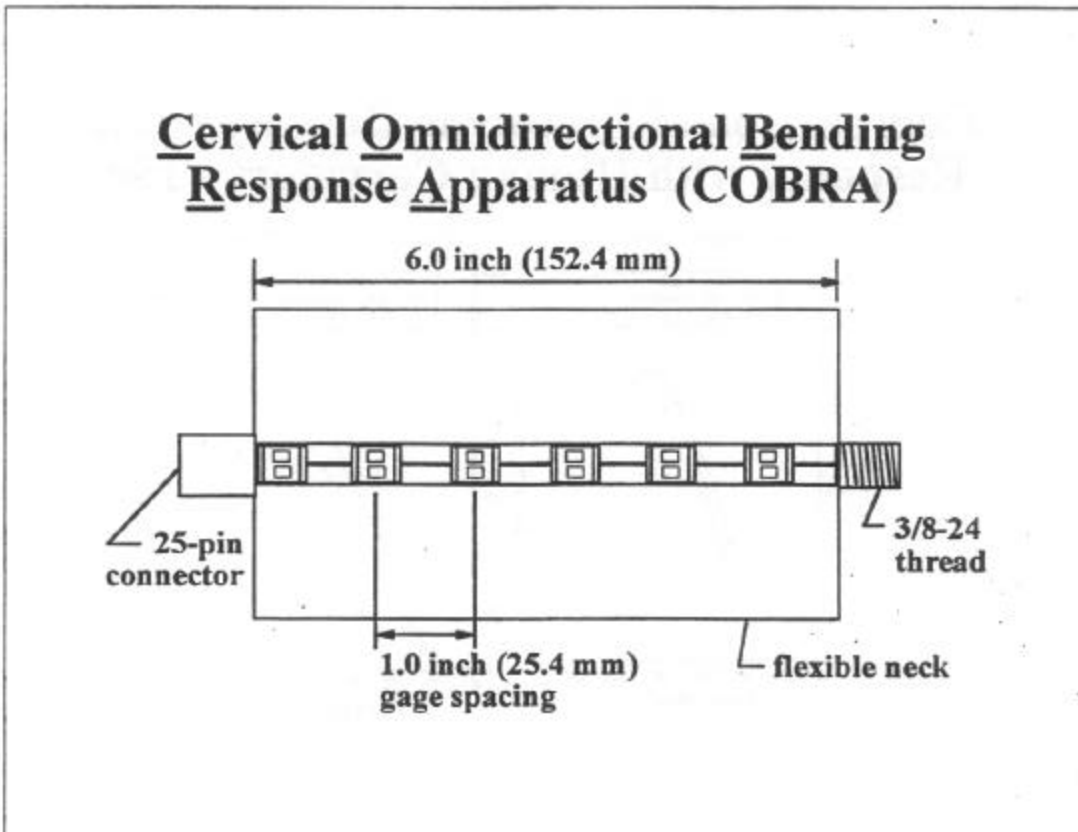
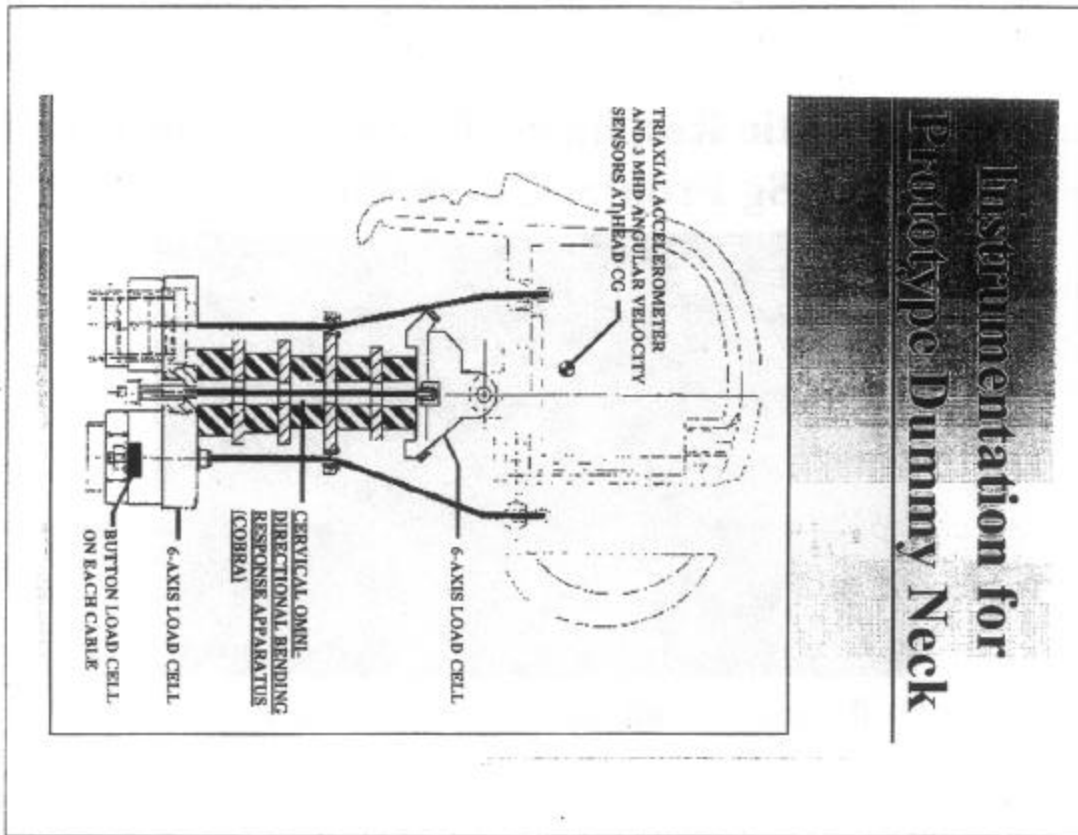

CHEST

Full Thorax Model Anterior View

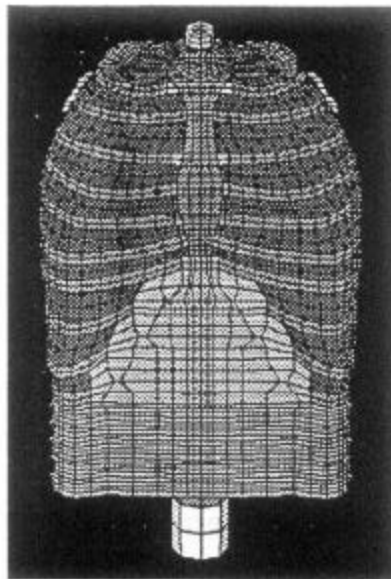

Legend

- bone
- cartilage
- intercostal muscle
- abdominal/back muscle
- lumped mass
- viscera

Full Thorax FE Model with Shoulder

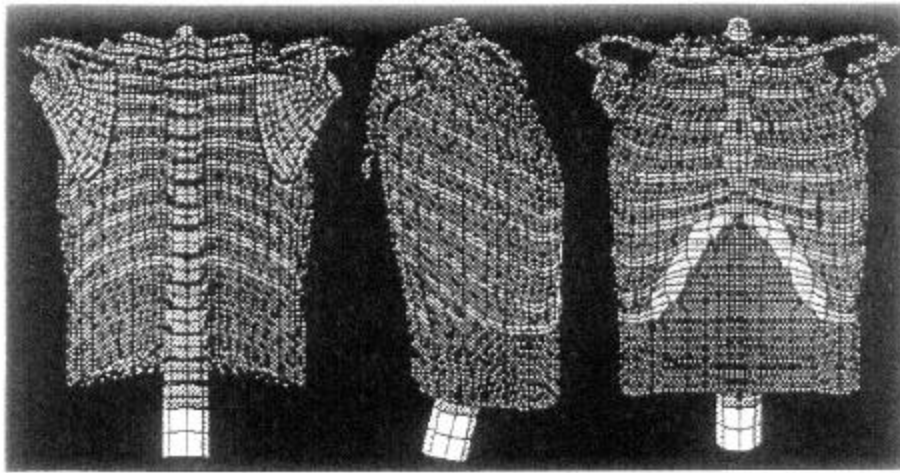

Posterior

Lateral

Anterior

Thorax - 2 Point Belt Interaction

Simulation Time = 50 msec

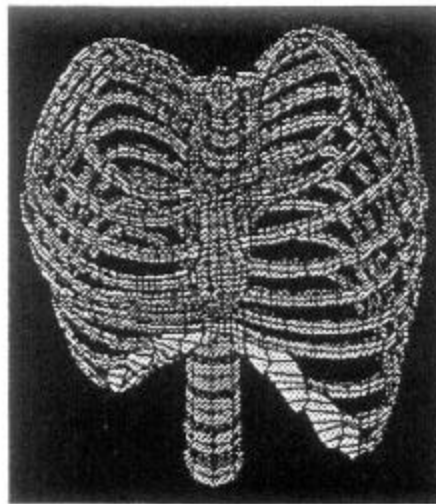

Deformed Rib Cage

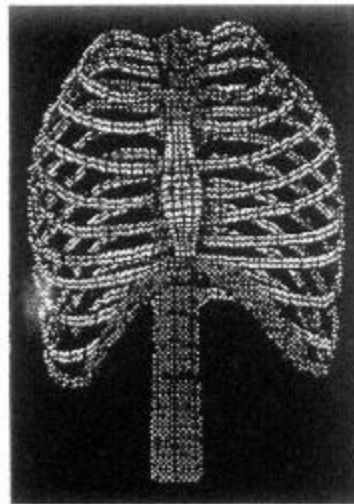

Stress Contours

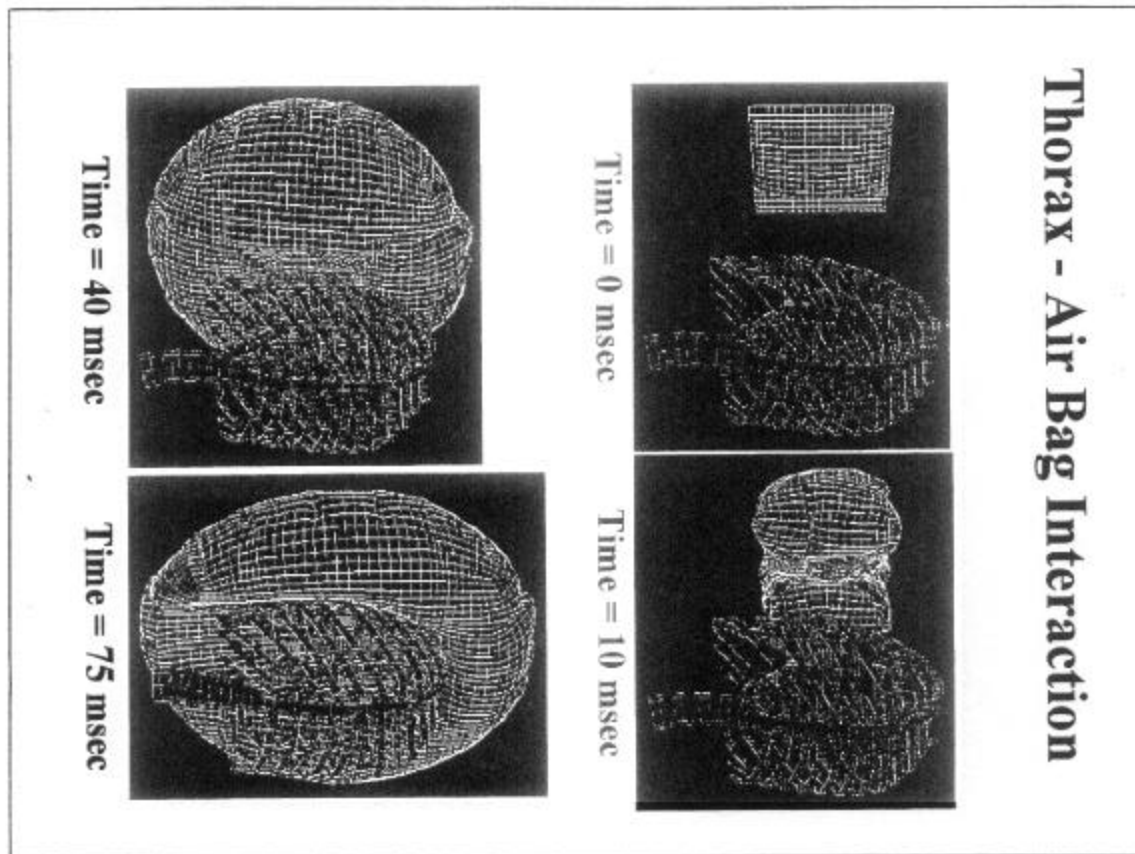

Comparison of 2-Point Belt and Airbag Interaction with Thorax

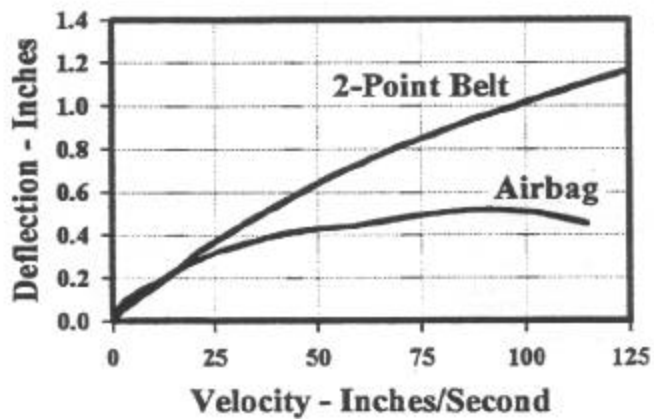

Hybrid III Dummy Model w/ Anatomic Thorax

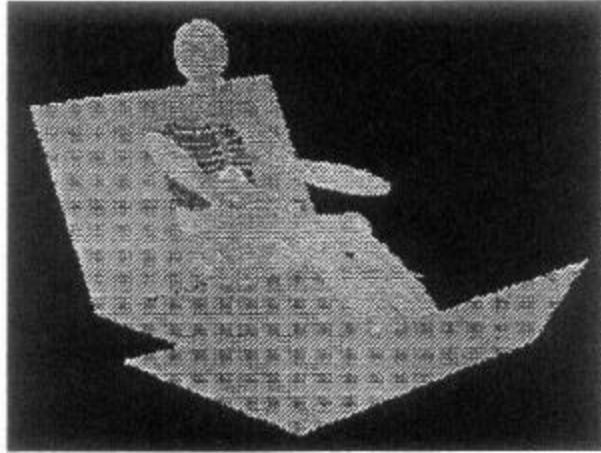

Chestband Instrumentation

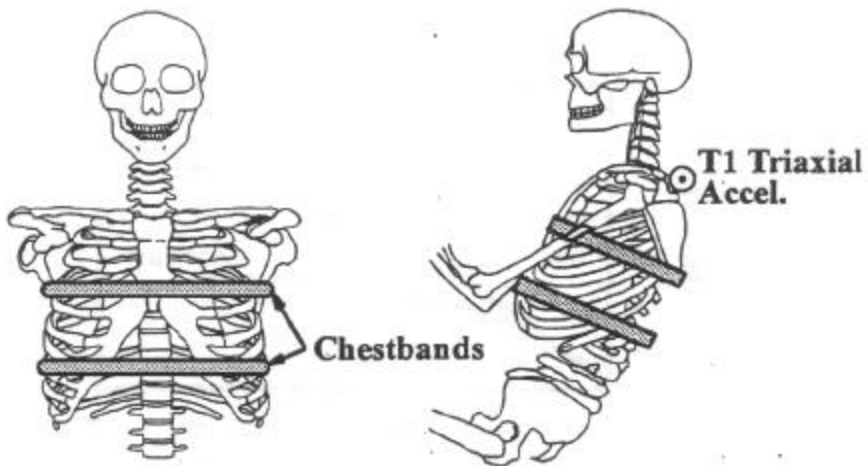

Typical Chest Contours

Belt Restraint

Airbag Restraint



top band



top band



bottom band



bottom band

Probability of Thoracic Trauma vs. T1 Acceleration

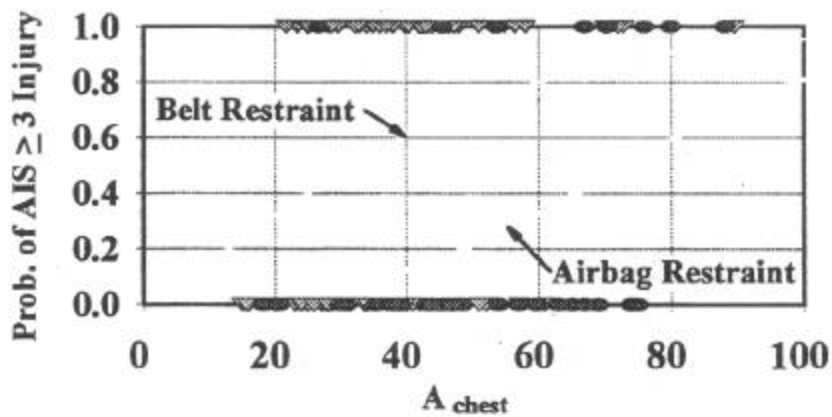

**Dichotomous Process
for Thoracic Trauma
Assessment**

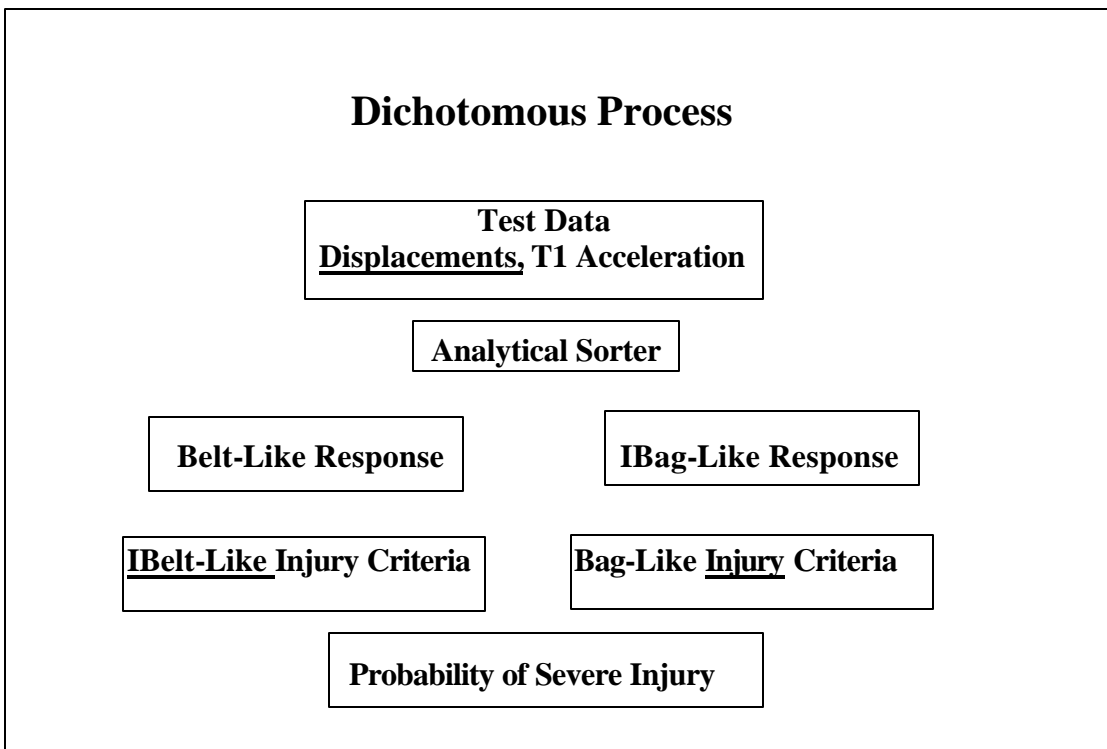

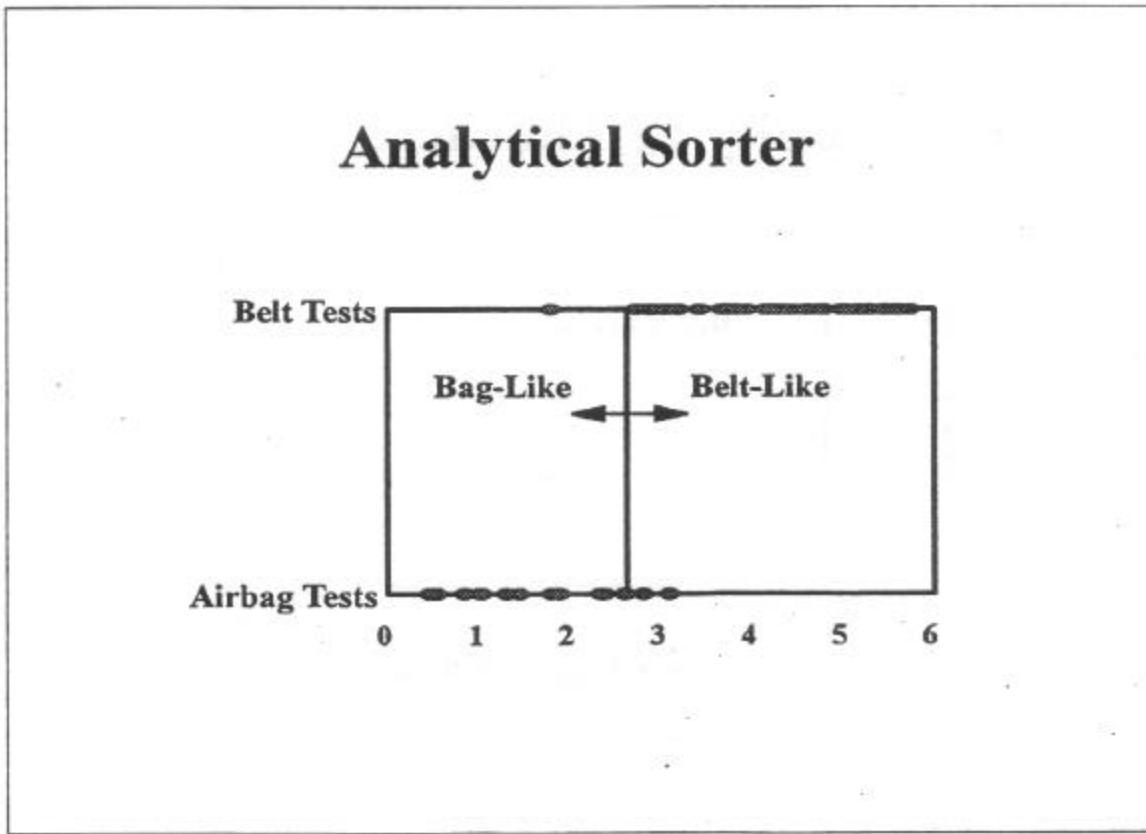
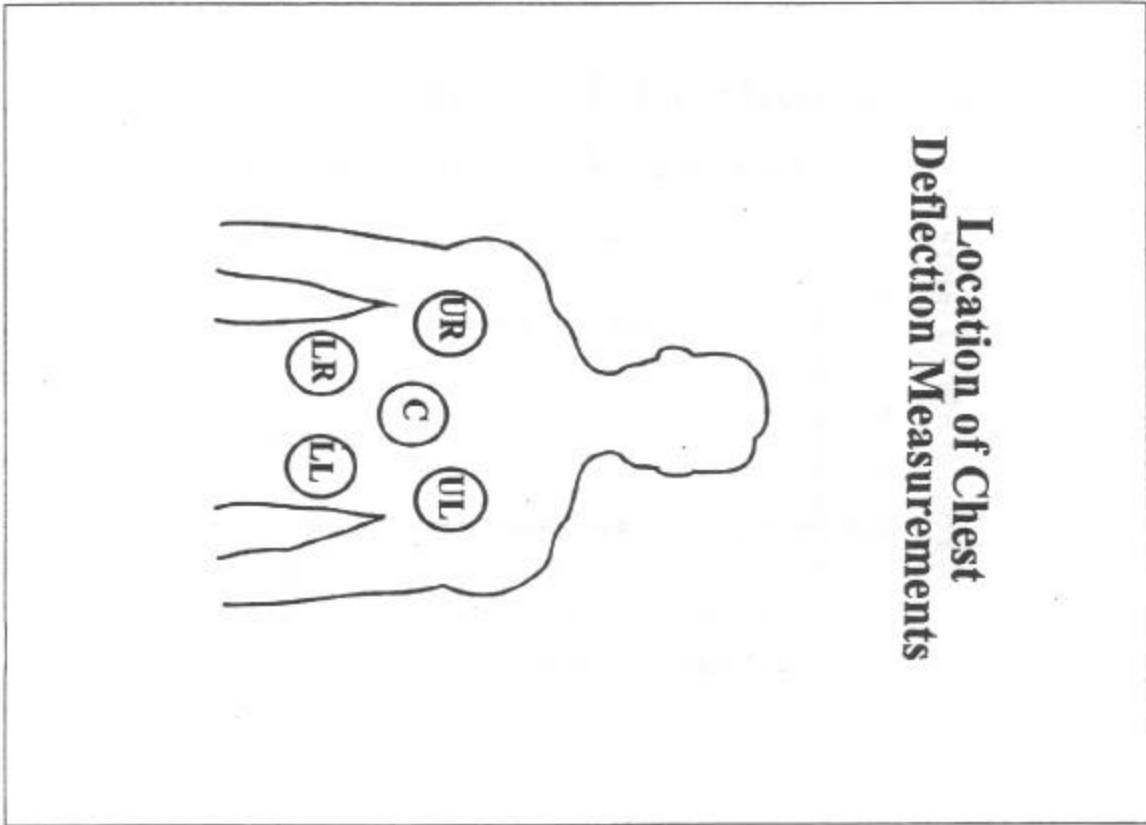

Probability of Thoracic Trauma vs. Linear Combination

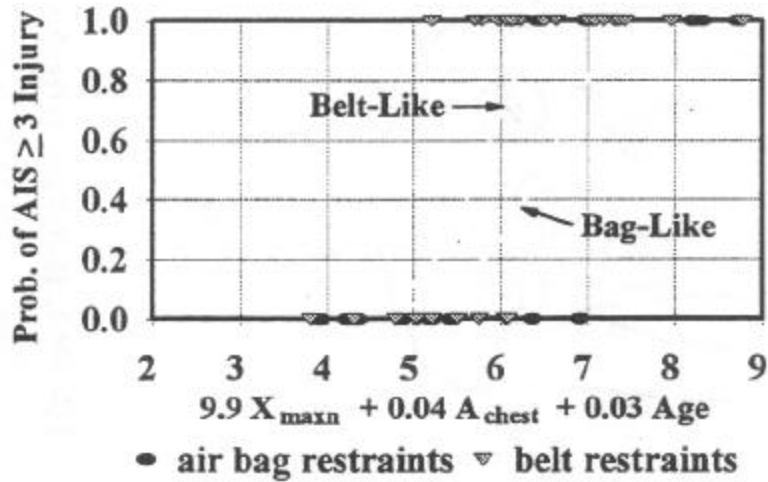

Probability of Thoracic Trauma

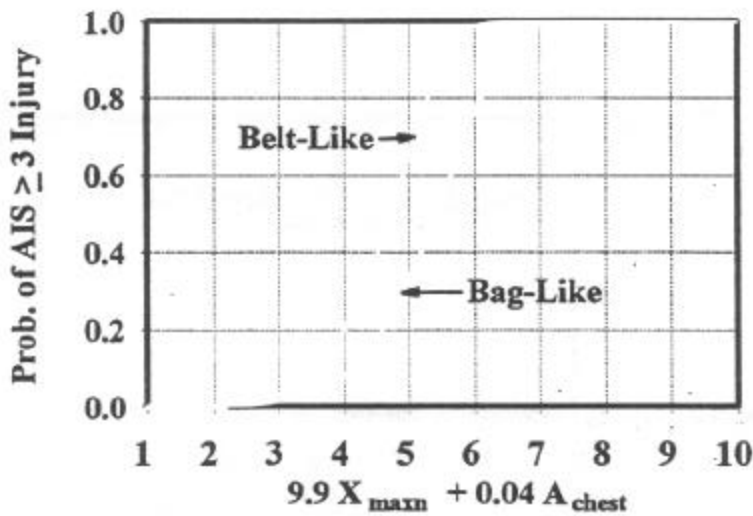

Lower Extremities

**Finite Element Model of
Lower Extremity**

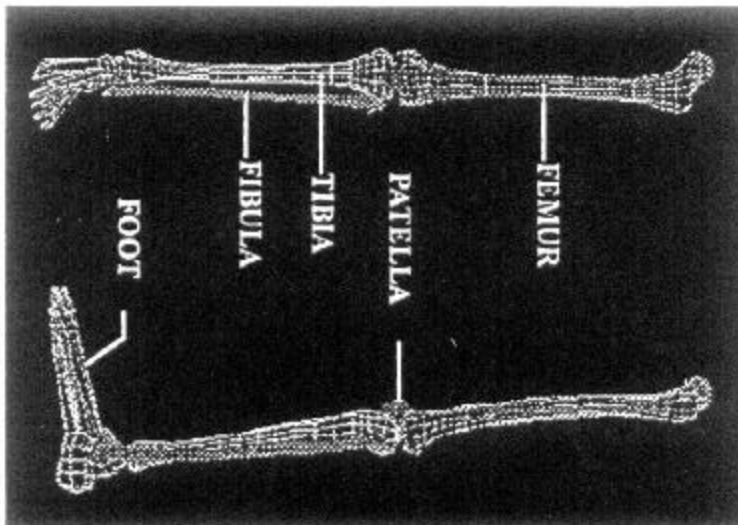

Finite Element Model of Anatomical Lower Extremity

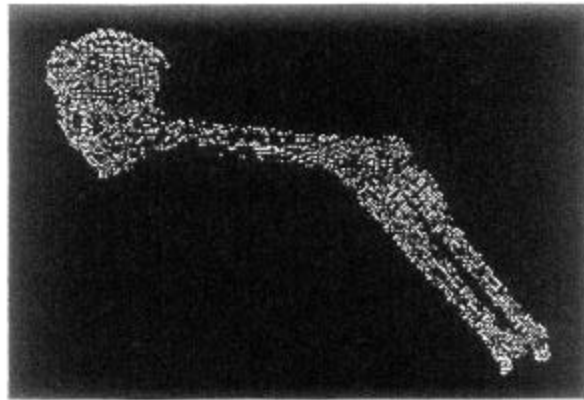

Finite Element Model of Anatomic Ankle Joint

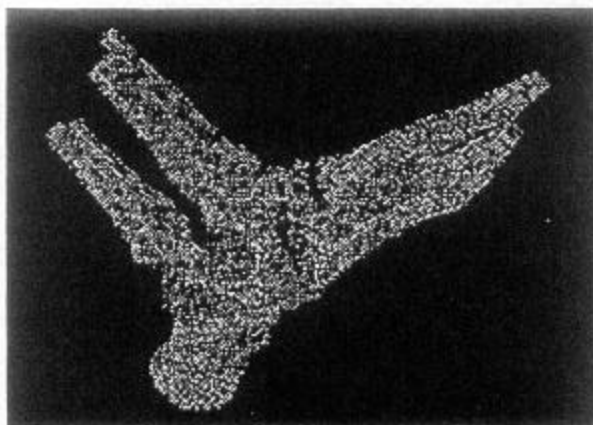

Experimental Ankle Testing (Pendulum Impact Apparatus)

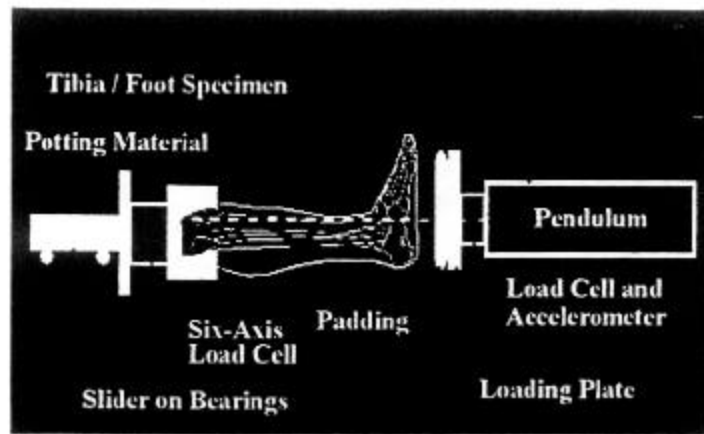

Experimental Toepan Intrusion Testing

Intrusion Sled System

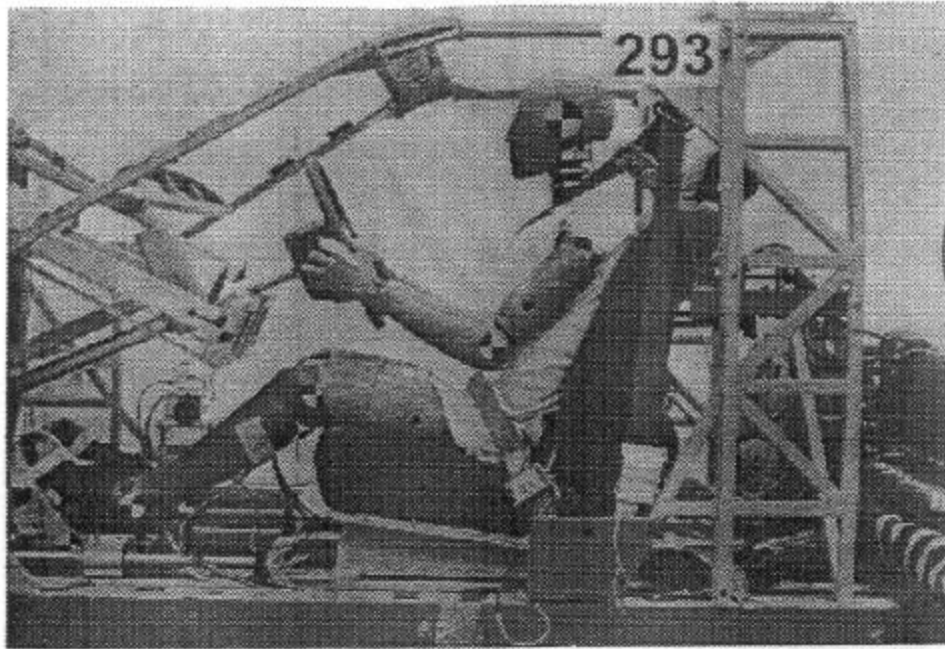

Courtesy of University of Virginia, Automotive Safety Laboratory

Intrusion Simulator (Toeplan)

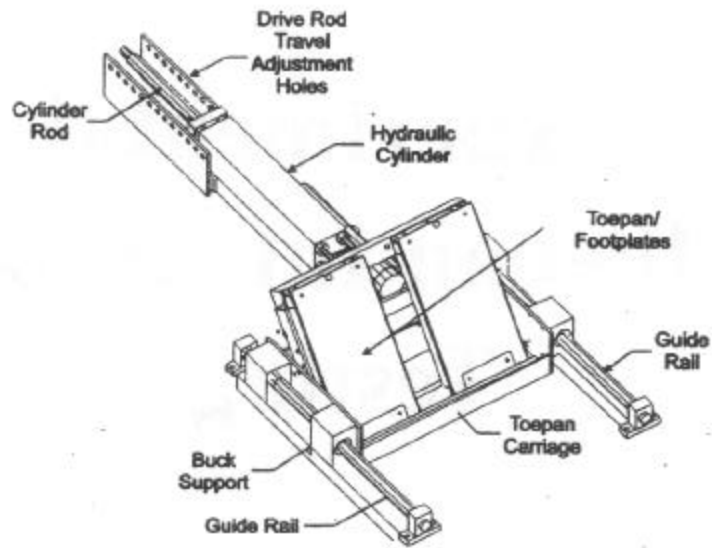

Courtesy of University of Virginia, Automotive Safety Laboratory

Intrusion Simulator (Toepan)

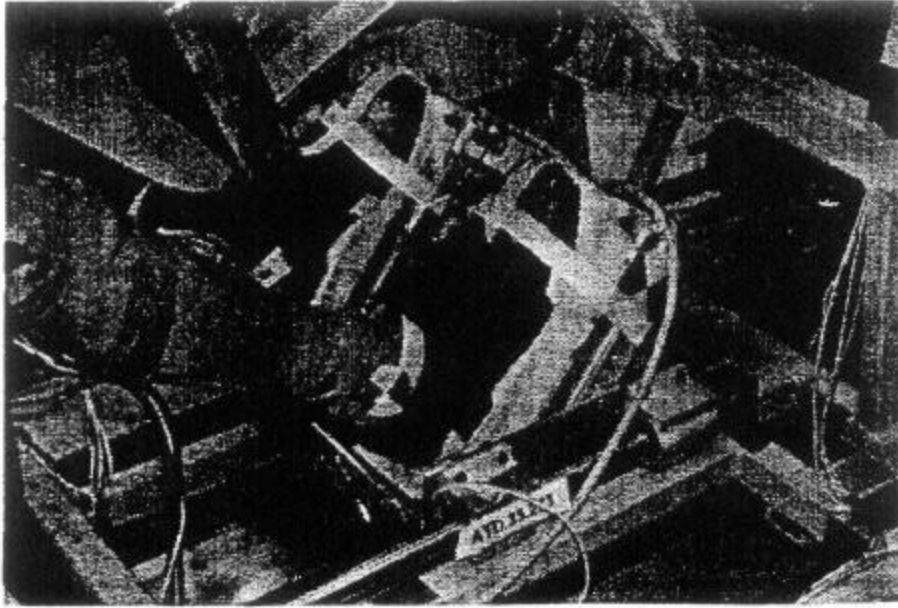

Courtesy of University of Virginia, Automotive Safety Laboratory

Intrusion Sled Test (Padded Toepan)

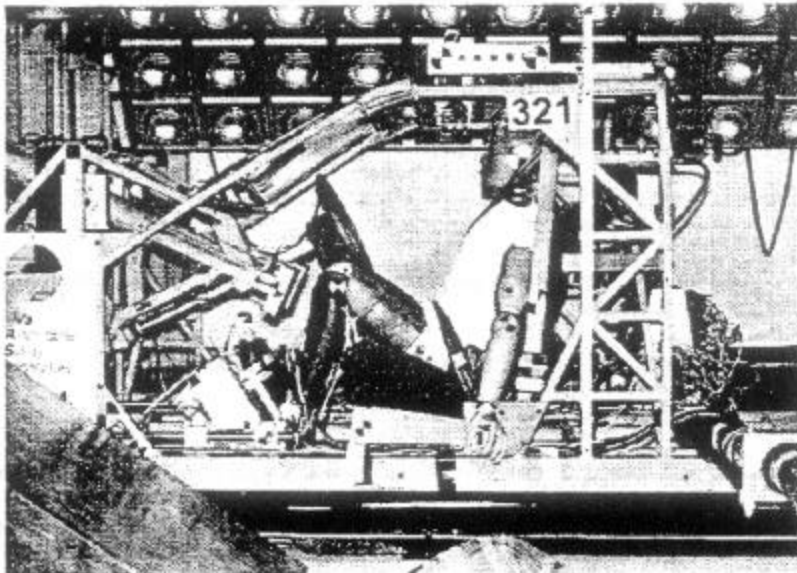

Courtesy of University of Virginia, Automotive Safety Laboratory

Advanced Dummy Development

Advanced Frontal Crash Test Dummy

- More humanlike thoracic structure with high-speed, three-dimensional deflection instrumentation
- Articulating spine with adjustable seating posture
- Improved shoulder design with more humanlike mobility
- New abdomen design featuring upper and lower modules with continuous 3D deflection measurement
- New pelvis design with new hip joints with injury assessment capability and submarining detection features
- New compliant femur design for more realistic femur loads
- Simplified load-sensing face
- New neck with more biofidelic flexion, extension, lateral bending, and axial response
- Advanced lower extremity (ALEX) with more humanlike ankle/foot motions and improved injury assessment capability

Advanced Frontal Impact Dummy

INSTRUMENTATION OVERVIEW

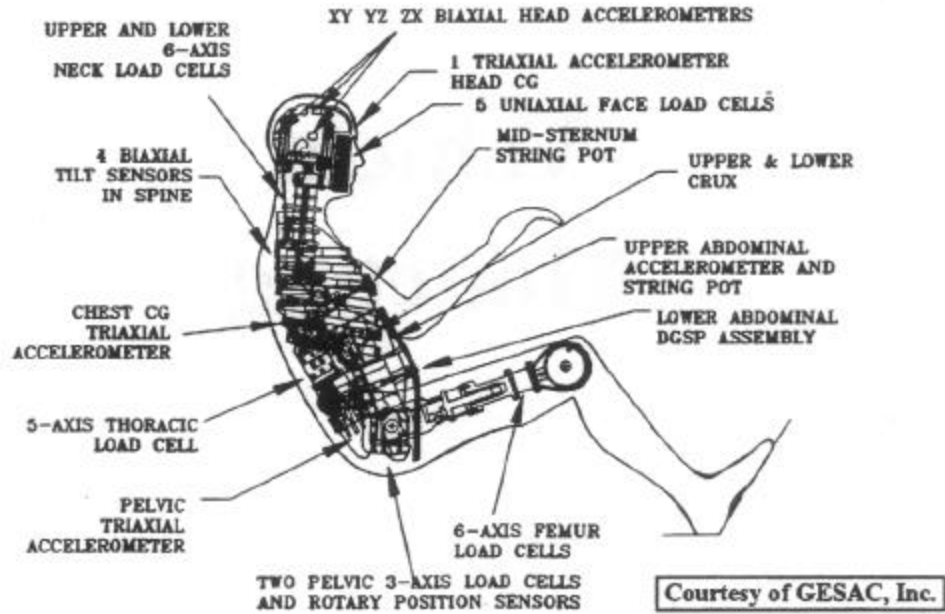

Advanced Lower Extremity Design

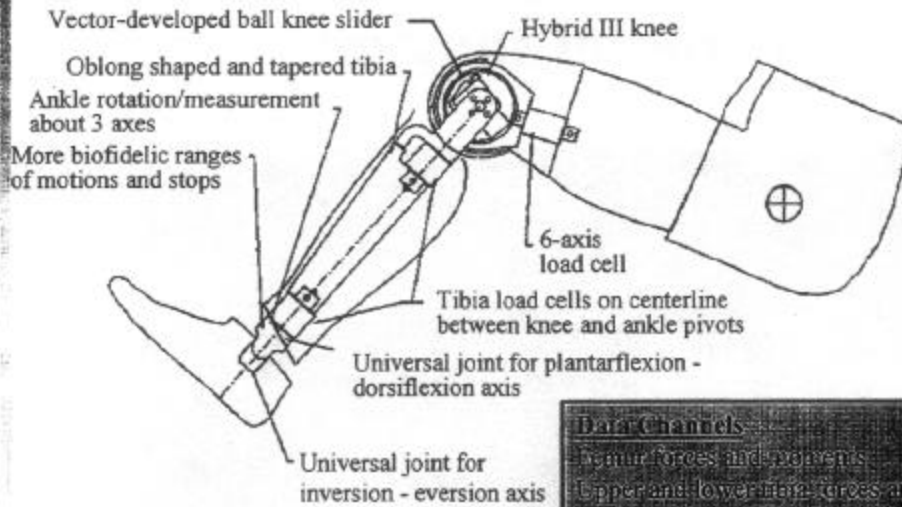

ALEX II
 Courtesy of NHTSA Vehicle Research and Test Center

- Data Channels**
- Femur forces and moments
 - Upper and lower tibia forces and moments
 - Ankle angles (3 axes)
 - Heel acceleration
 - Uniaxial load cells on heel and ball of foot

Vehicle Modeling

FE Model of Ford Taurus (Frontal Impact)

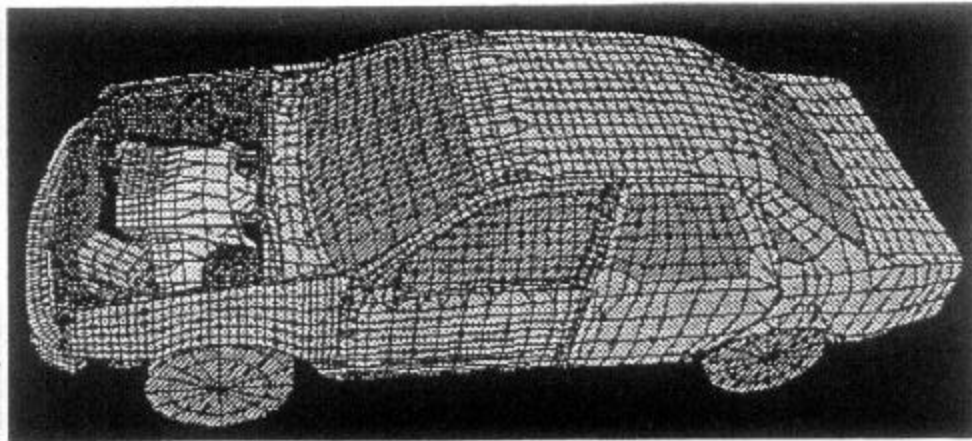

Offset Frontal Car To Car Crash Simulation

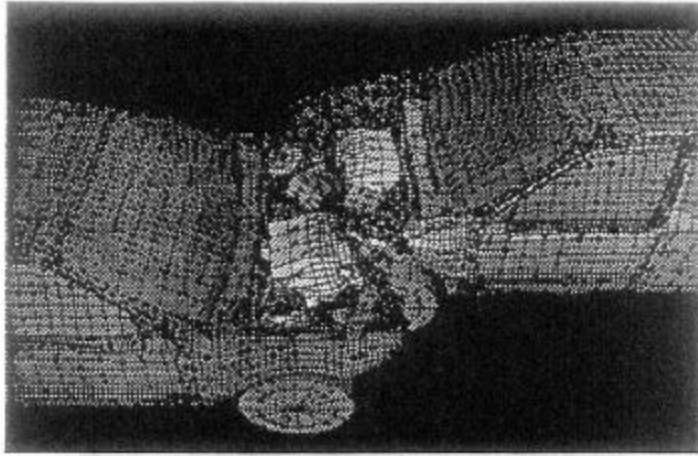

Car To Car Offset Crash Test

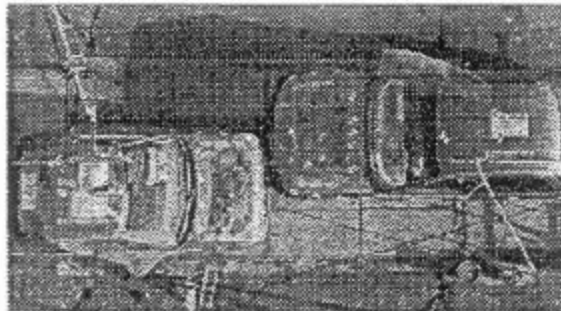

Frontal Barrier Impact Simulation

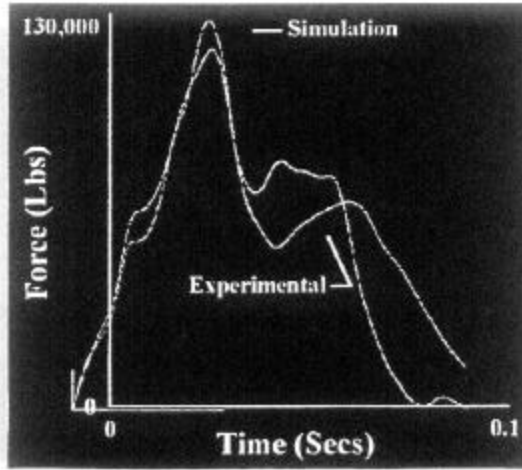

Madymo Kinematic Modeling

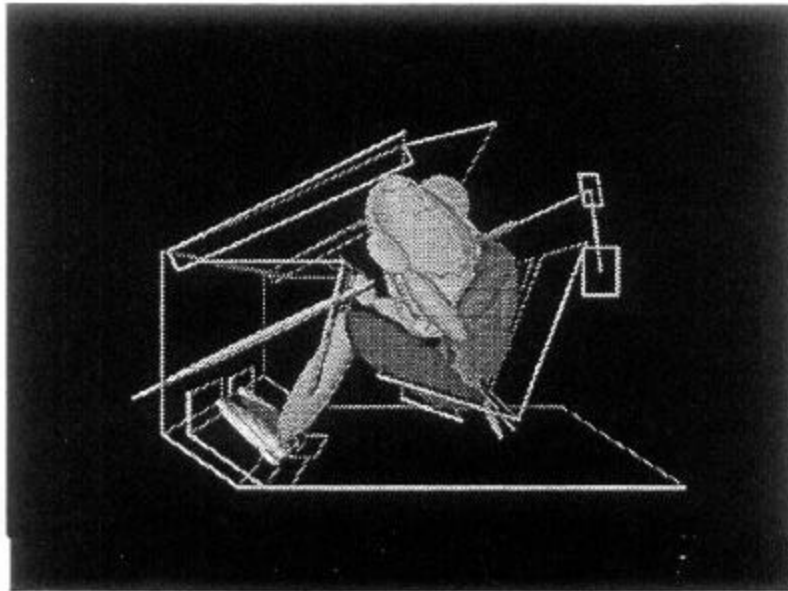

Madymo Kinematic Modeling (Various Occupant Sizes)

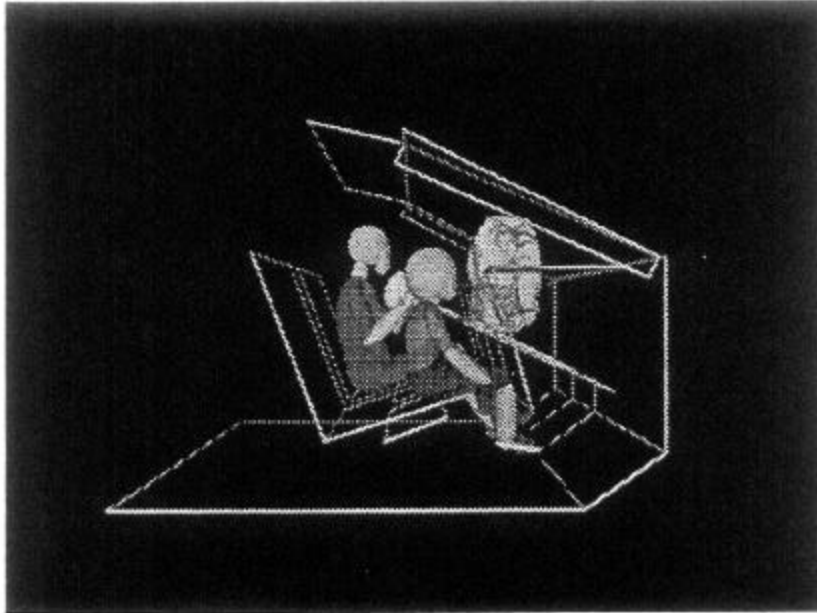

Seat Back Modeling

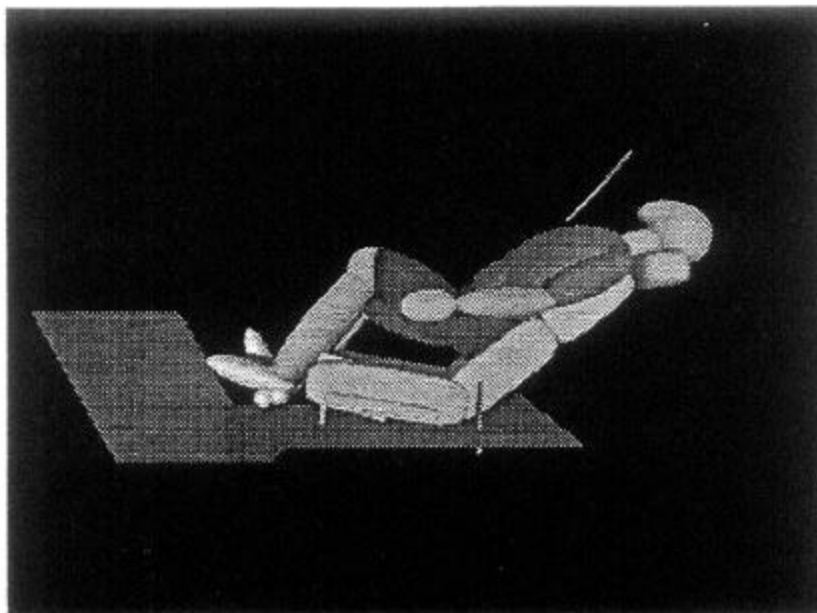

Occupant Restraint

STEPHEN SOLTIS: I might start off by suggesting some things that are comparable between maybe the FRA and the FAA. I'm from the FAA and you might say, "What do aircraft have to do with the rail transport industry?" Well, I think you've certainly seen that the FRA regulates locomotives and we have our version of the locomotive called the Boeing 747. There is something in common. I'm going to talk about occupant restraint and try to use somewhat of a generic approach. I will give examples of what we're doing on the aircraft side of the house and where similar things might be appropriate for all sorts of transportation. I'll address occupant protection system requirements and some design features that you might want to consider in addressing occupant protection systems. I'll give some examples of occupant protection systems themselves, look at head injury and the kinematics of impacts, review a lot of what was discussed by some of the previous speakers, and briefly illustrate some of the benefits of occupant restraint, particularly upper torso restraint systems.

Leading off with some of the requirements and design features that might be considered. I think you have to recognize that crashworthiness isn't only about crash energy management of the vehicle alone. There's a lot of things that go into crashworthiness. It's a systems approach. On an aircraft all of these items shown need to be considered and I think all of these items were addressed in one way or another in the symposium during the last few days. I heard each one of these topics briefly addressed by one or more speakers. Aircraft structure, we're looking at what was called crash energy management in many areas. Aircraft seats, there are also crash energy management considerations there. Restraint systems are part of the crash energy management system. That's the area where I'll concentrate on most during most of my presentation. Interior furnishings. We talked about tiedown strength, whether it's overhead bins, whether it's other components or items of mass within the cabin or other parts of the airplane, and whatever vehicle it might be, it needs to be considered.

I heard several comments about post crash fires and emergency evacuation. That's something we all have in common. We have to be able to evacuate the vehicle after the crash event itself. I have thought about a generic approach and I recalled seeing this at one time. This is something called the five steps to cost effective packaging and product design. Whether you're transporting the carton of eggs that was shown earlier or you're transporting people or children's toys, whatever, these same principles have to be followed. We're transporting people in a container. So you have a product that's being transported in a container. These are the five items that need to be considered in insuring that the product arrives at its destination. And I'll cover each one of these with an example of how we may have done that in the aircraft industry.

The first item being define the environment. We heard several commentators ask the last few days, what do we design to? Are we designing for head-on collisions of 150 miles an hour or 30-mile-an-hour head-on collisions? Are we designing for railroad crossing collisions? What's the environment that we have to design for? That still seems to be an issue that hasn't been resolved. We looked at doing just that. What is our environment? This is one example of some of the work that was done as a result of accident investigation studies. We had a comprehensive accident investigation study conducted where we looked at accident data or accident cases themselves. We tried to estimate what the velocity changes and the acceleration levels were in a particular accident based on perhaps the path of the vehicle itself through the trees, or whatever

else it may have struck. We looked at crash damage and at injuries of the occupants. And for each one of those accidents we plotted a data point. There are several data points not shown in this figure that defines the crash survivability of these vehicles. This particular envelope defines the 95th percentile of survivable accidents boundary. We now have an envelope of velocity changes that we can use to define the crash environment and have an objective. This is what we can design a vehicle to. We want our vehicle to be designed to the 95th percentile survivable impact or the 95th percentile survivable envelope. You see we have selected two points, one which will represent more of the vertical impact condition and one that is representative of longitudinal impact conditions. I'll show what they are. Once our envelope and the impact environment were defined, we selected two test conditions that we thought best represented that envelope. These test conditions were defined not only on the basis of the accident study, we also did full scale crash tests. We also did analytical work.

We compared all these approaches to come up with a common crash scenario or crash impact condition that could be used in occupant protection and designing occupant protection systems. The two test conditions that we defined are now part of the Federal Aviation Regulations. The first condition-it's representative of a crash scenario where you have a large vertical impact velocity. You have a high sink rate. It's an air-to-ground type condition. It's primarily looking at spinal load protection and retention and strength of the seat. The second condition is more of a ground-to-ground type condition. You've got the vehicle on the ground. Perhaps you have an overrun and you strike some obstruction or you abort a takeoff and you strike some obstruction. You experience a large longitudinal deceleration and no vertical acceleration with that crash pulse.

Our crash pulse is defined as a symmetrical, triangular crash pulse and if you're a large transport airplane, the first condition would be a 14g pulse, 35 feet per second. The second longitudinal condition would be a 44-feet-per-second velocity change with a 16g peak. Each vehicle, each class of airplanes, has their own crash signature. I've heard what happens when you crash a cab car with a locomotive-do they have different crash signatures? Well, for all aircraft we have a similar crash pulse. However, the parameters are different. The velocity changes are roughly the same but you have different g levels and different pulse durations. Those pulse durations and g levels are representative of the crash attenuation or the impact energy attenuation of the structure itself. The crash energy management of the vehicle's structure provides that crash pulse. Each size aircraft, each category-rotocraft, small general aviation airplanes, and large transports have their own crash signature. How do you define product fragility? We saw an excellent presentation on some injury criteria and there are a number of ways in which you can look at injury criteria. Some may use the typical Eiband band curves. This is used by some but it's difficult to apply. It's difficult to know where to select the magnitude of the acceleration in a crash pulse. The Eiband curve is not very useable. We find that the occupants aren't really injured traditionally by exceeding whole body tolerance, it's more of an exceedance of regional tolerance.

This figure is based on rotocraft accident studies. In that investigation we found that these regional areas of the body are areas where frequency of injuries are most common. You can see here head, face, upper, lower extremities, spine, thorax and abdominal injuries. We're interested in defining injury criteria that are debilitating or life-threatening injuries. We are more concerned with injuries to the head, perhaps the thorax and the spine. We've developed injury criteria specifically for those areas of the body as part of the pass/fail criteria. You run your dynamic tests and you make assessments of these injury criteria and determine whether or not you've

passed the test. It's not only a structures test it's an evaluation of whether or not the occupant's been injured.

And here's an example of local regional tolerances for the spinal area of the occupant. We've inserted a pelvic load cell in a Hybrid-II dummy. In a vertical impact test we measured the load in the dummy. We compared that to seat pan DRI to define a 1,500 pound pass/fail criteria which is a 7% and 9% probability of injury. That's a direct measurement made during the test for evaluating the potential for injury of a local area of the body. It's an injury mode that accident investigation, accident studies, have shown to be a frequent area of injury.

How do you choose proper cushioning? We've done that in a couple manners. We were looking at spinal injury. We have vertical impacts which are significantly more severe than what you're going to see in the railroad industry. This is an example of an energy-absorbing seat. We might have an overload of the spinal column due to impact. We want to relieve that load. One way of doing that is to extend the crash pulse on the occupant. In this example you can see somewhat this red area that is part of the seat pan. The seat pan is supported by some wire benders that allow it to stroke during the impact. You can alleviate or attenuate some of the impact energy and relieve the spinal loads on the occupant.

Another example of how we might do that is with airbag systems. There are airbag systems being developed for use on aircraft. Head injury is a serious injury-causing mechanism on aircraft accidents and front row seating is one location that's proved to be difficult to provide occupant protection. Striking one's head on galleys, lavatories or whatever might be located forward of front row seating results in striking items not as compliant or not as soft as a seat back. Some of the solutions that are being proposed and developed are airbag systems for those locations.

We need to develop and fabricate some prototype packages. In our case that may be a seat. It may be a prototype of a seat that we want to consider for a particular aircraft. In the past the FAA just had static strength criteria, we didn't have dynamic testing. We didn't have occupant injury criteria. This example shown would probably be all that would be tested, just the basic shell of the seat. Using a loading mechanism not necessarily even a seatbelt, one would demonstrate that they could hold the ultimate load for three seconds and they would pass the test. They would know nothing about injury criteria. They would know nothing about the dynamic response of the seat. That today is inadequate. If you're going to test a prototype, the prototype really has to represent the seat in a complete manner with all of its dressing, cushions, lapbelts and everything else associated with it. If not, when you go to run your dynamic test you're going to get a big surprise.

Here's a typical double row seat that might be used for certification of a Part 25 airplane transport seat. The front row is being subjected to a structures test, the critical case loading. There's another occupant in the double row test here and that occupant is being evaluated for seat-to-seat head injury criteria. This seat is a complete installation with complete dressing. All the seat cushions and everything or the actual items that will be used in the seat are included for certification. Consider the lapbelts. You can't change the lapbelts and restraint systems after certification. It's all part of the system. You've got to certify the system and that's what lives with the product.

We've worked with NASA on redesigning the space shuttle seats. And they went to a point of even dressing the Hybrid-II dummy with one of their survivor suits. You can see the interaction and interface effects of the restraint system with the actual survival suit itself. All these things come into play when you're looking at injury criteria and the overall response of the occupant and the loads in the seat. NASA has taken the step to even simulate the occupant's survival suit itself.

I will show some examples of restraint systems themselves. This might have been a typical one early on. Early restraint systems were really used not to provide crash protection but to keep the occupant from falling out of the airplane. You have open cockpits. You have some turbulence, you might be ejected from the airplane. Turbulence is still a problem today and restraint systems should be worn at all times during a flight. I noticed on the flight coming out, on American Airlines, in their magazine they had the president's article of the month that dealt with turbulence and it suggested that one always wear their lapbelt. They were emphasizing that. From the flight deck the pilot probably gave a 5- or 10-minute talk about turbulence and suggested that you always wear your lapbelt while you're seated. I think the airlines are going to place some more emphasis on wearing your seatbelt whenever you're in your seat. This restraint is what we started off with in the aircraft industry. People were falling out of aircraft due to turbulence or due to maneuvers. One of these early restraint straps, I understand, just came from a piece of luggage. They just put it on the seat. Some of the pilots I understand were afraid of being entrapped in an accident and they would release it upon landing. In doing, they didn't even have any crash protection at all.

This is more like what you might see in today's restraint system designs. This would be for a commuter-type airplane, an observer's seat behind the pilot and copilot. This is what's called a 3-point restraint. It has a lapbelt and a shoulder harness. It goes up to an inertia reel above the occupant's head. Restraint designs have good and bad design features. This, the restraint system, has an awful long length. There may be a lot of stretch in the restraint system for the upper strap goes up at a very shallow angle. This one doesn't pass over the shoulder at a reasonable angle. We recommend 5 degree down to a 30 degree up angle as an optimum restraint system takeoff angle from the shoulder. In this case you may have a very poor performance for it allows the occupant to move forward because of the webbing stretch. Plus by the time the webbing takes a shape that can resist the load, you're practically off the seat. So 3-point restraint are good but you don't want to have a lot of webbing hanging out of the inertial reel when you use them.

This is another 3-point restraint system that's more typical of what should be done. You can see it ties close to the shoulder. It doesn't have a big takeoff angle. It doesn't have a lot of excess webbing. The restraint system comes essentially over the center of the chest so you're not going to roll out of the restraint system during the impact. It also ties to the lapbelt on the side so you're not going to pull the lapbelt up in the center. If you have a center attach point, the restraint pulls up in the center and you could submarine out of the restraint system. This one looks like a reasonable design.

Here's what's called a 4-point system. It has a double upper torso belt and a rotary buckle release in the center. This restraint might have a tendency of pulling the buckle up and could have a tendency for submarining. Some people would have a tie-down strap in the center that would go down to the seat or tie around the thighs of the occupant to prevent that.

And last but not least another 4-point system. This is a common restraint system found on flight attendant seats. You have a lapbelt and a double shoulder harness on the occupant. The lapbelt and shoulder harness are a continuous piece of webbing. The buckle is in the center and the webbing comes down to a loop here that ties to the seat structure, wraps around and goes into an inertia reel. You can don this system relatively easy. You put on the lapbelt. You grab the two shoulder belts, that snugs up your lapbelt. The inertia reel then retracts the excess webbing and you're pretty much in the seat. You just stick your arms right in the upper torso restraints when you occupy the seat. When you load the lapbelt during a crash or crash impact, since the webbing is a continuous loop up through the upper torso restraint system, the restraint also snugs your shoulders at the same time. Also as you try to move out of the restraint, your shoulders will also be pretensioned and moved back, restrained in the seat.

I'm going to talk about occupant injury and the kinematics of impacts. The previous presenter from CALSPAN did an excellent job of presenting some of the similar information that I'm going to show here. So I'll go over it probably quite briefly. I think you've seen a figure something like this earlier. An example of a velocity time history of a crash impact. Here's the velocity change of the vehicle. The vehicle crashes here. It starts decelerating and the velocity is arrested at this point. The occupant being unrestrained, moves forward and in this example doesn't strike anything until the vehicle has come to rest. Then he has a 3-inch stopping distance from whatever he struck. Ideally, if he was bonded to the seat and the seat was rigidly attached to the airplane he would see a 15g impact. Now he's subjected to a 120g impact due to free floating in the cabin until he strikes something relatively rigid. A 120g impact would most likely produce an HIC value of greater than 1,000. The occupant would probably suffer a head injury and perhaps a number of other injuries along with that.

This is just another example, where you have a restraint system, but the restraint system is not perfect in any manner. Again you use the same type of crash pulse. The vehicle crash pulse comes down this slope here. The vehicle stops in 24 inches and your restraint system starts becoming effective here and you stop really in a 12-inch stopping distance. Half the vehicle's stopping distance. You can see you're going to have double the vehicle's deceleration. If you can extend the stopping distance with the restraint system to equal the vehicle's stopping distance, of course, you can see you're going to be decelerated at a value identical to the vehicle's deceleration. So the restraint system ideally can hold you into the seat and minimize your dynamic overshoot and make you more likely see the acceleration levels that the vehicle is going to see. If you are ejected from the seat you will see a much higher acceleration level when you strike some surface in the vehicle. And what's important in striking that surface is how far you travel and what the relative velocity change is between you and the vehicle, as was illustrated in one of the earlier figures. I have an example of that too, how velocity change can really affect things. Velocity change is really one of the most important parameters that you really want to consider. You want to control the velocity change between you and the structure that you're striking.

These are some tests that were done at the Civil Aeromedical Institute in Oklahoma City. The FAA has a dynamic test site there. We do a large number of dynamic tests there almost on a daily basis. We were at one time planning to do some for Amtrak. I think the people here are interested in doing seat developmental testing. We participate in the development of seats and new technology. We charge no fee. We typically don't do certification tests. In this test setup we're looking at head impacts and kinematics of head impacts. These three bottom tests are

typical of a certification test, the 16g longitudinal test required for Part 25 airplanes. The first test represents striking a galley or lavatory wall that has basically no changes to the structure. And you can see you exceed HIC of 1,000. Here we induce some fracture mechanism. We scored the surface of the wall panel we're striking to reduce the stiffness and we were able to obtain an HIC value less than 1,000. This is a case where we had no wall forward of the occupant. We had no head strike.

This is just a schematic of what a test setup looked like. Here again is our seat. Here's the panel we were striking during those tests. And this 35 inch is the typical setback that you find in front row seating on large Part 25 airplanes. Most of these tests were done evaluating those types of impacts. We've solved the aircraft seat-to-seat head strike problem. We're now working on trying to come up with a number of solutions for occupant front row seats, with head strikes on galleys and lavatories, whatever may be facing the occupant. I show this to illustrate that just putting on a lapbelt isn't enough. These test devices were restrained by lapbelts but the upper torso was not restrained. You find with this clearance, the 35 inches as shown, with the 44-foot-per-second crash pulse you're going to incur a head strike velocity that's very near what the initial velocity of the test was, the 44 feet per second. You're going to get a very large head strike velocity and as a result you have a very large head acceleration and a high HIC value, I think here it was 1182. Just putting on a lapbelt hasn't protected this occupant. Again, it's a systems approach. You need to consider the environment around the occupant. You have to de-lethalize the cabin itself. You need to provide energy-absorbing material for head strikes. You need to minimize your head strike velocity.

This is a head strike velocity time history curve for those tests. You can see this is where the 35-inch dimension is. It just so happens that's around the peak head strike velocity. It's probably the worst place you could put that wall if you had to make a selection. If you want to minimize the head strike velocity you could certainly move the wall closer and have a much lower head strike velocity and lower HIC. You could provide some energy absorption means at this location and again reduce head strike velocity.

Another means of preventing and minimizing head strike velocity would be restraint systems. I mentioned the upper torso restraint. As with the lapbelt, you still have a large head strike envelope and you can still develop large head strike velocities. So if you're going to place this occupant anywhere in a vehicle you want to place whatever is forward of him so that his head clears it. You don't want a head strike. The other way you can do that is if you go to different types of restraint systems. You can see here an upper torso/lapbelt restraint. With an upper torso lapbelt restraint, you restrict the head motion somewhat so now you can place something closer to the occupant and not have a head impact. You've not only changed the head strike velocity profile, you've changed the displacement profile.

Means of preventing head strike motion have been considered by the military to the point of requiring 5-point restraint systems. They have what they call an "IBARS" bar system which is the acronym for the title here. It's sort of mini-airbags underneath the restraint systems. It senses the impact, the bags blow up and they seat the occupant in his seat. The occupant rides this impact down as part of the seat as a unit. There's no slack in the restraint system to get dynamic overshoot and thus high g levels. And it minimizes your head strike envelope and potential for head strikes.

Are there any benefits for using lapbelts or upper torso restraint systems? Well, I think benefits for lower restraint torso systems are somewhat obvious. I think you can ride in automobiles or any vehicle without lapbelt restraint systems and you might be involved in an accident and maybe you might survive. You might go outside and be struck by lightning and you might survive but I wouldn't recommend that, either.

If you look at the effects of upper torso restraints where this figure is part of a rotocraft accident study, this is showing the velocity change envelope, longitudinal and vertical velocity changes, that defines the envelope for survivable rotocraft accidents. This red area is the area where we have serious injuries. Here you might have the onset of serious injuries. Here you have a minor injury in this shaded band. When you put on an upper torso restraint system you expand the area of minor injury. You can now withstand longitudinal impacts up to the limits of the velocity change envelope, the impact envelope. You've greatly expanded the region of the onset of serious injuries and significantly reduced the area of serious injuries themselves. Upper torso restraints can be very effective.

We also had an NTSB study that was conducted when we were developing standards for Part 25 airplanes. In 1983 the NTSB went out and looked at a number of small Part 23 airplane accidents. This was a dedicated research effort where they wanted to look at the occupant injuries that occurred during those accidents. They made some assessment of what would be the benefit of those occupants having upper torso restraints or shoulder harnesses in those vehicles. Upper torso restraints were not required in small Part 23 airplanes until 1986. So this data is prior to widespread usage of upper torso restraints as a requirement. Some vehicles did have them, but others didn't have them. In this example, the database has 214 fatalities. They looked at and studied the injury mechanisms associated with those fatalities. And it was found that if those occupants had upper torso restraints perhaps there would have been only 51 fatalities. Some of the fatalities would have been serious injuries, 106 of them, and 57 perhaps would have had minor or no injuries. They looked at serious injuries and then broke those down to where 49 might have had serious injuries and 180 of them would have minor or none. And as a result of this they showed that perhaps 364 of the 443 subject occupants would have benefitted or 82% of the occupants of those vehicles would have benefitted. The injury or fatality levels would have been reduced significantly. The use of upper torso restraints would have been beneficial to 82% of those occupants.

Some brief closing comments. Looking at occupant restraint, remember it's a systems design approach. You've got to look at the impact environment and look at who is the user of the restraint system. Delethalize the area around the head strike envelopes and so forth. It's not just put a restraint system on and hope it works. It's a complete systems approach. In designing and installing occupant restraint systems you need to recognize that they can have some undesirable attributes. Avoid undesirable webbing takeoff angles. You don't want to develop large loads resulting from undesirable webbing takeoff angles that load the chest cavity and the chest structure of the occupant. The FAA does have a pass/fail criteria that assesses that. You don't want to roll out of the restraint system. There are a lot of features that you need to look at in designing occupant restraint systems. You want to prevent and minimize head strike hazards. Head strikes are one of the leading causes of all types of fatalities and serious injuries. If you could minimize or prevent head strikes, I think you'd go a long way to preventing fatalities and serious injuries. And restraint systems can do that. That concludes my presentation.

I have two brief videos I think I have time--five minutes maybe or less. This is an example of what's called a 16g seat test. The occupant in the back had his restraint system fail, it wasn't installed properly. This example shows the effects of what's going to happen with no restraint. Well, we're going to capture the occupant with the seat forward of him. If we don't capture him with the seat forward you can see he's going to travel forward until he strikes another object. I think Chris Severson is going to show some tests that she ran. I'm not sure, I'm only speculating. She did her tests on a high g facility where the crash pulse is imposed by acceleration during the test. This is a deceleration type device. The occupant has residual velocity. You can see he's going to travel forward. In the test that Chris will show, the occupant, if he was in the front row would strike the seat back here. But the occupant essentially just falls forward and it wouldn't have looked very severe at all. That's essentially a nonrestraint condition.

And here's some examples of different restraint systems themselves. What I'd like you to take note of is the head strike envelopes that are associated with these different types of restraint systems. It should be plain. That's a typical lapbelt. You see how far forward the head and the occupant move in this type of restraint system. Typically 45 to 48 inches. This is the one I described earlier that I mentioned had the very high inertia reel location and it didn't provide very effective restraint. You can see that's clearly illustrated here. That was not accepted in certification tests. That restraint system was redesigned. This is one with upper torso restraints. This is a typical 4-point where we've got a restraint strap over each shoulder. A typical flight attendant restraint system will look like this. See the head strike envelope has been minimized in this case. If there are any questions I'd be happy to try to answer them.

BOB GALGANSKI: Bob Galganski, CALSPAN. Does the FAA have any plans to require that the airlines implement some use of minimal crashworthiness protection in the cabin; for example, maybe some padding on the sidewalls. When you're riding on a plane you're bouncing around and your head will sometimes hit that plastic inner wall. Are there any requirements--is anybody looking into that?

STEPHEN SOLTIS: We do have requirements regarding the interior of the airplane specifically the head injury criteria. We're conducting dynamic tests of seats yawed so you can evaluate those types of strikes. I think as was earlier pointed out you're going to get head injuries with large head strike velocities. You might strike your head on the side wall of the airplane but you're not going to have a very large velocity change typically in that direction in an aircraft accident. So it might smart a little bit. You might get a headache but you're probably not going to have a serious head injury. Where you're striking things forward of the front row seats, galleys and lavatories and things of that nature you're getting large impact velocities. We do have requirements namely the seat dynamic performance standards where that is evaluated during dynamic tests. I think as you pointed out a little bit of padding doesn't do anything. If you're going to have a large head strike velocity you need a large stopping distance. With the head strike velocities we're seeing I think the stopping distances required are four or five inches.

FRANK CIHAK: Steve, I'm Frank Cihak from the American Public Transit Association. I notice in most of the material you showed you had initial velocities on the order of 40 or 50 feet per second. Can you tell us how those came to be?

STEPHEN SOLTIS: They came to be as a result of accident investigation studies where we used the results of some NTSB data and also special studies that the FAA sponsored that were

conducted by Boeing, Lockheed, Douglas and Simula Corporation as part of their study for Rotorcraft. They went out and investigated accidents and tried to develop crash scenarios. What's a typical survivable crash scenario? We had to define what is a survivable accident. A survivable accident--there's two criteria you need to look at. What are the loads imposed on the occupant? What's the acceleration level? That's one criteria that needs to be addressed. And the other is to maintain a protective shell. We've said as long as the protective shell is maintained that should be considered a survivable accident. We've looked at that. We've defined two crash scenarios. One was an air-to-ground impact. That had a very high sink rate. And the other was sort of an overrun condition whether it be a takeoff or landing. Then we had to quantify those crash scenarios. We quantified them by using estimates of the accident investigators of what the velocity changes were during the impacts. And what you're seeing here is the velocity change. Not necessarily the landing velocity for example, if it's air-to-ground or if it's a ground overrun. You strike something but you don't stop dead like you might have with your head-on collision with the locomotives. But you strike something, you have a crash pulse and then you have some slide out subsequent to that.

There are estimates made during accident investigation where the velocity changes are estimated using some analysis. We also have modeled airplane accidents, validated those models and exercised those through a variety of crash scenarios and developed crash pulses that way. We compared them to what was estimated in accident investigations. We also have a series, in smaller planes, of full-scale crash tests. Some were done at NASA on a sling test facility where they have both longitudinal and vertical impact velocities. We've done some at the FAA's Tech Center, primarily vertical impacts. We have data from a couple of transport airplane, full-scale crash tests that we've done, one in 1965, one in 1984. We have transport airplane fuselage section, both longitudinal and vertical, impact tests that were conducted. These data were all used to develop some crash pulses, both the analytical and full-scale tests. We approached it three different ways. And we made our best judgement. This is a representative crash pulse for this class of vehicle. Every vehicle will be a little bit different.

AUDIENCE ATTENDEE: I've got a question I've been meaning to ask somebody for years now and you're the first person I can actually address on this. I know the seat backs on the planes have been padded for awhile, they give you some head injury protection. Over the last several years I have found myself sitting in a plane with a telephone sitting in front of my face. Are those phones designed for any protection capabilities or should I avoid the middle seats on these planes?

STEPHEN SOLTIS: Well, there's two answers to that. There's two categories of seats in airplanes now. The seat dynamic performance standards pertain to newly certificated airplanes. For Part 25 airplanes, that's after June 1986. If you're in a new airplane like a Boeing triple 7, those seats and cabin interiors have to meet the head injury criteria. For that configuration, that phone set will have to be tested. You might recall that I said when you test prototypes that you just can't test the shell. Everything has to be on that seat. You can't change restraint systems. You can't change cushions that might affect your energy absorption in a vertical impact. If you have a phone set in there you have to test with that phone set in the seat. You may strike the phone set but typically they are installed high and you're going to miss it. Because the seat back will move forward due to its own inertia, you're going to strike lower on the seat. Typically you'll miss the phone set. But if you did strike it that needs to be evaluated on the new airplanes. On the old airplanes they just use the static design requirements. They can retrofit the old type

seats in the old airplanes. There's a procedure they call the bowling ball test which is an instrument, a bowling ball, that by test they make some assessment of whether or not it's good, bad or indifferent on the older seats. It's not as comprehensive as the HIC evaluation. Everybody is putting new seats in current airplanes, whether it's an old generation airplane or not. They're putting in the 16g type seats in anticipation of a retrofit rule that the FAA should release maybe some time this year.

TOM PEACOCK: We're running a little behind so maybe we better hold any other questions for the panel discussion. Let's take a ten-minute break.

PRESENTATION

OCCUPANT RESTRAINT

Symposium on Rail Vehicle Crashworthiness

Volpe National Transportation Systems Center
Cambridge, Massachusetts

Occupant Restraint

Stephen Soltis

Federal Aviation Administration

Occupant Restraint Overview

Occupant Protection System Requirements/Design

Examples of Occupant Restraint Systems

Occupant Head Injury/Kinematics

Benefits of Occupant Upper Torso Restraint Systems

Occupant Protection System Requirements/Design

**Elements of Crashworthy
System Design**

Airframe Structure

*Strength
Impact Attenuation*

Interior Furnishings

Tiedown Strength

Aircraft Seats

*Strength
Occupant Injury Criteria*

Post Crash Fire

*Fuel Containment
Ignition Sources*

Emergency Evacuation

Availability of Exits & Paths

**Five Steps to More Cost Effective
Packaging and Product Design**

Define the Environment

Define Product Fragility

Choose the Proper Cushioning

Design and Fabricate the
Prototype Package

Test the Prototype Package

**Five Steps to More Cost Effective
Packaging and Product Design**

Define the Environment

Define Product Fragility

Choose the Proper Cushioning

*Design and Fabricate the
Prototype Package*

Test the Prototype Package

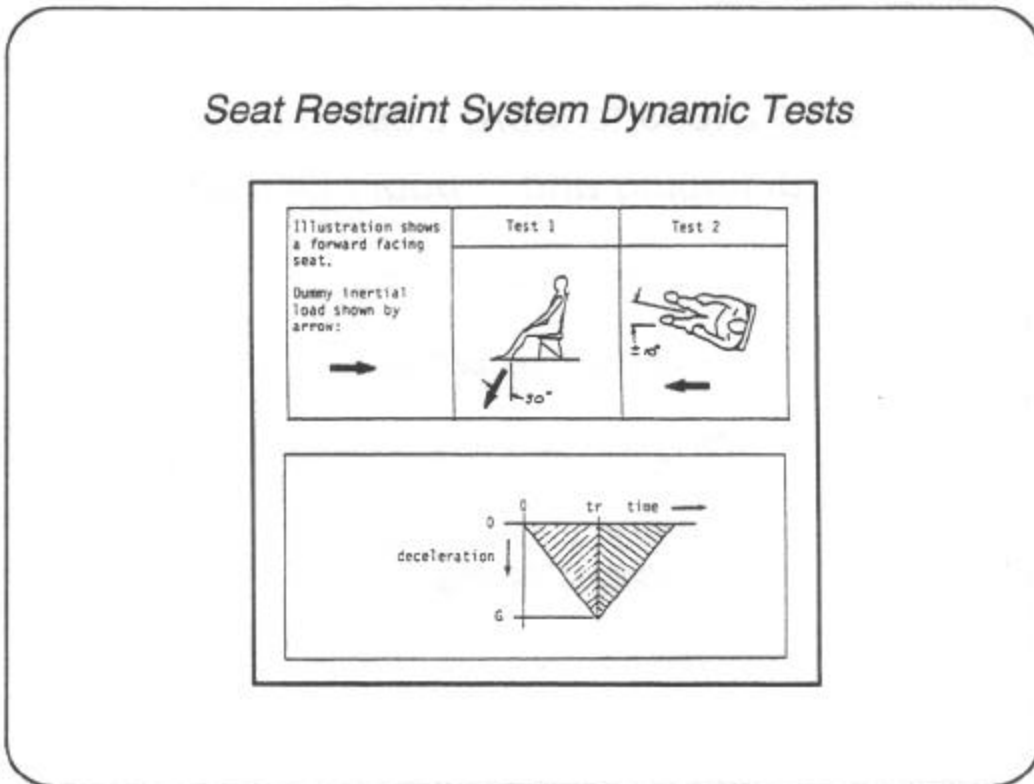
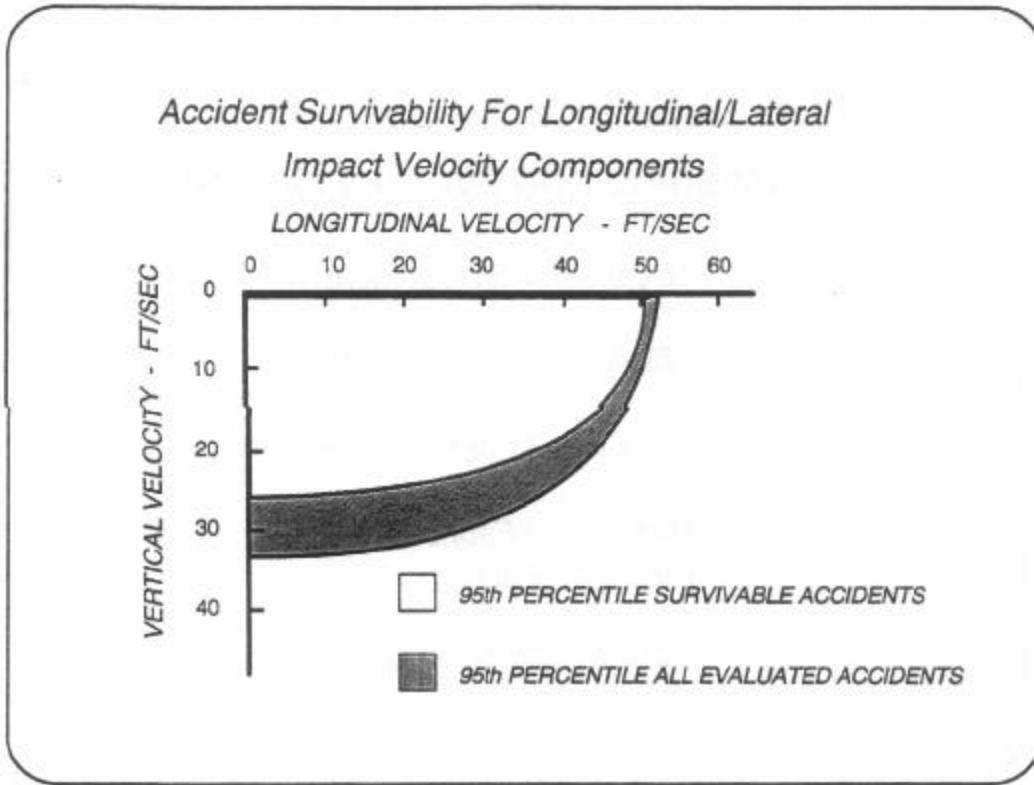

Five Steps to More Cost Effective Packaging and Product Design

Define the Environment

Define Product Fragility

Choose the Proper Cushioning

*Design and Fabricate the
Prototype Package*

Test the Prototype Package

*Duration And Magnitude Of Spinward Acceleration
Endured By Various Subjects*

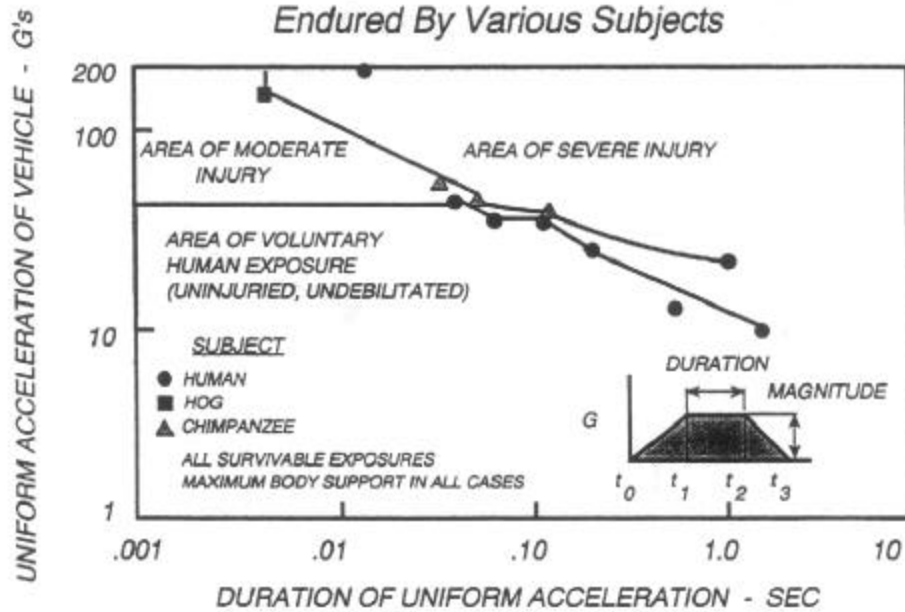

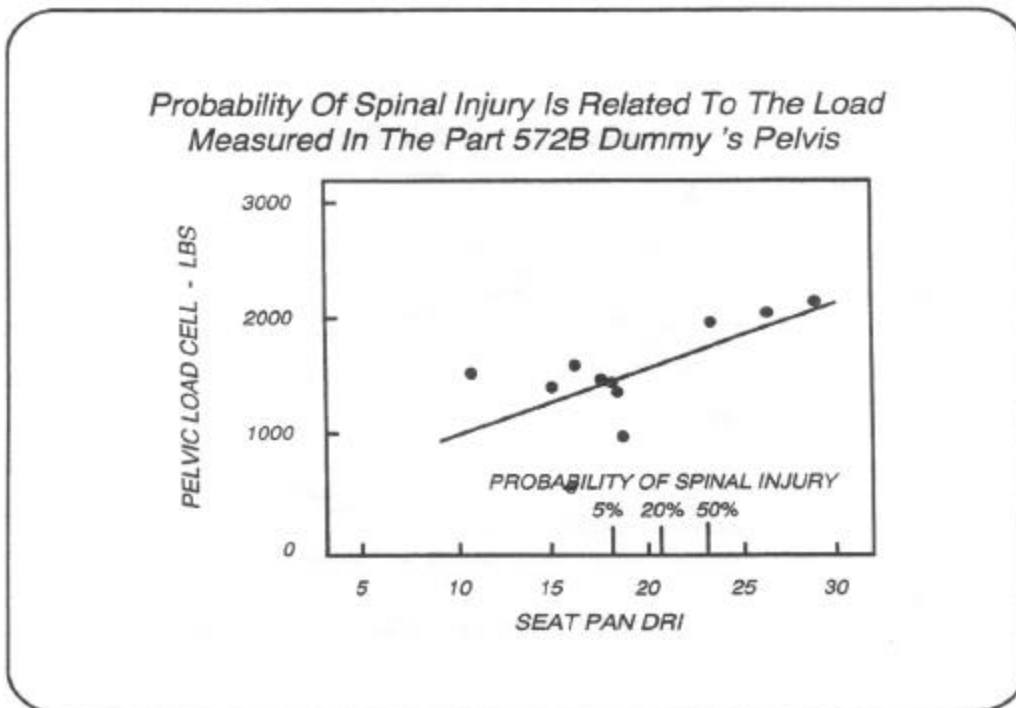
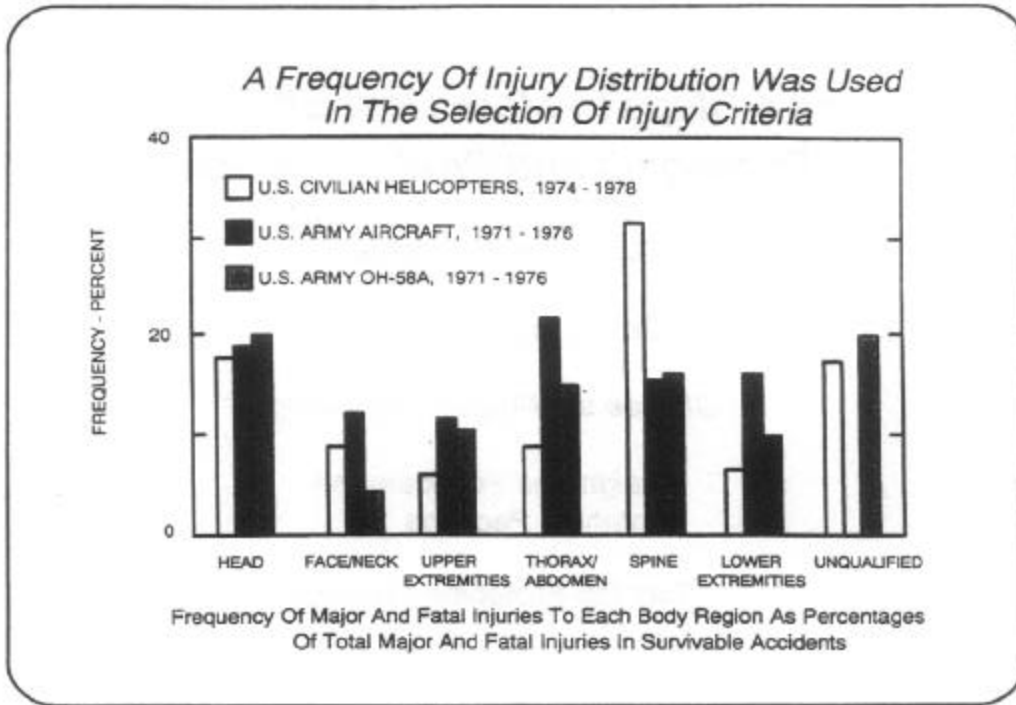

*Five Steps to More Cost Effective
Packaging and Product Design*

Define the Environment

Define Product Fragility

Choose the Proper Cushioning

*Design and Fabricate the
Prototype Package*

Test the Prototype Package

CAMI Energy Absorbing Seat Structure

Provides Spinal/Pelvic Load Impact Protection

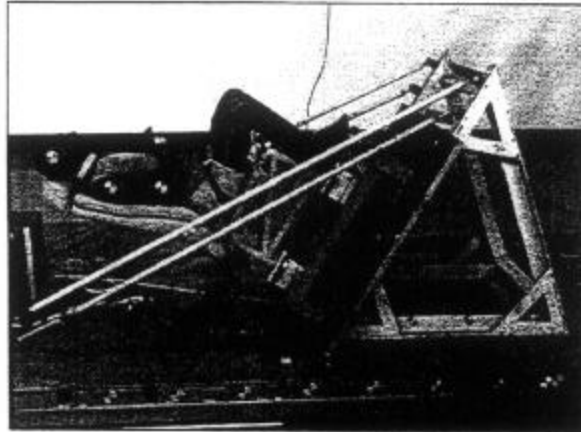

Airbag Systems May Provide Head Impact Protection

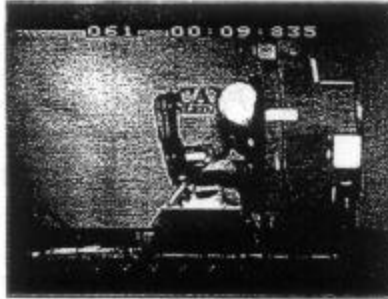

*Five Steps to More Cost Effective
Packaging and Product Design*

Define the Environment

Define Product Fragility

Choose the Proper Cushioning

*Design and Fabricate the
Prototype Package*

Test the Prototype Package

Prototype Test Specimen

Needs To Include Complete Dressing And Restraint System



*Five Steps to More Cost Effective
Packaging and Product Design*

Define the Environment

Define Product Fragility

Choose the Proper Cushioning

*Design and Fabricate the
Prototype Package*

Test the Prototype Package

Certification Test Specimen

Includes Complete Dressing And Restraint System



Certification Test Specimen

Includes Complete Dressing And Restraint System

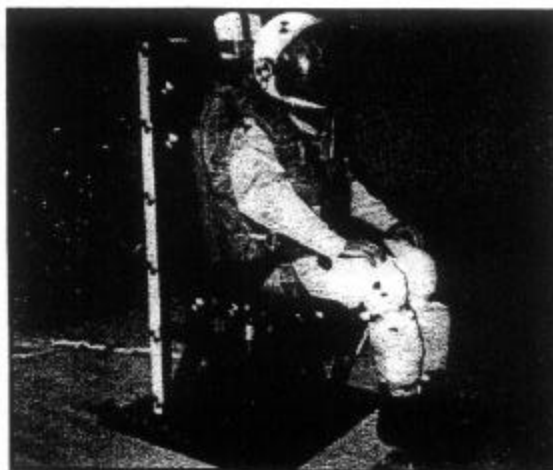

Examples of Occupant Restraint Systems

Early Aircraft Occupant Restraint System

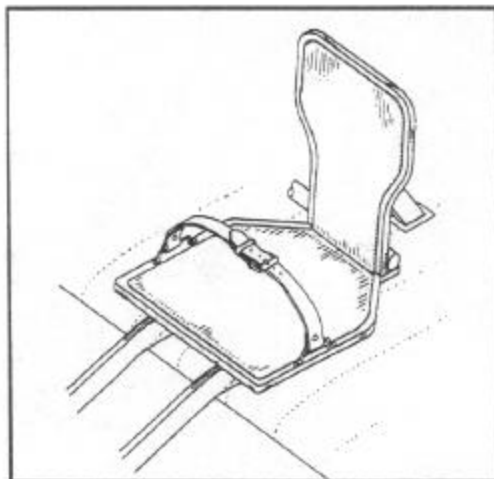

III-3-23

Typical Aircraft Restraint System

Three Point

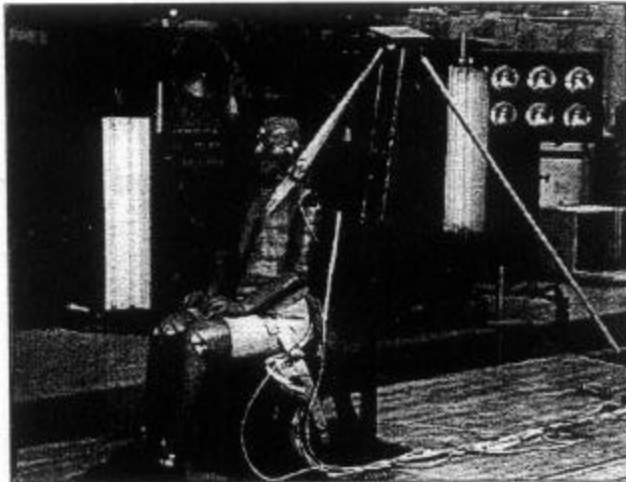

Typical Aircraft Restraint System

Three Point

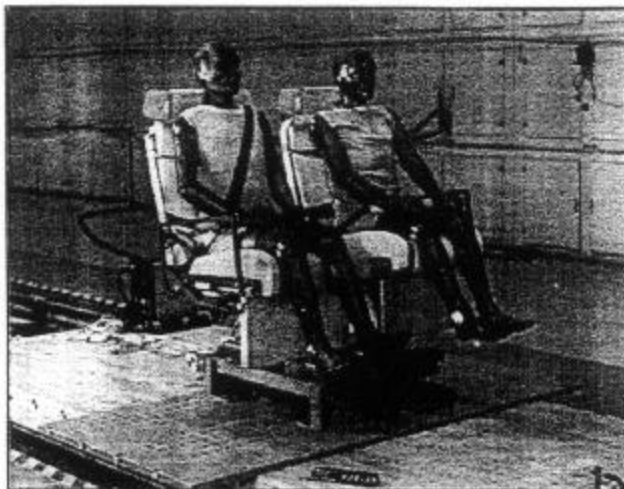

*Typical Aircraft Restraint System
Four Point*

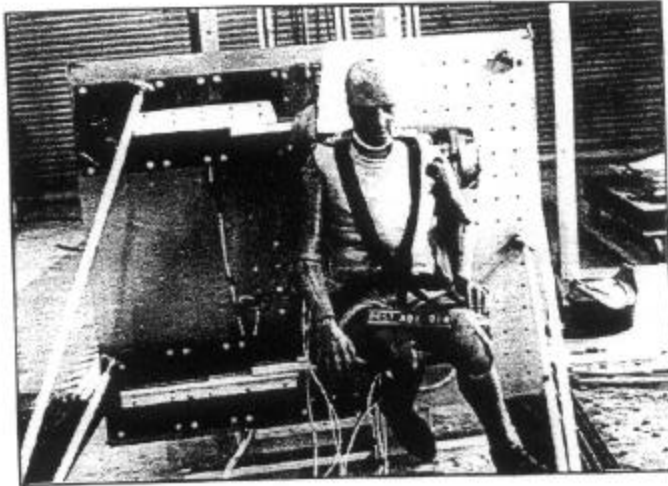

*Typical Aircraft Restraint System
Four Point (TARC)*

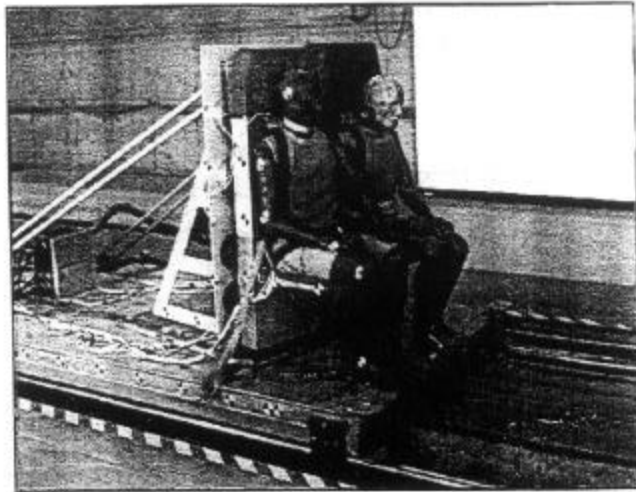

III-3-25

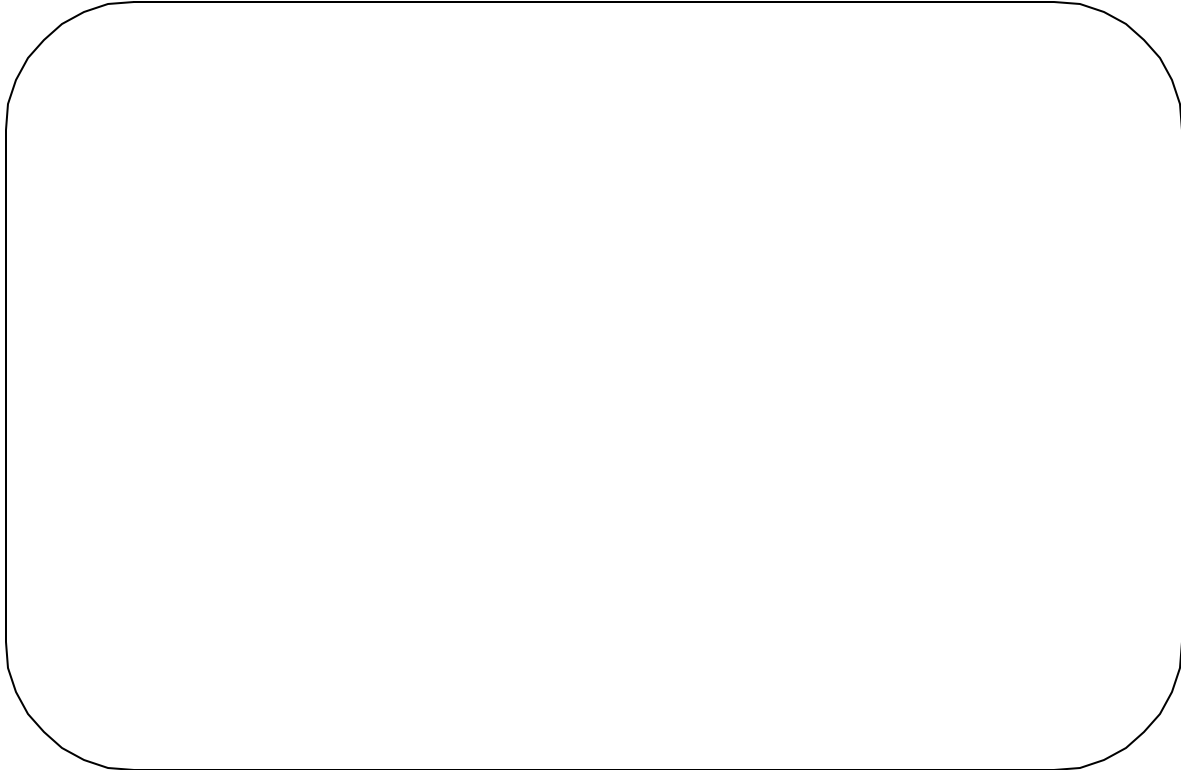
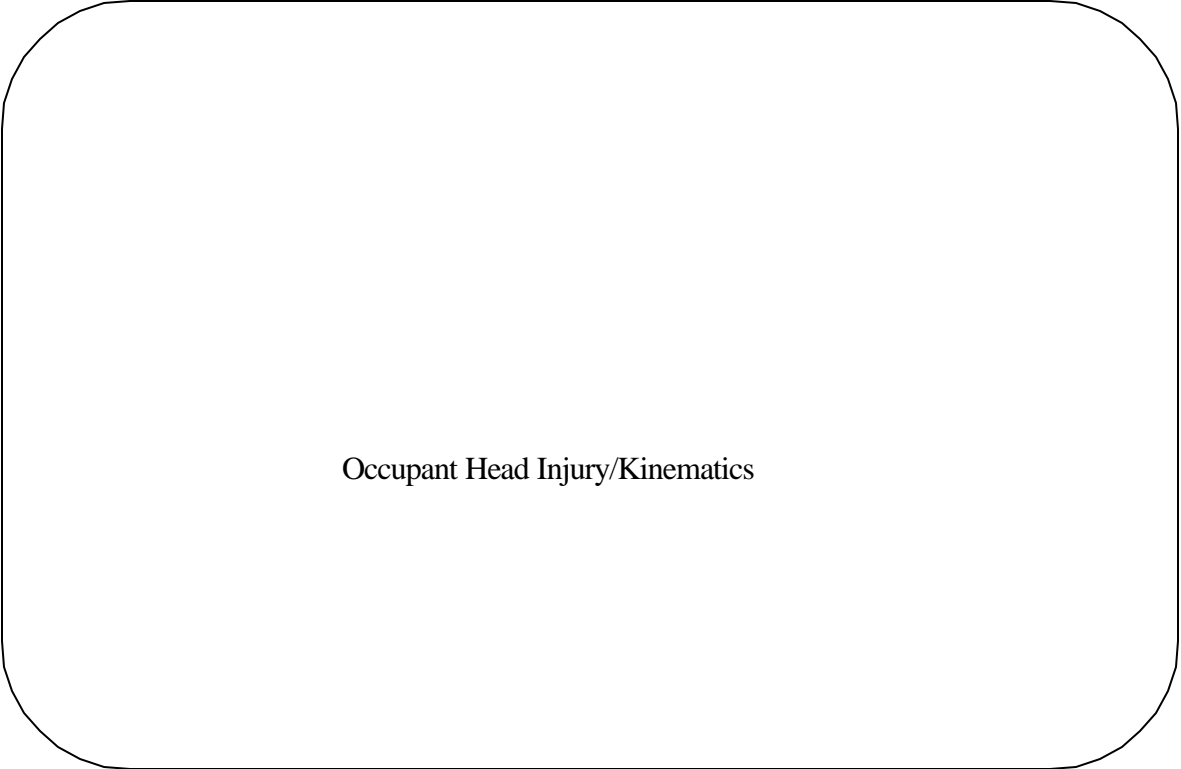

Example Impact Vehicle/Occupant Time History

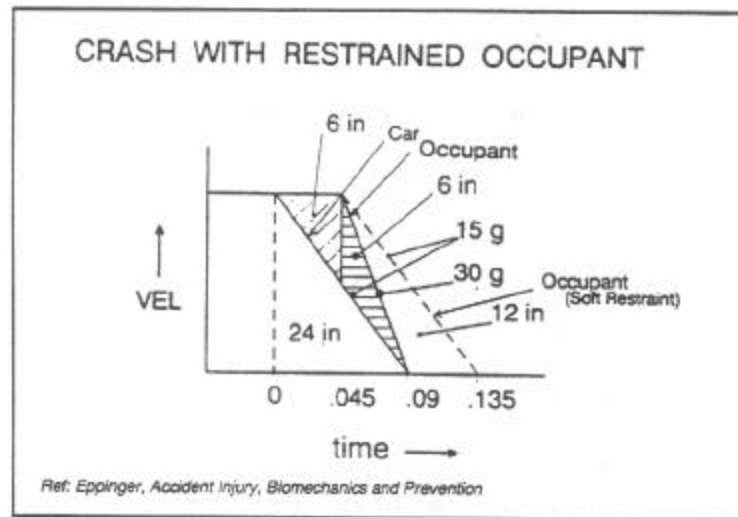

CAMI Head Impact Kinematics Evaluation

Ref: Report DOT/FAA/AM-92/20

Test Number	Pulse Shape	Sled		Head Contact**		EIC	Note.
		Gpk (G)	Vel. (ft/s)	Vel (ft/s)	Time (sec.)		
A91058	Trapezoid	-7	20.7	----	----		1
A91062	Trapezoid	-7	44.7	36.5	.132	749	
A91064	Triangle	18.5	44.9	41.4	.126	1120	2
A91065	Triangle	16.9	44.9	41.3	.125	862	3
A91082	Triangle	16.7	45.1	46.1	.123	---	4

- Notes. (** Contact after onset of pulse)
1. The ATD's head barely glanced wall, no significant impact.
 2. An unmodified panel of Nomex used as strike panel.
 3. Modified Nomex panel by cutting slits in laminate on strike face of panel. This was done to reduce stiffness.
 4. No strike panel, velocity and contact time at place of wall.

CAMI Head Impact Test Set Up

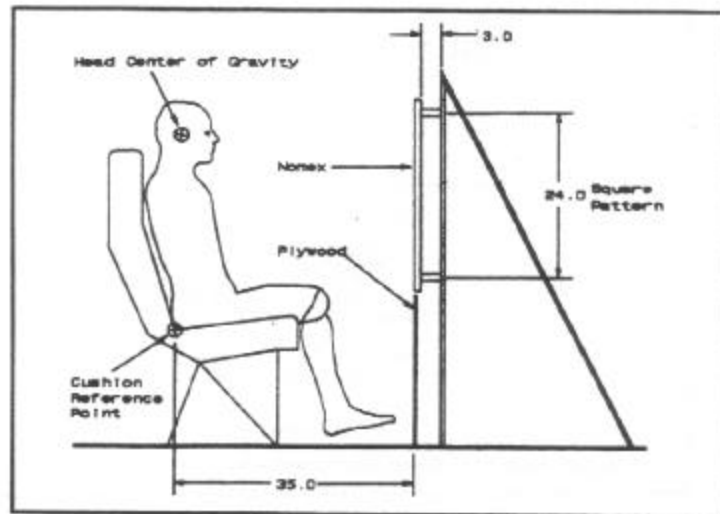

CAMI Head Impact Kinematics Evaluation

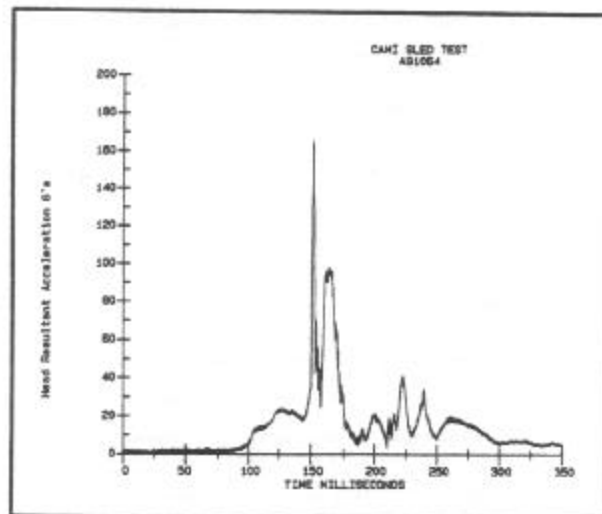

ATD Head Velocity Time History

Ref: Report DOT/FAA/AM-92/20

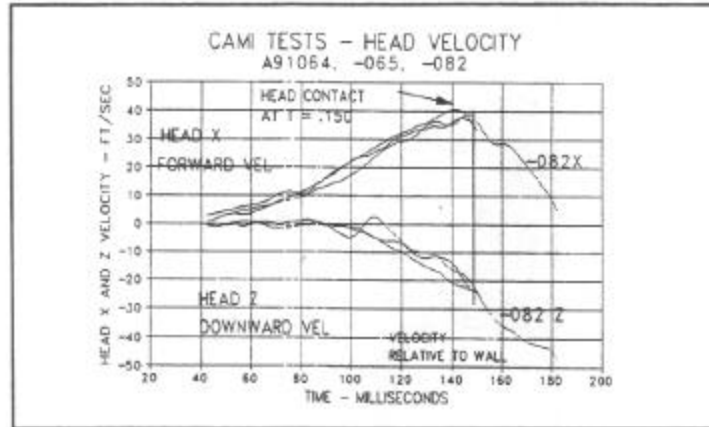

Lap Belt Only Restraint Extremity Strike Envelope

Side View (Ref: USARTL-TR-79-22A)

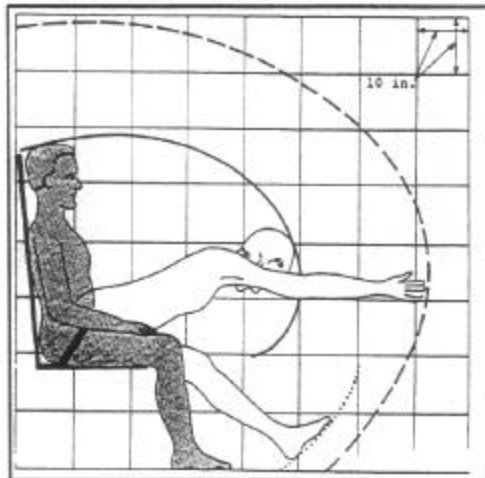

Full Restraint Extremity Strike Envelope

Side View (Ref: USARTL-TR-79-22A)

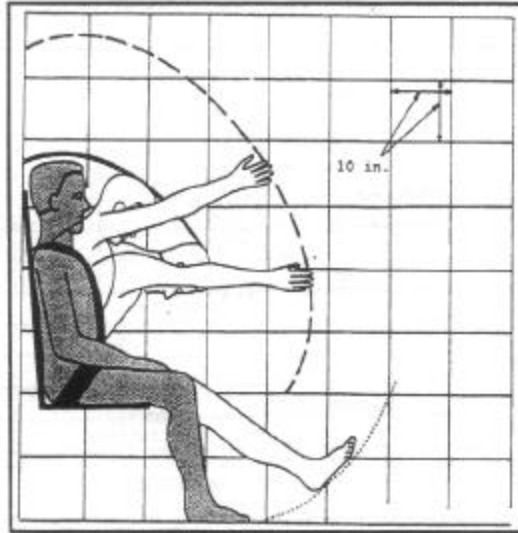

Inflatable Body and Head Restraint System

IBAHRS (Ref: USARTL-TR-79-22A)

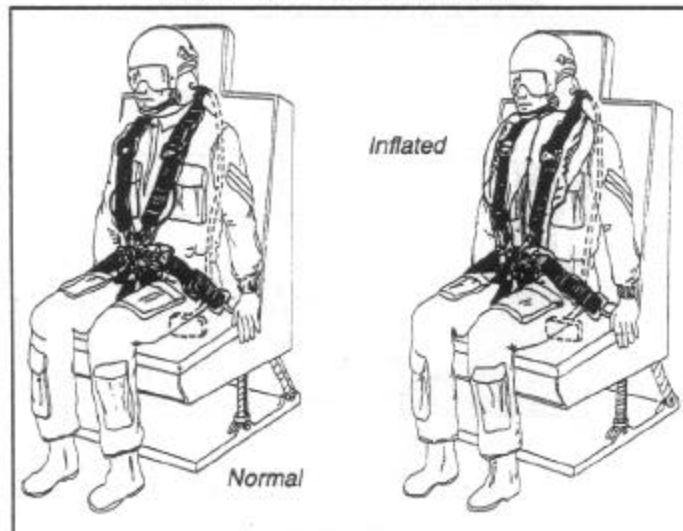

Benefits of Occupant Upper Torso Restraint Systems

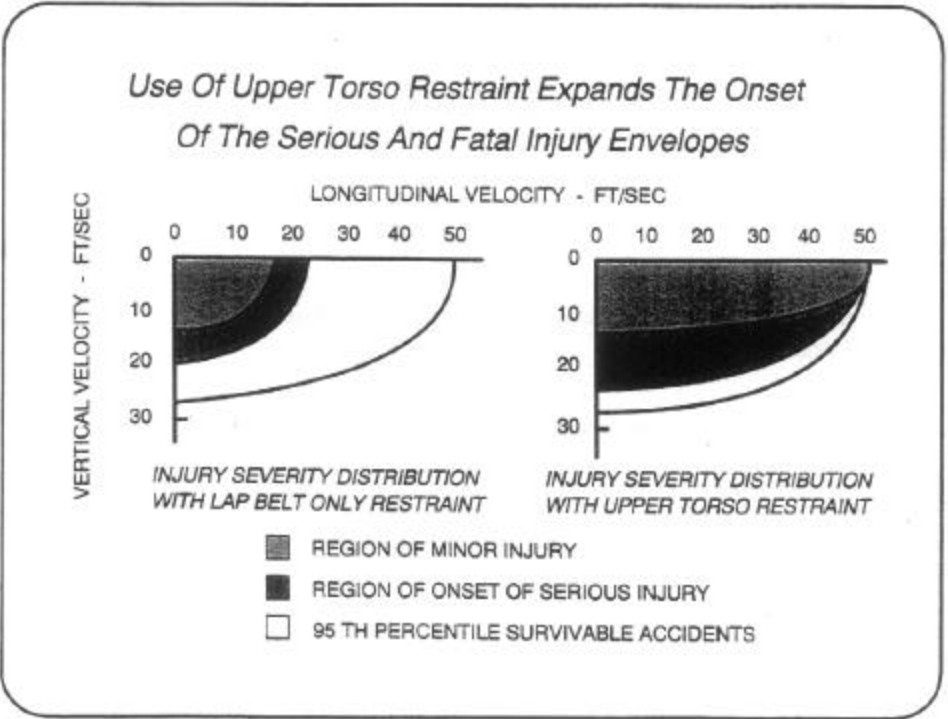

**Occupants in Survivable Accidents
Potential Benefits of Shoulder Harness Use**

ORIGINAL INJURY DISTRIBUTION	EXPECTED DISTRIBUTION WITH SHOULDER HARNESS	PERCENT
FATAL 214	FATAL 51	24
	SERIOUS 106	50
	MINOR/NONE 57	26
SERIOUS 229	SERIOUS 49	21
MINOR/NONE	180	79
MINOR 63	MINOR 32	51
	NONE 31	49
TOTAL FATAL and SERIOUS 443	TOTAL WHO BENEFITED 364	82

THE 364 NUMBER IS COMPILED FROM THE 106 OCCUPANTS CODED FATAL TO SERIOUS, THE 57 OCCUPANTS CODED FATAL TO MINOR/NONE, THE 180 OCCUPANTS CODED SERIOUS TO MINOR/NONE, AND THE 21 OCCUPANTS OUT OF 49 WHO WERE CODED SERIOUS TO SERIOUS BUT WOULD HAVE HAD LESS SERIOUS INJURIES.

Conclusions

Proper Occupant Restraint Requires a Systems Design Approach Considering the Impact Environment and the Intended User

Occupant Restraint Systems May Possess Desirable and Undesirable Attributes

Prevention Occupant Head Injury Requires Both Occupant Restraint and an Evaluation of Head Strike Hazards

Occupant Restraint Systems Can Minimize or Prevent Serious Injuries and Fatalities

Passenger Response in Train Collisions

MODERATOR: Kristine Severson.

KRISTINE SEVERSON: Good afternoon. It looks like the group's gotten a little bit small, but I'll try not to take it personally. My talk today covers research conducted here at the Volpe Center in the area of passenger response in train collisions. The work was performed by David Tyrell, Brian Marquis, and me. Before I go into passenger response, I'll give you a bit of background information about our research effort.

Here at the Volpe Center, we began looking at interior crashworthiness of trains about two years ago. This research was in support of the FRA and their discussions with Amtrak regarding the high speed trains in the Northeast Corridor. We were interested in evaluating the crashworthiness of both the structure of the trains, and preserving occupant volume, as well as the interior of the trains and providing a friendly interior to help limit the force and acceleration that the occupant experiences in the collision, and we recognize the trade-offs between these two different design objectives.

The primary objective of interior crashworthiness is to limit the forces and decelerations that an occupant is subjected to in the event of a train collision. These forces arise when an occupant makes contact with some part of the interior, and they can be minimized by connecting the occupant with the interior as quickly but gently as possible, and basically this is what we're trying to accomplish when we design the interior.

During the presentation this afternoon, I'll first cover the interior collision dynamics. Next, I'll cover three different methods of evaluation that we used here at the Center in our research, each with increasing fidelity. First, there was a basketball model which we used to calculate secondary impact velocity for a variety of different collision scenarios. In the next step we created a MADYMO model to evaluate the occupant environment during a collision, and also to evaluate a variety of collision conditions, interior conditions, and restraint configurations. Finally, we conducted static and dynamic tests of Amtrak passenger seats so we could measure the force/deflection characteristics of the seat during the static test, and also evaluate the seat performance during dynamic tests with loading conditions similar to what they might see in a collision.

These pictures are a product of the MADYMO simulation. The numbers on top correspond to event numbers that will be used in the next slide also. Initially the train and the occupant are travelling at the same speed. Once the primary collision occurs, the train begins to decelerate in stage two while the occupant continues to travel at a speed roughly equivalent to the speed of the train prior to impact. In this period, we say he's in free flight. At steps three and four, the occupant collides with the seat back, and he is decelerated rapidly until he is moving at the same velocity as the vehicle.

Once the train begins to slow down, the occupant continues to travel. The longer that travel distance is, the larger the relative velocity with respect to the vehicle. The best thing you can do, which was mentioned by Steve Soltis, is to effectively connect the occupant to the interior immediately. In which case, the occupant would only see the deceleration of the train.

Before going into a great amount of detail on each of the evaluation methods, I'll sum up our findings. Basically the basketball model provides a good, quick estimate of the head injury criteria for occupants seated in rows for that interior. The more detailed computer model with MADYMO can be used to provide a good approximation of the occupant kinematics during a collision and also the injury criteria arising from the forces and decelerations from the secondary impact. Finally, static testing is necessary to measure the force deflection characteristics of the seat to fine-tune the model. Dynamic testing is necessary to evaluate the collision performance of the seats under actual dynamic loading conditions, and also to validate the model for a range of collision conditions.

Now I'll go into a little more detail about the successive evaluation methods that we used. In the basketball model, we used the vehicle deceleration time histories from the lumped mass model, as it's been referred to over the last couple of days. We were able to plot the occupant's relative velocity, that is relative to the vehicle, against the relative displacement of the vehicle. Then we evaluated the impact velocity after the occupant has travelled two-and-half-feet relative to the vehicle. That came from a 42-inch seat pitch, less the thickness of the seat back and the occupant's head. So the distance from the front of the head to the rear of the seat is two-and-a-half-feet. We calculated the impact velocity that way. We used an approximation for the seat deflection characteristic that was taken from the school bus seat specification. Knowing the seat deflection characteristic, we could calculate the deceleration of the head and calculate the head injury criteria. Then we were able to calculate a percent fatality for different collision conditions and rank them that way.

The next higher fidelity model that we used was MADYMO. This was done cooperatively within the Center through different divisions, both our division and the crashworthiness division which does a lot of work for NHTSA and is very familiar with the MADYMO model. The model gives a detailed representation of the human body kinematics during a collision. We looked at a range of different interior configurations, different seat belt configurations, different train consists, and different positions within a consist.

This outlines the selected cases that we looked at. The different interior configurations were forward facing seats in rows with a 42-inch seat pitch. We looked at restrained and unrestrained occupants. We looked at seats facing each other as well as forward-facing seats with a table in front of an occupant without seat belts. The different consist variations were power car to power car, cab car to power car, and cab to cab. Each consist had a power car, five coach cars, and a cab car. We looked at different closing speeds from 70 to 140 miles per hour, and we looked at different cars within a consist, either the first coach or the trailing cab car.

This graph compares the impact velocity of the basketball model that we used with the MADYMO model. At about two-and-half-feet we would take the impact velocity to be about 18 miles per hour for the basketball model which corresponds quite closely with the MADYMO model. So in terms of the ability to predict secondary impact velocity, it's reasonable.

This table lists the results for all the different collision configurations and interior configurations that we looked at. The column and row highlighted in white are done so because they are the most severe collision conditions. These results are from secondary impact alone. The results do not include injuries or fatalities due to loss of occupant volume. Basically, the conclusion is that the cab car in a 70-miles-per-hour collision is not very forgiving for restrained or unrestrained

occupants in the majority of the seating configurations. For facing seats, the unbelted occupant has very little chance of survival based on this simulation.

This is a picture of the sled testing that was conducted with the Amtrak passenger seats in 1995. The whole test effort was a cooperative effort between the Federal Railroad Administration, Amtrak (who provided the seats for us to test), NHTSA (who provided the crash test dummies for us to use), as well as the FAA. Steve Soltis and Van Goudy at the CAMI facility in Oklahoma were very helpful in educating us on sled testing of passenger seats.

This is just a simple schematic of what the seat pair looks like. It will be helpful when we look at some of the test video. Basically, the seat is mounted with a floor-mounted pedestal and a bracket that mounts to the wall on the other side.

This is a schematic of the acceleration test sled. We used the high-G test sled where the sled is initially at rest, and it was accelerated with a pneumatic ram according to a crash pulse that we prescribed. The forward seat strikes the occupant with an impact velocity rather than the occupant striking the seat. It's equivalent to being in the stationary consist that gets struck with a moving vehicle.

For our test setup, we tried to mount the seats as accurately as possible according to how they are mounted in Amfleet cars. The seats were instrumented. There were four triaxial load cells underneath the forward seat pair, and four uniaxial load cells underneath the rear seat pair. We also had string potentiometers to measure deflection of the forward seat back that struck the occupant.

For the crash test dummies, we used 50th percentile Hybrid III male crash test dummies. In all but one test, we used two dummies; one was instrumented, one was not. The one dummy was instrumented to measure the triaxial head and chest deceleration, neck forces, and moments, as well as femur load. The seats were mounted on Brownline track (provided by Amtrak) that is used in the Amfleet cars. The track was mounted on hat-shaped, stainless steel channels as they're mounted in the Amfleet cars.

We conducted seven different dynamic tests. The first three tests were used to evaluate the influence of crash pulse. All the other conditions were the same. In the remaining four tests, we kept the crash pulse the same, and evaluated the influence of the initial seat position and dummy position.

There's always a good deal of discussion about the crash pulse and what should be used. We used a triangular crash pulse based on the lumped mass model predictions of the train collisions. The chosen pulse represents an occupant in the first coach car of a power car-to-power car collision with a 70-miles-per-hour closing speed. Again, we used a triangular crash pulse. The 8g's is just a bit more severe than what was seen in the lumped mass model, and that was done intentionally.

This graph depicts the different crash pulses. The dashed line shows what was derived from the lumped mass train model. The bigger dashed line was what we specified for the testing, and the jagged line was what was actually measured as the acceleration of the sled during one of the 8g tests.

To show the impact of the crash pulse on the secondary impact velocity, we integrated each of the crash pulses. The resulting impact velocity ranges from 17 to 24 miles per hour.

In every test, the head injury criteria and chest deceleration calculated and measured were well below what NHTSA and FAA specify: HIC of 1000 and chest g's of 60. We found that the initial position of the occupant does not have a significant influence on the injury criteria in most cases with one exception.

In tests above 5g's, the seat attachments were prone to failure at the wall mount. There were a couple of cases where the forward seat became detached entirely from the car. There was a great deal of variation in the plastic seat deformation from one test to another. The degree of seat deformation influences the effective stiffness of the seat and also influences how the occupant is decelerated during the secondary collision.

With that, I will show a video that shows all seven of the dynamic tests. These tests were conducted by MGA Research Corporation. The dynamic tests were conducted at their facility in Wisconsin. For each of the tests there are two different views. The first test was with a 5g crash pulse, relatively benign. The sled is accelerated backwards. The seat strikes the dummy's knees first and then the head strikes. The cushions flew off during this test. It's difficult to see, but there were string potentiometers connected to the front seat pair. The cushions interfered with the data. We also noticed that the seat cushions flew off of the seat before the head made contact, so they weren't affecting the deceleration of the head. For the future seat tests, we either taped the seat cushions to the chair or removed them entirely.

The second test is the most extreme test with a crash pulse of 10g's. Tray tables deploy during the collision. This doesn't look like a very comfortable thing to experience; however, the HIC measured was 133, and the chest deceleration was 18g's which is relatively low. In the third test, we used an 8g crash pulse with only one occupant. In the previous test, there was a weld failure of the component that prevented the seat from rotating. The third test was designed to determine when the seat was not loaded equally on either side of the center point, if that weld would fail again. It did not. So it appeared that the weld failure in the second test was a random failure. Because there was only one occupant, the seat saw half the load of what there would be with two occupants, and therefore there was very little plastic deformation of the seat under- frame. In this test, the recline mechanism rod failed, and allowed the occupants to decelerate over a larger distance. The HIC in test three was 112 and the chest deceleration was 19g's.

Again, all of the remaining tests will have an 8g crash pulse. The fourth test, the front seat is reclined. In this case, you can see a massive rotation of the seat. The seat came out of the wall mount and allowed the seat to rotate and tore the track below it, at which point the track failed. Now the seat is entirely removed from the test sled. The injury criteria consisted of an HIC of 180 and a chest deceleration of 20g's. This is a situation we want to avoid: a 250-pound seat that can become a projectile in the interior.

In test five, the front seat was reclined, and the occupant's legs were elevated on the leg rest. Again, the seat came away at the wall mount, and there's massive deformation of the under-frame.

In test six, the rear seat was fully reclined. The front seat in the full upright position. The occupant's feet are on the floor. You can see the recline mechanism fails on the rear seat which is not subjected to a load except from its own inertia. In this case, the seat separated from the wall mount and the floor mount, and there was a good deal of structural deformation beneath the seat. Because the seat became detached, it didn't provide a great deal of resistance to the occupant, and it resulted in very low injury criteria: an HIC of 41 and a chest deceleration of 12g's. Also, in a number of tests, the tray tables deployed, probably not increasing fatality rates, but adding to facial injury.

In the final test, the rear seat was fully reclined with the dummy's legs up. In this test, we saw the highest head injury criteria. It's because the feet strike first, then the knees, and then the head. Typically, the knees would strike first, deforming the seat a good deal, and creating a softer surface for the head to strike. In this case, the seat has basically undergone no deformation, so it appears very rigid to the head. The HIC in this test was 811 and chest deceleration was 8g's. This was by far the most severe test in terms of injury criteria, but still below the NHTSA and FAA standard of 1000 for HIC, and 60 for chest deceleration.

After completion of the testing, we had an enormous amount of test data to analyze. To compare the test data with the results from the computer model we created a MADYMO model with the same initial conditions as in every test. We wanted to evaluate the model for range of parameters and determine when it is able to predict what we saw in the sled testing and when, if at all, it's not. We also wanted to gain an understanding of the sensitivities to different test variables such as the crash pulse, occupant position, and the effective stiffness of the seats.

These graphs show the sensitivity to crash pulse. We did a number of runs with MADYMO with crash pulses varying from a peak of 4g's up to 16g's to show the influence on head injury criteria, and on top of those is plotted the actual test results at those different crash pulse peaks. This graph shows that in terms of predicting injury criteria for the different crash pulses, the model is quite good.

We plotted similar curves for seat stiffness. We saw a very wide range of effective seat stiffnesses during the testing depending on if the recline mechanism failed, if the wall mount became separated, if there were weld failures, and the degree of plastic deformation of the under-frame. We wanted to evaluate the influence of the seat stiffness on the occupant response. In MADYMO you define contact surfaces as piecewise linear springs. We had defined the spring stiffness based on the results from the static testing, in which we performed two static tests: one with a load applied near the head contact point and another with the load applied near the knee contact point. To evaluate the seat stiffness and the sensitivity to the seat stiffness, we took the stiffness of the high load application and multiplied it by a factor of .5 up to 5, to demonstrate how the HIC is influenced by the effective stiffness of the seat. Basically this covers the range of what we saw during the test: the range of 41 to 811. So the effective seat stiffness varies a great deal. One has to keep that in consideration when saying that the model validates the testing.

The two dashed lines correspond to the force-deflection measured during the static tests, with the load applied at the head and knee contact points. The shaded area around each dashed line represents a range of +/- 50% of the nominal seat stiffness at each location. All of our results fall within these ranges.

We've superimposed the kinematic output over photographs from the 10g sled test to show how they correspond in terms of predicting the occupant kinematics during the test. Initially, during free flight in the second frame on the top right, the MADYMO occupant and the crash test dummy are still in good comparison. They are still following each other in the third frame. In the fourth frame, the test dummy continues to travel further than the MADYMO dummy. This is due to the effective seat stiffness. In the 10g test, we saw a massive amount of structural deformation, so the seat appeared to be relatively soft to the occupant, decelerating the test dummy over a longer distance than in the model.

In the post-test analysis, we compared the model results to the test results. We found that the injury criteria agree very well, within the variability of the effective seat stiffness that I've just talked about. Also, the kinematics predicted by the model were extremely close to what we observed during the testing. The head and chest decelerations from the analysis are in general agreement with the test data, and the variation in the effective seat stiffness can account for the discrepancies that we do see between the injury criteria for the test and the model.

To conclude, the basketball model described previously provides a reasonable estimate of the head injury criteria. It's a quick estimate. We can evaluate a number of different collision conditions. The model we've developed with MADYMO allows us to predict the head and chest deceleration injury criteria for the seats in forward-facing rows interior. Static testing is necessary to define the seat characteristics in terms of force/deflection. The seat characteristics are necessary to develop an accurate computer model. Once validated, the computer simulation can be used to analyze a range of different parameters. In the testing, we looked at different crash pulses, different interior configurations, and the model's ability to accurately predict injury criteria measured in the tests. I believe that we have a valid model to evaluate a range of occupant sizes and positions as well as different seat pitches and crash pulses. That concludes my presentation. [Applause] Does anybody have any questions before we move to the panel? Yes.

BOB GALGANSKI: Bob Galganski for CALSPAN. I've got a number of questions if you don't mind.

KRISTINE SEVERSON: Okay.

BOB GALGANSKI: Were the seats mounted on an actual Amtrak floor band?

KRISTINE SEVERSON: They were mounted on the brownline tracking that is used in the Amfleet cars which is in turn mounted on stainless steel hat-shaped channels. The hat-shaped channel was rigidly fixed to the test sled.

BOB GALGANSKI: So it was a true test of the mounting capability?

KRISTINE SEVERSON: Yes.

BOB GALGANSKI: Do you plan to run any unrestrained or any restrained occupant runs to see what the difference is?

KRISTINE SEVERSON: Yes, at this point, I think that as things stand, we don't have Amtrak seats with seatbelts to test.

BOB GALGANSKI: I mean what about cobbling up something just for comparison sake?

KRISTINE SEVERSON: We are planning on doing two more series of testings. The high speed generation seats, I believe, are specified to be equipped with potential seatbelt attachment points, but as of now, seatbelts are not required.

DAVID TYRELL: If I can interject and clarify, we are planning tests for two additional seats, what Amtrak has termed their third generation seat, similar to the seats that we tested here, and also a high speed train seat which is supposed to have mountings for seatbelts. We are planning to test that with seatbelts attached to those mountings. Those seats are not yet available; however, and it's indeterminate when they will be available. Hopefully soon.

BOB GALGANSKI: I had a couple more.

KRISTINE SEVERSON: Okay.

BOB GALGANSKI: What was the range of secondary impact velocities? Did you -

KRISTINE SEVERSON: Yes, we have that recorded. We have all the data integrated from the head acceleration, and it is extremely close within the fraction of a mile per hour. The actual head velocities at impact ranged from 17 to 24 miles per hour, I believe.

BOB GALGANSKI: Okay, one more. This is a comment in general. The low HIC numbers are misleading. You know, you've got an HIC of 173, and you figure everything's all well, but I think that just points up the need for more comprehensive injury measures like, you know, facial damage. You're going to do a lot of damage to your dentures or your teeth, you know, getting the seat back in your face, especially the frame, so that's a critical, critical point.

KRISTINE SEVERSON: Right, one of the things that we initially started looking at was strictly fatalities. We weren't evaluating ranges of injuries. We were looking at injuries as fatal or non-fatal, and I agree. We've seen that the injury criteria are quite low. The next step might be to look at the range of injury criteria. Now maybe we're preventing fatalities. How can we further prevent injuries?

BOB GALGANSKI: One more thing, and I'll get out. At the risk of incurring the wrath of Amtrak, how does Amtrak feel about these results?

KRISTINE SEVERSON: Maybe you should ask Amtrak. Caesar Vigara?

CAESAR VIGARA: I'm Caesar Vigara. I'm a chief industrial designer with Amtrak. I was in charge of the development of the new seat that is not available. The lawyers have it now. So we'll see when we get there, but I should clarify several things to you and to the rest of the people. Throughout the history of the seat that we presently have which is a 25-year-old design basically, there have been continuous improvements such as simple but yet effective ways of minimizing injury like there was a piece of metal that used to come very sharply under the seat.

That now has a lip that is bent this way. We will be changing the attachment point on the wall so that the seat doesn't come out which we did tell you we knew had to be done. Now it was substantiated. A lot of the things that were concluded we found out. We intended to do anyway. Now the new seat that we have developed indeed addresses-the intention of it is all of the things that the comment that you made on the facial injury. It is a huge crash pad, and the whole design of the seat is such that it will give probably like 20 inches in the worst case scenario if it works. It has to be tested, and it has to be perfected. One more comment. On the seatbelt attachment points, there is a requirement from the FRA, I believe, to have seat attachment points provided for the high speed train seat. I am recommending because I am the person that interfaces with the potential manufacturer of seat, whoever that may end up being because they have to be chosen by Bombardier, that we have a design that from scratch, from an engineering point of view, from a structural point of view, considers those points. I want to avoid any situations where we have additions to the seat which has been the history of our present seat. Rather to design a main beam which is designed and intended to have attachment points for seatbelts because it will change the whole dynamics of the structure so that your concerns have been addressed.

BOB GALGANSKI: I've been waiting patiently. I also noticed obviously that the HICs were very low in your tests. I don't believe that the tests that you're running show a real significant potential for head injury based on your dummy model. I don't think HIC is the real indication that. I think the problem you're running into is the non-biofidelity of that dummy. I think if you ran that same test with cadavers or something more human-like that you're going to get a much harsher facial impact. Now I throw this next comment to all of FRA. I don't know if data is available, but you should certainly know what injuries are occurring in the real world as far as occupant impact with the seat back and front. Are you seeing a lot of facial injuries? What I see on these tests is I see--I mean where is the load going? You have very low head accelerations and very low chest accelerations.

KRISTINE SEVERSON: You can see that the knees strike first in almost every case.

BOB GALGANSKI: My question is have you measured the femur load?

KRISTINE SEVERSON: Yeah, and every single case was below 2250.

BOB GALGANSKI: What were they roughly?

KRISTINE SEVERSON: 1600 average maybe. One case I think the max was about 2200. What you say about better bio-fidelity in the occupant, that's why I asked you if you compared your final net results with MADYMO to see what you found there.

AUDIENCE ATTENDEE: Would you care to comment on the results of this if the tests were conducted at an initial velocity of 35 miles per hour rather than 70?

KRISTINE SEVERSON: What would the difference in the results be? I don't expect they would vary very much. Once you get above about a 35-miles-per-hour impact speed, the crash pulse doesn't change very much for the vehicles in the train. So I would expect the results to be quite similar. Yes?

MIKE NOLAN: Mike Nolan from Intero. I noticed you mentioned that the specification for the new seat has a requirement for a seatbelt attachment at a later date. It raises an interesting scenario where you could have a set of passengers in one seat belted in-you're nodding your head. Somebody must have already raised this.

KRISTINE SEVERSON: Yes, in a paper that we've published earlier, we raised that problem. If you have one occupant who's restrained and one is not, they can both end up loading the same seat which puts an extreme requirement on the seat, even more so than what you see here.

MIKE NOLAN: Yes, and do you have any comments on that?

KRISTINE SEVERSON: Well my comment is, I mean, the seat needs to be designed to take the loads that it could see in a collision. That's my comment.

MIKE NOLAN: Okay. I have one more question.

KRISTINE SEVERSON: Actually to finish that, I think that when we talked about testing the high speed seat, I believe that we've specified restraining sandbags equivalent to the mass of two dummies in the forward seat pair and having the seats loaded by dummies from the rear. So they would be tested under the double loading condition.

MIKE NOLAN: They would be tested under the double loading condition.

[Simultaneous talking]

MIKE NOLAN: You could have two rows of seats. Let's say the front set would be belted in.

KRISTINE SEVERSON: Well we wouldn't use a dummy because they're kind of expensive, but like 165-pound sandbag restrained to the seat.

MIKE NOLAN: Okay. But restrained to the seat and then the rear set would be-

KRISTINE SEVERSON: Two dummies striking the seat that are unrestrained.

MIKE NOLAN: Okay. One more question if you don't mind. There's been discussion of tertiary impacts, and as I saw these, which unfortunately went off screening, I had the impression that in some cases, tertiary impacts were occurring, and that you also discussed compliant seat backs, and it seems to me that a limitation on the compliance, that is compliance up to a certain point, just like a deflection angle, would be appropriate. Do you have any comments on that?

KRISTINE SEVERSON: Yes, that is good. We can't talk about compartmentalization if you have a totally compliant seat that falls down when you hit it, you're not really compartmentalized anymore.

MIKE NOLAN: Okay.

KRISTINE SEVERSON: We didn't measure the tertiary impacts that some people have referred to. When you're mocking up just two rows out of a car, you're not modelling the entire car so

anything that the occupant hits after the seat is not really realistic of what they would hit in a collision, and we didn't take that into consideration.

MIKE NOLAN: Thank you.

KRISTINE SEVERSON: Yes.

CAESAR VIGARA: Mike, I needed to remind you of one thing. That new generation seat that we are presenting is a good five inches higher, and this has a double purpose. One is to provide greater privacy, and the other one is to provide a greater shield for this phenomenon that you described. So we've been trying to think about everything.

KRISTINE SEVERSON: I'm sorry. Steve?

AUDIENCE ATTENDEE: I had an initial comment, but before I forget about this tertiary impact condition. The high g facility, depending how you do this, might not be a good mechanism which to evaluate that because immediately you're breaking the system, and it's a little bit different in-

KRISTINE SEVERSON: In your case, you have the occupant striking the seat at an impact velocity, and then you have the inertia. In our case, the seat strikes the occupant with a certain velocity, but if we're looking at a collision where one train's at a standing and is struck by another. One occupant will see one condition. One will see the other.

AUDIENCE ATTENDEE: Right, right. It's true for that case, but what I'm saying is you do have a breaking effect on a sled. So you accelerate, and then you break immediately. If you let it free roll for some distance, you would eliminate that if you want to look at these other effects perhaps, but my initial reason for raising my hand was again on injury criteria. You looked at HIC, but there may be some other injury mechanisms, and one that comes to mind that I recall from one of the Stapp car crash conferences, and I'm reaching back for a number, but I believe it was something like, and this is for impacts on the top of the head which Dr. Kleinberger discussed a little bit earlier. He was doing some research on, but my recollection was that, you know, a direct impact on the top of the head of a free-falling occupant of something like 15 feet per second would be injurious, and I think Christopher Reeves is an example of what can happen.

KRISTINE SEVERSON: We did measure the neck load and moment, and what we used as a criteria to evaluate them, I believe is what Dr. Kleinberger talked about, and not very favorably, the Mertz-Weber criteria, and the neck injury criteria in every test was below that. It's a pass/fail criteria for a force versus a duration. The peak loads we were seeing were about, I don't remember exactly, 500 or 600 pounds, but in every case, they were below that pass/fail curve or pass.

AUDIENCE ATTENDEE: Some more work, Kris.

KRISTINE SEVERSON: Yes?

AUDIENCE ATTENDEE: Interestingly enough, anecdotely, a lot of the injuries that come to our attention following collisions and derailments involve the lower extremities. Perhaps we can

speculate because people are in a state of repose with feet fairly far underneath the, as far as they can get, under a metal bar footrest or under the seat in front of them. As we go down the road, I wonder if there's any strategy to deal with that at all?

KRISTINE SEVERSON: Are you talking about preventing them from submarining basically?

AUDIENCE ATTENDEE: Basically.

KRISTINE SEVERSON: We didn't see that on the test. If anything, the dummies tended to stand up and rise over the seat. In terms of lower extremity injury criteria, the only thing we looked at was the femur loads, and they were high but below what criteria we have to compare them with.

AUDIENCE ATTENDEE: I think we need a strategy to calibrate our scenarios of the injuries that we're finding in the real world, and we're not very helpful on that to you. What we find is that the National Transportation Safety Board reports at best, and they give us AIS in a broad kind of way. We do not have the survival factors of people to reflect the data in this regard; however, certain transportation companies may have claims department data that could be of some assistance if they were properly abstracted with recognition of all appropriate legal considerations including privacy. I think one of our issues here are what are we trying to prevent, and we do have, obviously, many casualties that occur from crash pulse in passenger train accidents. To my knowledge, few fatalities--I can't think of any. I was speculating since 1991-identified as likely related to crash pulse as opposed to the fire water or some kind of incursion to the occupied volume. We've got lots of casualties, non-fatal casualties. If we can work on what those non-fatal casualties are, then perhaps we can refine our analysis of what the responses may be in terms of seat design and other adjustments to the compartment.

KRISTINE SEVERSON: I definitely agree that the next piece of the puzzle would be to verify our test and model results with actual collision data.

PRESENTATION

PASSENGER RESPONSE IN TRAIN COLLISIONS

Federal Railroad Administration
High Speed Ground Transportation Safety

Passenger Response in Train Collisions

Kristine Severson
David Tyrell
Volpe National Transportation Systems Center
US Department of Transportation

Background Information

- Research Initiated to Support FRA in
Discussions with Amtrak on NEC High Speed
Trainset
- Tradeoffs Between Preserving Occupant Volume and
Secondary Collision Conditions

Interior Crashworthiness Safety Objective

- Limit the Deceleration and Force Imparted to the Occupant to Survivable Levels



Presentation Outline

- Interior Dynamics During a Train Collision
- Three Methods of Evaluating Interior Crashworthiness:
 - "Basketball" Model
 - Computer Simulation of Secondary Impact
 - Sled Testing
- Conclusions

Unrestrained Occupant Motion During a Train Collision

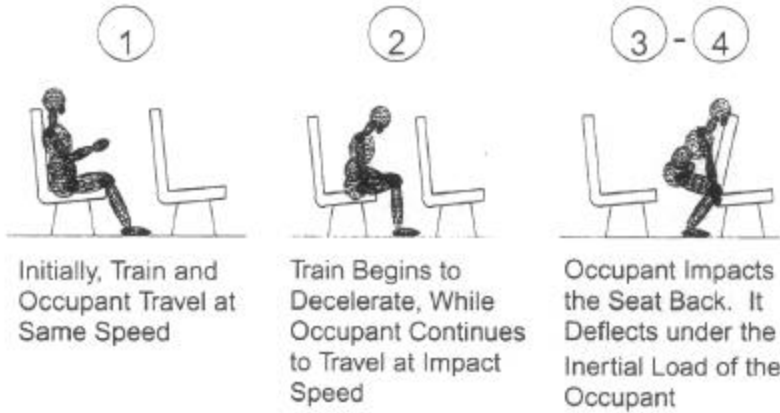

Interior Dynamics During a Train Collision*

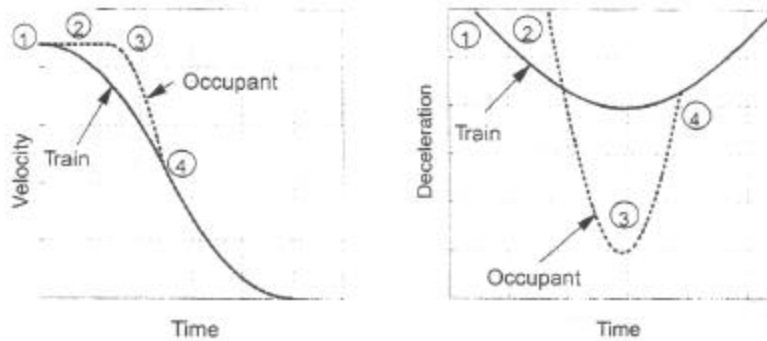

* Hypothetical curves of vehicle and unrestrained occupant in a collinear train collision

Research Conclusions

- "Basketball" Model Can Be Used to Provide a Good Estimate of Head Injury Criteria for Occupants Seated in Rows
- Occupant Motion and Injury Criteria Due to Head, Chest, Neck and Femur Loads can be Determined Analytically if Seat Characteristics are Known
- Static and Dynamic Testing is Necessary to Measure Seat Force/Deflection Characteristics

Basketball Model

- Vehicle Deceleration Time Histories From Lumped Mass Models of Train Collisions
- Seat Force/Deflection Characteristic Taken From School Bus Seat Spec 49CFR571.222
- Calculate HIC Based upon Impact Velocity and Seat Stiffness
- Model Can Be Used to Quickly Estimate Percent of Fatal Injuries Due to Secondary Impact for Large Range of Consists and Closing Speeds

Computer Simulation of Secondary Impact (MADYMO)

- Detailed Representations of Human Body
Kinematics and Mechanics
- Range of Interior Configurations, With and Without Seat Belts
- Program Developed for Analyzing Automobile Interior Performance in Frontal Collisions
- Widely Accepted and Applied by NHTSA and the Automotive Industry

Selected Cases

- Interior Configuration
 - Forward-Facing Seats, With and Without Seatbelts
 - Face-to-Face Seats, With and Without Seatbelts
 - Forward-Facing Seats and Table, Without Seatbelts
- Consist Variation
 - Power Car to Power Car, Cab Car to Power Car, Cab Car to Cab Car
- Closing Speed
 - 70, 140 mph

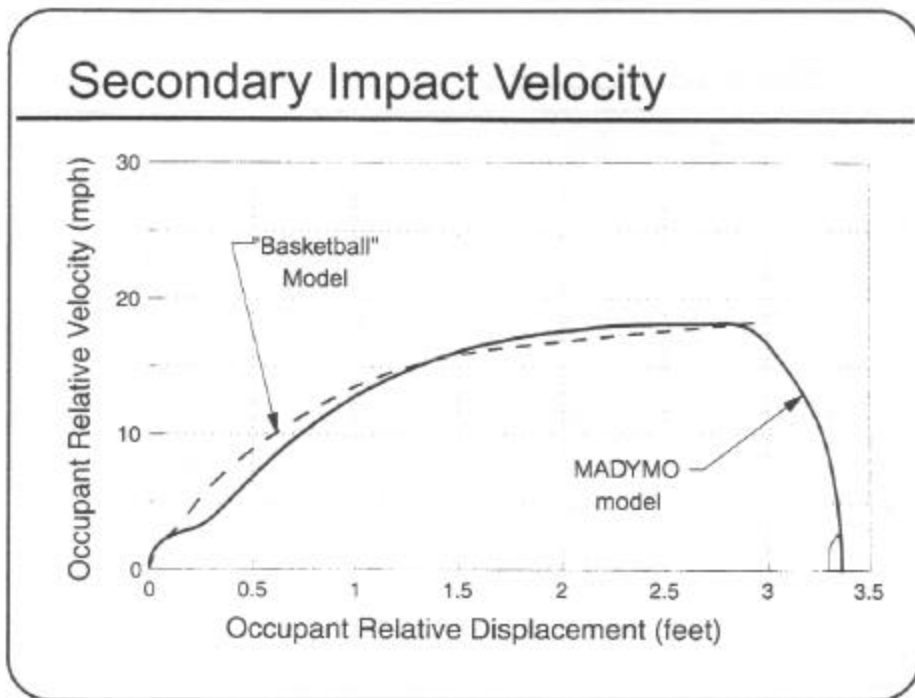
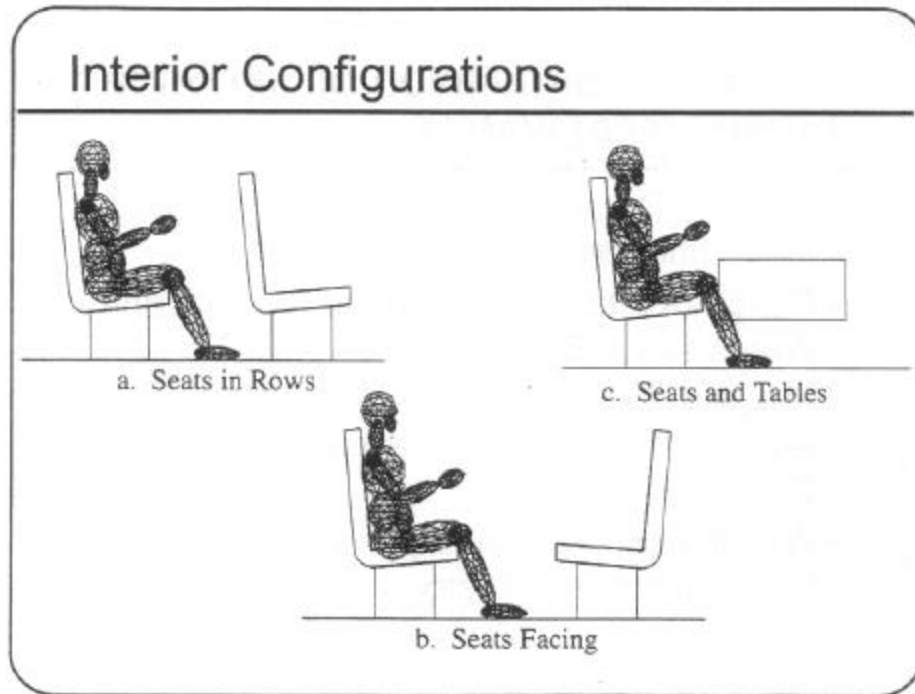

Seats in Rows, Facing Seats, and Seats and Tables, Secondary Collision Fatality Rates

		Conventional Design			Constrained Crash Energy Management Design		
		60 mph Frontal Seatbelt	60 mph Frontal Seating	Cab Car 70 mph Cab Car Leading	60 mph Frontal Seating	60 mph Frontal Seating	Cab Car 70 mph Cab Car Leading
Seats in	Belted	0%	0%	0%	0%	0%	2%
Rows	Unbelted	2%	4%	16%	4%	6%	13%
Facing Seats	Belted	0%	0%	75%	0%	0%	38%
	Unbelted	100%	100%	100%	100%	100%	100%
Seats and Tables		7%	3%	100%	1%	0%	5%

Note: Principal cause of fatality is loss of occupant volume. Fatalities due to loss of occupant volume are not shown on this table.

Sled Testing

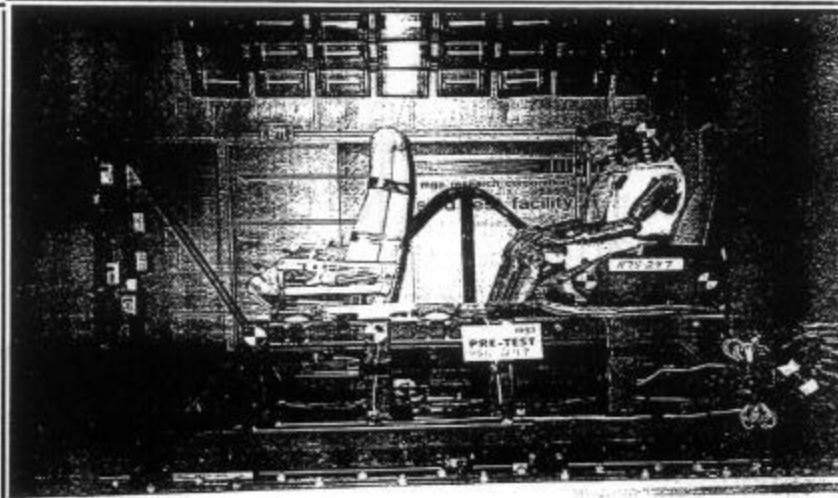

Schematic of Seat Pair

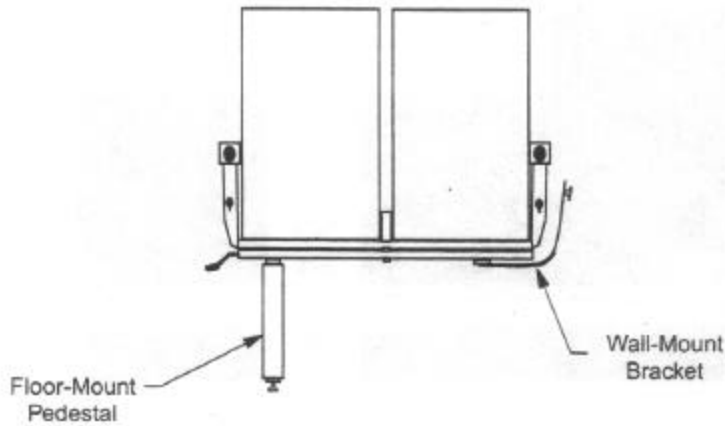

Acceleration Test Sled

- Sled Initially at Rest
- A Crash Pulse is Specified That Simulates the Deceleration of a Train in a Head-on Collision
- Pneumatic Ram Accelerates the Test Fixture

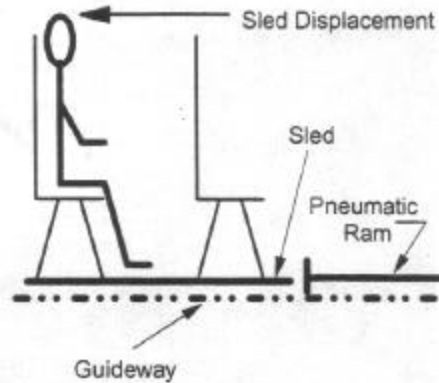

Test Set-up

- Seat Mounting Representative of Amfleet Cars
- Seat Instrumentation
 - Four Triaxial Load Cells
 - Four Uniaxial Load Cells
 - Four - Eight String Potentiometers
- Anthropomorphic Test Devices
 - 50th Percentile Hybrid III Male
 - Instrumented to Measure:
 - Triaxial Head and Chest Acceleration
 - Triaxial Neck Forces and Moments
 - Axial Femur Load

Seven Dynamic Tests Conducted

- First Test Series
 - Evaluated Influence of Crash Pulse
- Second Test Series
 - Evaluated Influence of Seat and Dummy Positions

Basis for Crash Pulse

- Based on Lumped-Mass Model Predictions
 - 1st Coach Car, Power Car to Power Car Collision, 70 MPH Closing Speed
- Occupant Response is not Sensitive to Precise Shape of Pulse
- Occupant Response is Sensitive to Secondary Impact Velocity
- 8g Symmetric Triangular Pulse of 0.250 Seconds Duration
 - Results in ~20 MPH Secondary Impact Velocity

Crash Pulses

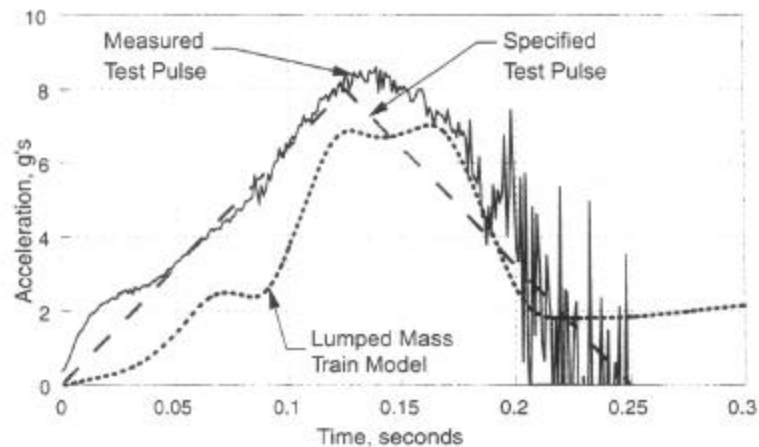

III 4 24

Secondary Impact Velocity

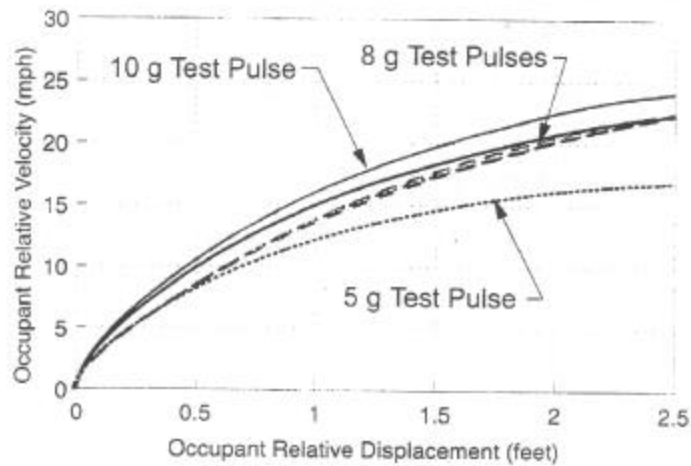

Test Results

- Dummies
 - NHTSA Standards for Injury Criteria Were Met in Every Dynamic Test
 - Initial Position Does Not Have a Significant Influence on Injury Criteria
- Seats
 - In Tests Above 5 g's Seat Attachments were Prone to Detachment at Wall Mount
 - Variation in Plastic Seat Deformation Among Dynamic Tests, Resulting in Variation of the Effective Seat Stiffness

Analysis of Test Results

- Objectives of Analysis
 - Compare Test Data with Results from Computer Model
 - Validate Model for a Range of Parameters
 - Gain an Understanding of Sensitivities to Test Variables

Sensitivity to Crash Pulse

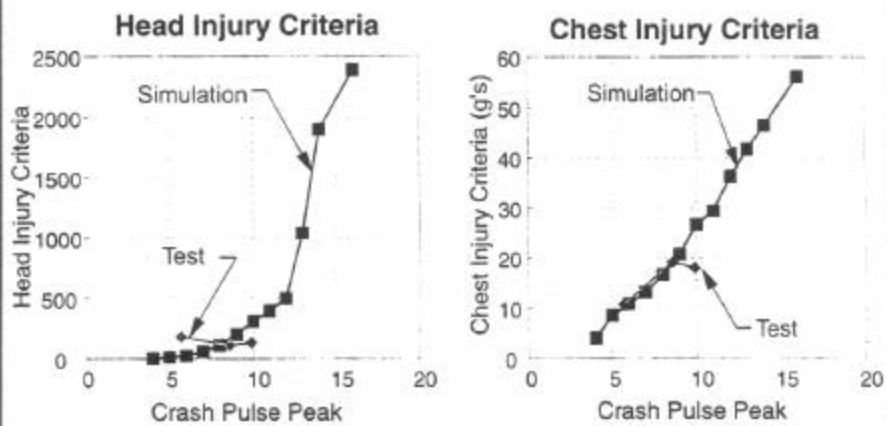

Seat Stiffness

- Wide Range of Seat Behavior Observed During Testing
 - Recline Mechanism Collapse, Wall Mounting Separation, Weld Failure
- Influence of Seat Stiffness on Occupant Response Analytically Investigated

Sensitivity to Seat Stiffness

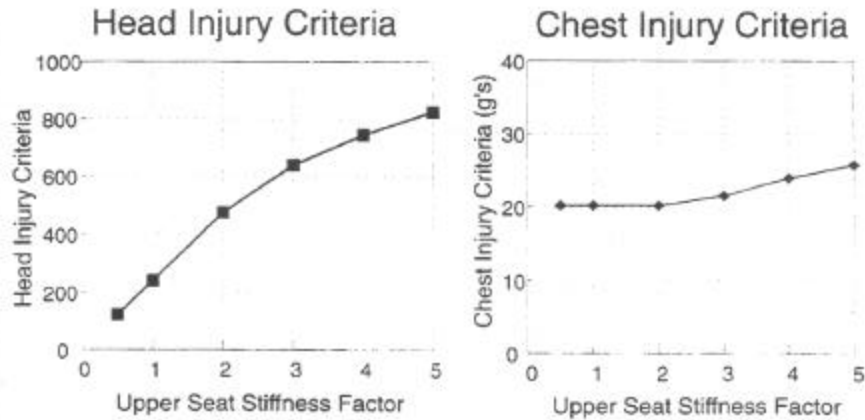

Range of Effective Seat Stiffness Used in Sensitivity Analysis

Note: Dashed lines are approximated from static test data

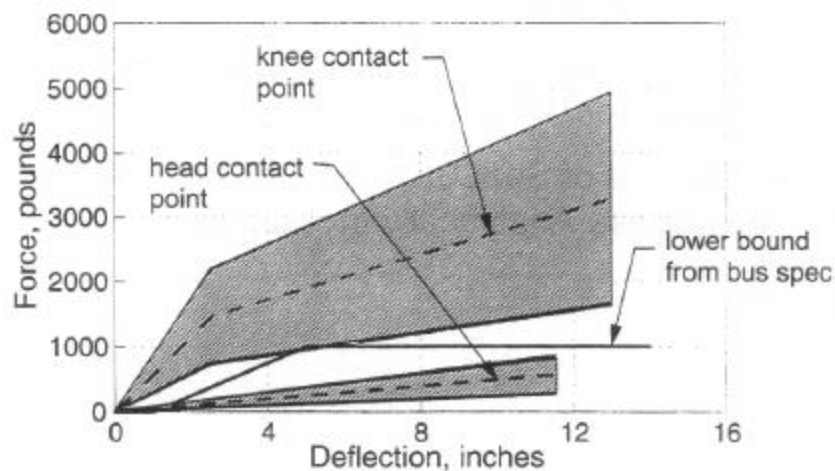

Comparison of Test and Model Results

- Test & Analysis Results Agree Within Variability of Seat Stiffness
- Dummy Kinematics Predicted by Analysis are Extremely Close to Kinematics Observed During Tests
- Head & Chest Decelerations from Analysis in General Agreement With Test Data
- Variations in Effective Seat Stiffness can Account for Discrepancies in Injury Criteria

Overall Research Conclusions

- Basketball Model Provides a Reasonable Estimate of Head Injury Criteria
- MADYMO Simulation Predicts Head, chest neck and femur Injury Criteria Measured During Dynamic Tests with a Reasonable Degree of Accuracy
- Static Test Results Used to Define Seat Force/Crush Characteristics for Model
- Validated Computer Simulation can be Used to Analyze a Range of Parameters Such as Occupant Size and Position, Seat Pitch and Crash Pulse

Interior Crashworthiness Panel Discussion

DAVE TYRELL: I'd like to ask the panel members to come up so we can have a panel discussion. I'd like to start off and take advantage, perhaps expand on something similar to Grady's question he asked Steve. You showed a graph that indicated improvements in injury or reduction in seriousness of injury with the use of seatbelts. How was that determined? It looked like it might have been done for the NTSB. What kind of analysis or tests were done to determine that?

PANELIST: That compared lap belt restraint systems with lap belt upper torso restraint systems. So it wasn't no lap belt versus lap belted occupants. That was a special study conducted by the NTSB where their field investigators went out to a number of selected accidents. This is again a special study case. The occupants of those vehicles or airplanes were wearing just lap belt restraints. The investigators made some assessments and judgements on what they thought the injuries or fatalities would be if upper torso restraint systems were utilized. So if they saw a severe head injury and they thought an upper torso restraint would have reduced that injury, they made that judgment. So there were some judgmental decisions made based on the injuries suffered by the occupants and the types of objects that were struck in the vehicle.

DAVE TYRELL: One of the things I've struggled with is the injury criteria as used by NHTSA, and it's used by the FAA, appear to be appropriate in measuring the threat of fatality. So my interpretation has been that if your head and your heart make it through the collision, you're likely to survive, and that's kind of what those criteria say, but in order to evaluate ankle and extremity injury, ankle, leg, hand, and wrist, and arm, it becomes almost overwhelming. I mean even if you had the computer model that could simulate all the forces and decelerations experienced by the whole body in each piece, it would be an extreme thing to go through and say here are the injuries I expect. I guess I'm looking for suggestions or comments on turning Grady's request into a tractable problem.

PANELIST: Our injury criteria are based more on life-threatening injuries and are not necessarily based on the threat of an immediate fatality. I don't think if you exceed a HIC of a thousand it's a give in that it's a fatality, or a chest injury criteria is based on an AIS level of three. The spinal injury criteria is not also based on a threat of fatality. We were looking at basing our injury criteria on debilitating injuries and then somewhat life threatening. Other injuries such as the upper and lower extremities, we did not determine any injury criteria for them. One, it's difficult to do. It's difficult to measure and difficult to assess whether or not you met the criteria, and secondly, like the position you're in, it was our first attempt at providing, you know, some significant improvements in crashworthiness in aircraft, and that being the seat dynamic performance standards. If we made those standards, you know, so complex that it envisioned every potential injury mechanism and tried to protect every occupant from every crash event, I think we'd still be in meetings like this discussing those standards. So I think we ought to be rational and take a pragmatic approach and really just develop criteria for the more serious crash events and the more serious injury mechanisms.

MICHAEL KLEINBERGER: If I can add on a little bit to that. Some of the injury criteria are available because the instrumentation is available on the dummies. For example, in the ankle, there really is no good instrumentation down there. So it would be very difficult to state some

injury criteria for ankle injury because there's no measurements being used down there. The new dummy that we've released is trying to get at some of those things, trying to look at some of the lower extremity injuries. One thing I mentioned before, which I'll state again, is I think it's important to determine what injuries you're trying to prevent in these situations. If you look at it in the real world and you're seeing a lot of tibia fractures, well then you better first of all get a dummy that will measure tibia loads, and second of all come up with some tibia tolerances. I mean we are doing this kind of thing. We test every part of the body. It depends on what problem you're trying to solve.

BOB GALGANSKI: If I may say something. A few years ago I read an article where-maybe Michael you could answer this-somebody was working on a segmented face for an advanced dummy. Something like the segmented load cell barrier in front of collision tests, but wasn't the face broken up into little squares, and I don't know whether strain gauge instrumentation was used to record displacements, and you would use this as, perhaps, an index of facial disfigurement. Is that work still ongoing?

MICHAEL KLEINBERGER: Yeah, there is a face available which we call the Melvin face. It looked like the dummies that Kris was testing actually had that face on it. Did they have-

KRISTINE SEVERSON: I don't know what face it had.

MICHAEL KLEINBERGER: John Melvin from General Motors developed a new face that had some load cells built into it, and that gives you some information. The new dummy we released also has some load cells in the face so it would be a better tool to use than Hybrid-III.

KRISTINE SEVERSON: Yes, we did not definitely have any load cells in the face.

DAVE TYRELL: The faces on those dummies were chalked so you could see where they contacted the seats.

MICHAEL KLEINBERGER: It looked like the face the way you chalked it, I guess.

DAVE TYRELL: Are there any questions from the audience? Frank?

FRANK CIHAK: I'm not sure who should be answering this, and maybe not this panel even. Maybe it should have been an earlier one, but does NHTSA do any-everything we've seen there was single vehicle modelling. Was anything done in collision between vastly different vehicles like automobiles and trucks, and then what kind of survivability do you expect out of those kind of things if anything?

PANELIST: I have a slide at the office which I really wish I had.

MICHAEL KLEINBERGER: There was a lot of hype I guess about three or four years ago about that specific question because the comment came out comparing big cars to small cars, and basically the argument is that the government is trying to force the car manufacturers to build smaller cars with greater fuel efficiency, and the car manufacturers are, of course, arguing that larger is safer which is certainly true to some extent. We have done some crash tests of large cars

and small cars, and obviously, as you would expect, the small car did not typically fair as well as the large car. I don't know of any car to truck crashes.

BOB GALGANSKI: Yes, CALSPAN has conducted for litigation purposes tests between say a semi and a VW. You know who's going to win that one, and I don't know if those results would be available, but we've run a number of those for litigation purposes, and they're quite impressive.

AUDIENCE ATTENDEE: The question is for Steve. On some of the charts you showed there, they had a 95 percentile survivable curve on it. Could you describe what that means?

STEVE SOLTIS: That's just more or less a statistical estimation. We've looked at all of the airplane accidents and said if we wanted to design to 95 percentile velocity change, these are the velocity changes that we would have to design to. Now if you look at the cumulative velocity change diagrams, you can find that as you start getting above 95 percentile and if you want to start looking at 98 or 100 percentile velocity changes, you may see another 50 percent or 75 percent difference in the velocity change from the 95 percentile up to the 150 percentile. If you want to include every survivable accident instead of looking at a 44-foot-per-second velocity change, you might be looking at a 60- or 70- or 80-foot-per-second. So that little increment costs you big bucks to gain that, and 95 percentile has typically been used in the aircraft industry by the military in the past.

DAVE TYRELL: Herb?

HERBERT WEINSTOCK: Well I'm just noting that it's about a quarter to five now, and I want to be sure that for the Volpe Center that I did have an opportunity to thank everybody for their participation, particularly the presenters and the moderators that helped this very successful conference that kept things interesting where we have an active group at this point. We'd also like to extend special thanks to our associates, friends, from NHTSA and FAA Administration guidance that they've given us in the course of the research we've been doing. Particular thanks to the people that joined us, France and the United Kingdom, for sharing their research with us, for participation of U.S. railroad, the AAR, the transit industry, and the manufacturing community. Special thanks, of course, to Grady Cothen and his staff at the Office of Safety for their participation in the conference and their driving interest, continuing interest in this area of research activity, and also to Steve Ditmeyer and his staff for the guidance that organized the conference. Dave Tyrell has done most of the work in terms of organizing and scheduling things with the help of Joe Davin back there who's been very quiet, but he's been instrumental in making things go seamless, and Debbie Duncan that put it together, and we'd like to thank everyone for coming and thank everybody for their participation. Grady, Steve, would you like to say anything?

[Applause]

STEVE SOLTIS: And I'll just turn it around and say thank you, Herb, for your role and your committee's role in putting together this excellent conference, and we wish everybody has a safe journey home. If you're driving, buckle the seatbelts. If you're riding the train, ride in the middle coach, and if you're flying, I guess stay away from the bulkhead. Again, thank you and the

audience for staying through to the end this afternoon. Thank you on the panel. We really appreciate it. [Applause]

GRADY COTHEN: I would like to thank you on behalf of the FRA staff and also the Administrator and the office of FRA, but most particularly on behalf of the passenger equipment safety standards working group that some of us serve on because this is an important milestone in our activity that will play out over the next several years, and having a common baseline to work from and catching up where we've been behind and so forth is true of so many of us. It's a great benefit, and we appreciate that.

APPENDIX

RAIL VEHICLE CRASHWORTHINESS SYMPOSIUM

JUNE 24-26, 1996

SPEAKERS & ATTENDEES

SPEAKERS

Duncan Allen, P.E.
Senior Project Manager
DeLeuw, Cather & Company
Prudential Center
Boston, MA 02199
Tel. 617-859-2376
Fax 617-859-2174

John Bell
Program Director High Speed Transits
Amtrak
100 North 20th Street, Ste 300
Philadelphia, PA 19103
Tel. 215-349-3804
Fax 215-496-9451

Al Bieber
General Electric
Transportation Division
2901 East Lake Road
Erie, PA 16531

Dr. Alan Bing
Arthur D. Little, Inc.
Acorn Park
Cambridge, MA 02140-2390

Harvey C. Boyd
Electro-Motive Division
General Motors Corporation
Locomotive Group
LaGrange, Illinois 60525

Frank Cihak
Chief Engineer
American Public Transit Association
1201 New York Avenue, NW
Washington, DC 20005
Tel. 202-898-4042
Fax 202-898-4019

Louis-Marie Cléon
Société Nationale des Chemin de Fer Français
(SNCF)
15 Rue Traversière
Cedex 12
Paris 75571
France

Grady Cothen
Deputy Associate Administrator
Office of Safety Enforcement
Federal Railroad Administration
400 7th Street, SW
Washington, DC

Steven Ditmeyer
Director-Office of Research & Development
Federal Railroad Administration
400 7th Street, SW
Washington, DC
Tel. 202-366-6920
Fax 202-366-7157

Robert Dorer
Chief
High Speed Ground Transportation Office
Volpe Center
55 Broadway
Kendall Square
Cambridge, MA 02142-1093

Frank Duschinsky
Director of Engineering
NEC Project for the Consortium
Bombardier Inc.
Transportation Equipment Group-
North America
1101 Parent Street
Saint-Bruno, Quebec
Canada J3V 6E6
Tel. 514-441-2020
Fax 514-441-1515

Robert Galganski
CALSPAN Advanced Technology Center
4455 Genesee Street
(P.O. Box 400)
Buffalo, NY 14225

Dr. Richard John
Director
Volpe Center
55 Broadway
Kendall Square
Cambridge, MA 02142-1093

Larry Kelterborn
Consultant
LDK Engineering, Inc.
1084 Botanical Drive
Burlington, Ontario
L7T 1V2
Canada

Steve Kirkpatrick
SRI International
Research Engineer III
Shock Physics Geophysics Department
Poulter Laboratory
Menlo Park, CA 94025
Tel. 415-859-2604
Fax 415-859-2260

Michael Kleinberger
Biomechanics Division
National Highway Traffic Safety
Administration, NRD-12
400 7th Street, SW
Washington, DC 20590
Tel. 202-366-4698
Fax 202-366-5670

John Lewis
Team Leader (Vehicle Crashworthiness)
British Rail Research
PO Box 2
London Road
Derby DE24 8YB
England

Dr. Ron Mayville
Manager
Applied Mechanics Unit
Arthur D. Little, Inc.
Acorn Park
Cambridge, MA 02140-2390

James T. McQueen
Associate Administrator
Railroad Development
Federal Railroad Administration
400 7th Street, SW
Washington, DC

Daniel Palardy
Project Engineer
Engineering - Structure & Traction Group
Bomboardier Inc.
1101 Parent Street
Saint Bruno Quebec J3V 6E6
Canada

Thomas Peacock
Mechanical Engineer
Federal Railroad Administration
403 Verona Court
Millersville, MD 21108
Tel. 410-987-0237

Dennis Ramm
Metra
Chief Mechanical Officer

Kristine Severson
Mechanical Engineer
Structures and Dynamics Division
Volpe Center, DTS-76
55 Broadway
Kendall Square
Cambridge, MA 02142-1093
Tel. 617-494-2998
Fax 617-494-3616

Steve Soltis
National Resource Specialist
Crash Dynamics
Los Angeles Aircraft Certification Office
Federal Aviation Administration, ANM-102N
3229 E. Spring Street
Long Beach, CA 90806-2425

Roderick Smith
Department of Mechanical and Process
Engineering
Mappin Street
Sheffield S1 3JD
Tel. 0114 282 5522/5150/5151
Fax 0114 275 3671

Dr. Mark Snyder
Program Manager
Foster-Miller, Inc.
350 Second Avenue
Waltham, MA 02154-1196
Tel. 617-890-3489
Fax 617-890-3489

Dr. Thomas Tsai
Research Manager, Mechanical Systems
Office of Research and Development
Federal Railroad Administration, RDV-32
Nassif Building
400 7th Street, SW
Washington, D.C. 20590

David Tyrell
Moderator
Volpe Center
55 Broadway
Kendall Square
Cambridge, MA 02142-1093
617-494-2687

Marc Villemin
GEC Alstom Transport
3 Avenue des Trois Chenes
Belfort Cedex 90018
France

Dr. Herbert Weinstock
Chief
Structures and Dynamics Division
Volpe Center
55 Broadway
Kendall Square
Cambridge, MA 02142-1093

Clifford A. Woodbury, 3rd
Mechanical Engineer
LTK Engineering Services
2 Valley Square, Suite 300
512 Township Line Road
Blue Bell, PA 19422
Tel. 215-542-0700
Fax 215-542-7676

ATTENDEES

Anna M. Barry
Superintendent Orange Line
Maintenance
Mass. Bay Transportation Authority
Wellington Carhouse 37
Revere Beach Parkway
Medford, MA 02155
Tel. 617-222-5080
Fax 617-391-8333

Allen Bieber
Sr. Engineer-Locomotive
General Electric Co.
2901 East Lake Rd.
Tel. 814-875-2655
Fax 814-875-2395

George Brunner
Project Engineer-Viewliner
AMTRAK
100 N. 20th Street, Suite 300
Philadelphia, PA 19103
Tel. 215-349-3016
Fax 215-349-3832

Christine Beyer
Office of Chief Council
Federal Railroad Administration, RCC-31
Nassif Building
400 7th Street SW
Washington, D.C. 20590

John Carney
Provost
Worcester Polytechnic Institute
100 Institute Road
Worcester, MA 01609-2280
Tel. 615-322-0055
Fax 615-343-0670

David W. Carter
Director of Capital Projects-Locomotive
NJ Transit Corporation
One Penn Plaza East
Newark, NJ 07105
Tel. 201-491-7738
Fax 201-491-7905

Dick Cataldi
Sr. Program Manager
AAR
50 F Street, NW
Washington, D.C. 20001
Tel. 202-639-2261
Fax 202-639-2285

Thomas Clark
Director-Cars
NJ Transit Corporation
1148 Newark Turnpike
Kearny, NJ 07032
Tel. 201-955-5752
Fax 201-491-7905

Claudio Dallavalle
Manager of Engineering
Florida Overland Express
5950 Hazeltine National Drive
Citadel III Building, Suite 255
Orlando, FL 32822
Tel. 407-855-3421
Fax 407-855-5634

Joseph Davin
U.S. DOT/Volpe Center
55 Broadway
Cambridge, MA 02142-1093
Tel. 617-494-2512
Fax 617-494-2318

Harold S. Edris
Chief-Equipment Engineer
State of MD - Mass Transit Administration
6 Saint Paul
Baltimore, MD 21202
Tel. 410-767-3323
Fax 410-333-4810

E.R. English
Director
Office of Safety Enforcement
Federal Railroad Administration, RRS-10
Nassif Building
400 7th Street SW
Washington, D.C. 20590

Keith Falk
Director, Car Systems Engineering
New York City Transit
130 Livingston Street-2nd Floor
Brooklyn, NY 11202
Tel. 718-694-4485
Fax 718-488-6503

George Feinstein
Manager, Brake Systems Engineering
New York City Transit
130 Livingston Street-2nd Floor
Brooklyn, NY 11202
Tel. 718-694-4440
Fax 718-488-6503

Les Fiorenzo
Deputy Regional Director
Federal Railroad Administrator, DTS-906
55 Broadway
Kendall Square
Cambridge, MA 02142-1093

Daniel Foth
Executive Director
American Public Transit Association
1201 New York Avenue
Washington, D.C. 20005
Tel. 202-898-4113
Fax 202-898-4049

Paul Frazer
Senior Technical Project Manager
Massachusetts Bay Transportation Authority
Ten Park Plaza
Boston, MA 02116-3974
Tel. 617-222-5642

Russell D. Gaus
Staff Engineer
LTK Engineering Services
2 Valley Square, Suite 300
Township Line Road
Blue Bell, PA 19422
Tel. 215-542-0700
Fax 215-542-7676

Herbert Gould
Deputy Director
Office of Systems Engineering
Volpe Center, DTS-70
55 Broadway
Kendall Square
Cambridge, MA 02142-1093

James Grady
Manager-Locomotive Standards
CONRAIL
2001 Market Street (15D)
Philadelphia, PA 19101-1415
Tel. 215-209-4852
Fax 215-209-4912

Tesla Halen
MSC
Human Factors, Interior Design
Adtranz
Box 943, S-391 29 Kaknar
Kalmar, Sweden
Tel. 46480 62874
Fax 46480 27677

John Harrison
Vice President
Parsons Brinckerhoff
120 Boylston Street
Boston, MA 02116
Tel. 617-426-7330
Fax 617-482-8487

Jack E. Heiss
Railway Engineering Administrator
Florida Department of Transportation
605 Suwannee Street, M.S.
Tallahassee, FL 32399-0450
Tel. 904-487-4261
Fax 904-922-4942

Magnos Hermodsson
M.Sc. Eng. Phys.
ABB-Daimler Benz Transportation Trains
Div./Stress and Dynamics Analysis
Adtranz, P.O. Box 943 S-39129
Kalmar, Sweden
Tel. 01146-480-62833
Fax 01146-480-27679

John Hitz
Chief
Accident Prevention Division
Volpe Center, DTS-73
55 Broadway
Kendall Square
Cambridge, MA 02142-1093

Michael Huntley
Office of Safety Enforcement
Federal Railroad Administration, RSS-14
Nassif Building
400 7th Street, SW
Washington, D.C. 20590
Tel. 202-366-1458
Fax 202-366-7136

Michael Iden
Senior Director Technical Services
Union Pacific RR
1416 Dodge Street, Rm 900
Omaha NE 68179-0900
Tel. 402-271-6718
Fax 402-271-3210

Keith Ishigure
Vice President
Nippon Sharyo USA Inc.
375 Park Avenue, Suite 2806
New York, NY 10152
Tel. 212-755-2150
Fax 212-755-2257

Doug Karan
Sr. Industrial Designer
AMTRAK
100 North 20th Street
Philadelphia, PA 19103
Tel. 215-349-3873
Fax 215-349-3890

Scott Landrum
Manager Mechanical Engineering
Burlington Northern Santa Fe
2000 Continental Plaza
777 Main Street
Fort Worth, Texas 76102
Tel. 817-333-1203
Fax 817-333-6115

Jean Legait
SNCF-Rolling Stock Headquarters
15 Rue Traversiere
Paris, France 75012
Tel. 33-1-53-33-19-22
Fax 33-1-53-33-19-70

Ed Lombardi
Director-Performance & Tests
AMTRAK
30th & Market Streets
Philadelphia, PA 19104
Tel. 215-349-2748
Fax 215-349-4059

Dr. Gary Long
Associate Professor
University of Florida
Dept. Of Civil Engineering
P.O. Box 116580
Gainesville, FL 32611-6580
Tel. 352-392-0378
Fax 352-392-3224

Paul P. Lorek
Sr. Structures Engineer
American Passenger Rail Car Company
1 Transit Drive
Hornell, NY 14843
Tel. 607-324-2109
Fax 607-324-7090

John Lybas
Associate Professor
University of Florida
Dept. Of Civil Engineering
P.O. Box 116580
Gainesville, FL 32611
Tel. 352-392-5666
Fax 352-392-3394

William X. Lydon, Jr.
Director of Equipment
Southern California Regional Rail Authority
818 West Seventh Street, 7th Floor
Los Angeles, CA 90017
P.O. Box 86425
Los Angeles, CA 90086-0425
Tel. 213-244-6854
Fax 213-489-1469

Pat Malin
Project Engineer
AMTRAK
100 North 20th Street, Suite 300
Philadelphia, PA 19103
Tel. 215-972-5914
Fax 215-349-3832

D.W. Mayberry
Vice President-Research & Tests
Norfolk Southern Corporation
110 Franklin Road, S.E.
Roanoke, VA 24042-0002
Tel. 540-981-3231
Fax 540-981-5453

Thomas McDermott
Brotherhood Railway Carmen Division
Transportation Communications International
Union
1010 Market Street, 13th Floor
St. Louis, MI 63101
Tel. 314-621-8400
Fax 314-621-8843

Mark McKeon
Regional Director
Federal Railroad Administration, DTS-906
Volpe Center
55 Broadway
Kendall Square
Cambridge, MA 02142-1093

Daniel Metaut
GEC ALSTHOM TRANSPORT
Tour NEPTUNE
CEDEX 20
92086 PARIS LA DEFENSE
Tel. 33 1 41 26 98 60
Fax 33 1 41 26 99 90

Myles B. Mitchell
President
M.B. Mitchell & Associates, Inc.
11500 Henegan Place
Spotsylvania, VA 22553
Tel. 540-972-3432
Fax 540-972-0401

Howard Moody
Manager, Train Control
Association of American Railroads
50 F Street, N.W.
Washington, D.C. 20001
Tel. 202-639-2202
Fax 202-639-2465

George Neat
Chief
Vehicle Crashworthiness Division
Volpe Center, DTS-74
55 Broadway
Kendall Square
Cambridge, MA 02142-1093

Francis M. Nelson
Project Engineer
LTK Engineering Services
2 Valley Square, Suite 300
512 Township Line Road
Blue Bell, PA 19422
Tel. 215-542-0700
Fax 215-542-7676

James F. O'Kelly, III
Director of Engineering
American Passenger Rail Car Company
(AMERAIL)
1 Morrison Knudsen Drive
Hornell, NY 14843
Tel. 607-324-4595, Ext. 4188
Fax 607-324-2252

Phil Olekszyk
Dep Asso Administration
FRA Office of Safety
400 7th Street, SW
Washington, D.C. 20590
Tel. 202-366-0897
Fax 202-366-8984

Jim Parry
Assistant General President
Brotherhood Railway Carmen Division of
TCU
3 Research Place
Rockville, MD 20850
Tel. 301-948-4910
Fax 301-948-1369

Nicole Paulus
Consultant
Nickel Development Institute
3209 McKnight East Drive
Pittsburgh, PA 15208
Tel. 412-369-0377
Fax 412-367-2353

W.J. Peacock
Analyst
TASC
55 Walkers Brook Drive
Reading, MA 01867
Tel. 617-942-2000
Fax 617-942-7100

Benjamin Perlman
Professor
Tufts University
Dept. Of Mechanical Engineering
Medford, MA 02155
Tel. 617-628-5000, Ext. 2554
Fax 617-627-3058

Kurt Rindgen
Project Manager
AMTRAK
100 North 20th Street, Suite 300
Philadelphia, PA 19103
Tel. 215-349-3060
Fax 215-349-3832

Arthur Rosenwach
Manager, Engineering Design
American Passenger Rail Car Co.
(AMERAIL)
900 E. 103rd Street
Chicago, IL 60422
Tel. 312-264-9730, Ext. 326
Fax 312-264-2181

Gopal Samavedam
Division Manager
Foster-Miller, Inc.
350 Second Avenue
Waltham, MA 02154
Tel. 617-890-3200
Fax 617-890-3489

Robert Scarola
MP&E Inspector
DOT/Federal Railroad Administration
970 Broad Street Room 1435F
Newark, NJ 07102
Tel. 201-645-3069
Fax 201-645-6554

Sieghard Schneider
Systems Engineering, L31
Krauss-Maffei Verkehrstechnik GmbH
Krauss-Maffei-Str. 2
D-80997 Munich
Germany
Tel. 49-89-8899-3208
Fax 49-89-8899-4180

Rick Shultz
Manager/Product Safety & Environmental
Impact
GE Transportation Systems
2901 East Lake Rd. 14-3
Erie, PA 16531
Tel. 814-875-5559
Fax 814-875-2395

Jeffrey W. Simmons
SRI International
Program Manager
Menlo Park, CA 94025
Tel. 415-859-4495
Fax 415-859-2260

Tom Simpson
Vice President
Railway Progress Institute
700 N. Fairfax Street, #601
Alexandria, VA 22314
Tel. 703-836-6332
Fax 703-548-0058

Som P. Singh
Principal Investigator
Association of American Railroads
23W 230 Ozer Court
Naperville, IL 60540
Tel. 708-369-9372
Fax 708-369-9807

Roderick Smith
Professor
Advanced Railway Research Centre
University of Sheffield
Mappin Street
Sheffield, U.K. S1 3JD
Tel. 0114-282-5522
Fax 0114-275-3671

David Snyder
Manager-RR Services
Virginia Railway-Express
6800 Versar Center
Springfield, VA 22151
Tel. 703-642-3808
Fax 703-642-3820

Karen Spezzaferro
Reliability & Quality Analyst
TASC
55 Walkers Brook Drive
Reading, MA 01867
Tel. 617-942-2000
Fax 617-942-7100

Clive Thornes
Vehicles Manager
PB Transit & Rail Systems, Inc.
Two Gateway Center, 4th Floor
Newark, NJ 07102
Tel. 201-643-8100
Fax 201-648-0888

Dr. Frank F.C. Tung
Deputy Director
Volpe Center
55 Broadway
Kendall Square
Cambridge, MA 02142-1093

Cesar Vergara
Chief Designer
AMTRAK
100 North 20th Street
Philadelphia, PA 19103
Tel. 215-349-3878
Fax 215-349-3890

Harold B. Weisinger
Manager, Private Car Standards
AMTRAK Engineering Mechanical Service
Center
30th Street Station, 3rd Fl. North
Philadelphia, PA 19104
Tel. 215-349-1457
Fax 215-349-2767

Charles Whalen
Railroad Safety Inspector
Department of Transportation
Federal Railroad Administration
970 Broad Street Room 1435F
Newark, NJ 07102
Tel. 201-645-3065



