



U.S. Department of
Transportation

Federal Railroad
Administration

Positive Train Control Interoperability and Networking Research

Office of Research,
Development,
and Technology
Washington, DC 20590

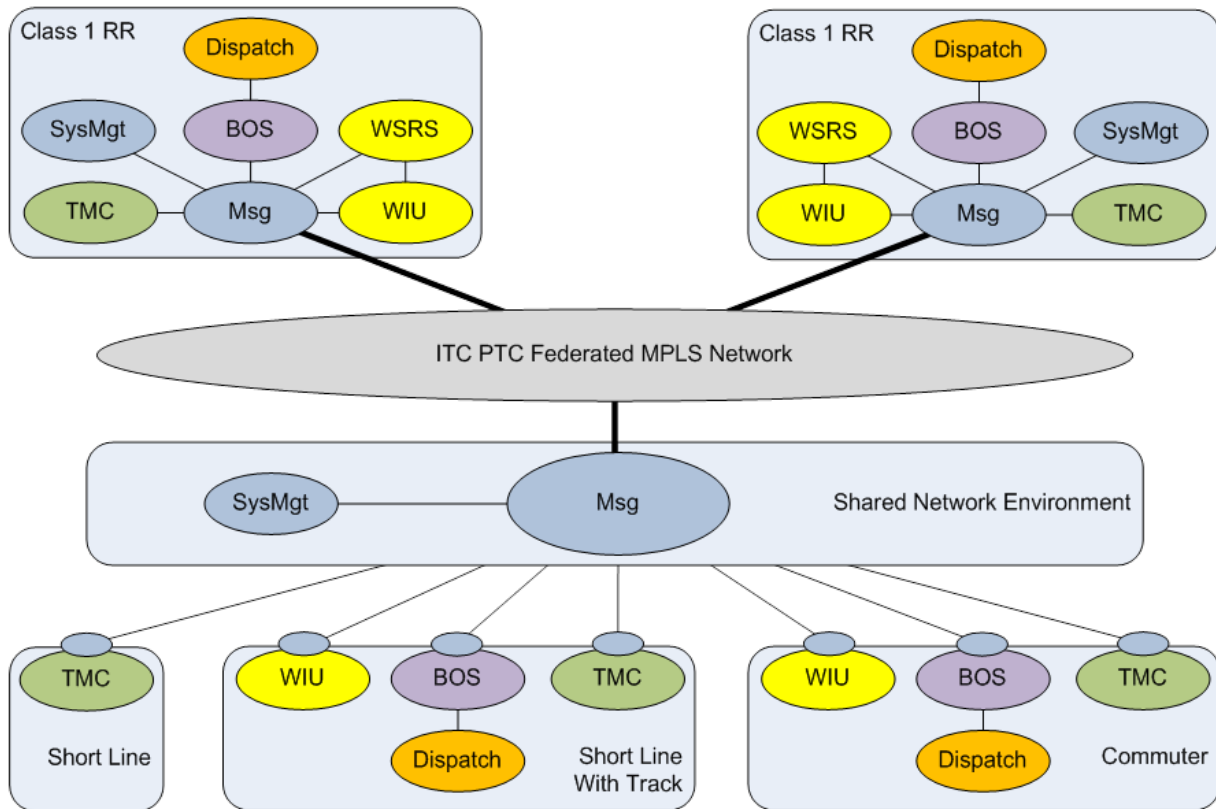

NOTICE

This document is disseminated under the sponsorship of the Department of Transportation in the interest of information exchange. The United States Government assumes no liability for its contents or use thereof. Any opinions, findings and conclusions, or recommendations expressed in this material do not necessarily reflect the views or policies of the United States Government, nor does mention of trade names, commercial products, or organizations imply endorsement by the United States Government. The United States Government assumes no liability for the content or use of the material contained in this document.

NOTICE

The United States Government does not endorse products or manufacturers. Trade or manufacturers' names appear herein solely because they are considered essential to the objective of this report.

REPORT DOCUMENTATION PAGE			<i>Form Approved</i> <i>OMB No. 0704-0188</i>	
Public reporting burden for this collection of information is estimated to average 1 hour per response, including the time for reviewing instructions, searching existing data sources, gathering and maintaining the data needed, and completing and reviewing the collection of information. Send comments regarding this burden estimate or any other aspect of this collection of information, including suggestions for reducing this burden, to Washington Headquarters Services, Directorate for Information Operations and Reports, 1215 Jefferson Davis Highway, Suite 1204, Arlington, VA 22202-4302, and to the Office of Management and Budget, Paperwork Reduction Project (0704-0188), Washington, DC 20503.				
1. AGENCY USE ONLY (Leave blank)		2. REPORT DATE December 2015		3. REPORT TYPE AND DATES COVERED Technical Report May 2012 – Sept 2014
4. TITLE AND SUBTITLE Positive Train Control Interoperability and Networking Research			5. FUNDING NUMBERS RR18D1/KLB05 RR18D1/KT880 RR18D1/LT880 RR18D1/MLK15	
6. AUTHOR(S) Rockwell Collins, Inc			8. PERFORMING ORGANIZATION REPORT NUMBER DOT-VNTSC-FRA-14-06	
7. PERFORMING ORGANIZATION NAME(S) AND ADDRESS(ES) Rockwell Collins, Inc			10. SPONSORING/MONITORING AGENCY REPORT NUMBER DOT/FRA/ORD-15/41	
9. SPONSORING/MONITORING AGENCY NAME(S) AND ADDRESS(ES) U.S. Department of Transportation Federal Railroad Administration Office of Railroad Policy and Development Office of Research and Development Washington, DC 20590				
11. SUPPLEMENTARY NOTES *TranSystems 38 Chauncy Street, Suite 200 Boston, MA 02111				
12a. DISTRIBUTION/AVAILABILITY STATEMENT This document is available to the public through the FRA Web site at http://www.fra.dot.gov.			12b. DISTRIBUTION CODE	
13. ABSTRACT (Maximum 200 words) This document describes the initial development of an ITC PTC Shared Network (IPSN), a hosted environment to support the distribution, configuration management, and IT governance of Interoperable Train Control (ITC) Positive Train Control (PTC) systems between short line and commuter railroads and Class I railroads. This effort is focused on ITC-compliant I-ETMS PTC Systems, which will allow the IPSN to support interoperability for train initialization and PTC-supported operations between tenant railroads and their host railroad partners and between host railroads while operating in each other's territory.				
14. SUBJECT TERMS Positive Train Control, PTC, Railroad, Shared Network, ITCM			15. NUMBER OF PAGES 72	
			16. PRICE CODE	
17. SECURITY CLASSIFICATION OF REPORT Unclassified	18. SECURITY CLASSIFICATION OF THIS PAGE Unclassified	19. SECURITY CLASSIFICATION OF ABSTRACT Unclassified	20. LIMITATION OF ABSTRACT	

METRIC/ENGLISH CONVERSION FACTORS

ENGLISH TO METRIC

METRIC TO ENGLISH

<p style="text-align: center;">LENGTH (APPROXIMATE)</p> <p>1 inch (in) = 2.5 centimeters (cm) 1 foot (ft) = 30 centimeters (cm) 1 yard (yd) = 0.9 meter (m) 1 mile (mi) = 1.6 kilometers (km)</p>	<p style="text-align: center;">LENGTH (APPROXIMATE)</p> <p>1 millimeter (mm) = 0.04 inch (in) 1 centimeter (cm) = 0.4 inch (in) 1 meter (m) = 3.3 feet (ft) 1 meter (m) = 1.1 yards (yd) 1 kilometer (km) = 0.6 mile (mi)</p>
<p style="text-align: center;">AREA (APPROXIMATE)</p> <p>1 square inch (sq in, in²) = 6.5 square centimeters (cm²) 1 square foot (sq ft, ft²) = 0.09 square meter (m²) 1 square yard (sq yd, yd²) = 0.8 square meter (m²) 1 square mile (sq mi, mi²) = 2.6 square kilometers (km²) 1 acre = 0.4 hectare (he) = 4,000 square meters (m²)</p>	<p style="text-align: center;">AREA (APPROXIMATE)</p> <p>1 square centimeter (cm²) = 0.16 square inch (sq in, in²) 1 square meter (m²) = 1.2 square yards (sq yd, yd²) 1 square kilometer (km²) = 0.4 square mile (sq mi, mi²) 10,000 square meters (m²) = 1 hectare (ha) = 2.5 acres</p>
<p style="text-align: center;">MASS - WEIGHT (APPROXIMATE)</p> <p>1 ounce (oz) = 28 grams (gm) 1 pound (lb) = 0.45 kilogram (kg) 1 short ton = 2,000 pounds (lb) = 0.9 tonne (t)</p>	<p style="text-align: center;">MASS - WEIGHT (APPROXIMATE)</p> <p>1 gram (gm) = 0.036 ounce (oz) 1 kilogram (kg) = 2.2 pounds (lb) 1 tonne (t) = 1,000 kilograms (kg) = 1.1 short tons</p>
<p style="text-align: center;">VOLUME (APPROXIMATE)</p> <p>1 teaspoon (tsp) = 5 milliliters (ml) 1 tablespoon (tbsp) = 15 milliliters (ml) 1 fluid ounce (fl oz) = 30 milliliters (ml) 1 cup (c) = 0.24 liter (l) 1 pint (pt) = 0.47 liter (l) 1 quart (qt) = 0.96 liter (l) 1 gallon (gal) = 3.8 liters (l) 1 cubic foot (cu ft, ft³) = 0.03 cubic meter (m³) 1 cubic yard (cu yd, yd³) = 0.76 cubic meter (m³)</p>	<p style="text-align: center;">VOLUME (APPROXIMATE)</p> <p>1 milliliter (ml) = 0.03 fluid ounce (fl oz) 1 liter (l) = 2.1 pints (pt) 1 liter (l) = 1.06 quarts (qt) 1 liter (l) = 0.26 gallon (gal) 1 cubic meter (m³) = 36 cubic feet (cu ft, ft³) 1 cubic meter (m³) = 1.3 cubic yards (cu yd, yd³)</p>
<p style="text-align: center;">TEMPERATURE (EXACT)</p> <p style="text-align: center;">[(x-32)(5/9)] °F = y °C</p>	<p style="text-align: center;">TEMPERATURE (EXACT)</p> <p style="text-align: center;">[(9/5) y + 32] °C = x °F</p>

QUICK INCH - CENTIMETER LENGTH CONVERSION

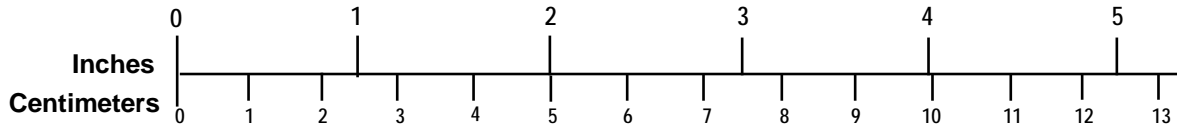

QUICK FAHRENHEIT - CELSIUS TEMPERATURE CONVERSION

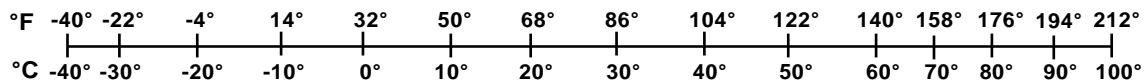

For more exact and or other conversion factors, see NIST Miscellaneous Publication 286, Units of Weights and Measures. Price \$2.50 SD Catalog No. C13 10286

Updated 6/17/98

Contents

CONTENTS.....	V
ILLUSTRATIONS.....	VII
TABLES.....	VIII
EXECUTIVE SUMMARY	1
1. INTRODUCTION.....	1
1.1 Scope of Document.....	1
1.2 References	1
1.3 Objectives.....	3
1.4 Activities.....	3
2. INDUSTRY OUTREACH ACTIVITIES	5
2.1 Approach to Outreach.....	5
2.2 Industry Contacts.....	5
2.2.1 Industry Associations.....	7
2.2.2 Short Lines	7
2.2.3 Commuter Railroads	7
2.3 Short Line and Commuter Railroad PTC Needs.....	8
2.4 Short Line and Commuter Railroad Concerns.....	8
3. IPSN CONCEPT OF OPERATIONS REVIEW	9
3.1 Data Flows to Be Supported.....	10
3.2 Major System Components and Interfaces with External Systems	14
3.3 IPSN Operational Concepts.....	17
3.4 IPSN-based Roles and Responsibilities.....	19
3.4.1 IPSN Users.....	19
3.4.2 IPSN Operator.....	20
3.4.3 Class I ITC Members	21
3.5 Summary of Operational Impacts	21
4. IPSN LAB ENVIRONMENT ENGINEERING, TEST AND DEMONSTRATION	26
4.1 Sprint Planning	26
4.2 Sprint 1.....	26
4.2.1 Objective	26
4.2.2 Engineering.....	27
4.2.3 Test and Demonstration	29
4.3 Sprint 2.....	30
4.3.1 Objective.....	30

4.3.2	Engineering	32
4.3.3	Test and Demonstration	33
4.4	Sprint 3.....	35
4.4.1	Objective	35
4.4.2	Engineering	37
4.4.3	Test and Demonstration	38
4.5	Sprint 4.....	38
4.5.1	Objective	38
4.5.2	Engineering	38
4.5.3	Test and Demonstration	39
5.	PROJECT FINDINGS	40
5.1	Concept of Operations Findings	40
5.2	IPSN Laboratory Findings.....	41
5.3	Findings from Potential IPSN Users	42
5.4	Research Questions: Summary of Project Findings	43
APPENDIX A. IPSN PROJECT QUAD CHART		46
APPENDIX B. IPSN PROJECT OUTREACH QUESTIONNAIRE		47
ACRONYMS		59
DEFINITIONS		61

Illustrations

Figure 1 ITC PTC Shared Network Concept	9
Figure 2 I-ETMS PTC Message Flows.....	11
Figure 3 ACSES PTC Message Flows	12
Figure 4 System Boundary of ITC PTC Shared Network Implementations	14
Figure 5 IPSN Major Components and External Interfaces for Tenant only Railroad.....	16
Figure 6 IPSN Major Components and External Interfaces for Host/Tenant Railroad	16
Figure 7 Sprint 1 Objective Environment.....	27
Figure 8 Illustration of Core Test Initialization Scenario	29
Figure 9 Sprint 2 Objective Environment.....	31
Figure 10 Core Test Configuration	34
Figure 11 Test Scenarios Validated	35
Figure 12 Sprint 3 Objective Environment.....	36

Tables

Table 1 Summary of Short Line Railroads Potentially Implementing PTC	6
Table 2 Summary of Commuter Railroad Contacts Potentially Implementing PTC.....	6
Table 3 Shared Network Expected Benefits	10
Table 4 IPSN Component Distributions	15
Table 5 Role and Responsibilities of Railroad ITC PTC Personnel in the IPSN Context	20
Table 6 Role and Responsibilities of IPSN Operator Personnel.....	21
Table 7 Role and Responsibilities of Class I ITC Members.....	21
Table 8 Tenant-Only I-ETMS Implementation Approach.....	23
Table 9 Host/Tenant I-ETMS Implementation Approach	24

Executive Summary

The ITC PTC Shared Network (IPSN) is a technological platform that supports the distribution, configuration management, and IT governance of Interoperable Train Control (ITC) Positive Train Control (PTC) systems among and between short line railroads, commuter railroads and Class I railroads. ARINC (Rockwell Collins) is developing a proof of concept system for this network environment, which is focused on ITC-compliant Interoperable Electronic Train Management System (I-ETMS) variant PTC Systems. The system will support interoperability for train initialization, handle PTC-supported operations between tenant railroads and their host railroad partners, and provide similar interoperability support between host railroads while operating in each other's territory.

The IPSN project's primary objective is to advance industry understanding and acceptance of the operational concepts of interoperability, configuration management, and IT governance that would support an ITC-shared messaging network infrastructure for smaller railroads that implement PTC. It seeks to support short line and commuter railroads that may not have the technical capability or staff to independently achieve full PTC implementation, and deliver the safety benefits with reduced program deployment and operational risks for the smaller railroads. Other key objectives for the project are to: (1) integrate and develop key elements of shared network infrastructure for short line and commuter rail interoperability with the Class I Railroads; (2) develop a concept of operations for the shared network; (3) validate the concept; and (4) provide a demonstration capability.

ARINC (Rockwell Collins) examined alternative ITC messaging topologies that would extend ITC messaging beyond the shared network environment for short line and commuter access across a simulated Multi-Protocol Label Switching (MPLS) link to a Class I back office server. Also, distribution of virtual machine technologies across more than one physical location, and introduction of a reliable message router capability to support shared network scalability were researched.

The team demonstrated:

- Train initialization using a real TMC (Train Management Computer) across the shared network environment
- Integration of systems management for asset monitoring and management
- Simulated message loading
- Provisioning of cellular and MPLS connections into the shared network environment.

Core findings include the following:

- ITC Messaging and ITC Systems Management functions can be hosted in a shared network environment.
- Initialization can be conducted across a shared network environment for a simulated short line or commuter locomotive to a simulated short line, commuter, or Class I back office.
- An IPSN can directly support the integration of technology and methodology in the development of ITC PTC message interoperability between the short line and commuter rails with the Class I railroads.

- The short line and commuter railroads have expressed a great deal of interest in the shared network concept. The PTC component and process allocations can help railroads plan for PTC deployment.

1. Introduction

1.1 Scope of Document

This is the final report on the ITC PTC Shared Network (IPSN), which is a hosted technological platform that supports the distribution, configuration management, and IT governance of Interoperable Train Control (ITC) Positive Train Control (PTC) systems between short line railroads, commuter railroads and Class I railroads. ARINC (Rockwell Collins) is initiating a proof of concept system for this network, which is focused on ITC-compliant Interoperable Electronic Train Management System (I-ETMS) PTC Systems, and it will support interoperability for train initialization and PTC-supported operations between tenant railroads and their host railroad partners, and provide similar interoperability support between host railroads while operating in each other's territory.

The IPSN supports the needs of short lines and commuters that may not have the technical capability or staff to independently support ITCM and a full PTC procurement, so it is focused on delivering PTC safety benefits with reduced operational deployment risks for the smaller lines. The concept of operations to support a shared network infrastructure for smaller railroads has not been demonstrated because a shared environment has great complexity in networking and PTC message flows.

The project is designed to develop descriptions of the major elements of the IPSN for a multi-railroad hosted environment that supports ITC PTC interoperability with Class I railroads. Tenant railroads that operate in PTC-equipped territories are mandated to support PTC message interoperability with their host railroads. Similarly, regional commuter and passenger railroads that dispatch PTC traffic must also support PTC message flows and operations. The IPSN has the potential to facilitate PTC interoperability by leveraging a shared network and centralized servers for handling and delivery of PTC messages between host and tenant railroads.

Included in this report is: (1) a summary of IPSN contract progress; (2) a summary of outreach activities relative to the IPSN project, including a review of identified short line and commuter railroad PTC needs and concerns; (3) a summary of the IPSN concept of operations; (4) IPSN architectural considerations and activities supporting demonstration of the IPSN concept; and (5) a summary of the overall project findings.

1.2 References

This section contains a complete list of the documents and other sources utilized to date for the IPSN project activities.

- 49 CFR Part 236 Subpart I, "Positive Train Control Systems; Final Rule", Docket No. FRA-2008-0132, 15 January 2010.
- National Railroad Passenger Corporation (Amtrak) PTC Implementation Plan, Revision 2.0, July 16, 2010.
- CSX Transportation, Inc. Positive Train Control Implementation Plan, Revision 1.02 (FRA-2010-0028-0012), July 8, 2010.
- Norfolk Southern Railway Positive Train Control Implementation Plan, Revision 1.3 (FRA-2010-0060-0012), July 9, 2010.

- ITC – System Reference Architecture, S9000-0110, Version 1.0, April 21, 2011.
- ITC – Systems Management Requirements, S9451, Version 2.54, June 28, 2013.
- Interoperable Electronic Train Management System (I-ETMS®) Positive Train Control Development Plan (PTCDP), Version 2.0 (FRA-2010-0028-0013), 1 June 2011.
- Positive Train Control Office-Locomotive Segment Interface Control Document (ICD), Release 2.11.1, Association of American Railroads, document dated October 26, 2012.
- Union Pacific Railroad Positive Train Control Implementation Plan, Version 2.1 (FRA-2010-0061-0021), March 11, 2013.
- BNSF Railway Electronic Train Management System PTC Implementation Plan (PTCIP), Version 1.8 (FRA-2010-0056-0161), 17 September 2013.
- FRA Positive Train Control Technical Bulletin PTC-14-01, Positive Train Control: Safety Plan (PTCSP) Review Guidance, 1 April 2014
- FRA Positive Train Control Technical Bulletin PTC-14-02, Monitoring and Audit Guidelines of Positive Train Control (PTC) System Functional Testing and Track Database Verification, 1 April 2014
- IEEE STD 1362-1998, IEEE Guide for Information Technology – System Definition – Concept of Operations (ConOps) Document - Description, IEEE Computer Society/Software & Systems Engineering Standards Committee, 22 December 1998.
- Benefits of a Shared Facility/Service, Dennis Lengyel, ARINC, WebEx presentation to APTA CEOs. September 12, 2012.
- PTC Communications Design and Implementation Alternatives, Henry McCreary, CSX, Presentation at the PTC Conference, St. Louis, MO., October 23-24, 2012.
- FRA/ARINC Meeting, Bill Everett, ARINC, Proprietary Meeting Presentation, January 23, 2013.
- White Paper prepared for BAA, Bill Everett, ARINC, March 12, 2013.
- ASLRRA PTC Symposium – How Does it all Work Together, Bill Everett, ASLRRA Technology Committee, Presentation at the ASLRRA PTC Symposium, Atlanta GA. April 28, 2013.

1.3 Objectives

The IPSN project's primary objective is to advance industry understanding of the operational concepts of interoperability, configuration management, and IT governance that would support an ITC-shared ITCM network infrastructure for smaller railroads that participate in PTC. Other key objectives for the project are to: (1) integrate and develop key elements of shared network infrastructure for short line and commuter rail interoperability with the Class I Railroads; (2) develop a concept of operations for the shared network; (3) validate the concept; and (4) provide a demonstration capability.

1.4 Activities

The IPSN will support the interoperability of PTC message exchange between the short line and commuter railroads and the Class I railroads by integrating technology and methodology together. The IPSN is designed to: (1) reduce the number of interconnections between Class I railroads and the smaller railroads, thus minimizing the required number of communication links to send and receive PTC messages to tenant railroads; and (2) provide centralized personnel and IT infrastructure to support the smaller railroads in PTC message transmission with their host railroads, thus providing efficiencies in manpower and technical ITCM implementation complexity. I-ETMS PTC as an overlay technology is intended to be integrated into existing short line and commuter infrastructure and operations through the IPSN, and continue to allow the smaller railroads to focus on their core operational objectives.

Development and testing of the prototype IPSN system has been organized as three Sprints. The work effort was planned to be spread across three phases of 13 weeks each, for a complete nine month project between October 2013 and July 2014. Each phase was expected to take approximately three months. The fundamental tasks for the project are described below.

- 1) Project Management – this task includes development of the project management plan (PMP), sprint planning, and industry coordination.
 - a. Project Management Plan – Effort to produce the IPSN PMP.
 - b. Sprint Planning – Planning cycle at the beginning of each sprint to plan the objectives for the sprint with key project personnel.
 - c. Project Coordination – Project management of day-to-day project activities and progress with project personnel.
- 2) Concept of Operations Development – this task includes the iterative development of a concept of operations for an ITC PTC Shared Network.
 - a. Draft Development – Objective deliverable of Sprint 1.
 - b. Update Development – Objective deliverable of Sprint 2.
 - c. Final Development – Objective deliverable of Sprint 3.
- 3) Project Participation – This task incorporates industry participation of the Federal Railroad Administration (FRA) and candidate Class I and commuter and short line railroads, incorporating industry outreach, laboratory capability participation, test participation, and demonstration participation.
 - a. Industry Outreach – Half day event at each Sprint cycle to present objectives of sprint and seek industry input.

- b. Lab Capability Participation – Participant collaboration during sprint integration and checkout.
 - c. Test Participation – Participant collaboration during lab testing.
 - d. Demonstration Participation – Participant collaboration at end of sprint cycle demonstration.
- 4) Laboratory Environment Engineering – This task incorporates the engineering of laboratory environment, including engineering development, integration and checkout of physical devices, building of virtual machines, installation of PTC simulators, and establishing connectivity for ITC interoperability testing and demonstration.
- a. Sprint 1 – Engineering for initial laboratory for ITC interoperability.
 - b. Sprint 2 – Extension to support Class I multi-domain interoperability.
 - c. Sprint 3 – Extension to support multiple short line/commuter and Class I interoperability.
- 5) Testing – This task incorporates testing of core aspects of interoperability and validation of the concept of operations of the shared network environment.
- 6) Demonstration – This task is a one day demonstration/deliverable of the sprint results.
- 7) Project Reporting – This task includes delivery of monthly one page project reports to the FRA. The final project report will be developed and submitted under this task.

The development and test activities of Sprint 1 through 3 have been completed. The contract was extended to September 30, 2014, and a fourth sprint was completed as well. This provided more time for industry outreach and more time for short line and commuter railroad discussions, which had proven difficult to schedule.

2. Industry Outreach Activities

This section summarized the approach to outreach of potential users of the IPSN; a review of the industry contacts made including industry associations, short lines, and commuter railroads; and a summary of PTC needs and concerns expressed by the short line and commuter railroads.

2.1 Approach to Outreach

The outreach approach as stated in our proposal to the FRA is:

"Following the initial planning for the Sprint, ARINC will conduct a Web-Ex based Industry Outreach Event. The event will incorporate an overview of the project objectives, the prioritized use cases to examine for the sprint, and the planned goals for test and demonstration. Candidate railroad participants will be invited to the outreach event, and participation solicited. ARINC intends to target at least one short line without field infrastructure, a commuter, and a short line with track and signals, all for interconnection to at least one Class 1 railroad. Feedback will be solicited and additional information assessed for inclusion with the current or subsequent sprint development. Following selection of core candidates, the participants will be invited to project activities, including participating in lab sessions for the development of the core shared environment capability, review and input of operational concepts, functional test participation, and demonstration participation.

The project participants are not subcontractors to the project, and will be expected to provide any time or travel involved with the project as in-kind contribution. The primary role of the project participants will be for review and feedback of the concept of operations and lab environment test and demonstration. Dependent on the project participant's level of contribution, ARINC may coordinate physical connectivity to the participant's facility – this effort would be pursued outside of the ITC PTC Shared Network. ARINC will supply simulated environments where real component connectivity cannot be obtained in a timely manner to support interoperable message traffic across the shared environment. This can be supported in a virtual machine environment without impacting the quality of configuration for test and demonstration. Participation and feedback will be encouraged throughout each sprint cycle, and feedback at the end of the cycle will be used as planning input for the subsequent cycle."

2.2 Industry Contacts

We have been discussing the project with individual railroads and the leadership of the Railroad Industry Associations since before the project started in October of 2013. We have been collaborating with the Industry Associations to develop a master list that includes key information and contacts for every railroad that must implement PTC. A comprehensive list of short lines and commuters that may be required to implement PTC is provided in Table 1 and Table 2, respectively. The short line list is expected to reduce in the total rail impact due to the final ruling on yard limits issued on August 22nd, but the exact impact of this ruling not been validated at the time of this report.

Aberdeen, Carolina & Western Rwy. Co.	Georgia & Florida Railway, LLC	Nebraska Kansas & Colorado Railway
Acadiana Railway Company	Georgia Central Railway, L.P.	New England Central Railroad, Inc.
Alabama & Gulf Coast Railway	Georgia Southwestern Railroad	New York, Susquehanna & Western Rwy.
Alabama Warrior Railroad	Golden Isles Terminal Railroad	North Shore Railroad Co.
Allegheny Valley Railroad Company	Grand Elk Railroad, LLC	Northern Lines Railway
Arizona & California Railroad	Grand Rapids Eastern Railroad, Inc.	Ohio Central Railroad Company
Arizona Eastern Railway Co.	Housatonic Railroad	Ozark Valley Railroad
Atlantic and Western Railway, L.P.	Idaho Northern & Pacific Railroad Co.	Paducah & Louisville Railway, Inc.
Buckingham Branch Railroad Company	Illinois Railway	Portland & Western Railroad
Buffalo & Pittsburgh Railroad, Inc.	Indiana & Ohio Railway Company	Providence & Worcester Railroad Co.
Buffalo Southern Railroad	Indiana Eastern Railroad	R.J. Corman Railroad Group
Burlington Junction Railway	Indiana Harbor Belt Railroad Co.	Reading Blue Mountain & Northern Railroad
California Northern Railroad	Indiana Northeastern Railroad Co., Inc.	Riceboro Southern Railway, LLC
Camp Chase Industrial Railroad	Indiana Rail Road Company	Richmond Pacific Railroad
Cascade & Columbia River Railroad	Indiana Southern Railroad, Inc.	Rochester & Southern Railroad, Inc.
Central Oregon & Pacific Railroad	Jackson & Lansing Railroad Company	San Joaquin Valley Railroad Co.
Central Railroad of Indiana	Kansas and Oklahoma Railroad	South Kansas & Oklahoma Railroad
Chattooga & Chickamauga Railroad	Kansas City Transportation Company LLC	Southwest Pennsylvania Railroad
Chicago, Ft. Wayne & Eastern Railroad	Kaw River Railroad	Springfield Terminal - Subsidiary of Pan Am Railways
Columbus & Ohio River Rail Road Co.	Keokuk Junction Railway	Stillwater Central Railroad
Commonwealth Railway, Inc.	Kyle Railroad Company	Tacoma Rail
Connecticut Southern Railroad	Louisiana & Delta Railroad, Inc.	Terminal Railroad Association of St. Louis
Conrail	Louisville & Indiana Railroad	Toledo, Peoria and Western Railway
Dakota & Iowa Railroad	Lycoming Valley Railroad Co.	Transkentucky Transportation Railroad, Inc.
Dallas, Garland & Northeastern Railroad	Marquette Rail, LLC	Twin Cities & Western Railroad
Depew, Lancaster & Western Railroad Co.	Minnesota Commercial Railway	Utah Railway Co.
Dubois County Railroad	Minnesota Northern Railroad	Wabash Central Railroad Corporation
East Brookfield & Spencer Railroad	Missouri & Northern Arkansas Railroad Co.	West Texas & Lubbock Railroad
East Penn Railroad, LLC	Mohawk Adirondack & Northern Railroad	Western New York and Pennsylvania Railroad
Eastern Idaho Railroad	Montana Rail Link	Wheeling & Lake Erie Railway
Florida Central Railroad Company	Morristown & Erie	Wichita Tillman & Jackson Railway
Florida Midland Railroad Company, Inc.	Nebraska Central Railroad Co.	

Table 1 Summary of Short Line Railroads Potentially Implementing PTC

Rail Runner Express	Tri-Rail	Westside Express Service
Capital MetroRail	Northstar Rail	FrontRunner
MBTA Commuter Rail	Music City Star	NCTD - Sprinter Service
Metra Commuter Rail	Shore Line East	NCTD - Coaster Service
NICTD - SouthShore	Metro-North Commuter	Caltrain
DART - Trinity Rail Express	Long Island Commuter Rail	Sounder Commuter Rail
A-Train Commuter Rail	Port Authority of New York & New Jersey	Altamont Commuter Express
Commuter Rail	New Jersey Transit Commuter Rail	Amtrak
SEMOG - MiTrain	SunRail Commuter Rail	MARC
Metrolink	SEPTA	Virginia Railway Express

Table 2 Summary of Commuter Railroad Contacts Potentially Implementing PTC

Class I Railroad status and plans

Class I Railroads need to clearly understand the project’s status so they can convey their support of the hosted concept when they interface with commuter and short line railroads. As a result, we emailed the PTC leadership of each Class I Railroad and asked them about their level of support for the Hosted concept, and their support continues to be very strong. After we received their responses, the team decided to follow up by scheduling face to face meetings with each Class I to provide detailed briefings on the project. A technical face to face session with CSX was provided on June 4th, and another meeting with Amtrak on May 27th. That meeting went very well and a visit to Annapolis for a deeper technical discussion is in progress. A follow up

management meeting is also being planned. AMTRAK expressed strong interest in a Hosted PTC Communications Service.

The Class I Railroads, in conjunction with Meteorcomm, held a two day working session June 23-24 at METRA in Chicago to discuss Interoperable Train Control Messaging (ITCM). We attended the meeting to discuss the project and learn more about ITC federation issues. In July we provided status to Union Pacific (UP) and also provided information about our outreach to-date that was used to support a meeting that UP planned to have with their short line partners in late August. Also in July we had discussions with BNSF that yielded direct recommendations and contact info for railroads they had recently spoken to. In August we were contacted by Norfolk Southern (NS) with a specific referral to a short line railroad they had recently met with. Bill Everett has subsequently met with that railroad. NS has asked to come to Annapolis to meet with us and view the demo.

Even with the Class I short line interaction mentioned above there are still many short line railroads that have not met with their Class I railroads on PTC.

2.2.1 Industry Associations

The Industry Associations our team continues to work with are AAR (Association of American Railroads), APTA (American Public Transportation Association) and ASLRRRA (American Short Line Railroad Association).

2.2.2 Short Lines

In his role as a member of the ASLRRRA Technology Committee since 2008, Bill Everett has facilitated the education of PTC for the ASLRRRA members. Bill has leveraged that relationship to brief the ASLRRRA members on the FRA Project. A by-product of those briefings has led to more detailed discussions with the two largest short line holding companies (WATCO and Genesee and Wyoming (G&W)). Those discussions are continuing with a working session and demonstration of our Proof of Concept (POC) system being planned at our Annapolis location for all ASLRRRA members needing to implement PTC.

Short Line Railroad Status and Plans

Bill Everett was invited to the North Carolina Railroad Association to present PTC and that session on May 14th went very well. At that session, a Board Member of the ASLRRRA Southern Region invited Bill to present at their Southern Region Meeting in October and present at the Eastern Region and Western Region meetings in September and November as well. The working session with Genesee & Wyoming, WATCO, and other short line railroads is currently being planned. We conducted weekly conference calls to develop the agenda and plan for the meetings, with the Hosted PTC Communications project as the centerpiece of the meeting's agenda. We are reaching out to individual Short lines not owned by G&W and WATCO to discuss the project and to participate in working sessions.

2.2.3 Commuter Railroads

APTA has been a strong advocate of this project since the beginning and has provided contacts and opportunities to communicate with the railroads. There have been two briefings with the commuter rail CEOs and individual discussions with commuter railroads. Additionally, we met the commuter CEOs at the APTA Rail Conference (June 15-18, 2015) in Montreal and briefed them there.

Commuter Railroad Status and Plans

The chair of the Commuter Railroad CEO Committee requested FRA to talk with the committee directly about the project. We worked with Lou Sanders of APTA to define the committee's questions for the Commuter CEO meeting in conjunction with the APTA Rail Conference in Montreal. In addition to the Montreal meeting and briefing at the full conference, we have had detailed meetings with Dallas Area Rapid Transit (DART) and New Jersey Transit. Additionally, we met with METRA at the RSSI Expo in Nashville in May 2014. METRA is interested in the project and a follow up discussion is planned. Follow up meetings with MARC and VRE are also planned.

2.3 Short Line and Commuter Railroad PTC Needs

Short Line Railroad Needs – The short line railroads need education and assistance in planning for PTC. It is also important that discussions with their Class I host railroads begin as soon as possible so they understand the requirements from the host railroad to effectively plan. They need a cost effective approach to implement PTC, because it is a true financial burden for these railroads.

Commuter Railroad Needs – The cost of PTC is significant for the commuter railroads and it severely impacts the status of good repair initiatives for their public infrastructure. Because they are directly named in the legislation, Commuter railroads have launched PTC projects and are investing in the technology. They are in dire need of a cost-effective solution for PTC and we have received high interest from the railroads that we have talked to.

2.4 Short Line and Commuter Railroad Concerns

We have received positive feedback on the concept of a shared PTC Communications environment from almost everyone in the industry that we have communicated with. However, it is still uncertain how the commuter and short line railroads are going to pay for this.

Short Line Railroads – The short line railroads need direct guidance from their Class I Host Railroads so they can start the planning process. If funding could be allocated to help all the short line railroads who are required to implement PTC with planning, that would be the most efficient approach to this task. The final ruling on yard limits was just issued on August 22nd, and it has helped resolve the uncertainty that had been affecting the short line railroads decision making and their level of engagement.

Commuter Railroads – Most of the larger commuter railroads have launched their PTC Projects or are planning to launch them soon. As previously stated, the Chair of the Commuter Railroad CEO Committee asked to talk directly to the FRA regarding the Hosted PTC Project. We think that discussion has provided some guidance on how the project can move forward.

3. IPSN Concept of Operations Review

The IPSN concept is illustrated in Figure 1. PTC can be integrated into existing short line and commuter infrastructure and operations as an overlay technology, and the IPSN is an aggregation of PTC component implementation that should consolidate PTC message exchange and operational practices. The IPSN is expected to reduce technical and operational integration across short line and commuter railroads with their host railroads, support improvements to both capital outlay for each railroad to develop independent solutions, and improve overall operating methods and safety through maximized standardization of interface, configuration management, and IT governance methodologies.

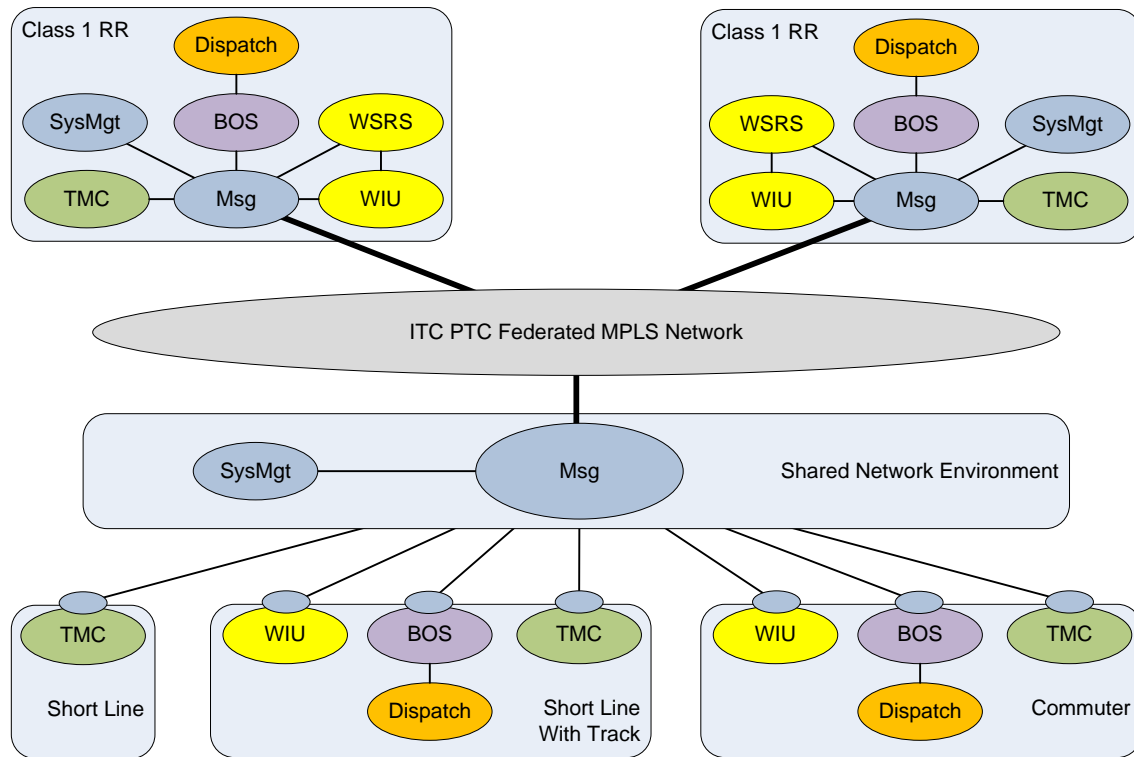

Figure 1 ITC PTC Shared Network Concept

Developing the shared network is anticipated to provide benefits identified in Table 3.

Shared Network Environment Expected Benefits	Short Lines	Commuters	Class 1 Rails	FRA
Reduce investment in IT human or computer resources	x	x		
Reduce effort to implement infrastructure functions among multiple organizations	x	x	x	
Reduce resources needed for testing	x	x		x
Reduce technical training and support requirements	x	x		
Focus on more operational oriented components of PTC	x	x		
Simplify asset/software configuration management	x	x		
Centralize alarm reporting, management, and resolution	x	x		

Table 3 Shared Network Expected Benefits

3.1 Data Flows to Be Supported

The core use cases for ITC PTC interoperability support message flow across a common ITC compliant messaging and systems management fabric. These message flows incorporate application message traffic between the ITC PTC back office, locomotive, and wayside components. The message traffic has specific use case scenarios for PTC operation, such as train initialization and train departure. The Concept of Operations development effort is integral with the sprint planning; once the PTC operational use cases were evaluated for direct relevance to short line and commuters they were prioritized for sprint implementation. A priority use case in the context of a short line is a short line locomotive initialization on a short line yard or interchange, and the required PTC information flows to the Class I host railroad back office for PTC train initialization.

Tenant railroads – both short lines and commuter railroads - that operate in PTC territories are mandated to support PTC message interoperability with their host railroads. Regional commuter and passenger railroads that dispatch PTC traffic additionally also must support PTC message flows and operations. The Concept of Operations defined the potential to facilitate PTC interoperability by leveraging a shared network and centralized servers for handling and delivery of PTC messages between host and tenant railroads.

In the Concept of Operations analysis, context diagrams have been developed for core I-ETMS PTC message flows and core Advanced Civil Speed Enforcement System (ACSES) PTC message flows, which are shown as overlays on existing legacy systems in Figure 2 and Figure 3, respectively.

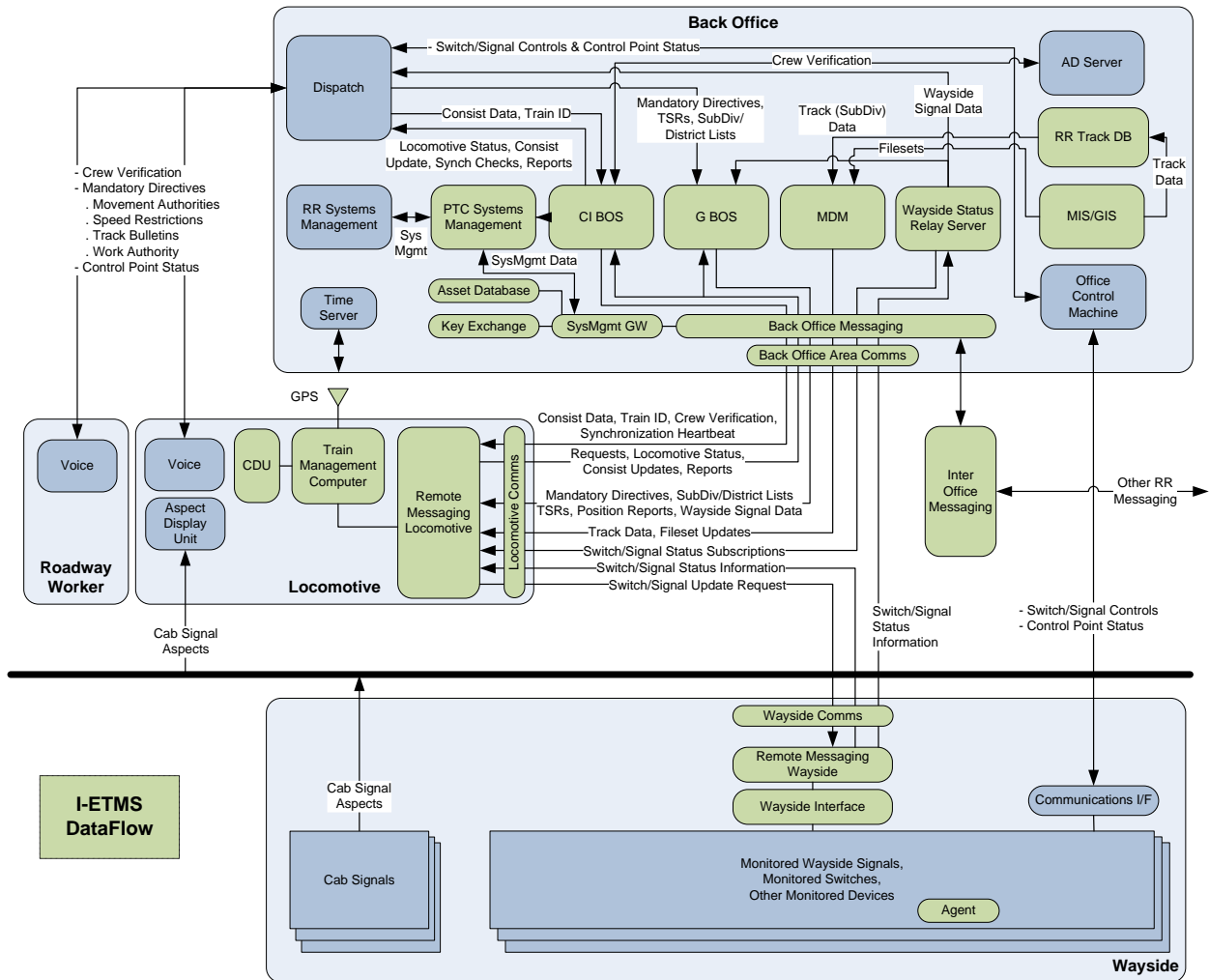

Figure 2 I-ETMS PTC Message Flows

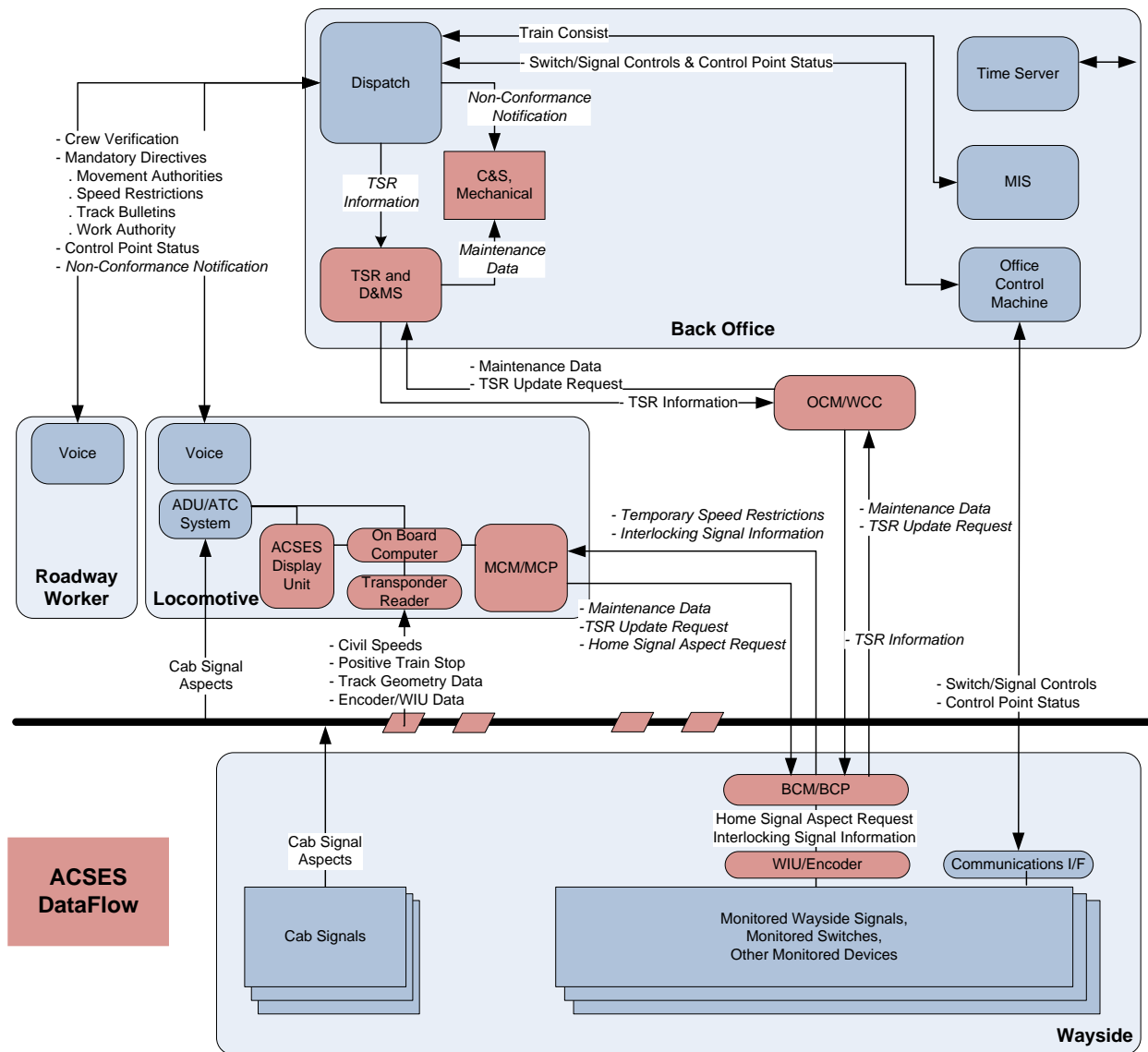

Figure 3 ACSES PTC Message Flows

When the message flows were analyzed, priorities were placed on maximizing the principles of PTC interoperability based on the ITC System Reference Architecture. The ITC host railroads will extend the principles of ITC PTC interoperability to tenant railroads that are other ITC Class I railroads, short line tenants, and commuter railroad tenants. The ITC member PTC implementation plans use standard terms for ITC PTC interoperability with tenants, based on Type Approval FRA-TA-2011-02, to ensure that:

- PTC technical solutions will meet the requirements of interoperability as defined in 49 Code of Federal Regulation (CFR) Part 236.1003(b).
- Functionality and interoperability is tested by participating in a PTC testing program.
- Any technology exchange that is needed to implement PTC is done in accordance with applicable FRA requirements.

Additionally, the Class I Joint Railroad Safety Team (JRST) is pursuing an abbreviated risk assessment, using the I-ETMS Risk Assessment Methodology, to establish that I-ETMS is compliant with requirements §236.1015(e)(2) *Vital Overlay*, and Acronyms of Part 236. Deployment and operation of the ITC PTC Shared Network concept will be aligned with the ITC members to support native I-ETMS based interoperability over a shared network infrastructure. In this approach to developing the IPSN Concept of Operations, it is anticipated that the PTC Safety Critical and Non-Safety Critical functions of the ITC members' PTC development plans can be adapted with minimal or no variance. To date, these functions have been identified as applied to a shared network deployment and are under review.

As the data flows to be supported by the IPSN were defined, it became essential to distinguish railroad locomotive equipment and back office configurations. The primary objective of the IPSN is ITC (I-ETMS) PTC interoperability for an I-ETMS equipped locomotive entering and operating on ITC PTC Track. PTC function and process allocation is currently being conducted across five primary types of PTC operation (divided into hosts and commuters):

- *Short Line Hosts* who own or dispatch I-ETMS PTC Track.
- *Commuter Hosts* who own or dispatch I-ETMS PTC Track.
- *Commuter ACSES Hosts* who also own or dispatch ACSES PTC Track.
- *Short Line Tenants* who do not own or dispatch I-ETMS PTC Track.
- *Commuter Tenants* who do not own or dispatch I-ETMS PTC Track.

Preliminary investigations have been conducted on interoperability aspects of I-ETMS PTC and ACSES PTC systems. Three means of I-ETMS/ACSES technical interoperability are under consideration for future investigation—because they are beyond the initial scope of ITC PTC interoperability within an ITC PTC shared network—and they are:

- Dual equipping locomotives
- Dual equipping waysides
- Dual equipping waysides and offices

As an example, a promising method that would provide I-ETMS locomotive interoperability on ACSES track is to deploy dual-equipped waysides along the ACSES track. This solution would be integrated to ensure ACSES temporary service restrictions from a Temporary Speed Restriction (TSR) server, which would convey through the I-ETMS back office service to the I-ETMS locomotive, and ACSES track would be surveyed for ITC RR Database deployment. This method of ACSES/I-ETMS interoperability might be deployed without significant impact to the IPSN, as long as the Temporary Speed Restriction (TSR) input to the I-ETMS BOS could be made available within the hosted network. Potentially, other methods would be required to support ACSES-equipped locomotive on ITC PTC track. These advanced PTC interoperability topics are beyond the immediate scope of the IPSN investigation.

Based on the primary types of PTC operation over the IPSN that have been identified, we have evaluated the allocation of PTC components and system processes, and the impact on I-ETMS safety/non-safety critical functionality, to determine the IPSN system boundaries for deployment and data flows to be supported. The IPSN (depicted in Figure 4) is a grouping of ITC PTC functions that can be integrated to support multiple railroads and maximize the use of the ITC PTCDP approach for Part 49 Subpart 236 compliance. These collections, or aggregations of

PTC functionality, are not safety overlays, but aggregations of PTC deployment for shared community benefit. They use the safety assurance concepts and PTC functions as needed and defined in the ITC PTC Development Plan.

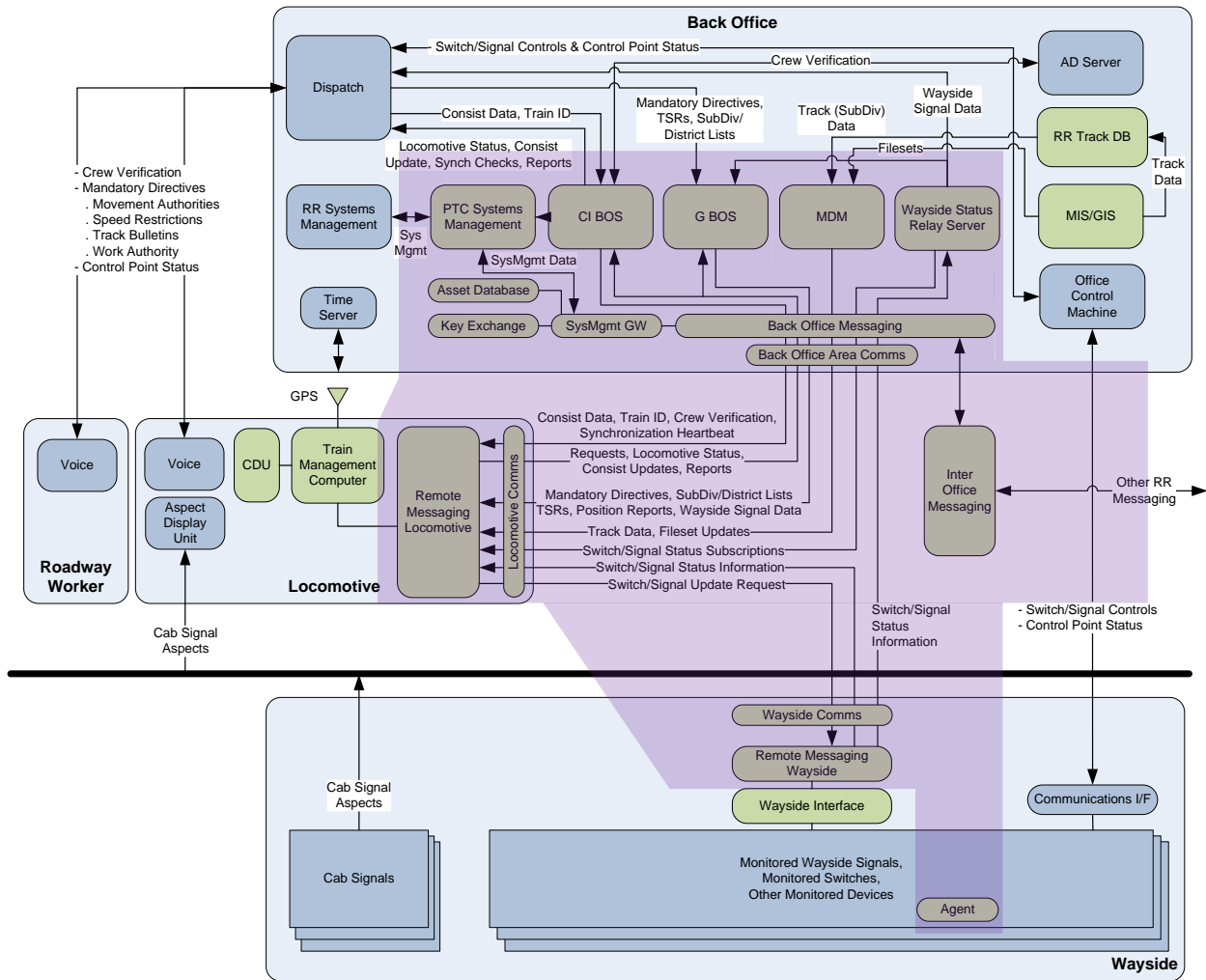

Figure 4 System Boundary of ITC PTC Shared Network Implementations

3.2 Major System Components and Interfaces with External Systems

When the project examined the core PTC message flows meant to support the IPSN, ARINC evaluated the major IPSN system components and interface with external systems (which were mapped to the needs of a Tenant-only railroad and a Tenant/Host railroad). Candidate railroads were involved in discussions of PTC component allocations, and the results were iteratively integrated into the functionality table to ensure the ITC PTC functional composition and safety assurance concepts are kept intact, and to minimize any potential variances to the ITC PTCDP. These components are shown in Table 4. Figure 5 and Figure 6 expand the IPSN concept for its

interoperable aspects to external systems, including other railroads. These external interfaces were further developed and are discussed in the Concept of Operations document.

IPSN Component	Function	Tenant RR IPSN	Host/Tenant RR IPSN
Back Office Messaging	Message transmission for the railroad back office	◆	◆
Inter Office Messaging	Message transmission between assets and railroad back offices	◆	◆
Sys Mgmt Gateway	Messaging Systems Management	◆	◆
Crew Interaction BOS	Railroad Initialization and Crew Reports	◆	◆
Mobile Device Manager	Onboard File Information and Transfer	◆	◆
Systems Management	Remote Asset Monitoring and Control	◆	◆
Asset Database	Registry of railroad assets	◆	◆
Key Exchange Server	Security keys with datastore	◆	◆
Geographic BOS	SubDiv/District Mandatory Directives		◆
Wayside Status Relay	Subscription based Wayside Status		◆
Remote Messaging – Locomotive	Message transmission for the railroad’s remote locomotive assets	◆	◆
Remote Messaging – Wayside	Message transmission for the railroad’s remote wayside assets		◆
Back Office Area Communications	Communications infrastructure at the IPSN in support of railroad remote asset connectivity	◆	◆
Locomotive Communications	Communications infrastructure at the railroad yard in support of railroad back office connectivity	◆	◆
Wayside Communications	Communications infrastructure at the railroad wayside in support of railroad back office and locomotive connectivity		◆

Table 4 IPSN Component Distributions

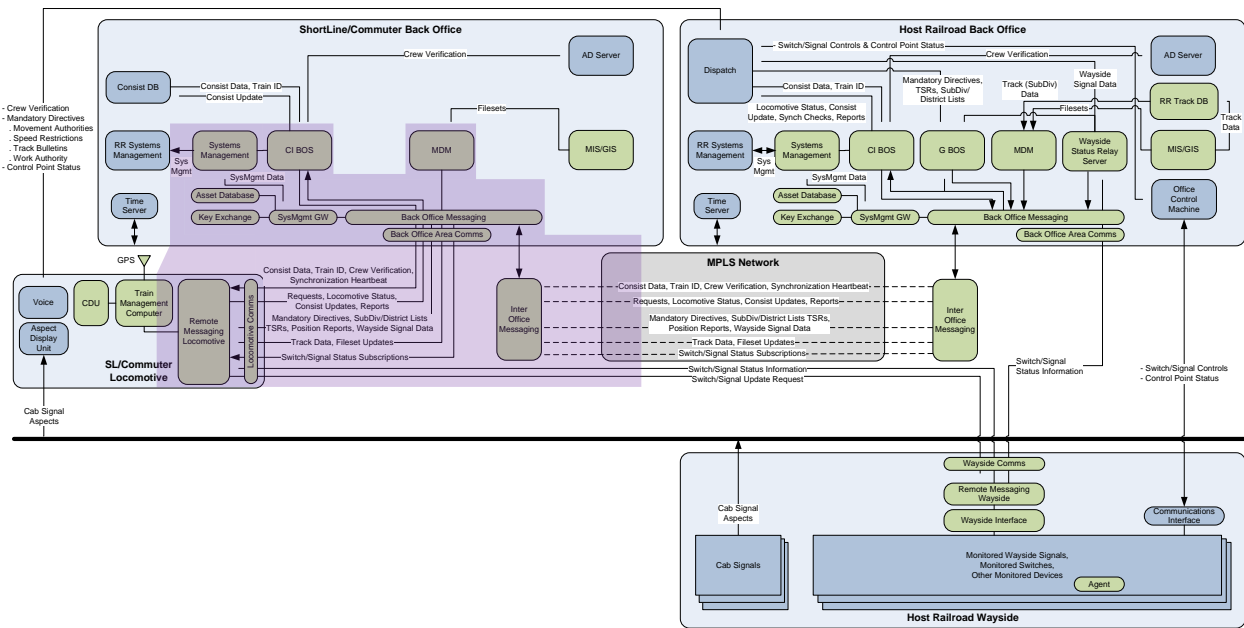

Figure 5 IPSN Major Components and External Interfaces for Tenant only Railroad

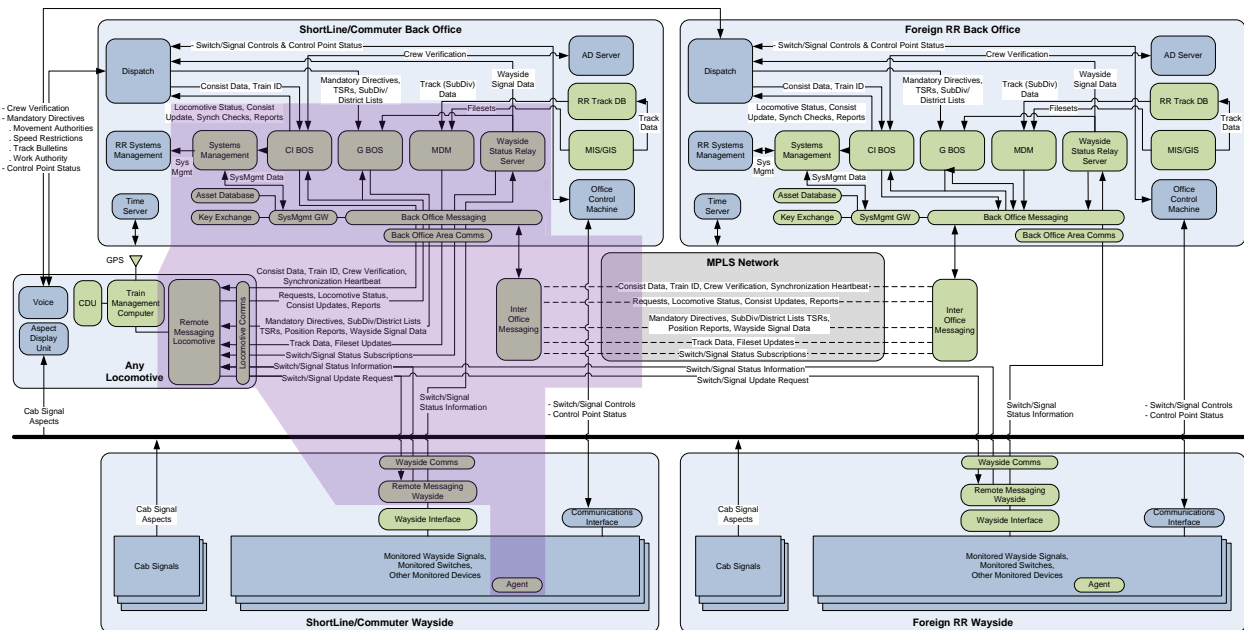

Figure 6 IPSN Major Components and External Interfaces for Host/Tenant Railroad

3.3 IPSN Operational Concepts

The existing I-ETMS operational concepts and railroad operations under I-ETMS were analyzed, and they were applied to specific IPSN operational concepts for multiple railroad utilization. When the potential changes to the I-ETMS Operational Concepts, as provided in version 2.0 of the ITC PTC Development Plan (FRA-2010-0028-0013), were reviewed, the changes included the complete set of I-ETMS operational concepts, and the impact of railroad operations under I-ETMS:

- Underlying Methods of Operation
- Locomotive Segment Operating States
- Display of Information in the Locomotive Cab
- Track Database
- Data Integrity and Authentication
- Interfaces and Data Synchronization – Wayside-Locomotive Segment
- Interfaces and Data Synchronization – Wayside-Office Segment
- Interfaces and Data Synchronization – Office Locomotive Segment
- Interfaces and Data Synchronization – Dispatching-Office Segment
- Handling of Time Zones
- Personnel Roles and Responsibilities
- Locomotive Segment Initialization
- Departure Test
- Consist Data Management
- Train Navigation
- Train Movement
- Speed Limits and Restrictions
- Work Zones
- Malfunctioning Highway Grade Crossing Warning Systems
- Tracks Out of Service
- Miscellaneous Track Bulletins
- Route Integrity Protection
- Warning and Enforcement
- Parking Brake
- Train Handling Exception Monitoring
- Horn Protection
- Energy Management
- I-ETMS Equipment Failures and Effects

All I-ETMS-based operational concepts will remain identical to the IPSN operation concept; either with no change or additional impact, or certain PTC back office functions will be located at an IPSN-located server instead of a server located at the host railroad. The physical location

of these functions at the IPSN modifies the personnel roles and responsibilities by shifting some host railroad functions to the IPSN, aiding to reduce the railroad personnel requirements. In all cases of railroad operations under I-ETMS, no major variances to railroad operations under I-ETMS are introduced with utilization of the IPSN.

Additional operational concepts to support the collection of I-ETMS functionality in a shared environment for multiple railroad utilization were evaluated, and are discussed in the Concept of Operations document. These core functions and operations of the IPSN include:

- Interoperability
- Messaging Implementation
- Back Office Server and Dispatch Implementation
- Systems Management
 - Security Management
 - Data Management
 - Monitoring, Diagnostics, and Notifications
 - File Transfer and Kit Dissemination
 - Configuration Management and IT Governance
 - Trouble Ticketing and Help Desk
- IPSN Expandability, Availability and Continuity of Operations
- Safety Provisioning
- PTC Testing and Certification
- IPSN Adaptability

3.4 IPSN-based Roles and Responsibilities

3.4.1 IPSN Users

The roles and responsibilities of railroad personnel involved with operation or maintenance of ITC PTC systems *in the IPSN context* are detailed in Table 5

Role	Responsibility
Train Crew	<p>Conductor provides general direction and train government. Engineer provides authority or safety of proceeding. Conductor and Engineer equally responsible for:</p> <ul style="list-style-type: none"> • Safety and proper operation of the train. • Keeping records of all mandatory directives in effect. • Use of signals and other precautions as case requires. <p>Engineer is charge of engine and proper handling of train/engine:</p> <ul style="list-style-type: none"> • In charge of train in absence of the Conductor. • Initializes and operates the I-ETMS locomotive segment. <p>Conductor, Engineer, and other crew acting as pilot are responsible for safety of the train, observance of rules, and taking all precaution for protection.</p>
Train Dispatcher or Control Operator	<p>Responsible for supervising safe and efficient movement of trains, engines, roadway workers, or machines on Main or other controlled track.</p> <p>Handle and establish protection in accordance with §236.1029 in event of en-route failure of the I-ETMS Locomotive Segment apparatus.</p> <p>Respond to alerts generated by I-ETMS provided to the dispatching system.</p>
Roadway Workers	<p>Roadway Workers are responsible for inspection and maintenance of railroad physical plant.</p> <p>Maintenance of Way personnel conducts construction, inspection, and maintenance of the track structure.</p> <p>All Roadway workers obtain authority of other bulletined protection from dispatcher or control operator before occupying or fouling Main or other controlled track to perform work.</p> <p>Roadway worker in charge responsible for authorizing safe movement of trains through work zone limits under their control.</p> <p>Coordinate changes resulting in work that might impact the I-ETMS track file database.</p>
Signal Personnel	<p>Conducts design, construction, inspection and maintenance of signal systems.</p> <p>Conduct design, installation, operation, inspection, and maintenance of wayside interface units and their interconnection with signal systems.</p> <p>Coordinate changes resulting in work that might impact the I-ETMS track file database.</p> <p>May conduct work on railroad right-of-way under protection described for Roadway Workers.</p>

Role	Responsibility
Mechanical Personnel	Responsible for inspection and maintenance of railroads rolling stock. Responsible for installation, inspection and maintenance of the I-ETMS Locomotive Segment apparatus and locomotive communications subsystems (excepting maintenance of locomotive messaging subsystems if supported through the IPSN).
Telecommunications Personnel	Responsible for operation, inspection, and maintenance of railroad's specific telecommunications facilities for interconnection to the IPSN. Responsible for installation, inspection, operation and maintenance of the communication systems utilized by I-ETMS (<i>excepting if these systems are supported through the IPSN</i>). May conduct work on railroad right-of-way under protection described for Roadway Workers.
Other Office Technical Personnel	Responsible for operation and maintenance of railroad's computerized operating systems. Responsible for installation, operation and maintenance of the back office server infrastructure (if BOS is hosted at the railroad's facility) Responsible for final production and configuration management of the I-ETMS track database.
First Line Supervisors	Responsible for monitoring job performance of personnel under their direction Trained as to the PTC-related duties of the personnel under their direction.

Table 5 Role and Responsibilities of Railroad ITC PTC Personnel in the IPSN Context

3.4.2 IPSN Operator

Roles and responsibilities of IPSN personnel involved with operation or maintenance of the IPSN are detailed in Table 6 on the next page.

Role	Responsibility
Telecommunications Personnel	Responsible for coordination of railroad's specific telecommunications facilities for interconnection to the IPSN Responsible, if supported by the IPSN and elected by the railroad, for installation, inspection, operation and maintenance of the communication systems utilized by I-ETMS for connection to the IPSN Responsible for installation and maintenance of IPSN connections to the ITC PTC

Role	Responsibility
	MPLS (Multi-Protocol Label Switching) Federated network
Other Office Technical Personnel	Responsible for operation and maintenance of IPSN computerized operating systems Responsible for systems management of IPSN hosted and managed components Responsible for installation, operation and maintenance of the back office server infrastructure (if supported by IPSN and elected by the railroad) Responsible for configuration management and IT governance of the IPSN hosted and managed components
First Line Supervisors	Responsible for monitoring job performance of personnel under their direction Trained as to the PTC-related duties of the personnel under their direction.

Table 6 Role and Responsibilities of IPSN Operator Personnel

3.4.3 Class I ITC Members

Additional roles and responsibilities of Class I ITC Members involved with IPSN implementation are detailed in Table 7.

Role	Responsibility
Telecommunications Personnel	Acceptance of the IPSN into the ITC PTC MPLS Federated network
Other Office Technical Personnel	Finalization of industry IT governance model

Table 7 Role and Responsibilities of Class I ITC Members

3.5 Summary of Operational Impacts

A short line or commuter railroad mandated to implement PTC has three primary courses of action to develop an I-ETMS solution encompassing the back office, locomotive, wayside, and communication subsystems:

- Implement a standalone I-ETMS solution
- Implement through a Class I ITC member's I-ETMS solution
- Implement through the IPSN

Table 8 and Table 9 highlight the core development requirements of the alternative implementation approaches for a short line or commuter railroad that only traverses other railroads' I-ETMS certified track segments (tenant-only railroad), or for a short line or commuter

railroad that owns or operates an I-ETMS certified track segment in addition to traversing other railroads I-ETMS track segments (host/tenant railroad).

Implementation Approach	Standalone I-ETMS Solution	Through Class I ITC	Through IPSN
Back Office Subsystem	<p>Railroad: License, install, and maintain Calyon International Back Office System (CI-BOS) and Mobile Device Management (MDM) at own facility</p> <p>License, install and maintain PTC systems management at own facility (Security, Data Management, Monitoring, File/Kit Transfers, Configuration Management, Trouble Ticketing/Help Desk)</p>	<p>Railroad: License, install, and maintain CI-BOS and MDM at own facility</p> <p>License, install and maintain PTC systems management at own facility (Security, Data Management, Monitoring, File/Kit Transfers, Configuration Management, Trouble Ticketing/Help Desk)</p>	<p>Railroad: License CI-BOS and MDM</p> <p>IPSN: Install and maintain CI-BOS and MDM at IPSN</p> <p>License, install and maintain PTC systems management at IPSN (Security, Data Management, Monitoring, File/Kit Transfers, Configuration Management, Trouble Ticketing/Help Desk)</p>
Locomotive Subsystem	<p>Railroad: License, install, and maintain Locomotive subsystem (Train Management Computer (TMC) and related PTC equipment)</p>	<p>Railroad: License, install, and maintain Locomotive subsystem (TMC and related PTC equipment)</p>	<p>Railroad: License, install, and maintain Locomotive subsystem (TMC and related PTC equipment)</p>
Communications Subsystem	<p>Railroad: License, install, and maintain PTC messaging at own back office and on locomotives</p> <p>Install and maintain communications from own locomotives to own back office</p> <p>Install and maintain federated connections to PTC MPLS network</p>	<p>Railroad: License, install, and maintain PTC messaging at own back office and on locomotives</p> <p>Install and maintain communications from own locomotives to own back office</p> <p>Class I ITC Railroad: Install and maintain federated connections to PTC MPLS network</p>	<p>Railroad: License PTC messaging</p> <p>Coordinate with IPSN for Install and maintain communications from own locomotives to IPSN and from IPSN to back office</p> <p>IPSN: Install and maintain federated connections to PTC MPLS network</p> <p>Potentially install and</p>

Implementation Approach	Standalone I-ETMS Solution	Through Class I ITC	Through IPSN
			maintain PTC messaging at IPSN and on locomotives Potentially install and maintain communications from locomotives to IPSN and from IPSN to back office
Wayside Subsystem	n/a	n/a	n/a

Table 8 Tenant-Only I-ETMS Implementation Approach

Implementation Approach	Standalone I-ETMS Solution	Through Class I ITC	Through IPSN
Back Office Subsystem	<p>Railroad: License, install, and maintain CI-BOS, Global Back Office System (G-BOS) and MDM at own facility</p> <p>License, install, and maintain WSRS at own facility (optional)</p> <p>License, install and maintain PTC systems management at own facility (Security, Data Management, Monitoring, File/Kit Transfers, Configuration Management, Trouble Ticketing/Help Desk)</p> <p>Develop RR Track Database</p> <p>Develop Railroad Dispatch to BOS Interface</p>	<p>Railroad: License, install, and maintain CI-BOS, G-BOS and MDM at own facility</p> <p>License, install, and maintain WSRS at own facility (optional)</p> <p>License, install and maintain PTC systems management at own facility (Security, Data Management, Monitoring, File/Kit Transfers, Configuration Management, Trouble Ticketing/Help Desk)</p> <p>Develop RR Track Database</p> <p>Develop Railroad Dispatch to BOS Interface</p>	<p>Railroad: License CI-BOS, G-BOS and MDM</p> <p>Develop RR Track Database</p> <p>Develop Railroad Dispatch to BOS Interface</p> <p>IPSN: Install and maintain CI-BOS, G-BOS and MDM at IPSN</p> <p>License, install and maintain WSRS at IPSN</p> <p>License, install and maintain PTC systems management at IPSN (Security, Data Management, Monitoring, File/Kit Transfers, Configuration Management, Trouble Ticketing/Help Desk)</p>
Locomotive Subsystem	<p>Railroad: License, install, and</p>	<p>Railroad: License, install, and</p>	<p>Railroad: License, install, and</p>

Implementation Approach	Standalone I-ETMS Solution	Through Class I ITC	Through IPSN
	maintain Locomotive subsystem (TMC and related PTC equipment)	maintain Locomotive subsystem (TMC and related PTC equipment)	maintain Locomotive subsystem (TMC and related PTC equipment)
Communications Subsystem	<p>Railroad: License, install, and maintain PTC messaging at own back office and on locomotives</p> <p>Install and maintain communications from own locomotives and Wayside Interface Units (WIUs) to own back office</p> <p>Install and maintain federated connections to PTC MPLS network</p>	<p>Railroad: License, install, and maintain PTC messaging at own back office and on locomotives</p> <p>Install and maintain communications from own locomotives and WIUs to own back office</p> <p>Class I ITC Railroad: Install and maintain federated connections to PTC MPLS network</p>	<p>Railroad: License PTC messaging</p> <p>Coordinate with IPSN for Install and maintain communications from own locomotives and WIU to IPSN and from IPSN to back office</p> <p>IPSN: Install and maintain federated connections to PTC MPLS network</p> <p>Potentially, install and maintain PTC messaging at IPSN, on locomotives, and on WIUs</p> <p>Potentially install and maintain communications from locomotives and WIUs to IPSN and from IPSN to back office</p>
Wayside Subsystem	<p>Railroad: License, install, and maintain Wayside subsystem (WIU and related PTC equipment)</p>	<p>Railroad: License, install, and maintain Wayside subsystem (WIU and related PTC equipment)</p>	<p>Railroad: License, install, and maintain Wayside subsystem (WIU and related PTC equipment)</p>

Table 9 Host/Tenant I-ETMS Implementation Approach

The impact of operational changes to the railroads operational policies, procedures, methods or daily work routines are no different than those for railroads deploying I-ETMS without the use of the IPSN, and are summarized in the I-ETMS PTCDP. These changes include the operation of I-ETMS locomotive segment equipment, the conveyance of mandatory directives from host railroads, operation in accordance with the next governing signals indication, the use of cab signal speed control and positive stop enforcement, and the impact of predictive enforcement.

I-ETMS capability changes are no different whether a railroad implements I-ETMS as a standalone implementation, or through a Class I railroad, or through the IPSN. Due to the

alternative placements of these capabilities, the environment and interface considerations will vary by the implementation approach. For the railroad implementing its I-ETMS solution through the IPSN, many of the I-ETMS capabilities are hosted. These capability, environment, and interface changes as a result of implementing I-ETMS through an IPSN are incorporated as a part of Table 6 and Table 7.

System processing changes include the railroad impact of transforming data, or producing new data, in support of I-ETMS operation. The use of new data sources; changes in the quantity, type, and timing of data needed for import to and export from the system; and data retention requirements are no different whether a railroad implements I-ETMS as a standalone implementation, or through a Class I railroad, or through the IPSN. For the railroad utilizing the IPSN, many I-ETMS required system processing changes are internal to the IPSN and do not create an operational impact to the railroad. For a railroad utilizing the IPSN, the core system processing impact includes interfaces and publication of crew verification, consist, asset registry, software and configuration kits, and railroad SubDivision data.

4. IPSN Lab Environment Engineering, Test and Demonstration

4.1 Sprint Planning

The project laboratory environment was iteratively developed through a series of Sprints. Each Sprint had an original objective period of three months. During Sprint 3, the project was extended to support an additional Sprint cycle. Each of the four Sprint cycles was launched with a sprint planning session. The objectives for each sprint were discussed:

- Review the core project objectives:
 - Determine the core operational concepts of PTC interoperability, configuration management, and IT governance for smaller railroads in a shared network environment
 - Reduce capital and operational expenses of PTC implementation and operation across the short lines and commuters with benefits to the Class Is and the FRA
 - Review knowledge gaps for research in the form of research questions for investigation
- Agree on specific operational scenarios or use cases to be developed or refined in the concept of operations.
- Identify the requirements for each sprint.
- Determine how to advance these goals and knowledge gaps within the allotted sprint.

For each Sprint, the output of the planning cycle included working notes on the Sprint topology and test goals and objectives. Sections 4.2 through 4.5 provide input on the Sprint planning objectives, engineering, test and demonstration of each Sprint cycle. Section 5.2 provides the findings of the IPSN laboratory environment activities.

4.2 Sprint 1

4.2.1 Objective

The objective of Sprint 1 was to develop an initial lab environment capability to support locomotive initialization across a simple messaging topology, a simulated train management computer (TMC) and simulated Back Office Server (BOS). The base lab/test environment is depicted in Figure 7. Included in the objective environment was the integration of a simulator for testing purposes, scripting methods to replicate the AAR PTC Office-Locomotive Segment ICD for locomotive initialization, and a management console for the development and monitoring of the infrastructure virtual machines. The goal of Sprint 1 was to provide an initialization capability would demonstrate core PTC functionality in a small IPSN environment that could be scaled into a cloud-based service. The initialization function would include a check on the locomotive crew and consist between a simulated short line locomotive TMC and a simulated Class I back office service across the messaging fabric within a Class I's track. This

early capability is analogous to the primary use case for many tenant railroads that do not own any track, but run on PTC-enabled track across a Class I host railroad territory and must initialize in order to enter the track.

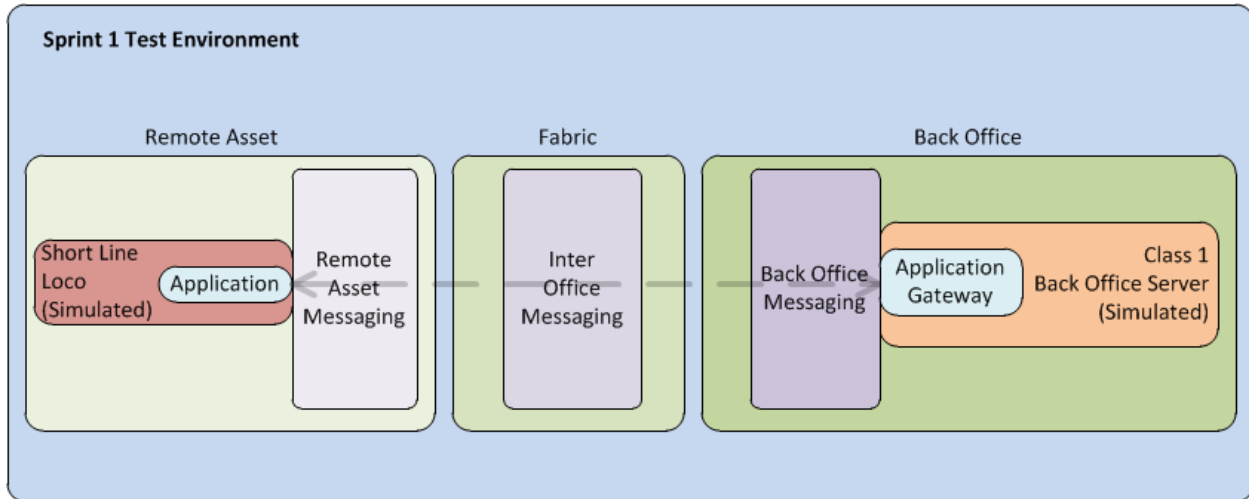

Figure 7 Sprint 1 Objective Environment

4.2.2 Engineering

The Sprint 1 engineering effort incorporated several elements:

- Allocated ITCM components to remote, inter-office, and back office messaging functions for IPSN deployment
- Developed virtual machine (VM) templates with a virtualization management engine
- Hosted machines on a shared platform with integrated CPU, storage, and network infrastructure
- Developed baseline environment of messaging VMs on Red Hat Enterprise Linux (RHEL)
- Integrated a simulator for test/integration
- Integrated operator console access to shared environment with SSH capability

A review was conducted of the components of the ITC messaging architecture. These components include multiple brokers and exchanges that are highly distributable, and they can be deployed in multiple ways to meet the requirements of the railroad. In the case of a shared network, the team wanted to determine if there were ITC messaging groupings that would support a routine approach for multiple railroad deployment. It became evident that the messaging functions follow the ITC PTC architecture consisting of the back office subsystem, the locomotive subsystem, the wayside subsystem, and the communications subsystem. The remote assets, which include both locomotive and wayside subsystems, commonly require an application gateway to bridge a class D application onto the AMQP-based ITC messaging system. This AG then interface to a remote broker that contains queues and exchanges for interaction with fragmentation senders and receivers, management adapters, message loggers, message routers, and event monitors for messaging functions at the remote asset. Additionally

the ITC messaging function incorporates a connection manager for establishing and maintaining connections of the remote asset with the PTC communications subsystem. The collection of these ITC messaging components was grouped for shared network deployment as the Remote Asset Messaging (RAM) element. These components are generally instantiated, in the case of the locomotive, as a slot 10 card on a train management computer; or in the case of a wayside interface unit, the wayside management system. In the case of the shared network deployment, the RAM must be configured correctly to ensure message traffic on the short line or commuter's remote asset can be managed by the shared network provider.

The back office deployment of ITC messaging commonly incorporates the deployment and configuration of a transport network broker, a fragment receiver broker, an interchange subsystem, and a back office broker. Each broker in the back office has queues and exchanges to support, in a similar manner as the remote assets, interaction with fragmentation senders and receivers, management adapters, message loggers, message routers, and event monitors. The back office components additionally support route publications for messages across the network; and an external link manager for message translations needed through 220 MHz radios. This collection of ITC messaging components were logically grouped for shared network deployment as the Back Office Messaging (BOM) element; and is generally instantiated together for a single railroad at the same time.

The ITC messaging component incorporates deployment and configuration of an inter-org broker – unique with a bridge filter to support message filtering of the railroad with other railroads. For the shared network deployment, this component was grouped independent of the other broker queues and exchanges as the Inter-Office Messaging (IOM) element. The IOM requires an extensive amount of configuration management as new railroads are integrated into the shared network infrastructure.

For Sprint 1, the ITC messaging components were associated into the RAM, IOM, and BOM elements, and were all integrated on a single VM, with an expectation these elements would naturally expand out into the larger ITC PTC system architecture as the system incorporated actual remote assets or increased sizing requirements based on message loads. The division of the ITC messaging components into the three messaging elements in the shared network supported a manageable collection of functions for consideration in virtual machine sizing and for methods to distribute the functionality in the shared network environment. The further analysis of this issue was deferred for Sprint 2.

Machine sizing parameters, operating systems, and build packages were considered for the development of standard virtual machine templates. This effort required a review of the various applications that would be hosted in the shared environment, and their machine requirements in terms of network interfaces, storage, and CPU processing. Developing the templates provided ready-made machines that could be put under configuration control, and cloned for distribution and deployment in a rapid manner.

The initial virtual machines were created, then application suites installed these VMs, all hosted on the shared hypervisor platform. The Sprint development environment included shared storage, the shared hypervisor platform, and physical and virtual networking across the virtual machines and physical devices. The baseline virtual machine configuration was finalized, along with a simulator for the locomotive and the back office infrastructure.

A VPN connection into the environment was established to allow SSH into the hypervisor and VM collection. The test laboratory was physically separate from the engineering facility, and a large portion of the work on the machines was conducted remotely.

4.2.3 Test and Demonstration

The Sprint 1 test and demonstration effort incorporated two primary elements:

- Developed components and message scripts on test simulator for locomotive initialization
- Tested initialization functionality through the shared network

The simulator supports message exchange between the system under test and simulators. The primary system under test is the messaging fabric, so a script was developed to conduct a routine locomotive initialization with a back office service. The use case was to conduct the initialization using a simulated short line locomotive to a simulated Class I back office. Figure 8 illustrates the initialization scenario used to test an initialization message exchange for the core employee authentication, exchange of train ID, configuration check, correct subdiv file check, exchange of the locomotive system state, and a departure test report. The train consist exchange was added to the test scenario at a later point.

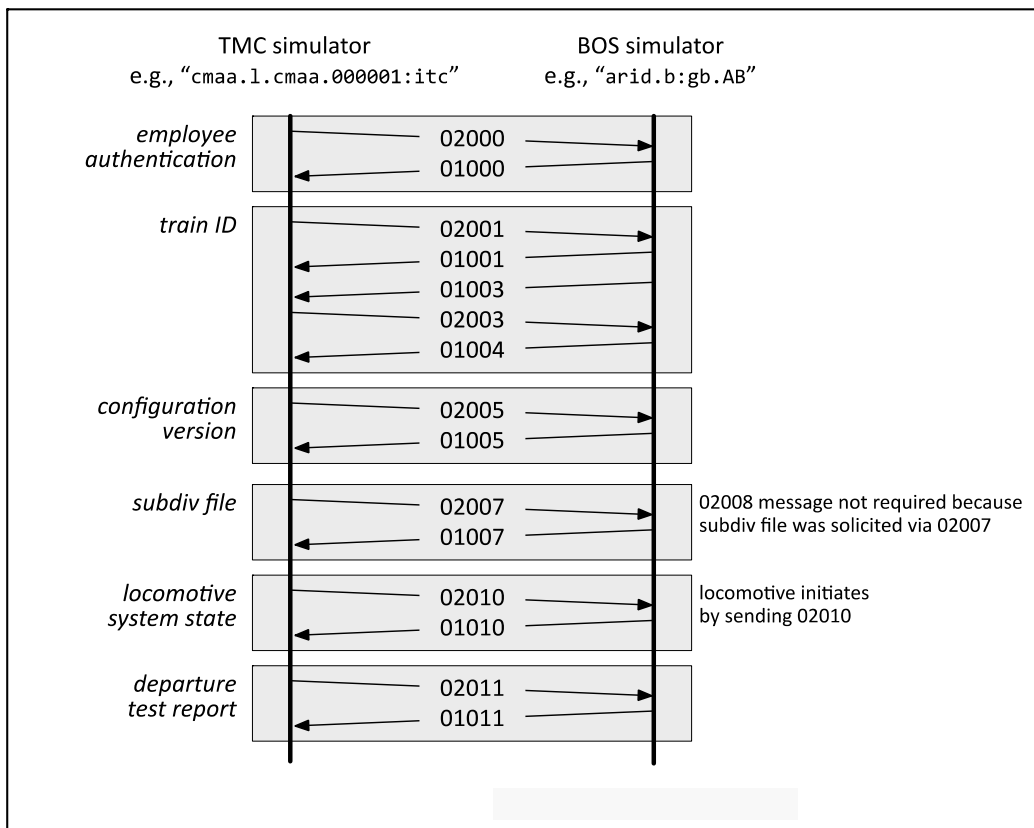

Figure 8 Illustration of Core Test Initialization Scenario

Using the locomotive and back office simulators, messages were exchanged across the RAM, IOM, and BOM elements of the messaging fabric. For the testing and demonstration effort, the RAM was configured as a short line using an EMP address of cmaa.l.cmaa.000001:itc. The BOM as configured as a Class I railroad with an EMP of arid.b:gb.AB. The IOM provided the inter-office functions along with the inter-change broker in the BOM, and end-to-end message exchange through the configured ITC messaging fabric hosted on the shared networking environment was successfully validated.

The Sprint 1 demonstration was successfully completed and it showed how locomotive initialization of a short line locomotive to a Class I BOS could occur in the hosted environment.

4.3 Sprint 2

4.3.1 Objective

In Sprint 2, the team examined alternative ITC messaging topologies that could support further scaling and expansion of messaging within a virtualized hosted environment and looked at host railroad use of the shared environment. An objective diagram of the configured environment using a variety of real ITCM and simulated PTC components and carrier transport components is depicted in Figure 9. The laboratory environment had been expanded in parallel with development of the Concept of Operations. The diagram depicts a series of PTC real and simulated components built in a virtualized environment that could be readily migrated into an Infrastructure as a Service (IaaS) cloud-based PTC service.

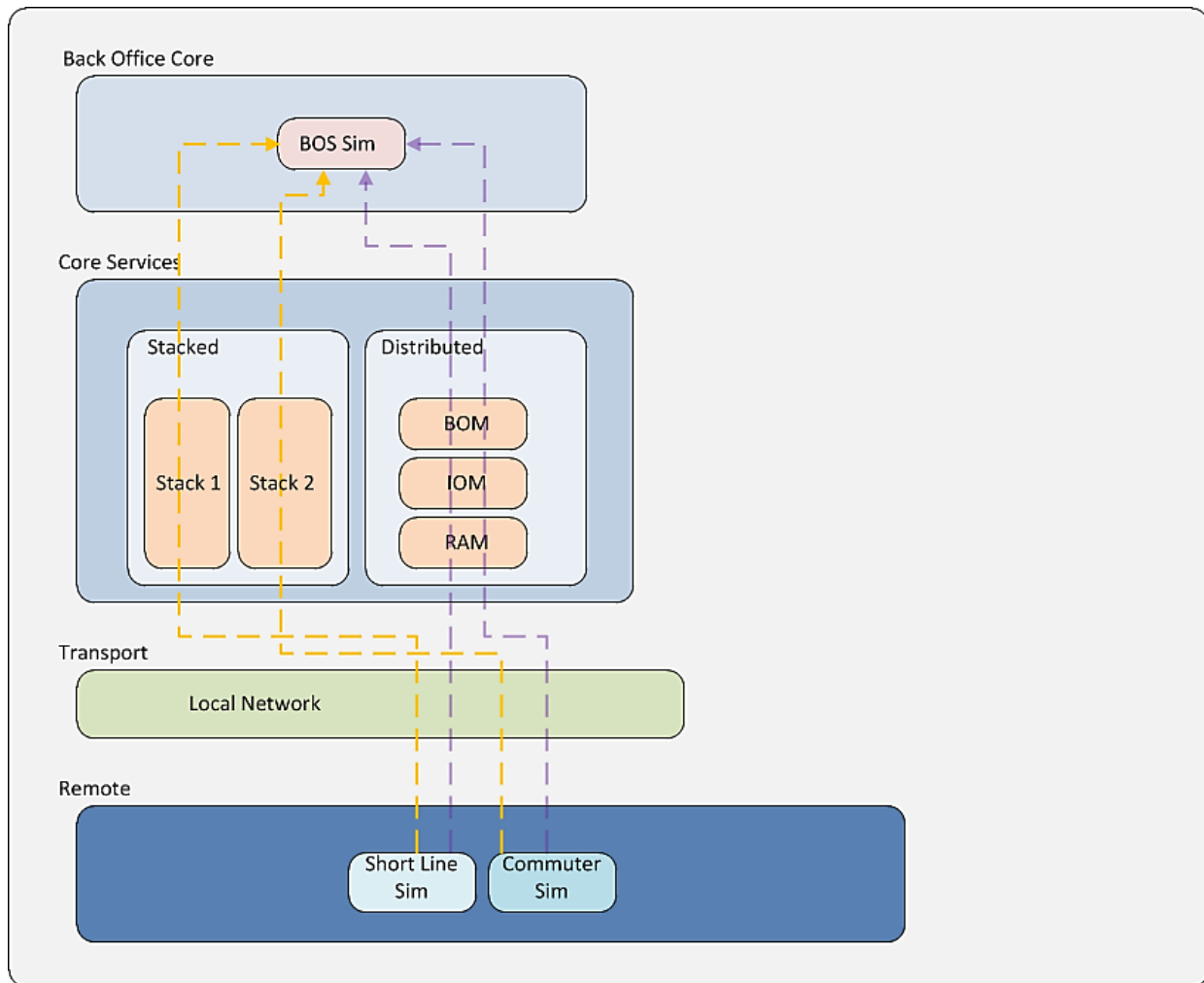

Figure 9 Sprint 2 Objective Environment

The Sprint 2 goals included the following:

- A commuter locomotive should be able to initialize with its own back office and the back office of a short line railroad.
- A short line locomotive should be able to initialize with its own back office and the back office of a commuter railroad.
- Multiple railroads (commuter and short line) should be supported in a shared network environment.
- Examine alternative messaging topologies to accommodate scaling and extensibility of the hosted environment user’s PTC deployment (stacked and distributed).

There are cases of both short line and commuters that will host ITC PTC track and own track, so the team decided that an important use case was “a short line and a commuter host with its back office for locomotive initialization.” This would be the first Sprint that focuses on the needs of a host short line or host commuter railroad.

4.3.2 Engineering

The Sprint 2 engineering effort incorporated several elements:

- Developing an approach for ITC messaging scaling and expansion in a shared network environment.
- Integrating additional VMs for new locomotives and BOS simulators representing additional railroads.
- Integrating the ITC Messaging fabric to support multiple railroad message routing through the shared infrastructure.

In Sprint 2, the team focused on developing an approach for ITC messaging scaling and expansion as the shared network environment increases in the number of railroads it would need to support. ITC messaging already contains a number of high availability features in support of distribution to triple redundant brokers and logical placement of virtual machine clusters. The focus in this Sprint was not to repeat what has already been integrated within ITC messaging, but to review alternative approaches to how the core messaging elements (RAM, IOM, and BOM) might be distributed within multiple virtual machines to support an increasing number of tenant and host railroads. The RAM elements will naturally migrate outside of the shared network environment to the mobile locations of remote assets, however for this early capability they were incorporated into the approach for VM scaling.

There are many factors that enter into the evaluation of a preferred deployment approach, including message integrity, system integrity, message availability, system availability, timeliness of message delivery, system scalability, multi-geographic operations and failover, system manageability, and system extensibility. These factors were considered, and as a result two primary forms of messaging deployment were developed: *stacked deployment* and *distributed deployment*.

In stacked deployment, all core ITC messaging elements for a specific railroad are placed with one virtual machine. If this approach was used in production, the machine would be replicated using private Virtual Local Area Networks (VLANs) to support a clustered node of machines on one or more hypervisors at one geographic location, and further replicated with an additional node on separate physical hypervisors (s) at a separate geographic location. As more railroads were added to the shared environment, the core messaging components for that railroad would be deployed on another single virtual machine, and further replicated with clustered nodes and geographic distribution.

In distributed deployment, a single element of ITC messaging supports many railroads on one virtual machine. In this approach, a machine was built to support the IOM element for multiple railroads and another machine was built to support the BOM element for multiple railroads. The identical approach for VM replication, clustered nodes and physical distribution would be provided in a production environment to support failover and high availability needs for the shared environment.

To test both approaches, a suite of virtual machines were deployed to supporting stacked and distributed deployment, and a set of simulated locomotives and simulated back office servers were created. The connections across each machine were configured as follows: in stacked deployment, most of the messaging was within the single VM, while in distributed deployment messaging employed exchanges between multiple VMs.

The test results were inconclusive. There were no strong benefits to one deployment topology or the alternative, in part because the simulated test environment was not a full scale emulation of a production-like system containing virtual machine replication, multiple hypervisors, and geographic distribution of the ITC messaging system. Nonetheless, utilizing the two approaches demonstrated multiple railroad deployment and messaging could be conducted in the shared network; tailoring the virtual machine environment to support the railroad's size would likely be required in an operational environment.

In Sprint 2, the team also identified the potential of some hybrid approaches for ITC messaging deployment, potentially with BOM elements deployed on a one machine per railroad basis (with its redundant configurations for high availability), as well as IOM elements that incorporate filtering and inter-office brokering within and outside of the shared network environment to the Class I railroads that could be deployed with sets of multiple railroads on a single virtual machine.

4.3.3 Test and Demonstration

The Sprint 2 test and demonstration effort incorporated several elements:

- The simulators and scripts used for the BOS and locomotive simulators were separated.
- Each locomotive and each BOS were updated with a distinct combination of IP address and Ethernet Management Port (EMP) number.
- The test environment was expanded to support additional locomotive and BOS simulators.
- The test scenarios now included the initialization of short-line and commuter locomotives from short-line, commuter, and Class-1 BOSs.

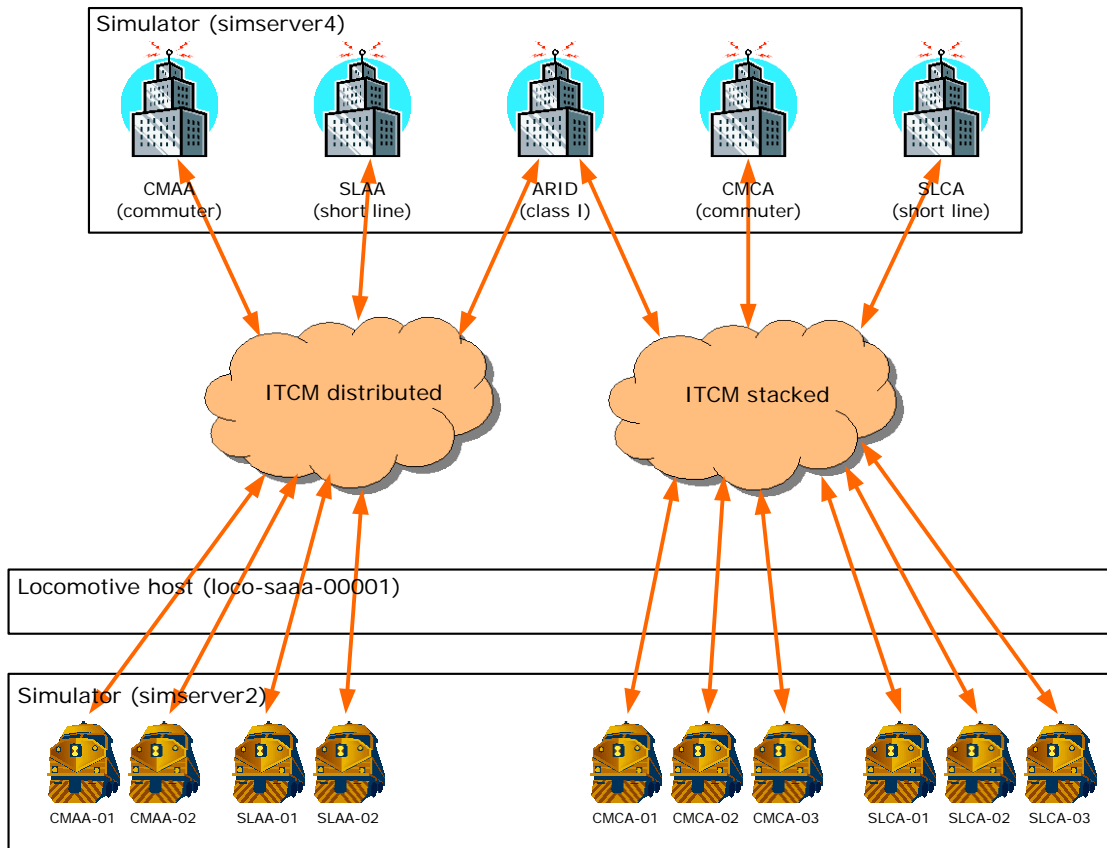

Figure 10 Core Test Configuration

The test configuration for Sprint 2 is depicted in Figure 10. In this Sprint, it was decided that the Class I back office simulator from Sprint 1 could be used for initializations from simulated short line and commuter locomotives could be conducted with short-line, commuter, and Class-1 BOSs. To support the review of conducting these initializations across either a stacked or distributed approach, additional VMs were deployed to support the set of test scenarios depicted in Figure 11.

Scenario	Locomotive...	...is initialized by BOS at	ITCM configuration
Commuter loco initialized by own BOS	cmaa.l.cmaa.000001:itc	cmaa.b:gb.AB	Distributed
Short line loco initialized by own BOS	slaa.l.slaa.000001:itc	slaa.b:gb.AB	Distributed
Commuter loco initialized by short line BOS	cmaa.l.cmaa.000001:itc	slaa.b:gb.AB	Distributed
Short line loco initialized by commuter BOS	slaa.l.slaa.000001:itc	cmaa.b:gb.AB	Distributed
Commuter loco initialized by Class I BOS	cmaa.l.cmaa.000001:itc	arid.b:gb.AB	Distributed
Short line loco initialized by Class I BOS	slaa.l.slaa.000001:itc	arid.b:gb.AB	Distributed
Commuter loco initialized by own BOS	cmca.l.cmca.000001:itc	cmca.b:gb.AB	Stacked
Short line loco initialized by own BOS	slca.l.slca.000001:itc	slca.b:gb.AB	Stacked
Commuter loco initialized by short line BOS	cmca.l.cmca.000001:itc	slca.b:gb.AB	Stacked
Short line loco initialized by commuter BOS	slca.l.slca.000001:itc	cmca.b:gb.AB	Stacked
Commuter loco initialized by Class I BOS	cmca.l.cmca.000001:itc	arid.b:gb.AB	Stacked
Short line loco initialized by Class I BOS	slca.l.slca.000001:itc	arid.b:gb.AB	Stacked

Figure 11 Test Scenarios Validated

The test validated the ability of both short line and commuter locomotives to conduct messaging through the shared network, to its own back office, to each other's back office, and to a Class I back office. Additionally, these features could be supported in the shared network utilizing alternative deployment topologies of the ITC messaging fabric.

The Sprint 2 demonstration was successfully completed, demonstrating locomotive initialization of a short line and commuter to its own, to each other's, and to a Class I BOS in the hosted environment. The demonstration also provided successful message exchange across alternative deployment topologies in the shared network. Finally, the demonstration illustrated messaging to a host railroad utilizing the shared network.

4.4 Sprint 3

4.4.1 Objective

Sprint 3 was the project's last planned Sprint. For Sprint 3, the primary goals were to:

- Extend ITC messaging beyond the shared network environment to look at short line and commuter access across a simulated MPLS link to a Class I back office.
- Examine distribution of virtual machine technologies across more than one physical location.
- Introduce a developed message router capability to support shared network scalability.

Additionally, the team identified the need to upgrade the environment to support the increasing storage requirements. It was determined that there was not enough time in Sprint 3 to complete all of the desired goals, so the team created a fourth Sprint. These additional goals included introducing a real train management computer for initialization with the simulated back office and introducing a systems management for asset monitoring and management; and are discussed in Section 5.5. The interoperability messaging objective for Sprint 3 is provided as Figure 12, which incorporates the real TMC and multiple Back Office Servers (simulated) in a cloud environment to further simulate short line and commuter railroad interoperability to a Class I back office.

The core use case for Sprint 3 was to demonstrate shared network environment use in support of commuter and short line locomotive initialization and polling across a real network connection to the Class I back office. This would be the first Sprint that focuses on extending beyond the hypervisor environment to simulated Class I back office servers across a real network connection.



Figure 12 Sprint 3 Objective Environment

The original Sprint 3 objectives included the following:

- Commuter and short line initialization across a simulated MPLS link into a Class I office.
- Message delivery for a simulated tenant train communicating with host road (polling).
- Initializing a real TMC that utilized the shared network to a simulated back office service.
- Monitoring assets thru the shared network (Short Line & commuter).
- Managing multiple commuters and short lines.

4.4.2 Engineering

The Sprint 3 engineering effort incorporated multiple elements:

- Upgrade the environment for increased network storage.
- Build a large scale ITC messaging topology.
- Upgrade to a new version of the Simulator.
- Add Interoperable Train Control Systems Management (ITCSM) reference asset, gateway, and bosim.
- Build a slot 10 surrogate to connect to real TMC.
- Build and interface to additional cloud-based environments.
- Add ITCM to Amazon Web Service (AWS).
- Create an IP Sec connection between the Hypervisor Development Lab and two AWS environments.
- Develop 2 polling scripts.
- Add the RC Message Router.

The original infrastructure for the lab environment was supposed to use a large storage capacity that was internal to the hypervisor, and it would be integrated with an internal management console for virtual machine creation. The virtualization engine to support this configuration was validated but while it was being integrated in the lab environment, it was determined the management console would need to be integrated as a separate physical device and a storage array network (SAN) would eventually need to be added. The increased virtual machine requirements in Sprint 3 required this upgrade in the lab environment by adding a small SAN to accommodate the increased storage needs.

The modification to the hypervisor in Sprint 3 included the addition of several new virtual machines to provide the ITC messaging support to five commuter and five short line railroads. A new version of the Simulator was upgraded in the environment, and additional virtual machines added to support new locomotive and back office service simulators. Three new virtual machines were added to support the introduction of an ITC systems management gateway, an ITC reference asset, and an ITC systems management back office simulator (bosim). The bosim provided a support platform for ITC systems management message sending and receiving to the ITC messaging fabric, an asset registry for railroad assets, and a simulation of a key exchange server. An additional virtual machine was added to support a slot 10 surrogate function to interface to a real TMC messaging network – this machine provided network address translation from the real TMC locomotive LAN to the VLAN configuration of the shared network environment, and supported the class D to ITC messaging gateway interface.

To simulate the interface across a federated MPLS network, the Sprint 3 development included two simulated Class I railroads on different environments in the Amazon Web Service (AWS) cloud. Two environments were created, one on AWS East and another on AWS West, with the ITC messaging capability and back office simulators that were created at these two locations. An IP Sec connection between the lab hypervisor and the AWS environments was then established, to provide the simulated MPLS connection across the commuter and short line shared network environment, as well as the two simulated Class I railroads. The AWS environments would be used for both initialization and polling of the simulated commuter and short line locomotives utilizing the shared network environment through the real network connections to the simulated Class I back office services.

To support shared network scalability, the team introduced a message router capability. The message router for the purposes of the Sprint development was a pass-through of messages between the shared network infrastructure and the external connections to the AWS environment. The objective of the message router utilization is to support scalability of the shared network as it will continue to increase in size and complexity. The message router additionally is expected to help facilitate shared network services such as a real key exchange server that will be needed to support messaging operations across multiple railroads.

4.4.3 Test and Demonstration

The Sprint 3 test and demonstration effort incorporated two primary elements:

- Simulated commuter and short line locomotive initialization was tested to its own back office and to a simulated Class I back office through a real network connection.
- New scripts were tested for polling with file sync from Class I back office to locomotives.

The tests and demonstrations extended beyond the original planned period. However, the work accomplished several of the original Sprint 3 goals, including 1) the environment upgrade to support increased storage requirements; 2) the distribution of virtual machine technologies across more than one physical location through the addition of two simulated Class I back offices in the Amazon cloud; 3) the extension of ITC messaging beyond the shared network environment for short line and commuter access across a simulated MPLS link to a Class I back office; and 4) the introduction of a message router to support shared network scalability. Other Sprint 3 goals were deferred to Sprint 4, including 1) the initialization across the shared network environment using a real train management computer, and 2) integration of systems management for asset monitoring and management.

4.5 Sprint 4

4.5.1 Objective

For Sprint 4, the primary goals and objectives were to initialize using a real TMC across the shared network environment; to integrate systems management for asset monitoring and management; to add message loading using the simulators; and to plan provisioning of real cellular and MPLS connections into the shared network environment.

The core use case for Sprint 4 was to provide a test and integration capability for the short line and commuter railroads required to conduct testing and obtain FRA certification of their locomotives for use on ITC PTC enabled track.

4.5.2 Engineering

The Sprint 4 engineering effort incorporated several elements:

- Integrating a real TMC utilizing the shared network to a simulated back office service.
- Event reporting of ITC Asset data via ITC systems management.
- Monitoring shared network assets thru the shared network (Short Line & commuter).

- Adding message loading with simulators.
- Planning for provisioning cellular network access.
- Planning for provisioning MPLS integration.

The Sprint 4 engineering effort incorporated a real TMC that was interfaced to the shared network environment. The real TMC made use of a slot 10 surrogate that provided NAT and an ITC messaging gateway to interface with VLAN connectivity into the shared network. Messages could be exchanged with the real TMC to a simulated back office service with the shared network ITC messaging topology, which brings the real TMC through the initialization process and into an active state.

Using the installed ITC Systems Management virtual machines in the shared network environment, an ITC reference was stimulated with events for transmission through the shared network environment for message capture into a systems management engine.

Additional assets of the shared network were integrated with the systems management engine for health/status reporting. All non-ITC assets were integrated using snmpv2 and proxy agents.

Message loading of the shared network environment could not be completed due to resource limitations in simulator development, and would need to be conducted in future work.

Plans were advanced for cellular and MPLS connectivity to the shared network environment to support network access in a PTC test environment with short line and commuter railroads. The purpose of the external communications circuits is to provide an 'on ramp' for testing and locomotive crew familiarization for the short line and commuter railroads while full PTC connectivity with the Class I railroads can be progressed.

4.5.3 Test and Demonstration

The Sprint 4 test and demonstration effort incorporated several elements:

- Conduct a real TMC initialization with a remote Computer Display Unit (CDU) through shared environment for initialization.
 - Demonstrated check against real subDiv file.
 - Went to active state, demonstrated enforcement braking to stop at switch.
- Conducted ITC reference asset event reporting through the shared network environment.
- Demonstrated systems management engine for performance logging and monitoring of the shared infrastructure assets thru the shared network (Short Line & commuter).

5. Project Findings

5.1 Concept of Operations Findings

Core findings as a result of the Concept of Operations development included the following:

- An IPSN can directly support the integration of technology and methodology in the development of ITC PTC message interoperability between the short line and commuter rails with the Class I railroads. An IPSN can:
 - Reduce the number of interconnections between Class I railroads and the smaller rails, which would minimize the required number of communication links to send and receive PTC messages to tenant railroads.
 - Provide centralized personnel and IT infrastructure on behalf of the smaller rails to support PTC message transmission to their host railroads, providing efficiencies in manpower and technical complexity.
- The ITC PTC is an overlay technology on existing short line and commuter infrastructure and operations; while an IPSN is a collection of ITC PTC components that are integrated in order to support multiple railroads and maximize the use of the ITC PTCDP approach for Part 49 Subpart 236 compliance.
- In all cases of the I-ETMS-based operational concepts, the IPSN operation concept will remain identical to the I-ETMS concepts; either with no change or additional impact excepting:
 - Certain PTC functions are physically located at an IPSN facility instead of the railroad's facility, and
 - Certain IPSN personnel conduct administrative activities that would otherwise be conducted by the individual short line or commuter railroad.
- Operations of I-ETMS-equipped short line and commuter railroads in the context of the railroad utilizing the IPSN can be conducted with no variance to that provided under the I-ETMS PTCDP operating under type approval FRA-TA-2011-02.
- The impact of operational changes to the railroads operational policies, procedures, methods or daily work routines are no different than those for railroads deploying I-ETMS without the use of an IPSN, including:
 - Operation of I-ETMS locomotive segment equipment.
 - Electronic conveyance of mandatory directives from host railroads.
 - Operation in accordance with the next governing signals indication.
 - Use of cab signal speed control and positive stop enforcement.
 - The impact of predictive enforcement.
- I-ETMS capability changes are no different whether a railroad implements I-ETMS as a standalone implementation, through a Class I railroad, or through an IPSN. Due to the alternative placements of these capabilities, the environment and interface considerations will vary by implementation. For the railroad implementing its I-ETMS solution through an IPSN, many of the I-ETMS capabilities are already hosted.

- System processing changes include the impact on railroads of transforming data, or producing new data, in support of I-ETMS operation. The use of new data sources; changes in the quantity, type, and timing of data needed for import to and export from the system; and data retention requirements are no different whether a railroad implements I-ETMS as a standalone implementation, or through a Class I railroad, or through an IPSN. For the railroad utilizing an IPSN, many I-ETMS required system processing changes can be conducted internal to the IPSN and would reduce operational impact to the railroad.
- The Track Database Verification is not an IPSN function – railroads that own track must ensure that their processes create these files and verify the location accuracy of the track database attributes.
- IPSN operations will incorporate Configuration Management and IT Governance practices to support interoperability of deployed software versioning across multiple railroads.
- A shortline or commuter railroad which has a mandate to implement PTC can employ one of three primary courses of action to develop an I-ETMS solution that includes the back office, locomotive, wayside, and communication subsystems:
 - Implement a standalone I-ETMS solution.
 - Implement through a Class I ITC member’s I-ETMS solution.
 - Implement through an IPSN.
- To achieve system certification in concert with the railroads that utilize it, an IPSN can draw from the work of the ITC PTCDP Type Approval and the ITC PTC Safety Plan. The core safety and non-safety functions of the I-ETMS PTC all apply with little to no expected variance. However, the safety plan is a railroad responsibility. The railroads that utilize an IPSN, just as they utilize I-ETMS, have responsibility for the development of their safety plan.
- Testing and certification is a railroad responsibility. The railroads that utilize the IPSN, just as they utilize I-ETMS, will have responsibility for the accuracy of tests in support of system validation and verification. An IPSN can help to support, consolidate and reduce costs in this effort by providing a similar foundation effort to support the railroads and reduce total overall audit and monitoring requirements of the FRA.

5.2 IPSN Laboratory Findings

Core findings as a result of IPSN laboratory activities include the following:

- ITC Messaging and ITC Systems Management functions can be hosted in a shared network environment.
- Initialization can be conducted across a shared network environment for a simulated short line or commuter locomotive to a simulated short line, commuter, or Class I back office.
- ITC messaging components in a shared network environment can be logically grouped into remote asset, back office, and inter-office elements of messaging.

- A template approach for virtual machine development aids in configuration management and reliable deployment of new virtual machines in the shared network environment.
- A shared network environment can be utilized with ITC messaging to physically distant railroad remote assets and back offices to support messaging for tenant and host railroads.
- Alternative messaging topologies can be supported in a shared network environment to support scaling and extensibility of the shared network environment across multiple railroads.
- Shared network environment components can be distributed across multiple physical locations.
- ITC assets can transmit health, status and event information through ITC systems management deployment in the shared network environment.
- ITC systems management requires integration with additional back office functions to establish a complete systems management architecture – these functions include security key management; event reporting, parsing, and fault correlation; implementation of file distribution engines; and management of additional assets.
- Utilizing the shared network environment, a real TMC can be initialized, engage into active state, and conduct enforcement braking to a stop at a switch.
- A shared network environment can be provisioned with network access in a PTC test environment with short line and commuter railroads, providing an ‘on ramp’ for testing and locomotive crew familiarization while full PTC connectivity with the Class I railroads is progressed.
- A shared network environment can be developed utilizing information technology design principles for scalability and expansion, high availability, and continuity of operations.

5.3 Findings from Potential IPSN Users

Core findings as a result of discussions with potential users of the IPSN include the following:

- Railroads that have met with us have all expressed appreciation for sharing this information.
- The short line and commuter railroads have expressed a great deal of interest in the shared network concept. The PTC component and process allocations are helping the railroads plan for PTC deployment.
- Class I railroads have expressed support for the shared PTC network approach.
- The short line railroads need education and assistance in planning for PTC. It is also important that discussions with their Class I host railroads progress so they understand their requirements from the host railroad to effectively plan. They need a cost effective approach to implement PTC because it is a true financial burden for these railroads.
- The short line railroads need direct guidance from their Class I Host Railroads so they can start planning to execute PTC.

- The cost of PTC is significant for the commuter railroads. Because commuter railroads are directly named in the legislation, they have launched PTC projects and are investing in the technology. They need a cost-effective solution for PTC.
- Most of the larger commuter railroads have launched their PTC Projects or are planning to launch them soon.

5.4 Research Questions: Summary of Project Findings

At the beginning of the project, an initial set of seven research questions were developed for consideration throughout the project. These questions and a summary response for each question follow.

1. Can a shared infrastructure supporting multiple railroads be integrated and tested to meet PTC requirements?

- A shared infrastructure supporting multiple railroads can be integrated and tested to meet PTC requirements.
- The core architecture supports consolidation of messaging into a shared infrastructure that can meet core I-ETMS PTC functionality of train initialization and message exchange.
- A distributed approach supports placement of PTC functionality where needed, for example:
 - A Track Bulletin System could be third party provided to the railroad.
 - An MDM for SubDiv File transmission could be at the Host Railroad or be can be integrated to support distribution in a shared network infrastructure.
- An IPSN does not substantially modify the I-ETMS PTC overly as described in the ITC PTC Development Plan.

2. Can the shared infrastructure concept meet technical and operational PTC requirements of the smaller rails?

- A shared infrastructure concept can meet technical and operational PTC requirements of the smaller rails.
- An IPSN can be developed that meets the requirements of the ITC collaboration agreement for ITC PTC interoperability.
- An IPSN can be developed leveraging the ITC PTCDP to meet the ITC PTC requirements.
- Non-ITC PTC systems (ACSES, ITCS) are not immediately supportable through the shared infrastructure concept but have potential to be developed using an IPSN base.

3. Can interoperability issues/risks be minimized between ITC Railroads and the other roads with this approach?

- Interoperability issues/risks can be minimized between ITC Railroads and the other roads with an IPSN approach.
 - Interoperability aspects of an IPSN are in compliance with the ITC PTC Development Plan.
 - Consolidation of other roads interface connections through an IPSN builds in configuration management of the interfaces to the ITC Railroads.
 - ACSES PTC interfaces to ITC Railroads are not immediately addressed through implementation of an IPSN, although an IPSN should be capable in providing an integration platform to support eventual ACSES/I-ETMS interoperability needs.
- 4. *Can a shared environment reduce small railroad and FRA resources needed for PTC testing?***
- A shared environment can reduce small railroad and FRA resources needed for PTC testing.
 - Testing is expected to be conducted in compliance with the ITC PTC Development Plan and Type Approval.
 - Variances from the PTCDP are expected to be minimal, and the ITC PTC Safety Plan is expected to be used with testing effort for ITC PTC validation.
 - Tests between ITC Railroads and others across an IPSN will have similar interfaces and test runs, reducing the overall test effort and FRA resources needed for testing.
- 5. *Can a shared environment address training requirements for the small railroads and allow focus on the more operational oriented components of PTC?***
- A shared environment can address training requirements for the small railroads and allow them to focus on the more operational oriented components of PTC.
 - A shared environment can help consolidate testing, certification, and safety plan development across multiple railroads, which will reduce small railroad labor requirements and support a larger focus on operational aspects of PTC.
 - An IPSN can integrate a test environment to support testing and certification as well as early integration and training of the railroad's train management computer for locomotive initialization.
- 6. *Can a shared environment address configuration management and IT governance challenge for smaller rails?***
- A shared environment can address the configuration management and IT governance challenge for smaller rails.
 - Policy mechanisms can be made a contractual condition for utilization of an IPSN.
 - An IPSN is expected to be a member of the ITC policy committee with voting rights on configuration management and IT governance.

- An IPSN can maintain system of record and implement change management controls for coordinated introduction of technology.

7. *Are there roadblocks such as dispatching or subdivision file creation that can leverage a shared concept?*

- Roadblocks such as dispatching or subdivision file creation cannot leverage a shared concept as examined in this project.
- Technical implementation, rules, and railroad knowledge base of railroad track territory are unique across each railroad.
- It is possible that quality control and configuration management processes can be shared for subdivision file creation among the host railroads.

Appendix A. IPSN Project Quad Chart

The original Quad Chart summarizing the project concept is provided below.

ITC PTC Shared Network (ISPN) Project

<p>Visual of Project Concept:</p>	<p>Project Description:</p> <ul style="list-style-type: none"> • Conduct Industry Outreach on PTC messaging needs • Develop Concept of Operations for a Shared ITCM/ITCSM Environment for small railroads handling PTC message routing and delivery • Establish a demonstration shared ITCM/ITCSM environment • Conduct shared ITCM/ITCSM demonstrations with Class 1, Short Line and Commuter Railroads • Produce a report on Industry Outreach, Concept of Operations, and demonstration
<p>Railroad Impact:</p> <ul style="list-style-type: none"> • Reduce small rail investments in IT human and computer resources required for ITCM/ITCSM • Reduce small railroad and FRA resources needed for testing • Reduce Technology Training and support requirements for the small railroads • Simplify the configuration management problem – central staff focused on software currency • Reduce complexity of PTC network connections for Class 1 railroads 	<p>Cost and Schedule:</p> <ul style="list-style-type: none"> • AOC – December 2013 - ~\$157k <ul style="list-style-type: none"> • Draft Concept of Operations, Establish Lab, Initial Demonstration. • January 2014 – March 2014 - ~\$157k <ul style="list-style-type: none"> • Update Concept of Operations, Class I Demonstration • April 2014 – June 2014 - ~\$157k <ul style="list-style-type: none"> • Final version of Concept of Operations and report, Demonstrations with multiple small railroads and Class I for interoperability
<p>FRA Task Manager: TBD</p>	<p>ARINC Project Partner: Class 1 RR, Short Line and Commuter</p>

Appendix B. IPSN Project Outreach Questionnaire

The research questionnaire used in discussions with short line and commuter railroad meetings is provided in the remaining pages of this report.

ARINC

Hosted PTC Network User Questionnaire

Railroad _____

Points of Contact _____

Date _____

Type of Operation (can be multiple answers)

PTC

- Implement PTC on own track
 - WIUs
 - Comms infrastructure
 - CAD
 - BOS
 - Tenant – host railroad installs PTC infrastructure
 - Only operate PTC-enabled locomotive on Class 1 or other railroad
 - Host – other railroads will operate under PTC office control on my railroad
 - My primary PTC system will be other than I-ETMS
 - PTC Implementation in yard
 - Other
-
-

Notes:

Methods of Operation (can be multiple answers)

- Applicable Rules
 - NORAC
 - GCOR
 - Other _____
- Wayside Signals – CTC
- Wayside Signals - ABS
- Cab Signals
- Track Warrant
- Other _____

Notes:

Size of Operation

- Number of locomotives to be PTC equipped _____
- Number of miles of track _____
- Number of miles of PTC-equipped track _____
- Number of PTC subdivisions _____
- Number of WIUs to be installed _____
- Number of 220 MHz base stations to be installed _____
- Number of locations to initialize PTC locomotives _____
 - Initialize at train origination
 - Initialize at switch entry to PTC track
- Number of office system locations _____
- Number of locations from which locomotives to be dispatched _____
- Number of interchange partners for PTC operation _____
- Number of train crew requiring PTC security credentials _____

Notes:

PTC Infrastructure To Be Installed (can be multiple answers)

- Locomotive Only – no PTC WIUs or 220 radio base stations or other PTC wireless connections
 - TMC Supplier _____
- Locomotive + WiFi in yard
- Locomotive + cellular or WiFi on track
- Locomotive + WIUs – will connect via _____ communications path to WIU.
 - WIU supplier(s) _____
- Locomotive + WIUs + 220 radio base stations
- Locomotive + WIUs + 220 radio base stations + cellular or WiFi

Notes:

Office Environment (can be multiple answers)

Dispatch

- Dispatched by host railroad
- Have own dispatch – PTC capable
- Have own dispatch – not PTC capable
- No computerized dispatch
- Shared dispatch – PTC capable
- Shared dispatch – not PTC capable
- Dispatch supplier/generation _____

Notes:

Back Office Server

- Will have own BOS
 - Supplier _____
- Will connect to other railroad BOS _____
- Will connect to shared BOS operated by _____

MIS

Consist Data

- Have consist system that can provide consist data to TMC
- Do not have consist system that can provide consist data to TMC
- Partner/host railroad will provide consist data to TMC

Notes:

Crew Data

- Have crew authentication system – can authenticate crews on PTC-equipped locomotive
- Have crew authentication system cannot authenticate crews on PTC-equipped locomotive
- Partner/host railroad will perform crew authentication function

Notes:

Temporary Speed Restrictions

- I need to provide TSRs on my railroad to my locomotive (PTC operation)
- I need to provide TSRs on my railroad to foreign locomotive (PTC operation)
- My locomotives need to receive TSRs from foreign railroad while on my railroad
- My locomotives need to receive TSRs from foreign railroad while on foreign railroad

Notes:

Grade Crossing/Diamond Status (or other target)

- I need to provide target status data on my railroad to my locomotive (PTC operation)
- I need to provide target status data on my railroad to foreign locomotive (PTC operation)
- My locomotives need to receive target status data from foreign railroad while on my railroad
- My locomotives need to receive target status data from foreign railroad while on foreign railroad

Notes:

Work Blocks

- I need to provide work block data on my railroad to my locomotive (PTC operation)
- I need to provide work block data on my railroad to foreign locomotive (PTC operation)
- My locomotives need to receive work block data from foreign railroad while on my railroad
- My locomotives need to receive work block data from foreign railroad while on foreign railroad

Notes:

Other Office Systems

Subdiv File

- No PTC territory – do not have to generate subdiv files
- Have PTC territory, have system to distribute subdiv file to locomotive
- Have PTC territory, do not have system to distribute subdiv file to locomotive
- Have PTC territory, have capability to create/maintain GIS files
- Have PTC territory, do not have capability to create/maintain GIS files

Notes:

TMC Software, Kit, Subdiv File Distribution and Configuration Management

- Will have own MDM or other mechanism to distribute software and file updates to my TMCs, WIUs, base stations
 - MDM
 - ITCSM
 - Other _____
- Will not have own MDM or other mechanism to distribute software and file updates to my TMCs, WIUs, base stations
- Partner/host railroad will update TMC software and files in my locomotives

- Will have own mechanism to distribute Slot 10 card software updates to my TMCs
- Will not have own mechanism to distribute Slot 10 software updates to my TMCs
- Partner/host railroad will update Slot 10 software in my locomotives

- Will have own mechanism to distribute non-TMC software updates to my locomotives
- Will not have own mechanism to distribute non-TMC software updates to my locomotives
- Partner/host railroad will update non-TMC software in my locomotives
- Not Applicable – won't have non-PTC software to be updated remotely

Notes:

Security Key Distribution

- Will have own mechanism to generate, store, and distribute security keys to my TMCs or other assets
- Will not have own mechanism to generate, store, and distribute security keys to my TMCs or other assets
- Partner/host railroad will generate, store, and distribute security keys to my TMCs or other assets
- Will have capability to distribute security keys requested by other railroads
- Will not have capability to distribute security keys requested by other railroads

- Other

Notes:

Remote PTC Asset Monitoring

- Will have own system for monitoring the status and health of my PTC-equipped assets
- Have separate system for monitoring the status of non-PTC equipment
- Will not have own system for monitoring the status and health of my PTC-equipped assets
- Partner/host railroad will monitor the status and health of my PTC-equipped assets and provide the information to me
- Need communications means to relay foreign railroad PTC asset information to them

Notes:

Network Infrastructure

- I intend to stand up my own complete ITCM/ITSM network, including wireless systems
- I will stand up ITCM software, but not 220 base stations
- I will install wireless systems (220, cellular, WiFi), but not ITCM network
- I have an agreement to connect into another railroad ITCM system
- My locomotives are dispatched by another railroad, and they will provide all PTC communications infrastructure
- I need to install WiFi at train origination point only to connect to other railroad ITCM network

Notes:

Train Location Data

- I will receive location data from my locomotives directly through my own infrastructure
- Have system separate from PTC for locomotive location tracking
- I want to receive location data from my locomotives from other railroads
- I need to provide location data from foreign locomotives operating on my track to owning railroad

Notes:

Dispatcher Messages

- I need to be able to send dispatcher messages to my locomotives on my railroad
- I need to be able to send dispatcher messages to my locomotives while on foreign railroad
- Foreign locomotives need to be able to receive dispatcher messages while on my railroad

Notes:

WIU Status Information

- I need to receive WIU status of my track on my dispatch
- I need to receive WIU status of foreign railroad track on my dispatch

Notes:

Automatic Violation Reports

- I need to be able to receive violation reports from my locomotives on my railroad
- I need to be able to receive violation reports from my locomotives while on foreign railroad
- Foreign locomotives need to be able to receive violation reports while on my railroad

Notes:

Timeline

Agreement(s) with Interoperability Partner/Host/Tenant _____

Implementation of PTC Infrastructure

- Office Systems _____
- Locomotives _____
- WIUs _____
- Communications _____
- ITCM Network _____
- System Monitoring/Management _____
- Development of Subdiv Files _____
- Start of PTC Operation _____

Acronyms

AAR	Association of American Railroads
ABS	Automatic Block Signal (System)
ACES	Advanced Civil Speed Enforcement System
APTA	American Public Transportation Association
ASLRRRA	American Short Line and Regional Railroad Association
AWS	Amazon Web Service
BOS	Back Office System
CDU	Computer Display Unit
CFR	Code of Federal Regulation
CI-BOS	Calyon International Back Office System
CTC	Centralized Traffic Control
FRA	Federal Railroad Administration
G-BOS	Global Back Office System
GIS	Geographic Information System
I-ETMS	Interoperable Electronic Train Management System
ICD	Interface Control Document
IEEE	Institute of Electrical and Electronics Engineers
IPSN	ITC PTC Shared Network
ITC	Interoperable Train Control
ITCM	Interoperable Train Control Messaging
ITCS	Incremental Train Control System
ITCSM	Interoperable Train Control Systems Management
MDM	Multiple Device Management
MPLS	Multi-Protocol Label Switching
PTC	Positive Train Control
PTCDP	PTC Development Plan
PTCIP	PTC Implementation Plan
PTCSP	Positive Train Control Safety Plan
REC	Request for Expedited Certification
TC	Traffic Control

TMC	Train Management Computer
TWC	Track Warrant Control
WIU	Wayside Interface Unit

Definitions

<i>Automatic Block Signal</i>	A series of consecutive blocks governed by block signals, cab signals, or both, actuated by a train or engine or by certain conditions affecting the use of the block.
<i>ACSES</i>	A vital overlay transponder based system that combined with Automatic Train Control provides PTC functionality
<i>Auxiliary Track</i>	A track auxiliary to a Main Track, such as an industrial track, spur, or yard track.
<i>Bi-directional Authority</i>	A mandatory directive that authorizes train, engine, or employee movement in both directions on a Main Track or other controlled track.
<i>Civil Speed Restriction</i>	Speed restriction as contained in the timetable or Operations Bulletin.
<i>Control Operator</i>	An employee assigned to operate a TC control machine.
<i>Crossing</i>	Point of intersection at grade between two tracks belonging to the same or different railroads.
<i>Centralized Traffic Control</i>	A block system operated from a dispatching office using block signal indications to authorize train movements.
<i>Current of Traffic</i>	The movement of trains or engines on a Main Track in one direction specified by the rules.
<i>District</i>	A portion of a division or region designated by the Timetable.
<i>Division or Region</i>	A defined area comprised of multiple subdivisions or districts, assigned to the supervision of a Superintendent.
<i>Double Track</i>	Two Main Tracks, upon one of which the current of traffic is in a specified direction, and upon the other in the opposite direction.
<i>Energy Management</i>	Functions external to I-ETMS that computes locomotive control settings for optimal fuel use and minimization of in-train forces.
<i>Enforcement Brake Application</i>	A full-service brake application automatically invoked by a train control system to prevent a train from otherwise violating an authority or speed limit in advance, or in response to a violation that has already occurred.
<i>Engine</i>	A unit propelled by any form of energy, or a combination of such units operated from a single control, used in train or yard service.
<i>Equipped Locomotive</i>	A locomotive equipped with I-ETMS and a communications system capable of supporting train control applications.
<i>Explicit Control</i>	The most permissive operating mode of the Office Segment Server.
<i>Full-Service Brake Application</i>	An application of the brakes resulting from a continuous or a split reduction in brake pipe pressure at a service rate until maximum brake

cylinder pressure is developed. As applied to an automatic or electro-pneumatic brake with speed governor control, an application other than emergency which develops the maximum brake cylinder pressure, as determined by the design of the brake equipment for the speed at which the train is operating. (49 CFR §236.701)

<i>Host Railroad</i>	A railroad that has effective operating control over a segment of track
<i>I-ETMS</i>	Used to refer to the railroad vital safety overlay system developed jointly by the Interoperable Train Control committee and Wabtec.
<i>Interoperability</i>	The ability of a controlling locomotive to communicate with and respond to the PTC railroad's positive train control system, including uninterrupted movements over property boundaries.
<i>ITC System</i>	An interoperable train control system being proposed by the major Class I freight carriers.
<i>Locomotive</i>	A single unit propelled by any form of energy.
<i>Main Track</i>	A track extending through yards and between stations, upon which trains are operated by movement authority or the use of which is governed by block signals.
<i>Mandatory Directive</i>	Any movement authority or speed restriction that affects a railroad operation. (49 CFR §220.5)
<i>Methods of Operation</i>	Track Warrant Control (TWC) with non-signal and Automatic Block Signal (ABS) applications, Centralized Traffic Control (CTC), or other operation types that generate mandatory directives.
<i>Miscellaneous Track Bulletin</i>	A track bulletin identifying conditions affecting operation of the train and safety of employees. Miscellaneous track bulletins may contain information not enforceable by I-ETMS.
<i>Non-Explicit Control</i>	A restrictive operating mode of the Office Segment Server.
<i>Non-Signaled Territory</i>	Track without signals, over which train movements are governed by timetable, track warrants, or operating rules; aka <i>dark territory</i>
<i>Penalty Brake Application</i>	A full-service brake application automatically invoked by a train control system or other locomotive appurtenance in response to failure to acknowledge an alert or comply with conditions imposed by the system or appurtenance.
<i>Permanent Speed Restriction</i>	Speed restriction as contained in the timetable or General Bulletin.
<i>Positive Train Control</i>	A system, further described in 49 CFR §236.1005, whose core functions include prevention of train-to-train collisions, derailments due to train overspeed, unauthorized train incursions into work zones, and movement of trains through switches in improper position.
<i>PTCIP</i>	PTC Implementation Plan as further described in 49 CFR §236.1011.
<i>PTCDP</i>	PTC Development Plan as further described in 49 CFR §236.1013.

<i>PTCSP</i>	PTC Safety Plan as further described in 49 CFR §236.1015.
<i>PTC System Certification</i>	Certification as required under 49 U.S.C §20157 and further described in §§236.1009 and 236.1015.
<i>Segment of track</i>	Any part of the railroad where a train operates.
<i>Siding</i>	A track auxiliary to the Main Track used for meeting or passing trains.
<i>Single Track</i>	A Main Track upon which trains are operated in both directions.
<i>Subdivision</i>	A portion of a division or region designated by the Timetable.
<i>Tenant Railroad</i>	A railroad, other than a host railroad, operating on track upon which a PTC system is required.
<i>Track Authority</i>	Movement authority provided by mandatory directive to a train or roadway worker.
<i>Track Bulletin</i>	Mandatory directive issued by the train dispatcher which affects the movement of trains. Track bulletins contain information enforceable by I-ETMS. Used generically in this document to refer to a temporary speed restriction, work zone, or miscellaneous restriction or message issued by Mandatory Directive.
<i>Track Database</i>	Database containing locations and attributes of track over which trains are subject to location tracking and enforcement.
<i>Track Segment</i>	Segment of track.
<i>Track Warrant Control</i>	A method of authorizing train movements or protecting track forces on a main track within specified limits in a territory so designated in the timetable.
<i>Traffic Control</i>	A system under which train or engine movements are authorized by block signals whose indications will supersede the superiority of trains for both opposing and following movements on the same track.
<i>Train Dispatcher</i>	The railroad employee responsible for supervising the movement of trains, engines, or employees on a Main Track or a controlled track.
<i>Uni-directional Authority</i>	A mandatory directive that authorizes train, engine, or employee movement in one direction on a Main Track or other controlled track.
<i>Work Authority</i>	A mandatory directive that authorizes train, engine, or employee movement in both directions on a Main Track or other controlled track.