

# **Track Inspector Rail Defect Reference Manual**

**July 2015, Revision 2**

**Office of Railroad Safety**



U.S. Department of Transportation

**Federal Railroad Administration**

# Foreword

This is the second edition of the Federal Railroad Administration (FRA) Track Inspector Rail Defect Reference Manual. This rail manual is compiled for use by employees of FRA that participate in the process of identification, inspection, and reporting of discovered rail flaws and rail flaws associated with rail failure as designated in Title 49 Code of Federal Regulations (CFR) Part 213, Track Safety Standards (TSS).

The use of this manual will ensure continued and accurate FRA oversight in railroad rail failure analysis and rail failure-caused derailment investigations. Proper rail failure analysis is particularly important when working with the various agencies and organizations associated with derailment investigations. The information compiled in this manual will allow the inspector to provide a more detailed and accurate reporting of rail conditions to the media or other agencies.

FRA regional Track inspectors will primarily use this manual to assist in the proper identification of these rail conditions. The manual is mainly designed to assist an FRA Track inspector in identifying the type of defect, defect development, rail surface condition, and various other aspects of rail identification and maintenance.

FRA regulatory authority does not involve all phases of rail maintenance within the U.S. general railroad system. However, an FRA Track inspector can be involved in the investigation process associated with rail flaw failure that may require a more extensive knowledge of the rail maintenance processes. This manual is intended to provide FRA inspectors with additional knowledge in these areas, which will enable them to perform their duty functions more efficiently, and may be updated in the future to address new regulatory changes.

This manual is divided into eleven separate sections. Each section contains various materials that will assist FRA Track inspectors in the performance of their responsibilities associated with railroad rails. Rail maintenance, such as rail lubrication, rail profile maintenance, and railroad internal track maintenance programs, greatly increases the life cycle of the rail. These practices also are deterrents to the crack growth life of internal rail flaws. Without aggressive track maintenance programs, rail flaw development and failure will continue to be an issue, and result in service disruption to the railroads.

# Table of Contents

**Foreword.....i**

**Table of Figures.....iii**

**Section 1: Defect Nomenclature..... 1**

**Section 2: Rail Manufacturers ..... 3**

**Section 3: Rail Identification/Sections ..... 5**

**Section 4: Development of Defects..... 9**

**Section 5: FRA Rail Defects and Description..... 18**

**Section 6: FRA Remedial Action Guidance..... 41**

**Section 7: Flaw Detection ..... 52**

**Section 8: Rolling Contact Fatigue ..... 56**

**Section 9: Rail Welding ..... 60**

**Section 10: Rail Grinding..... 65**

**Section 11: Definitions and Terminology..... 71**

## **Table of Figures**

Figure 1: Identifying Transverse Defects in Relation to Cross Sectional Area of Rail Head .....	2
Figure 2: Terminology Used to Identify Defect Planes in Relation to Rail Section .....	10
Figure 3: Transverse Fissure Showing Normal Growth Pattern. ....	12
Figure 4: Detail Fracture Showing Normal Growth pattern .....	13
Figure 5: Compound Fissure Showing Segments of Rapid Growth Rings.....	13
Figure 6: Detail Fracture Showing Normal and Sudden Growth Patterns .....	14
Figure 7: Detail Fracture Showing Normal, Rapid, and Sudden Growth Patterns .....	14
Figure 8: Vertical Split Head Showing Two-Stage Development .....	15
Figure 9: Weld Failure Showing First Stage Fatigue Development and Second Stage Rupture .....	16
Figure 10: Weld Failure Showing Preexisting Fatigue and Second Stage Rupture .....	16
Figure 11: Impact Batter from Rolling Stock Wheels .....	17
Figure 12: Friction Batter from Fracture Face Contact.....	17
Figure 13: Transverse Fissure .....	18
Figure 14: Compound Fissure.....	19
Figure 15: Detail Fracture Originating from a Visible Shell .....	20
Figure 16: Detail Fracture Originating from a Visible Shell .....	21
Figure 17: Detail Fracture from Head Check.....	21
Figure 18: Reverse Detail Fracture .....	22
Figure 19: Reverse Detail Fracture Showing Significant Development .....	23
Figure 20: Engine Burn Fracture Showing Significant Growth.....	23
Figure 21: Rail Failure Fracture Face Showing No Transverse Defect .....	24
Figure 22: Horizontal Split Head Originating from Internal Seam.....	25
Figure 23: Side View of Horizontal Split Head.....	25
Figure 24: Vertical Split Head Defect Breaking Out in Head/Web Fillet Area.....	26
Figure 25: Vertical Split Head Crack Out in Head/Web Fillet Area .....	27
Figure 26: Vertical Split Head (Shear Break) .....	27
Figure 27: Shear Break Showing Dark Discoloration Identifying Defect Length .....	28
Figure 28: Head and Web Separation Showing Progression into Web .....	29
Figure 29: Head and Web Defect Associated with Rail Joint.....	29
Figure 30: Split Web Defect Showing Bleeding Condition Along Crack Development.....	30
Figure 31: Web Failure Resulting from High Residual Stress.....	30
Figure 32: Piped Rail Showing Significant Rail Collapse.....	31
Figure 33: Base Defect Originating from an Identifiable Nick on Bottom of Rail.....	32
Figure 34: Half Moon Shaped Broken Base .....	32
Figure 35: Base Fracture Showing Nick with Transverse Development .....	33
Figure 36: Electric Flash Butt Weld Showing Oxide Entrapment and Progression .....	34
Figure 37: Thermite Weld with Slag Entrapment.....	35
Figure 38: Thermite Weld Showing Severe Porosity .....	35
Figure 39: Thermite Weld Showing Oblique Type Failure Originating in Web Area.....	36
Figure 40: Gas Pressure Weld Showing Oxide Inclusion and Improper Fusion .....	36
Figure 41: Transverse Defect Developing from Bond Application .....	37
Figure 42: Web Defect Developing from Bond Application .....	37
Figure 43: Bolt Hole Crack Originating in Lower Quadrant with Significant Progression.....	38
Figure 44: Flattened Rail.....	39

Figure 45: Damaged Rail .....	40
Figure 46: Example of Drooping Rail Head .....	40
Figure 47: Illustration of Acceptable Bolting Arrangements.....	49
Figure 48: Gauge Side Shell Showing Severe Parent Metal Decay.....	56
Figure 49: Centralized Flaking Condition Showing Chipping of Parent Metal .....	57
Figure 50 Thermal Cracks on Burned Stock Rail .....	57
Figure 51: Gauge Side Head Checking and Flaking.....	58
Figure 52: Flattened Rail Head Showing Displacement of Parent Metal (Spalling) .....	58
Figure 53: Newly Completed Electric Flash Butt Weld .....	61
Figure 54: Electric Flash Butt Weld in Track .....	61
Figure 55: New in Track Electric Flash Butt Weld.....	61
Figure 56: Gas Pressure Weld in Track .....	62
Figure 57: Thermitic Weld in Track .....	64
Figure 58: Boutet Weld in Track .....	64
Figure 59: Freshly Ground Rail .....	65
Figure 60: Rail Grinder at Work.....	67
Figure 61: Worn Low Rail Profile .....	68

# Section 1: Defect Nomenclature

## Typical Defect Classification Nomenclature (FRA and Industry) Used by U.S. Railroads

### Rail Defect Abbreviation and Definition

BBJ = Broken Base Joint Area  
BBO = Broken Base Outside Joint Area  
BHB = Bolt Hole Break  
BHJ = Bolt Hole Break Joint Area  
BHO = Bolt Hole Break Outside Joint Area  
BRJ = Broken Rail Joint Area  
BRO = Broken Rail Outside Joint Area  
CF = Compound Fissure  
CH = Crushed Head  
DF = Detail Fracture  
DWE = Defective Weld – Electric  
DWG = Defective Weld – Gas Pressure  
DWP = Defective Weld Plant  
DWF = Defective Weld Field  
EBF = Engine Burn Fracture  
HSJ = Horizontal Split Head Joint Area  
HSH = Horizontal Split Head Outside Joint Area  
HWJ = Head and Web Separation Joint Area  
HWO = Head and Web Separation Outside Joint Area  
PRJ = Piped Rail Joint Area  
PRO = Piped Rail Outside Joint Area  
REWF = Rail End Weld Fracture  
SWJ = Split Web Joint Area  
SWO = Split Web Outside Joint Area  
TDC = Compound Fissure  
TDD = Detail Fracture  
TDE = Transverse Defect Electrode Burn  
TDT = Transverse Fissure  
TDW = Transverse Defect Welded Burn  
TF = Transverse Fissure  
TWB = Thermite Weld Boutet  
TWBW = Thermite Weld Boutet Wide Gap  
TWO = Thermite Weld Orgotherm  
TWOW = Thermite Weld Orgotherm Wide Gap

VSJ = Vertical Split Head Joint Area  
VSH = Vertical Split Head Outside Joint Area  
WEBF = Welded Engine Burn Fracture

### **Additional Defect Nomenclature Used by United States Railroads**

NT = No Test  
SSC = Shelled, Spalled, Corrugated  
SD = Shell Defect  
SSH = Shell Defect  
EB = Engine Burn  
REX = Rail Exception  
DHS = Deep Horizontal Separation  
DWG = B Defective Weld Wide Fap Boutet  
DIW = Defective In-Track Weld  
DSW = Defective Slot Weld  
SBT = Signal Bond Thermite  
FR = Flattened Rail  
OTH = Damaged Rail

**Note: Sizing of all types of transverse-oriented defects is reported by an approximated percentage of cross-section area of the rail head. All other defect types are normally reported in inches.**



Figure 1: Identifying Transverse Defects in Relation to Cross Sectional Area of Rail Head

## Section 2: Rail Manufacturers

Much of the rail manufactured for North American use is from North American steel mills. However, many of the overseas steel mills realized the market potential that we offered, and it is not uncommon to see steel that was manufactured by a foreign steel mill almost anywhere in the general rail system.

It is important that we understand what the brandings on the rail section indicate because we need this information every time we classify a defect. It is also common for certain types of defects to be inherent to rail manufactured at a specific mill. Therefore, the inspector needs to understand the importance of this information.

Listed below are common manufacturers of rail used in North America. The list may exclude some rail manufacturers (if so, the omission is unintentional). However, it should be fairly well populated with the most common rail sections that we test today.

### Brand

### Manufacturer and Country

Algoma	Algoma Steel, Canada
ATH	Thyssen Steel, Germany
Steelton	Bethlehem Steel, Steelton Mill, USA
Lackawanna	Bethlehem Steel, Lackawanna Mill, USA
Maryland	Bethlehem Steel, Sparrow Points Mill, USA
BSCO	Bethlehem Steel, Steelton Mill, USA
BSC Workington	British Steel, Workington Mill, England
British Steel	British Steel, England
Carnegie	U.S. Steel, Carnegie Mill, USA
CF&I	Colorado Fuel & Iron, USA
Colorado	Colorado Fuel & Iron, USA
Corus	Corus Steel, France
DO	Voest Alpine Steel, Donawitz Mill, Austria
DOM	Dominion Steel, Canada
DOMINION	Dominion Steel, Canada
HY	Corus Steel, Hyange Mill, France
Illinois	U.S. Steel, USA
Inland	U.S. Steel, USA
ISG	International Steel Group (Formerly Bethlehem), USA
JFE	Japan Ferrous Steel, Japan
Klockner	Klockner Steel, Germany
Krupp	Krupp Steel, Germany
Lucchini	Lucchini Steel, Italy
MH	British Steel, Workington Steel, England
Mittal	Mittal Steel (Formerly Bethlehem), USA
MR	Rodange Steel, Luxemburg
Nippon	Nippon Steel, Japan



NKK	Nippon Steel, Kokan Mill, Japan
PST	Pennsylvania Steel Technologies (Formerly Bethlehem), USA
RMSM	Rocky Mountain Steel Mill (Formerly CF&I), USA
Rodange	Rodange Steel, Luxemburg
Sacilor	Sacilor Steel, France
Sumitomo	Nippon Steel, Sumitomo Mill, Japan
SDI	Steel Dynamics Inc., Columbia City Mill, USA
Sydney	Sydney Steel, Canada
SYSCO	Sydney Steel, Canada
TCI	U.S. Steel, Tennessee Mill, USA
TENN	U.S. Steel, Tennessee Mill, USA
TENNESSEE	U.S. Steel, Tennessee Mill, USA
Thyssen	Thyssen Steel, Germany
TZ	Moravia Steel, Czech Republic
VILRU	Villerupt Steel, France
Wheeling	Wheeling Pittsburgh Steel, USA
WP	Wheeling Pittsburgh Steel, USA
Workington	British Steel, Workington Steel, England

# Section 3: Rail Identification/Sections

The rail sections that we test come from many different steel mills and are of various types and weights. It is very important that we know how to identify this information when performing our jobs. Rail sections that are manufactured today are identified by two markings that are located on the web of each rail. These markings are rolled into the rail during the final stages of rolling mentioned above.

The first marking referred to below is called the “branding.” The rail section brand is the raised lettering on one side of the web. This information provides you with the section type or style. The second marking is referred to as the “heat stamp” of the rail section and is located on the opposite side of the web as the branding. This is the information used to identify the specific rail section.

## Rail Branding

The rail web is branded at least every 16 feet, and the branding will consist of the following information:

- Weight per every 3 feet of rail: two- or three-digit number
- Section: two-letter code
- Type of process used for hydrogen elimination: two-letter code
- Manufacturer: spelled out, letter code, or symbol
- Year rolled: four-digit number
- Month rolled: lines or roman numerals

<b>Example:</b>	<b>141</b>	<b>RE</b>	<b>Mittal</b>	<b>2006</b>	<b>11111</b>
	Rail	Section	Manufacturer	Year	Month
	Weight			Rolled	Rolled

## Rail Stamping

The web of each rail is “hot stamped” at least every 16 feet on the opposite side as the branding and should not be within a 2-foot proximity of a rail end. The data will contain the following information:

- Heat Number
- Rail Position Letter
- Ingot or Strand/Bloom Number
- Method of Hydrogen Elimination (Optional)

**Note:** Ingots are numbered by letters that succeed each other starting with “A,” designating their position in the cast. Strand/bloom numbers may be joined or separately coded at the manufacturer’s preference.

## Continuous Cast Stamping Example:

<b>168362</b>	<b>HH</b>	<b>B</b>	<b>27</b>	<b>VT</b>
Heat Number	Type of Rail	Rail Position Letter	Rail Bloom	Strand & Method of Hydrogen Elimination

## Ingot Cast Stamping Example:

<b>HH</b>	<b>287165</b>	<b>A</b>	<b>12</b>
Type of Rail	Heat Number	Rail Letter	Ingot Number

## Steelmaking Processes of Hydrogen Elimination

The steelmaking process will identify the method that hydrogen was removed from rail steel while in the molten state or in ingot, bloom, strand, or rail section form. The most common method in North American steel is controlled cooling. The methods used are identified by the following:

- CC – Control Cooled
- BC – Bloom Cooled
- VT – Vacuum Treated
- HH – Head Hardened
- OH – Open Hearth Method

Gases absorbed by the liquid steel during the heat process can cause shatter cracks, voids, inclusions, and other harmful phenomena in the steel after it has solidified. Hydrogen has been recognized for some time to be the predominant cause for shatter cracks and other inclusions during the manufacturing process. By using one of the cooling processes above the rail, manufacturers have had significant success in removing hydrogen from rail.

## Rail Sections Encountered in North America

The rail section identifies the engineering association that established the design specifications for the section. The most commonly used section used in North America is the “RE” section.

### North American Rail Sections

**RE:** AREA (American Railway Engineering Association) or AREMA (American Railway Engineering and Maintenance-of-Way Association)

**ARA-A:** ARA, American Railway Association, high speed  
**ARA-B:** ARA, American Railway Association, low speed  
**AS:** ASCE, American Society of Civil Engineers  
**ASCE:** ASCE, American Society of Civil Engineers  
**AB:** Atkinson Bowman  
**CB:** C&O, B&O  
**DY:** Dudley  
**DYM:** Dudley Modified  
**NYC:** New York Central  
**PS:** Pennsylvania Railroad Standard  
**NH:** New York, New Haven and Hartford  
**HF:** Head Free

## **Rail Grade Stamp**

The rail grade stamp is a series of numbers that designate the grade or strength of the rail.

### **Standard Rail**

**CC** – Control Cool  
**MH** – Medium Hardness  
**CH** – Control Cooled End Hardened  
**3HB** – 300 Brinell Hardness  
**CrMo** – Chrome Molybdenum Alloy  
**CROMO RAIL** – Chrome Molybdenum Alloy  
**SS** – Standard Strength  
**IH** – Intermediate Hardness  
**HISI** – High Silicon  
**SMH** – Intermediate Hardness  
**SA** – Special Application

### **Premium Rail**

**HH** – Head Hardened  
**FHH** – Fully Head Hardened  
**FT** – Fully Heat Treated  
**CT** – Control Treated  
**LHH** – Low Alloy Head Hardened  
**LAHH** – Low Alloy Head Hardened  
**DS** – Micro Alloy Head Hardened  
**HCP** – High Carbon Pearlite  
**NH** – New Head Hardened  
**OCP** – One Percent Carbon Pearlite  
**HS** – High Carbon Micro Alloy Head Hardened  
**DH** – Deep Head Hardened

**DH37, DH37S, DH370** – Deep Head Hardened 370 Brinell  
**DH400** – Deep Head Hardened 400 Brinell  
**HE** – Hypereutectoid  
**HE370** – Hypereutectoid 370 Brinell  
**HE400** – Hypereutectoid 400 Brinell

## **Rail Manufacturing Process**

The manufacturing process of steel requires huge quantities of raw materials and many processes. Steel is essentially a combination of iron and carbon. These products, along with other alloys, determine the metallurgical characteristics of the finished steel. For example, to manufacture 1 ton of steel, it can take 1½ tons of iron ore; ⅔ ton of coal; 1/5 ton of limestone; ¼ ton of iron and/or steel scrap; 165 tons of water; and 8 tons of air. Other alloys are added to alter the metallurgical structure of the steel.

Rail manufacturing can be grouped into four stages. They are (1) the production of molten steel from the necessary raw materials; (2) the casting of the liquid to form ingots or continuously cast blooms; (3) the rolling process to form cross sections of rail; and (4) finishing, which consists of cooling, straightening, cutting to the desired length, and final inspection.

Current steel for rail is produced by the basic oxygen process or by the electric arc furnace process; in effect, heat produced by gas or electricity. Both of these processes produce a molten steel material of high quality that is ready to be rolled into rails. While in the liquid, it is then poured into molded ingots.

After the ingots have cooled and solidified, they are stripped from the molds and sent to a soaking pit. In the soaking pit, they are reheated to a rolling temperature of approximately 2350 °F. Once this temperature is reached, they are moved to the rolling or blooming mill where they are rolled into their final form. The rail usually reaches a temperature below 1900 °F during completion of this process.

When the rolling is completed, each of the rails is moved to the cooling bed and cooled to about 1000 °F. The purpose of control cooling is to reduce the hydrogen content and improve the hardness of the rail. After the rails are removed from the control-cooling bed, they are passed through a roller and straightened vertically and laterally. Once the rail is straightened, it must pass the inspection process prior to shipment.

# Section 4: Development of Defects

## Introduction

There are several factors that can influence the expected duration of rail service. The service life is affected primarily by the chemical composition of the rail, track maintenance programs, speed, and tonnage. All of these factor into the development of vertical and lateral head wear, plastic flow or deformation of the rail head, and development of rail defects.

- **Track maintenance programs** – Track maintenance programs consist of any track maintenance procedure that can ensure the track can maintain adequate support to reduce the amount of rail flexing, provide proper friction control, and provide rail profile maintenance that will considerably influence the rail service life.
- **Wear** – Lateral wear occurs primarily on the gauge face when the rail is located on the high side of a curve from the presence of high-wheel flange force. Vertical wear occurs on the rail head running surface from the wheel/rail interaction during cyclical loading and rail grinding patterns.
- **Plastic flow** – Plastic flow or mechanical deformation of the rail head can occur on high or low rail, and is normally associated in curves that carry higher axle load operations. Plastic flow is a result of wheel/rail contact stress that is exceeding the material strength of the rail steel.
- **Rail defects** – Rail defects develop in any type of rail, or rail welds, as a result of several conditions. These conditions normally will originate from the rail manufacturing process; cyclical loading; and impact from rolling stock, rail wear, and plastic flow.

The development of rail defects can be influenced in modern steel through an extensive maintenance program that will prolong the timeframe before the rail is subjected to the affects of excessive wear and plastic flow. This would include friction control methods and proper rail profile. However, it is impossible to accurately predict rail service life or defect development.

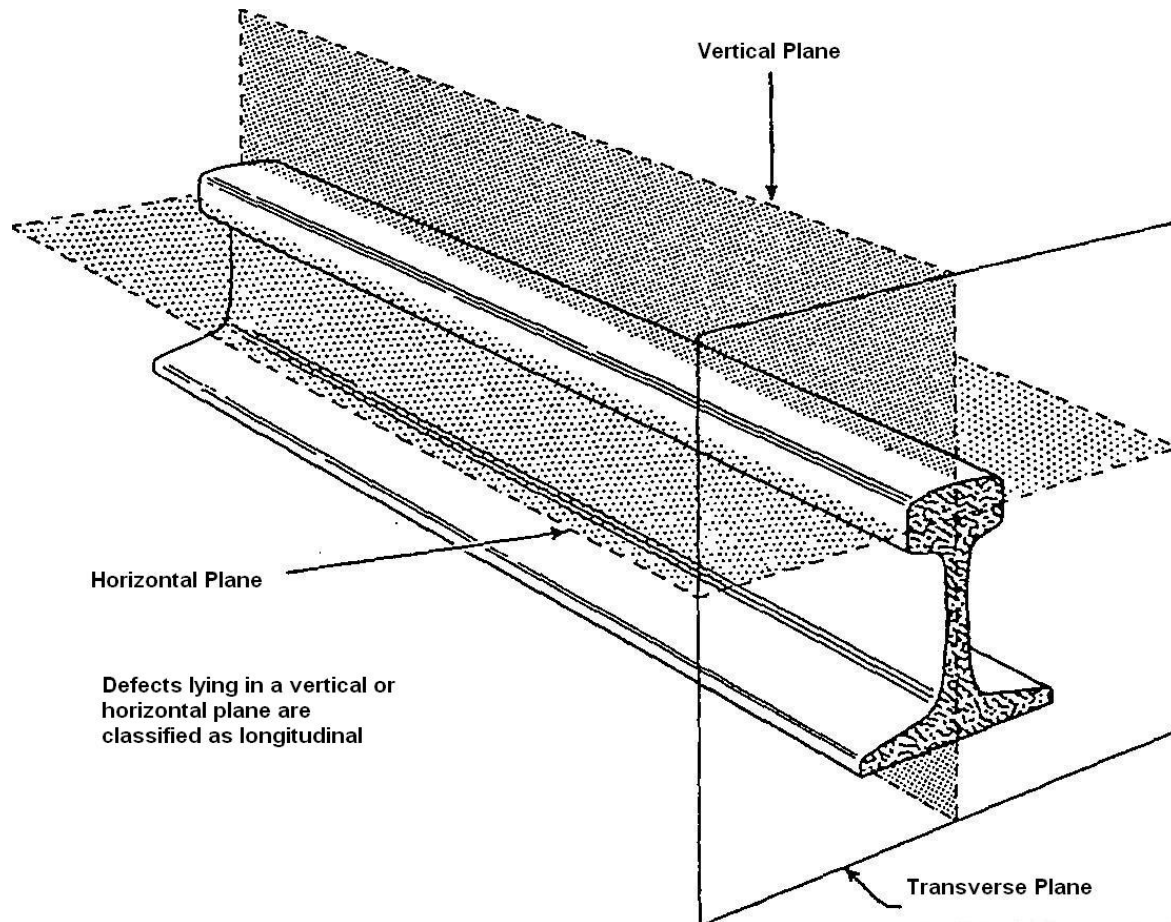

Figure 2: Terminology Used to Identify Defect Planes in Relation to Rail Section

### **Rail Loading and Stressing**

Internal rail defects normally require certain forms of rail stresses to initiate progression and develop to a detectable size defect. Listed below is terminology that can be used to describe the planes of stresses in rail:

- Vertical Plane – stresses progressing in a longitudinal direction normal to rail length
- Horizontal Plane – stresses progressing horizontally along the rail
- Transverse Plane – stresses progressing transversely along the cross section of the rail

### **Rail Loading at the Rail/Wheel Interface**

**Vertical Loading** – Loading forces applied by the wheel tread under normal train operation. They are normally characterized into three components referred to as static load, dynamic load, and impact load. Static load is the equivalent to the gross weight of the railcar divided by the number of wheels (i.e., 160-ton railcar with 8 wheels has a static load of 20 tons). The static loading can be influenced by track curve super-elevation. Dynamic loading is the increase of static load that results from train speed. This is a result of vertical dynamics associated with the car truck interaction with the track geometry. Impact loading is the additional increased loading over static and dynamic that

occurs when a wheel travels over a significant rail head irregularity, or the wheel contains a flat spot.

**(Note: Actual vertical loading of the rail can be determined by the addition of the above components and can be considerably greater than a normal static load.)**

Lateral Loading – The load forces applied by the wheel flange to the high rail in curved track. This is a result of wheel/truck curving forces. In sharp curves, lateral loading is normally stable throughout the curve. However, in a shallow curve or tangent track, lateral loading can occur as a result of truck hunting.

Creep – Load forces that are generated at the localized rail/wheel interface by the rolling action of the wheel. Longitudinal creep forces result from traction applied to the rail head by the wheel. Transverse creep forces result from lateral movement of the wheel during truck hunting.

### **Rail Stresses**

Bending Stress – Bending of the rail that occurs from vertical wheel loading and lateral wheel loading. Vertical wheel loading normally results from loading between the tie supports, and causes tensile longitudinal stresses in the rail base area and head/web fillet area. Lateral wheel loading applies tensile longitudinal stresses in the rail web area and head/web area of the rail field side.

Thermal Stress – These stresses occur in continuous welded rails due to thermal expansion and contractions that occur as the actual rail temperature increases above or reduces below the rail neutral temperature. When the rail temperature is above neutral temperature, compressive longitudinal stresses are established. When the rail temperature is below neutral temperature, tensile longitudinal stresses are established. These stresses can drastically influence rail flaw development.

Residual Stress – These stresses are a result of the manufacturing process, particularly from roller straightening and head hardening. They can also result from the welding of rails because of the different expansion and contraction of the steel that occurs during the weld process. Residual stresses can be found in any location within the rail section and can exhibit high tensile stresses that can result in rail failure.

### **Defect Development Identification**

Defect development identification is determined by the type of defect, origin, and direction of development in relation to the planes of the rail section. These are identified as transverse, vertical and horizontal planes of development. The defects that develop in a transverse plane in relationship to the rail section are normally internal in origin and are not visibly identified until the defect progression penetrates the rail head.

Internal transverse defect size can only be identified visibly by breaking the cross-section of the rail in a press. After the rail is broken, a transverse defect is measured against the cross-sectional area



of the rail head. If half of the rail head cross-section shows signs of defective growth, the defect is called a 50-percent fracture.

When the defective portion of the rail is closely examined, certain characteristics provide information that will allow the type of growth identification the defect had experienced. Transverse growth is normally referred to in three types of classifications:

**Normal Growth** – Defect development over a period of time in gradual stages. Normal development is typically progressive and can be uninterrupted. The defect will show a smooth and polished fracture with no granular structure. There may also be a number of identifiable smooth granular growth rings.



Figure 3: Transverse Fissure Showing Normal Growth Pattern.



Figure 4: Detail Fracture Showing Normal Growth pattern

**Rapid Growth** – Signifies recent development in numerous small stages. The small, polished, well-defined fracture is surrounded by a rough granular surface, which shows the outline of several growth rings of gradual increasing size.



Figure 5: Compound Fissure Showing Segments of Rapid Growth Rings.

**Sudden Growth** – Signifies recent development in a few large stages. The small, polished, well-defined fracture is surrounded by a rough granular surface, which shows the outline of one or two growth rings. The distance between rings will increase directly with the rate of growth.



Figure 6: Detail Fracture Showing Normal and Sudden Growth Patterns

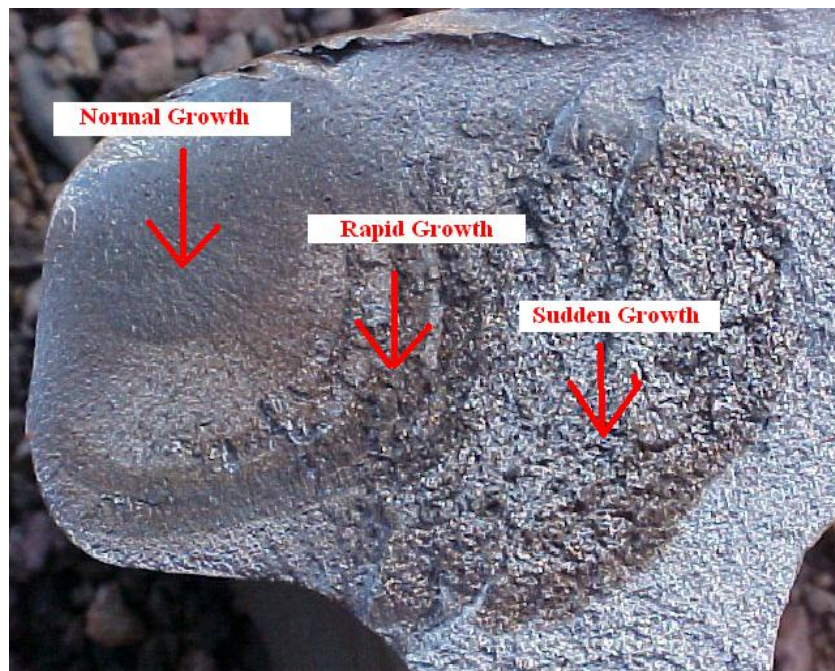

Figure 7: Detail Fracture Showing Normal, Rapid, and Sudden Growth Patterns

### Multiple Stage Ruptures

Defects that develop in an oblique, angular, or longitudinal direction in relationship to the rail section can also produce identifiable stages of development, referred to as multiple stage ruptures. This is often seen in bolt hole breaks, base breaks, and head and web separations. When a longitudinal or angular defect shows signs of various stages of development each is considered a separate stage of development. This is normally identified by the presence of a preexisting

identifiable fatigue condition along with another growth stage, or complete failure, referred to as secondary development. There may also be a previously oxidized portion within the break and a normal granular non-oxidized portion of break. The oxidized portion may represent the initial stage of development, and the normal granular non-oxidized portion will normally represent the secondary stage of development. It is possible to have more than two stages of development before complete failure of the defect. If a preexisting fatigue condition is not identified on the fracture face, the failure is commonly referred to as a “sudden rupture.”



Figure 8: Vertical Split Head Showing Two-Stage Development



Two Stage  
Weld Failure  
Fracture Face  
with Oxidation  
First Stage of  
Break; Total  
Fracture of  
Rail is Second  
Stage Break  
Showing No  
Discoloration

Figure 9: Weld Failure Showing First Stage Fatigue Development and Second Stage Rupture



Pre-existing Fatigue

Figure 10: Weld Failure Showing Preexisting Fatigue and Second Stage Rupture

## Rail Batter

There are two significant types of rail batter that an inspector will normally encounter during review of a rail defect. They are generally referred to as impact and friction batter. Impact batter is a result of a rail breaking exposing the fracture face to wheel impact from rolling stock. Friction batter is a result of sufficient rail section separation allowing the two fracture faces to make contact under load. Batter is identified as significant rail-end damage or a smooth polished fracture face. Both types of batter can obliterate the matching fracture faces preventing identification of an underlying fatigue condition.



Figure 11: Impact Batter from Rolling Stock Wheels



Figure 12: Friction Batter from Fracture Face Contact

# Section 5: FRA Rail Defects and Description

## Transverse Defects in the Rail Head

A transverse defect is a type of fatigue that has developed in a plane transverse to the cross sectional area of the rail head. Development can be normal or in multiple stages prior to failure. The transverse defect is only identified by the nondestructive inspection process, unless the defect has progressed to the rail running surface and has cracked out.

### Transverse Fissure



Figure 13: Transverse Fissure

**Description** – Transverse fissure means a progressive crosswise fracture starting from a crystalline center or nucleus inside the head from which it spreads outward as a smooth, bright, or dark, round or oval surface substantially at a right angle to the length of the rail. The distinguishing features of a transverse fissure from other types of fractures or defects are the crystalline center or nucleus and the nearly smooth surface of the development that surrounds it.

Transverse fissure defects are inherent from the manufacturing process and are found predominantly in noncontrol cooled rail prior to the mid-1930s. However, it can develop in more modern high-chrome rail from a hydrogen imperfection. It is not uncommon for multiple fissures to be present in one rail length. Identification of this type defect is not accurately made until the rail section is broken and the size determined by the area of cross-section of the rail head affected. It is normal for a transverse fissure to remain in service for some time without

further development. Development is highly influenced by wheel impact and rail bending stresses, and growth is normally slow to a size encompassing 20- to 25-percent cross-sectional area of the rail head. Once the defect reaches this size, growth is normally more accelerated.

### Compound Fissure

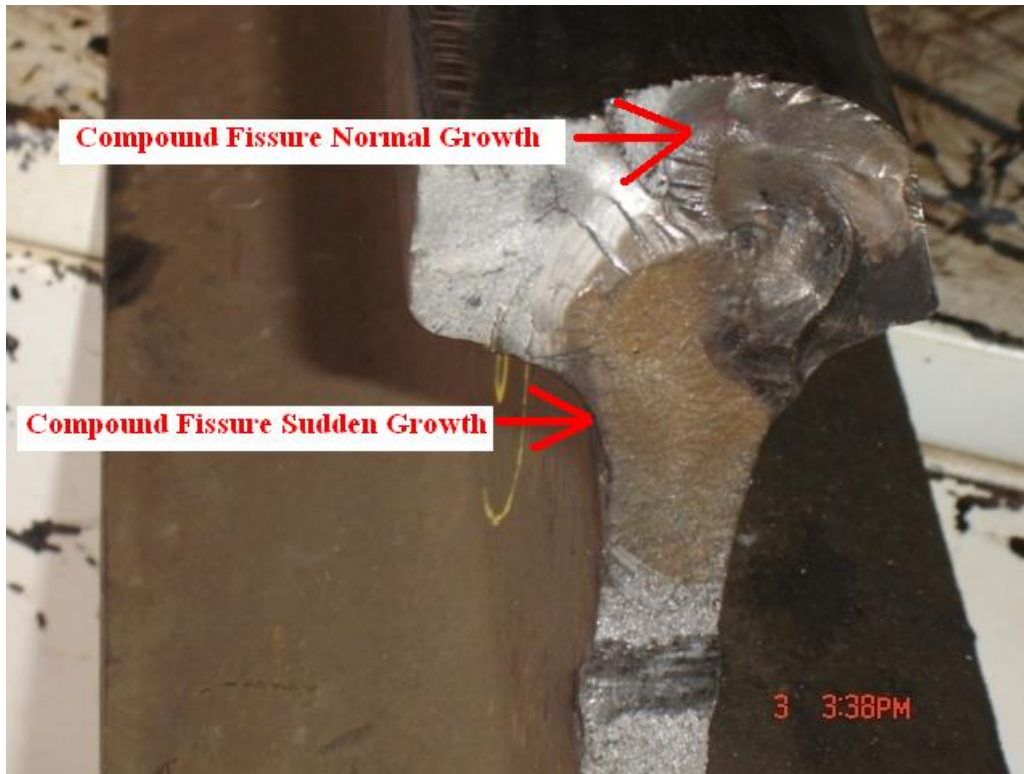

Figure 14: Compound Fissure

**Description** – Compound fissure means a progressive fracture originating from a horizontal split head that turns up or down, or in both directions, in the head of the rail. Transverse development normally progresses substantially at a right angle to the length of the rail.

The defect normally originates as a horizontal separation from an internal longitudinal seam, segregation, or inclusion inherent from the manufacturing process. It then develops longitudinally prior to transverse progression upward, downward, or in both directions in relation to the transverse plane of the rail section.

Growth is normally slow to a size of 30–35 percent. The compound fissure can result in an oblique type failure and is considered a hazardous rail defect.



## Detail Fracture



Figure 15: Detail Fracture Originating from a Visible Shell

**Description** – Detail fracture means a progressive fracture originating at or near the surface of the rail head. These fractures should not be confused with transverse fissures, compound fissures, or other defects, which have internal origins. Detail fractures may originate from shelly spots, head checks, or flaking.

The detail fracture is usually associated with the presence of a longitudinal seam or streak near the running surface on the gage side. Unlike the transverse fissure, no nucleus will be present. Growth can be normally slow to a size of a 10- or 15-percent cross-section of the rail head. Growth can then become rapid and/or sudden, prior to complete failure. It is not uncommon for more than one detail fracture to develop in an immediate area where the conditions that initiate their development, such as shelling or head checking, are present.



Figure 16: Detail Fracture Originating from a Visible Shell

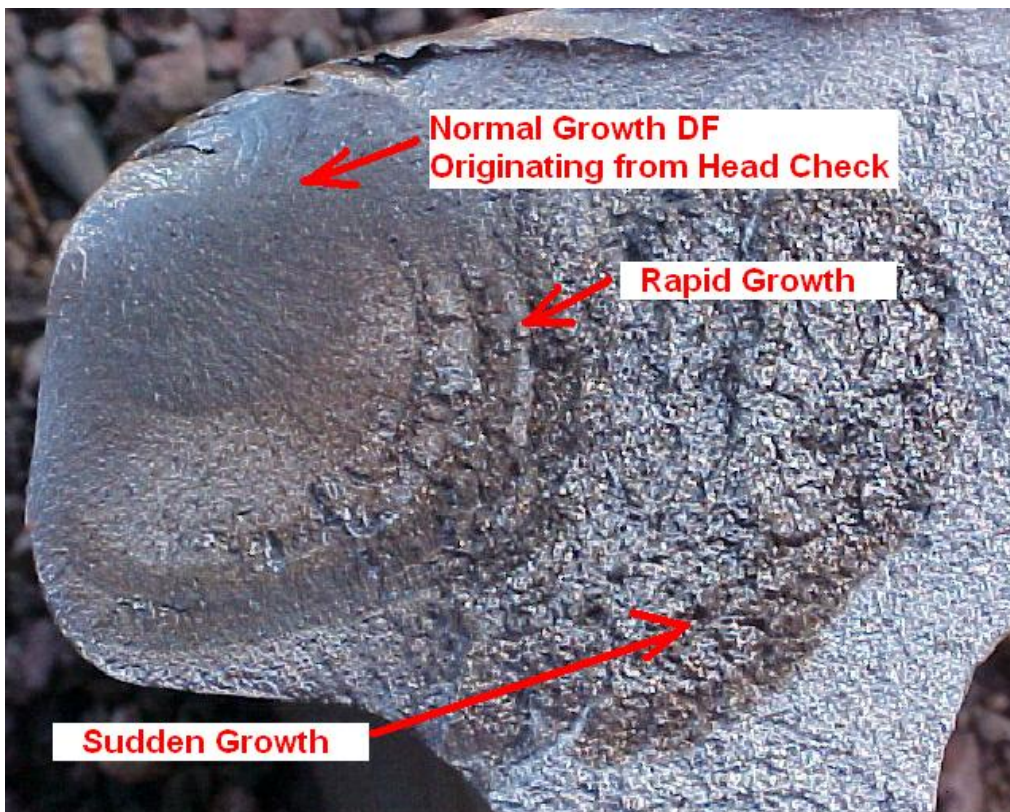

Figure 17: Detail Fracture from Head Check

The detail fracture from the head check is a progressive fracture initiating at the gage corner of the rail head and developing transversely in the head. The origin is a head check condition located at the upper gage corner of the rail, normally associated with concentrated loading which cold works the steel. This can also be referred to as a thermal crack. Growth can be very rapid after a size of 5–10 percent cross sectional area of the rail head is reached.



Figure 18: Reverse Detail Fracture

The reverse detail fracture is a progressive transverse fracture normally originating at the bottom corner of the gage side of the rail head. The origin is a stress riser associated with a notching condition on the cold rolled lip located on the bottom corner of the rail head. The cold rolled lip condition is typically associated with severely worn rail and high axle loadings. The growth is normal to a size of 10 percent and is often rapid or sudden prior to complete failure of the rail section. It is not uncommon for complete failure at a size much less than that of a typical detail fracture type defect.



Figure 19: Reverse Detail Fracture Showing Significant Development

### **Engine Burn Fracture**



Figure 20: Engine Burn Fracture Showing Significant Growth

**Description** – Engine burn fracture means a progressive fracture originating in spots where driving wheels have slipped on top of the rail head. In developing downward, they frequently resemble the compound or even transverse fissures with which they should not be confused or classified.

The defect originates when a slipping engine driver wheel heats a portion of the rail surface, and rapid cooling forms thermal cracks. Impact from wheels over the affected burned area initiates a slight horizontal separation of the burned metal from the parent rail metal and develops a flat spot. Transverse separation may start from a thermal crack in the region of the burn at any time.

It is common for more than one engine burn to be located within a short proximity. Growth is normally slow to a size of 10–15 percent. However, once transverse separation reaches a size of 10–15 percent, growth can become accelerated.

### Ordinary Break



Figure 21: Rail Failure Fracture Face Showing No Transverse Defect

**Description** – Ordinary break means a partial or complete break in which there is no sign of a fissure, and in which none of the other defects described in this section is found.

In very cold weather, this type of rail fracture can occur as a result of a significant wheel impact from a flat or broken wheel. This type of failure can also be more susceptible to break where an unevenly supported base is present. The cause of failure cannot easily be determined.

# Longitudinal Defects in the Rail Head

## Horizontal Split Head

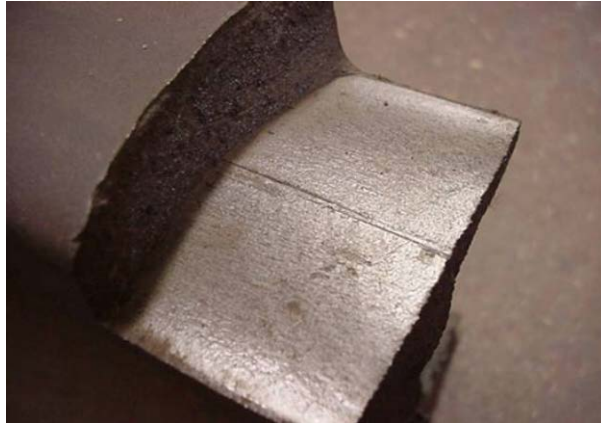

Figure 22: Horizontal Split Head Originating from Internal Seam

**Description** – Horizontal split head means a horizontal progressive defect originating inside of the rail head, usually one-quarter inch or more below the running surface and progressing horizontally in all directions, and generally accompanied by a flat spot on the running surface. The defect appears as a crack lengthwise of the rail when it reaches the side of the rail head.

The horizontal split head originates from an internal longitudinal seam, segregation, or inclusion inherent from the manufacturing process. Horizontal separation will progress longitudinally and horizontally (parallel to the running surface) and is normally rapid in development. Wheel impact can initiate transverse separation, in which case the defect should be classified as a compound fissure. The horizontal separation may be present in several locations within the same rail section.



Figure 23: Side View of Horizontal Split Head

## Vertical Split Head



Figure 24: Vertical Split Head Defect Breaking Out in Head/Web Fillet Area

**Description** – Vertical split head means a vertical split through or near the middle of the head, extending into or through it. A crack or rust streak may show under the head close to the web or pieces may be split off the side of the head.

The origin is an internal longitudinal seam, segregation, or inclusion inherent from the manufacturing process. Vertical separation will progress longitudinally and vertically (parallel to side of head), and may gradually turn toward the gage or field side of the rail head. It is common for a portion of a vertical split head to develop toward the gage side of the rail head while the other end develops toward the field side.

Growth is normally very rapid once the seam or separation has opened up anywhere along its length.

The vertical split head defect can be identified by the presence of a dark streak on the running surface and widening of the head for the length of the defect development. The side of the head to which the split is offset may show signs of sagging or dropping, and a rust streak may be present in the head/web fillet area under the rail head. In advanced stages, a bleeding crack will be apparent at the fillet.



Figure 25: Vertical Split Head Crack Out in Head/Web Fillet Area



Figure 26: Vertical Split Head (Shear Break)



A shear break is a longitudinal separation of the rail head, resulting from the loss of significant rail head parent metal. The reduction of rail head parent metal results in the loss of the ability of the rail section to support loading, and is not typically associated with inherent conditions in the material. A shear break usually occurs when the rail is loaded off the center axis, causing rail head collapse, and can be associated with gaging problems, light weight rail, severely worn (vertical wear) rail, or off-center loads caused by worn rolling stock wheels.

Growth is usually very sudden, and more than one shear break may be present in the immediate vicinity as a result of the significant weakness of the rail head. Visual characteristics are the same as a vertical split head and it is classified as a vertical split head defect when discovered.



Figure 27: Shear Break Showing Dark Discoloration Identifying Defect Length

## Web Defects

### Head and Web Separation



Figure 28: Head and Web Separation Showing Progression into Web

**Description** – Head and web separation means a progressive fracture longitudinally separating the head and web of the rail at the fillet under the head.

Acidic action from some asphalt-based fill material, used in road crossings, may initiate a corrosion fatigue where the rail head joins the web. Gravel in crossings, excessive speed on curves, or improper canting of the rail can cause eccentric loading of the rail head and initiate development. Fatigue development can appear as rust-colored “rail strain” in the head/web fillet area, or as a slight horizontal cracking under the head. This type of defect can also develop in the head fillet area at the jointed rail end as a result of extreme stress conditions often created by pumping or swinging joints.



Figure 29: Head and Web Defect Associated with Rail Joint

## Split Web



Figure 30: Split Web Defect Showing Bleeding Condition Along Crack Development

**Description** – Split web means a lengthwise crack along the side of the web, extending into or through it. The origin can be a seam or damage to the web, mechanical damage, or the split web can sometimes develop at locations where heat numbers are stamped into the web. Split webs can also develop as a result of high residual stresses from the roller straightening process, rail welding, and joint application.

Growth can be very rapid once the crack extends through web. It can also be accelerated by heavy axle loading. The defect can be visibly identified by the presence of rust-colored bleeding along the crack development.



Figure 31: Web Failure Resulting from High Residual Stress

## Piped Rail



Figure 32: Piped Rail Showing Significant Rail Collapse

**Description** – Piped rail means a vertical split in a rail, usually in the web, due to failure of the shrinkage cavity in the ingot to unite in rolling.

The origin of a piped rail is normally from the presence of a longitudinal seam or cavity inside the web that is inherent from the manufacturing process. Once development initiates, the seam will develop vertically toward the head and base of the rail. This type of defect is relatively uncommon in modern rail manufacturing technology.

The original seam does not normally progress either vertically or horizontally. Heavy axle loading can result in the seam spreading or opening up in a crosswise direction, resulting in a bulge in the web. These internal seams are also susceptible to development when subjected to pressure butt welding.

## Miscellaneous Defects

### Broken Base



Figure 33: Base Defect Originating from an Identifiable Nick on Bottom of Rail



Figure 34: Half-Moon-Shaped Broken Base

**Description** – Broken base means any break in the base of the rail. Broken base is generally categorized into two types of failure—broken base and base fracture. A broken base is normally confined within the flange area of the rail base and is normally an oval-shaped break referred to as a “half moon” break. This type of base break is commonly caused by a seam, segregation, or improper bearing on the tie plate. A base fracture is normally the result of a nick or other type damage to the base that results in an identifiable indentation.



Figure 35: Base Fracture Showing Nick with Transverse Development

A base fracture is a progressive fracture in the base of the rail, which can develop in a transverse plane. These defects, as a rule, originate on the outer edge of the base and can result in complete transverse failure of the rail section. Base fractures are usually caused by a nick on or a blow to the edge of the base, which results in an indentation or similar damage. Damage of this nature is sometimes caused by improper rail handling.

Transverse development can be relatively slow until the defect has progressed some distance into the rail section. However, a complete and sudden transverse rupture of the rail can occur with minimal transverse progression.

## Defective Weld



Figure 36: Electric Flash Butt Weld Showing Oxide Entrapment and Progression

**Description** – Defective weld means a field or plant weld containing any discontinuities or pockets, exceeding 5 percent of the rail head area individually or 10 percent in the aggregate (oriented in or near the transverse plane) due to incomplete penetration of the weld metal between the rail ends, lack of fusion between weld and rail end metal, entrapment of slag or sand, underbead or other shrinkage cracking, or fatigue cracking. Weld defects may originate in the rail head, web, or base, and in some cases, cracks may progress from the defect into either or both adjoining rail ends. If the weld defect progresses longitudinally through the weld section, the defect is considered a split web for purposes of remedial action.

Plant welds are identifiable as a result of the shearing processes used to remove excessive weld material. This removal will provide a finish that is more flush with the web design, as opposed to field welds that will show excess weld material along the web and base area of the rail. Both types of welds can also fail at an angular or oblique direction from an anomaly associated with the web area such as shear gouges, trapped oxides, or improper heat.



Figure 37: Thermite Weld with Slag Entrapment



Figure 38: Thermite Weld Showing Severe Porosity





Figure 39: Thermite Weld Showing Oblique Type Failure Originating in Web Area

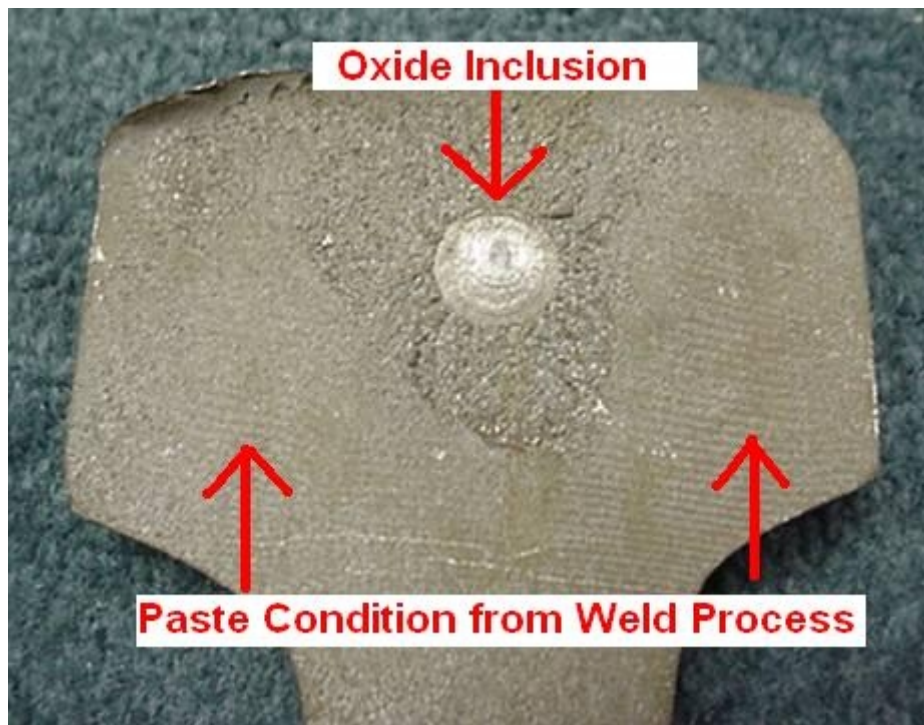

Figure 40: Gas Pressure Weld Showing Oxide Inclusion and Improper Fusion

## Detail Fracture Associated with Welded Bond Wire Connection (Traction, Signal)



Figure 41: Transverse Defect Developing from Bond Application

**Description** – A welded bond wire connection can be the origin of a transverse defect that develops and expands from the point on the rail head where a head bond is attached by welding. It is questionable whether the primary cause of transverse defects associated with welded bonds is due to thermal cracks being created by rapid or irregular cooling at or near the point where the bond is attached or whether the focal point of the defect is a metallurgic reaction and the resulting penetration of the native metal through a martensite layer sometimes developed between the bond and the rail head. The inspector should be aware that rail defects can also develop from bond applications to the rail web.



Figure 42: Web Defect Developing from Bond Application

## Bolt Hole Crack



Figure 43: Bolt Hole Crack Originating in Lower Quadrant with Significant Progression

**Description** – Bolt hole crack means a crack across the web, originating from a bolt hole, and progressing on a path either inclined upward toward the rail head or inclined downward toward the base. Fully developed bolt hole cracks may continue horizontally along the head/web or base/web fillet, or they may progress into and through the head or base to separate a piece of the rail end from the rail. Multiple cracks occurring in one rail end are considered to be a single defect. However, bolt hole cracks occurring in adjacent rail ends within the same joint must be reported as separate defects.

A bolt hole crack is normally the result of stresses associated with pumping or swinging joints, improper drilling, excessively worn joint bars, or abnormal rail end impacts from rolling stock. Unchamfered holes that result a drilling burr on the edge of the hole left by the drilling operation can result in defect development. Growth is normally erratic and the rail can frequently rupture from a very small defect when the rail end is subjected to unusual stresses.

## Flattened Rail



Figure 44: Flattened Rail

**Description** – Flattened rail means a short length of rail, not at a joint, that has flattened out across the width of the rail head to a depth of three-eighths inch or more below the rest of the rail and 8 inches or more in length. Flattened rail occurrences have no repetitive regularity and thus do not include corrugations, and have no apparent localized cause such as a weld or engine burn. Their individual lengths are relatively short, as compared to a condition such as head flow on the low rail of curves.

## Damaged Rail



Figure 45: Damaged Rail

**Description** – Damaged rail means any rail broken or injured by wrecks, broken, flat, or unbalanced wheel, wheel slipping, or similar causes.

## Crushed Head

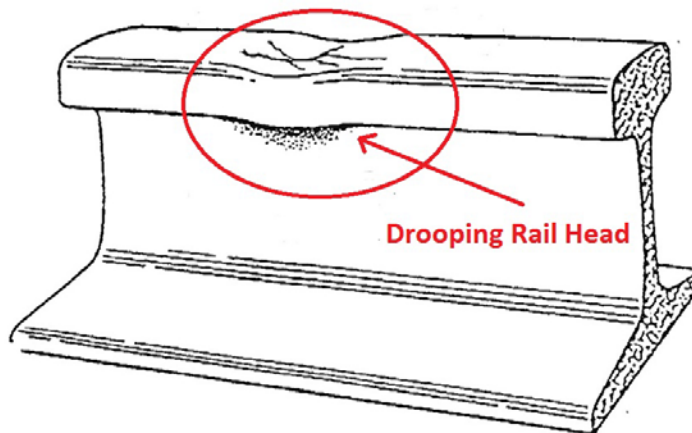

Figure 46: Example of Drooping Rail Head

**Description** – Crushed head means a short length of rail, not at a joint, which has drooped or sagged across the width of the rail head to a depth of three-eighths inch or more below the rest of the rail head and 8 inches or more in length. Unlike flattened rail, where the depression is visible on the rail head only, the sagging or drooping is also visible in the head/web fillet area.

# Section 6: FRA Remedial Action Guidance

## Rail Defect Remedial Actions as Designated by the Track Safety Standards, 49 CFR Part 213, Section 213.113, *Defective rails*:

Notes:

A. Assign person designated under § 213.7 to visually supervise each operation over defective rail.

A2. Assign person designated under § 213.7 to make visual inspection. After a visual inspection, that person may authorize operation to continue without continuous visual supervision at a maximum of 10 m.p.h for up to 24 hours prior to another such visual inspection or replacement or repair of the rail.

B. Limit operating speed over defective rail to that as authorized by a person designated under § 213.7(a), who has at least 1 year of supervisory experience in railroad track maintenance. The operating speed cannot be over 30 m.p.h or the maximum allowable speed under § 213.9 for the class of track concerned, whichever is lower.

C. Apply joint bars bolted only through the outermost holes to defect within 10 days after it is determined to continue the track in use. In the case of Classes 3 through 5 track, limit the operating speed over defective rail to 30 m.p.h until joint bars are applied; thereafter, limit speed to 50 mph or the maximum allowable speed under § 213.9 for the class of track concerned, whichever is lower. When a search for internal rail defects is conducted under § 213.237, and defects are discovered in Classes 3 through 5 that require remedial action C, the operating speed shall be limited to 50 m.p.h, or the maximum allowable speed under § 213.9 for the class of track concerned, whichever is lower, for a period not to exceed 4 days. If the defective rail has not been removed from the track or a permanent repair made within 4 days of the discovery, limit operating speed over the defective rail to 30 m.p.h until joint bars are applied; thereafter, limit speed to 50 m.p.h or the maximum allowable speed under § 213.9 for the class of track concerned, whichever is lower. When joint bars have not been applied within 10 days, the speed must be limited to 10 m.p.h. until joint bars are applied.

D. Apply joint bars bolted only through the outermost holes to defect within 7 days after it is determined to continue the track in use. In the case of Classes 3 through 5 track, limit operating speed over the defective rail to 30 m.p.h or less as authorized by a person designated under § 213.7(a), who has at least 1 year of supervisory experience in railroad track maintenance, until joint bars are applied; thereafter, limit speed to 50 m.p.h or the maximum allowable speed under § 213.9 for the class of track concerned, whichever is lower. When joint bars have not been applied within 7 days, the speed must be limited to 10 m.p.h. until the joint bars are applied.

E. Apply joint bars to defect and bolt in accordance with §§ 213.121(d) and (e).

F. Inspect rail 90 days after it is determined to continue the track in use. If the rail remains in the track and is not replaced or repaired, the reinspection cycle starts over with each successive reinspection unless the reinspection reveals the rail defect to have increased in size and therefore become subject to a more restrictive remedial action. This process continues indefinitely until the rail is removed from the track or repaired. If not inspected within 90 days, limit speed to that for Class 2 track or the maximum allowable speed under § 213.9 for the class of track concerned, whichever is lower, until it is inspected.

G. Inspect rail 30 days after it is determined to continue the track in use. If the rail remains in the track and is not replaced or repaired, the reinspection cycle starts over with each successive reinspection unless the reinspection reveals the rail defect to have increased in size and therefore become subject to a more restrictive remedial action. This process continues indefinitely until the rail is removed from the track or repaired. If not inspected within 30 days, limit speed to that for Class 2 track or the maximum allowable speed under § 213.9 for the class of track concerned, whichever is lower, until it is inspected.

H. Limit operating speed over defective rail to 50 m.p.h or the maximum allowable speed under § 213.9 for the class of track concerned, whichever is lower.

I. Limit operating speed over defective rail to 30 m.p.h or the maximum allowable speed under § 213.9 for the class of track concerned, whichever is lower.

**Guidance:** In paragraph (a), FRA explains that only a person qualified under § 213.7, *Designation of qualified persons to supervise certain renewals and inspect track*, is able to determine that a track may continue to be used once a defective condition is identified in a rail. The option “or repaired” is added to paragraph (a)(1) to allow railroads to use recently developed processes to remove the defective portion of the rail section, used normally to remove transverse defects or defective welds, and replace that portion of the rail section by using recently developed weld technologies commonly referred to as “slot welds” or “wide gap welds.” These processes allow the remaining portion of non-defective rail to remain in the track.

FRA redesignated former paragraph (b) (as used in this section) as paragraph (d) and added a new paragraph (b). Paragraph (b) provides that track owners have up to a 4-hour period in which to verify that certain suspected defects exist in a rail section, once they learn that the rail indicates any of the defects identified in paragraph (c)’s remedial action table. This 4-hour, deferred verification period applies only to suspected defects that may require remedial action Notes “C” through “I,” found in the remedial action table. This 4-hour period does not apply to suspected defects that may require remedial action Notes “A,” “A2,” or “B,” which are more serious and must continue to be verified immediately.

The 4-hour timeframe provides flexibility to allow the rail flaw detector car to continue testing in a nonstop mode, without requiring verification of less serious, suspected defects that may require remedial action under Notes “C” through “I.” This flexibility also helps to avoid the need to operate the detector car in a non-test, “run light” mode over a possibly severe defective rail condition that could cause a derailment, when having to clear the track for traffic movement. However, any suspected defect encountered that may require remedial action Notes “A,” “A2,” or “B” requires immediate verification. Overall, the 4-hour, deferred-verification period is intended to help to improve rail flaw detector car usage, allow for operation of the chase car rail inspection method of operation, increase the opportunity to detect more serious defects, and ensure that the entire rail that a detector car is intended to travel over while in service is inspected. The option of “or repaired” is added to paragraph (b)(1) for clarification as stated in the paragraph (a) guidance.

FRA added a new paragraph (c) to contain both the remedial action table and its notes, as revised, which formerly were included under paragraph (a). In paragraph (d), three rail defect types are redefined (compound fissure, defective weld, and flattened rail), one is added (crushed head), and all rail flaw definitions are enumerated in alphabetical order.

The remedial actions required for defective rails specify definite time limits and speeds. The remedial actions also allow certain discretion to the track owner for the continued operation over certain defects. Inspectors should consider all rail defects dangerous and care should be taken to determine that proper remedial actions have been accomplished by the track owner or railroad. When more than one defect is present in a rail, the defect requiring the most restrictive remedial action must govern. (Note: In this technical bulletin, FRA’s use of “track owner” or “railroad” is intended to be interchangeable where the railroad is the track owner or otherwise assigned responsibility for compliance under § 213.5).

The remedial action table and specifications in the rule address the risks associated with rail failure. These risks are primarily dependent upon defect type and size and should not be dependent upon the



manner or mechanism that reveals the existence of the defect. Failure of the track owner to comply with the operational (speed) restrictions, maintenance procedures, and the prescribed inspection intervals specified in this section and § 213.237 (Defective rails, and Inspection of rail, respectively), may result in a violation of the Track Safety Standards (TSS).

Specifically, FRA revised the remedial action table as follows:

- Transverse defects. FRA placed the “transverse fissure” defect in the same category as detail fracture, engine burn fracture, and defective weld because they all normally fail in a transverse plane.
- Compound fissure remains with the same remedial action classifications. This type of defect has an increased potential to fail in an oblique plane and is considered a more serious defect.
- FRA changed the heading of the remedial action table for all transverse-type defects (i.e., compound fissures, transverse fissures, detail fractures, engine burn fractures, and defective welds) to refer to the “percentage of existing rail head cross-sectional area weakened by defect,” to indicate that all transverse defect sizes are related to the actual rail head cross-sectional area. Additionally “or repaired” is added to the heading in the table.
- FRA reduced the cross-sectional area of the rail head which requires remedial action Notes “A2” or “E and H” to 60 percent from the prior limit of 80 percent.
- FRA added a required remedial action and definition for a longitudinal defect that is associated with a defective weld—longitudinal.
- FRA added “crushed head” to the remedial action table and defect definition.
- Footnote 1 reminds inspectors that a chipped rail end is not a designated rail defect under this section and is not, in itself, an FRA-enforceable defective condition. Inspectors are reminded that a chipped rail end is not to be considered as a “break out in rail head.”
- Footnote 2 provides that remedial action Note “D” applies to a moon-shaped breakout, resulting from a derailment, with a length greater than 6 inches but not exceeding 12 inches and a width not exceeding one-third of the rail base width. FRA also recommends that track owners conduct a special visual inspection of the rail pursuant to § 213.239, before the operation of any train over the affected track. A special visual inspection pursuant to § 213.239, which requires that an inspection be made of the track involved in a derailment incident, should be done to assess the condition of the track associated with these broken base conditions before the operation of any train over the affected track.

Note “A” clarifies that a person qualified to supervise certain renewals and inspect track as designated in § 213.7 must visually supervise each operation over the defective rail.

Note “A2” addresses mid-range transverse defect sizes. This remedial action allows for train operations to continue at a maximum of 10 mph up to 24 hours, following a visual inspection by a person designated under § 213.7. If the rail is not repaired or replaced, another 24-hour cycle begins.

Note “B” limits speed to that as authorized by a person designated under § 213.7(a) who has at least 1-year of supervisory experience in track maintenance. The qualified person has the responsibility to evaluate the rail defect and authorize the maximum operating speed over the defective rail based on the size of the defect and the operating conditions; however, the maximum speed over the rail may not exceed 30 mph or the maximum speed under § 213.9 for the class of track concerned (whichever is lower).

Notes “C,” “D,” and “H” limit the operating speed, following the application of joint bars, to 50 mph or the maximum allowable speed under § 213.9 for the class of track concerned (whichever is lower). When the maximum speed specified in Notes “B,” “C,” “D,” and “H” exceeds the current track speed, the railroad is required to record the defect. For example, when a railroad determines that remedial action Note “B” is required and the track speed already is 30 mph or less, the railroad must record the defect. This indicates that the railroad is aware of the characteristics of the defective rail and has designated a permissible speed in compliance with the regulation.

Note “C” applies specifically to detail fractures, engine burn fractures, transverse fissures, and defective welds, and addresses defects that are discovered during an internal rail inspection required under § 213.237 and whose size is determined not to be in excess of 25 percent of the rail head cross-sectional area. For these specific defects, a track owner formerly had to apply joint bars bolted only through the outermost holes at the defect location within 20 days after it had determined to continue the track in use.

Note “C” is revised for these specific defects and now requires a track owner to apply joint bars bolted only through the outermost holes to the defect within 10 days after it is determined to continue the track in use. When joint bars have not been applied within 10 days, the track speed must be limited to 10 mph until joint bars are applied. This addition allows the railroads alternative relief from remedial action for these types of defects in Class 1 and 2 track.

Note “D” applies specifically to detail fractures, engine burn fractures, transverse fissures, and defective welds, and addresses defects that are discovered during an internal rail inspection required under § 213.237 and whose size is determined not to be in excess of 60 percent of the rail head cross-sectional area. Formerly, for these specific defects, a track owner had to apply joint bars bolted only through the outermost holes at the defect location within 10 days after it is determined that the track should continue in use.

Note “D” is revised for these specific defects and now requires a track owner to apply joint bars bolted only through the outermost holes to the defect within 7 days after it is determined to continue the track in use. The allowance of 7 days provides the track owner with additional time for remediation when the defect is identified just prior to the start of weekend shutdown. When joint bars have not been applied within 10 days, the track speed must be limited to 10 mph until joint bars

are applied. As mentioned in Note “C,” this addition also allows the railroads alternative relief from remedial action for these types of defects in Classes 1 and 2 track.

When an FRA inspector discovers a defective rail that requires the railroad representative to determine whether to continue the track in use and to designate the maximum speed over the rail, the inspector should inquire as to the representative’s knowledge of the defect and remedial action. If the railroad was not aware of the defect prior to the FRA inspection, the FRA inspector should observe the actions taken by the railroad representative to determine compliance. If the railroad had previously found the defective rail, the FRA inspector should confirm the proper remedial action was taken. During records inspections, the FRA inspector should confirm that the defects were recorded and proper remedial actions were taken.

The remedial action table for defects failing in the transverse plane (transverse and compound fissures, detail and engine burn fractures, and defective welds) specifies a lower limit range base of 5 percent of the railhead cross-sectional area. If a transverse condition is reported to be less than 5 percent, the track owner is not legally bound to provide corrective action under the TSS. Conditions reported to be less than 5 percent are not consistently found during rail breaking routines and, therefore, defect determination within this range is not always reliable.

Compound fissure conditions that weaken between 5 and 70 percent of the cross-sectional area of the rail head are defects requiring remedial action (Note B). Defects in the range between 70 and less than 100 percent of cross-sectional head area require remedial action (Note A2), as prescribed. Defects that affect 100 percent of the cross-sectional head area require remedial action (Note A) as prescribed, the most restrictive remedial action. Inspectors should be aware that compound fissures are defects that can fail in the transverse or oblique plane and are characteristic of rail that has not been control-cooled (normally rolled prior to 1936).

Defects identified and grouped as detail fractures, engine burn fractures, transverse fissures, and defective welds, will weaken and will normally fail in the transverse plane. Detail fractures are characteristic of control-cooled rail [usually indicated by the letters CC or CH on the rail brand (i.e., 1360 RE CC CF&I 1982 1111)]. Their prescribed remedial action relates to a low range between 5 and 25 percent and a mid-range between 25 and 60 percent, for Notes “C” and “D,” respectively. Those defects require joint bar applications and operational speed restrictions within certain time frames. Defects extending less than 100 and more than 60 percent require a visual inspection. If the rail is not replaced, effectively repaired, or removed from service, an elective would be to restrict operation to a maximum of 10 mph for up to 24 hours, then perform another visual inspection.

The second sentence in remedial action Note “C” addresses defects that are discovered in Classes 3 through 5 track during an internal rail inspection required under § 213.237, and which are determined not to be in excess of 25 percent of the rail head cross-sectional area. For these specific defects, a track owner may operate for a period not to exceed 4 days, at a speed limited to 50 mph or the maximum allowable speed under § 213.9 for the class of track concerned (whichever is lower). If the defective rail is not removed or a permanent repair is not made within 4 days of discovery, the speed is limited to 30 mph, until joint bars are applied or the rail is replaced.

The requirements specified in this second paragraph are intended to promote better usage of rail inspection equipment and therefore maximize the opportunity to discover rail defects which are approaching service failure size. The results of FRA's research indicate that defects of this type and size range have a predictable slow growth life. Research further indicates that even on today's most heavily used trackage in use today, defects of this type and size are unlikely to grow to service failure size in 4 days.

In the remedial action table, all longitudinal defects are combined within one group subject to identical remedial actions based on their reported size. These types of longitudinal defects all share similar growth rates and the same remedial actions are appropriate to each type.

Defective rails categorized as horizontal split head, vertical split head, split web, piped rail, and head-web separation, and defective weld (longitudinal) are longitudinal in nature. When any of this group of defects is more than 1 inch, but not more than 2 inches, the remedial action initiated, under Note "H," is to limit train speed to 50 mph, and Note "F" requires re-inspecting the rail in 90 days, if deciding operations will continue. If not inspected within 90 days, limit speed to that for Class 2 track or the maximum allowable speed under § 213.9 for the class of track concerned (whichever is lower), until it is inspected. Defects in the range of more than 2 inches, but not more than 4 inches, require complying with Notes "I" and "G"; speed is limited to 30 mph and the rail re-inspected in 30 days, if they decide operations will continue. If not inspected within 30 days, speed is limited to that for Class 2 track or the maximum allowable speed under § 213.9 for the class of track concerned (whichever is lower), until it is inspected. When any of the six defect types exceeds a length of 4 inches, a person designated under § 213.7(a) must limit the operating speed to 30 mph, under Note "B."

Another form of head-web separation, often referred to as a "fillet cracked rail," is the longitudinal growth of a crack in the fillet area, usually on the gage side of the outer rail of a curve. The crack may not extend the full width between the head and the web, but it is potentially dangerous. Evidence of fillet cracking is a hairline crack running beneath the head of rail with "bleeding" or rust discoloration. Fillet cracks often result from improper super-elevation or from stress reversal as a result of transposing rail. The use of a mirror is an effective aid in examining rail and the determination of head-web cracks or separation in the body of the rail.

A "bolt hole crack" is a progressive fracture originating at a bolt hole and extending away from the hole, usually at an angle. It develops from high stress risers, usually initiating as a result of both dynamic and thermal responses of the joint bolt and points along the edge of the hole, under load. A major cause of this high stress is improper field drilling of the hole. Excessive longitudinal rail movement can also cause high stress along the edge of the hole. When evaluating a rail end, which has multiple bolt hole cracks, inspectors will determine the required remedial action based on the length of the longest individual bolt hole crack.

Under Notes "H" and "F," the remedial action for a bolt hole crack that is more than one-half of an inch but not more than 1 inch, if the rail is not replaced, is to limit speed to 50 mph, or the maximum allowable under § 213.9 for the class of track concerned (whichever is lower), then re-inspect the rail in 90 days, if operations will continue.

For bolt hole cracks greater than 1 inch, but not exceeding one and one-half inches, Notes “H” and “G” apply. These rails are required to be limited to 50 mph and re-inspected within 30 days. For a bolt hole crack exceeding one and one-half inches, a person qualified under § 213.7(a) may elect to designate a speed restriction, which cannot exceed 30 mph, or the maximum allowable under § 213.9 for the class of track concerned (whichever is lower).

Under Notes “F” and “G,” where corrective action requires rail to be re-inspected within a specific number of days after discovery, several options for compliance may be exercised depending on the nature of the defect. For those defects that are strictly internal and are not yet visible to the naked eye, the only option would be to perform another inspection with rail flaw detection equipment, either rail-mounted or hand-held. For defects that are visible to the naked eye and therefore measurable, a visual inspection or an inspection with rail flaw detection equipment are acceptable options. For certain defects enclosed within the joint bar area, such as bolt hole cracks and head-web separations, the joint bars must be removed if a visual re-inspection is to be made.

The re-inspection prescribed in Notes “F” and “G” must be performed prior to the expiration of the 30- or 90-day interval. If the rail remains in the track and is not replaced or repaired, the re-inspection cycle starts over with each successive re-inspection unless the re-inspection reveals that the rail defect increased in size, and has become subject to a more restrictive remedial action as a consequence. This process continues indefinitely until the rail is removed from track or repaired.

Where corrective action requires rail to be re-inspected within a specific number of days after discovery, the track owner may exercise several options for compliance. One option would be to perform another inspection with rail flaw detection equipment, either rail-mounted or hand-held.

Another option would be to perform a visual inspection where the defect is visible and measurable. In the latter case, for certain defects enclosed within the joint bar area such as bolt hole breaks, removal of the joint bars will be necessary to comply with the re-inspection requirement. If not inspected within 30- or 90-day timelines, limit speed to that for Class 2 track or the maximum allowable speed under § 213.9 for the class of track concerned (whichever is lower), until it is inspected. This change defines the re-inspection cycle and requires the track owner to continue the re-inspection or apply a reduction in speed.

If defects remain in track beyond the re-inspection interval, the railroad must continue to monitor the defects and take the appropriate actions as required in the remedial action table.

A broken base can result from improper bearing of the base on a track spike or tie plate shoulder, and from over-crimped anchors, or it may originate in a manufacturing flaw. With today’s higher axle loads, inspectors can anticipate broken base defects in 75-pound, and smaller, rail sections with an irregular track surface, especially on the field side. For any broken base discovered that is more than 1 inch, but less than 6 inches in length, the remedial action (Note D) is to apply joint bars bolted through the outermost holes to the defect within 10 days, if operations will continue. In Classes 3 through 5 track, the operating speed must be reduced to 30 mph or less, as authorized by a person under § 213.7(a), until joint bars are applied. After that, operating speed is limited to 50 mph or the maximum allowable under § 213.9 for the class of track concerned (whichever is lower).

Under Note “D,” there are several acceptable “outermost hole” bolting arrangements for joint bars centered on a rail defect. See Figure 1, for an illustration of acceptable bolting arrangements. In all cases, railroads may not drill a bolt hole next to a defect that is being remediated with the application of joints bars (pursuant to Note D). The reason for not drilling next to the defect is to prevent the propagation of the crack into the hole closest to the defect.

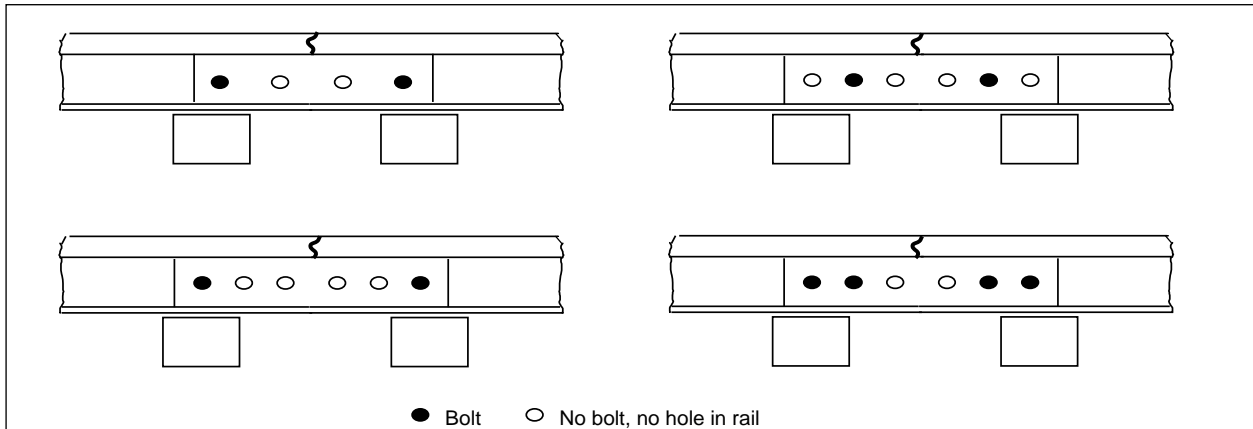

Figure 47: Illustration of Acceptable Bolting Arrangements

A broken base in excess of 6 inches requires the assignment of a person designated under § 213.7 to visually supervise each train operation over the defective rail. The railroad may apply joint bars to the defect and bolt them in accordance with §§ 213.121(d) and (e), and thereafter must limit train operations to 30 mph or the maximum allowable under § 213.9 for the class of track concerned (whichever is lower). As reference, the dimensions between the outermost holes of a 24-inch joint bar vary between approximately 15 and 18 inches, and for a 36-inch joint bar approach 30 inches.

Inspectors should point out to the track owner that broken bases nearing these dimensions may negate the purpose for which the joint bars are applied. A broken base rail may be caused by damage from external sources, such as rail anchors being driven through the base by a derailed wheel. It is improper to consider them “damaged rail,” as this defect is addressed by more stringent provisions applicable to broken base rails, under Note “A” or “E” and “I.”

Damaged rail can result from flat or broken wheels, incidental hammer blows, or derailed or dragging equipment. Reducing the operational speed in Classes 3 through 5 track to 30 mph until joint bars are applied, lessens the impact force imparted to the weakened area. Applying joint bars under Note “D” ensures a proper horizontal and vertical rail end alinement in the event the rail fails.

Flattened rails and crushed rails (localized collapsed head rail) are also caused by mechanical interaction from repetitive wheel loadings. FRA and industry research indicate that these occurrences are more accurately categorized as rail surface conditions, not rail defects, as they do not, in themselves, cause service failure of the rail. Although it is not a condition shown to affect the structural integrity of the rail section, it can result in less than desirable dynamic vehicle responses in the higher speed ranges. The flattened rail condition is identified in the table, as well as in the definition portion of § 213.113(b), as being three-eighths of an inch or more in depth

below the rest of the rail head and 8 inches or more in length. As the defect becomes more severe by a reduced rail head depth, wheel forces increase.

The rule addresses flattened rail in terms of a specified remedial action for those of a certain depth and length. Those locations meeting the depth and length criteria must be limited to an operating speed of 50 mph or the maximum allowable under § 213.9 for the class of track concerned (whichever is lower).

“Break out in rail head” is defined as a piece that has physically separated from the parent rail. Rail defects meeting this definition are required to have each operation over the defective rail visually supervised by a person designated under § 213.7. Inspectors need to be aware that this definition has applicability across a wide range of rail defects, as indicated in the Remedial Action Table. Where rail defects have not progressed to the point where they meet the definition of a break out, but due to the type, length, and location of the defect, they present a hazard to continued train operation, inspectors should determine what remedial actions, if any, the track owner should institute.

The following are two rail head break out examples where the Note “A” corrective action would be necessary:

- Example One: A bolt hole break where the head of the rail is totally separated from the parent rail (either tight or loose), but that piece of rail will not physically lift out of the joint bars by hand. The inspector might determine that the separation was total because the separated piece rattled when tapped. It is important that railroads take the appropriate remedial action in this situation, because it is potentially very unsafe. It is impossible to know what will happen when the next train operates over this defect. That train could cause the piece to become so loose that it comes out of the place, cocks at an angle and causes a wheel to ramp up, derailling the train.
- Example Two: A vertical split head defective rail where rail head separation is apparent because the inspector can determine that a physical separation has occurred through the rail head, but the rail head has not entirely separated over the entire length of the defect.

The following is an example where the Note “A” corrective action would not be necessary:

- Example: At rail joints, a chipped rail end, which is not considered a rail defect according to the current § 213.113 table, and should not be considered as a break out in the rail head.

The issue of “excessive rail wear” continues to be evaluated by the Rail Integrity Task Force. FRA believes that insufficient data exists at this time to indicate that parameters for this condition should be proposed as a minimum standard.

Some railroads apply safety “weld straps” to thermite-type field welds. These straps do not provide the same support of a joint bar. They would provide only limited support if a weld were to break under a train movement and as such, they do not comply with the provisions of corrective actions C, D, or E (installation of joint bars). Only a joint bar having full contact with the bottom of the rail

head and rail base [*see* § 213.121 (a)] and with a manufactured relief for the weld material would comply with corrective actions C, D, or E.

When an FRA inspector finds a rail defect that appears to originate from fatigue at a bond wire attachment weld, the inspector should cite the railroad using part 213 defect code 0113B. Inspectors must also identify in their narrative the type of the rail defect (e.g., defective weld, detail fracture, etc.). FRA added this defect code based on a National Transportation Safety Board (NTSB) recommendation arising from the NTSB investigation of a February 9, 2003, Canadian National Railway (CN) derailment in Tamaroa, IL. The NTSB determined that the probable cause of this accident was CN's placement of bond wire welds on the head of the rail just outside the joint bars, where untempered martensite associated with the welds led to fatigue cracking that, because of increased stresses associated with known soft ballast conditions, rapidly progressed to rail failure.

FRA provides the "Track Inspector Rail Defect Reference Manual" on the e-library in its Web site. Inspectors are expected to be conversant with rail defect types, appearance, growth, hazards, and methods of detection.



# Section 7: Flaw Detection

## Introduction to Flaw Detection

The single most important asset to the heavy haul industry is its rail. However, the primary concern of the railroad companies is the probability of rail flaw development, and broken rails, resulting from the repeated applications of high-contact stress from the heavy axle loads that are encountered today. This has resulted in the railroad companies improving their maintenance practices and increasing their test methods and frequencies.

One of the most important practices for the reduction of broken rail is the nondestructive inspection process. This includes several technologies and methods that are in use in the heavy haul industry today with the objective of obtaining full life potential of the rail section. These technologies and methods must be capable of performing an accurate, reliable, and effective test in an ever-changing environment while at an acceptable speed that will not interfere with the service functionality of the railroad.

## Detection Methods

Current detection methods are performed using various types of test equipment and processes with some human involvement in the interpretation of the test data. Listed below are four of these processes:

**Portable Test Process** – The portable test process consists of an operator pushing a test device over the rail at a walking pace, while visually interpreting the test data on a flaw detector. When a suspect defect is identified, the operator will stop and manually verify the defect type and location. The defect is then logged and reported to the railroad for remedial action. Presently, no permanent record of the test is stored for future analysis.

**Start/Stop Test Process** – The start/stop process is a vehicle-based test at a slow speed, usually not in excess of 35–40 km/h. The vehicle travels along gathering data that is presented to the operator in real time for interpretation. Once a suspect equipment response is identified by the test operator, the vehicle is stopped and proceeds back to the suspect location. The location is verified by the operator and, if determined defective, classified and reported for immediate remedial action. This process produces a permanent record of test for future analysis.

**Chase Car Test Process** – The chase car process is a variation of the start/stop process. This process consists of a lead test vehicle performing the flaw detection process in advance of a chase car. Once the lead test vehicle encounters an equipment response that represents a suspect defective condition, a copy of the test data is electronically transmitted back to the chase car for verification. The location is verified by the chase car operator, allowing the lead detector car to continue with the test. The purpose of this process is to increase production while maintaining the ability to report a defective condition for remedial action to the railway. A permanent record of the test is produced by the detector and chase car for future analysis.

**Continuous Test Process** – The continuous test process consists of operating a high-speed vehicle-based test system nonstop along a designated route, sometimes covering in excess of 150–300 km per shift. The test data is then analyzed according to defined standards at a centralized location. Once analyzed, reports are sent out to a verification staff via the Internet. They verify “suspects” to confirm as “defects” using a portable test unit or a portable hand-held flaw detector. Verification reports are transmitted back to the railroad over the Internet for records and proper remedial action. This process also produces a permanent record of test for future analysis.

## **Current Technologies**

The primary technologies used for nondestructive testing on heavy haul lines are ultrasonic and induction test processes. The ultrasound technology is the most frequently used, and the induction is currently used as a complimentary system to ultrasound only. They are described as follows:

### **Induction**

The basis for induction testing requires the introduction of a high-level direct current into the rail head, establishing a magnetic field around the rail head. In the induction test process, the magnetic field is considered a region consisting of concentric lines of force perpendicular to the rail head. Once the magnetic field is established, it will remain constant in strength and shape as long as the rail weight, rail head contour, and current flow remain constant.

The current is generally around 1200A to 3600A; however, it can vary by rail weight and test speed. The introduction of the current is applied by using two sets of electrodes that are placed on the rail head. The spacing between the electrode sets is approximately 120 cm and the current flows into the rail from the forward electrode set and out through the trailing electrode set. During this process, the rail head becomes an electrical circuit that flows longitudinally through the rail head.

The induction sensor unit is then passed through the magnetic field. The unit containing the induction sensors is located between the two sets of brushes at a pre-set distance above the surface of the rail head. This clearance must be maintained throughout the continuity of the test to ensure test integrity.

When motion is introduced, the sensor unit moves through the magnetic field and it detects a distortion in the concentric lines of force in the established magnetic field where an electromotive force is induced. This electromotive force is measurable as a voltage. If the sensor unit is passed through the magnetic field and there is no distortion, then no electromotive force is measured.

In modern rail weights, only the head and the top part of the web are “saturated” with current. As the current flows through the rail, any condition, such as a defect, will distort the current path. The distortion of the current flow will also lead to a distortion of the associated magnetic field. It is this distortion of the magnetic field that is detected by the search unit.

The search unit houses multiple sensors aligned in various planes in relation to the rail head. Multiple sensors, arranged in various planes in relation to the rail head, are used to allow the detection of all the components of the magnetic field disturbances. The signals received by the sensor unit are sent to the test system and evaluated to determine if they meet or exceed a set

threshold. If the signals exceed the predetermined threshold level, the data is presented to the operator for interpretation as a potential defect.

The processed data is then kept as the permanent record of test. It is very important that the system is able to saturate the rail head with electrical current, or the quality of the test can be jeopardized.

## Ultrasonics

Ultrasonics are briefly described as sound waves, or vibrations, that are propagating at a frequency that is above the range of human hearing, normally above a range of 20,000 Hz or cycles per second. The range normally used during current flaw detection operations is 2.25 MHz (million cycles per second) to 5.0 MHz.

The ultrasonic test method of rail testing is described briefly as follows:

1. Ultrasound is generated onto the rail at various angles by piezoelectric transducers that are manufactured from ceramic materials. The transducers are contained in a wheel assembly, or sled device, which rides on top of the rail head. The ultrasound is produced by applying a voltage to the transducer itself.
2. The wheel/sled containing the transducers is commonly referred to as the search unit.
3. The transducers are positioned at several different angles. The ultrasound produced by these transducers normally covers the rail from the top of the rail head through the web to bottom of rail and the entire width of the rail head. The base portion off center of the rail is currently not covered by current test systems.
4. Ultrasound is generated into the rail at all angles associated with the system at test speeds up to 100 km/h.
5. If a condition is encountered of sufficient size and orientation that would offer a reflector to the ultrasound that is transferred into the rail, the ultrasound is then reflected back to the respective transducer. These conditions would include rail head surface conditions, internal or visible rail flaws, weld upset/finish, or known reflectors within the rail geometry such as drillings or rail ends.
6. The information reflected back to the transducer is then processed by the test system and is recorded in the permanent test data on the coinciding display for that ultrasonic channel.

In effect, the ultrasound produced from the transducer travels through the rail specimen from the top of rail head. If the sound path is uninterrupted, no reflected signal is returned to the transducer. If a condition exists, such as a rail head surface irregularity, rail geometry reflector (bolt hole drilling, weld upset/finish, rail end, etc.), or internal rail flaw, the ultrasound produced will reflect back to the transducer and an equipment response is presented to the operator for interpretation. The information processed by the test system is maintained on a permanent record of test. Test systems that are used by heavy haul lines normally use a minimum of 24 ultrasonic test channels, 12 on each rail. However, recently systems that can accommodate more than 24 channels and additional wheel/sled angled test probes have been developed.

## **Flaw Detection Limitations**

Ultrasonic testing has been the primary nondestructive test (NDT) method used for internal rail flaw inspection. As with any NDT method, ultrasonic technology contains physical limitations that allow certain types of rail head surface conditions to be instrumental in influencing the detection of rail flaws. The predominant types of these mechanically formed conditions are referred to as shells, engine driver burns, spalling, flaking, corrugation, and head checking. Other conditions that are encountered are heavy lubrication or debris on the rail head.

# Section 8: Rolling Contact Fatigue

Rolling contact fatigue (RCF) conditions develop in rails at the wheel/rail interface in most railroad systems. Any type of surface condition can be an influential obstacle in the detection of an underlying rail defect. If any doubt or uncertainty in the integrity of the test process is identified by the detector car operator concerning surface conditions, they have the option to record the rail section as an invalid test and report the location to the railroad. Detailed below are some of the more critical types of surface conditions we encounter.

## Shells

Shells are identified as progressive horizontal separations, generally on the gauge side of the rail head, which may crack out at any level, usually at the upper gauge corner. Shelling may turn down to form a transverse separation and, once detected, is classified as a detail fracture. Uncapped or gutted shells will result in the dislodgement of parent metal from the rail section.



Figure 48: Gauge Side Shell Showing Severe Parent Metal Decay

## Flaking

Flaking originates at the surface of the rail and is commonly found near the stock rail area of a switch where concentrated loading cold works the steel. Flaking can be identified on the rail head surface as a horizontal separation with scaling or chipping of small segments of parent metal.



Figure 49: Centralized Flaking Condition Showing Chipping of Parent Metal

## **Burned Rail**

Burned rail is a rail head condition that is the result of friction from slipping locomotive drivers. The damaged area can gradually chip out and roughen under repeated traffic. Potential transverse defects can develop from thermal cracks associated with the burned area. Once the surface condition reaches a critical stage of displacement of the rail head surface material, the detection of an underlying rail flaw is obstructed.



Figure 50 Thermal Cracks on Burned Stock Rail

## **Head Checking**

Head checking is identified as a slight separation of metal on the gauge side of the rail head, normally found in the high side of curves. It is also common in switch areas, due to the lateral force induced on the rail head from wheel displacement through turnouts. Head checking can turn down and develop into a transverse separation.



Figure 51: Gauge Side Head Checking and Flaking

## Spalling

Spalling is generally referred to as the displacement of parent metal from the rail head from high contact stresses associated with cyclical loading. This may also be referred to as a slight flaking in the minimal stage of severity. Further deterioration of the rail head can increase the amount of metal displacement, resulting in a significant spalling condition.



Figure 52: Flattened Rail Head Showing Displacement of Parent Metal (Spalling)

**Note:** It is the responsibility of the rail flaw detector car operator to properly identify the types of rail head surface conditions that can result in an improper or invalid test of the rail section in which the condition is contained. Extra care should be taken within interlocking areas. The operator should also be aware of other conditions that can result in an invalid test.

## **Effects of Rail Wear**

Severe head wear distortion can alter the normal angle refraction of the ultrasonic beam from the transducer to such a critical level that the ultrasonic signals do not penetrate at the expected angle, or to the expected location, in the specimen. Therefore, it is possible that reflected sound beams normally associated with internal rail flaws may not be identified by the test system from the defective portion of the rail section. In effect, if the severity of the head wear characteristics is significant, it can impact the integrity of the test.

## **Rail Flaw Development and Failure**

Nondestructive test systems are designed to perform optimally on a perfect test specimen. Unfortunately, much of the rail in the heavy haul industry is affected by the loading stresses that result in much of the plastic deformation characteristics of the rail specimen that were previously described. These conditions impact the development of rail flaws. The conditions can also impact the technologies currently used for flaw detection, and limit their detection capabilities. Therefore, it is important that emerging technology developments continue in an effort to alleviate the impact of adverse test specimen conditions.

Normal railway maintenance such as rail lubrication, rail profile maintenance, and track maintenance programs, all greatly increase the life cycle of rail. These practices also are deterrents to the crack growth life of internal rail flaws. Without aggressive track maintenance programs, rail flaw development and failure will continue to be an issue, and result in service disruption to the heavy haul railways.



# Section 9: Rail Welding

Continuous welded rail provides many benefits to the railway industry including elimination of joints, increased rail life, reduced track deterioration, and reduced maintenance costs. Many of the rail lines in the United States now have welded rail to some extent and more continuous welded rail is being installed on an annual basis.

Rail welding can be done at a stationary, specialized welding plant or at the on-track site by portable welding techniques. In the United States, the majority of rail welding consists of aluminothermic or thermite welding, flash butt welding, and gas pressure welding. The flash butt weld will produce a narrower heat affect zone than the thermite weld and has a more consistent hardness through the finished weld, which will normally result in less weld failures.

## Electric Flash Butt Welds

Flash butt welding of rails has been the most popular method of welding of rails in the world for some time. The process has proven to make strong, reliable welds. The flash butt welding process is typically performed in a stationary welding plant. However, the recent development of mobile flash butt welding processes has resulted in a portable in-track alternative.

The flash butt rail welding process is a method of forging two separate rails together by generating electrical heat until sufficient flashing of the parent metal takes place. Once the temperature rises to fusion level, the rail ends are pressed together with an application of force that ultimately leads to the welding of the rail ends.

## Basic Components of Electric Flash Butt Welding

There are three basic components required to complete the flash butt weld process:

- 1) Clamping mechanism sufficient to tightly hold the rails being welded in position.
- 2) The forging mechanism with dual functions:
  - a) Brings the rails into contact under minimal force during the heating stage
  - b) Applies high forces to the rails upon completion of the weld cycle to extract all impurities and finalize the fusion of the weld.
- 3) A transformer that will reduce the main supply voltage to a suitable welding voltage that makes available sufficient current to heat the rails being welded. The welding current required can vary depending on rail size and cross-sectional area being welded.

It is critical that the rail ends are of similar dimension within specified tolerances and that they are thoroughly cleaned prior to welding. A rail end that has not been properly cleaned may result in an oxide inclusion and the dimension should be within similar tolerance to avoid lack of fusion.

Flash butt welding of rails is considered superior to thermite welding because it is a forging process. The strength of the joint is almost as much as the strength of the parent metal; whereas, thermite welding is a casting process and may be more susceptible to imperfections like porosity, inclusions, and lack of fusion.



Figure 53: Newly Completed Electric Flash Butt Weld



Figure 54: Electric Flash Butt Weld in Track



Figure 55: New in Track Electric Flash Butt Weld

To ensure a proper electric flash butt weld is problem free extra care must be taken to follow the correct welding procedures. Proper rail end alignment is necessary prior to beginning the weld process. The weld must then be sheared and ground properly. Transverse defect development in the electric flash butt weld will normally originate from oxidation and contain an inclusion. The weld may also fail as a result of lack of fusion or stress riser.

## Gas Pressure Welds

The gas pressure welding of rail is an alternative process that is similar to the flash butt welding process because it also consists of fusing the rail ends together with no external metal fill required to fill in between the rail ends. This rail welding process has been extensively used in many countries because of reliability and simplicity of the welding process.

Gas pressure welding is a solid phase welding technique that uses the mixture of oxygen and acetylene gases for heating the rail ends to reach a temperature of approximately 2400 °F and then applying high pressure to bond the rail ends. This process is normally done in a welding plant but also has mobile in-track capabilities.

This process requires the ends of the rail to be butted against each other and applying pressure. Once the rail ends are butted together, they are heated by the evenly distributed oxy-acetylene burners until they are fused solidly. Upon completion of the weld, a trimmer device is used to remove the excessive weld material from the rail/weld section until a uniform dimension is achieved. With the proper post-weld heat treatment, the hardness of the weld is comparable to the parent rail steel.



Figure 56: Gas Pressure Weld in Track

To ensure a good gas pressure weld adherence to the welding procedures, proper rail-end alignment, proper shearing, and grinding are necessary to make a gas pressure weld. Gas pressure welds can originate from an inclusion, lack of fusion, or stress riser.

## Aluminothermic Welding (Thermite)

The aluminothermic welding process produces fusing as a result of an exothermic reaction between iron oxide and aluminum, which produces high heat generation. Since the reaction is exothermic, it is capable of producing heat that is sufficient to result in a molten state of metal that can be cast to bond rail ends together. The reaction can be altered or controlled, dependent on the chemical reaction of the iron oxide and aluminum proportions.

The exothermic reaction between the iron oxide and aluminum is done in a conical metal container lined with magnesite that is referred to as a “crucible.” After the exothermic reaction occurs for a few seconds, approximately equal portions of molten steel and liquid aluminum oxide are separated. The aluminum oxide is lighter and will float on top of the molten steel. After the aluminum oxide has floated to the top of the crucible, the molten steel is released from the bottom of the crucible. The rail ends are preheated to the proper temperature before the release of the molten steel. The molten steel pours down into a hardened sand mold that has been packed with luting sand and special paste around the two rail ends to be joined. During this process, the rail ends are partially melted by the extreme heat as the mold fills. When the pour is complete, the weld is allowed to cool and solidify. Once the molten steel solidifies the mold is removed and the weld is cleaned and finished to produce the joint. The two predominant aluminothermic weld processes used by the railroads are referred to as the thermite process and the boutet process.

The steps used in the aluminothermic weld process consist of:

- Preparing rail ends for welding
- Rail end separation
- Setting the weld gap and alignment
- Rail clamp application
- Applying the mold assembly
- Placing weld material into the crucible
- Preheating the rail ends
- Igniting the weld material
- Removing mold assembly
- Shearing excess head weld material
- Rough grinding the excess material
- Final grinding of the weld material



Figure 57: Thermite Weld in Track



Figure 58: Boutet Weld in Track

Aluminothermic welds develop defects that may originate in the rail head, web, or base. The defective condition may be a result of incomplete penetration of weld material, lack of fusion with the rail end, slag entrapment, shrinkage, or a fatigue discontinuity. Many defects in the aluminothermic weld will normally originate from improper rail end alignment, improper preheat conditions, inadequate weld charge material, or the introduction of moisture or impurities during the weld charging process.

# Section 10: Rail Grinding

Rail grinding is a vital maintenance practice that when applied consistently can ensure a prolonged rail life. Rail grinding is necessary to achieve the most optimal wheel/rail contact patch and prevent excessive rail wear. It is of utmost importance for railroads to control the normal process of wear and fatigue of the rail head and extend the life of their rail. This is achievable with proper track maintenance and a sustainable rail management program.

One key factor in a rail management program is a sufficient rail grinding program. As rail accumulates tonnage, the wheel/rail contact patch will vary and could promote undesirable plastic flow and rolling contact fatigue (head-checking, spalling, shelling, flaking). The geometrical alteration of the rail head affects the load stresses that can initiate rail defect development or rail failure.

## Benefits of Rail Grinding

Rail grinding is a well-established process for the reduction and control of rolling contact fatigue development. The primary benefits of rail grinding could be categorized by these four areas:

1. Remove existing rolling contact fatigue to prevent development to a more severe condition that can result in additional damage or weakening of the rail section.
2. Reprofile the rail head to the desired transverse shape and improve performance at the wheel/rail contact patch.
3. Correct surface defects such as engine driver burns, dipped welds, etc.
4. Improve rail inspection system capabilities.

The key to obtain the benefits of rail grinding is to have a regular grinding plan and use the proper type of equipment and grinding strategy.



Figure 59: Freshly Ground Rail

# Common Rail Grinding Strategies

## Preventive Grinding

The preventive grinding strategy is considered by many railroads to be the most beneficial strategy to use for the control of rolling contact fatigue development in a rail management plan. Preventive grinding is a method that results in the removal of minimal rail steel with more frequent grind cycles. The objective of a preventive grinding strategy is to grind at higher speeds to obtain a properly profiled rail surface. The preventive grinding strategy can be initiated at the installation of new rail, or it can be achieved through the use of other grinding strategies to shape the rail to a desired profile, and then initiate the preventive strategy. In this strategy, sharp curves are ground more frequently than slight curves and tangent track is ground less frequently.

## Preventive Gradual Grinding

The preventive gradual grinding process is performed at a slower rate of speed, increasing the grinding motor power, optimizing the grinding patterns, decreasing the grind interval, and increasing the amount of rail steel removal. This strategy is often used on rail that has not previously used a preventive grinding strategy to improve the rail condition, and then the preventive grinding strategy is initiated.

## Maintenance Grinding

The maintenance grinding strategy uses much longer intervals between grinding cycles, with more rail steel removed by performing multiple slower grind passes. It is usually used on curves and it can prevent heavy rolling contact fatigue development and damage. However, it can adversely shorten rail life.

## Corrective Grinding

The corrective grinding strategy is mostly used when rail has reached a severe or advanced rate of rolling contact fatigue development. The grinding frequencies are not normally driven by accumulated tonnage. Instead, it is normally driven by other factors like significant shelling development, corrugation, or the presence of other severe surface anomalies. Corrective grinding will result in removing larger quantities of rail steel by multiple low-speed grind passes.

## Optimum Rail Grinding Strategy

The purpose to grind rail is to achieve the longest life of the rail through preventive rail maintenance. This practice is designed to result in rail removal once the parent rail head loss has reached its maximum effective use and not because of fatigue.

The best rail grinding strategy will normally consist of:

1. Target rail profiles for the area that promote low wear rates, low contact patch stress, and proper vehicle stability.

2. Surface quality results that meet a standard in roughness and facet width that is suitable for the area.
3. Cycles that are adequate to maintain balance of wear and fatigue.
4. Low costs per mile.

Use of a strategy that meets or exceeds these results will achieve longer rail life. Preventive rail grinding strategy, along with a properly developed rail lubrication and friction management program, are essential in a successful rail management program.



Figure 60: Rail Grinder at Work

### **Work-Hardened Region**

A work-hardened region in rail will develop under load with the passage of tonnage over the rail. This region is important protection to reduce rail wear and prevent the development of rolling contact fatigue. In modern rail with improved hardness this region will normally develop to a depth of 0.25 inches below the rail head surface. In older rail with lower hardness, the region could develop to a depth as much as 0.50 inches below the rail head surface.

Preventive grinding removes a minimal amount of rail steel during the grind process; whereas, corrective grinding removes a more substantial amount of rail steel. When considering a grinding strategy, it is important to prevent complete removal of this beneficial work-hardened area and protect the rail steel from wear.

### **Rail Profiles**

Rail profile maintenance is necessary on U.S. railways to help prolong the life of rail and reduce unnecessary capital investment. Rail grinding is used to achieve optimal rail/wheel contact



conditions. Rail grinding to optimal rail profile and managed tolerances by preventive grinding assists in the reduction of excessive wheel/rail contact stresses and rail wear.

### **Optimal Rail Profiles**

Rail must endure a varied array of wheel profiles while in service. The various shapes of the wheels can range from new, wide flange, thin flange, hollow, to severely worn.

Software is available that can design the optimal rail profile in tangent or curved track to minimize the effects of the rail contact stress that these various wheel shapes have on the rail. An optimal rail profile can improve the railcar's ride stability and steering ability through curves.



Figure 61: Worn Low Rail Profile

### **Tangent Track Profiles**

Tangent track profiles are ground to produce a central rail running band or a running band favoring either gage or field side of the rail head. These rail profiles are designed to reduce the hollowing effects of rail on the wheels.

Tangent track profiles are also designed to increase the rail life in curves and tangent track, lower the grinding power required, lower the lateral forces at wheel/rail interface, improve wheel life, and lessen the amount of fuel consumed.

## **High Rail Profiles**

Rail profiles have been improved for high sides of curves that more efficiently distribute contact stress on mild, intermediate, and sharp curves. It is essential that the high rail of the curve avoid localized stress and fatigue development while ensuring the vehicle curving performance is optimal. These profiles are designed to minimize rail wear, development of rolling contact fatigue, and reduce fuel costs.

## **Low Rail Profiles**

Optimal low rail profiles are designed to eliminate concentrations of stress and fatigue caused by hollow wheels and wide gage on heavy haul railroads. These designs are also beneficial for improving curve steering to maximize the vehicle curving performance. Many low rail profiles are also designed to reduce metal removal per grinding cycle while still controlling loading contact stresses.

## **Grinding Equipment**

Rail grinding machines come in various size and capabilities, dependent on productivity requirement. The machines have grinding “stones” that rotate perpendicular to the rail to remove metal from the surface in longitudinal facets or ridges. The width of the facets will determine the rail profile and surface finish appearance based on the amount of metal removal. A large number of facets with fewer transition lines between the facets will improve rail profile and increase the amount of metal that will be removed from the rail head. The amount of facets will be increased by making numerous grind passes with a small-sized grinder or by increasing the number stones used in grinding. In order to reduce track occupancy time it is normal to use more grinding stones and have the ability to remove metal and shape the rail head with one pass.

Smaller sized grinding machines normally use 8 to 24 grinding stones, while the larger production-type grinding machines may have 48 to 96 grinding stones. The larger production-type grinding machines are capable of achieving the target rail profile with one grinding pass.

The design of the grinding stones is determined by the metal removal required and surface finish expectations. Both of these expectations can influence the useful life of the stone. The stones are made of an abrasive grit material and a type of resin bond. The grit size and bond are important components in the stones performance.

Larger grit size will remove more metal material from the rail surface and leave a rougher finish. The grade and type of the grit used in the stones have distinct fracture characteristics or degrees of degradation, and the type and quality of the resin will influence the ability of the resin to bond the grit. This is always influential in the metal removal capabilities of the stone.

The region of metal removed by the stone is dependent on the amount of force that is applied between the stone and rail head. The power required to spin the stone at constant speed as force is increased is a key factor. Minimum force and power levels are required to enable the stone to

penetrate the steel and remove the metal. Production is increased with greater pressure and power applied to the stones.

The region of metal removed is also affected by machine speed. An increase in speed will result in the amount of metal removal to decrease. However, higher power level and stone pressure can result in a higher-speed grinding capability.

Rail head surface finish is determined by the depth of the facets or ridges resulting from the grit scratches. High power, slow speed, and coarse stone grits will result in fewer facets and a rougher surface finish.

# Section 11: Definitions and Terminology

## Definition of Rail Terms

**Base** – the part of a rail lying below the web area, also referred to as the foot or flange.

**Bleeding** – a reddish-brown streak indicating internal rusting. Noticeable in some rails containing vertical split head defects, generally under the ball of the rail.

**Bonds** – short wires used to bridge gaps in electrical circuits, usually at track circuit joints or between rails.

**Break** – a complete separation of one or more pieces of rail.

**Broken Rail** – a term commonly used to describe any rail that has been completely broken through the entire rail section.

**Cant** – the angle of an individual rail relative to vertical. Rail is canted by the inclination of the tie plate in order to match the conical wheel profile. Cant is usually expressed as a rate of inclination, such as 1 in 40, etc.

**Cold work** – plastic deformation of the rail material at low temperatures.

**Continuous welded rail (CWR)** – rail sections that are welded end to end into rail strings that result in a rail without rail joints; also referred to as welded rail or ribbon rail.

**Corrugation** – a series of wave-like variations of the rail head running surface, identified by an uneven head wear pattern. Short wave corrugation has a wavelength of 1–3 inches, intermediate wave corrugation has a wavelength of 3–24 inches, and long wave corrugation exceeds 24 inches in length. Short wave is more common on transit lines and high-speed lines, while all may be present within a heavy haul system.

**Crack** – a separation of metal extending partially, but not completely, through the rail section.

**Defect** – a term generally used to refer to an identifiable imperfection internal to the rail section or rail section geometrical surface.

**Detected defect** – a defective rail detected by a rail flaw detection (RFD) vehicle or visual means by the operator of a RFD vehicle.

**Fatigue** – irreversible damage to a material caused by cyclic loading—normally leading to the formation of a crack.

**Field side** – the side of rail head away from wheel flange.

**Flaking** – usually refers to small pieces of parent rail material becoming detached from the rail running surface—a type of minute spalling sometimes associated with a faulty manufacturing process.

**Flaw** – a general term often associated with cracks originating from rail defects, but not always (e.g., it may relate to inclusions, segregation, weld discontinuities, or mechanical damage to a rail).

**Fracture** – usually the complete separation of one or more portions of the rail (also see “Break”).

**Gauge corner** – the smaller upper rail head radius region that makes contact with the flange of a wheel.

**Gauge side** – the side of rail closest to the wheel flange.

**Gauge line** – the location on the gauge side of the rail head five-eighths inches below the rail tread that is used to establish track gauge.

**Hair line crack** – a fine and usually shallow surface crack.

**Head checks** – transverse surface cracks on the gauge corner of rails, resulting from cold working of the rail surface. These are sometimes referred to as gauge cracks and controlled by preventative rail grinding.

**Head-hardened rail** – a rail that has only the rail head hardened to provide a harder steel for locations where excessive loading forces may increase head wear, such as high side of a curve.

**Heat** – one batch of metal from a steelmaking furnace at the steel mill. All rails rolled from ingots or cast blocks from one heat.

**Heat treatment** – the process of altering the properties of the rail material by a specific heating and cooling process. Heat-treated rail is good in locations that require a rail section of higher strength and durability.

**High carbon rail** – a rail with extra carbon added during the manufacturing process to increase hardness.

**Inclusion** – an impurity, normally an oxide or a sulfide. The inclusion can be generated by the steelmaking process or by in-track thermite welding processes.

**Lip** – a length of material, usually towards the lower edge of the rail head, which has undergone severe plastic deformation to form a folded layer.

**Nucleus** – a term often used by metallurgists to refer to the origin or starting point of a defect.

**Origin** – the cause of a defect, the initial location of a defect, the point of initiation of a crack.

**Outside joint area** – the part of the rail that is not located within the prescribed confines of the “rail end.”

**Percent size** – percentage of rail head cross-sectional area that is weakened by the defect (transverse defects only).

**Pipe** – term assigned to defects that originate from ingot casting procedures.

**Progressive fracture** – term usually used to describe the gradual propagation of a crack over a period of time.

**Rail defect** – may be a defect detected visually, ultrasonically, by other NDT methods, or may be exposed by an inservice rail failure that may render the rail unfit for normal operation.

**Rail end** – the part of jointed rail covered by the angle bar or a similar linear length in welded rail.

**Rail flaw** – imperfections on the surface or interior of the rail section.

**Rail failure** – a rail that is broken while in service. An internal defect may be present. However, a rail failure can result from conditions other than an internal defect (i.e., load impact, stress failure, etc.)

**Rail lip** – a length of rail steel material that has undergone severe plastic deformation to form a folded layer overhanging at the lower corner of the rail head. This condition is typically found on the high side of curves.

**Rail neutral axis** – the point in the rail web where internal pressure is compressive (pushing) above and tensile (pulling) below during vertical loading of the rail section.

**Rail neutral temperature** – the rail temperature at which there are no axial thermal forces in the rail section.

**Rail surface irregularities** – a rail surface irregularity is deformation or damage to the running surface of a rail, which can include the following: flaking, spalling, shelling, corrugation, localized rail head surface collapse, and crushed head and crack-out under the rail head.

**Rail wear** – a reduction of the rail head as a result of abrasive action between the steel wheel on the steel rail.

**Relayed rail** – worn, but still usable, rail taken from track and reused in another location (often referred to as secondhand or used rail).

**Rolling contact fatigue** – a form of rail fatigue damage originating primarily from cyclic loading in the wheel/rail interface zone.

**Running surface** – a longitudinal band on the rail head where the wheels make contact with the rail—also referred to as the “bright band” or “rail tread.”

**Rupture** – a synonym for “fracture” or “break.

**Seam** – an internal rail longitudinal pocket that is inherent from the manufacturing process.

**Section modulus** – the bending strength of a particular rail section.

**Segregation** – a result of an improper steel manufacturing process that can be identified by a separated or partially separated steel microstructure, mostly associated with the rail web.

**Shatter crack** – discontinuous, internal cracks formed in steel due to stresses produced by localized transformation and decreased solubility of hydrogen during cooling after hot-working.

**Shelling** – a term associated with cracks originating from sub-surface defects or at the rail running surface that can result in considerable dislodgment of the rail parent metal.

**Spalling** – a term used to refer to the dislodged parent material area of the rail head that results from rolling contact fatigue.

**Streak** – a dark line seen on the running surface of the rail head.

**Stress relief** – normally referred to as post-weld heat treatment.

**Thermal cracking** – a rail defect identified as fine cracks across the rail head, caused by excessive heat generated at the wheel/rail interface.

**Transposed rail** – rail that is removed from one side of the track to the other side, without turning the rail, so gauge and field sides are interchanged.

**Tread** – path of wheel contact with running surface of the rail.

**Turned rail** – rail with some wear that has been removed, turned, and replaced in track, so gauge and field sides are interchanged.

**Work-hardened rail** – rail that has a hardness greater than when manufactured, as a result of the cold working of the steel by cyclical traffic loading.

## **Metallurgical Terminology**

**Air Cooling** – Cooling of the heated metal, intermediate in rapidity between slow furnace cooling and quenching, in which the metal is permitted to stand in the open air.

**Alloy** – (Met.) Metal prepared by adding other metals or non-metals to a basic metal to secure desirable properties.

**Alloy Steel** – Steel containing substantial quantities of elements other than carbon and the commonly accepted limited amounts of manganese, sulfur, silicon, and phosphorous. Addition of such alloying elements is usually for the purpose of increased hardness, strength, or chemical resistance. The metals most commonly used for forming alloy steels are nickel, chromium, silicon, manganese, tungsten, molybdenum, and vanadium. “Low alloy” steels are usually considered to be those containing a total of less than 5 percent of such added constituents.

**Basic Oxygen Process** – A steelmaking process wherein oxygen of the highest purity is blown onto the surface of a bath of molten iron contained in a basic lined and ladle-shaped vessel. The melting cycle duration is extremely short with quality comparable to open hearth steel.

**Bessemer Process** – A steelmaking process in which air is blown through the molten iron so that the impurities are thus removed by oxidation.

**Bloom** – (Slab, Billet, Sheet-Bar.) Semi-finished products, hot rolled from ingots. The chief differences are in their cross sectional areas in ratio of width to thickness, and in their intended use.

**Blooming-Mill** – A mill used to reduce ingots to blooms, billets, slabs, sheet-bar, etc. (See “Semi-Finished Steel.”)

**Break Test** – (For tempered steel) A method of testing hardened and tempered high-carbon spring steel strip wherein the specimen is held and bent across the grain in a vice-like calibrated testing machine. Pressure is applied until the metal fractures, at which point a reading is taken and compared with a standard chart of brake limitations for various thickness ranges. (See “Bend Test.”)

**Brinell Hardness (Test)** – A common standard method of measuring the hardness of certain metals. The smooth surface of the metal is subjected to indentation by a hardened steel ball under pressure or load. The diameter of the resultant indentation, in the metal surface, is measured by a special microscope and the Brinell hardness value read from a chart or calculated formula.

**Brittleness** – A tendency to fracture without appreciable deformation.

**Butt Welding** – Joining two edges or ends by placing one against the other and welding them.

**Carbon Steel** – Common or ordinary steel as contrasted with special or alloy steels, which contain other alloying metals in addition to the usual constituents of steel in their common percentages.

**Continuous Casting** – A casting technique in which the ingot is continuously solidified while it is being poured and the length is not determined by mold dimensions.

**Cooling Stresses** – Stresses develop by uneven contraction or external constraint of metal during cooling; also those stresses resulting from localized plastic deformation during cooling and retained.

**Corrosion** – Gradual chemical or electrochemical attack on a metal by atmosphere, moisture, or other agents.

**Deburring** – A method whereby the raw slit edge of metal is removed by rolling or filing.



**Degassing Process** – (In steelmaking) Removing gases from the molten metal by means of a vacuum process in combination with mechanical action.

**Ductility** – The property of metals that enables them to be mechanically deformed when cold, without fracture. In steel, ductility is usually measured by elongation and reduction of area as determined in a tensile test.

**Fatigue** – The phenomenon leading to fracture under repeated or fluctuating stress. Fatigue fractures are progressive, beginning as minute cracks, and grow under the action of fluctuating stress.

**Finished Steel** – Steel that is ready for the market without further work or treatment. Blooms, billets, slabs, sheet bars, and wire rods are termed “semi-finished.”

**Fracture Test** – Nicking and breaking a bar by means of sudden impact, to enable macroscopic study of the fracture.

**Hardening** – Any process that increases the hardness of a metal. Usually heating and quenching certain iron base alloys from a temperature either within or above the critical temperature range.

**Hardness** – Degree to which a metal will resist cutting, abrasion, penetration, bending, and stretching. The indicated hardness of metals will differ somewhat with the specific apparatus measuring hardness.

**Heat Treatment** – Altering the properties of a metal by subjecting it to a sequence of temperature changes–time of retention at specific temperature and rate of cooling therefore being as important as the temperature itself. Heat treatment usually markedly affects strength, hardness, ductility, malleability, and similar properties of both metals and their alloys.

**Inclusion** – Particles of impurities (usually oxides, sulfides, silicates, etc.) that are held mechanically or are formed during the solidification of or by subsequent reaction within the solid metal.

**Ingot** – A casting for subsequent rolling or forging.

**Open-Hearth Process** – Process of making steel by heating the metal in the hearth of a regenerative furnace. In the basic open-hearth steel process, the lining of the hearth is basic, usually magnesite; whereas, in the acid open-hearth steel process, an acid material, silica, is used as the furnace lining.

**Oxidation** – The addition of oxygen to a compound. Exposure to atmosphere sometimes results in oxidation of the exposed surface, hence a staining or discoloration. This effect is increased with temperature increase.

**Plastic Deformation** – Permanent distortion of a material under the action of applied stresses.

**Residual Stress** – Macroscopic stresses that are set up within a metal as the result of non-uniform plastic deformation. This deformation may be caused by cold working or by drastic gradients of temperature from quenching or welding.

**Rolling Mills** – Equipment used for rolling down metal to a smaller size or to a given shape, employing sets of rollers that determine or fashion the product into numerous intermediate and final shapes, e.g., blooms, slabs, rails, bars, rods, sections, plates, sheets, and strips.

**Seam** – (A defect) On the surface of metal, a crack that has been closed but not welded; usually produced by some defect either in casting or in working, such as blowholes that have become oxidized or folds and laps that have been formed during working. Similar to cold shut and laminations.

**Segregation** – In an alloy, concentration of carbon or alloying elements at specific regions, usually as a result of the primary crystallization of one phase with the subsequent concentration of other elements in the remaining liquid.

**Slag** – A product resulting from the action of a flux on the nonmetallic constituents of a processed ore, or on the oxidized metallic constituents that are undesirable. Usually slags consist of combinations of acid oxides with basic oxides, and neutral oxides are added to aid fusibility.

**Sliver** – (a defect) Loose metal piece rolled down onto the surface of the metal during the rolling operations.

**Stress** – Deforming force to which a body is subjected or the resistance that the body offers to deformation by the force.

**Structure** – The arrangement of parts, in crystals, especially the shape and dimension of the unit cell, and the number, kinds and positions of the atoms within it.

**Tensile Strength** – (Also called ultimate strength) Breaking strength of a material when subjected to a tensile (stretching) force, usually measured by placing a standard test piece in the jaws of a tensile machine, gradually separating the jaws, and measuring the stretching force necessary to break the test piece. Tensile strength is commonly expressed as pounds (or tons) per square inch of original cross section.

**Toughness** – Property of resisting fracture or distortion, usually measured by impact test, high-impact values, indicating high toughness.

**Work Hardening** – Increase in resistance to deformation (i.e., in hardness) produced by cold working.

## **NonDestructive Test Terminology**

**A-Scan Display** – A data presentation method in which signal amplitude is plotted along the y-axis versus time on the x-axis. The horizontal distance between any two signals represents the material

distance between the two conditions causing the signals. In a linear system, the vertical excursion is proportional to the amplitude of the signal.

**Acoustic Impedance (Z)** – The resistance of a material to the passage of sound waves. The value of this material property is the product of the material density and sound velocity. The acoustic impedance of a material determines how much sound will be transmitted and reflected when the wave encounters a boundary with another material. The larger the difference in acoustic impedance between two materials, the larger the amount of reflected energy will be.

**Amplitude** – (1) The maximum absolute value obtained by the disturbance of a wave or any quantity that varies periodically. (2) The vertical height of a received signal on an A-scan.

**Angle Beam Testing** – An ultrasound testing technique that uses an incidence wave angle other than 90 degrees to the test surface. The refracted angle of the sound energy is calculated using Snell's law.

**Angle Beam Transducers** – A device used to generate sound energy, send the energy into a material at an angle other than 90 degrees to the surface, and receive reflected energy and convert it to electrical pulses.

**Angle of Incidence** – The angle between the direction of propagation of an electromagnetic or acoustic wave (or ray) incident on a body and the local normal to that body.

**Angle of Reflection** – The angle between the direction of propagation of an electromagnetic or acoustic wave (or ray) reflected by a body and the local normal to that body.

**Angle of Refraction** – The angle between the direction of propagation of an electromagnetic or acoustic wave (or ray) refracted by an optically homogeneous body and the local normal to that body.

**Array Transducer** – A transducer made up of several individually piezoelectric elements connected so that the signals they transmit or receive may be treated separately or combined as desired.

**Attenuator** – A device for causing or measuring attenuation, usually calibrated in decibels.

**B-scan** – A data presentation method applied to pulse echo techniques. It produces a two-dimensional view of a cross-sectional plane through the test object. The horizontal sweep is proportional to the distance along the test object and the vertical sweep is proportional to depth, showing the front and back surfaces and discontinuities between.

**Back Reflection** – The signal received from the far boundary or back surface of a test object.

**Beam Spread** – The divergence of the sound beam as it travels through a medium. Specifically, the solid angle that contains the main lobe of the beam in the far field.

**Compressional Wave** – A wave in which the particle motion in the material is parallel to the wave propagation direction (also called a longitudinal wave).

**Contact Method** – The testing method in which the transducer face makes direct contact with the test object through a thin film of couplant.

**Contact Transducers** – An ultrasonic transducer that is designed to be used in direct contact with the surface of the test article.

**Couplant** – A substance (usually liquid) used between the transducer and the test surface to permit or improve transmission of ultrasonic energy into the test object.

**Cross Talk** – The unwanted signal leakage (acoustical or electrical) across an intended barrier, such as leakage between the transmitting and receiving elements of a dual transducer (also called cross noise and cross coupling).

**Cycle (Hertz)** – Comprises complete set of recurrent values of a periodic quantity.

**Decibel** – A logarithmic unit for expressing power relationships.  $n = 10 \log_{10}(I_1/I_2)$  where  $n$  is the difference of decibels of intensities 1 and 2.

**Defect** – A discontinuity or other imperfection causing a reduction in the quality of a material or component.

**Density** – The mass of a substance per unit volume.

**Discontinuity** – A break in the continuity of a medium or material.

**Echo** – A signal indicating reflected acoustic energy.

**Elasticity** – A term that describes how quickly molecules return to their original positions.

**False Indication** – A test indication that could be interpreted as originating from a discontinuity but which actually originates where no discontinuity exists.

**Flat Bottom Hole** – A type of reflector commonly used in reference standards. The end (bottom) surface of the hole is the reflector.

**Frequency** – The number of waves that pass a given point in a specified unit of time.

**Gain Control** – A control which varies the amplification of the ultrasonic system (also considered the sensitivity control).

**Gate** – An electronic device for monitoring signals in a selected segment of the trace on an A-scan display. The interval along the baseline that is monitored.

**Hertz** – One cycle per second.

**Inherent Defects** – Discontinuities that are normal in the material at the time it originally solidifies from the molten state.

**Longitudinal Waves** – Commonly used term for compressional wave.

**Loss of Back Reflection** – Absence or significant reduction of an indication from the back surface of the test object.

**Main Bang** – See initial pulse.

**Noise** – Any undesired signal that obscures the signal of interest. It might be electrical noise or a signal from specimen dimensional or property variations.

**Nondestructive Testing** – Testing to detect defects in materials using techniques that do not damage or destroy the items being tested.

**Orientation** – The angular relationship of a surface, plane, discontinuity or axis to a reference plane or surface.

**Phase Array** – A mosaic of transducer elements in which the timing of the elements' excitation can be individually controlled to produce certain desired effects, such as steering the beam axis or focusing the beam.

**Piezoelectric Effect** – The ability of certain materials to convert electrical energy into mechanical energy and vice versa.

**Piezoelectric Element** – A material that vibrates when an electric current passes through it.

**Propagation** – Advancement of a wave through a medium.

**Pulse** – A transient electrical or ultrasonic signal.

**Pulse Echo Method** – An ultrasonic test method in which discontinuities are detected by return echoes from the transmitted pulses.

**Pulse-Echo Test** – A test that can determine the location of a discontinuity by measuring the time required for a short ultrasonic pulse to travel through the material.

**Pulse Method** – Use of ultrasonic equipment that generated a series of pulses that are separated from each other by a constant period of time, i.e., energy is not sent out continuously.

**Pulse Rate** – Number of pulses that are transmitted in a unit time (also called pulse repetition rate).

**Pulser-Receiver** – Used with a transducer and oscilloscope for flaw detection and thickness gauging.

**Range** – The maximum ultrasonic path length that is displayed. See also “sweep length.”

**Refracted Beam** – A beam that occurs in the second medium when an ultrasonic beam is incident at an acute angle on the interface between two media having different sound velocities.

**Refraction** – The change in direction of an acoustic wave as the ultrasonic beam passes from one medium into another having a different sound velocity. A change in both direction and mode occurs at acute angles of incidence. At small angles of incidence, the original mode and a converted mode may exist in the second medium.

**Resolution** – The ability to clearly distinguish signals obtained from two reflective surfaces with a minimum difference in depth. Near surface resolution is the ability to clearly distinguish a signal from a reflector at a minimum distance under the near surface without interference from the initial pulse signal. Far surface resolution is the ability to clearly distinguish signals from the back surface when the sound beam is normal to that back surface.

**Scanning** – Movement of the transducer over the surface of the test object in a controlled manner so as to achieve complete coverage. May be either contact or immersion method.

**Search Unit** – An assembly comprising a piezoelectric element, backing material (damping), wear plate or wedge (optional) and leads enclosed in a housing (also called transducer or probe).

**Sensitivity** – A measure of the ability to detect small signals. Limited by the signal-to-noise ratio.

**Shear Waves** – Waves that move perpendicular to the direction the wave propagates.

**Shear Wave Transducer** – An angle beam transducer designed to cause converted shear waves to propagate at a nominal angle in a specified test medium.

**Shoe** – A device used to adapt a straight beam transducer for use in a specific type of testing, including angle beam or surface wave tests and tests on curved surfaces. See also “Wedge.”

**Sound** – Mechanical vibrations transmitted by an elastic medium.

**Test Frequency** – The frequency of vibration of the ultrasonic transducer employed for ultrasonic testing.

**Test Surface** – The surface of the test object at which the ultrasonic energy enters or leaves.

**Time of Flight** – The time for an acoustic wave to travel between two points; for example, the time required for a pulse to travel from the transmitter to the receiver via diffraction at a discontinuity edge or along the surface of the test object.

**Transducer** – An electro-acoustic or magneto-acoustic device containing an element for converting electrical energy into acoustical energy and vice versa. See “Search Unit.”

**Transducer Element** – The component in a transducer that actually converts the electrical energy into acoustical energy and vice versa. The transducer element is often made of a piezoelectric material or a magnetostrictive material.

**Ultrasonic** – A term referring to acoustic vibration frequencies greater than about 20,000 hertz.

**Ultrasonic Testing** – The transmission of high-frequency sound waves into a material to detect imperfections or to locate changes in material properties.

**Ultrasonic Vibrations** – Vibrational waves of a frequency above the hearing range of the normal human ear are referred to as ultrasonic, and the term therefore includes all those waves of a frequency of more than approximately 20,000 cycles per second. Also known as ultrasonic waves.

**Ultrasonic Waves** – Sound waves too high in frequency for humans to hear.

**Ultrasonically Sound Material** – A material having no discontinuities that cause discernible ultrasonic indications at the required test sensitivity level.

**Velocity** – Distance traveled per unit of time.

**Vibration** – A rapid back and forth motion of a particle or solid.

**Wavelength** – The distance needed in the propagation direction for a wave to go through a complete cycle.

**Wedge** – A device used to direct ultrasonic energy into a test object at an acute angle. See also “Shoe.”