

REPORT NO. UMTA-MA-06-0025-77-4

ENGINEERING TESTS FOR ENERGY STORAGE CARS,
AT THE TRANSPORTATION TEST CENTER
Volume III - Noise Tests

William T. Curran
AiResearch Manufacturing Company
2525 West 190th Street
Torrance CA 90509



MAY 1977

FINAL REPORT

DOCUMENT IS AVAILABLE TO THE U.S. PUBLIC
THROUGH THE NATIONAL TECHNICAL
INFORMATION SERVICE, SPRINGFIELD,
VIRGINIA 22161

Prepared for
U.S. DEPARTMENT OF TRANSPORTATION
URBAN MASS TRANSPORTATION ADMINISTRATION
Office of Technology Development and Deployment
Office of Rail Technology Development
Washington DC 20590

NOTICE

This document is disseminated under the sponsorship of the Department of Transportation in the interest of information exchange. The United States Government assumes no liability for its contents or use thereof.

NOTICE

The United States Government does not endorse products or manufacturers. Trade or manufacturers' names appear herein solely because they are considered essential to the object of this report.

Technical Report Documentation Page

1. Report No. UMTA-MA-06-77-4	2. Government Accession No.	3. Recipient's Catalog No.	
4. Title and Subtitle ENGINEERING TESTS FOR ENERGY STORAGE CARS AT THE TRANSPORTATION TEST CENTER Volume III-Noise Tests		5. Report Date May 1977	
		6. Performing Organization Code	
7. Author(s) William T. Curran		8. Performing Organization Report No. DOT-TSC-UMTA-77-6, III	
9. Performing Organization Name and Address * AiResearch Manufacturing Company 2525 West 190th Street Torrance CA 90509		10. Work Unit No. (TRAIS) UM704/R7706	
		11. Contract or Grant No. DOT-TSC-838-3	
12. Sponsoring Agency Name and Address U.S. Department of Transportation Urban Mass Transportation Administration Office of Technology Development and Deployment Office of Rail Technology Development Washington, DC 20590		13. Type of Report and Period Covered Final Report May 1974 through January 1975	
		14. Sponsoring Agency Code	
15. Supplementary Notes U.S. Department of Transportation Transportation Systems Center * Under contract to: Kendall Square Cambridge MA 02142			
16. Abstract The primary purpose of the tests documented herein was to demonstrate the principles and feasibility of an energy storage type propulsion system, and its adaptability to an existing car design. The test program comprised four phases of tests on two New York City Transit Authority R-32 cars where propulsion system had been replaced by an energy storage system. The four test phases were: verification of safe arrival, debugging procedures, performance verification tests, and expanded test program. This report contains test data collected during the performance verification and expanded test program phases. Testing was conducted at the DOT Transportation Test Center, Pueblo, Colorado. The data was collected and processed in accordance with the General Vehicle Test Plan for Urban Rail Testing. Volume I of this report covers the Program Description and Test Summary; Volume II, Performance, Power Consumption, and Radio Frequency Interference Tests; and Volume IV, Ride Roughness Tests.			
17. Key Words Energy Storage Cars (ESC) performance, power consumption, exterior noise, interior noise, ride roughness, radio frequency interference, structural dynamics		18. Distribution Statement DOCUMENT IS AVAILABLE TO THE U.S. PUBLIC THROUGH THE NATIONAL TECHNICAL INFORMATION SERVICE, SPRINGFIELD, VIRGINIA 22161	
19. Security Classif. (of this report) Unclassified	20. Security Classif. (of this page) Unclassified	21. No. of Pages 94	22. Price

METRIC CONVERSION FACTORS

Approximate Conversions to Metric Measures

Symbol	When You Know	Multiply by	To Find	Symbol
LENGTH				
in	inches	2.5	centimeters	cm
ft	feet	30	centimeters	cm
yd	yards	0.9	meters	m
mi	miles	1.6	kilometers	km
AREA				
in ²	square inches	6.5	square centimeters	cm ²
ft ²	square feet	0.09	square meters	m ²
yd ²	square yards	0.8	square meters	m ²
mi ²	square miles	2.6	square kilometers	km ²
	acres	0.4	hectares	ha
MASS (weight)				
oz	ounces	28	grams	g
lb	pounds	0.45	kilograms	kg
	short tons (2000 lb)	0.9	tonnes	t
VOLUME				
tsp	teaspoons	5	milliliters	ml
Tbsp	tablespoons	15	milliliters	ml
fl oz	fluid ounces	30	milliliters	ml
c	cups	0.24	liters	l
pt	pints	0.47	liters	l
qt	quarts	0.95	liters	l
gal	gallons	3.8	liters	l
ft ³	cubic feet	0.03	cubic meters	m ³
yd ³	cubic yards	0.76	cubic meters	m ³
TEMPERATURE (exact)				
°F	Fahrenheit temperature	5/9 (after subtracting 32)	Celsius temperature	°C

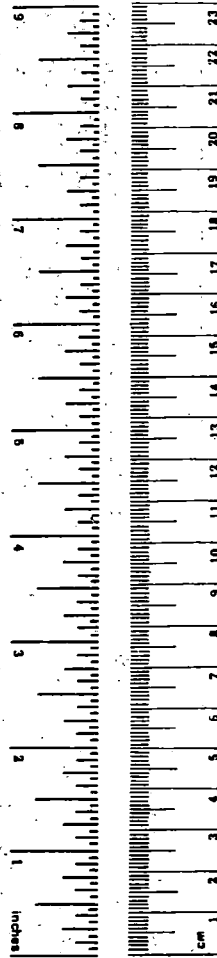

Approximate Conversions from Metric Measures

Symbol	When You Know	Multiply by	To Find	Symbol
LENGTH				
mm	millimeters	0.04	inches	in
cm	centimeters	0.4	inches	in
m	meters	3.3	feet	ft
m	meters	1.1	yards	yd
km	kilometers	0.6	miles	mi
AREA				
cm ²	square centimeters	0.16	square inches	in ²
m ²	square meters	1.2	square yards	yd ²
km ²	square kilometers	0.4	square miles	mi ²
ha	hectares (10,000 m ²)	2.5	acres	
MASS (weight)				
g	grams	0.035	ounces	oz
kg	kilograms	2.2	pounds	lb
t	tonnes (1000 kg)	1.1	short tons	
VOLUME				
ml	milliliters	0.03	fluid ounces	fl oz
l	liters	2.1	pints	pt
l	liters	1.06	quarts	qt
l	liters	0.26	gallons	gal
m ³	cubic meters	36	cubic feet	ft ³
m ³	cubic meters	1.3	cubic yards	yd ³
TEMPERATURE (exact)				
°C	Celsius temperature	9/5 (then add 32)	Fahrenheit temperature	°F

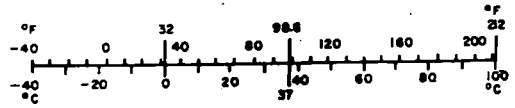

CONTENTS

<u>Section</u>		<u>Page</u>
1.	INTRODUCTION	1-1
	1.1 General	1-1
	1.2 Scope	1-1
	1.3 Instrumentation	1-1
	1.4 Test Set Summary Sheets	1-1
2.	EXTERIOR NOISE - EQUIPMENT NOISE SURVEY (ESC-CN-0001-TT)	2-1
	2.1 Summary	2-1
	2.2 Procedures	2-1
	2.3 Test Description and Results	2-3
3.	EXTERIOR NOISE - EFFECT OF CAR SPEED (ESC-CN-1001-TT)	3-1
	3.1 Summary	3-1
	3.2 Procedures	3-1
	3.3 Test Description and Results	3-3
4.	INTERIOR NOISE - EFFECT OF CAR SPEED (ESC-PN-1001-TT)	4-1
	4.1 Summary	4-1
	4.2 Procedures	4-1
	4.3 Test Description and Results	4-3
5.	INTERIOR NOISE - EFFECT OF TRACK SECTION (ESC-PN-1101-TT)	5-1
	5.1 Summary	5-1
	5.2 Procedures	5-1
	5.3 Test Description and Results	5-3
6.	INTERIOR NOISE SURVEY (ESC-PN-1301-TT)	6-1
	6.1 Summary	6-1
	6.2 Procedures	6-1
	6.3 Test Description and Results	6-3

CONTENTS (CONTINUED)

<u>Section</u>		<u>Page</u>
7.	INTERIOR NOISE - ACCELERATION EFFECT (ESC-PN-2001-TT)	7-1
	7.1 Summary	7-1
	7.2 Procedures	7-1
	7.3 Test Description and Results	7-3
8.	INTERIOR NOISE - DECELERATION EFFECT (ESC-PN-3001-TT)	8-1
	8.1 Summary	8-1
	8.2 Procedures	8-1
	8.3 Test Description and Results	8-3
9.	GLOSSARY	9-1

ILLUSTRATIONS

<u>Figure</u>		<u>Page</u>
1-1	Data Acquisition System	1-2
1-2	Data Recovery System	1-3
1-3	Exterior Noise - Equipment Noise Test Instrumentation	1-4
1-4	Exterior Noise - Car Speed Test Instrumentation	1-5
1-5	Interior Noise - Car Speed and Track Section Test Instrumentation	1-6
1-6	Interior Noise Survey Instrumentation	1-7
2-1	Exterior Noise Summary - Microphone 50 Feet from Track	2-4
2-2	Exterior Noise Summary - Microphone on Platform	2-5
2-3	Exterior Noise Microphone Locations	2-6
2-4	Equipment Noise Survey - Microphone 50 Feet from Track (Sheets 1 through 6)	2-7
2-5	Equipment Noise Survey - Microphone on Platform (Sheets 1 through 6)	2-13
3-1	Exterior Noise Test - Effect of Car Speed (Sheets 1 through 6)	3-4
4-1	Interior Noise Test - Effect of Car Speed (Sheets 1 and 2)	4-4
5-1	Interior Noise Test - Effect of Track Section (Sheets 1 through 6)	5-4
6-1	Interior Noise Survey Summary - Track Configurations	6-4
6-2	Interior Noise Survey (Sheets 1 through 4)	6-5
6-3	Interior Noise Survey - Car Body Vibration (Sheets 1 through 4)	6-9

ILLUSTRATIONS (CONTINUED)

<u>Figure</u>		<u>Page</u>
6-4	Interior Noise Survey - Flywheel Vibration (Sheets 1 through 3)	6-13
7-1	Interior Noise Test - Acceleration Effect (Sheets 1 through 4)	7-4
8-1	Interior Noise Test - Deceleration Effect	8-4

1. INTRODUCTION

1.1 GENERAL

The test report on the energy storage cars is presented in four volumes.

Volume I	Program Description and Test Summary
Volume II	Performance, Power Consumption and Radio Frequency Interference Tests
Volume III	Noise Tests
Volume IV	Ride Roughness Tests

The information contained in this volume is related to the exterior and interior noise tests. The exterior noise tests include equipment noise and the effect of car speed. Interior noise tests include the effect of car speed and track section, interior noise survey and the acceleration and deceleration effect tests.

These tests were performed by AiResearch at the Transportation Test Center in Pueblo, Colorado. The tests were conducted in accordance with AiResearch Test Program, 73-9373 and Expanded Test Procedures, 74-10441 to comply with Transportation System Center General Vehicle Test Plan, GSP-064.

1.2 SCOPE

Each section of this volume is devoted to the tests covered by a specific GSP-064 Test Set. The test procedures for each test set and a description of the AiResearch tests are also included.

1.3 INSTRUMENTATION

The instrumentation required for the data acquisition system is shown in figure 1-1, the data recovery system instrumentation in figure 1-2. Figures 1-3 through 1-6 show in detail the specific instrumentation required for each of the tests included in this volume of the report.

1.4 TEST SET SUMMARY SHEETS

A summary sheet of each GSP-064 Test Set related to the tests covered by this volume is provided in this section as a convenience for the reader.

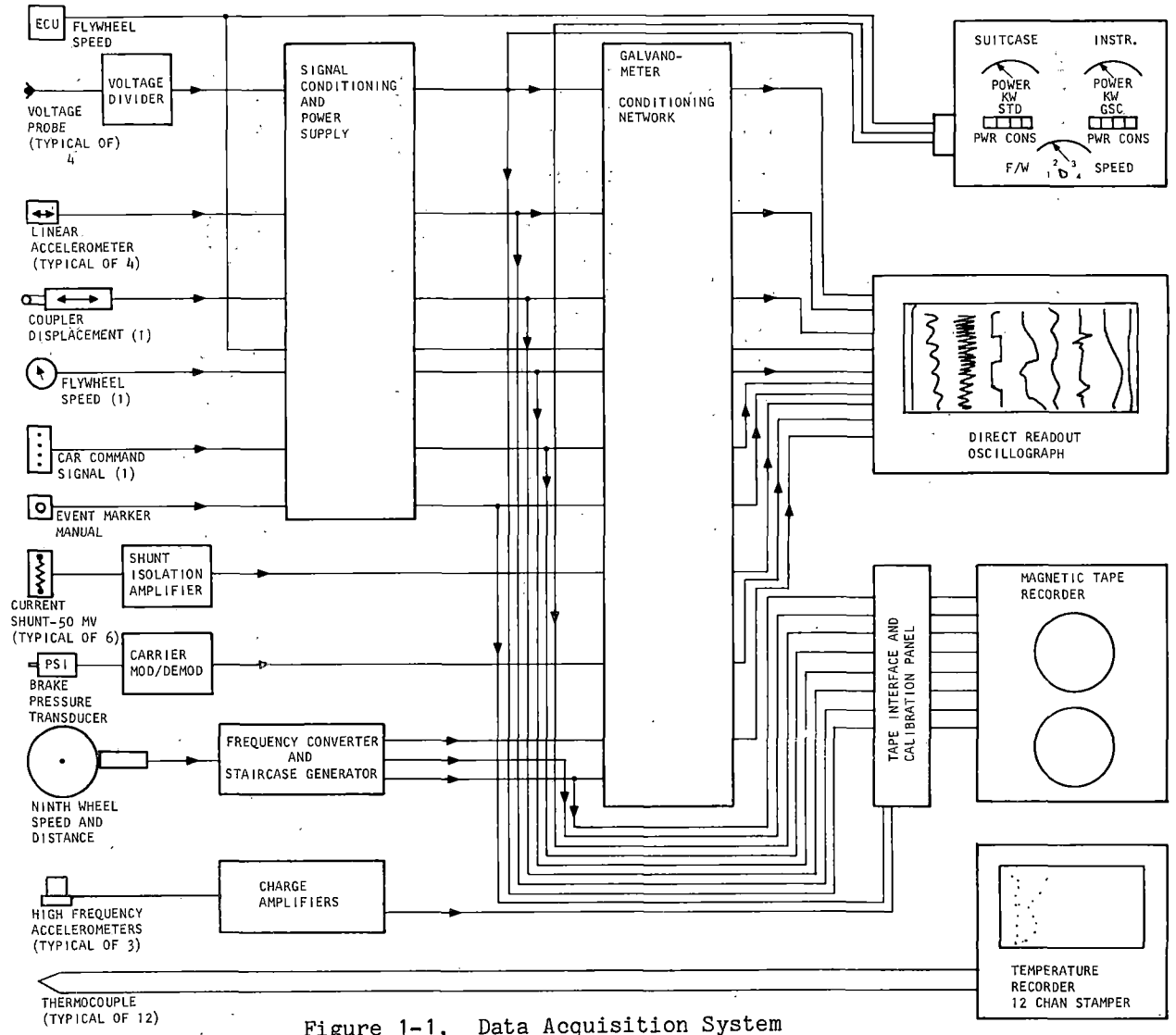

Figure 1-1. Data Acquisition System

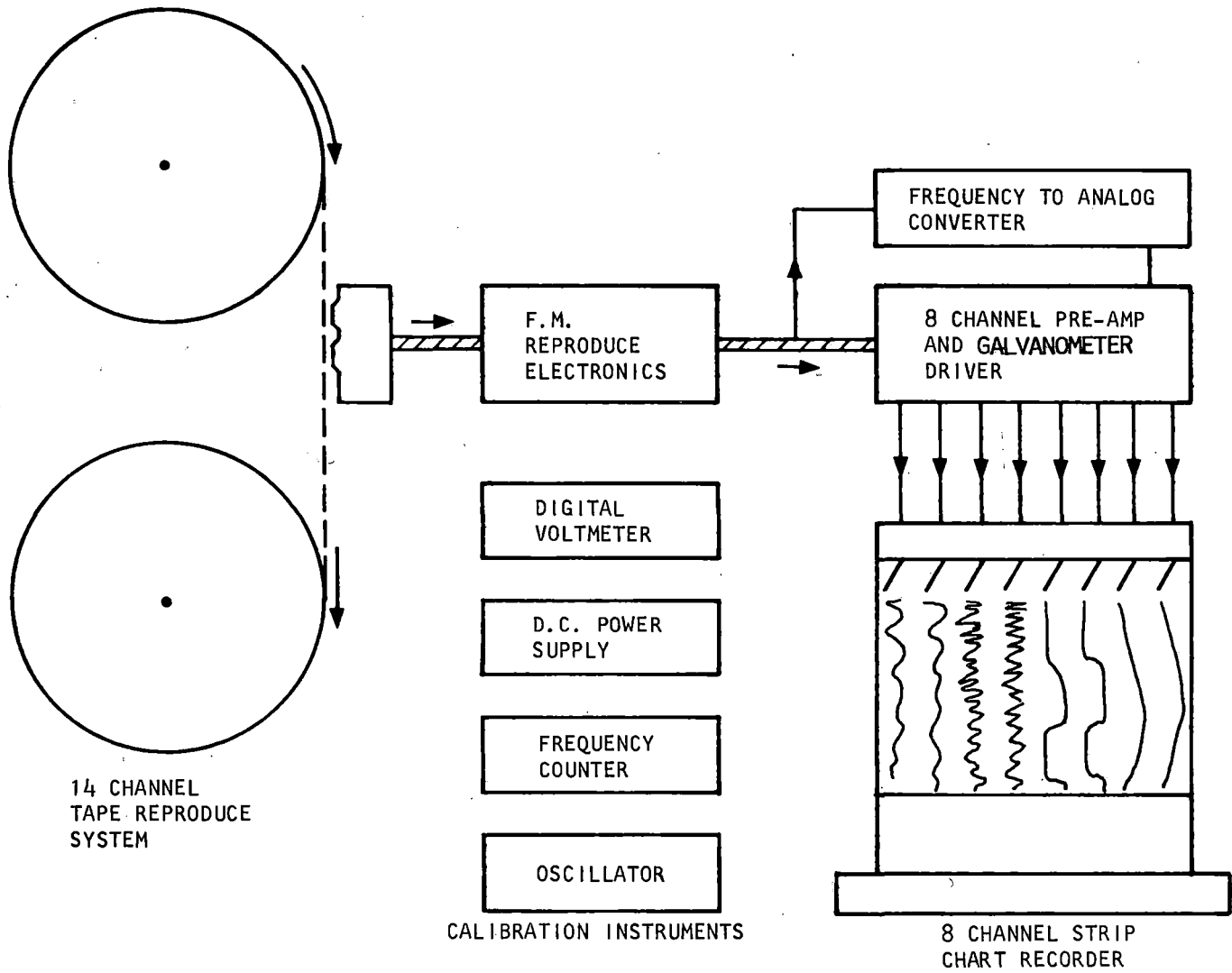

Figure 1-2. Data Recovery System

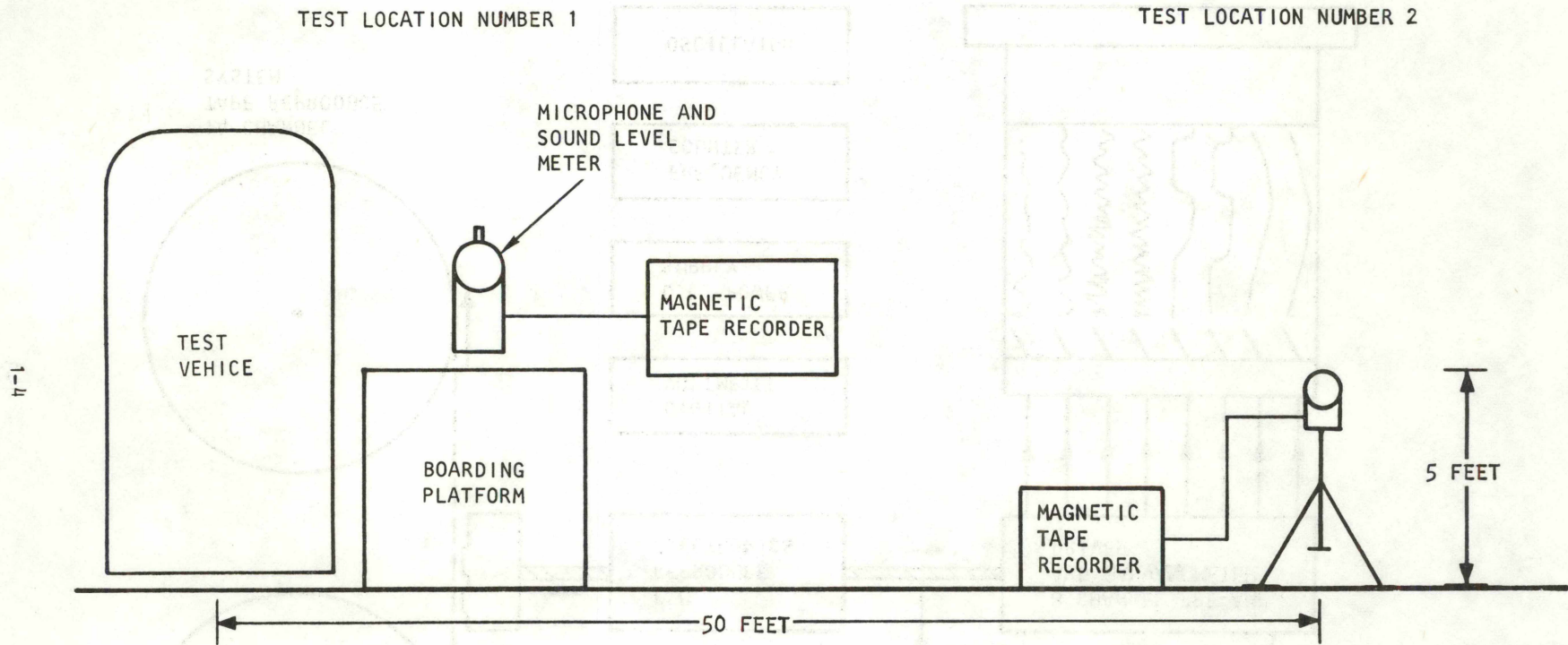

Figure 1-3. Exterior Noise - Equipment Noise Test Instrumentation

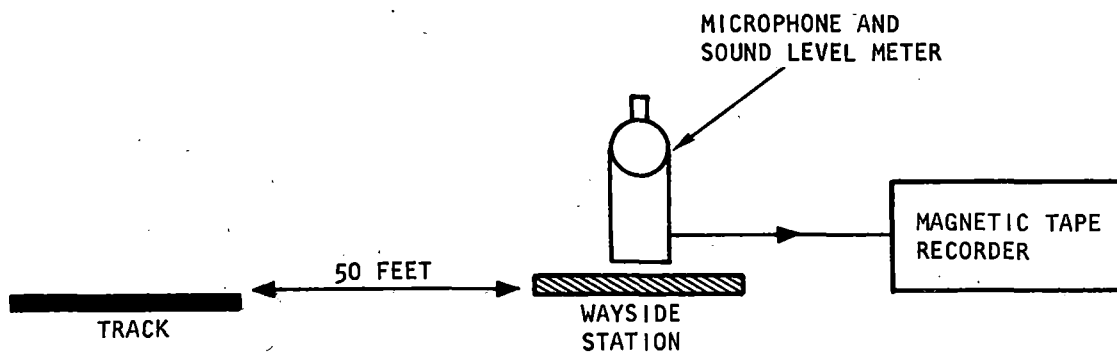
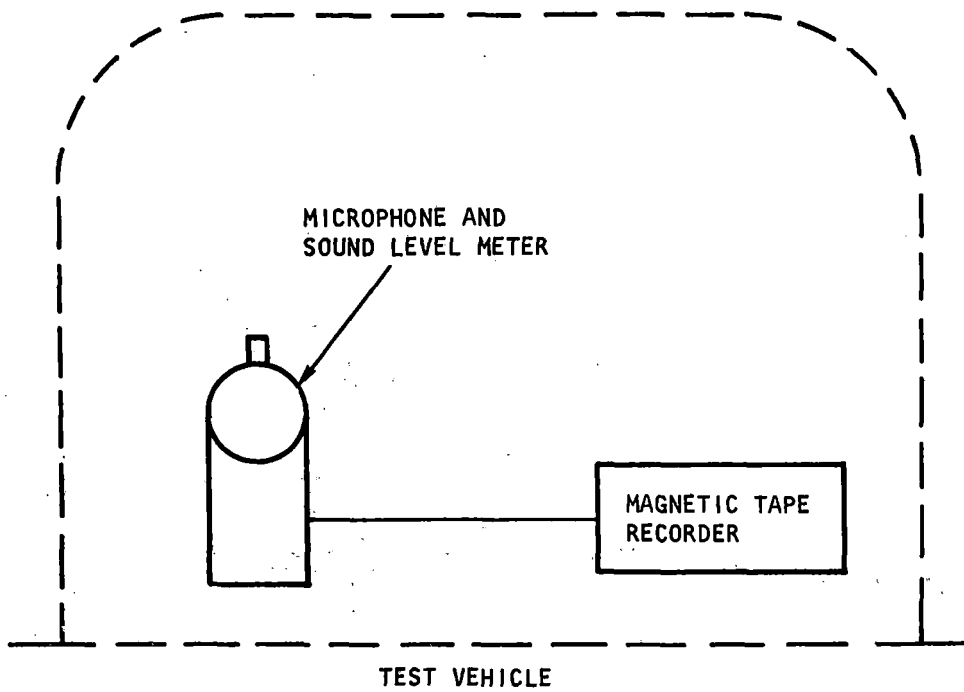

Figure 1-4. Exterior Noise - Car Speed Test Instrumentation



NOTE:

SETUP FOR EFFECT OF TRACK SECTION
SAME AS FOR EFFECT OF SPEED

Figure 1-5. Interior Noise - Car Speed and Track Section
Test Instrumentation

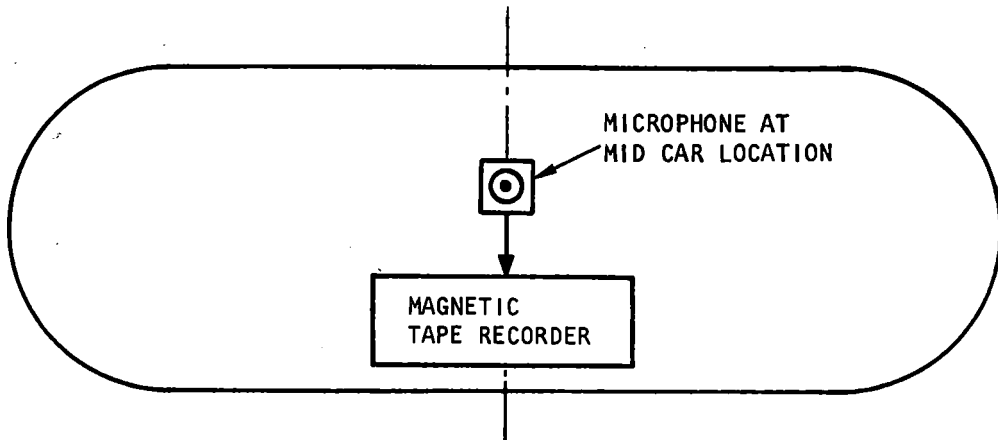

Figure 1-6. Interior Noise Survey Instrumentation

TEST TITLE: EQUIPMENT NOISE SURVEY - WAYSIDE

TEST SET NUMBER: ESC-CN-0001-TT

TEST OBJECTIVE:

To determine the contribution of equipment noise to total test vehicle signature.

TEST DESCRIPTION:

This test will be performed at a boarding platform area.

STATUS:

The energy storage cars successfully completed the equipment noise tests as prescribed by the conditions specified in paragraph 2.1.2. Refer to test log runs 51 through 54 presented in Volume I, Appendix C of this report.

TEST TITLE: EFFECT OF CAR SPEED - WAYSIDE

TEST SET NUMBER: ESC-CN-1001-TT

TEST OBJECTIVE:

Determine Wayside noise levels during vehicle passbys during constant speed conditions.

TEST DESCRIPTION:

This test will be performed at a wayside station 50 feet from the track for the following conditions:

- (a) Vehicle weights of AW0 and AW3
- (b) Single car and Multiple Units
- (c) Five selected speeds

STATUS:

The energy storage cars successfully completed the exterior car speed tests as prescribed by the conditions specified in paragraph 3.1.2. Refer to test log runs 51 through 54 presented in Volume I, Appendix C of this report.

TEST TITLE: EFFECT OF CAR SPEED - ON CAR

TEST SET NUMBER: ESC-PN-1001-TT

TEST OBJECTIVE:

To determine noise levels inside the test vehicle while operating at various speeds.

TEST DESCRIPTION:

This test will be performed at the following conditions:

- (a) Vehicle weights of AW0 and AW3
- (b) Four car interior locations
- (c) Five car speeds

STATUS:

The energy storage cars successfully completed the interior car speed tests as prescribed by the conditions specified in paragraph 4.1.2. Refer to test log run 72 presented in Volume I, Appendix C of this report.

TEST TITLE: EFFECT OF TRACK SECTION - ON CAR

TEST SET NUMBER: ESC-PN-1101-TT

TEST OBJECTIVE:

To determine the effect of track construction on interior noise levels.

TEST DESCRIPTION:

This test will be performed at one vehicle weight (AWO) and one speed on all sections of the UMTA test track.

STATUS:

The energy storage cars successfully completed the track section tests as prescribed by the conditions specified in paragraph 5.1.2. Refer to test log run 72 presented in Volume I, Appendix C of this report.

TEST TITLE: INTERIOR NOISE SURVEY

TEST SET NUMBER: ESC-PN-1301-TT

TEST OBJECTIVE:

To determine the noise characteristics of the test vehicle by a survey of various passenger locations.

TEST DESCRIPTION:

This test will be performed at one vehicle weight (AWO) while operating at a constant speed.

STATUS:

The energy storage cars successfully completed the interior noise tests as prescribed by the conditions specified in paragraph 6.1.2. Refer to test log runs 50, 71 and 72 presented in Volume I, Appendix C of this report.

TEST TITLE: ACCELERATION EFFECT - ON CAR

TEST SET NUMBER: ESC-PN-2001-TT

TEST OBJECTIVE:

To determine noise levels inside the test vehicle while accelerating.

TEST DESCRIPTION:

This test will be performed at selected interior test points for vehicle weights of AWO and AW3.

STATUS:

The energy storage cars successfully completed the acceleration effect tests as prescribed by the conditions specified in paragraph 7.1.2. Refer to test log runs 53, 67 and 72 presented in Volume I, Appendix C of this report.

TEST TITLE: DECELERATION EFFECT - ON CAR

TEST SET NUMBER: ESC-PN-3001-TT

TEST OBJECTIVE:

To determine noise levels inside the test vehicle while decelerating.

TEST DESCRIPTION:

This test will be performed at the following conditions:

- (a) For selected interior test points
- (b) For various braking configurations (depends upon modes available on test vehicle). The basic configuration will be the normal service system.
- (c) Vehicle weights of AW0 and AW3.

STATUS:

The energy storage cars successfully completed the deceleration effect tests as prescribed by the conditions specified in paragraph 8.1.2. Refer to test log runs 53, 67 and 72 presented in Volume I, Appendix C of this report.

2. EXTERIOR NOISE - EQUIPMENT NOISE SURVEY (ESC-CN-0001-TT)

2.1 SUMMARY

The exterior noise level test to determine the amount of noise the equipment contributes to the total noise level was conducted in compliance with Test Set Number ESC-CN-0001-TT of the TSC General Vehicle Test Plan, GSP-064. Requirements and procedures covered by the test set are defined in paragraphs 2.1.1 through 2.2.2. Refer to paragraph 2.3 for a description of the test, instrumentation used, and for the test results.

2.1.1 TEST OBJECTIVE

To determine the contribution of equipment noise to total test vehicle signature.

2.1.2 TEST DESCRIPTION

This test will be performed at a boarding platform area.

2.1.3 STATUS

The energy storage cars successfully completed the equipment noise tests as prescribed by the conditions specified in paragraph 2.1.2. Refer to test log runs 51 through 54 presented in Volume I, Appendix C of this report.

2.2 PROCEDURES

The following test procedures are included as part of the ESC-CN-0001-TT Test Set. The ESC tests were performed generally in accordance with these procedures and any procedural differences are reflected in paragraph 2.3.

2.2.1 PRETEST PROCEDURE

- (a) Ensure that the test vehicle is in a true test configuration (No wheel flats, no missing acoustical barriers such as seats or wind-screens).
- (b) Ensure that the following weather conditions prevail:

No rain or other precipitation

Less than 90% relative humidity

Less than 10 knots wind velocity

- (c) Identify model and serial number of the noise measurement system.
- (d) Ensure that the test site is relatively free of excessive sound absorptive or obstructive characteristics.
- (e) Install a windscreen on the noise measurement microphone.
- (f) Calibrate the noise measurement system by recording a known acoustic calibration signal in order to provide a reference level. Do this at the beginning and end of the test, but at least twice on each test data tape.
- (g) Record ambient noise, including both acoustical background and electrical noise of the measurement system.
- (h) Record barometric pressure, relative humidity and ambient temperature at beginning of test.

CAUTION

1. Caution test crew on maintaining integrity of the noise test data.
2. Position recording microphone such that it is not shielded from the source of noise.
3. Record wind velocity and direction prior to each test point.
4. The direction of motion of the Test vehicle will be the same for all test points.

2.2.2 TEST PROCEDURE

- (a) Position the test vehicle at a boarding platform away from other noise sources with all equipment turned off.
- (b) Position one microphone at the ear level of a standing passenger on the platform. Position the second microphone 50 feet from the track centerline at mid car.
- (c) Start the recorders prior to equipment cycle, identify the test point and the record gain level by voice.
- (d) Start up each item of equipment and record approximately 15 seconds of noise data for each record.
- (e) Maintain a written log of the equipments and record numbers.
- (f) Cycle the passenger doors for the last test point.

2.3 TEST DESCRIPTION AND RESULTS

The energy storage car (ESC) exterior equipment noise tests were conducted in accordance with AiResearch Documents 73-9373 and 74-10441 as defined in paragraph 2.3.1 and in compliance with GSP-064 Test Set ESC-CN-0001-TT, described in paragraphs 2.1.1 and 2.1.2.

2.3.1 DESCRIPTION

The ESC exterior equipment noise tests were performed, using the procedures described in paragraph 2.2, to evaluate the exterior audio noise level produced by the energy storage system.

With the energy storage cars at a standstill, equipment such as the car doors, air compressor, motor-generator set and ventilation fans was operated separately and in combinations. The noise created by the equipment was recorded by microphones located 50 feet from the track and on the platform. Amplitude versus frequency plots of these conditions was obtained as well as the flywheel noise created at start-up, steady state and at coast-down.

Summary plots depicting the relative noise level caused by various items of equipment, recorded with microphones located 50 feet from the track and on the platform, are shown in figures 2-1 and 2-2 respectively. It will be noted that some car equipment exterior noise data is lower when recorded from the platform than when recorded with the microphone 50 feet away. This apparent contradiction is due to a masking effect resulting from the close-in microphone location. The platform microphone location was directly opposite the coupler just outside the clearance line of the cars. From this position, some parts of the vehicle would appear as obstructions to direct sound propagation from sources on the far side or toward the ends. A view of the microphone positions is shown in figure 2-3.

2.3.2 INSTRUMENTATION

Block diagrams of the data acquisition system and the data recovery system are provided in figures 1-1 and 1-2. Details of instrumentation related to the equipment noise tests is shown in figure 1-3. Information concerning instrumentation for overall data acquisition for the energy storage car tests is described in Volume I of this report.

2.3.3 RESULTS

Representative samples of test results showing noise level of various items of equipment recorded by two microphones, located 50 feet from the track are shown in figures 2-4, sheets 1 through 4; flywheel noise level tests are shown in sheets 5 and 6.

Sample results of similar tests with the microphone located on the platform are shown in figure 2-5. See sheets 1 through 3 for equipment noise level tests and sheets 4 through 6 for flywheel noise level tests.

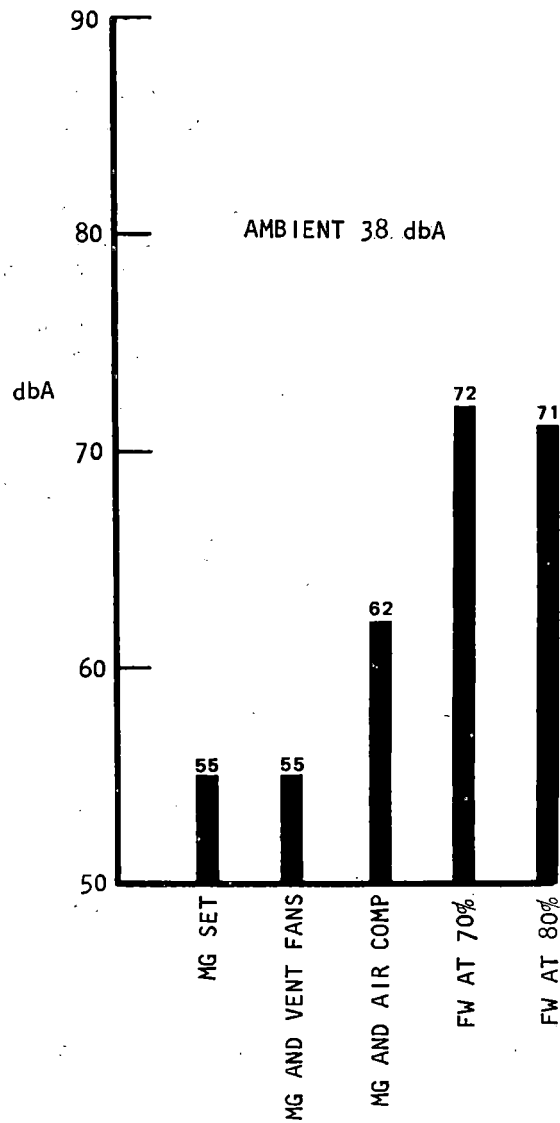

Figure 2-1. Exterior Noise Summary - Microphone 50 Feet From Track

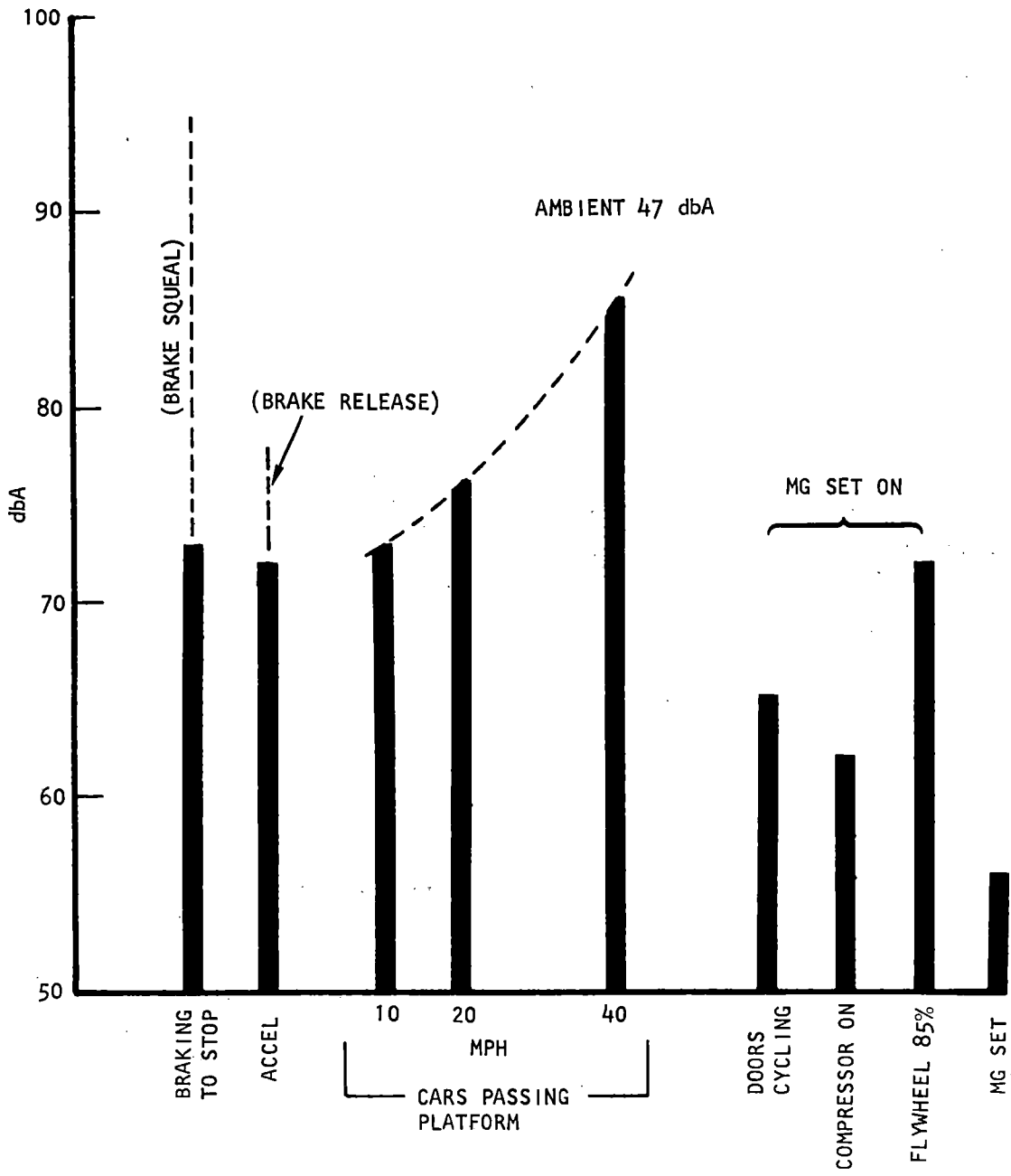

Figure 2-2. Exterior Noise Summary - Microphone on Platform

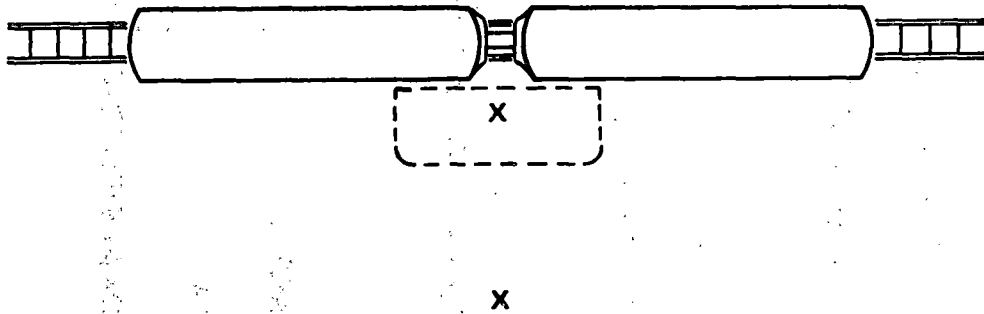

Figure 2-3. Exterior Noise **Microphone** Locations

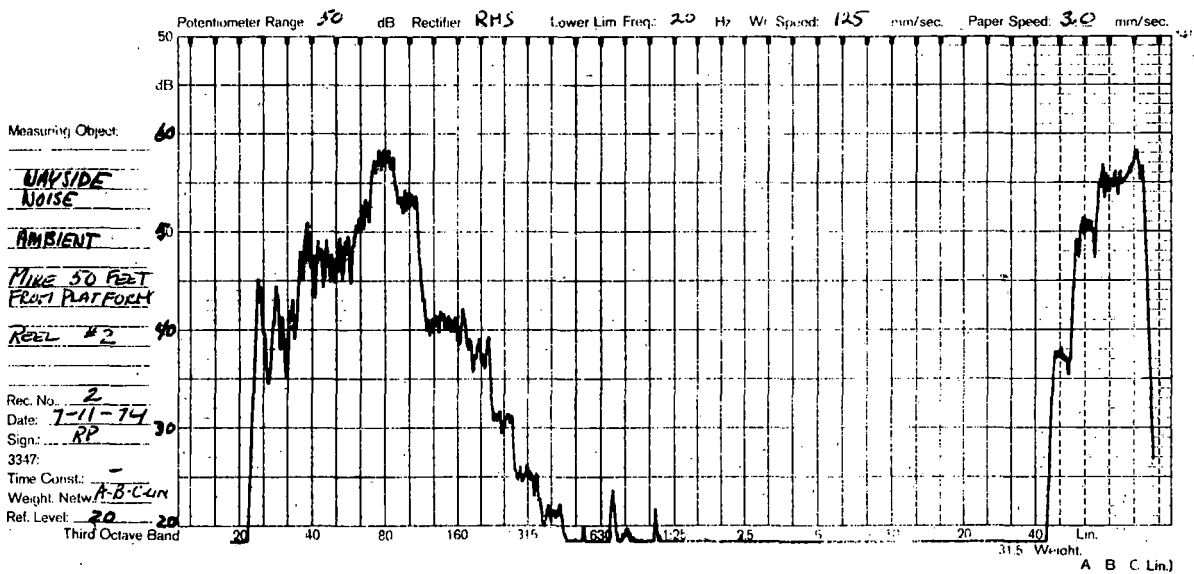
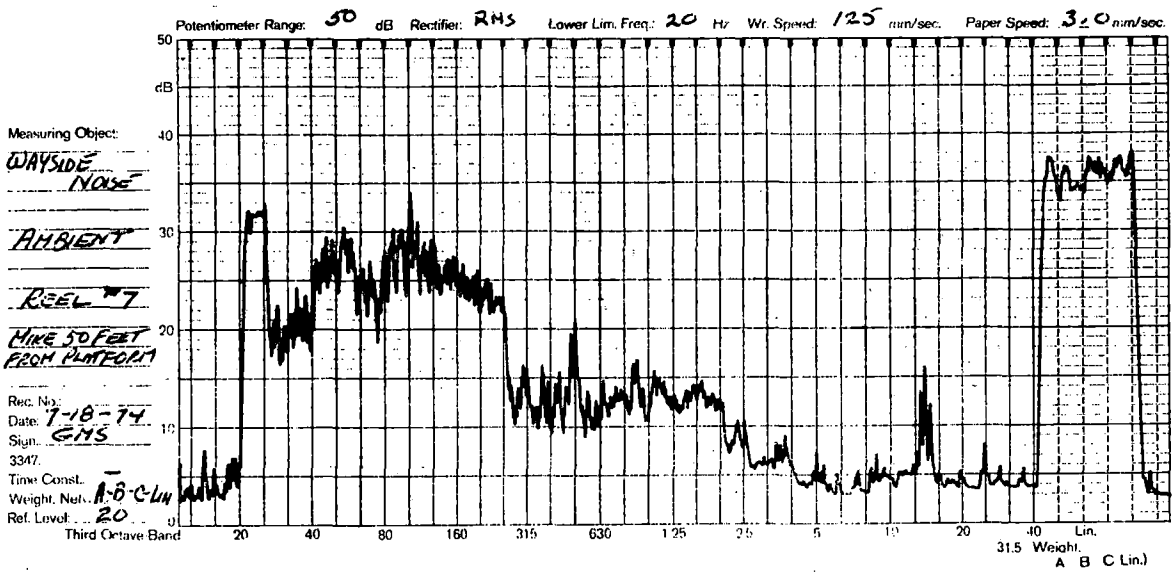

Figure 2-4. Equipment Noise Survey - Microphone 50 Feet From Track (Sheet 1)

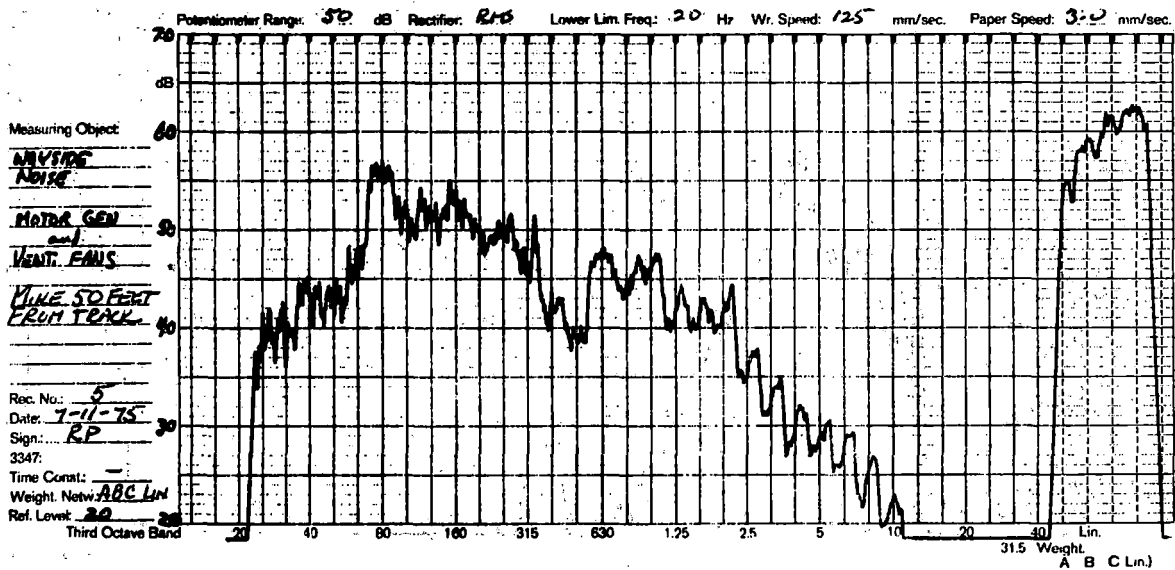
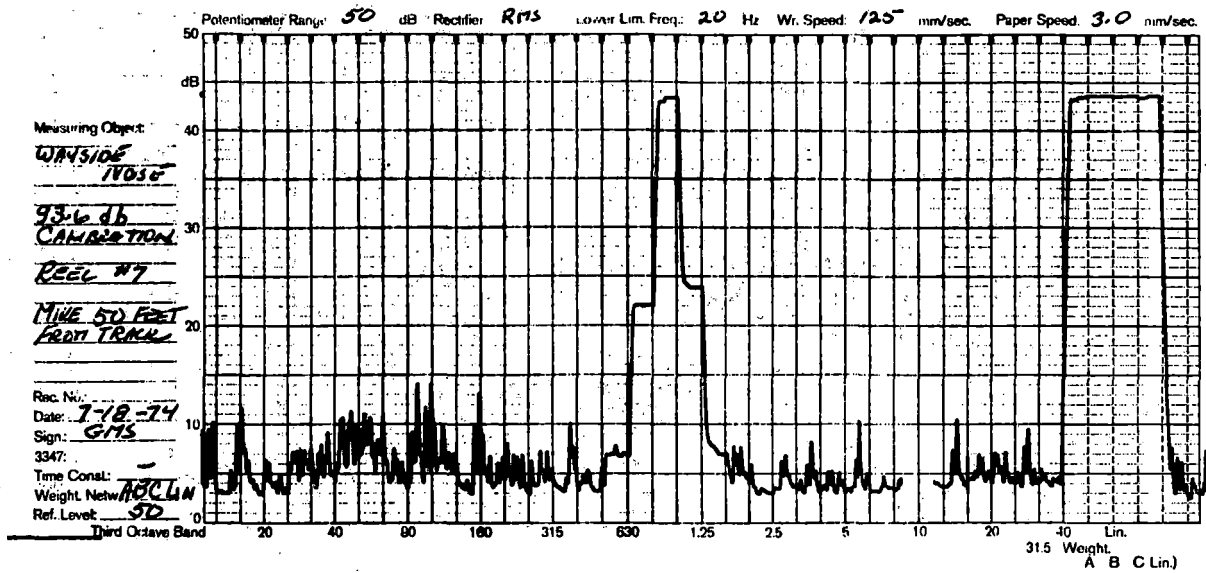

Figure 2-4. Equipment Noise Survey - Microphone 50 Feet From Track (Sheet 2)

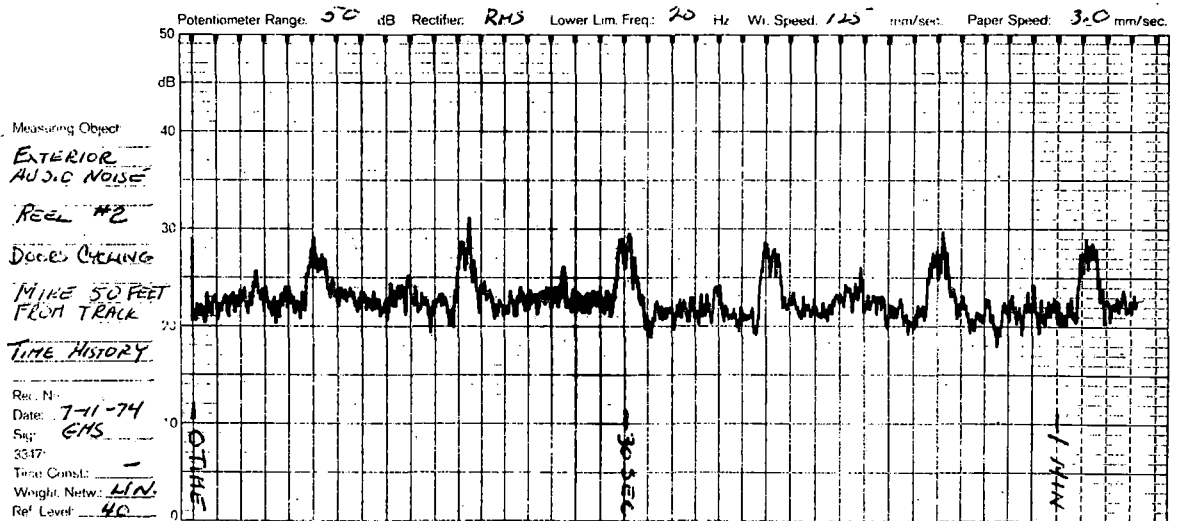
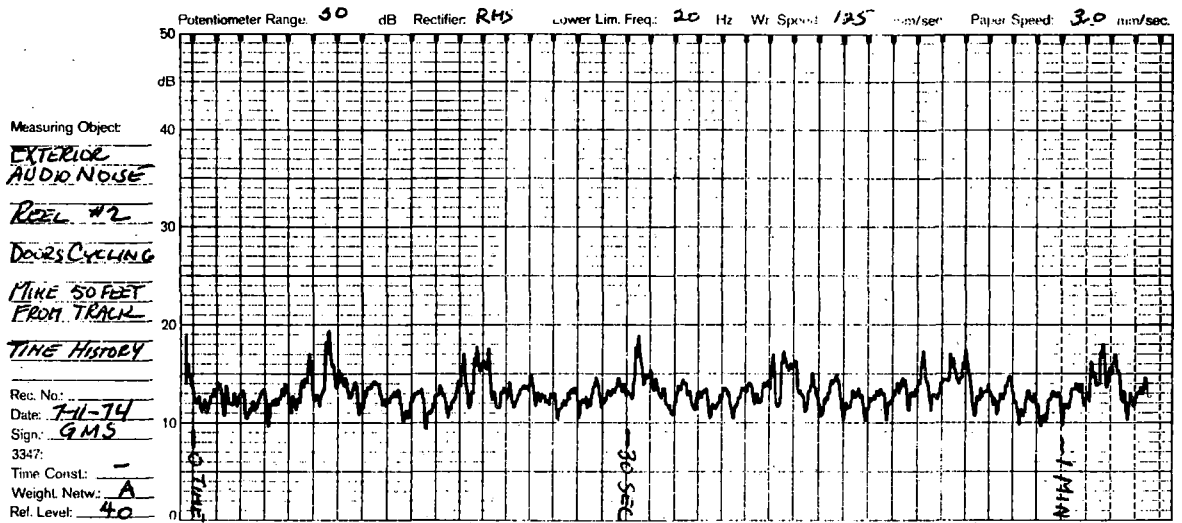

Figure 2-4. Equipment Noise Survey - Microphone 50 Feet From Track (Sheet 3)

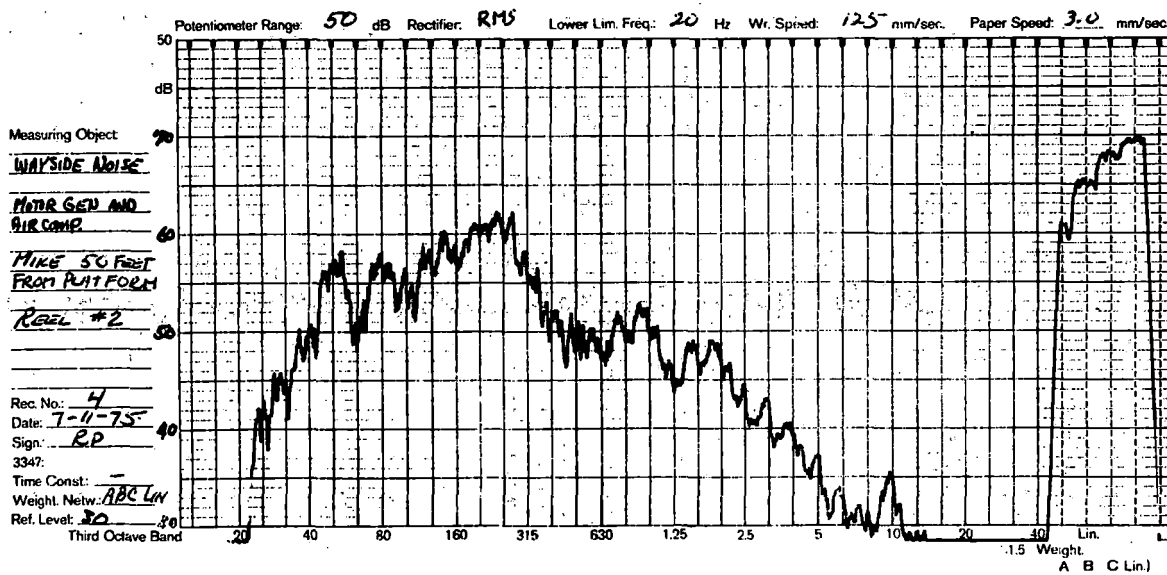
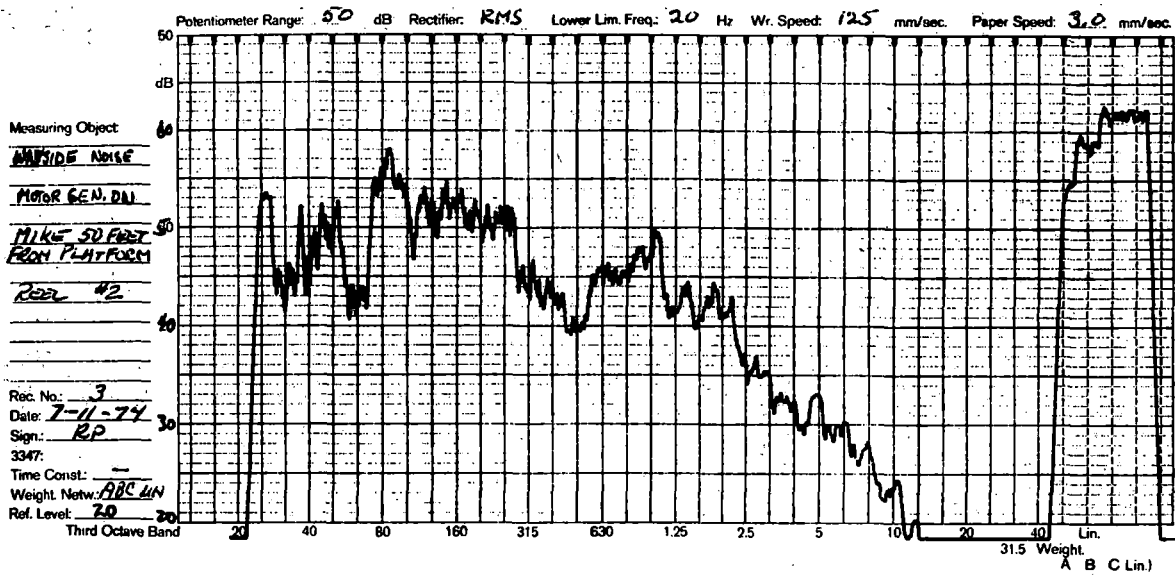

Figure 2-4. Equipment Noise Survey - Microphone 50 Feet From Track (Sheet 4)

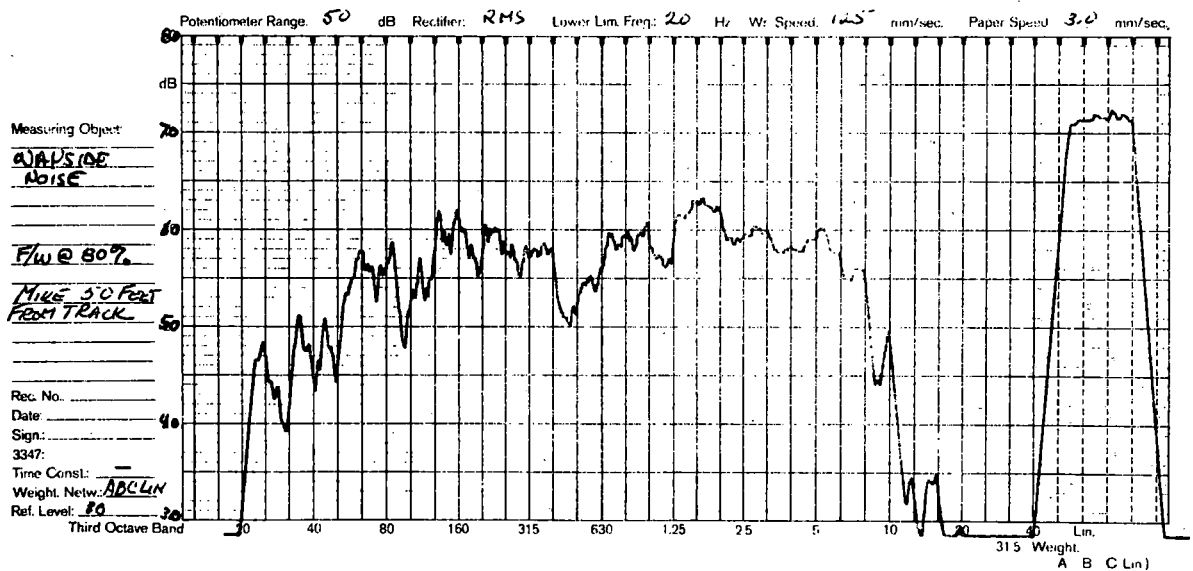
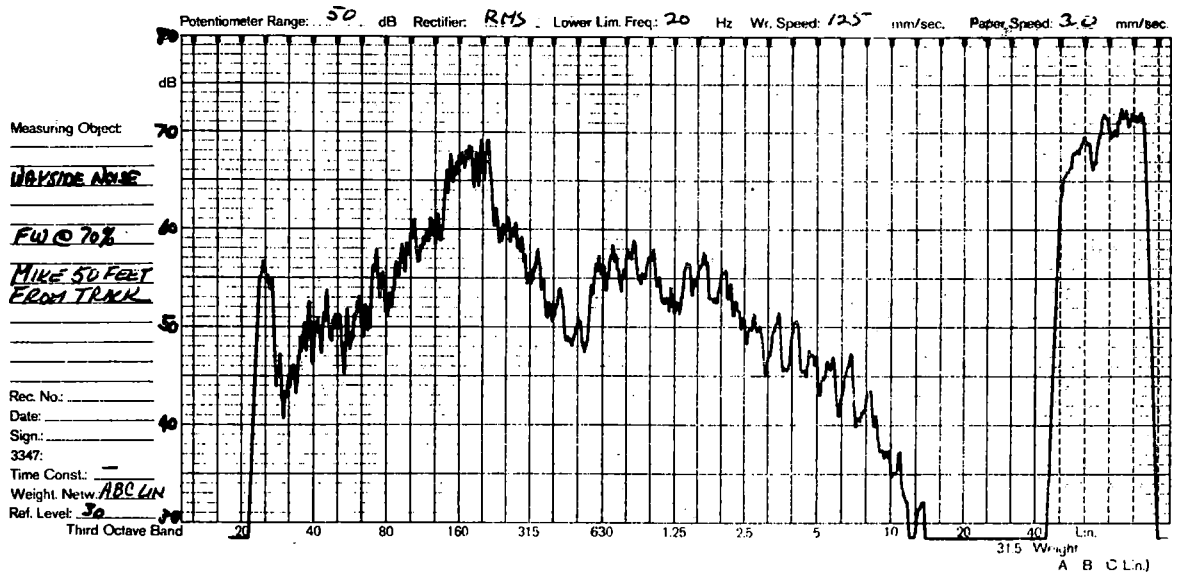

Figure 2-4. Equipment Noise Survey - Microphone 50 Feet From Track (Sheet 5)

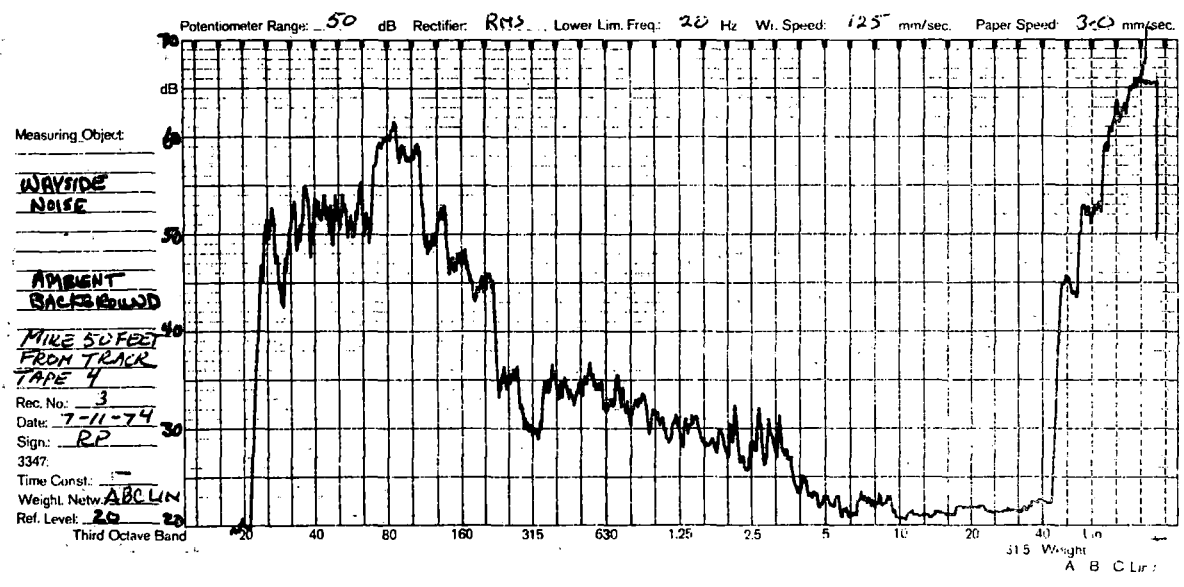
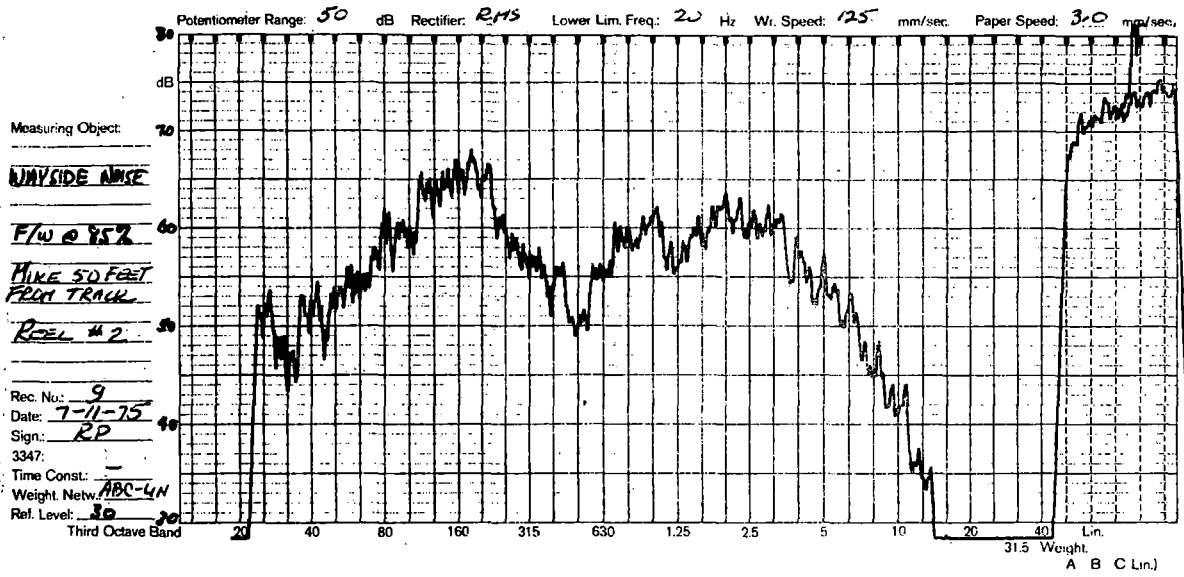

Figure 2-4. Equipment Noise Survey - Microphone 50 Feet From Track (Sheet 6)

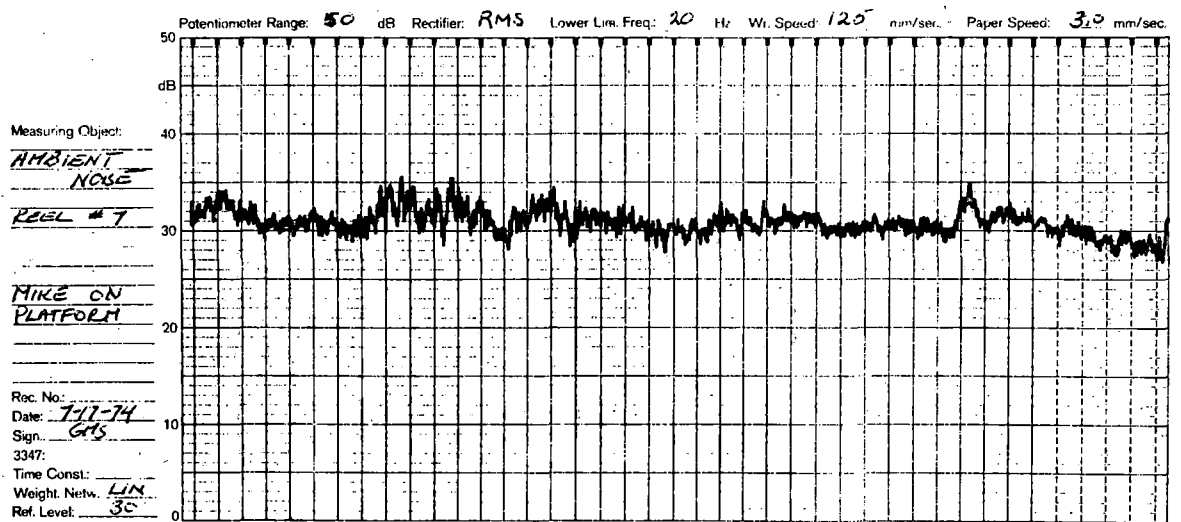
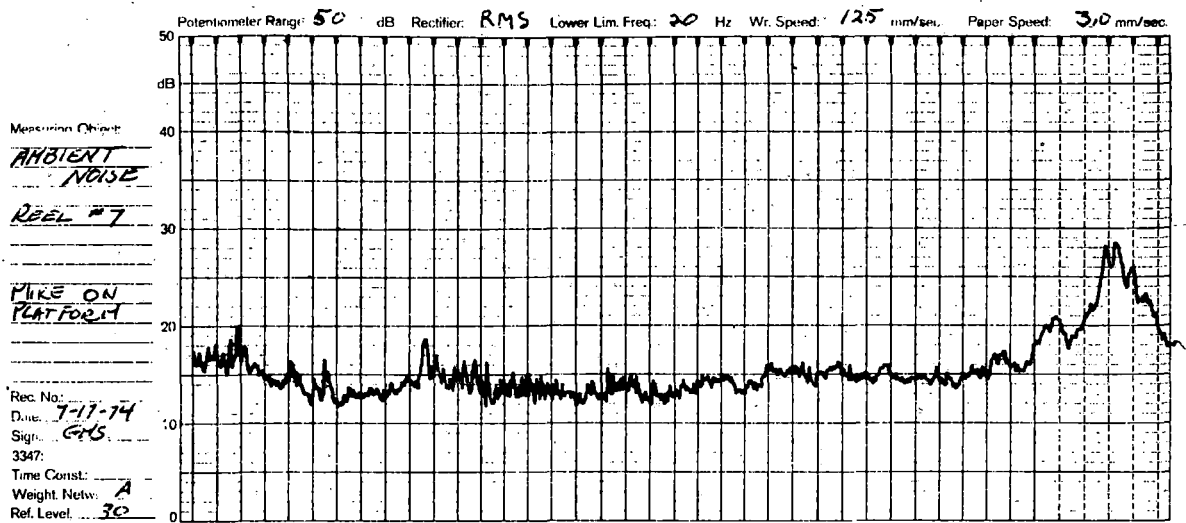

Figure 2-5. Equipment Noise Survey - Microphone On Platform (Sheet 1)

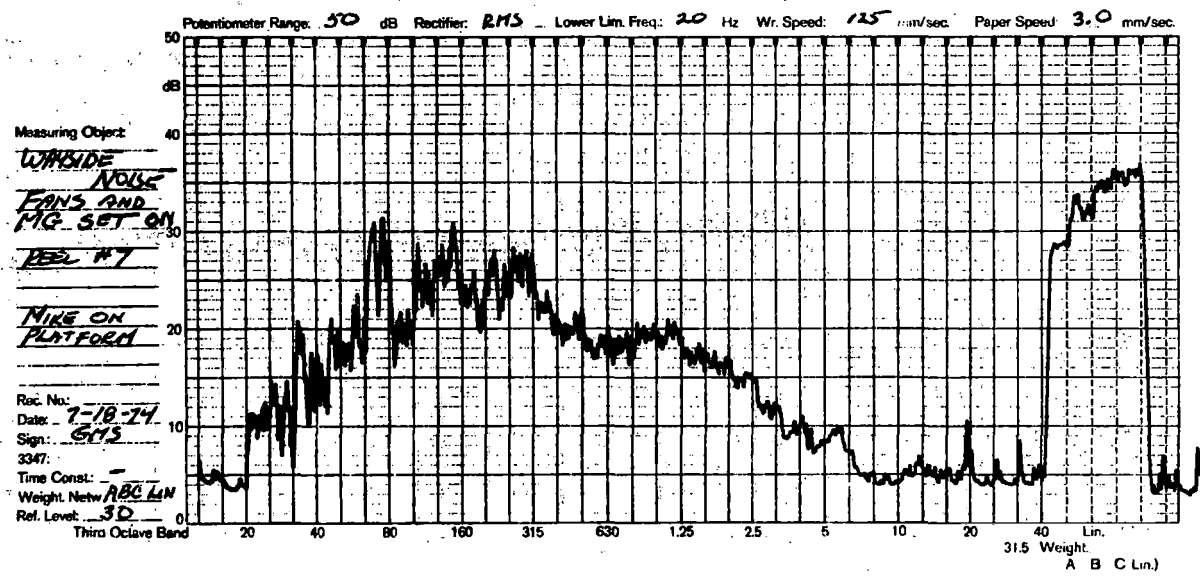
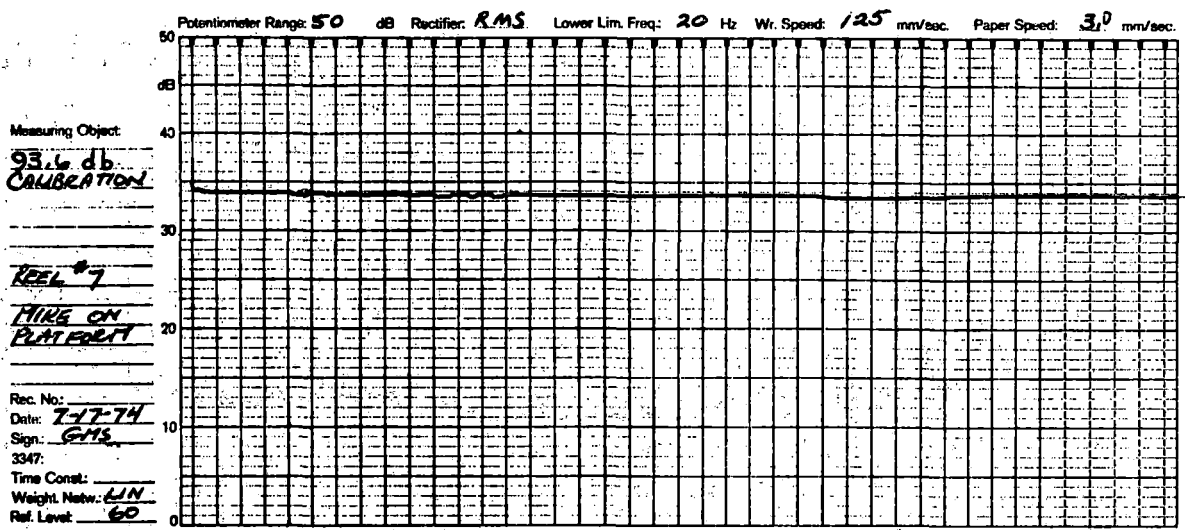

Figure 2-5. Equipment Noise Survey - Microphone On Platform (Sheet 2)

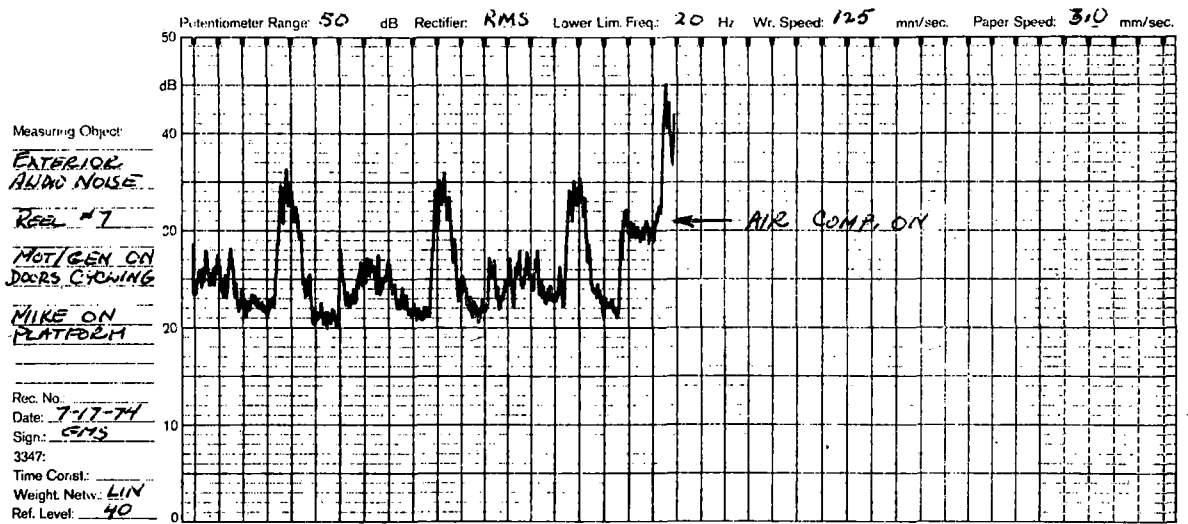
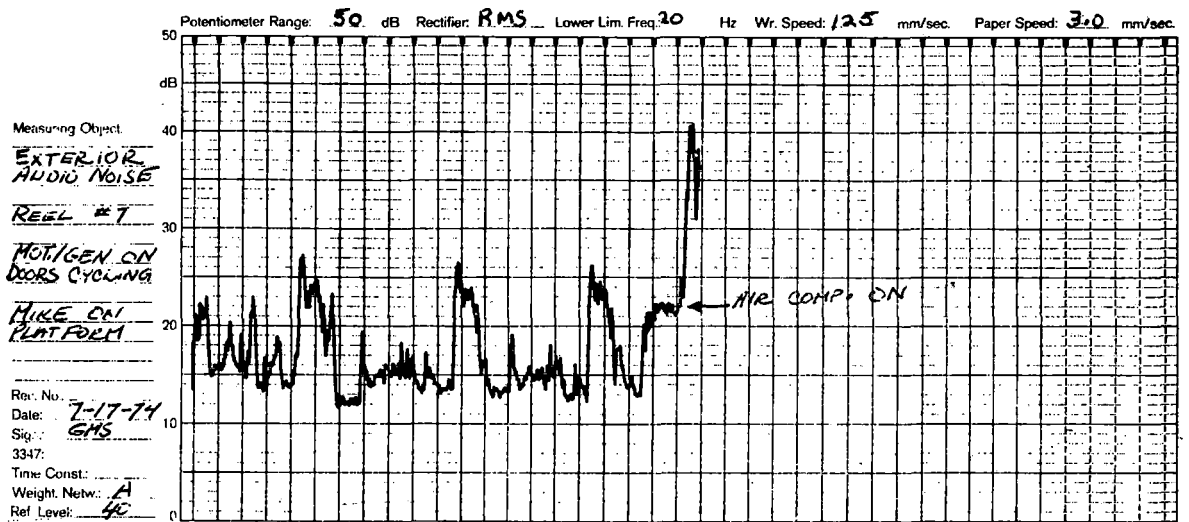

Figure 2-5. Equipment Noise Survey - Microphone On Platform (Sheet 3)

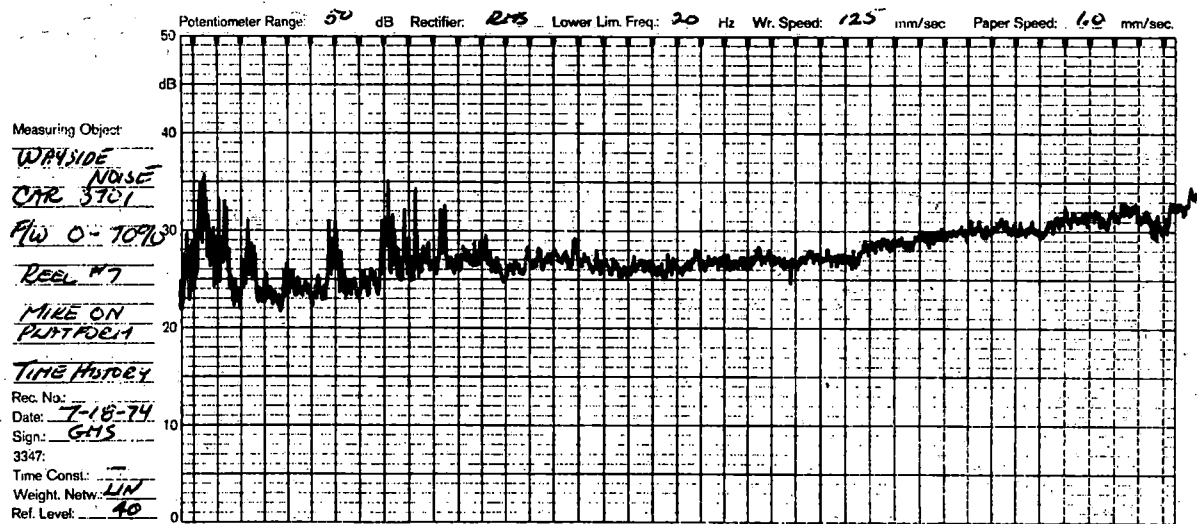
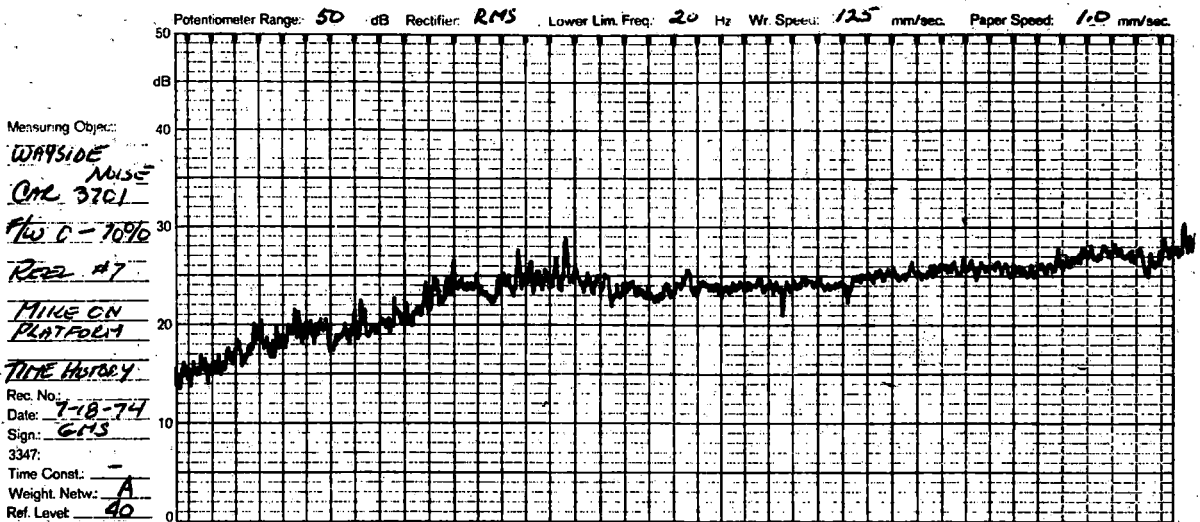

Figure 2-5. Equipment Noise Survey - Microphone On Platform (Sheet 4)

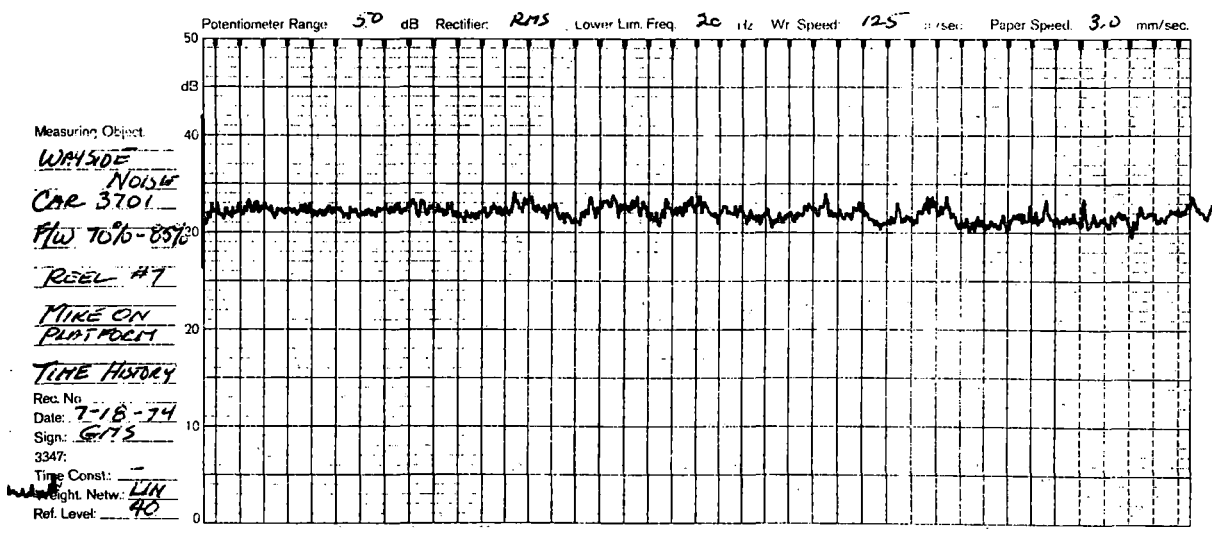
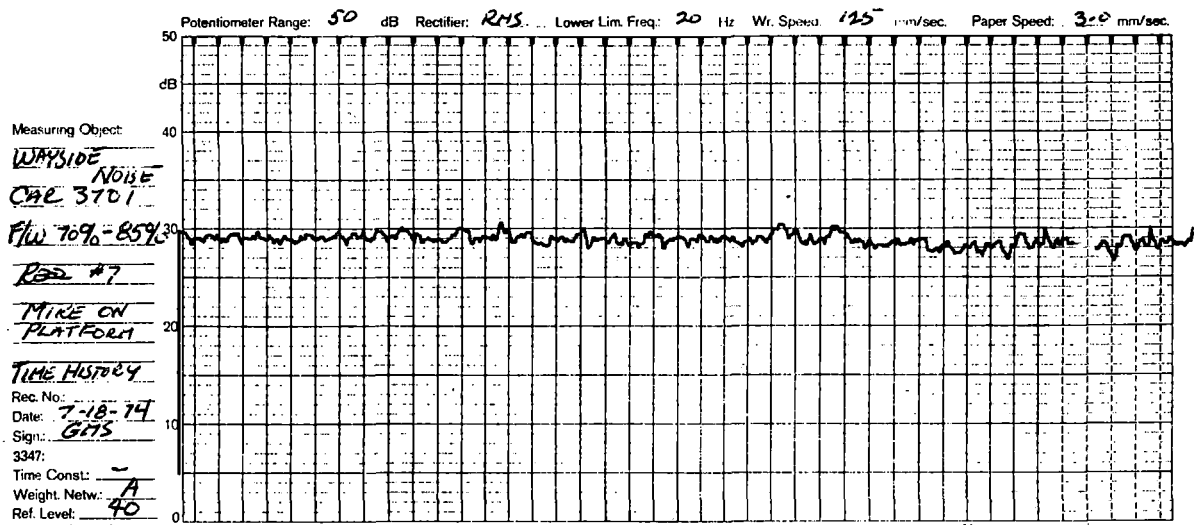

Figure 2-5. Equipment Noise Survey - Microphone On Platform (Sheet 5)

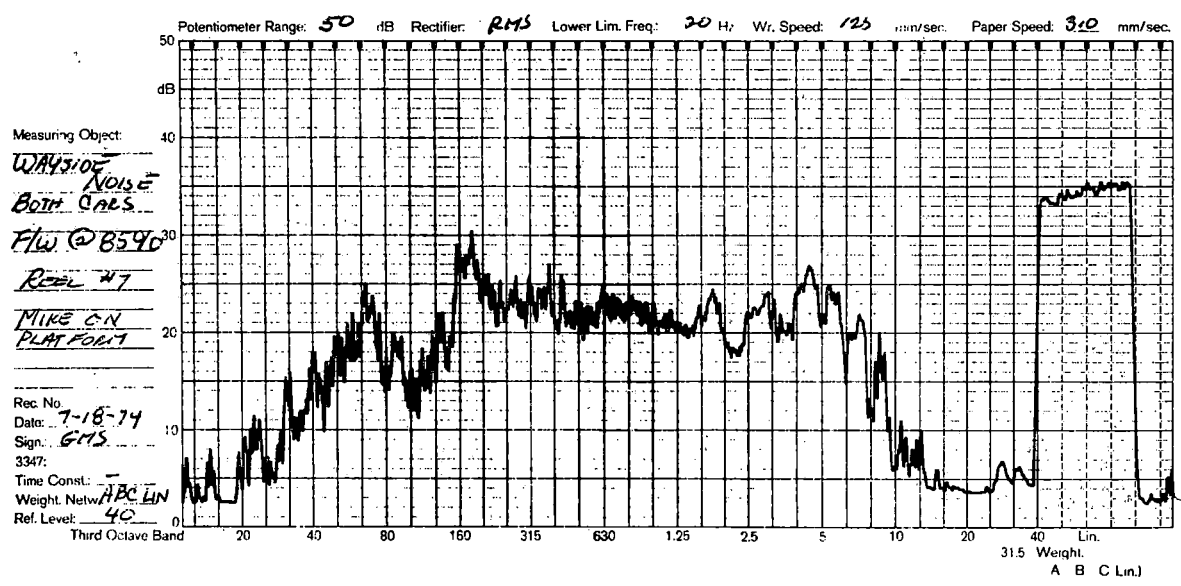
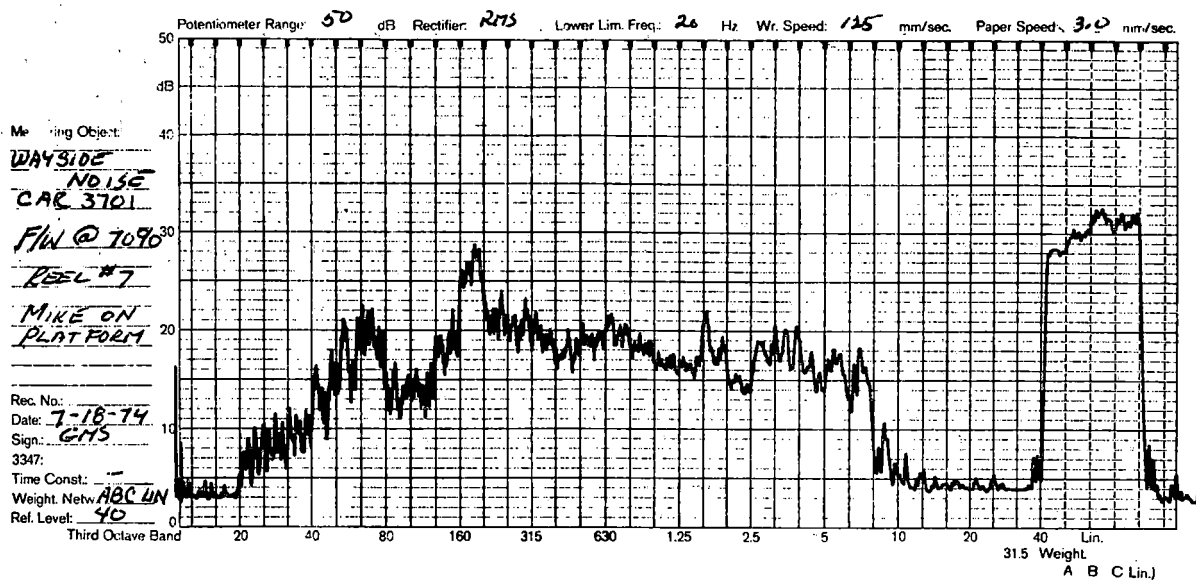

Figure 2-5. Equipment Noise Survey - Microphone On Platform (Sheet 6)

3, EXTERIOR NOISE - EFFECT OF CAR SPEED (ESC-CN-1001-TT)

3.1 SUMMARY

The exterior noise level test to determine the wayside effect of car speed was conducted in compliance with Test Set Number ESC-CN-1001-TT of the TSC General Vehicle Test Plan, GSP-064. Requirements and procedures covered by the test set are defined in paragraphs 3.1.1 through 3.2.2. Refer to paragraph 3.3 for a description of the test, instrumentation used, and for the test results.

3.1.1 TEST OBJECTIVE

To determine wayside noise levels during vehicle passbys during constant speed conditions.

3.1.2 TEST DESCRIPTION

This test will be performed at a wayside station 50 feet from the track for the following conditions:

- (a) Car weights of AW0 and AW3
- (b) Single car and multiple units
- (c) Five selected speeds

3.1.3 STATUS

The energy storage cars successfully completed the exterior car speed tests as prescribed by the conditions specified in paragraph 3.1.2. Refer to test log runs 51 through 54 presented in Volume I, Appendix C of this report.

3.2 PROCEDURES

The following test procedures are included as part of the ESC-CN-1001-TT Test Set. The ESC tests were performed generally in accordance with these procedures and any procedural differences are reflected in paragraph 3.3.

3.2.1 PRETEST PROCEDURE

- (a) Ensure that the test vehicle is in a true test configuration (no wheel flats, no missing acoustical barriers such as seats or wind-screens).
- (b) Ensure that the following weather conditions prevail:

No rain or other precipitation

Less than 90% relative humidity

Less than 10 knots wind velocity

- (c) Identify model and serial number of the noise measurement system.
- (d) Ensure that the test site is relatively free of excessive sound absorptive or obstructive characteristics.
- (e) Install a windscreen on the noise measurement microphone.
- (f) Calibrate the noise measurement system by recording a known acoustic calibration signal in order to provide a reference level. Do this at the beginning and end of the test, but at least twice on each test data tape.
- (g) Record ambient noise, including both acoustical background and electrical noise of the measurement system.
- (h) Record barometric pressure, relative humidity and ambient temperature at beginning of test.

CAUTION

1. Caution test crew on maintaining integrity of the noise test data.
2. Position recording microphone such that it is not shielded from the source of noise.
3. Record wind velocity and direction prior to each test point.
4. The direction of motion of the Test Vehicle will be the same for all test points.

3.2.2 TEST PROCEDURE

- (a) Select five discrete speeds within the normal operating speed range at the test vehicle.
- (b) Set-up the noise measurement system at Track Station 156 on the outside of the loop at a distance of 50 feet and 5 feet above the rail.
- (c) Start the recorder prior to the passby of the test vehicle and identify the test point, location, amplifier gain level and ambient weather conditions by voice.
- (d) Have the test vehicle operate up to one of the selected test speeds. Timing should be such that the vehicle is up to speed 10 seconds prior to passing microphone and should maintain speed for 10 seconds beyond the microphone.
- (e) Repeat steps c and d for each of the five selected speeds.

NOTE

Repeat the test point at a mid-speed three times (to ensure repeatable test data).

CAUTION

The direction of motion of the car will be the same for all passbys.

OPTION 1 Repeat the above procedure for another car weight.

OPTION 2 Repeat the above procedure for various train consists.

3.3 TEST DESCRIPTION AND RESULTS

The energy storage car (ESC) exterior noise effect of car speed tests were conducted in accordance with AiResearch Document 73-9373 as defined in paragraph 3.1.3 and in compliance with GSP-064 Test Set ESC-CN-1001-TT, described in paragraphs 3.1.1 and 3.1.2.

3.3.1 DESCRIPTION

The ESC exterior noise effect of car speed tests were performed using the procedures described in paragraph 3.2. With microphones located on the platform and at 50 feet from the track, recordings were made to measure the noise generated by the energy storage system as the cars accelerated away from the platform while maintaining speeds of approximately 10, 20, and 40 mph and when full service braking was applied.

3.3.2 INSTRUMENTATION

Block diagrams of the data acquisition system and the data recovery system are provided in figures 1-1 and 1-2. Details of the instrumentation related to the exterior noise effect of car speed tests is shown in figure 1-4. Information concerning instrumentation for overall data acquisition for the energy storage car tests is described in Volume I of this report.

3.3.3 RESULTS

Representative samples of test results covering acceleration away from platform, passing platform at 10, 20, and 40 mph and full service brake application from 40 mph are shown in figure 3-1, sheets 1 through 6. Noise level recording of the car accelerating away from the platform is shown in sheet 1; passing the platform at test speeds, sheets 2 through 4; brake application from 40 mph, sheet 5; and calibration levels, sheets 6.

The time history plots of exterior noise are shown on a linear scale for db and time. It may be noted that some of these plots were written on log frequency paper, but they are in fact run on a linear time scale, as marked. The plots were run in sets, one with no filter, one with an A scale filter and one frequency plot. The summary data is derived from the maximum levels of the A scale plots for train passing platform.

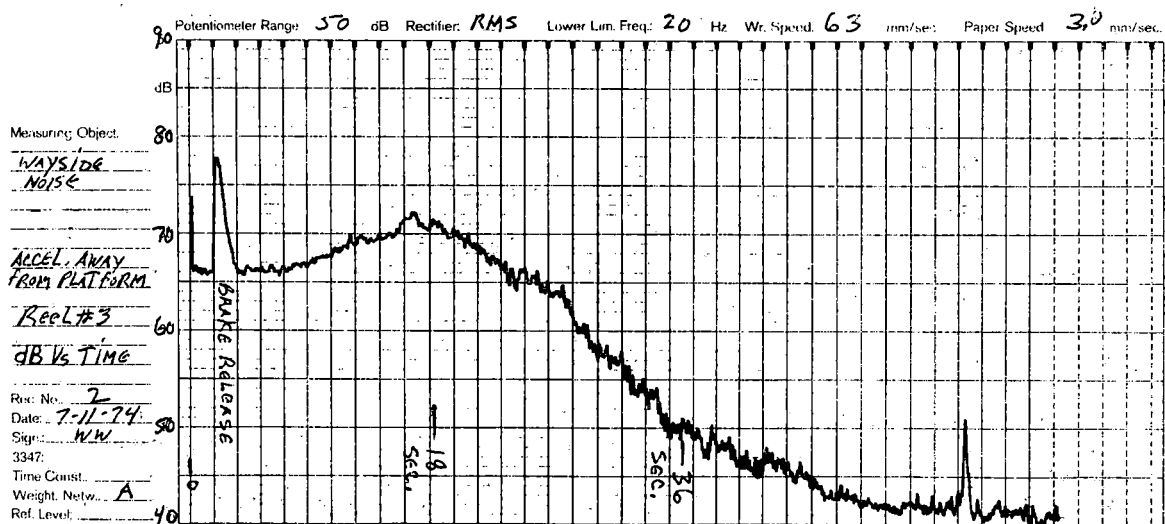
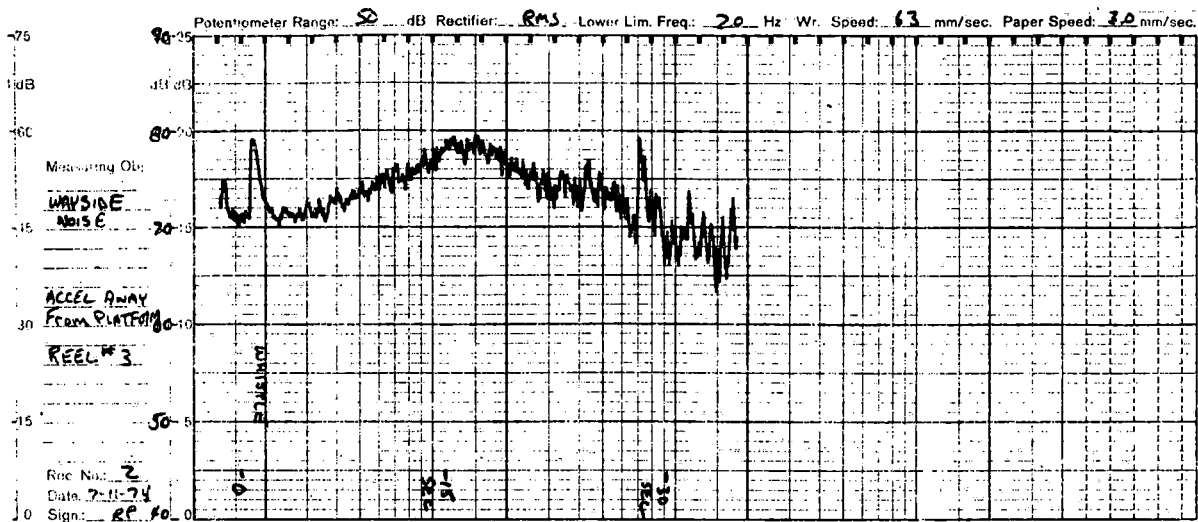

Figure 3-1. Exterior Noise Test - Effect of Car Speed (Sheet 1)

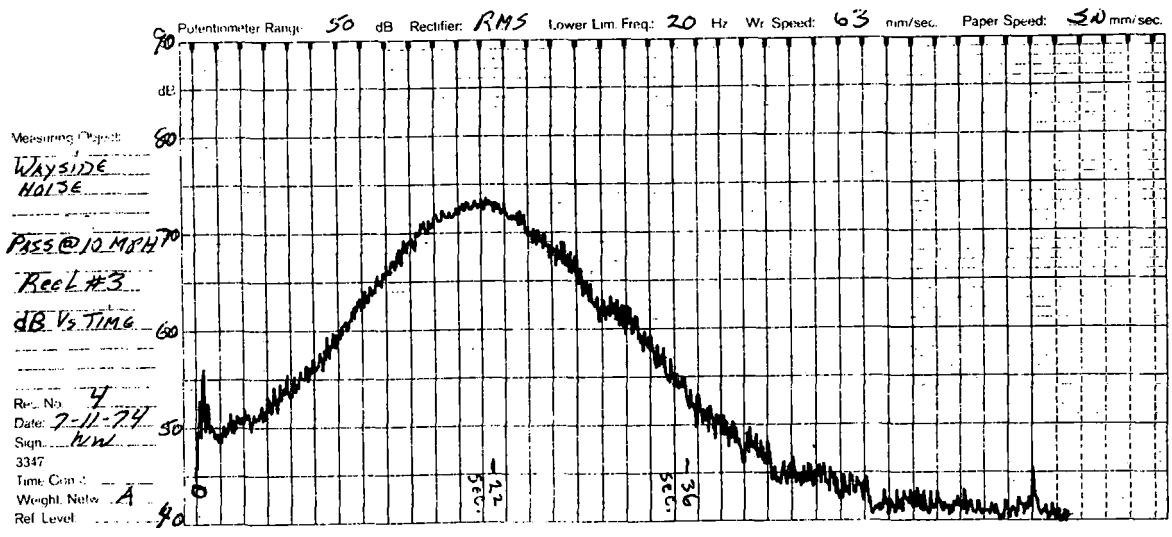
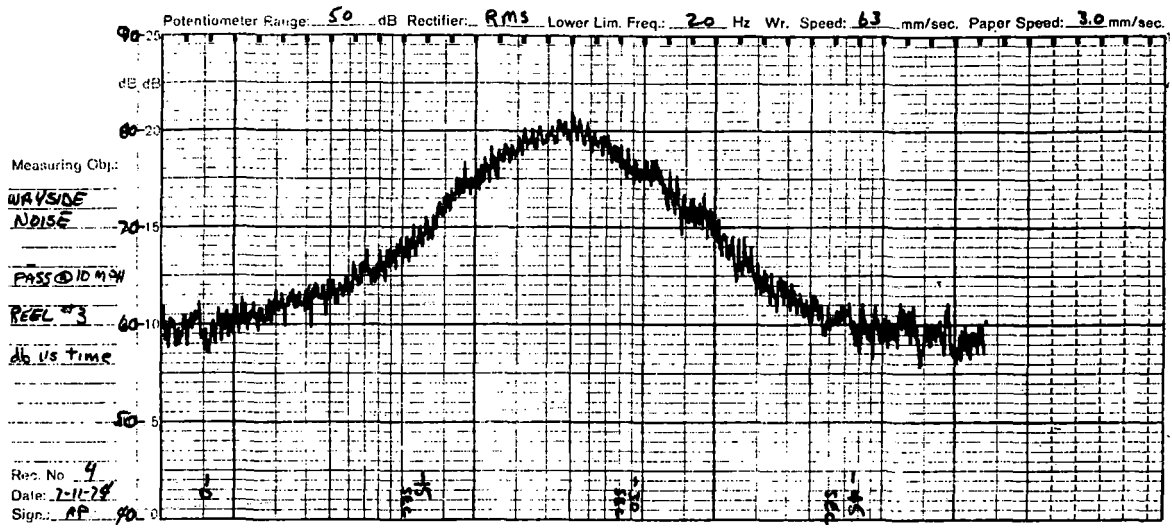

Figure 3-1. Exterior Noise Test - Effect of Car Speed (Sheet 2)

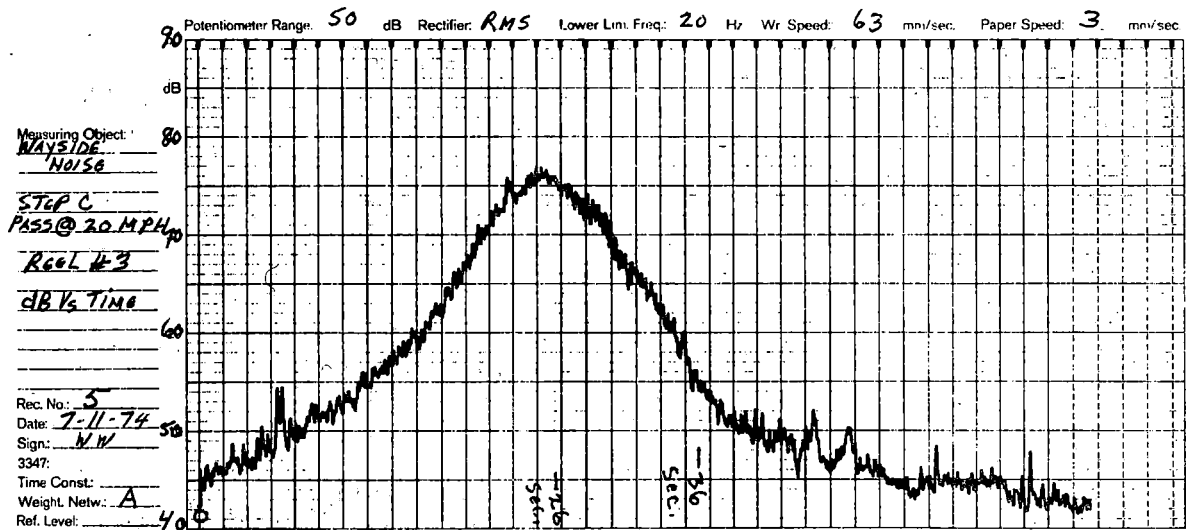
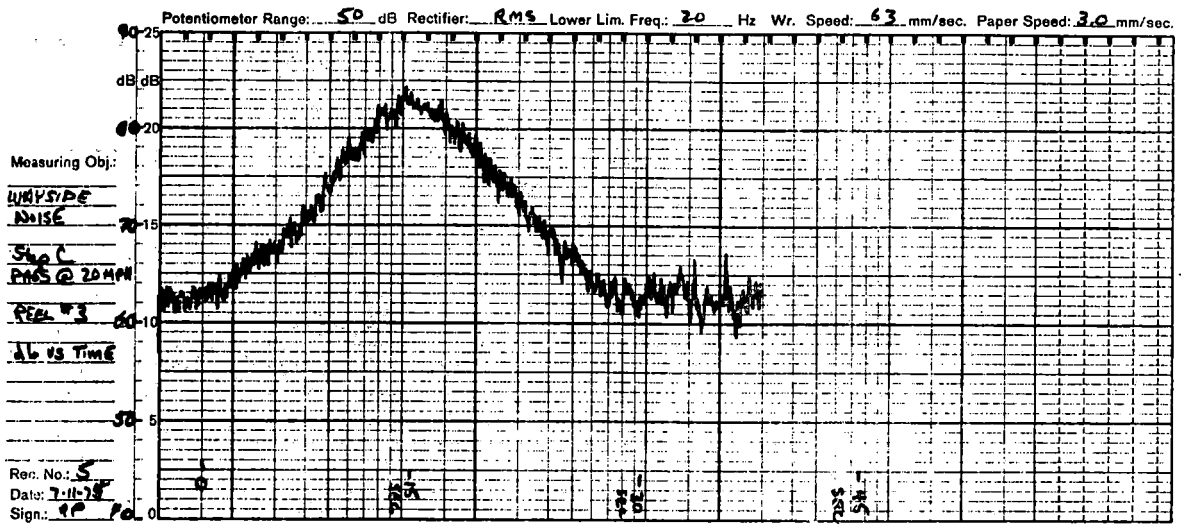

Figure 3-1. Exterior Noise Test - Effect of Car Speed (Sheet 3)

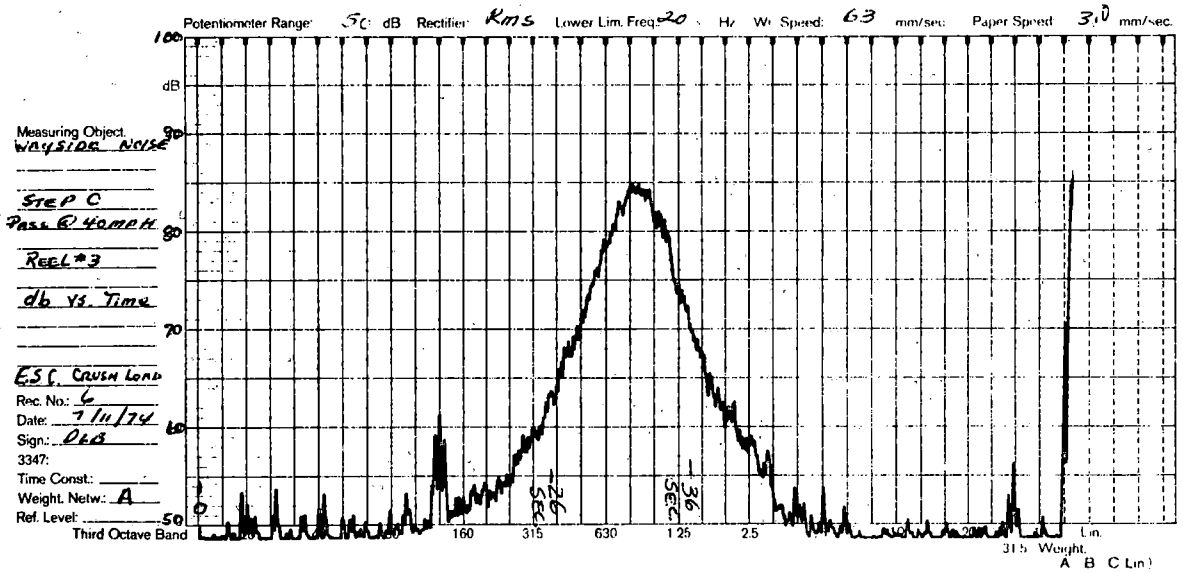
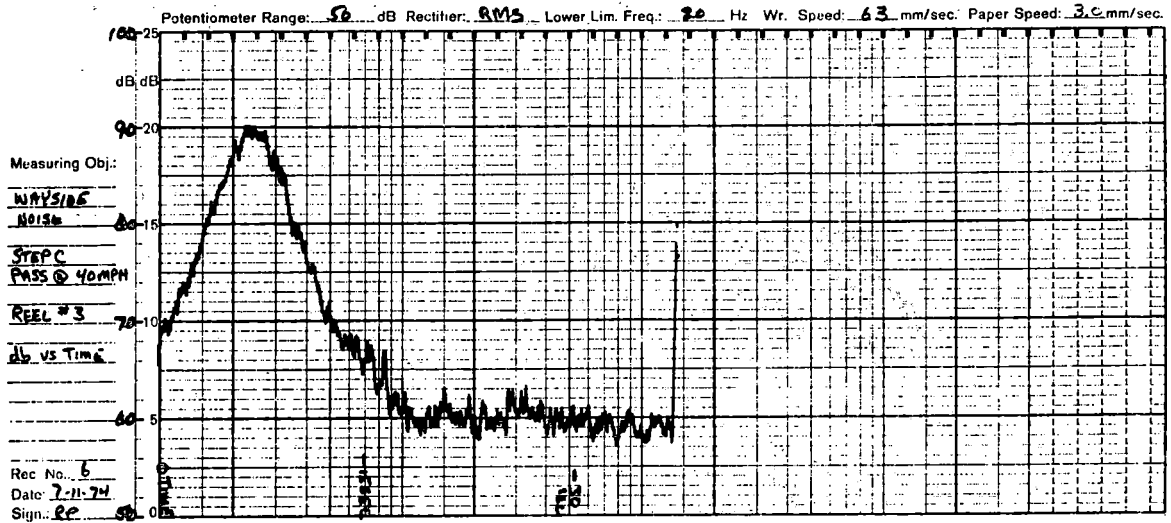

Figure 3-1. Exterior Noise Test - Effect of Car Speed (Sheet 4)

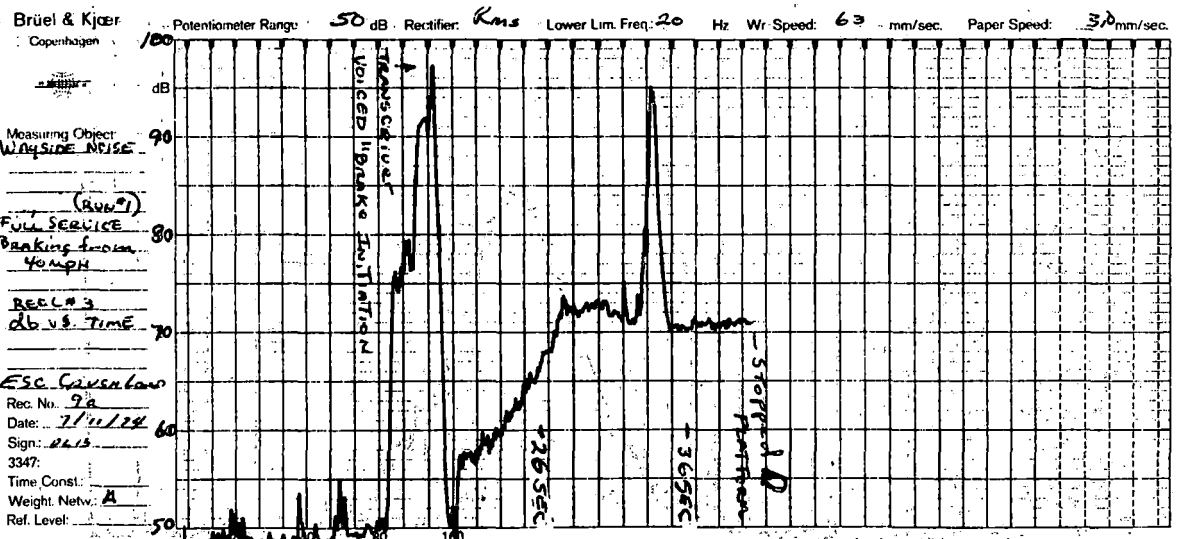
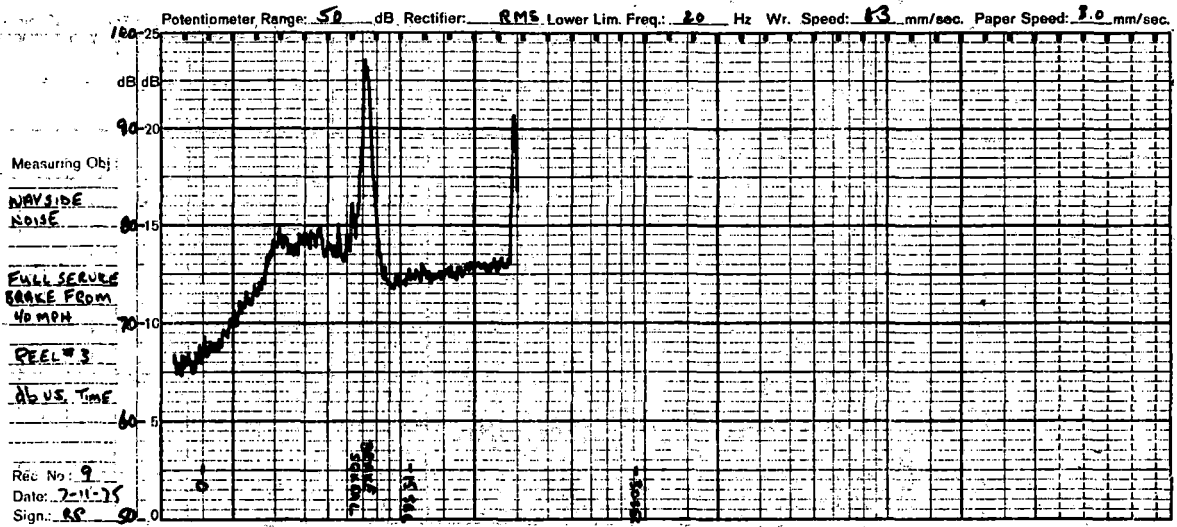

Figure 3-1: Exterior Noise Test - Effect of Car Speed (Sheet 5)

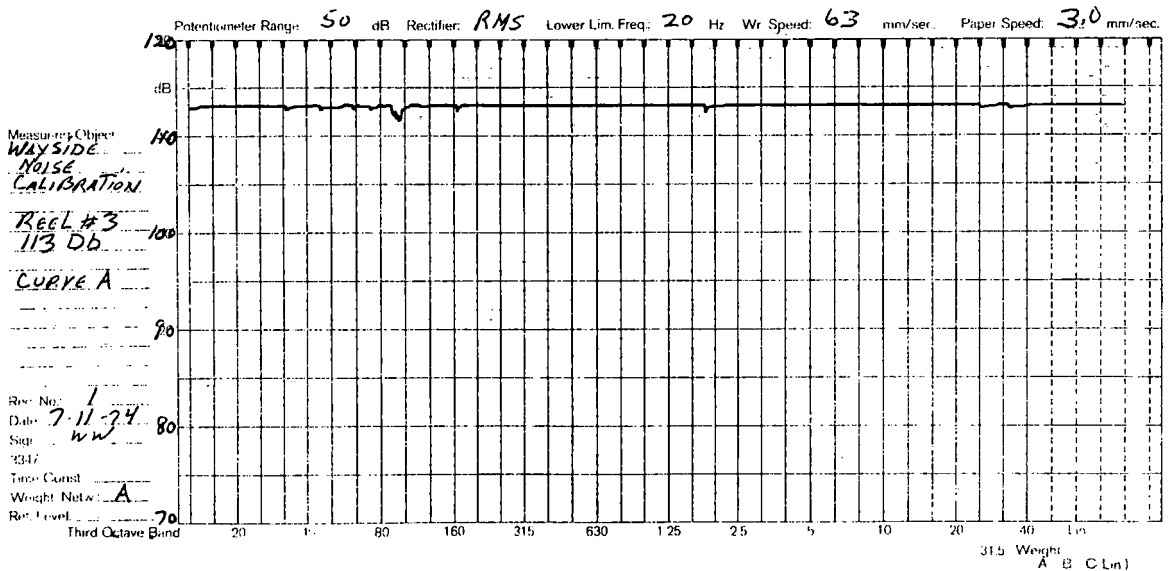
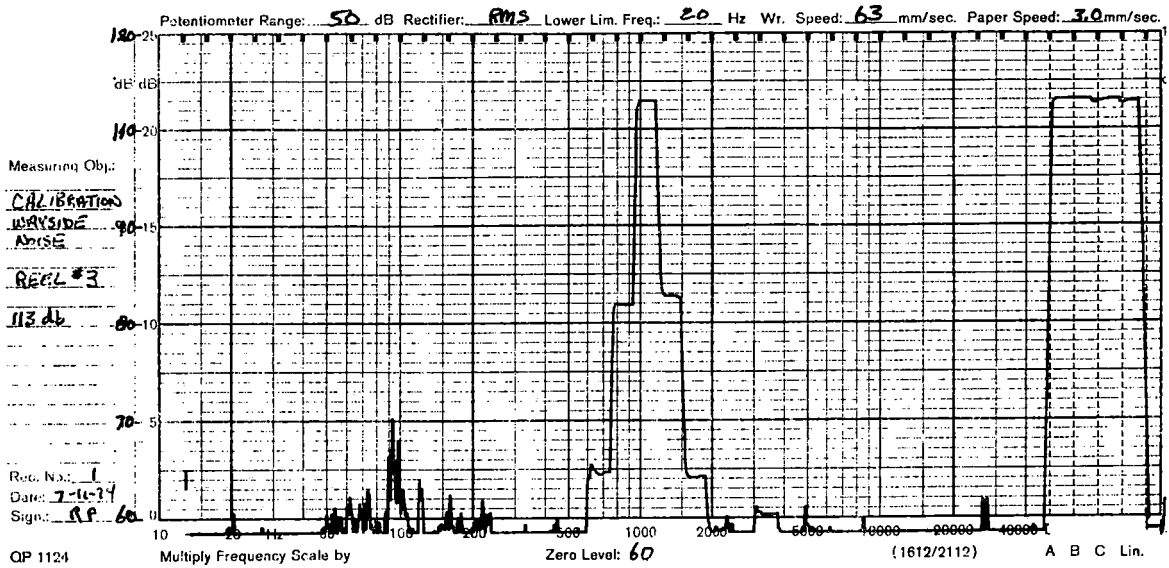

Figure 3-1. Exterior Noise Test - Effect of Car Speed (Sheet 6)

4. INTERIOR NOISE - EFFECT OF CAR SPEED (ESC-PN-1001-TT)

4.1 SUMMARY

The interior noise level test to determine the on-car effect of car speed was conducted in compliance with Test Set Number ESC-PN-1001-TT of the TSC General Vehicle Test Plan, GSP-064. Requirements and procedures covered by the test set are defined in paragraphs 4.1.1 through 4.2.2. Refer to paragraph 4.3 for a description of the test, instrumentation used, and for the test results.

4.1.1 TEST OBJECTIVE

To determine noise levels inside the test vehicle while operating at various speeds.

4.1.2 TEST DESCRIPTION

This test will be performed at the following conditions:

- (a) Car weights of AW0 and AW3
- (b) Four car interior locations
- (c) Five car speeds

4.1.3 STATUS

The energy storage cars successfully completed the interior car speed tests as prescribed by the conditions specified in paragraph 4.1.2. Refer to test log run 72 presented in Volume I, Appendix C of this report.

4.2 PROCEDURES

The following test procedures are included as part of the ESC-PN-1001-TT Test Set. The ESC tests were performed generally in accordance with these procedures and any procedural differences are reflected in paragraph 4.3.

4.2.1 PRETEST PROCEDURE

- (a) Ensure that the test vehicle is in a true test configuration (no wheel flats, no missing acoustical barriers such as seats or windscreens).
- (b) Ensure that the following weather conditions prevail:
 - No rain or other precipitation
 - Less than 90% relative humidity
 - Less than 10 knots wind velocity

- (c) Identify model and serial number of the noise measurement system.
- (d) Ensure that the test site is relatively free of excessive sound absorptive or obstructive characteristics.
- (e) Install a windscreen on the noise measurement microphone.
- (f) Calibrate the noise measurement system by recording a known acoustic calibration signal in order to provide a reference level. Do this at the beginning and end of the test, but at least twice on each test data tape.
- (g) Record ambient noise, including both acoustical background and electrical noise of the measurement system.
- (h) Record barometric pressure, relative humidity and ambient temperature at beginning of test.

CAUTION

1. Caution test crew on maintaining integrity of the noise test data.
2. Position recording microphone such that it is not shielded from the source of noise.
3. Record wind velocity and direction prior to each test point.
4. The direction of motion of the test vehicle will be the same for all test points.

4.2.2 TEST PROCEDURE

- (a) Select the 4-car interior locations (these test points should be representative of standing or seated passengers throughout the test vehicle).
- (b) Select five test vehicle speeds, representative of the normal operating speed range.
- (c) Operate the test vehicle at the test speed over track section I. Repeat passes over section I until data has been obtained for the 4 car locations.
- (d) For each test point, identify the test point and record gain level on the recorder by voice, and obtain a minimum of 15 seconds of data.
- (e) Repeat steps c and d for each car interior location.
- (f) Repeat steps c through e for each test speed.

OPTION 1 Repeat the above procedure for another test vehicle weight.

4.3 TEST DESCRIPTION AND RESULTS

The energy storage car (ESC) interior noise effect of car speed tests were conducted in accordance with AiResearch Document 73-9373 as defined in paragraph 4.3.1 and in compliance with GSP-064 Test Set ESC-PN-001-TT, described in paragraphs 4.1.1 and 4.1.2.

4.3.1 DESCRIPTION

Using the procedures described in paragraph 4.2, the ESC were driven over Section I of the test track at approximately 40 mph and amplitude versus frequency plots were obtained from the outputs of microphones placed over the flywheel at the number one and number two ends of car 3701 and from a microphone located five feet from the car floor at the center point of the car.

4.3.2 INSTRUMENTATION

Block diagrams of the data acquisition system and the data recovery system are provided in figures 1-1 and 1-2. Details of the instrumentation related to the interior noise effect of car speed tests is shown in figure 1-5. Information concerning instrumentation for overall data acquisition for the energy storage car tests is described in Volume I of this report.

4.3.3 RESULTS

A representative sample of the data plots obtained during the interior noise effect of car speed tests are shown in figure 4-1, sheets 1 and 2.

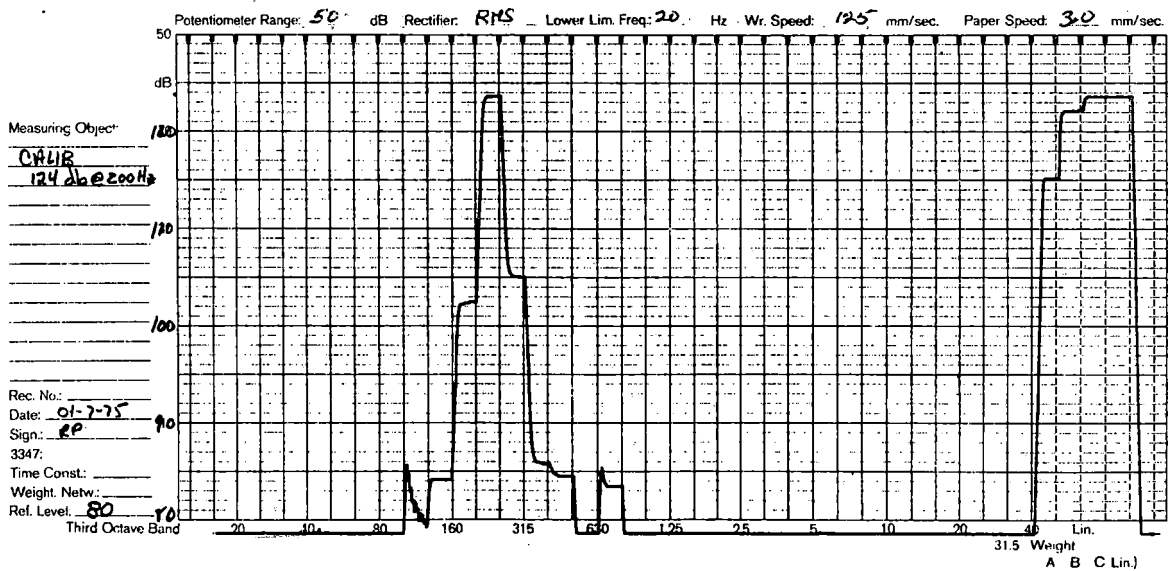
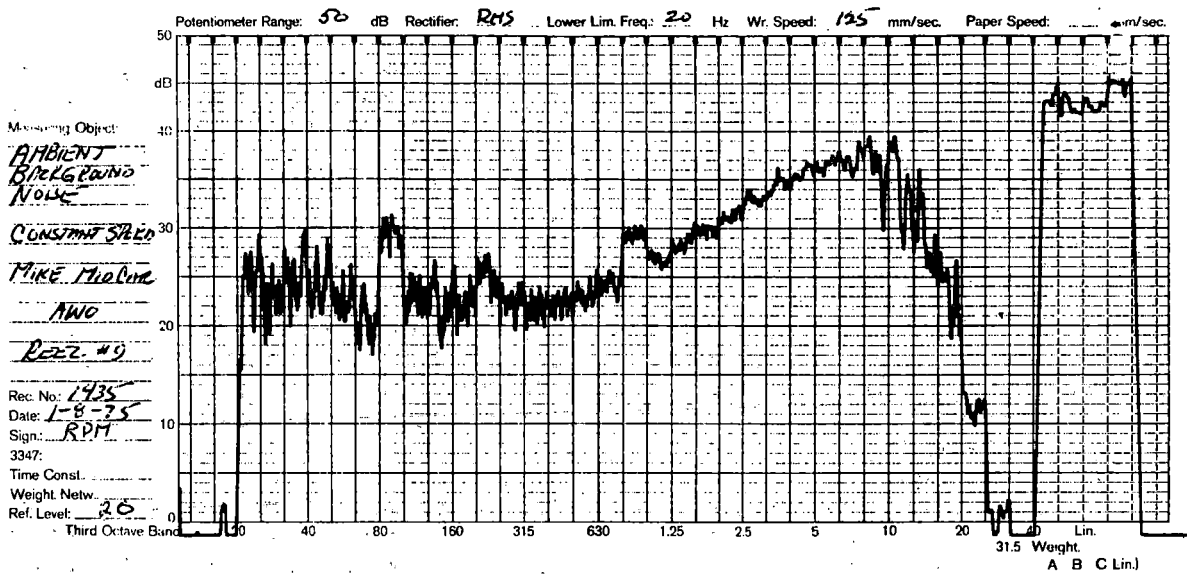

Figure 4-1. Interior Noise Test - Effect of Car Speed (Sheet 1)

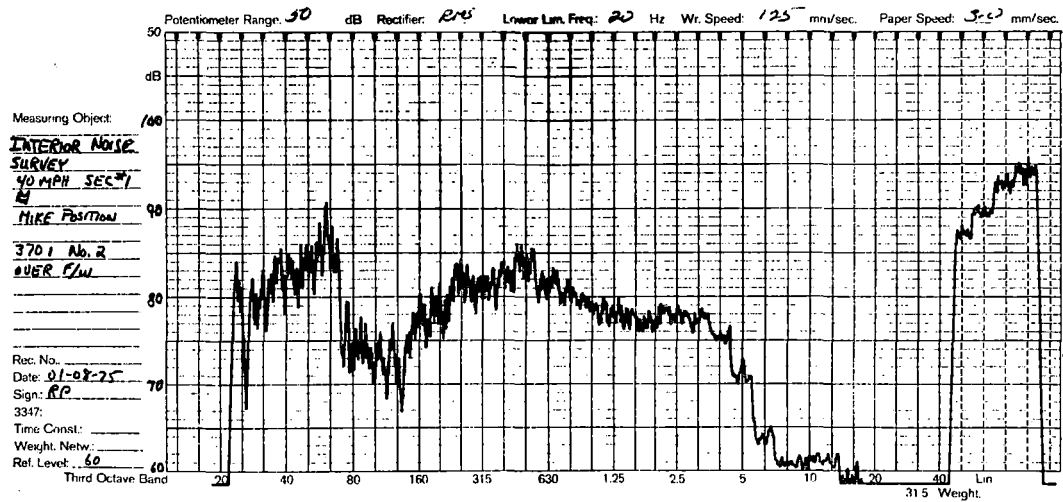
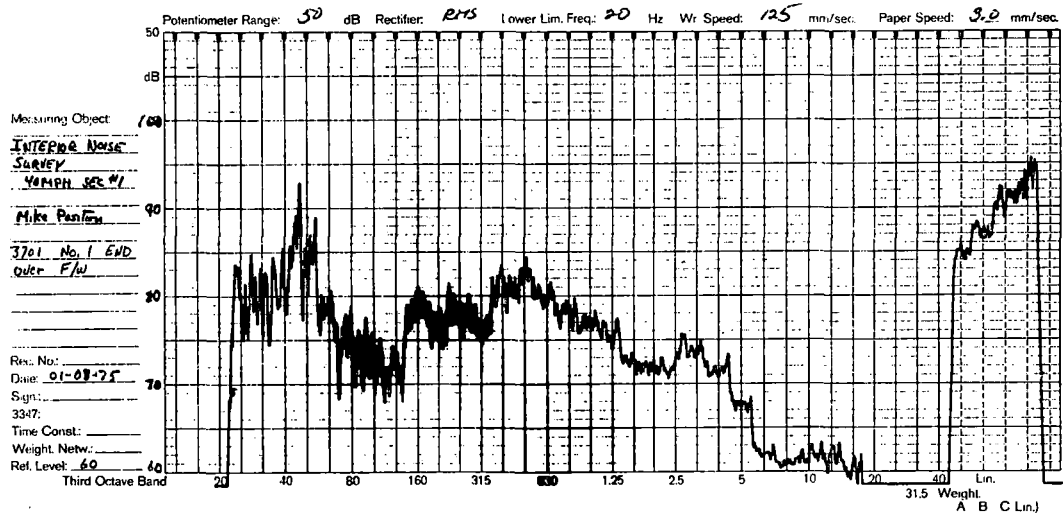
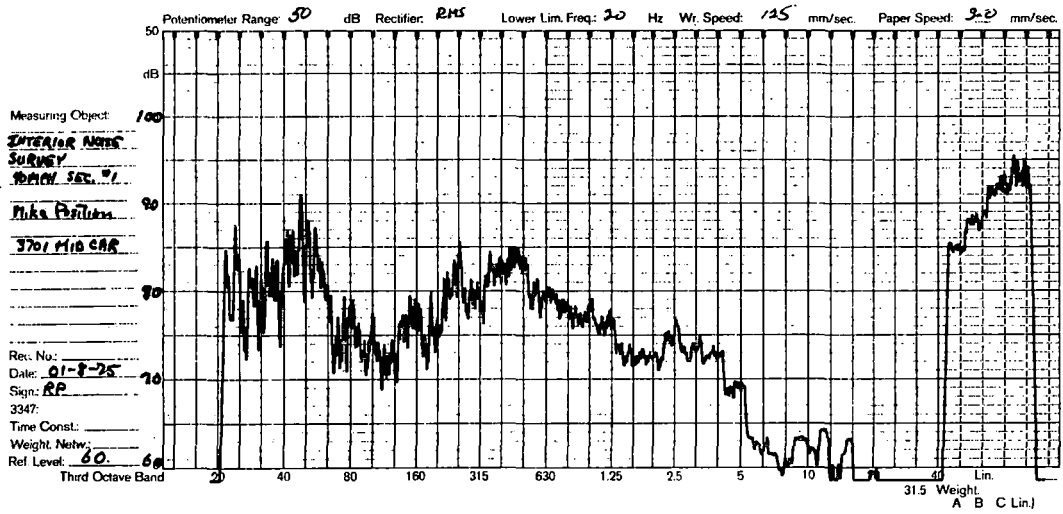

Figure 4-1. Interior Noise Test - Effect of Car Speed (Sheet 2)

5, INTERIOR NOISE - EFFECT OF TRACK SECTION (ESC-PN-1101-TT)

5.1 SUMMARY

The interior noise level test to determine the on-car effect of track section was conducted in compliance with Test Set Number ESC-PN-1101-TT of the TSC General Vehicle Test Plan, GSP-064. Requirements and procedures covered by the test set are defined in paragraphs 5.1.1 through 5.2.2. Refer to paragraph 5.3 for a description of the test, instrumentation used, and for the test results.

5.1.1 TEST OBJECTIVE

To determine the effect of track construction on interior noise levels.

5.1.2 TEST DESCRIPTION

This test will be performed at one test vehicle weight (AWO) and one speed on all sections of the UMTA test track.

5.1.3 STATUS

The energy storage cars successfully completed the track section tests as prescribed by the conditions specified in paragraph 5.1.2. Refer to test log run 72 presented in Volume I, Appendix C of this report.

5.2 PROCEDURES

The following test procedures are included as part of the ESC-PN-1101-TT Test Set. The ESC tests were performed generally in accordance with these procedures and any procedural differences are reflected in paragraph 5.3.

5.2.1 PRETEST PROCEDURE

(a) Ensure that the test vehicle is in a true test configuration (no wheel flats, no missing acoustical barriers such as seats or windscreens).

(b) Ensure that the following weather conditions prevail:

No rain or other precipitation

Less than 90% relative humidity

Less than 10 knots wind velocity

- (c) Identify model and serial number of the noise measurement system.
- (d) Ensure that the test site is relatively free of excessive sound absorptive or obstructive characteristics.
- (e) Install a windscreen on the noise measurement microphone.
- (f) Calibrate the noise measurement system by recording a known acoustic calibration signal in order to provide a reference level. Do this at the beginning and end of the test, but at least twice on each test data tape.
- (g) Record ambient noise, including both acoustical background and electrical noise of the measurement system.
- (h) Record barometric pressure, relative humidity and ambient temperature at beginning of test.

CAUTION

1. Caution test crew on maintaining integrity of the noise test data.
2. Position recording microphone such that it is not shielded from the source of noise.
3. Record wind velocity and direction prior to each test point.
4. The direction of motion of the Test Vehicle will be the same for all test points.

5.2.2 TEST PROCEDURE

- (a) Select a car interior location, representative of a typical passenger position as the test location.
- (b) Select a test vehicle speed, representative of a high normal operation as the test speed.
- (c) Instruct the test vehicle operator to announce the entering and leaving of the various track sections.
- (d) Operate the test vehicle at the test speed continuously around the test track.
- (e) For each test section, identify the test point and record gain level on the recorder by voice and obtain a minimum of 15 seconds of noise data.

5.3 TEST DESCRIPTION AND RESULTS

The energy storage car (ESC) interior noise effect of track section tests were conducted in accordance with AIResearch Document 74-10441 as defined in paragraph 5.3.1 and in compliance with GSP-064 Test Set ESC-PN-1101-TT, described in paragraphs 5.1.1 and 5.1.2.

5.3.1 DESCRIPTION

Using the procedures described in paragraph 5.2, the ESC were driven over the test track at approximately 40 mph and time history plots were obtained from the output of a microphone placed over the flywheel at the number two end of the car.

5.3.2 INSTRUMENTATION

Block diagrams of the data acquisition system and the data recovery system are provided in figures 1-1 and 1-2. Details of the instrumentation related to the interior noise effect of track section is shown in figure 1-5. Information concerning instrumentation for overall data acquisition for the energy storage car tests is described in Volume I of this report.

5.3.3 RESULTS

A representative sample of the interior noise track effect test results are presented in figure 5-1, sheets 1 through 6. Each sheet shows a time history of a different section of track recorded as the cars were driven at a constant speed of 40 mph.

The time history plots of the track section are shown on a linear scale for db and time. The plots were run in sets, one with no filter, one with an A scale filter and one frequency plot.

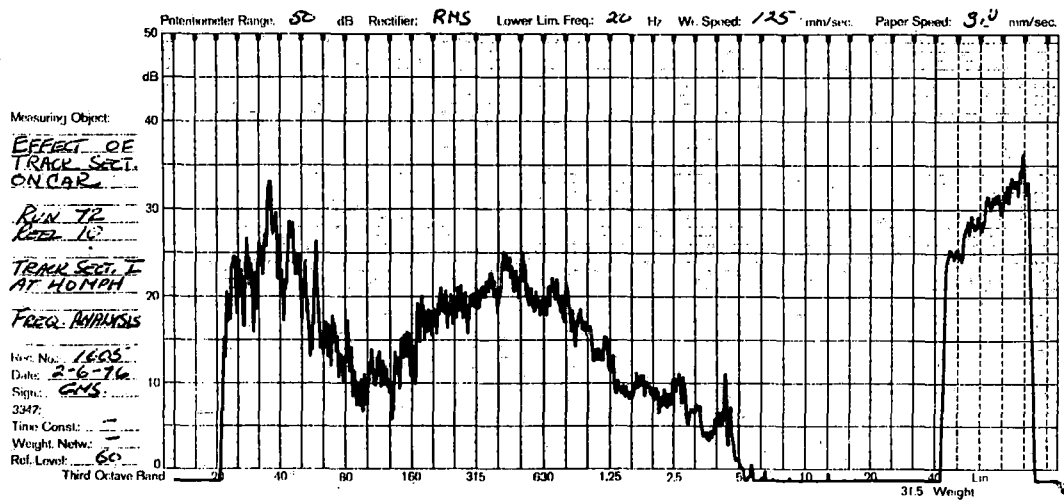
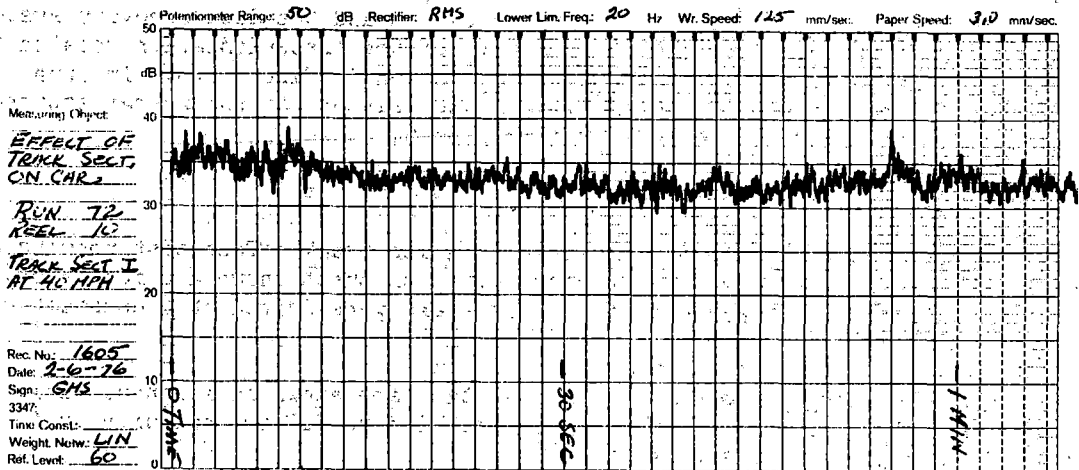
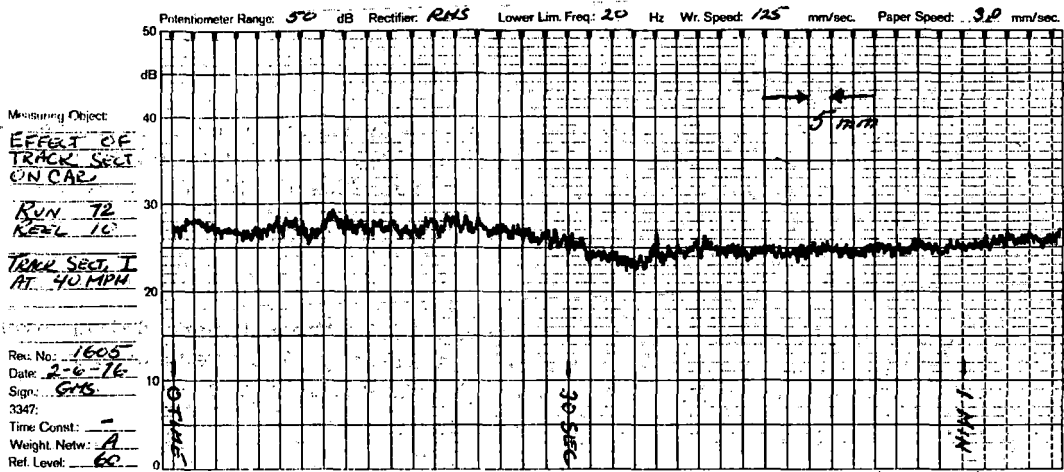

Figure 5-1. Interior Noise Test - Effect of Track Section (Sheet 1)

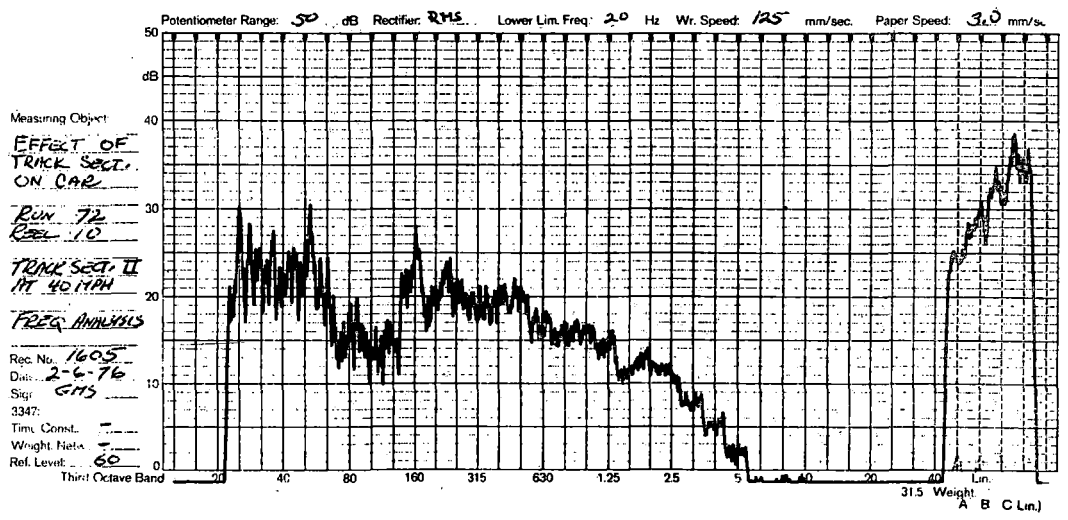
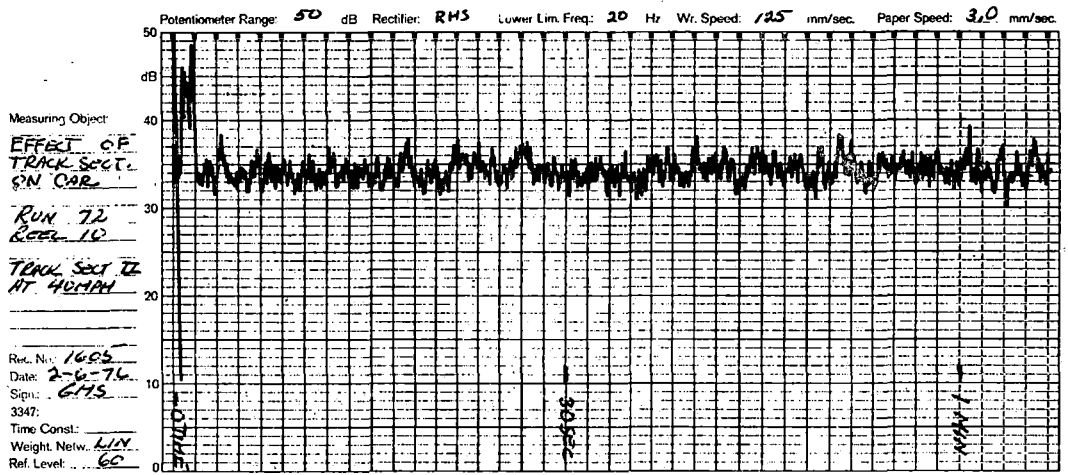
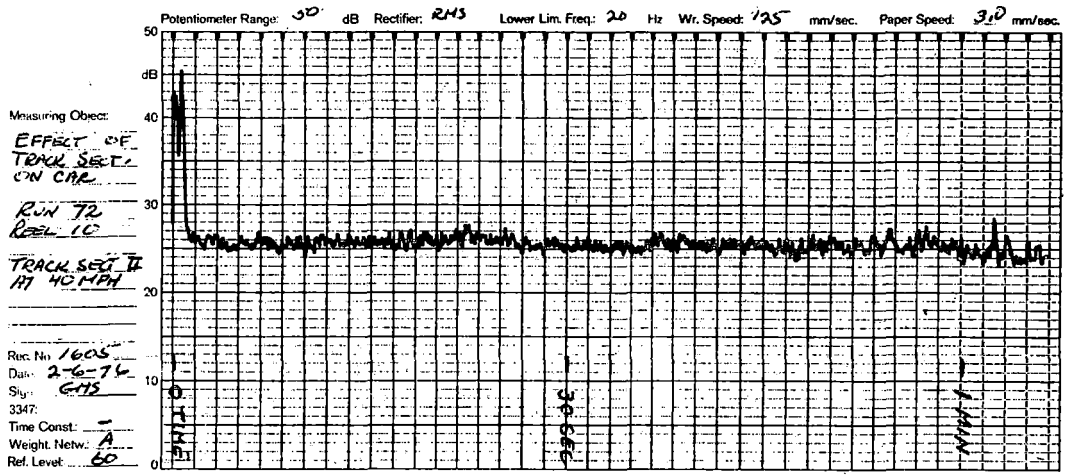

Figure 5-1. Interior Noise Test - Effect of Track Section (Sheet 2)

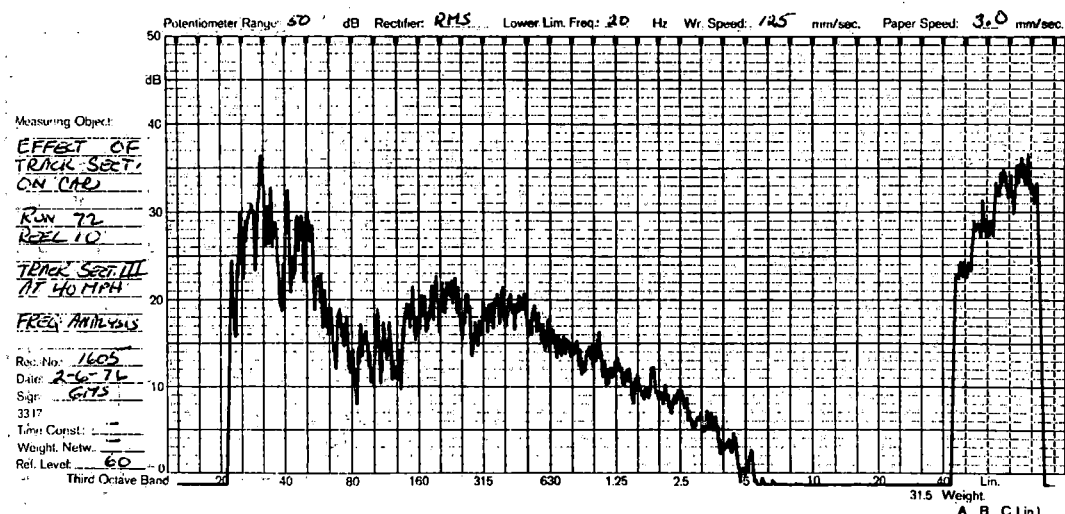
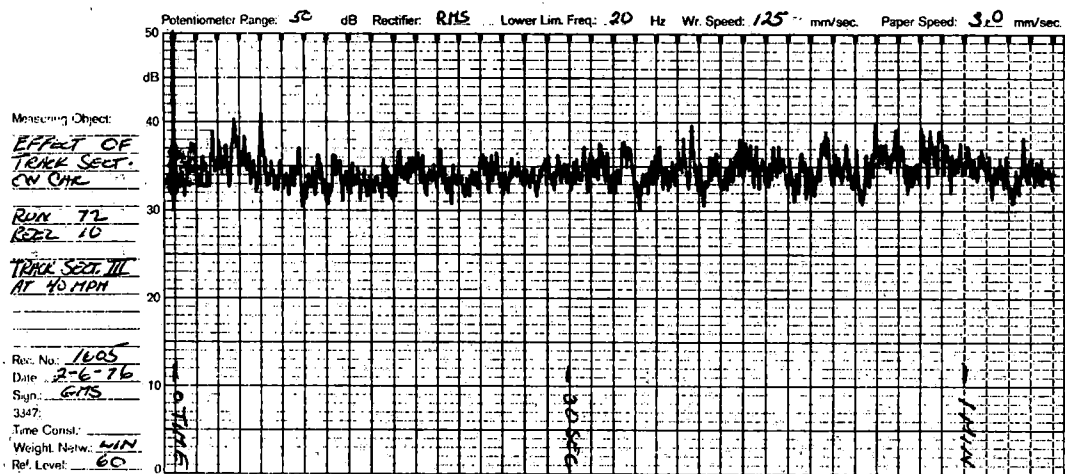
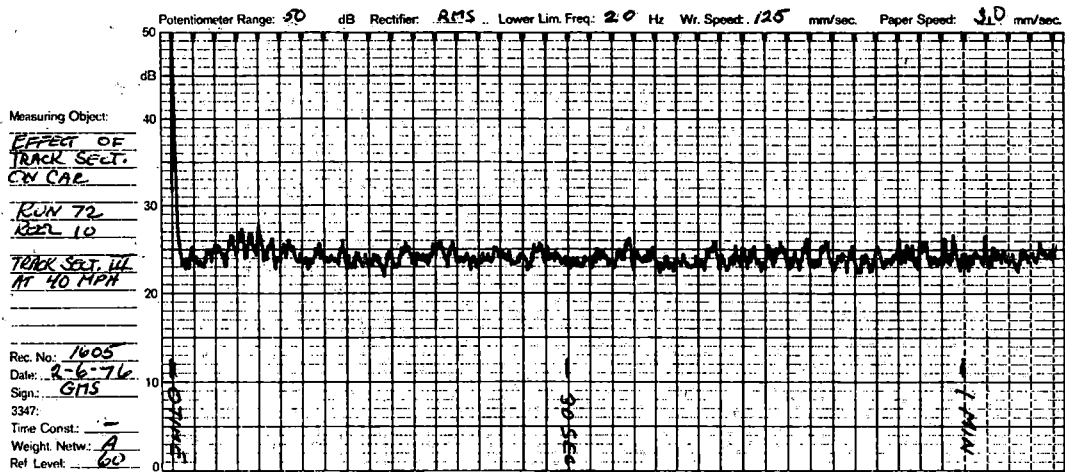

Figure 5-1. Interior Noise Test - Effect of Track Section (Sheet 3)

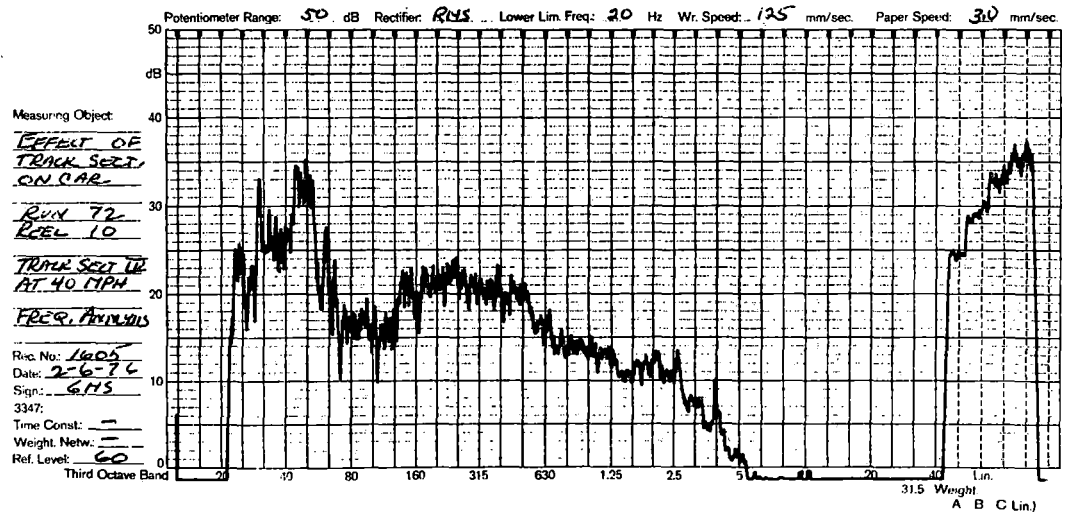
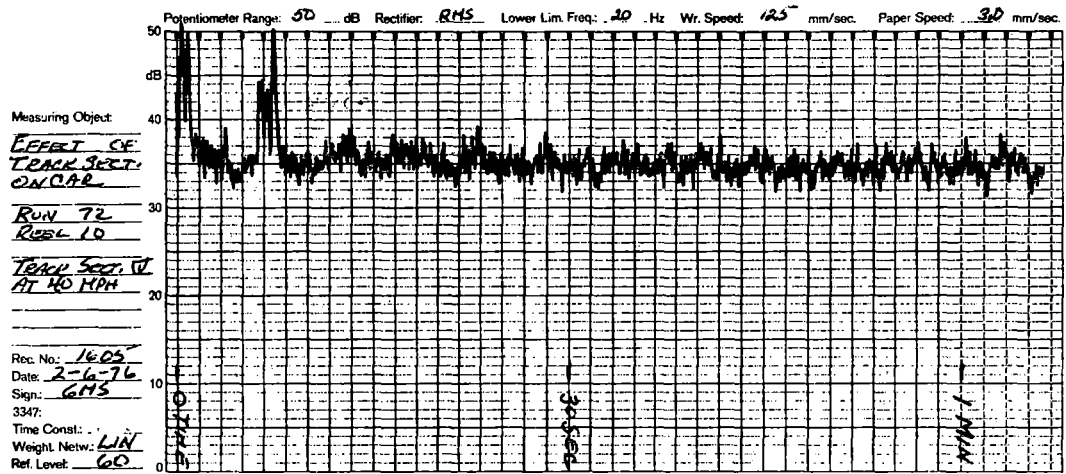
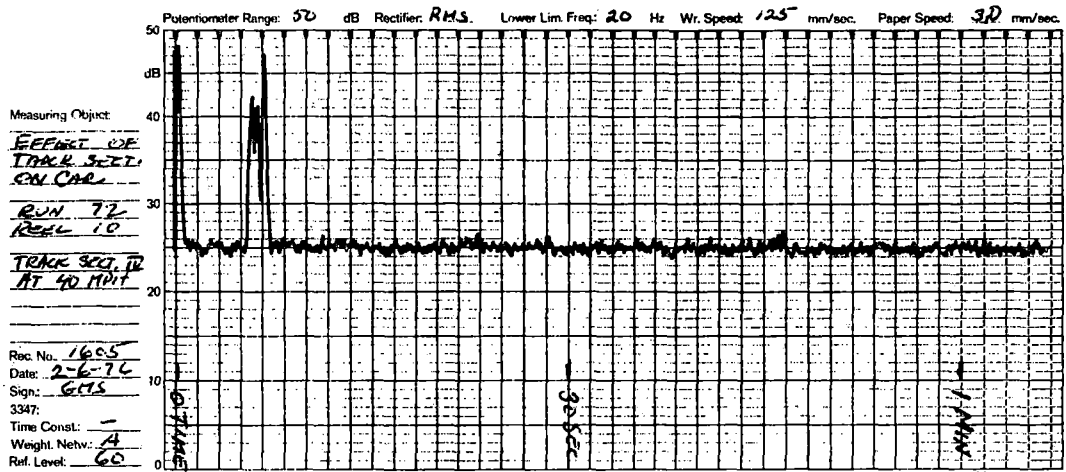

Figure 5-1. Interior Noise Test - Effect of Track Section (Sheet 4)

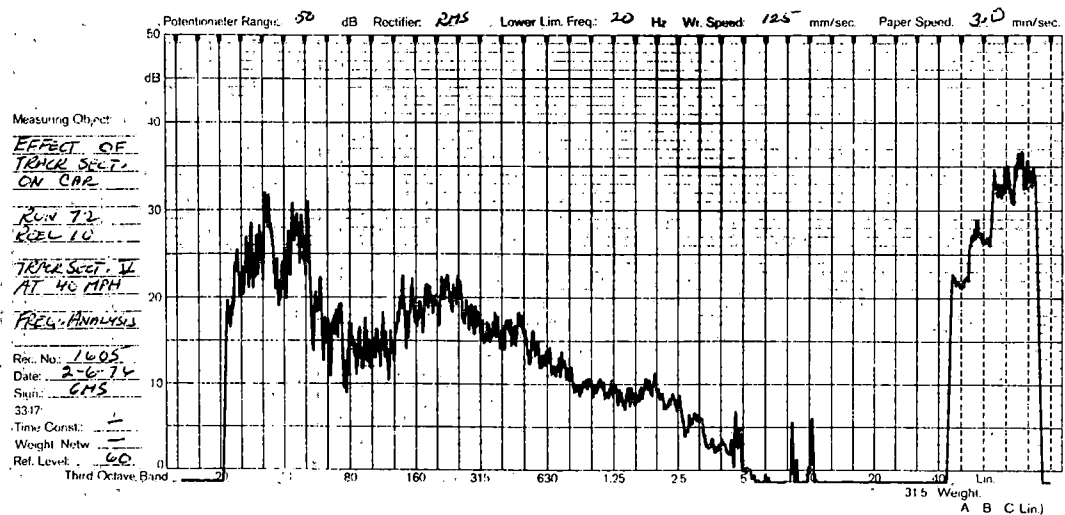
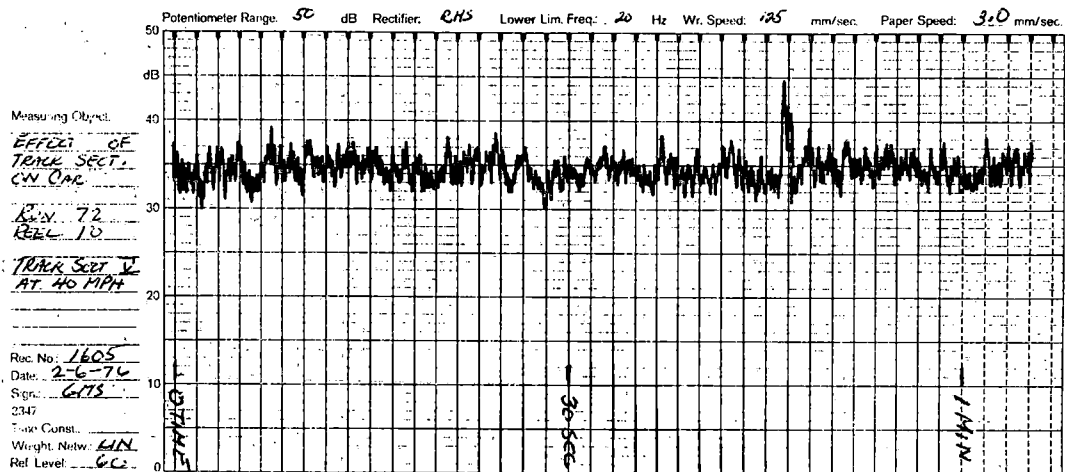
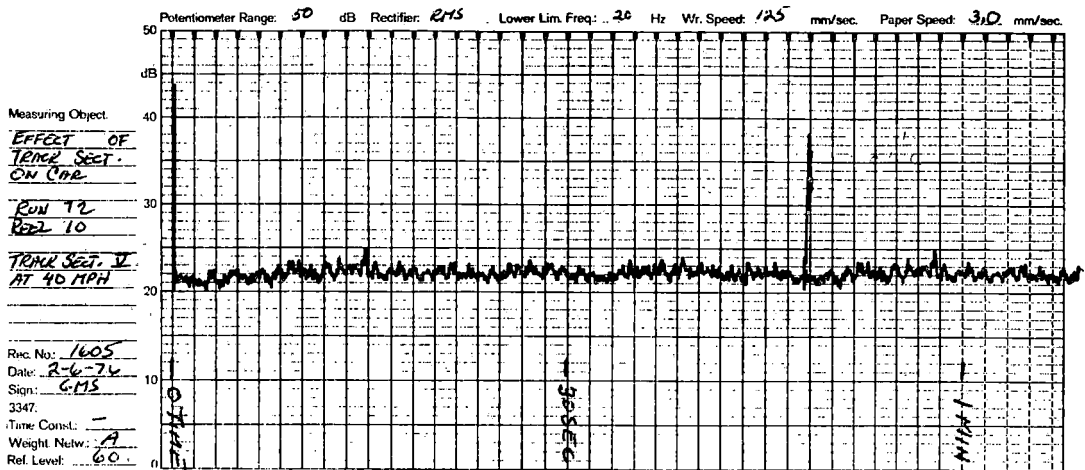

Figure 5-1. Interior Noise Test - Effect of Track Section (Sheet 5)

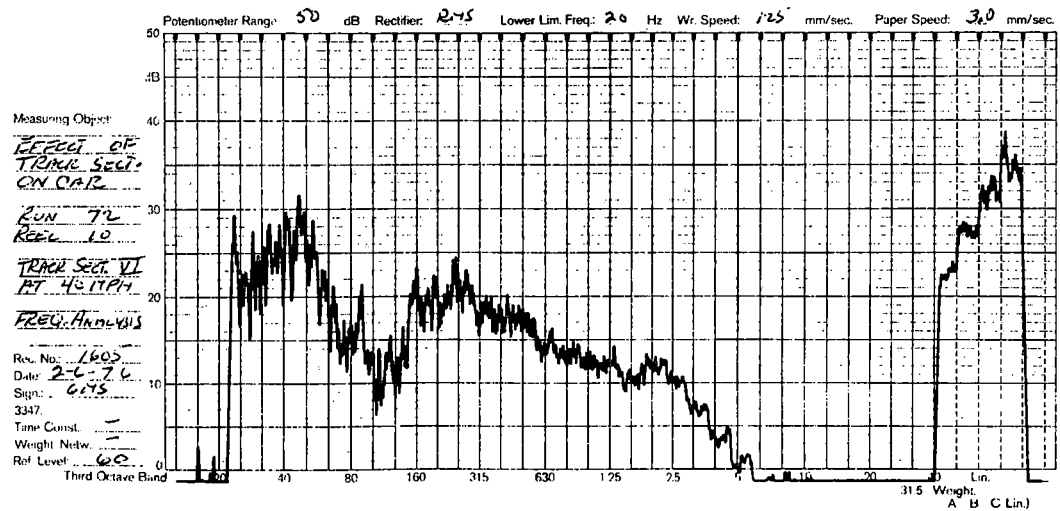
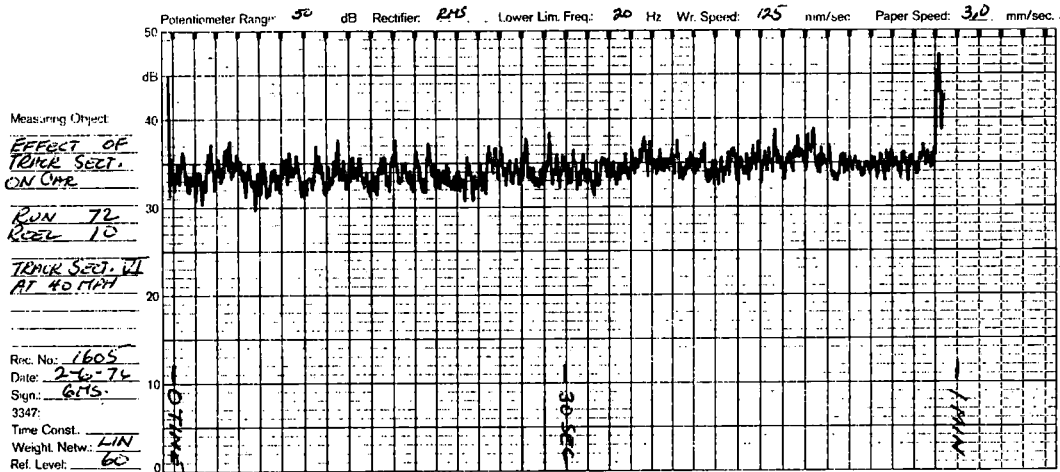
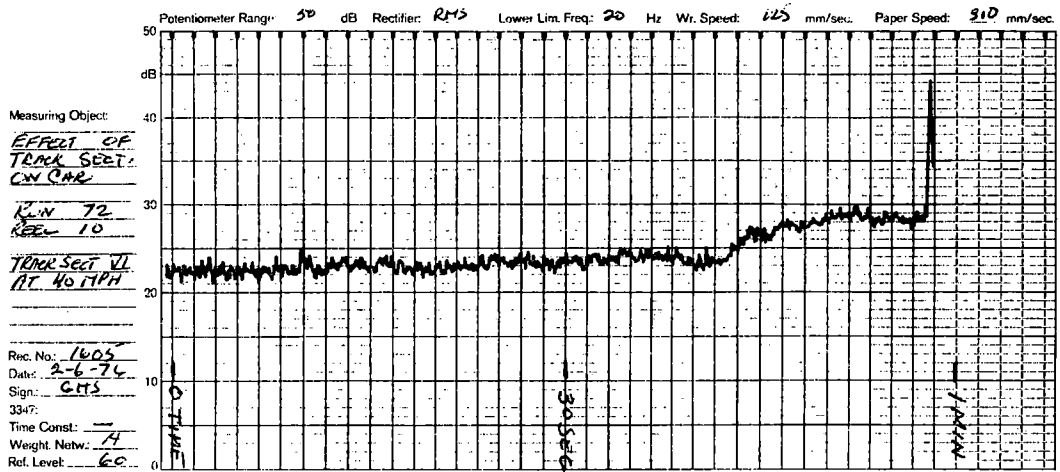

Figure 5-1. Interior Noise Test - Effect of Track Section (Sheet 6)

6. INTERIOR NOISE SURVEY (ESC-PN-1301-TT)

6.1 SUMMARY

The interior noise survey was conducted in compliance with Test Set Number ESC-PN-1301-TT of the TSC General Vehicle Test Plan, GSP-064. Requirements and procedures covered by the test set are defined in paragraphs 6.1.1 through 6.2.2. Refer to paragraph 6.3 for a description of the test, instrumentation used, and for the test results.

6.1.1 TEST OBJECTIVE

To determine the noise characteristics of the test vehicle by a survey of various passenger locations.

6.1.2 TEST DESCRIPTION

This test will be performed at a single test vehicle weight (AWO) while operating at a constant speed.

6.1.3 STATUS

The energy storage cars successfully completed the interior noise tests as prescribed by the conditions specified in paragraph 6.1.2. Refer to test log runs 50, 71 and 72 presented in Volume I, Appendix C of this report.

6.2 PROCEDURES

The following test procedures are included as part of the ESC-PN-1301-TT Test Set. The ESC tests were performed **generally** in accordance with these procedures and any procedural differences **are** reflected in paragraph 6.3.

6.2.1 PRETEST PROCEDURE

- (a) Ensure that the test vehicle is in a true test configuration (no wheel flats, no missing acoustical barriers such as seats or windscreens).
- (b) Ensure that the following weather conditions prevail:

No rain or other precipitation

Less than 90% relative humidity

Less than 10 knots wind velocity

- (c) Identify model and serial number of the noise measurement system.
- (d) Ensure that the test site is relatively free of excessive sound absorptive or obstructive characteristics.
- (e) Install a windscreen on the noise measurement microphone.
- (f) Calibrate the noise measurement system by recording a known acoustic calibration signal in order to provide a reference level. Do this at the beginning and end of the test, but at least twice on each test data tape.
- (g) Record ambient noise, including both acoustical background and electrical noise of the measurement system.
- (h) Record barometric pressure, relative humidity and ambient temperature at beginning of test.

CAUTION

- 1. Caution test crew on maintaining integrity of the noise test data.
- 2. Position recording microphone such that it is not shielded from the source of noise.
- 3. Record wind velocity and direction prior to each test point.
- 4. The direction of motion of the Test Vehicle will be the same for all test points.
- (i) Select a series of interior locations representative of the typical distribution of passengers in the Test Vehicle. This set of test locations might consist of 30 to 50 positions.
- (j) Select a test speed representative of high normal operation of the test vehicle.

6.2.2 TEST PROCEDURE

- (a) Operate the test vehicle through track section I at the selected test speed.
- (b) For each test location, identify the test point and record gain level on the recorder by voice and obtain a minimum of 15 seconds of noise data.
- (c) Repeat steps a and b as necessary to complete all of the test locations selected.

OPTION 1 Repeat the above procedure for another Test Vehicle weight.

OPTION 2 Repeat the above procedure for different train consists.

6.3 TEST DESCRIPTION AND RESULTS

The energy storage car (ESC) interior noise survey tests were conducted in accordance with AiResearch Documents 73-9373 and 74-10441 as defined in paragraph 6.3.1 and in compliance with GSP-064 Test Set ESC-PN-1301-TT, described in paragraphs 6.1.1 and 6.2.2.

6.3.1 DESCRIPTION

The ESC interior noise level test procedure was conducted in a manner similar to that prescribed for the exterior noise level test outlined in Section 2 and Section 3. For the interior tests, a microphone was located five feet from the car floor at the center point of car 3701, and, in addition to the audio recordings, the outputs of two 3-axis accelerometers were located, one at the car body center point, the other at the center of the bolster on the forward end of car 3700. The tests were performed using the procedures described in paragraph 6.2. A summary plot showing the track configurations is presented in figure 6-1.

6.3.2 INSTRUMENTATION

Block diagrams of the data acquisition system and the data recovery system are provided in figures 1-1 and 1-2. Details of the instrumentation related to the interior noise survey tests is shown in figure 1-6. Information concerning instrumentation for overall data acquisition for the energy storage car tests is described in Volume I of this report.

6.3.3 RESULTS

Representative samples of the interior noise survey tests are shown in figure 6-2, sheets 1 through 4. Results of car body vibration and flywheel vibration tests are shown in figures 6-3 and 6-4.

Car body vibration test plots (figure 6-3, sheets 1 through 4) were recorded from internally positioned vertical, lateral and longitudinal sensors and with the flywheel operating at speeds of 70 and 82 percent. Plots are identified by a circled number (1 through 8) located on each plot.

Flywheel vibration test plots (figure 6-4, sheets 1 through 3) were recorded from vertical, lateral and longitudinal sensors positioned near the flywheel and with the flywheel operating at speeds of 70 and 82 percent. Plots are identified by a circled number (9 through 14) located on each plot.

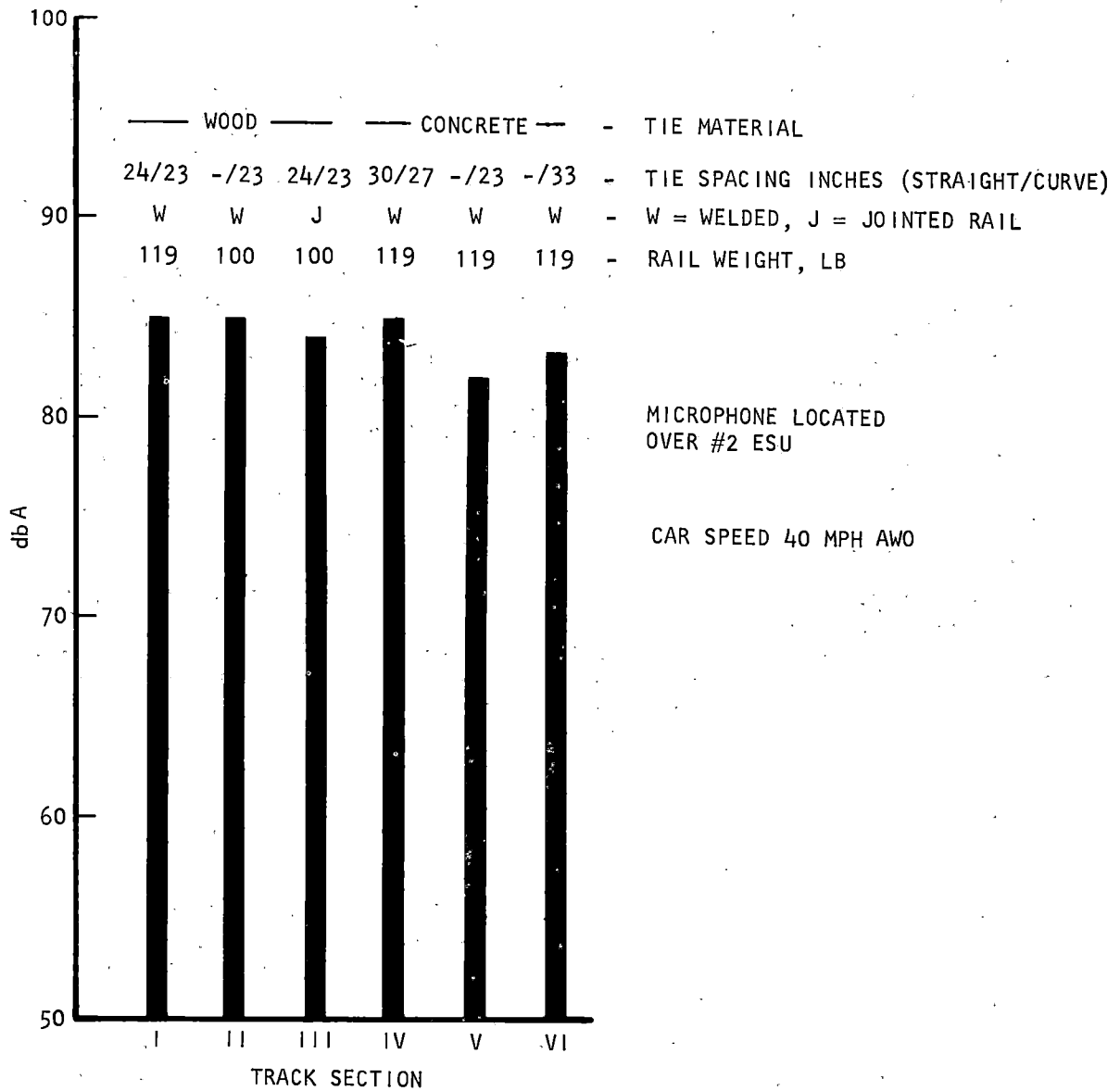

Figure 6-1. Interior Noise Survey Summary - Track Configuration

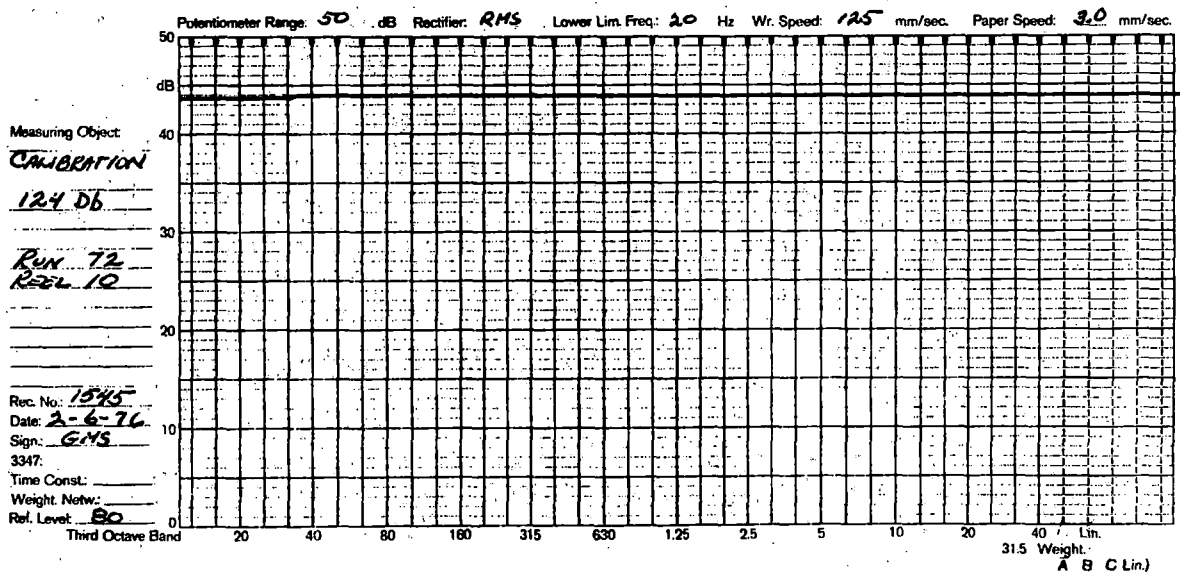
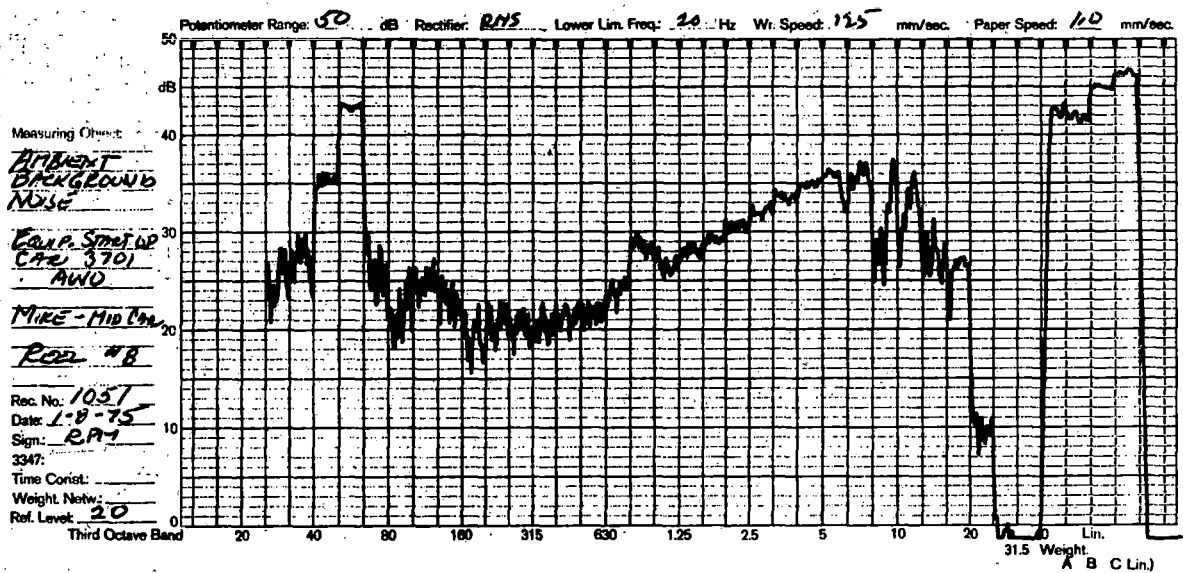

Figure 6-2. Interior Noise Survey (Sheet 1)

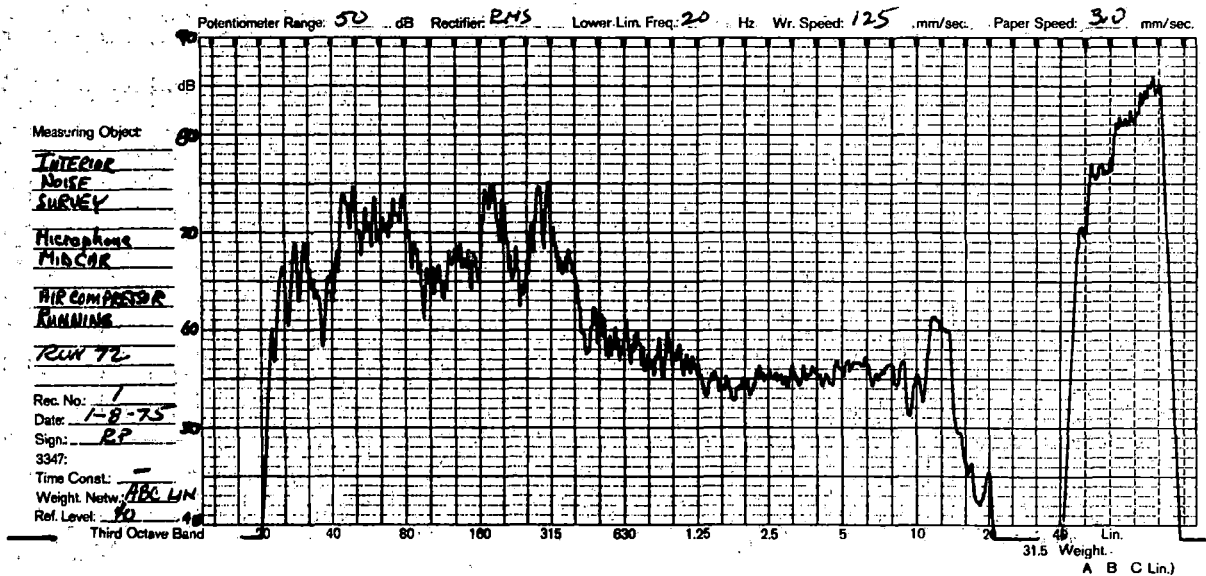
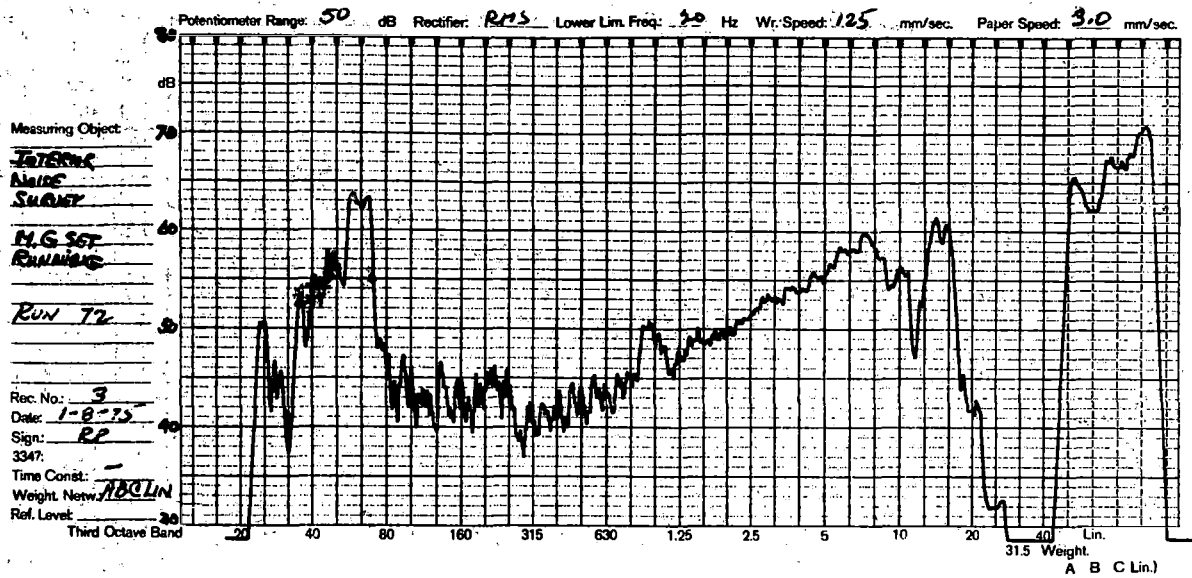

Figure 6-2. Interior Noise Survey (Sheet 2)

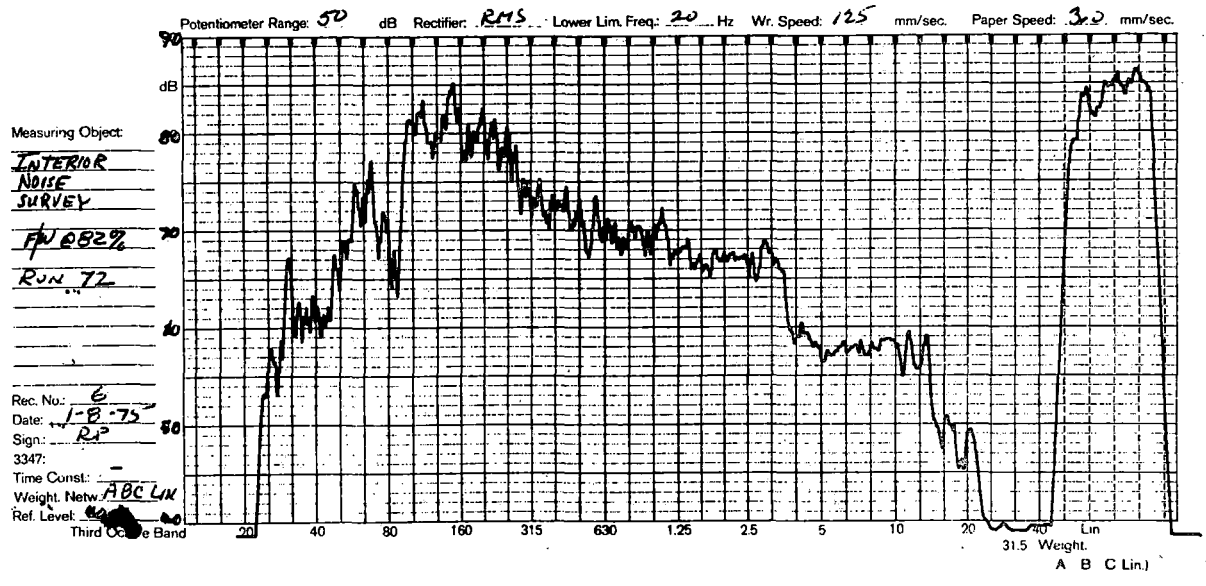
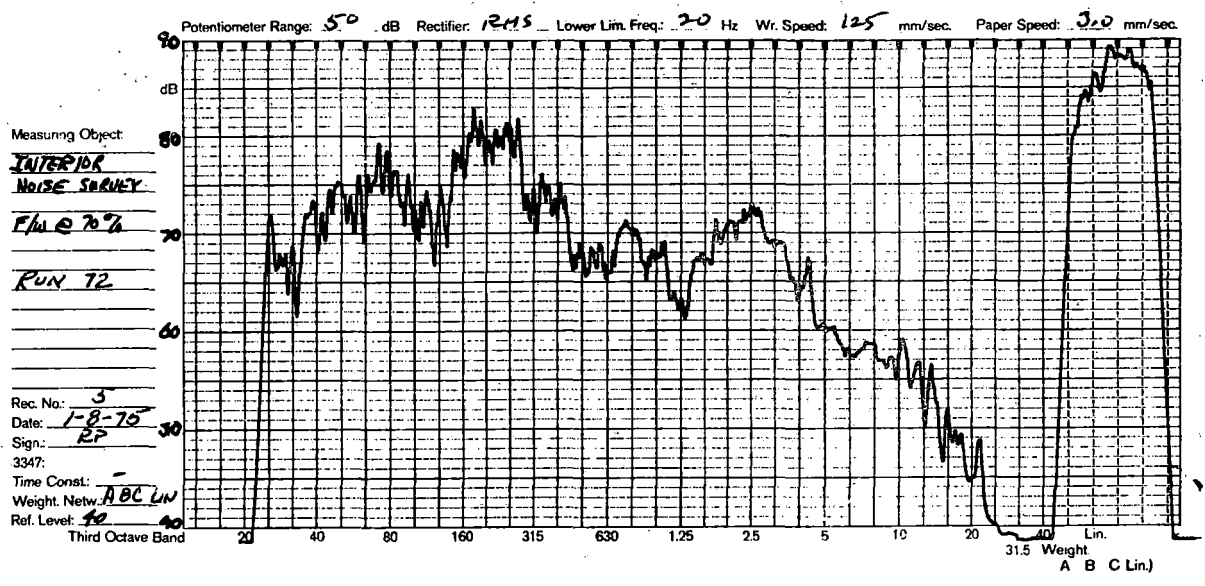

Figure 6-2. Interior Noise Survey (Sheet 3)

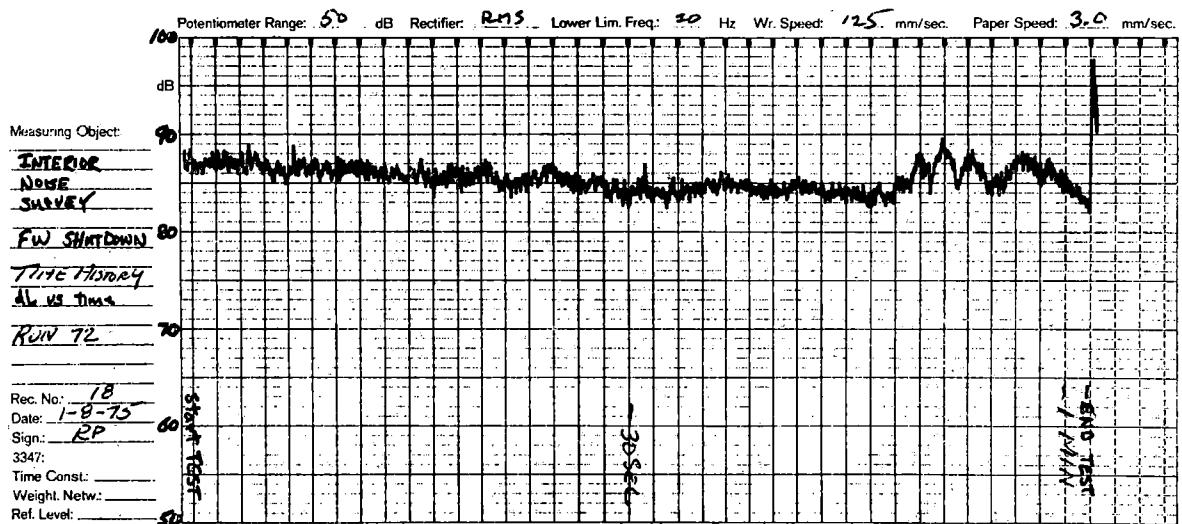
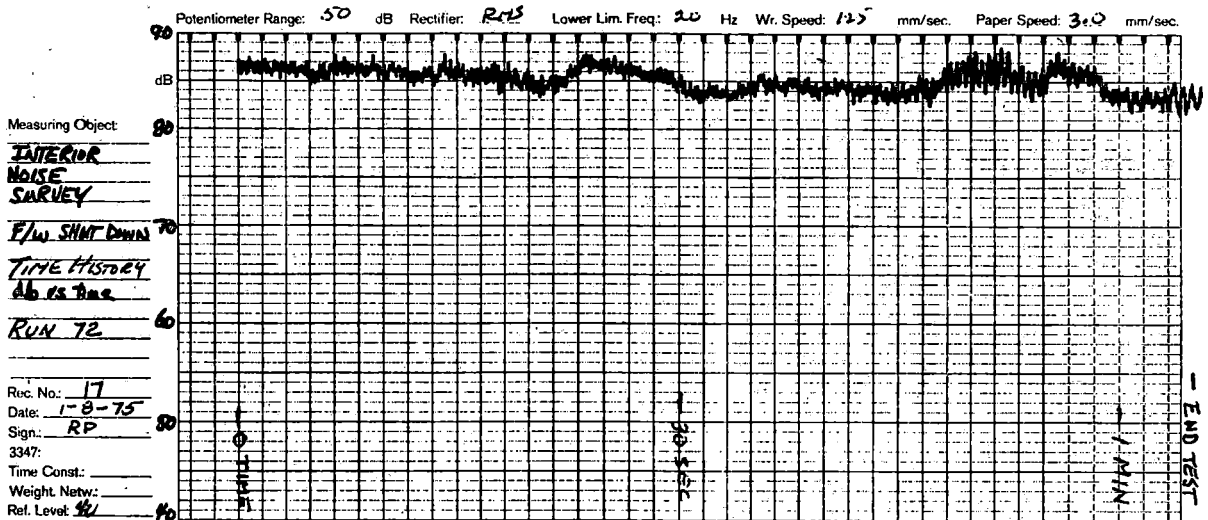

Figure 6-2. Interior Noise Survey (Sheet 4)

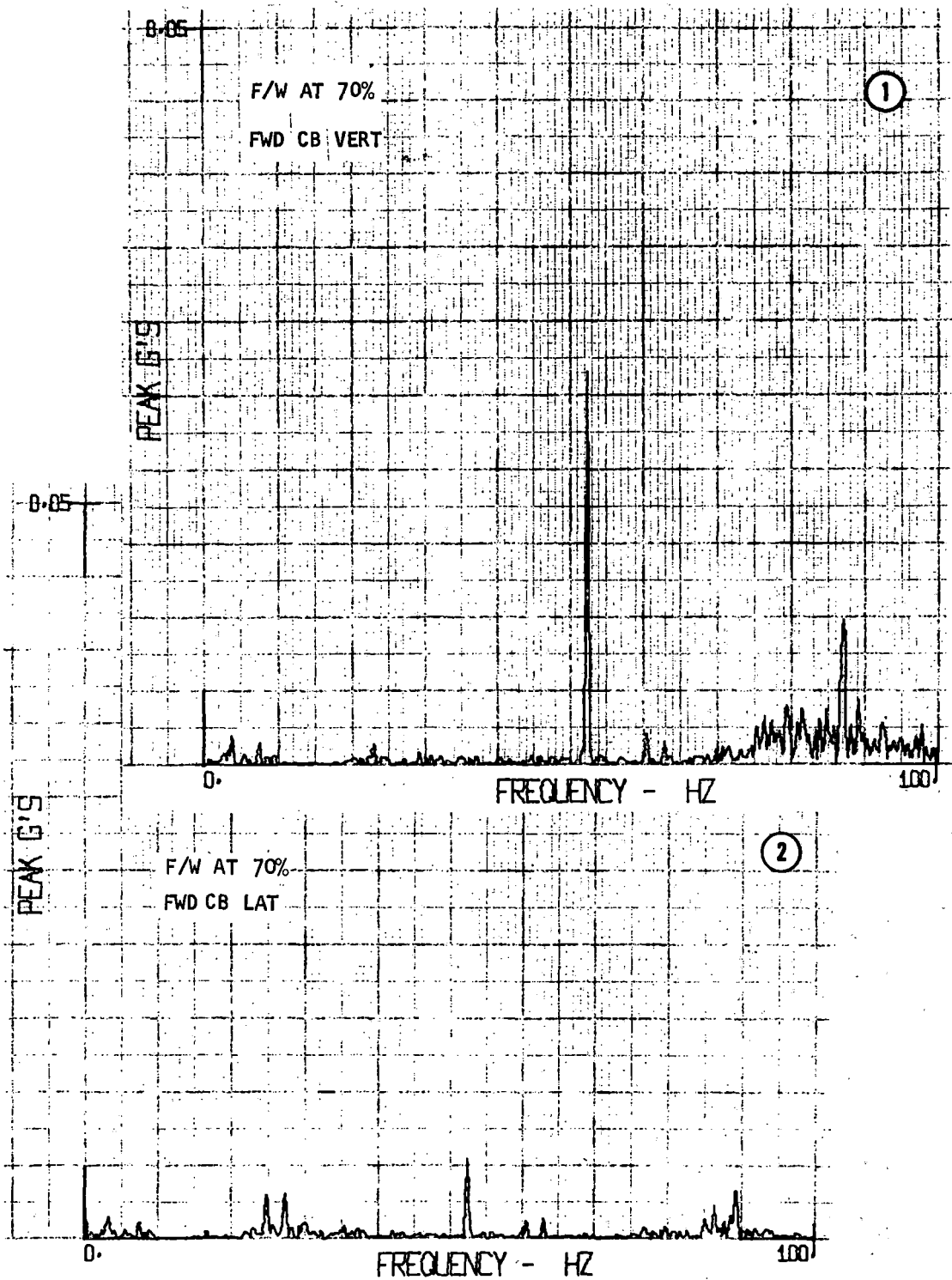

Figure 6-3. Interior Noise Survey - Car Body Vibration (Sheet 1)

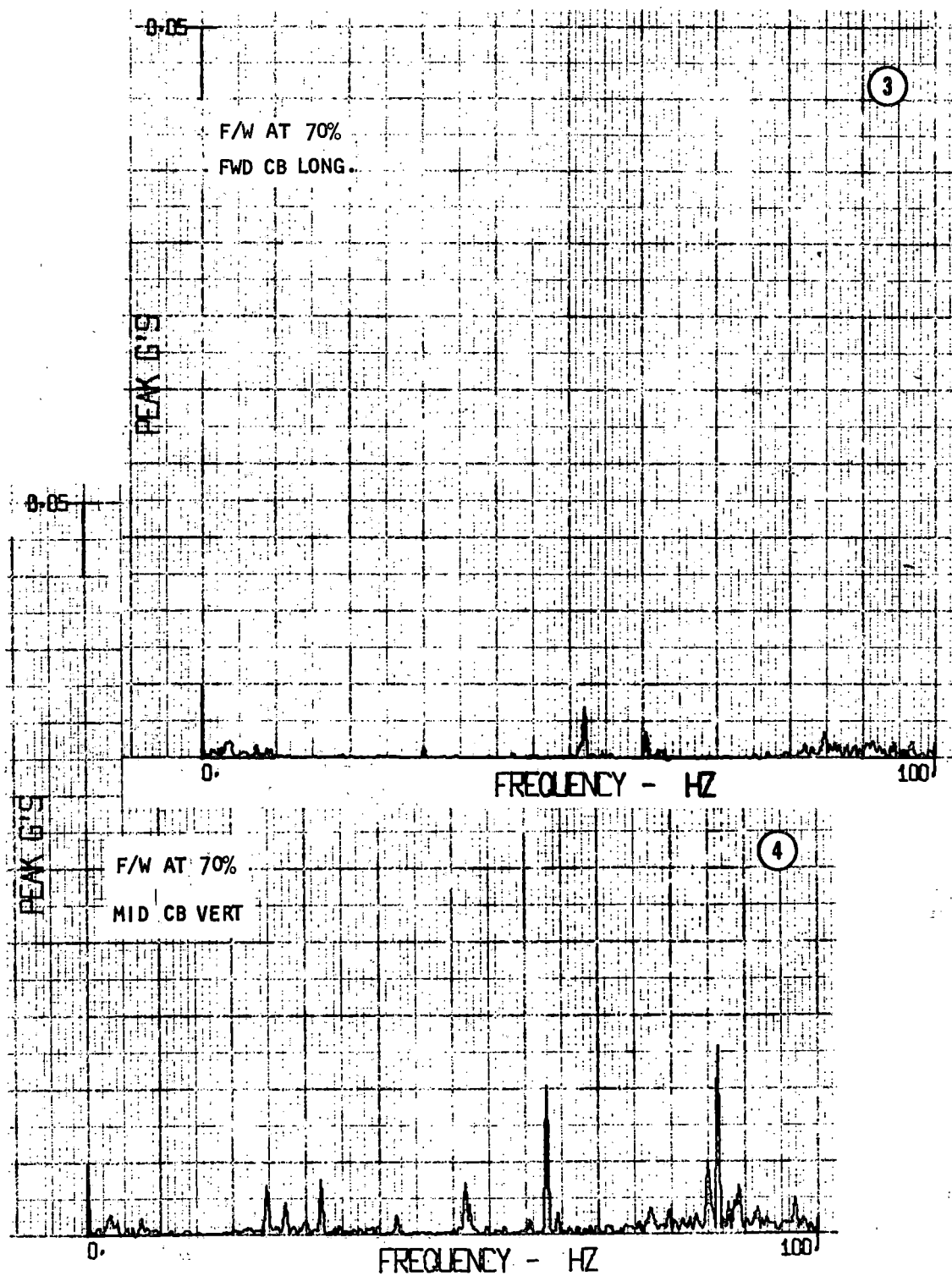

Figure 6-3. Interior Noise Survey - Car Body Vibration (Sheet 2)

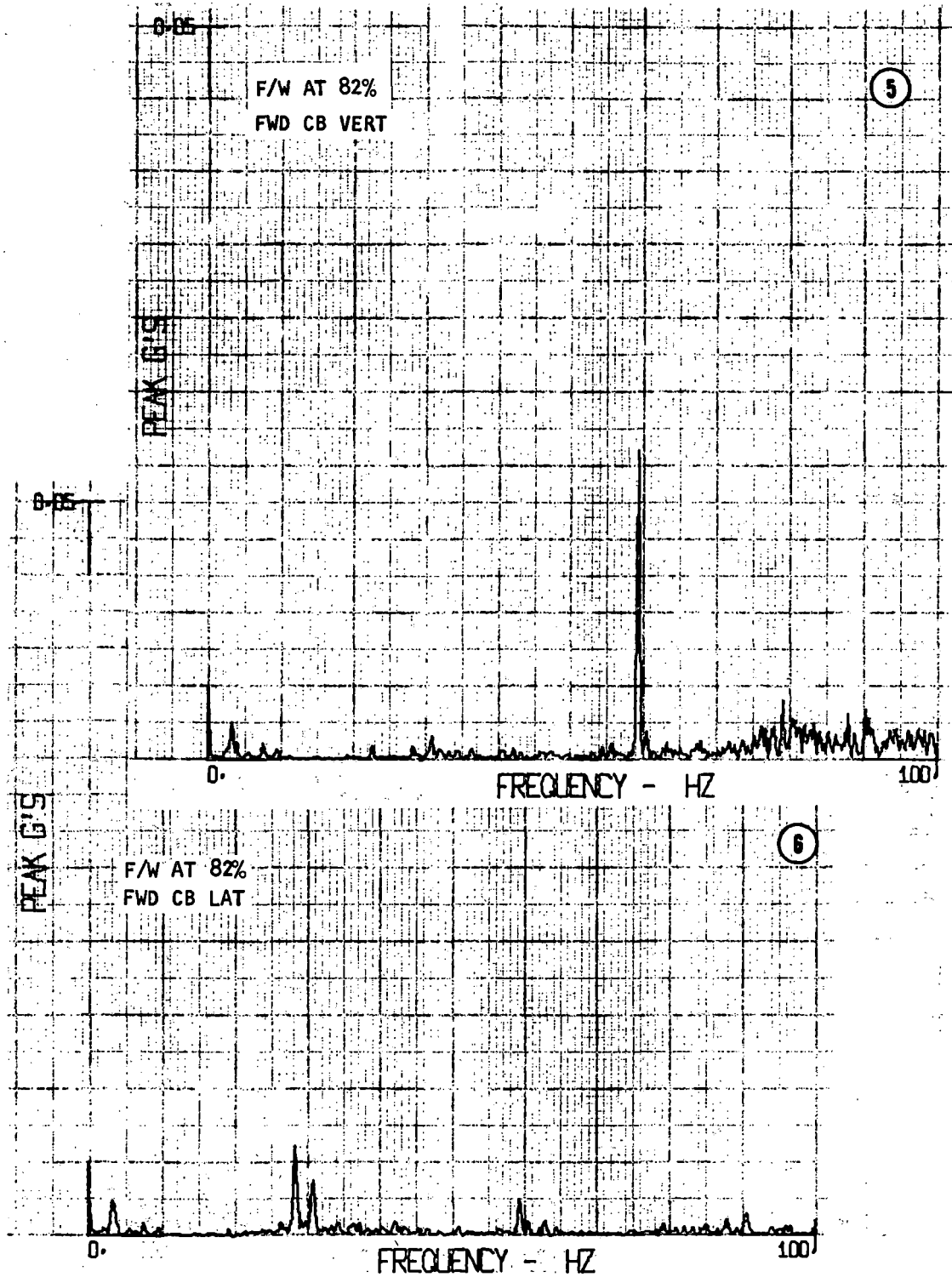

Figure 6-3. Interior Noise Survey - Car Body Vibration (Sheet 3)

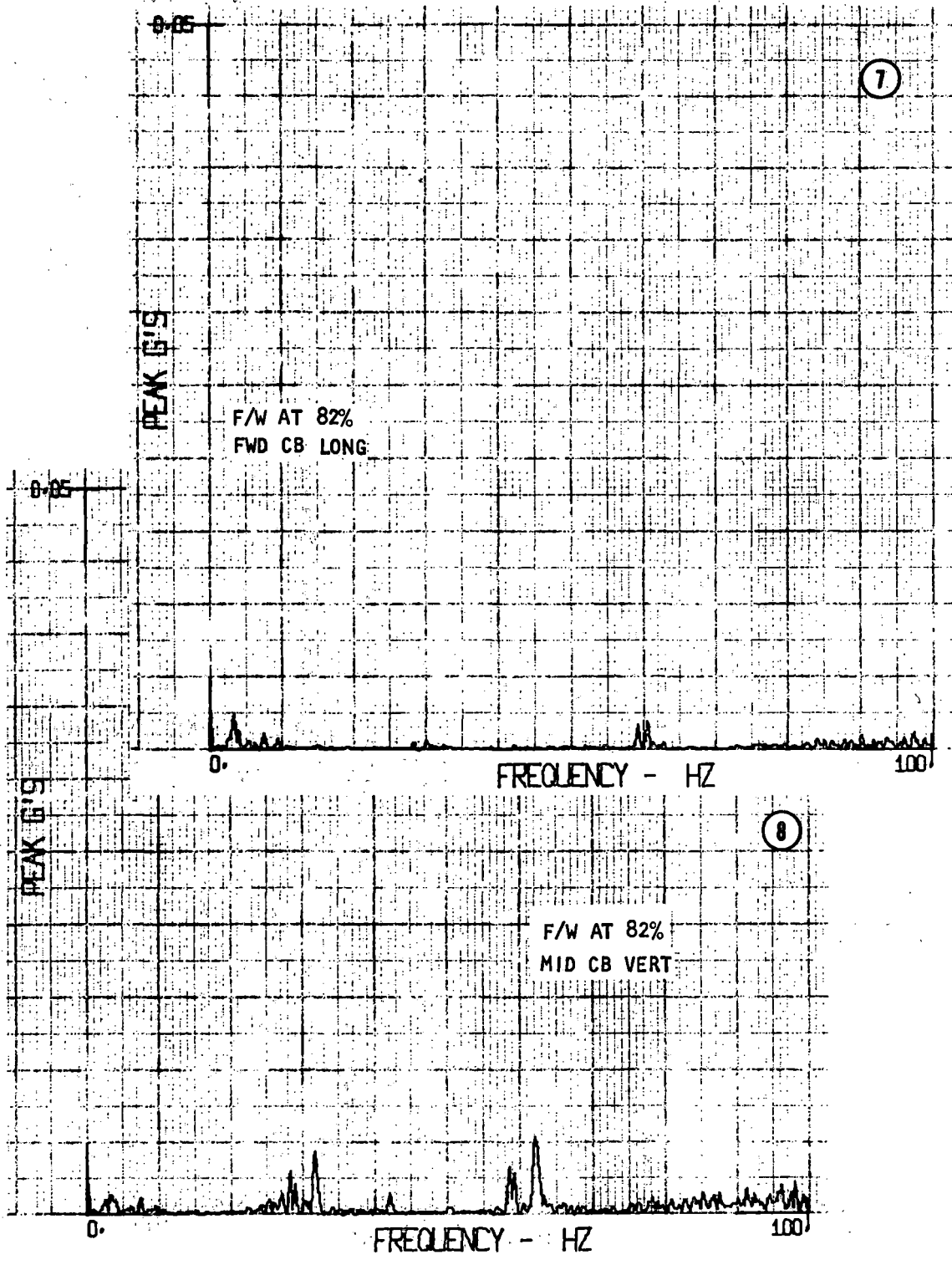

Figure 6-3. Interior Noise Survey - Car Body Vibration (Sheet 4)

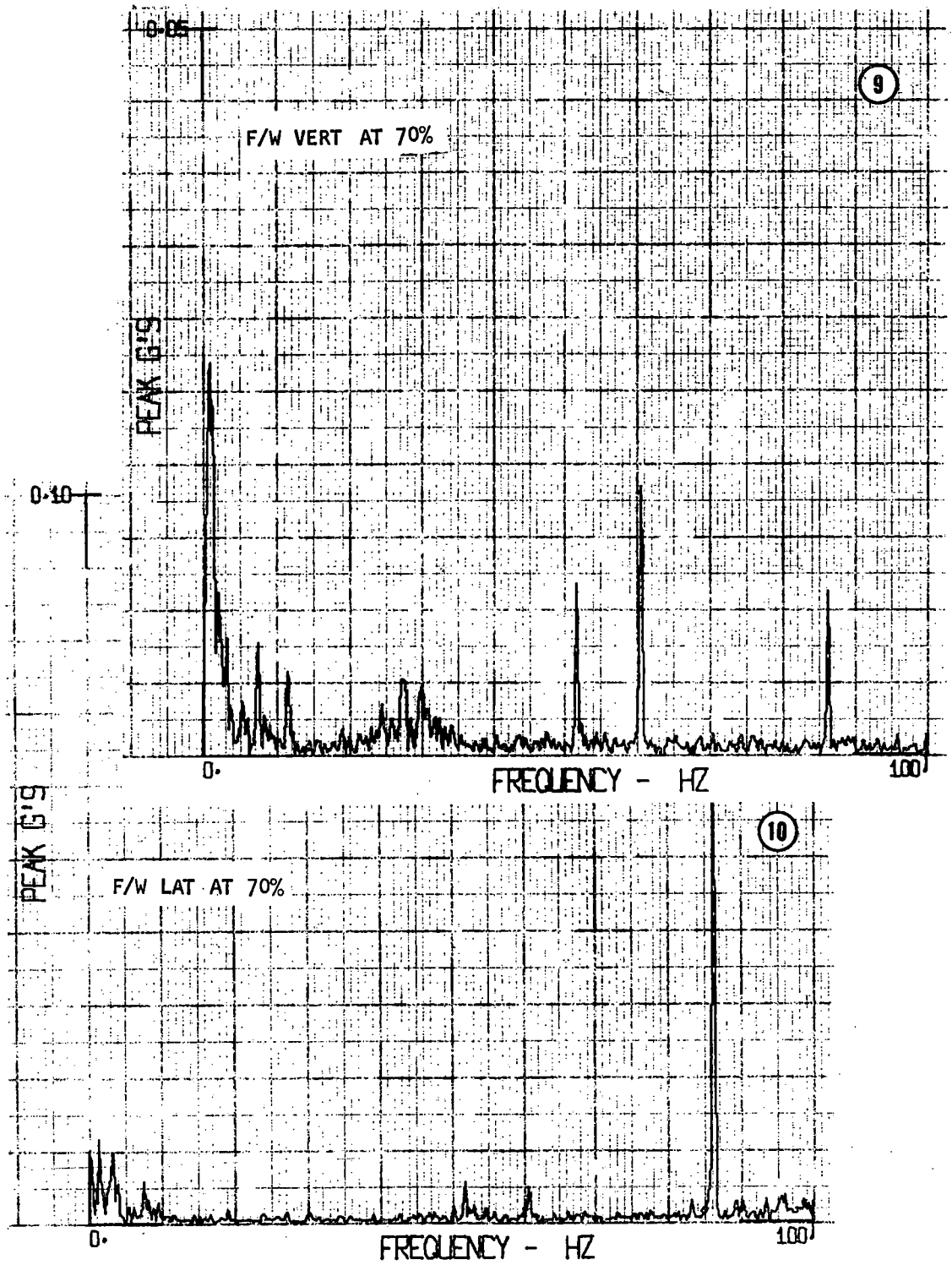

Figure 6-4. Interior Noise Survey - Flywheel Vibration (Sheet 1)

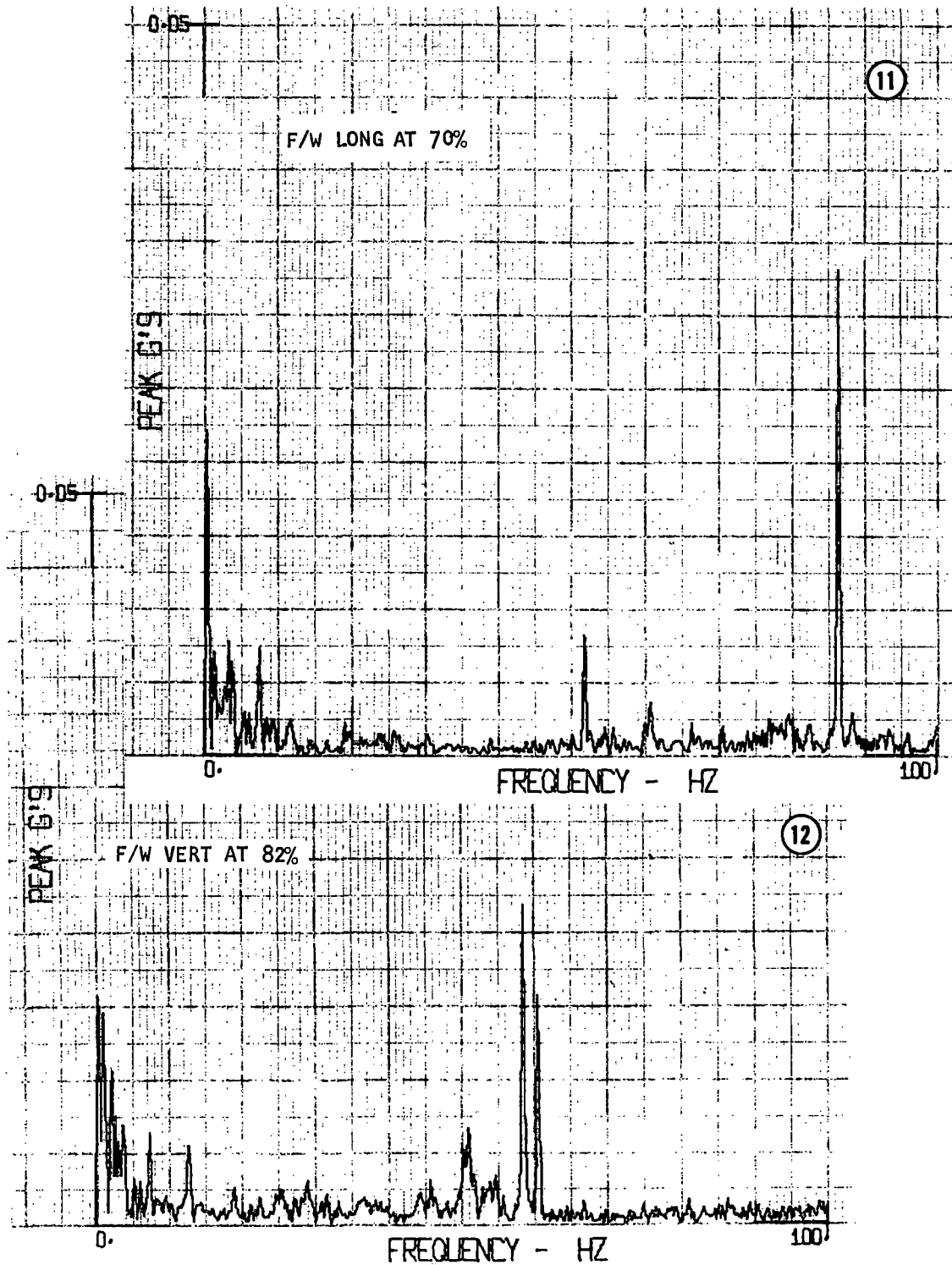

Figure 6-4. Interior Noise Survey - Flywheel Vibration (Sheet 2)

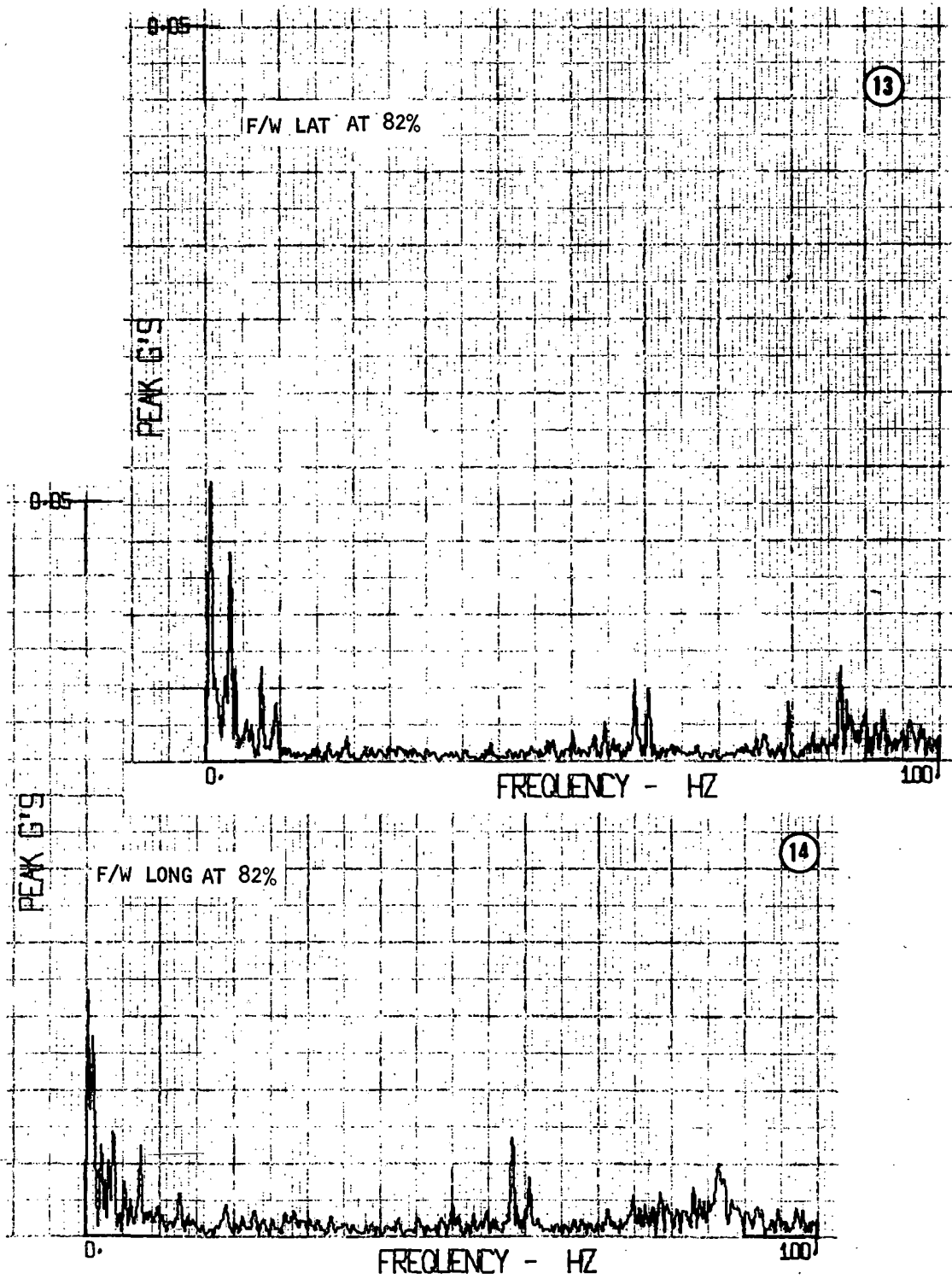

Figure 6-4. Interior Noise Survey - Flywheel Vibration (Sheet 3)

7. INTERIOR-NOISE - ACCELERATION EFFECT (ESC-PN-2001-TT)

7.1 SUMMARY

The interior noise level test to determine the noise level produced by an accelerating car was conducted in compliance with Test Set Number ESC-PN-2001-TT of the TSC General Vehicle Test Plan, GSP-064. Requirements and procedures covered by the test set are defined in paragraphs 7.1.1 through 7.2.2. Refer to paragraph 7.3 for a description of the test, instrumentation used, and for the test results.

7.1.1 TEST OBJECTIVE

To determine noise levels inside the test vehicle while accelerating.

7.1.2 TEST DESCRIPTION

This test will be performed at the following conditions:

- (a) Four selected interior test points
- (b) Car weights of AW0 and AW3

7.1.3 STATUS

The energy storage cars successfully completed the acceleration effect tests as prescribed by the conditions specified in paragraph 7.1.2. Refer to test log runs 53, 67 and 72 presented in Volume I, Appendix C of this report.

7.2 PROCEDURES

The following test procedures are included as part of the ESC-PN-2001-TT Test Set. The ESC tests were performed generally in accordance with these procedures and any procedural differences are reflected in paragraph 7.3.

7.2.1 PRETEST PROCEDURE

- (a) Ensure that the test vehicle is in a true test configuration (no wheel flats, no missing acoustical barriers such as seats or windscreens).
- (b) Ensure that the following weather conditions prevail:
 - No rain or other precipitation
 - Less than 90% relative humidity
 - Less than 10 knots wind velocity

- (c) Identify model and serial number of the noise measurement system.
- (d) Ensure that the test site is relatively free of excessive sound absorptive or obstructive characteristics.
- (e) Install a windscreen on the noise measurement microphone.
- (f) Calibrate the noise measurement system by recording a known acoustic calibration signal in order to provide a reference level. Do this at the beginning and end of the test, but at least twice on each test data tape.
- (g) Record ambient noise, including both acoustical background and electrical noise of the measurement system.
- (h) Record barometric pressure, relative humidity and ambient temperature at beginning of test.

CAUTION

1. Caution test crew on maintaining integrity of the noise test data.
2. Position recording microphone such that it is not shielded from the source of noise.
3. Record wind velocity and direction prior to each test point.
4. The direction of motion of the test vehicle will be the same for all test points.

7.2.2 TEST PROCEDURE

- (a) Select two-car interior locations as test points (these test points should be representative of standing or seated passengers throughout the test vehicle).
- (b) Position the test vehicle at track section I on the UMTA test track.
- (c) Start the recorder, identify the test point and record gain level by voice. Vehicle indicated speeds at selected points should also be voice entered on the recorder.
- (d) Initiate full acceleration, and record sound pressure levels until test vehicle reaches maximum speed.

OPTION 1 Repeat steps b through d for additional interior locations.

NOTE

During the test, specific additional car locations may be identified, and data obtained. This should be accomplished if noise levels appear abnormal and the data can be used to identify the source.

OPTION 2. Repeat steps b through d for additional test vehicle weights as required.

7.3 TEST DESCRIPTION AND RESULTS

The energy storage car (ESC) interior noise acceleration tests were conducted in accordance with AiResearch Documents 73-9373 and 74-10441 as defined in paragraph 7.3.1 and in compliance with GSP-064 Test Set ESC-PN-2001-TT, described in paragraphs 7.1.1 and 7.1.2.

7.3.1 DESCRIPTION

The ESC interior noise acceleration tests were performed at AWO and AW3 car weights to determine the noise level inside the car during acceleration. The microphones for these tests were located at the center point of the cars. Forward and reverse acceleration tests in the switching, series and parallel modes of operation were performed using the procedures described in paragraph 7.2.

7.3.2 INSTRUMENTATION

Block diagrams of the data acquisition system and the data recovery system are provided in figures 1-1 and 1-2. Details of the instrumentation related to the ESC interior noise acceleration tests is shown in figure 1-6. Information concerning instrumentation for overall data acquisition for the energy storage car tests is described in Volume I of this report.

7.3.3 RESULTS

Representative samples of the interior noise acceleration test results are shown in figure 7-1. The results shown were obtained during the application of acceleration switching, series and parallel modes (see sheets 1 through 3) in both the forward and reverse directions.

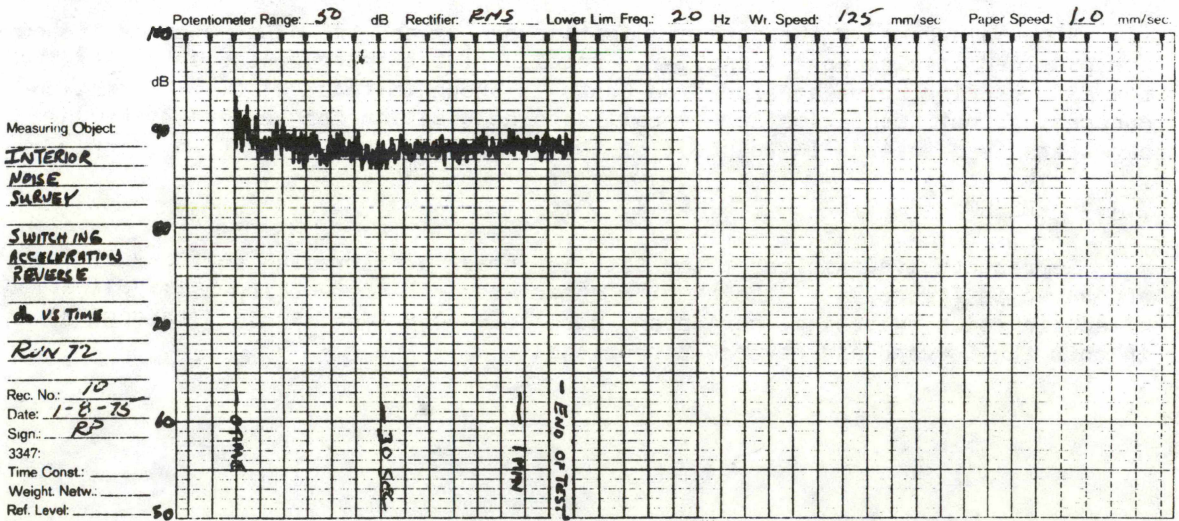
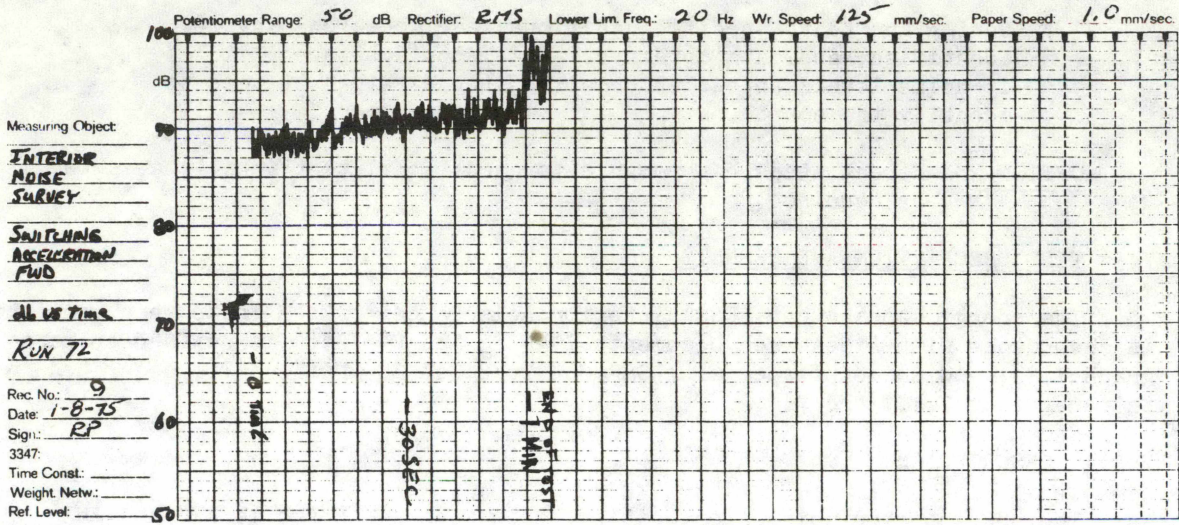

Figure 7-1. Interior Noise Test - Acceleration Effect (Sheet 1)

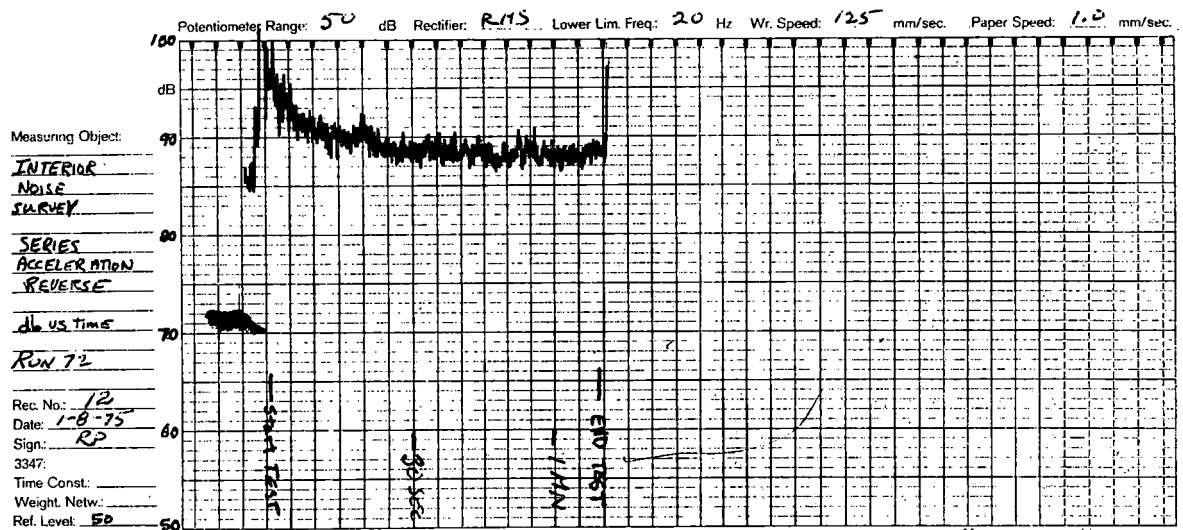
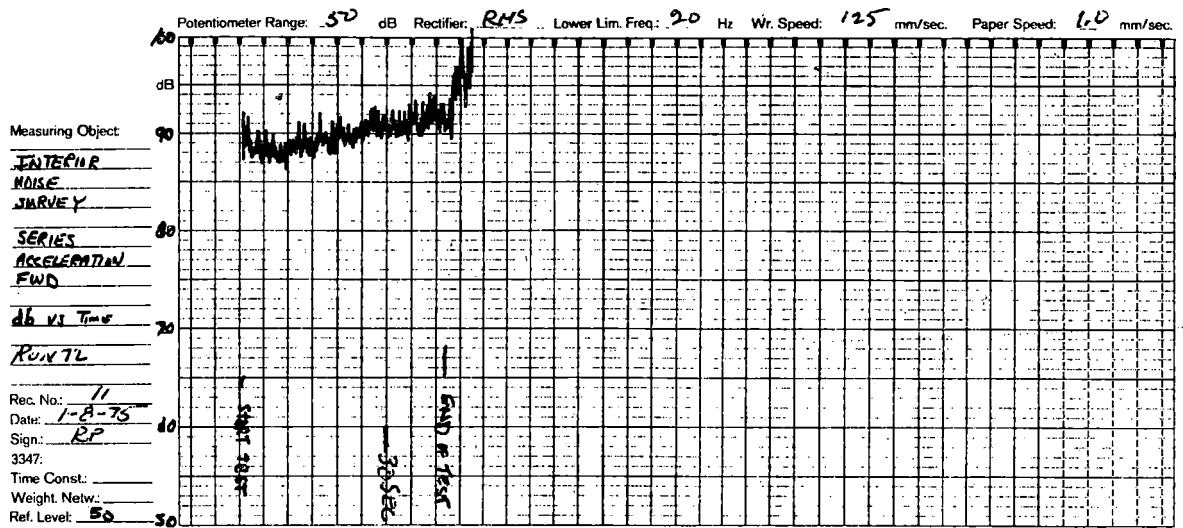

Figure 7-1. Interior Noise Test - Acceleration Effect (Sheet 2)

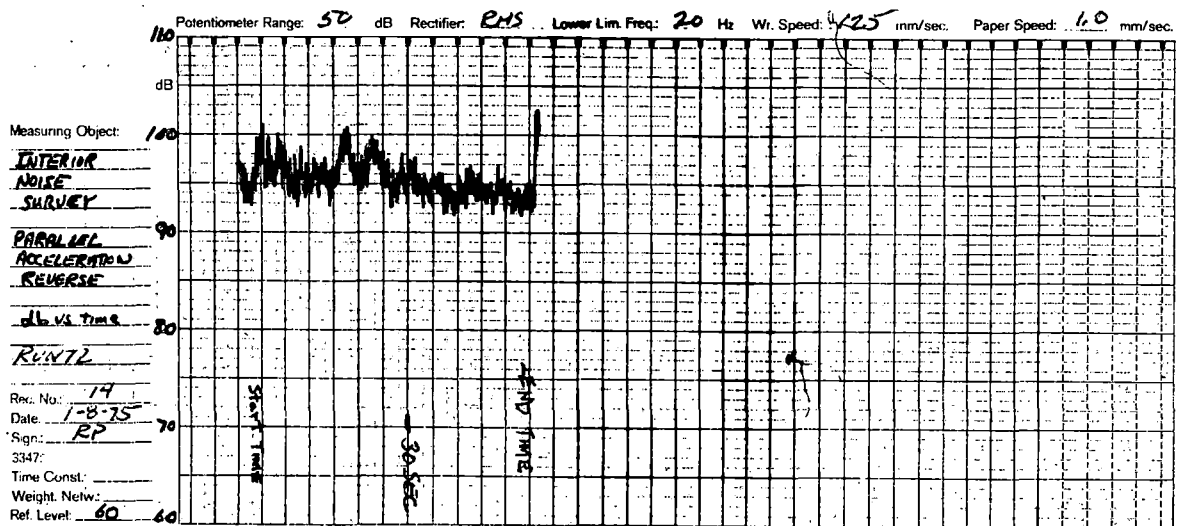
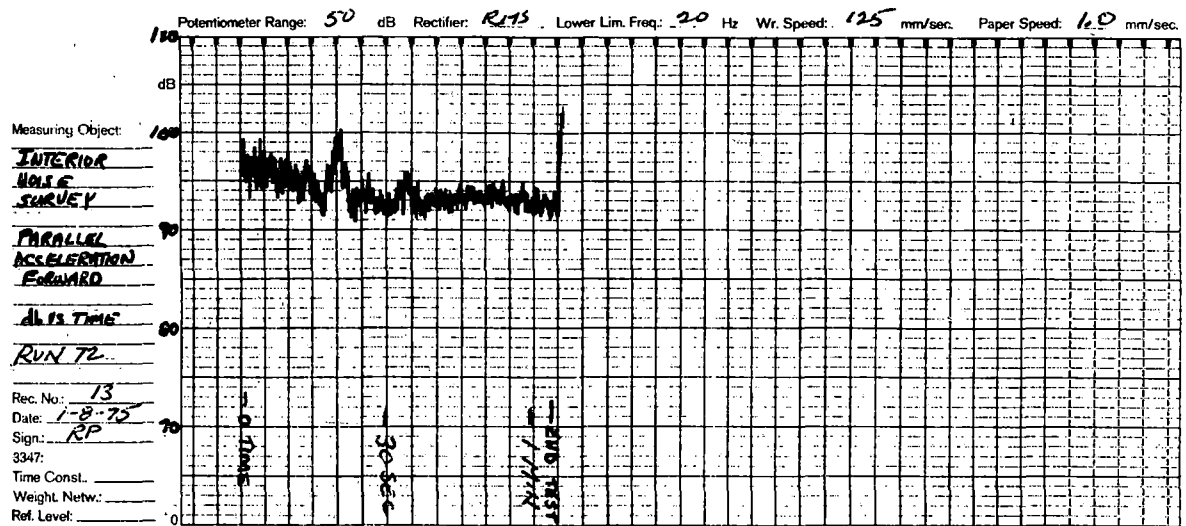

Figure 7-1. Interior Noise Test - Acceleration Effect (Sheet 3)

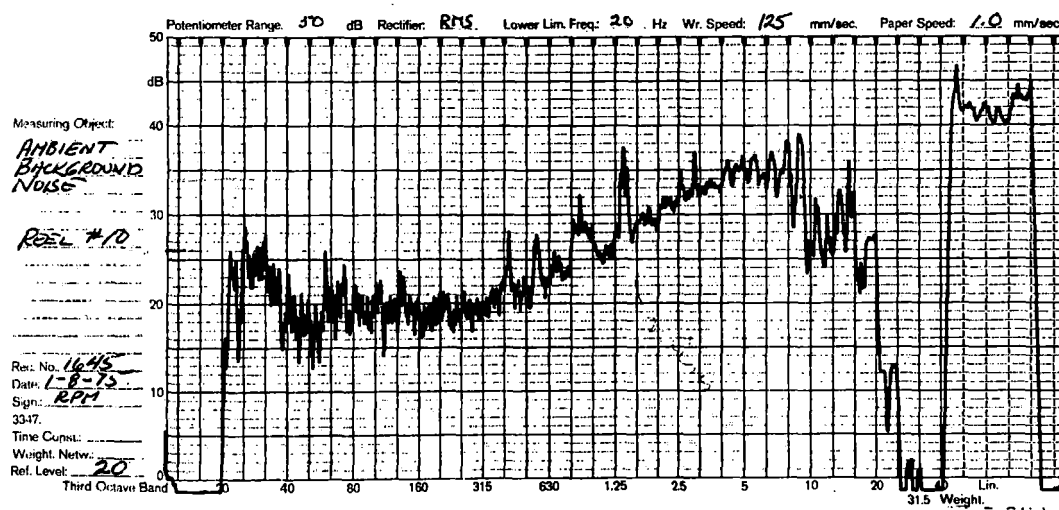
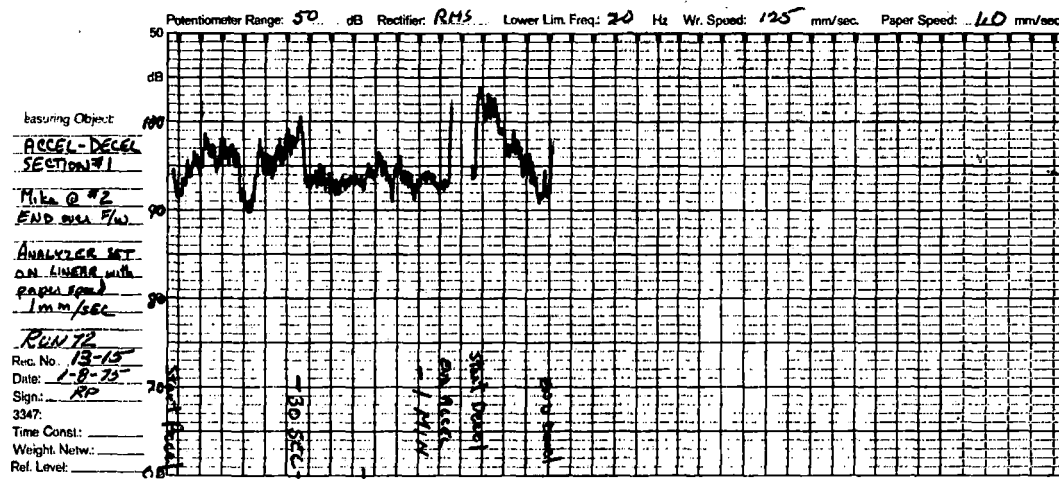
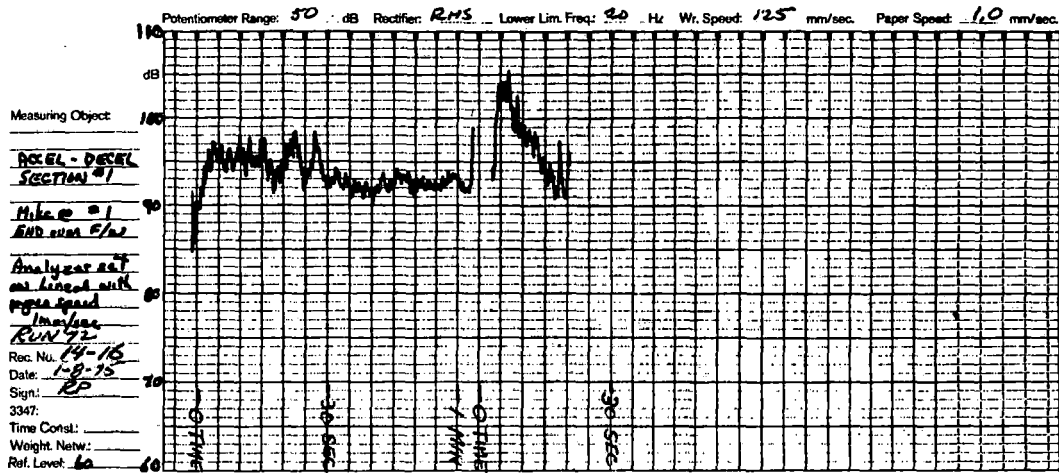

Figure 7-1. Interior Noise Test - Acceleration Effect (Sheet 4)

8. INTERIOR NOISE - DECELERATION EFFECT (ESC-PN-3001-TT)

8.1 SUMMARY

The interior noise level test to determine the noise level produced by a decelerating car was conducted in compliance with Test Set Number ESC-PN-3001-TT of the TSC General Vehicle Test Plan, GSP-064. Requirements and procedures covered by the test set are defined in paragraphs 8.1.1 through 8.2.2. Refer to paragraph 8.3 for a description of the test, instrumentation used, and for the test results.

8.1.1 TEST OBJECTIVE

To determine noise levels inside the test vehicle while decelerating.

8.1.2 TEST DESCRIPTION

This test will be performed at the following conditions:

- (a) Four selected interior test points
- (b) For various braking configurations (depends upon modes available on test vehicle). The basic configuration will be the normal service system.
- (c) Car weights of AWO and AW3

8.1.3 STATUS

The energy storage cars successfully completed the deceleration effect tests as prescribed by the conditions specified in paragraph 8.1.2. Refer to test log runs 53, 67 and 72 presented in Volume I, Appendix C of this report.

8.2 PROCEDURES

The following test procedures are included as part of the ESC-PN-3001-TT Test Set. The ESC tests were performed generally in accordance with these procedures and any procedural differences are reflected in paragraph 8.3.

8.2.1 PRETEST PROCEDURE

- (a) Ensure that the test vehicle is in a true test configuration (no wheel flats, no missing acoustical barriers such as seats or windscreens).

- (b) Ensure that the following weather conditions prevail:
- No rain or other precipitation
 - Less than 90% relative humidity
 - Less than 10 knots wind velocity
- (c) Identify model and serial number of the noise measurement system.
- (d) Ensure that the test site is relatively free of excessive sound absorptive or obstructive characteristics.
- (e) Install a windscreen on the noise measurement microphone.
- (f) Calibrate the noise measurement system by recording a known acoustic calibration signal in order to provide a reference level. Do this at the beginning and end of the test, but at least twice on each test data tape.
- (g) Record ambient noise, including both acoustical background and electrical noise of the measurement system.
- (h) Record barometric pressure, relative humidity and ambient temperature at beginning of test.

CAUTION

1. Caution test crew on maintaining integrity of the noise test data.
2. Position recording microphone such that it is not shielded from the source of noise.
3. Record wind velocity and direction prior to each test point.
4. The direction of motion of the test vehicle will be the same for all test points.

8.2.2 TEST PROCEDURE

- (a) Select 2-car interior locations as test points (these test points should be representative of standing or seated passengers throughout the test vehicle).
- (b) Operate the test vehicle at maximum speed such that the full deceleration cycle will occur with track section I on the transit test track.

- (c) Start the recorder, identify the test point and record gain level by voice. Vehicle indicated speeds at selected points should also be voice entered on the recorder.
- (d) Initiate full service deceleration and maintain until test vehicle comes to a complete stop.

OPTION 1 Repeat steps b through d for additional interior locations.

NOTE

During the test, specific additional car locations may be identified and data obtained. This should be accomplished if noise levels appear abnormal and the data can be used to identify the source.

OPTION 2 Repeat steps b through d for the required braking configurations (may be friction only, dynamic only, track brake only, etc. as available to the test vehicle).

OPTION 3 Repeat steps b through d for additional test vehicle weights as required.

8.3 TEST DESCRIPTION AND RESULTS

The energy storage car (ESC) interior noise deceleration tests were conducted in accordance with AiResearch Documents 73-9373 and 74-10441 as defined in paragraph 8.3.1 and in compliance with GSP-064 Test Set ESC-PN-3001-TT, described in paragraphs 8.1.1 and 8.1.2.

8.3.1 DESCRIPTION

The ESC interior noise deceleration tests were performed at AWO and AW3 car weights to determine the noise level inside the car during deceleration. The microphones for these tests were located at the center point of the cars and full service braking was applied from 40 mph in both the forward and reverse directions. Tests were performed using procedures described in paragraph 8.2.

8.3.2 INSTRUMENTATION

Block diagrams of the data acquisition system and the data recovery system are provided in figures 1-1 and 1-2. Details of the instrumentation related to the ESC interior noise deceleration tests is shown in figure 1-6. Information concerning instrumentation for overall data acquisition for the energy storage car tests is described in Volume I of this report.

8.3.3 RESULTS

Representative samples of the interior noise deceleration test results are shown in figure 8-1. The results shown were obtained during full service braking from 40 mph in both the forward and reverse directions.

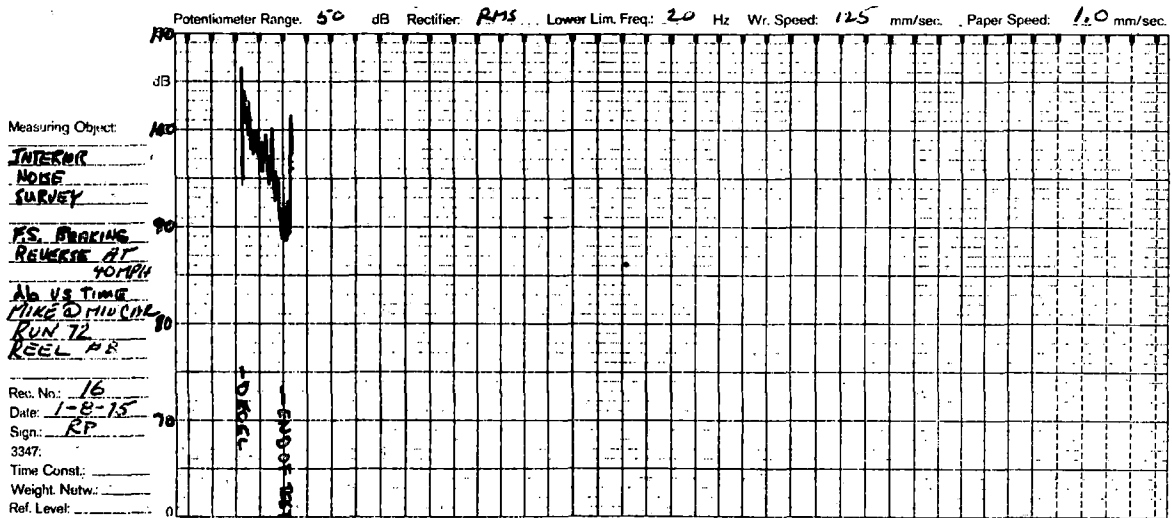
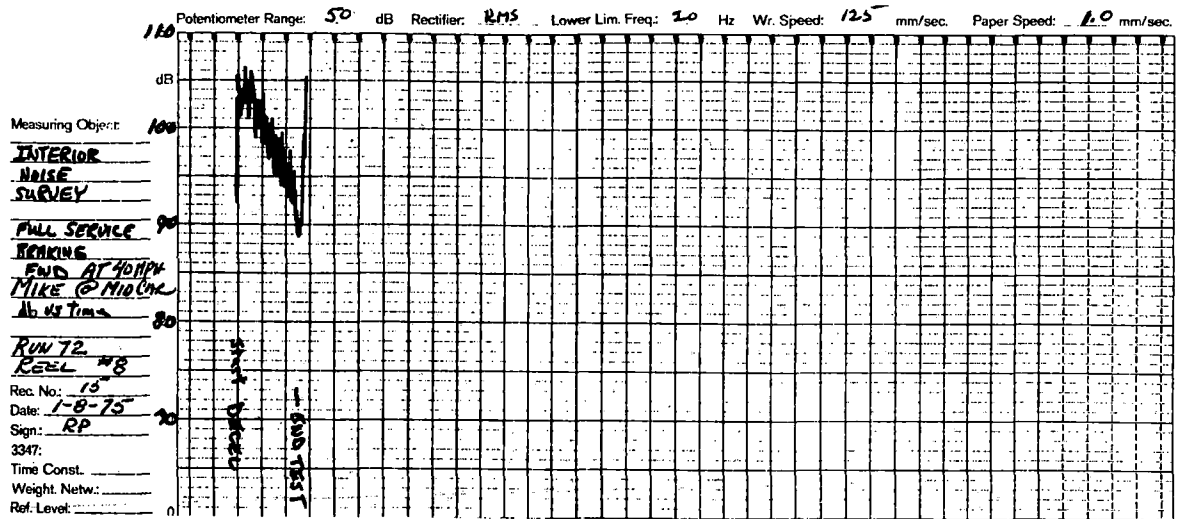

Figure 8-1. Interior Noise Test - Deceleration Effect

9. GLOSSARY

Ampl vs Freq plot	Log-log plot or semi-log plot of data
AWO	Vehicle empty weight
AW2	Vehicle empty weight plus full load
AW3	Vehicle empty weight plus crush load
CB	Carbody
DOT	Department of Transportation
ESC	Energy storage car
ESS	Energy storage system
FWD	Forward
F.S.	Full scale
F/W	Flywheel
H.P.	Hewlett Packard
MTA	Metropolitan Transportation Agency
NA	Not applicable
NYCTA	New York City Transit Authority
PAR	Parallel
QSD	Quick shutdown
REV	Reverse
RQD	Required
SER	Series
SW	Switch
TSC	Transportation Systems Center
TTC	Transportation Test Center
T/M	Traction motor
UMTA	Urban Mass Transportation Administration
X-Y Plot	Graphical data presentation obtained by running analog magnetic tape into an X-Y plotter with minimum filtering.

U. S. DEPARTMENT OF TRANSPORTATION

TRANSPORTATION SYSTEMS CENTER

KENDALL SQUARE, CAMBRIDGE, MA. 02142

OFFICIAL BUSINESS

PENALTY FOR PRIVATE USE, \$300



POSTAGE AND FEES PAID

U. S. DEPARTMENT OF TRANSPORTATION

518