

Resistance of a Freight Train to Forward Motion

METREK Division of The MITRE Corporation, MTR-7664

21-Freight Operations

**PROPERTY OF FRA
RESEARCH & DEVELOPMENT
LIBRARY**

MITRE Technical Report

7664

Resistance of a Freight Train to Forward Motion

John D. Muhlenberg

November 1977

Contract Sponsor: DOT/FRA

Contract No.: DOT-FR-54090

Project No.: 274A

Dept.: W-23

This document was prepared for authorized distribution.
It has not been approved for public release.

METREK Division of The MITRE Corporation
1820 Dolley Madison Blvd. McLean, Virginia 22101

MITRE Department
and Project Approval:

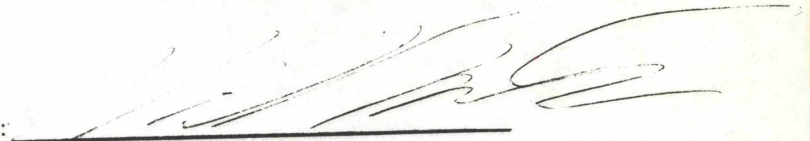
A handwritten signature in black ink, written over a solid horizontal line. The signature is stylized and appears to be a name with a surname.

ABSTRACT

This interim report documents the results of the initial portion of an intensive investigation of the train resistance phenomenon. The history and development of prior investigations are discussed and the formulas for train resistance developed by investigators in the U.S. and abroad are analyzed with respect to their present applicability to the phenomenon. Factors contributing to the considerable discrepancies among various formulas are discussed. A methodology suitable for a quick and accurate solution of the hitherto ignored problem of the air resistance of different arrangements of the same consist is developed and utilized in determining train resistance. Preliminary estimates of reductions in train resistance and consequent fuel and cost savings resulting from possible modifications to train and track technology are given. Recommendations are made for further investigations during the remainder of this study and possible fruitful areas for new research. Two appendices explain the rationale behind the calculation of air resistance of various consist arrangements and discuss the related computer program in detail.

ACKNOWLEDGMENT

The author would like to express his appreciation to Mr. John Anderes for his considerable assistance in setting up certain logical steps and "DO" loops in the computer program used to perform the calculations whose results are presented in the report. He would also like to acknowledge gratefully the contributions of Mr. Robert Martin, who wrote the section on Benefit Cost Methodology.

TABLE OF CONTENTS

	<u>Page</u>
1.0 INTRODUCTION	1
2.0 HISTORY AND DEVELOPMENT	4
3.0 COMPONENTS OF RESISTANCE	8
4.0 SPECIFIC FORMULAS OF RESEARCHERS	16
4.1 The Schmidt Formulas	16
4.2 The Tuthill Formulas	17
4.3 The Davis Formula	18
4.4 The Modified Davis Formula	19
4.5 Other Formulas	20
4.5.1 The E-L Variation	20
4.5.2 The Hoerner Formula	21
4.5.3 Foreign Formulas	21
5.0 COMPARISON OF RESULTS OF APPLICATION OF FORMULAS	25
5.1 American Formulas	25
5.2 Foreign Formulas	27
5.3 A Cautionary Note	27
6.0 FACTORS CONTRIBUTING TO DISCREPANCIES BETWEEN RESULTS	33
6.1 Temperature	33
6.2 Track Condition	35
6.3 Design of Trucks	37
6.4 Side Winds	37
6.5 Aerodynamic Drag and Length Considerations	39
7.0 A METHODOLOGY FOR APPROACHING THE AERODYNAMIC DRAG PROBLEM	48
7.1 Introduction	48
7.2 Division of Air Drag into Three Effects	51
7.2.1 Skin Friction Considerations	53
7.2.2 Front and Rear Pressure Effects	54
7.3 Computer Model	58
7.4 Results from Program Runs	59

TABLE OF CONTENTS (Continued)

	<u>Page</u>
8.0 PRELIMINARY ESTIMATES OF FUEL AND COST SAVINGS FROM REDUCED TRAIN RESISTANCE	66
8.1 Improved Roller Bearing Seals	68
8.2 Lightweight Equipment	71
8.2.1 Aluminum Hopper Cars	71
8.2.2 Lightweight Flatcars	73
8.3 More Favorable Consist Makeup	77
8.3.1 Average Train	77
8.3.2 TOFC/COFC Operation	78
8.3.3 More Unusual Trains	79
8.3.4 Summary of Consist Makeup Results	83
8.4 Improvement of Track Rigidity	83
8.5 Improved Truck Design	86
8.6 Other Modifications	88
9.0 BENEFIT COST METHODOLOGY	89
9.1 Improved Roller Bearing Seals	89
9.2 Lightweight Equipment	91
9.2.1 Lightweight Hopper Cars	91
9.2.2 Lightweight Flatcars	92
9.3 More Favorable Consist Makeup	93
9.4 Improvement of Track Rigidity	94
9.5 Improved Truck Design	94
10.0 FRUITFUL AREAS FOR NEW RESEARCH	95
REFERENCES	99
APPENDIX A METHODOLOGY OF TRAIN RESISTANCE CALCULATION AND RELATED COMPUTER PROGRAM	103
1.0 GENERAL CONSIDERATIONS BEHIND METHODOLOGY	103
2.0 RATIONALE BEHIND AIR DRAG CALCULATIONS	115

TABLE OF CONTENTS (Concluded)

	<u>Page</u>
2.1 Coupling Factor	117
2.2 Area Factor	119
2.3 Combination of Factors	119
2.4 Skin Friction	122
2.5 Undercarriage Drag	123
2.6 Summary	124
 3.0 COMPUTER PROGRAM	 125
 APPENDIX B EXAMPLES OF PROGRAM INPUT FILES, DATA, AND OUTPUT FORMATS	 135
 BIBLIOGRAPHY	 147

LIST OF ILLUSTRATIONS

<u>Table Number</u>		<u>Page</u>
I	Results of Determination of Train Resistance from Program	63
II	Average Train Characteristics	67
III	Characteristics of an "Unusual" Train	82
A-1	Data for Rolling Stock	112
A-2	Explanation of Symbols	113
A-3	Coefficient Combination Logic	122

<u>Figure Number</u>		
1	Varieties of Rolling Stock, Comparative Sizes and Shapes	6
2	Comparison of Journal Resistance with Resistance Calculated from Constant Terms of Davis Formula for Various Weights on Axles	10

LIST OF ILLUSTRATIONS (Continued)

<u>Figure Number</u>		<u>Page</u>
3	Comparison of Magnitudes of Train Resistance Formula Terms	12
4	Various Resistances for Average Train, Low Speeds	14
5	Various Resistances for Average Train, High Speeds	15
6	Comparison of Resistances with 75 ton Car	26
7	Comparison of Resistances with 20 ton Car	28
8	Specific Tractive Resistances in Different Countries	29
9	Resistance of Short Train of 10 Boxcars, Loaded	30
10	Resistance of Longer Train of 68 Boxcars, Empty	32
11	Decrease of Resistance with Time	34
12	Increase of Resistance after Stops	34
13	Resistances with Different Rail Weights	36
14	Relationship of True Drag to Skin Drag	46
15	Representative Conventional Freight Trains	49
16	Mixed Consist of Less Conventional Rolling Stock	50
17	Examples of Various Shielding Effects on Center Car	52
18	Examples Showing Proximity and Area Match Effects	55
19	Examples Showing Partial Proximity and Area Match Effects	57
20	Different Arrangements of Consist of Less Conventional Rolling Stock	61
21	Different Arrangements of Consist of Conventional Rolling Stock	62
22	Total Train Resistance for Three Consists	65
23	Reduction of Resistance of Average Train with Improved Bearing Seals	69
24	Comparative Train Resistance of Selected TOFC Consists on Level Tangent Track	74
25	Comparative Resistance of Selected COFC Consists on Level Tangent Track	75
26	Rearrangement of Mixed TOFC Consist	80
27	Reduction in Resistance of Average Train Due to Infinitely Stiff Track	85

LIST OF ILLUSTRATIONS (Concluded)

<u>Figure Number</u>		<u>Page</u>
A-1	Locomotive, Boxcar, Hopper Car	104
A-2	Gondola, Tank Car, Caboose	105
A-3	Flat Car, Flat Car with Special Freight, Container Well Car	106
A-4	TOFC with Single Trailers, Front and Rear	107
A-5	TOFC and COFC, with Twin Trailers and Containers	108
A-6	COFC with Single Containers, Front and Rear	109
A-7	Stak Pak or Hi-Cube Car, Auto Rack Car	110
A-8	Derivation of Effective Gap Size	118
A-9	Coupling Factor as a Function of Gap Length	120
A-10	Program Listing	127
B-1	Sample "TRAIN" and "ORDER" Files	136
B-2	Normal "ORDER" File for 70 Car Train	137
B-3	Random "ORDER" File for 70 Car Train	138
B-4	"TRAIN" File for "Average" Train	139
B-5	"TRAIN" File for Mixed TOFC Consist	140
B-6	Sample Data Output, Minimum	141
B-7	Sample Data Output, Complete	142

EXECUTIVE SUMMARY

The need for a suitable means for computing the resistance of a train to forward motion has existed almost since the beginning of modern railroading, to enable operating departments of railroads to predict schedules and match locomotives properly to the consist. As a consequence, several empirical expressions for calculating this resistance have been developed over a period of time in this country and abroad. Until recently, these formulas were sufficiently accurate to fulfill the railroads' needs.

Now, with fuel costs rising sharply, the need for accurate prediction of fuel consumption and for the means to reduce it through reduction of train resistance has become acute. The annual fuel bill of the nation's railroads is large: \$1.2 billion. Even a small reduction of this amount will save a considerable sum of money. Hence, new interest in train resistance and the possibilities for its reduction has arisen.

In this country train resistance formulas for freight trains were developed before the first World War by Schmidt and in 1937 extended to higher speeds by Tuthill. In the meantime, in 1926, Davis had developed a formula for the resistance of a single car. These expressions constituted the body of knowledge in this country concerning train resistance until in response to the replacement of friction bearings by roller bearings and the higher speeds of freight trains a "modified Davis" formula was developed.

These expressions show a considerable difference in the values of train resistance across the spectrum of operating velocities. It is believed that the "modified Davis" formula is presently the most accurate in American usage, but the possible deviation from the calculated value in using it is believed to be fairly high, on the order of $\pm 20\%$, depending upon the consist itself and other factors. As an example, a more accurate assessment of the air drag for piggy-back equipment requires tripling the aerodynamic coefficient used in the expression. Thus with mixed consists it is believed to lose considerable accuracy.

It is unfortunately possible, through an adverse choice of formula or train, to arrive at mistaken conclusions. An example is given which shows in one instance that air resistance is less than one half the total of other resistances and in the second instance that air resistance is more than three times the total of other resistances for the same speed. It would be possible to conclude

mistakenly in the first instance that air resistance was negligible for freight trains or that it was of overwhelming importance in the second instance.

These considerations, together with the realization that the arrangement of the consist itself is an important part of the train resistance problem, lead to the conclusion that at the present time methods of calculating train resistance are inadequate to calculate the resistance of a given consist with the degree of accuracy desired.

In order to provide a remedy, a methodology is developed in the body of the report which, when properly "tuned" and validated, could be used to make more accurate calculations of the resistance of a given consist than usage of a single blanket formula. The methodology computes the total resistance for each car in the train, depending upon its loading and its position with respect to the other cars in the consist. While making use of the initial terms of the modified Davis formula to compute the mechanical and velocity-dependent resistances of each car, the air resistance of each car is calculated as the summation of a front pressure effect, a skin friction effect, a rear pressure effect, and the drag of two trucks and the underside of the vehicle. These five items were formerly lumped together into a single coefficient. Since it can be demonstrated through the use of this technique that train resistance depends strongly upon the arrangement of the cars in the consist, it should permit more accurate calculation of the resistance once the methodology has been refined. Two appendices to the report explain the rationale behind the calculation of air resistance of various consist arrangements and discuss in detail the computer program devised to perform the calculation.

Unfortunately, the accurate data base upon which such a methodology must be based in order to obtain accurate results is lacking. Information regarding the air resistance of normal freight cars and the possible shielding effect they have upon the following car is almost non-existent. However, a table of data on existing types of rolling stock has been compiled, and the information therein is the best available. On that basis, through the use of a computer program devised especially to implement this methodology, calculations of train resistance were made for the examples used in the remainder of the report. The program permitted the easy modification of the calculation to reflect changes in the design of rolling stock or track which potentially would affect train resistance. In addition, it permitted the calculation to be made for any specified arrangement of the consist.

The areas of potential benefit which have been explored using this methodology are improved roller bearing seals, the use of lightweight equipment, rearrangement of the consist, improvement of

track rigidity, jointed rail vs. welded rail, and finally truck design. It must be noted that the data base upon which the calculations in this report have been founded is lacking significant information, mainly because up to this time the need for the collection of such information has not been recognized. As a consequence the gaps in the data base were filled by extrapolation from the existing data, or by estimation. Nevertheless, the results are believed to be as accurate as the state of knowledge and theory permits today. However, because of this area of uncertainty, all the conclusions with regard to magnitude of reduction of train resistance and the consequent fuel savings must at this time be regarded only as tentative and preliminary, and indicative of a direction in which to make future more detailed investigations.

(1) Improved Roller Bearing Seals

The friction in the seals accounts for a surprisingly large portion of power consumption. Claims have been made that a new seal design can reduce this friction by 31% over the worst comparable case and 18% on the average. These figures reflect a savings to the railroads, based on complete replacement and total freight car mileage, of \$57.5 million and \$33.4 million per year, respectively, on fuel bills.

(2) Light Weight Equipment

Two different possibilities were examined, light weight aluminum hopper cars and light weight flat cars for intermodal service. Complete replacement of the fleet of 595,595 hopper cars with aluminum cars, carrying the same freight load, would save the railroads \$3.9 million per year in fuel costs, not nearly as much as the bearing seal replacement. On a different basis, if the weight saved were used to haul additional freight, the additional annual revenue would be only \$1100 per car, making it difficult to justify the additional initial investment of \$36000 to \$44000 per car. In addition to the apparently poor economic justification for such replacement, the situation has been clouded further by the recent appearance of lighter weight steel hopper cars. Probably both of these aspects have contributed to the fact that aluminum hopper cars have not been manufactured for some time in this country.

For the intermodal light weight flat cars, the picture is more favorable. The drag on the average train at 60 mph is reduced 768 lbs. for the TOFC train and 1214 lbs. for the COFC train, substantially more in the latter case than the reduction attributable to use of aluminum cars. The reduction is biased in favor of the COFC train because the absolute reduction in weight is greater. At lower speeds the reduction is smaller, but with an average reduction of 826 lbs.,

over the mileage attributable to TOFC/COFC operation, annual savings of \$1.9 million in fuel costs result. It is smaller than that saved through use of the light weight hopper car since there are fewer cars and fewer ton-miles carried in this type of operation.

(3) Rearrangement of the Consist

Deliberate rearrangement of an average mix of ordinary rolling stocks shows the possibility of a reduction of train resistance of up to 13%, whereas the spread attributable to random arranging is approximately $\pm 1.5\%$. A unit boxcar train shows a resistance 6% lower than the rearranged average mix. Rearrangement of a unit TOFC or COFC consist will show no improvement, but rearrangement of a mixed consist (50% single trailer or container on flat car) shows an 11% improvement potential. The figures are more dramatic when an unusual mixture of intermodal, special purpose, and conventional rolling stock is used. Fuel consumption per mile for all these operations can be reduced in the same proportion. These figures are large enough that they suggest strongly that further study be given to the potential here.

(4) Track Improvement

The contribution of the track to train resistance can be lessened in two ways: through stiffening of the rail itself and the track substructure, and by using welded rail instead of jointed rail to eliminate the energy loss in jumping the gap between rail lengths. It seems possible that as a limit, resistance can be lessened by from 9% at 60 mph to 26% at 20 mph, where the air drag is not of such overwhelming magnitude. These reductions are directly relatable, as before, to fuel expenditures.

(5) Improved Truck Design

Like the contribution of the track to train resistance, the contribution of the truck appears to be limited to a certain value, beyond which no further improvement can be made. It is unrealistic to expect to realize more than a small portion of this full potential. Complete elimination of the velocity-dependent term (which reflects flange resistance, which in turn is function of truck design, among other things) results in a 3.8% reduction of train resistance. As with the others, this figure is directly translatable into fuel savings. However, it seems likely that improvement of truck design will save more through reduction of lading damage than through reduction of train resistance.

It is evident from the analysis of potential reductions in train resistance and the review of the state-of-the-art in predicting it that there are certain areas which require further study. Because of uncertainties in the data base, there is uncertainty in all the results given above. Nevertheless, certain requirements and needs stand out above others. MITRE's recommendations at the present time are as follows:

- (1) The origins of the modified Davis formula and the rationale behind its development must be determined so that confidence may be established in the basic theoretical formulation.
- (2) Fundamental information on the air drag of ordinary freight cars is needed. At the present time the lack of such information makes any conclusions regarding the resistance of such trains or any trains questionable.
- (3) The validity of the methodology for determining the resistance of a freight train as a function of the arrangement of the consist as developed in this report should be established. At the present time there is no other method known for solving this problem.
- (4) Bearing seal friction appears to be a fruitful area for reduction of train resistance. The functional dependence of this friction upon weight and velocity should be established more firmly than present understanding permits if meaningful conclusions are to be drawn regarding the effects of its reduction.
- (5) The effect of rigidizing the rail sub-structure and the rail itself and also substituting welded rail for jointed rail is a subject which deserves further study, as the potential seems high for effecting meaningful reductions in resistance through these techniques.
- (6) Additional information beyond what is presently available regarding TOFC/COFC operations needs to be assembled so that conclusions which are more meaningful may be drawn regarding possible changes in its operations.
- (7) The conclusions in this report are predicated completely upon operation over level tangent track. Some more representative routes need to be established on the basis of a statistical survey of route miles so that conclusions having a more realistic basis may be drawn.

- (8) The areas in which train resistance appears to have the most promise for realistic and meaningful reductions are bearing friction, consist rearrangement, and track stiffening. Light weight equipment does not appear to offer quite as large a potential based upon level tangent track; however, over more realistic terrain, because of the predominance of grade resistance, this conclusion could easily be modified. The relation of truck design to train resistance is possibly more tenuous than others and is probably more related to lading damage than fuel consumption.

MITRE expects as part of its continuing work on this task to examine the effects above which are recommended for further study. It is recommended that the areas for research in the field such as wind tunnel tests, full scale aerodynamic tests, and fuel consumption tests be emphasized both to fill the gaps in the data base and validate certain aspects of theory.

1.0 INTRODUCTION

The subject of train resistance, the resistance of a train to motion along the direction of the track, is a subject which is not readily amenable to theoretical analysis or easy determination through field testing. The inherent nonlinearities of frictional forces, the uncertainties regarding the sources of apparent resistance, and the dependence of forces upon various powers of velocity make analysis difficult, and variegated test conditions in the outdoor environment over which the experimenter has little control present difficulties in obtaining consistent data. Nevertheless, a need for expressions which would enable operating departments of railroads to predict schedules and allocate locomotive horsepower on the basis of information about the resistance of the consist has existed almost since the beginning of modern railroading, and over a period of time empirical formulas have been developed to serve this purpose.

Until recently, these formulas proved to be sufficiently accurate to serve the needs of the railroads, and little further interest in the subject developed. However, interest has recently been revived because of the repercussions of changes in railroading operations. Coal-burning steam locomotives have been replaced with diesel-electrics; higher speeds, if not more common, receive more emphasis; many new types of rolling stock have been introduced; and most recently, the price of fuel has risen sharply. These changes have meant that the formulas applicable to former types of rolling stock and lower speeds are no longer reliable. At the same time, accurate predictions of train resistance, because of its relation to fuel consumption, have assumed more importance in the face of rising fuel prices.

While fuel costs represented only about 8.5% of total operating expenses of the railroads in 1975 and 1976, the total fuel bill for the

nation's railroads is estimated to be over \$1.2 billion per year.¹ The significance of only a 10% reduction in fuel costs is quite evident. Hence any contribution to such a reduction which an investigation of train resistance and its subsequent reduction would make would clearly be beneficial.

The dependence of train resistance upon weight has generated interest in light-weight equipment; its dependence on mechanical friction has generated interest in better bearings and seals; its dependence upon aerodynamic drag, which apart from grade considerations becomes the dominant resistance at high speeds, has stimulated recent interest in wind tunnel testing and full scale validation of the results. However, the full extent of the reduction in train resistance attributable to these areas and others which appear as a result of the investigation discussed in this report remains to be determined.

At the present time, much basic information is lacking, particularly in the aerodynamic area, where information on the drag of ordinary rolling stock, not to mention some of the more unconventional modern pieces of equipment in use today, is notably lacking. The recent work of Hammitt (see Bibliography) is a useful contribution in this area, but its scope was limited to TOFC/COFC and related intermodal equipment; there have been relatively few reports concerned with ordinary rolling stock. A few foreign articles dealing with aerodynamic drag of passenger vehicles have been examined and some of the results reported herein; however, this report, because of the natural emphasis placed upon freight movement by American railroads, is primarily concerned with freight trains.

¹The source for this information was the AAR Yearbook of Railroad Facts, 1977 Edition.

Although this interim report makes some preliminary judgements on the cost effectiveness of various improvements which could be effected to reduce train resistance and hence fuel consumption, until better data and more information are available it will be difficult to make more than preliminary assessments of the possible financial benefits of reduction of train resistance through particular improvements in the design of track or rolling stock. It is hoped that this report, besides being an assessment of the state-of-the-art, will both stimulate interest in the field and lead the way to areas where further work is needed, so that more definitive conclusions can be reached.

2.0 HISTORY AND DEVELOPMENT

The earliest work in this country in the area of train resistance appears to be an attempt to measure the air resistance of a street railway car. This experiment took place in 1906; the streetcar was set upon a balance on top of a railroad flatcar and pulled at various speeds. Professor Schmidt of the University of Illinois in 1910 published a series of formulas derived empirically from tests on full scale freight trains. As the tests were run only to 40 mph, the formulas were not necessarily applicable to higher speeds. Later Professor Tuthill, in an article published shortly after World War II, presented another series of formulas applicable to higher speeds which was based principally on some tests run in 1937 on the Illinois Central System. In the meantime (1926) W. J. Davis, Jr., had published his own formula which has been more generally used in this country since that time.

Development of train resistance formulas occurred in foreign countries during the same period. A formula was developed in Germany by Strahl in 1913 and in the Soviet Union by Mukhachev in 1927. Similar formulas were developed in England and France in the late twenties and early thirties. The Russian formulas have been subsequently revised in 1956, 1963, and 1968; the French and German national railways also updated their original working formulas during the same period. British Railways has apparently only recently come to realize the obsolescence of their information. It is not quite clear what formulas were in use in Japan before the Second World War, but probably the devastation resulting from the war contributed to the subsequent obsolescence of previous information; the construction of the high speed New Tokaido line also contributed to a need for better data and improved formulas, and some recent work has consequently been published there.

In this country, until the advent of higher speed trains and less conventional rolling stock, persons in the field seemed content to rest

mainly with the Davis formula. However, it gradually became recognized that the Davis formula was not quite accurate when applied to newer and faster trains. Radical changes have been introduced into the forms of rolling stock which now comprise freight trains. Such items as piggy-back and containerized freight equipment, high capacity box cars, and auto-rack cars are examples of components of contemporary freight trains which had not been conceived in the days when the Davis expression was formulated. Figure 1 illustrates in scale outline the comparative sizes and shapes of both conventional rolling stock and some of the modern innovative items of equipment.

At least partially as a consequence of the use of such unconventional equipment, a modified version of the Davis formula, which resulted from some tests run by the Canadian National Railway (CNR) using some modern equipment, has become as widely used as the original version. More recently, circa 1965, a modification to that version was developed by the Erie-Lackawanna (E-L) Railroad for use with piggy-back trains and trains of auto-rack cars, as these trains were proving to have considerably more drag than trains hauling more conventional equipment.

Although some experimental work is presently being performed under contract with the U.S. Department of Transportation in the form of wind tunnel testing and field tests to improve the understanding of the aerodynamic drag of freight trains, and although some new drag coefficients have been established as a result for some special items of equipment, the work has not yet resulted in a totally new expression for the determination of train resistance. The CNR and E-L modifications to the Davis formula represent the most current generally accepted formulations of such expressions in use in this country today.

Because of the apparently greater interest in high speed operation and passenger service in Germany, France, and Japan, there have been

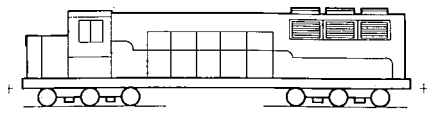

D-E Locomotive

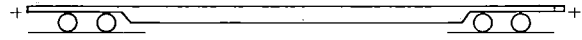

TTX Flatcar



Boxcar

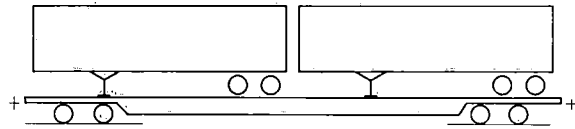

TOFC, Twin Trailers

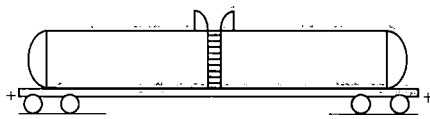

Tank Car

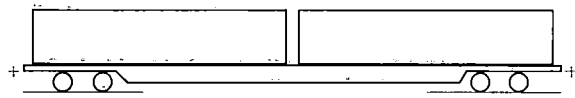

COFC, Twin Containers

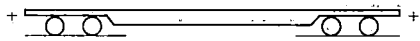

Flatcar

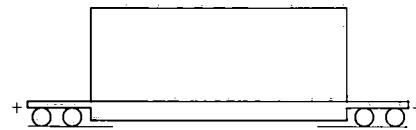

Container Well Car

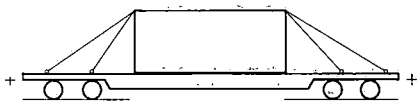

Bulky Freight on Flatcar

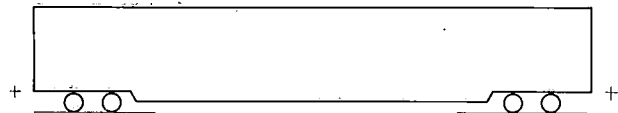

Hi-Cube Car

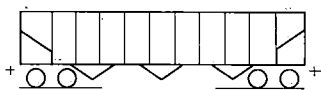

Hopper Car

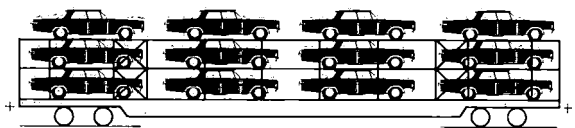

Auto Rack Car

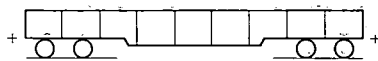

Gondola Car

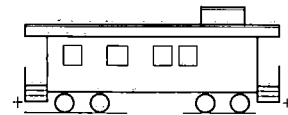

Caboose

FIGURE 1
VARIETIES OF ROLLING STOCK, COMPARATIVE SIZES AND SHAPES

several recent reports of investigations into the resistance of high speed passenger trains and commuter-type equipment. Unfortunately, most of this information is irrelevant to freight operations in this country. For this reason, specific discussion of foreign formulas will be limited to occasions where parallels can be drawn or there is particular relevance to the subject at hand.

No major mechanical improvements have been introduced into railroad operation in recent years approaching the extent and effect of the substitution of roller bearings for plain bearings, and as a consequence information for ordinary freight cars on the drag due to mechanical friction and velocity-dependent resistances caused by parasitic vehicle motions is reasonably complete. In contrast, corresponding information on air drag for such ordinary rolling stock as tank cars, boxcars, and hopper cars, not to mention the newer types of rolling stock, is virtually nonexistent. Most of the information stems from the original work of Davis in 1926 [1].² However, with the continuation of the present programs sponsored by the U.S. Department of Transportation Federal Rail Administration, more data should become available. It is with that expectation that the methodology for calculating more accurately the aerodynamic drag of a freight train with the widely mixed consist described in the later portions of this report has been developed.

²Figures in brakcets refer to references.

3.0 COMPONENTS OF RESISTANCE

Possibly because it is mathematically convenient, most researchers have proposed a formula for train resistance on level tangent track, of the form:

$$R = A + BV + CV^2 \quad (1)$$

in which

R = train resistance

V = train speed

and the coefficients are assigned various values, depending upon the particular author. If R is the total resistance on an absolute basis with dimensions in lbs., the coefficients A and B are functions of the vehicle weight and number of axles, while the coefficient C is a constant. Usually, however, the resistance R is referred to on a lb./ton basis. In this report it will be convenient to utilize both types of expressions. Where the context does not make the usage clear, it will be noted specifically which resistance is referred to.

If the train is accelerating, ascending a grade, or traversing a curve, additional constant terms must be introduced to account for these factors: a figure of .8 lb per ton per degree of curvature is recommended by AREA, see Hay [2]; and figures of 20 lbs. per ton per percent grade for grade resistance and 91.1 lbs. per ton per mphs for acceleration are derivable from fundamental laws of mechanics. An increase of mass is often used to account for rotational inertia in computing acceleration forces; this amounts to anywhere from 5% to 12%; thus a figure of 100 lbs. per ton per mphs is often used [3-4]. These figures are not normally included in the resistance expressions directly, however.

Not all authors are in agreement concerning the factors attributable to each of the above coefficients, and probably there is in actuality considerable overlapping of effects. Nevertheless, the discussion

following is believed to reflect the feelings of most authors regarding these factors, insofar as it is possible to admit to such simplification.

The term "A" includes various mechanical or friction drags and at least a portion of it appears to be weight-dependent. Hay [2] divides this term into three elements: rolling resistance, track resistance, and journal resistance. Rolling resistance arises from friction between the wheel and the rail, and energy is dissipated when slippage occurs; an additional small amount is dissipated through flattening of the rail and wheel surfaces. Track resistance is attributable to a component of force opposing the forward motion of the train which arises from the deflection of the rail due to car weight. Journal resistance is simply friction in the axle bearings. There are considerable discrepancies among the values used for "A" among various authors, and it is not entirely clear which effects contribute most to the term. However, Keller [3] has plotted a curve comparing journal resistance for sleeve-type friction bearings with the resistance calculated from the "A" term from the Davis formula; it appears that the journal resistance is one of the smaller contributors. See Figure 2. This is reaffirmed by Gluck [5] in the case of roller bearings.

The "B" coefficient comprises all effects which can be considered to be dependent upon the first power of the velocity. Flange resistance, caused by the nosing action of the truck and car and the consequent impacting of flange upon rail, is a major portion of this coefficient [1-2]. In general, the ride quality of the trucks seems to contribute to this coefficient [3]. The design of the trucks certainly relates to energy dissipation due to hunting. Also lumped into the coefficient are the energy dissipated in the swaying and jostling of the rolling stock, and the velocity-dependent energy dissipation in the deflection of the track and substructure.

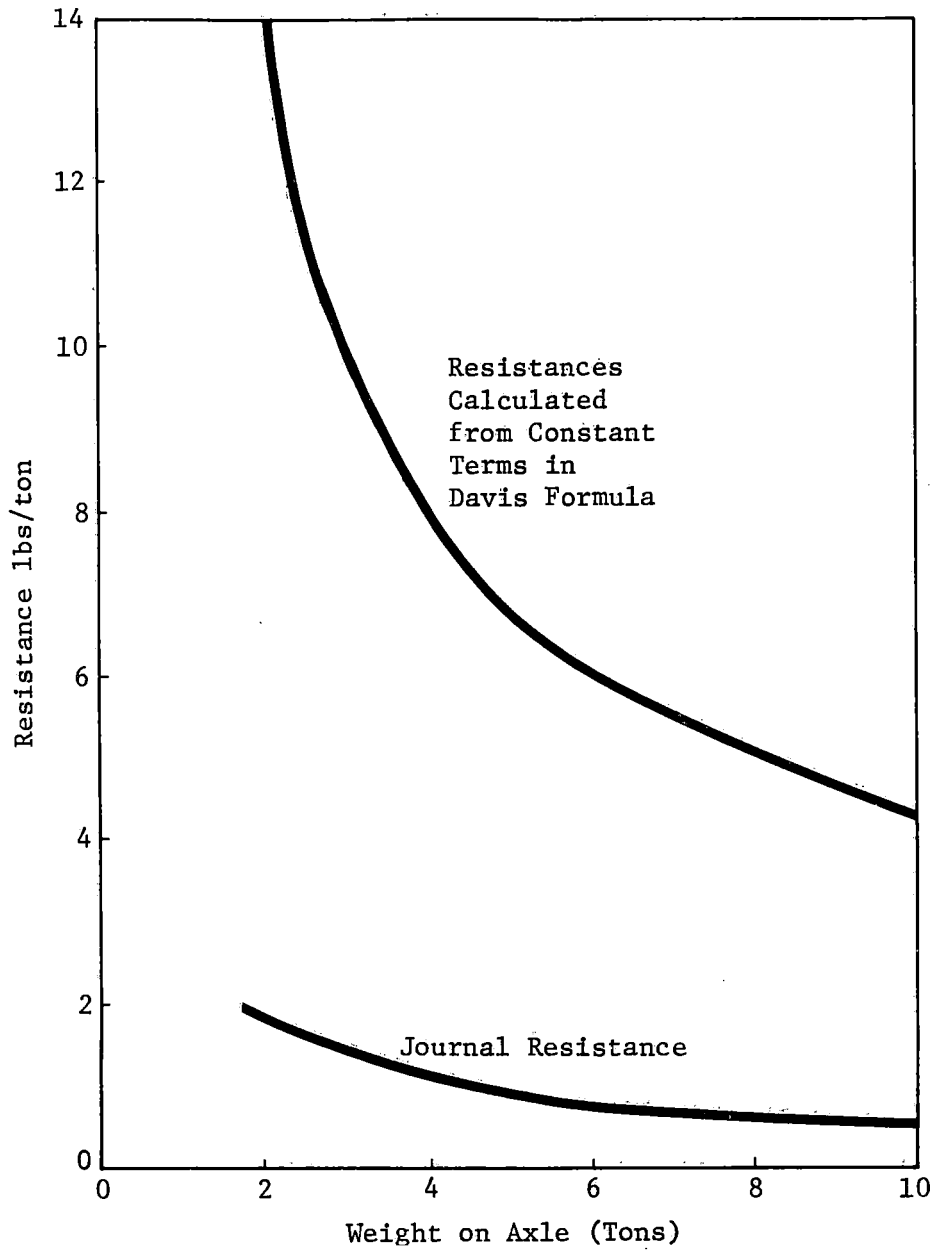

FIGURE 2
COMPARISON OF JOURNAL RESISTANCE WITH RESISTANCE
CALCULATED FROM CONSTANT TERMS OF DAVIS FORMULA
FOR VARIOUS WEIGHTS ON AXLES

The "C" coefficient is generally agreed to comprise the effect of air resistance, although it is not inconceivable that other, unknown effects are proportional to velocity squared. But even without consideration of this possibility, the term itself is only an approximation, as it is known that the air drag is a combination of shape effects and skin friction [1] [6], the latter of which theoretically varies as $V^{1.85}$ rather than V^2 , and both effects are lumped into the single term. However, there are obvious advantages to such simplification if accuracy is not greatly diminished.

While the preceding discussion is equally applicable to both passenger trains and freight trains, the remainder of this report will be concerned solely with freight trains, unless specifically stated to the contrary. Overall weights, lengths, shapes, truck designs, body smoothness and other characteristics of rolling stock significant in determination of resistance are for passenger cars markedly different from those for freight cars and constitute a separate topic. However, given the state-of-the-art, certain general considerations with regard to passenger trains are still applicable to freight trains, particularly with regard to aerodynamic resistance, where knowledge is relatively limited at this time, and certain conclusions regarding freight train aerodynamic drag will be postulated from research on passenger car bodies.

Figure 3 illustrates for a particular formula and at lower speeds (up to 35 mph) the relative magnitude of these various components of train resistance for an average length train of a particular weight, as a function of velocity. Note that of the three terms the mechanical resistance predominates. Because the magnitude of the second term is so small, several modern authors drop the term completely [5], [7], [8].

The various formulas do not take into consideration other effects which affect drawbar pull, such as the resistances attributable to

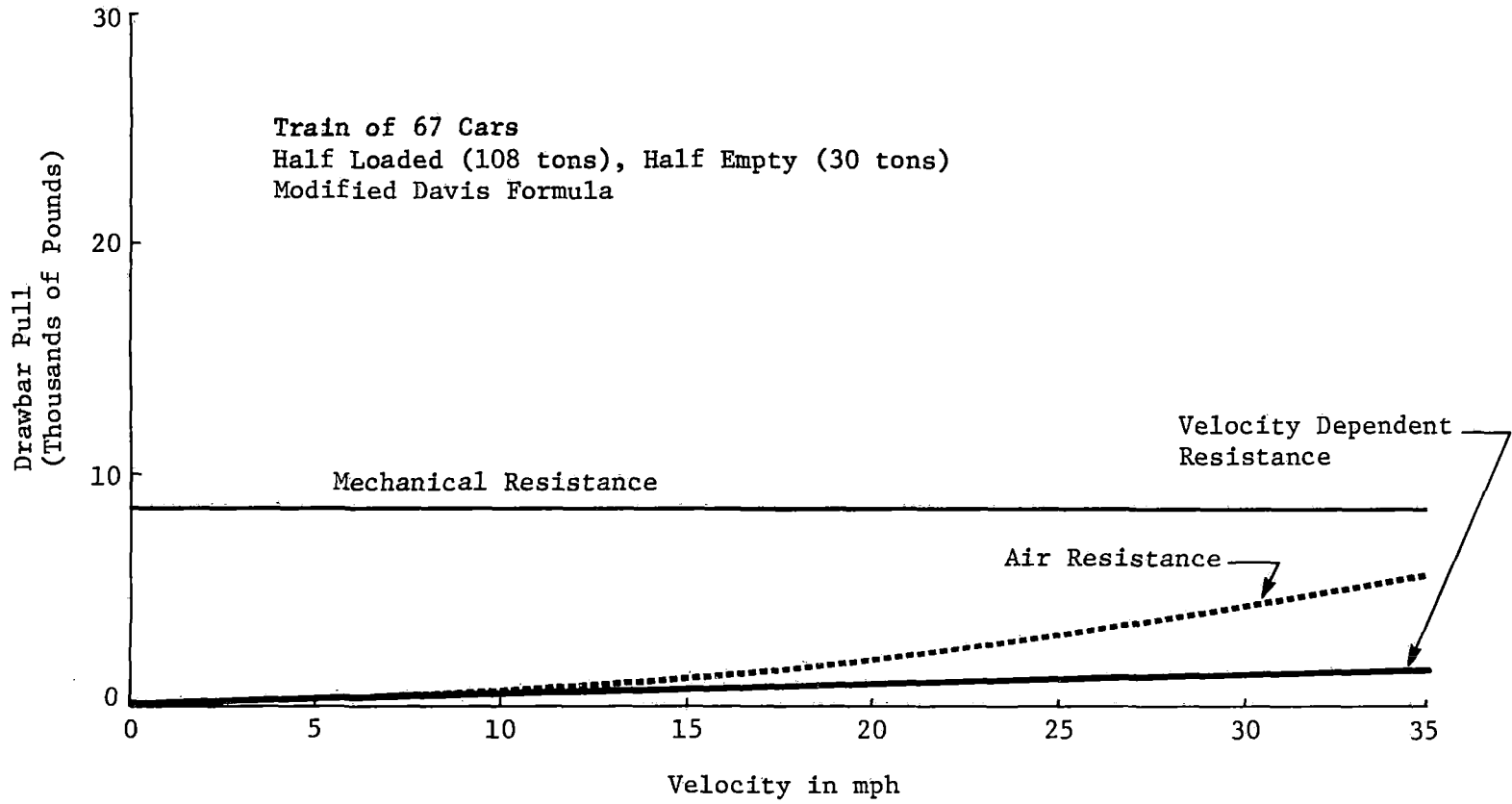

FIGURE 3
COMPARISON OF MAGNITUDES OF TRAIN RESISTANCE FORMULA TERMS

grade, curvature, and acceleration. Figure 4 illustrates the magnitude of the resistances attributable to these effects in relation to the data of Figure 3. The values of the grade, curvature, and acceleration were arbitrarily chosen but are reasonably representative. Note how the grade resistance predominates, even for such a small grade.

Figure 5 extends the curves of Figure 4 to higher velocities; note how the air resistance begins to predominate.

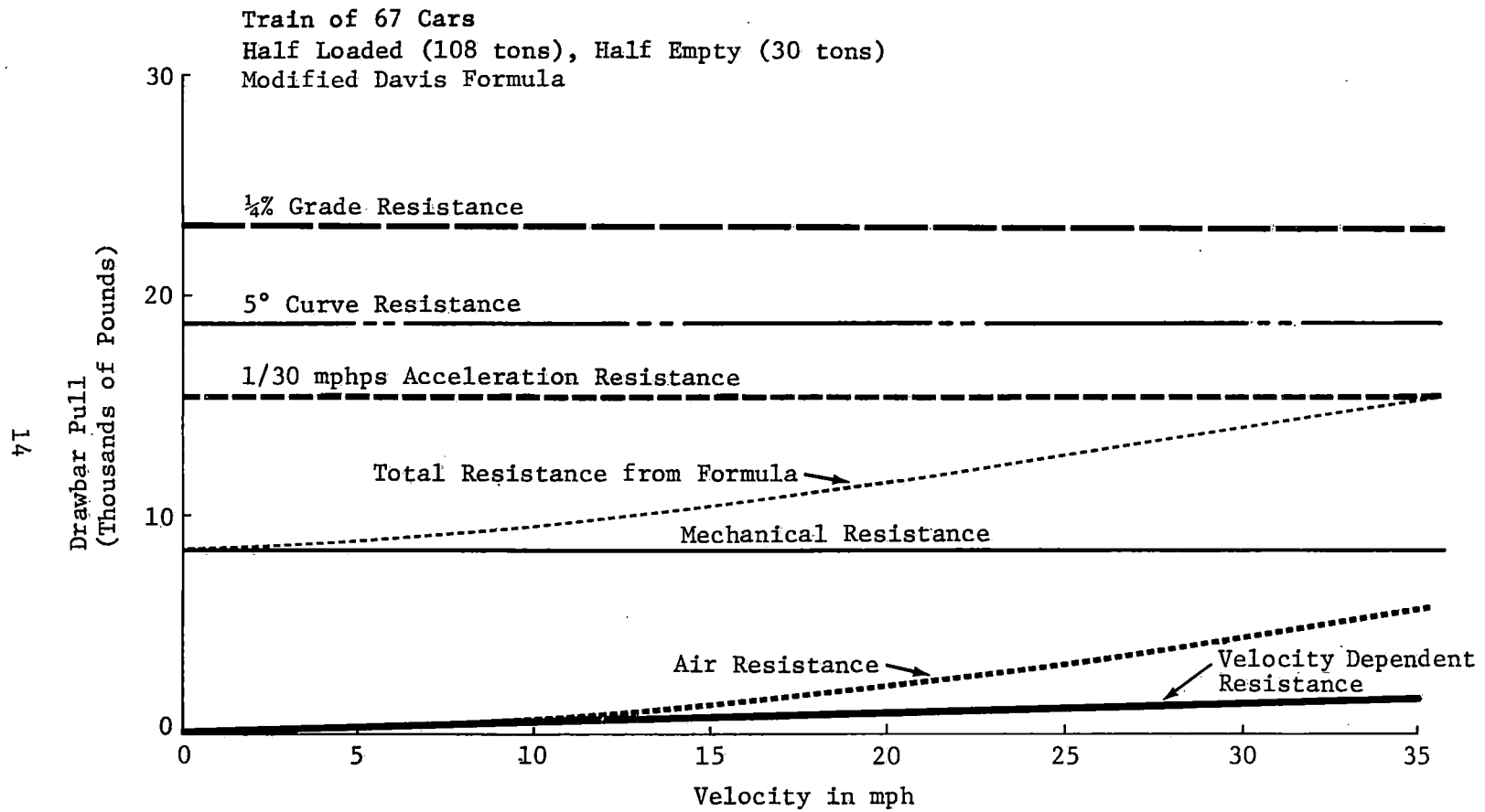

FIGURE 4
 VARIOUS RESISTANCES FOR AVERAGE TRAIN, LOW SPEEDS

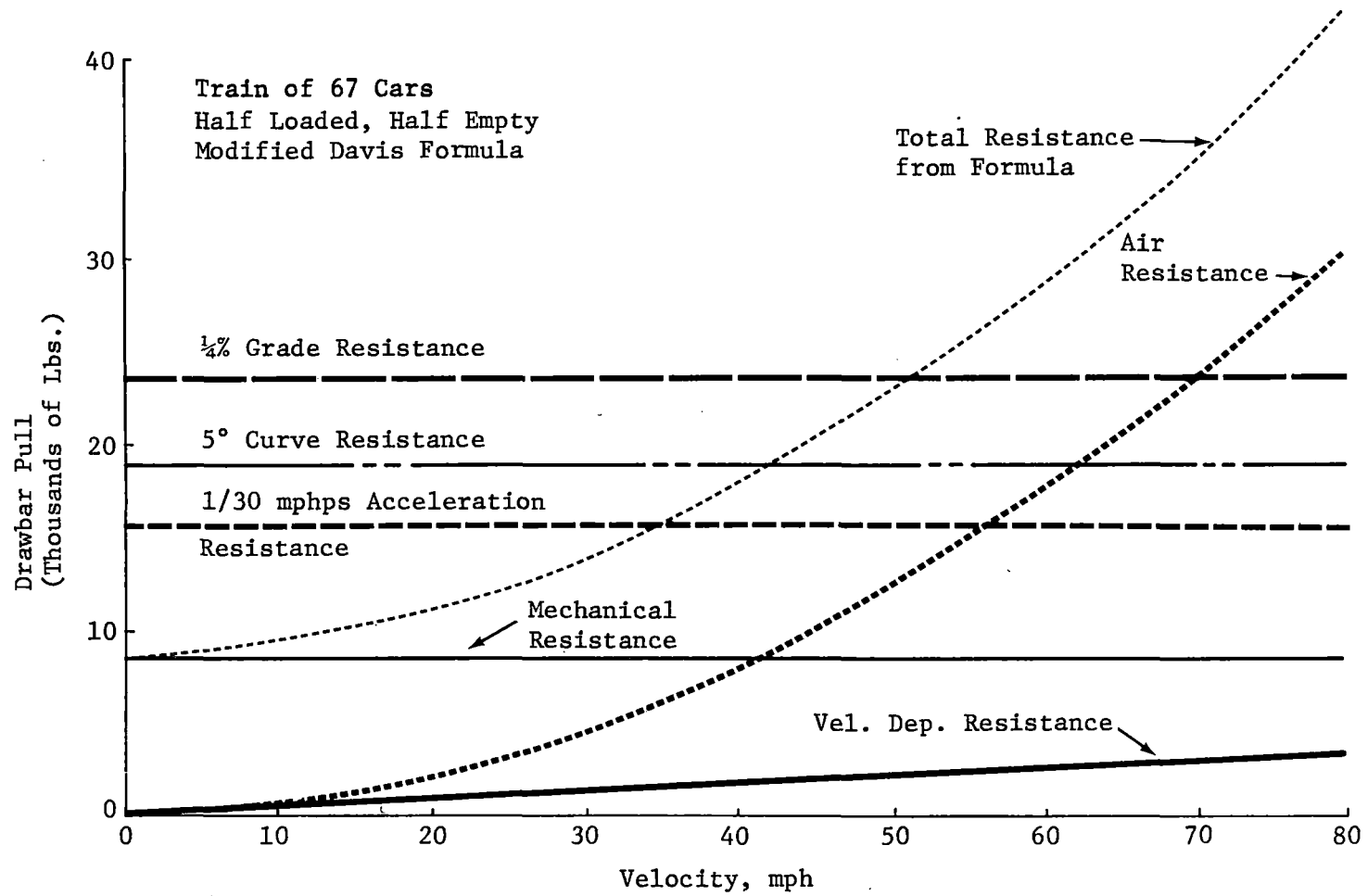

FIGURE 5
VARIOUS RESISTANCES FOR AVERAGE TRAIN, HIGH SPEEDS

4.0 SPECIFIC FORMULAS OF RESEARCHERS

4.1 The Schmidt Formulas

As noted earlier, Schmidt [9] published in 1910 a series of formulas for total train resistance, each formula being applicable to a train of a specific average car weight. The formulas were based upon empirical data, and the user was advised not to apply them to trains at velocities higher than 40 mph. At the time Schmidt developed this series of formulas, there seems not to have been much recognition that air drag was particularly appreciable, probably because normal freight train velocities were relatively slow, and no distinction between vehicles on the basis of their aerodynamic shape or their position in the consist was made. The above series of formulas applied to a train of cars and gave the specific resistance of the train in lbs./ton. For a train consisting of cars of gross weight of 75 tons each, the Schmidt formula for the train resistance in lbs. per ton of train weight, as most authors express it, is:

$$R = 2.87 + .019 V + .00113 V^2 \quad (2)$$

where V is expressed in mph. The total train resistance in lbs. is obtained from this expression by multiplying by the total train weight. Since this formula is predicated upon the average weight of the cars in the train, the expression may also be looked upon as yielding the specific resistance of a single car, in lbs./ton of car weight. It should be noted, however, that this expression, even though on a lb./ton basis, is not applicable to cars or trains of other weights and applies only to a 75 ton car, or to a train whose average weight per car is 75 tons; thus a different expression would be applicable to a car of 150 tons, or a train whose average weight is 150 tons per car. Such an expression would not equal twice the foregoing one.

4.2 The Tuthill Formulas

As the Schmidt formulas were not to be used at velocities above 40 mph, Tuthill [10] after World War II, based upon a series of tests conducted by the University of Illinois in 1937, produced another series of similar formulas, basically extensions of the Schmidt formulas, to be used at higher velocities. His formulas were also directed toward total train resistance based upon average car weight and yielded the resistance in lbs./ton, but, as with the Schmidt expressions, they may also be interpreted as yielding the specific resistance of a single car, in lbs./ton of car weight. Tuthill's formula for the resistance of a single car of 75 tons gross weight, in lbs./ton of car weight, would be:

$$R = .53 + .002 V + .0029 V^2 \quad (3)$$

It is worth noting that if the expressions are placed on an absolute basis, so that the resistance is measured in lbs., the coefficient of the V^2 term varies with the weight; as the weight increases, the coefficient increases. It has been noted that this is illogical, since the coefficient reflects the aerodynamic drag coefficient which is unrelated to weight [11].

A possible explanation is offered to explain this anomaly. Both Schmidt's and Tuthill's expressions are based upon average characteristics: average car weights and average consist makeup of actual trains. One can plausibly infer that the average density of the load, given a sufficient number of cars, was constant. In such a case, for a constant average cross-section, a heavier car will be longer, and the heavier trains will be longer trains for the same number of cars. It is known (see

later discussions on aerodynamics) that longer trains have more air drag than shorter ones, other things being equal, since much of the air drag is skin friction, a factor dependent upon train length. Unfortunately it is impossible to demonstrate the validity of this explanation, since only the weights were considered to be important, and no information was given on lengths of cars or trains.

4.3 The Davis Formula

Davis [1] formulated his expression in 1926 directly for a single car, rather than for a train; the expression included the number of axles as well as the weight and velocity, the original formula being:

$$R = 1.3 + \frac{29}{w} + bV + \frac{CAV^2}{wn} \quad (4)$$

where w = weight in tons per axle

b = experimental constant

n = number of axles per car

A = cross sectional area

V = velocity in mph., as before

C = aerodynamic coefficient

R = resistance in lbs. per ton of car weight

Davis did give recognition to differing velocity-dependent resistances and aerodynamic drags for various vehicles and published an accompanying table of recommended values for cross-sectional areas, the coefficient "b", and the aerodynamic drag coefficient. Values were provided for locomotives, passenger cars, freight cars, and a few other miscellaneous vehicles. For the same 75 ton car used above as an example, using Davis' recommended values, the expression for resistance in lbs./ton becomes:

$$R = 2.85 + .045 V + .0006 V^2 \quad (5)$$

The aerodynamic coefficient for a conventional locomotive was considerably higher, presumably because of its position as the leading vehicle as well as its different shape. The locomotive resistance was to be calculated separately; but the resistance of the cars was calculated as in the Schmidt-Tuthill formulas.

4.4 The Modified Davis Formula

The Schmidt-Tuthill expressions and the Davis formula were derived at a time when trains were lighter and when plain bearings rather than roller bearings were in general use [12]. In an attempt to remedy this growing inapplicability of these expressions, some tests were conducted by the Canadian National Railway using more modern equipment [12] [13]. These resulted in a modification of the Davis formula which became known as the modified Davis formula; the date of its origin is uncertain, but it was undoubtedly postwar. The formulation, in lbs. per ton of car weight, as reported in [14], is:

$$R = .6 + \frac{20}{w} + .01 V + \frac{.07 V^2}{wn} \quad (6)$$

For the same 75 ton car used in the previous example, this expression for resistance in lbs./ton becomes:

$$R = 1.67 + .01 V + .000933 V^2 \quad (7)$$

The differences between this and the Davis formula are worth noting. The two non-velocity dependent terms are both smaller, undoubtedly reflecting the somewhat smaller rolling resistance of roller bearings. The .6 figure reflects an effective coefficient of rolling friction of .0003 (.6 ÷ 2000) while the figure of 20 lbs. per axle closely relates to measured values of 5 lbs. per roller bearing seal, with four seals per axle. (See Section 9.2 for further discussion of this point.) Although some reduction in resistance has clearly been achieved here,

in general the advantage of roller bearings over plain bearings seems primarily to be the reduction in starting resistance, not running resistance. The reductions are approximately 80-90% and 10-15%, respectively [12] [15]. The coefficient of the velocity-dependent term is also smaller, possibly due to a diminution of coupled motions in the truck or carbody, although it is not clear what design improvements contributed to such a large reduction. The coefficient of the V^2 term is more than 50% larger, reflecting both an increased awareness of the importance of air drag as well as a slow (detrimental from the standpoint of aerodynamic drag) change in the nature of modern rolling stock.

While these changes seem reasonable, it has not been completely settled that the modified Davis formula is an improvement over the Davis formula. Hammitt [11] discusses the apparent dependence of the aerodynamic coefficient for TOFC/COFC equipment on speed when the modified Davis formula was used to correlate field data with theoretical values. Luebke [16] states that the difference between actual mechanical resistances, as measured by some tests performed by the Chesapeake and Ohio (C&O) Railroad in 1966, and the empirical values used in the CNR formula (modified Davis) was as much as 8%. However, since it appears to be somewhat more related to modern equipment, the modified Davis formula will be used hereinafter as a standard for computational purposes.

4.5 Other Formulas

4.5.1 The E-L Variation

As a subsequent extension of the effort to update train resistance expressions to relate them to modern equipment, in 1965 the Erie-Lackawanna RR, suspecting that the air drag of piggyback and auto-rack cars was higher than that of conventional freight cars, ran a series of full scale tests that resulted in their recommending the use of the modified Davis formula with a V^2 coefficient of .20 instead of .07 for such equipment. Then for a car of the same gross weight as used in the previous example,

the expression for resistance in lbs./ton would be [9]:

$$R = 1.67 + .01 V + .00293 V^2 \quad (8)$$

This, of course, would be applicable only to a car of the particular type and weight.

4.5.2 The Hoerner Formula

Hoerner has done extensive work in fluid-dynamic drag and has compiled a considerable array of data [17]. However, he gives no drag coefficients for freight cars in trains and only extracts an average drag coefficient from data by Tuthill for a 70 car train. His initial non-velocity-dependent terms are those of Davis, but the velocity-dependent term is somewhat different. Using the above-mentioned drag coefficient to complete the expression yields the following for the resistance in lbs./ton of car weight:

$$R = 1.4 + \frac{28}{w} + .02 V + \frac{.0664}{wn} V^2 \quad (9)$$

For a car of the same gross weight as used in the previous example, the resistance in lbs./ton becomes:

$$R = 2.89 + .02 V + .000885 V^2 \quad (10)$$

4.5.3 Foreign Formulas

It is of interest to note what formulas are used in foreign countries, even though on account of possible obsolescence and differences in rolling stock and track conditions they may not be applicable here.

In Germany, the basic work was by Strahl in 1913. His formula is quoted by Koffman [18] as:

$$R = 2.0 + (.007 + m) \left(\frac{V}{10}\right)^2 \quad (11)$$

when R is in kg./metric ton, V is in Km/h, and m is a constant equal to .025 for loaded freight cars with trucks. In English units this becomes

$$R = 4.0 + .001657 V^2 \quad (12)$$

R in lbs./ton and V in mph. Note that the linear term in V is missing. The equation was later (1932) revised to:

$$R = 4.0 + .001294 V^2 \quad (\text{lbs./ton}) \quad (13)$$

possibly reflecting better aerodynamic characteristics. The coefficient of the last term corresponds to the analogous coefficient in the modified Davis formula for a car of 54 tons gross weight. See Equation (6). However, apparently the particular expression was used for all cars regardless of weight.

In the Soviet Union, the original expression was due to Mukhachev in 1927. Also quoted by Koffman [18], his expression is for the absolute resistance in Kg. of a train of n cars. In metric units this was:

$$R = 1.2 W + .09 nV + .03 (1.0 + .04 n)V^2 \quad (14)$$

with R in Kg., W in metric tons, and n the number of vehicles. In English units this is:

$$R = 2.4 W + .319 nV + .1709 (1.0 + .04 n)V^2 \quad (15)$$

with R in lbs., W in tons, and V in mph. This was subsequently revised several times, with the 1968 version becoming a formula for specific resistance of a single car, which in metric units was quoted as:

$$R = .7 + \frac{3.0 + .1 V + .0025 V^2}{2w} \quad (\text{Kg/metric ton}) \quad (16)$$

w being the load per axle. Changing to English units and revising the form slightly for comparison purposes, the expression for a 75 ton box car becomes:

$$R = 1.752 + .0189 V + .00076 V^2 \quad (\text{lbs./ton}) \quad (17)$$

which is only moderately different from the Davis or modified Davis formulas.

In France, the French National Railways (SNCF) have adopted three formulas, as quoted in Koffman [18]. The one most nearly applicable to a 75 ton car would be:

$$R = 1.5 + .000625 V^2 \quad (\text{Kg/metric ton}) \quad (18)$$

or in English units, as above:

$$R = 3.0 + .00324 V^2 \quad (\text{lbs./ton}) \quad (19)$$

In England, information for freight trains was apparently lacking, and a formula devised only recently has been shown to have validity there. Also quoted by Koffman [18], the expression is:

$$R = 1.25 + .015 V + .0001 V^2 \quad (\text{Kg/metric ton}) \quad (20)$$

which in English units is

$$R = 2.5 + .0483 V + .000517 V^2 \quad (\text{lbs./ton}) \quad (21)$$

In Japan, a single formula was developed in 1967 which allegedly replaced the more than 30 expressions previously required [19]. The expression is of the form:

$$R = \alpha + \beta V + \gamma V^2 \quad (22)$$

where for four-axle freight cars

$$\alpha = (.7 K + .275)e^{-t/30}$$

$$\beta = .133$$

$$\gamma = .00106 S_1 / (1.0 + \theta S_2)$$

where K , S_1 , S_2 and θ are constants for various types of cars, wheels, and track conditions and t is the temperature in °C. The units are unfortunately not completely clear, although clearly metric, and the table of coefficient values is too extensive to reproduce here. It is sufficient to note that this expression is the only one to take into consideration apparent parameters of the problem such as track condition, wheel type, and temperature.

5.0 COMPARISON OF RESULTS OF APPLICATION OF FORMULAS

The expressions in Section 5 comprise most of the American and much of the foreign theory regarding the resistance of freight cars to longitudinal motion. A brief glance at the several formulas applicable to rolling stock and railroad operations in this country will reveal a considerable variation in the values predicted by the various formulas.

5.1 American Formulas

The five expressions from the previous section applicable to the resistance of the 75 ton box car used as an example are repeated below; the Erie-Lackawanna formula is specifically directed towards piggyback and auto-rack cars and has not been included.

$$R = 2.87 + .019 V + .00113 V^2 \quad (\text{Schmidt}) \quad (2)$$

$$R = .53 + .002 V + .00290 V^2 \quad (\text{Tuthill}) \quad (3)$$

$$R = 2.85 + .045 V + .00060 V^2 \quad (\text{Davis}) \quad (5)$$

$$R = 1.67 + .010 V + .00093 V^2 \quad (\text{CNR}) \quad (7)$$

$$R = 2.89 + .020 V + .00089 V^2 \quad (\text{Hoerner}) \quad (10)$$

The discrepancies among the coefficients are quite evident. Most of the investigators, recognizing that there were variables in the testing leading to the equations beyond the control of the investigator which affected the accuracy of the results, cautioned that a certain deviation from the formulas could be expected; Tuthill [10], for example, recommended adding 8% to the values given by the formula to account for spread due to unknowns.

The expressions are plotted for the 75 ton car for various values of velocity in Figure 6. While there are certain similarities of shapes and several of them are reasonably close together, the deviations among the curves are still considerable. It is also worth noting that the

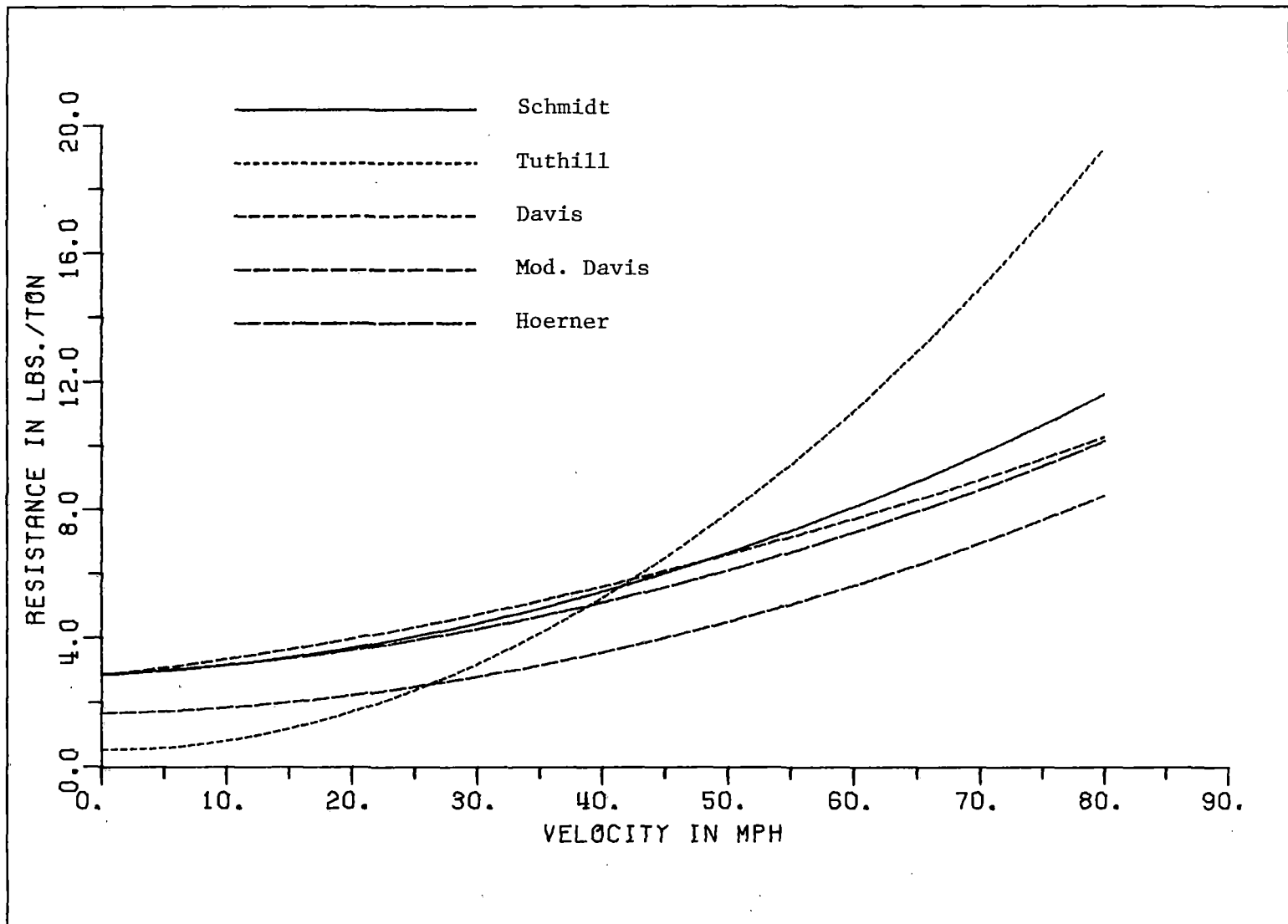

FIGURE 6
COMPARISON OF RESISTANCES WITH 75 TON CAR

relationships of the curves would have been different had a car of a different weight been chosen as an example, as shown in Figure 7, where a car of 20 tons gross weight was chosen for illustration. The deviations among the curves constitute a silent testimonial to the difficulty of accurately quantifying such an apparently simple phenomenon.

5.2 Foreign Formulas

The situation with regard to train resistance formulas in use in foreign countries does not appear at first glance to be better than that prevailing here. Koffman [18] has plotted a figure showing the relative magnitude of the specific resistances of trains in four European countries, as determined by the formulas discussed in Section 5. The curves are illustrated in Figure 8, which, as in Figures 6 and 7, shows a considerable deviation among the curves. However, as the characteristics of rolling stock and track construction differ from country to country, and as several if not all of the countries noted have made efforts to keep their train resistance formulas more nearly up to date than in this country, it appears likely that the formulas actually reflect the prevailing conditions in the respective countries. Apparent reasons for the deviations are discussed in some detail in Section 7.

5.3 A Cautionary Note

The formulas developed by the investigators which were discussed in Section 5 must be used with caution and the results interpreted with discretion. It is unfortunately possible to arrive at results which may lead to erroneous conclusions.

Consider, for instance, using the Davis formula to determine the drawbar pull required for a short train of ten boxcars, all loaded to capacity. The magnitudes of the three terms using the Davis formula are plotted in Figure 9. Note that even at 80 mph, the air resistance

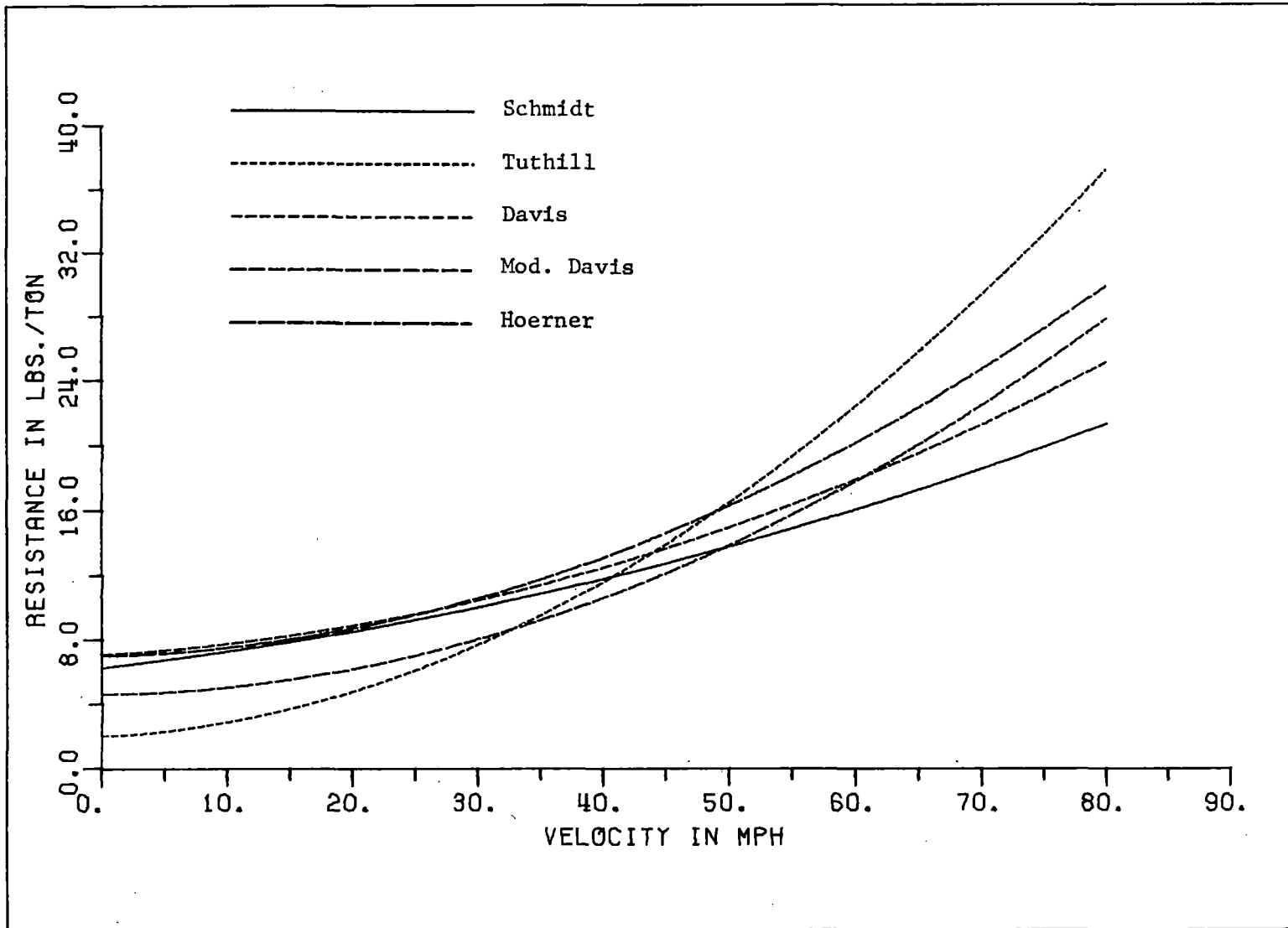

FIGURE 7
COMPARISON OF RESISTANCES WITH 20 TON CAR

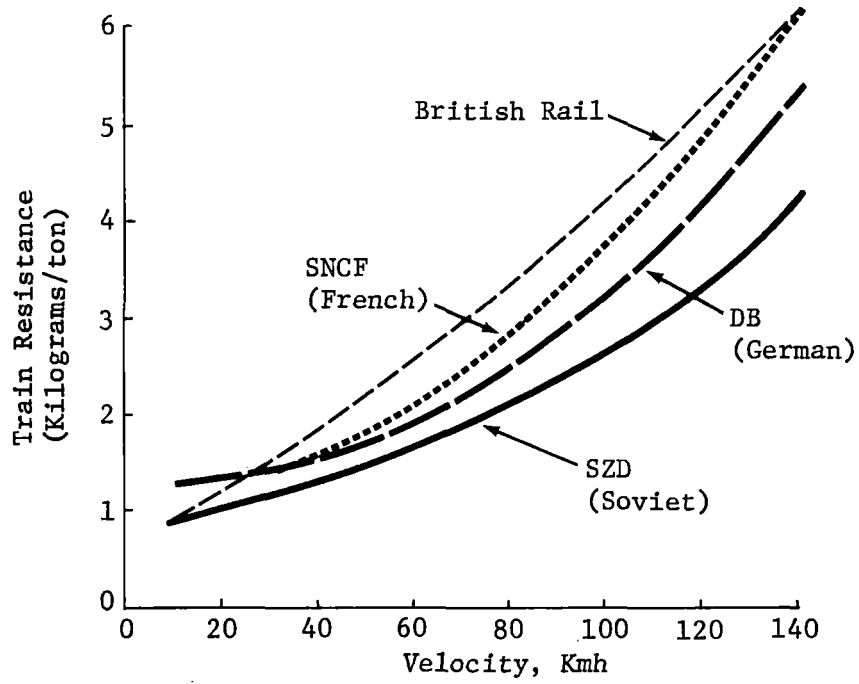

FIGURE 8
SPECIFIC TRACTIVE RESISTANCES IN DIFFERENT COUNTRIES

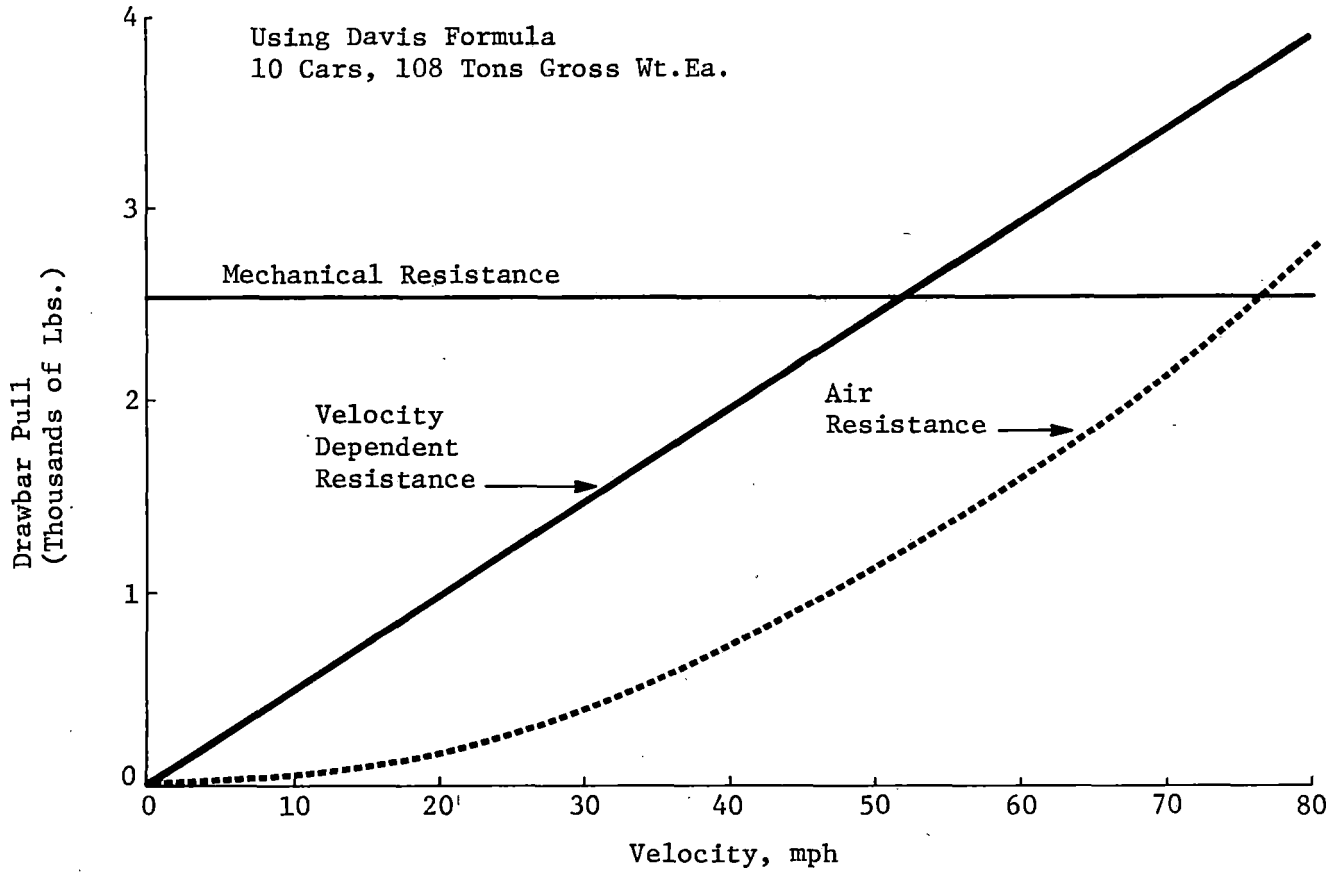

FIGURE 9
RESISTANCE OF SHORT TRAIN OF 10 BOXCARS, LOADED

is less than half the total of other resistances. One might easily conclude that air resistance is a virtually negligible effect for freight trains.

Consider, however, a longer train consisting of empty boxcars. Figure 10 illustrates the magnitudes of the same three terms using the modified Davis formula. The air resistance is more than three and one-half times the total of the other two terms at 80 mph.

The discrepancy between the figures is attributable to all three factors which are different from each other in the examples: train length, specific weight of cars, and the particular formula used. These examples were introduced only to inject a note of caution at this time: the formulas themselves produce widely varying results on the same train; with different trains, the relative significance of the several terms in the formulas changes. A more detailed discussion of these factors and the reasons for the discrepancies between the figures will be found in the following section.

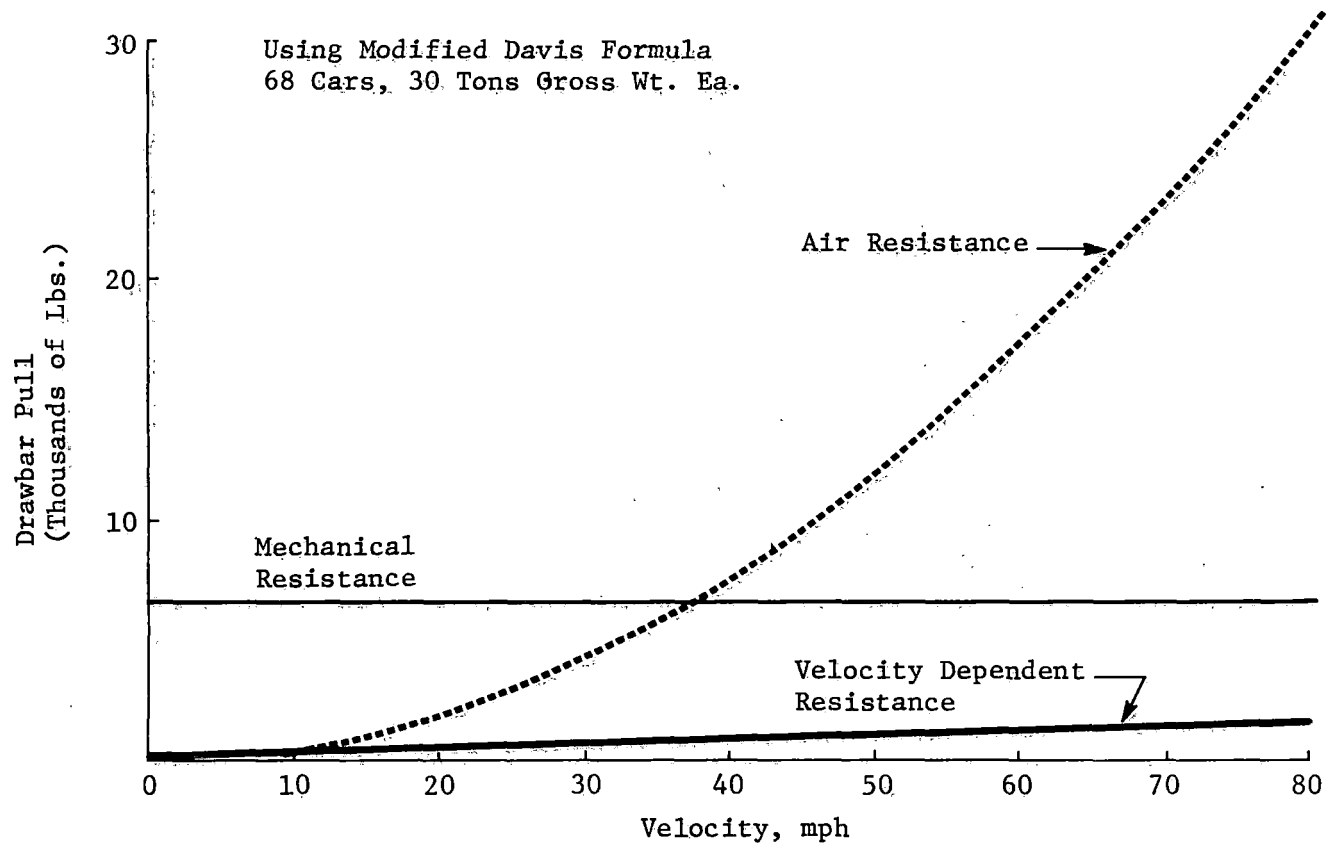

FIGURE 10
RESISTANCE OF LONGER TRAIN OF 68 BOXCARS, EMPTY

6.0 FACTORS CONTRIBUTING TO DISCREPANCIES BETWEEN RESULTS

There are many factors which apparently affect train resistance, only a few of which are incorporated directly in some fashion into the standard train resistance formulas. The fact that many of these have been largely ignored by investigators, possibly because their effects remain difficult to quantify, could account for some of the discrepancies among the results from the previous formulas. Some of these are temperature, track condition, truck design, the effects of side winds, and the makeup of the consist; others, such as aerodynamic drag and the relationship of train length and train weight, are accounted for in the resistance formulas only in a less than precise fashion. Considerations with regard to each of these are given in the discussion following.

6.1 Temperature

Temperature is an obvious factor, not only the ambient temperature, but the temperature of the journals as a function of time along the journey. Schmidt and Marquis [20] have shown, at least for trains equipped with friction bearings, that train resistance diminishes from the start of a run until it settles out asymptotically to a steady-state value, the phenomenon being apparently attributable to the warming of the bearings. This relationship is illustrated in Figure 11. This phenomenon is also made evident when the train stops and the journals have been allowed to cool; the resistance is seen to rise to its previous initial value after the train starts again. See Figure 12.

In view of the comparatively uniform rolling characteristics of roller bearings, it is doubtful that this experience is completely relevant to modern operations; however, this phenomenon, along with variations in ambient temperature from test to test contributing to a similar effect, may help explain a portion of the discrepancies in the results of various researchers.

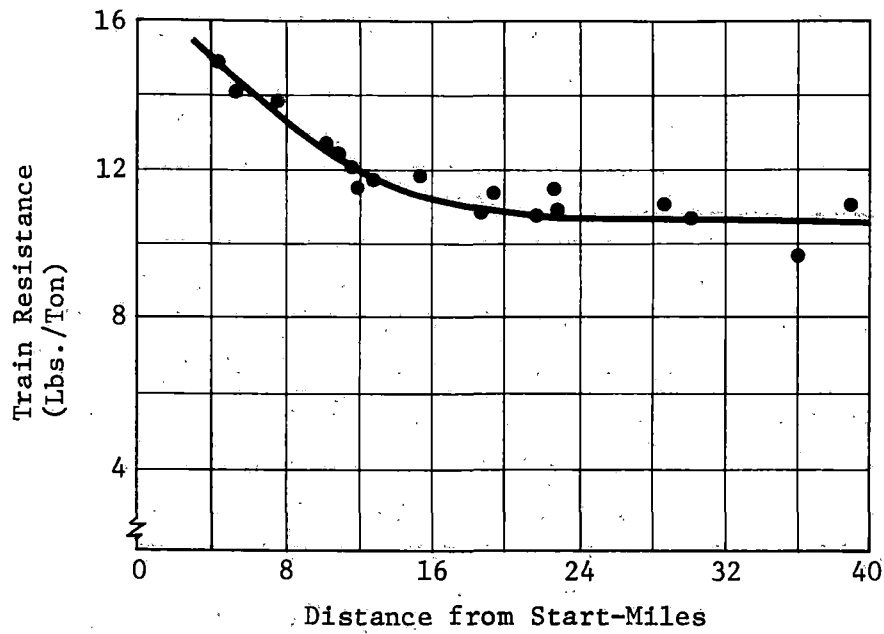

FIGURE 11
DECREASE OF RESISTANCE WITH TIME

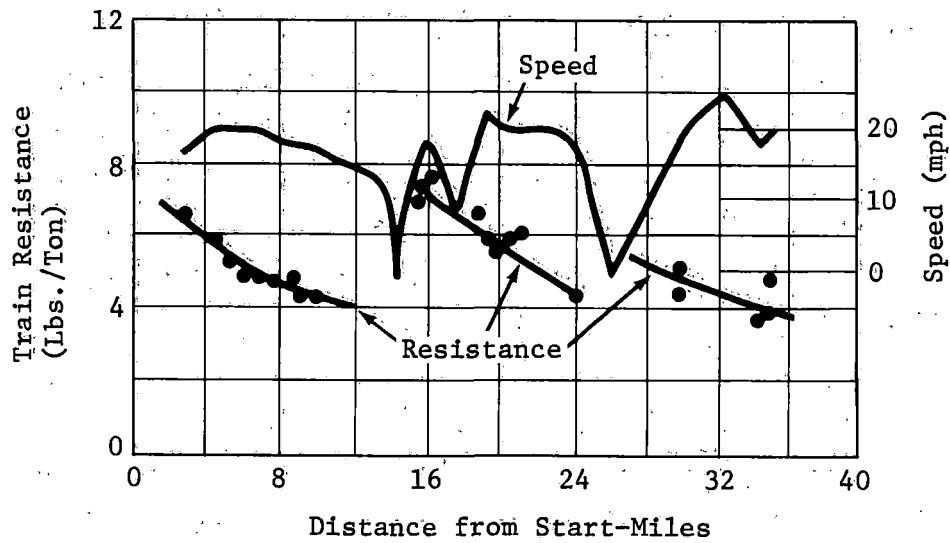

FIGURE 12
INCREASE OF RESISTANCE AFTER STOPS

6.2 Track Condition

Track condition is another partly intangible characteristic which affects train resistance, apparently quite significantly in some cases. A number of factors enter into track condition as it apparently affects train resistance: rail weight, tie spacing, roadbed condition, etc. Hay [1] mentions a reduction of .4 lb./ton in going from 84 lb. rail to 150 lb. rail, for constant axle loadings. The figure seems small, but for an average train such a reduction can diminish drawbar pull by three thousand lbs. or more. Keller [3] discusses a formula developed by AREA which quantifies the resistance due to the so-called "wave action of the rails"; this formula considers both the EI of the rail and the effective modulus of elasticity of rail support. The results of using the formula correspond roughly with the figures from Hay mentioned previously. Keller also mentions a specific test which was run under carefully controlled conditions to eliminate variables other than roadbed and rail conditions. The results are shown in Figure 13 along with predictions from the Davis formula. Here it appears that a reduction of almost 1.0 lb./ton is attributable to using only slightly heavier rail. Harada [19] specifically notes that freight car resistance on "heavy" rail is "very small" compared with that on 30 kg. rail.

Other authors have noted that train resistance formulas in use in various countries yield considerably different, but apparently locally valid results. As noted in Section 6.2 and illustrated in Figure 8, Koffman [18] shows a curve of specific tractive resistance of a given freight car, as calculated by formulas in use in the Soviet Union, Germany, France, and England. Note that at 80 km/h (50 mph) the specific tractive resistance in England is more than 50% higher than in the Soviet Union. He gives an example whereby the same train pulled at 100 km/h theoretically required 1460 HP in the Soviet Union, 1800 HP in Germany, 1970 HP in France, and 2130 HP

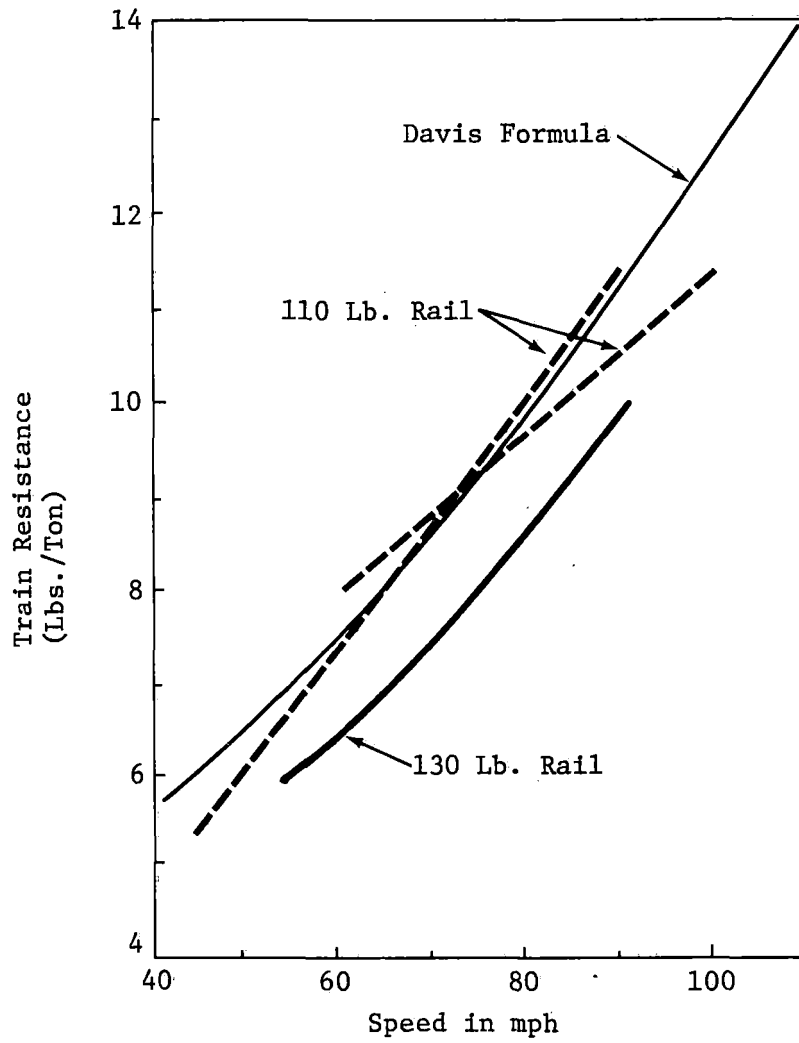

FIGURE 13
RESISTANCES WITH DIFFERENT RAIL WEIGHTS

in England. Scales [21], noting prophetically in early 1973 that the energy crisis was upon us and that such an apparently unnecessary consumption of power was unsatisfactory, attributes the differences in the curves, possibly correctly and certainly persuasively, to differences in track construction in the various countries. He points out that British rail is lighter, and the ties further apart, than any of the others, with the Russian construction the heaviest, and German and French in between. Apparently American construction parallels Russian techniques, as he notes that European visitors are often astonished at the apparently underpowered locomotives pulling heavy loads. There seems to be room for further study of this phenomenon.

6.3 Design of Trucks

The design of the trucks certainly influences train resistance, as energy dissipated in frictional snubbers, hydraulic dampers, friction in the center plate, carbody oscillations, or simply the wheel flanges impacting the rails must all come from the locomotive and is reflected in drawbar pull requirements. Several authors have commented on the relationship of truck design to train resistance [2], [17] but "design" is a difficult characteristic to quantify. Some analysis is presently being made in Canada by Marcotte and Caldwell [22] of the effects of a self-steering truck upon train resistance and consequently fuel consumption. Another possible avenue of approach to the subject is that a mathematical evaluation of vibration energy dissipated in the carbody or trucks could be made from appropriate recordings of motion amplitudes.

6.4 Side Winds

The effect of side winds, as opposed to the resistance encountered by a train moving in still air, is another phenomenon which does not lend itself readily to analysis but which affects

train resistance to some degree by altering the airflow around the cars, particularly between them; it is thus related to the size of the gap between adjacent cars. Hammitt [11] presents considerable data, both on regular equipment and TOFC/COFC equipment, on the effects of gap size upon drag caused by side winds, from recent wind tunnel measurements. Hammitt, in another work [23], presents a polar diagram showing the variation of drag on a high speed streamlined train with respect to the yaw angle of the wind. Aside from a similarly shaped diagram reproduced in Keller [3] from the Great Indian Peninsula Report (1934), whose date renders the usefulness of the data somewhat questionable, and a reference in Hay [2] to an AREA report which presented the findings of a study of the problem only as information and not recommended for general acceptance, little other mention of the effects of side winds upon aerodynamic drag of a train was found.

Unfortunately, (1) the difficulty of measuring wind velocity accurately at the desired point either on the ground or on the train, (2) the fact that the wind at one end of a long train is likely to be substantially different from the wind at the other end, both in magnitude and direction, or that the wind several miles down the track will be similarly different, and (3) the fact that the wind is in most instances a transient phenomenon cast doubt upon the likelihood that meaningful and useful results will be obtained from further investigation of this phenomenon.

Nevertheless its effect is large in some instances. The data in Hammitt [11] clearly show that the aerodynamic drag can double when the wind attacks the train at an angle. In addition, there is a separate effect, cited in an AREA report [24], that "a strong side wind ... presses wheel flanges against rail head, thereby initiating a frictional resistance to forward motion." The magnitude

of this phenomenon is substantial; as given in the same report, the magnitude can be as much as 2.8 lbs. per ton for a locomotive; this is the same order of magnitude as the entire mechanical resistance for a normal freight car. Unfortunately, no similar figure is given for ordinary rolling stock, but there is no reason the figure should be substantially different.

It is easy to see how the effects of such a comparatively unpredictable event such as the occurrence of side winds might affect the results of tests taken outdoors, as is almost all full-scale railroad testing. Unfortunately, little can be done to minimize the effects of side winds other than to close the gaps between cars so as to present a relatively unbroken exterior surface to the air stream. While undoubtedly a phenomenon affecting train resistance in an adverse fashion, it appears to be one with which the railroads will have to live.

6.5 Aerodynamic Drag and Length Considerations

No discussion of train resistance would be complete without mentioning aerodynamic drag, which has been shown on level tangent track to predominate over other resistances at high speed. Still, present understanding of the aerodynamic drag of trains is rudimentary, despite the attention which it has commanded from recent investigators because of the interest in freight trains of higher speeds, not to mention advanced high-speed passenger train systems [5], [6], [11], [14], [16], [19], [23], [25-28]. Despite the effort put into such research and the number of articles published, the problem of air drag on trains is far from solved. The air resistance of even a passenger train of identical cars is difficult to quantify, although much progress has been made recently, e.g., [27], but the air resistance of a long freight train consisting of many different types of cars

arranged in random order in the consist does not readily lend itself to analysis. The formulas for train resistance in common use go no further than to suggest the use of an overall aerodynamic coefficient representing an average value of drag for the particular kind of rolling stock.

Most investigators agree that the phenomenon of air drag on a railroad vehicle can be roughly separated into three effects: the drag on the front of the vehicle caused by the dynamic pressure; the skin friction on the sides and roof of the vehicle along its length; and the drag caused by flow separation at the rear of the vehicle [3], [5], [23], [27-29]; occasionally the drag of the trucks and the underside of the carbody is separately included [1], [5], [30].

These effects may be relatively easy to quantify for a single vehicle, by means of wind tunnel or full scale testing, but despite this, the literature is devoid of such information on ordinary rolling stock. Attesting to this state of affairs, Hammitt [11] comments that "available full scale tests are not adequate to define the aerodynamic drag of railroad freight cars." For a train of vehicles, accurate information of such nature is much more difficult to obtain, since it is evident that at least the front and rear effects are substantially modified by the proximity and aerodynamic characteristics of the vehicle immediately before and after the vehicle under consideration, and the resistance of each combination of vehicles will be different. Consideration of the latter effect is given in the following section, but before that subject is broached, some discussion of the relative magnitude of the front, rear, and skin effects is in order.

The most recent studies of the relationships of these parameters were related to wind tunnel tests of scale models of high speed streamlined passenger trains and corroborative full scale tests,

in France, Germany, and Japan. Some tentative conclusions relating to freight trains may be drawn, notwithstanding that the data relate to passenger trains.

Bernard [27], referring to tests on the 5-car TGV-001 streamlined train, gives "aerodynamic coefficients" (in daN/kmh^2) for the leading, trailing, and intermediate cars; respectively: .00545, .00848, and .00359. Comparing the coefficients for the leading and trailing vehicles, he notes that "the end effect is considerable." He also comments that "streamlined extremities do not effect any improvement in this respect."

It is implicitly assumed in the above discussion and in the discussion following, and apparently by the investigators mentioned, that the air pressure between cars is approximately equal to ambient pressure. Thus the coefficient for the leading car comprises the integral of the distribution of excess pressure over only the front of the vehicle plus the skin friction over its length. Similarly, the coefficient for the trailing car comprises the integral of the distribution of the negative (less than ambient) pressure over the rear of the vehicle plus the skin friction over its length. (Often these two effects are lumped together directly in calculating the air drag. See Hara [29], for instance.) The coefficient for the intermediate vehicles is comprised solely of skin friction over the sides and roof of the vehicle. (The skin friction on the underneath side of the vehicle is either ignored, possibly on the presumption that on account of the presence of the trucks the air under the car moves with the car and consequently contributes only a minimum force due to aerodynamic shear, or is lumped into the other coefficient.)

Thus, to find the total air drag for the train, Bernard calculates a total aerodynamic coefficient consisting of two terms. The first

term adds the portion of the front and rear coefficients corresponding to pressure effects and multiplies them by the cross-sectional area; the second term multiplies the skin friction coefficient by the effective surface area of the entire train; these terms are then added and multiplied by the square of the velocity to obtain total air drag.

Gluck [5] adopts a similar but not identical procedure and has arrived at analogous figures of similar magnitude for testing of short modern passenger trains in Germany. Corresponding drag coefficients (in this case dimensionless but based on the same cross-sectional area) for the leading, trailing, and intermediate cars were determined to be .132, .252, and .158, respectively, for the VT601 seven car train and .215, .308, and .100, respectively, for the apparently less streamlined but newer ET-403 four car train.

The ratios of the combined front and rear effect to the skin effect for the trains mentioned above are 3.8, 2.4, and 5.2, respectively, the differences undoubtedly reflecting the relative degree of streamlining and the smoothness of the exterior surfaces. In the worst case, it will take only six cars for the total of skin friction to be greater than the pressure effects from front and rear.

These figures are roughly confirmed by Hara [29] with respect to the New Tokaido Line equipment. He states that the friction coefficient will equal the pressure coefficient for "only two coaches" (in this case the locomotive is treated as a separate entity) and that consequently "for a long train skin friction will be dominant." He notes as a consequence that "endeavor to diminish the pressure drag (front and rear) is not so effective for the diminution of total drag."

How related is this recent information on relatively streamlined passenger trains in foreign countries to unstreamlined freight trains in this country? In actuality, quite a bit. It seems to have been forgotten that the aerodynamic coefficients actually relate to skin friction, even though they are referenced to the cross-sectional area of the car. Thus the recommended Davis coefficient for a leading car or locomotive is .0024, whereas for trailing cars the recommended coefficient is .0005. The resistance of the locomotive was usually calculated separately, and presumably the coefficient comprised all pressure effects, with only the skin effect on the trailing vehicles. Note that the relative magnitude of these coefficients is, significantly, about the same as the 5.2 ratio for the least streamlined of the three passenger trains cited earlier, which is probably more nearly comparable to a freight train from a skin friction standpoint. Davis himself, with reference to passenger cars, talks at some length about skin friction [1], but, perhaps unfortunately, states that "it is convenient to express the combined effects of front pressure, rear suction, and skin friction in terms of cross-sectional area of the car." Freight train coefficients are similarly treated later in the same article.

Since the Davis formula is a car formula, as opposed to the earlier Schmidt-Tuthill series of formulas for trains, the length of the train is implicit in the Davis formula, as it should be to give proper consideration to the aerodynamic drag term, which will be proportional to the total length if it reflects skin friction. In the Davis formula, to find the total resistance, the expression for lbs. per ton (per car) is multiplied by the average weight per car and the number of cars. This is equivalent to taking the resistance to be the specific resistance of the train and multiplying by the total weight of the train, which will be, as before, the

average car weight times the number of cars. Thus the aerodynamic term in the formula is effectively multiplied by the number of cars. Of course this presupposes that all the cars are the same length, but in Davis' day this was not an unreasonable presumption. Today, however, this is no longer applicable, as one can see from Figure 1.

Lipetz [6] presents a formula for the air resistance of a train which follows along similar lines. This is given as

$$R = .002 A_L + .00245 P_C \frac{L_C}{100} V^2$$

where

A_L = cross sectional area of locomotive

L_C = length of car

P_C = perimeters of car (height of two sides plus roof width)

It is seen that he too allocates all the pressure effects to the leading vehicle, in this case the locomotive, and skin friction effects only to the trailing cars.

It is of some interest again to note the ratio of the two effects as determined by Lipetz. If one substitutes representative values for cross sectional areas, lengths, and perimeters, one arrives at the expression:

$$R = (.240 + .0392) V^2$$

yielding an approximate ratio of 6:1 of pressure effect to skin effect. Thus using his formula, six freight cars would have the skin friction drag equivalent to the pressure drag of the leading car.

It appears, then, that anywhere from five to ten cars contribute in skin friction the equivalent of the pressure drag from the leading

and trailing vehicles. In further substantiation of this figure, Davis [1], in reporting data from Schmidt's earlier testing, notes that the average drag in the trailing cars is from 13.8% to 16.8% of that of a leading car, corresponding to a figure of seven cars. Thus in calculating the resistance of a short train, particularly a light one, where the air drag might be the predominant resistance, it is possible to incur an error approaching as a limit a factor of two by mere substitution into the Davis or CNR formulas. In a long train, the end effects will be spread out over a considerable number of cars and will be masked by the predominance of the skin effect, and the formulas will have customary accuracy; in a shorter train, ten cars or less, the true air drag may be double that given by the formulas.

Thus the true air drag of a string of similar freight cars may be represented as a straight line when plotted as a function of the number of cars, but the curve does not go through the origin if the pressure terms are not dumped upon the locomotive. Bernard [27] presents such a curve as a function of train length. The resistance calculated by the formula does, however, go through the origin. Two such curves are shown in Figure 14. The error is the difference between them. The ratio between the true air drag and the calculated drag is shown also. It is easily seen that the ratio approaches one for a long train but becomes very large for a short train.

This effect in itself may be further masked by the weight of the cars, particularly if calculated by the Davis formula, which emphasizes mechanical resistance more than others. In a heavy train moving at lower velocities, the air drag itself is much smaller, and any error in calculating air drag will be masked by the addition of the other terms.

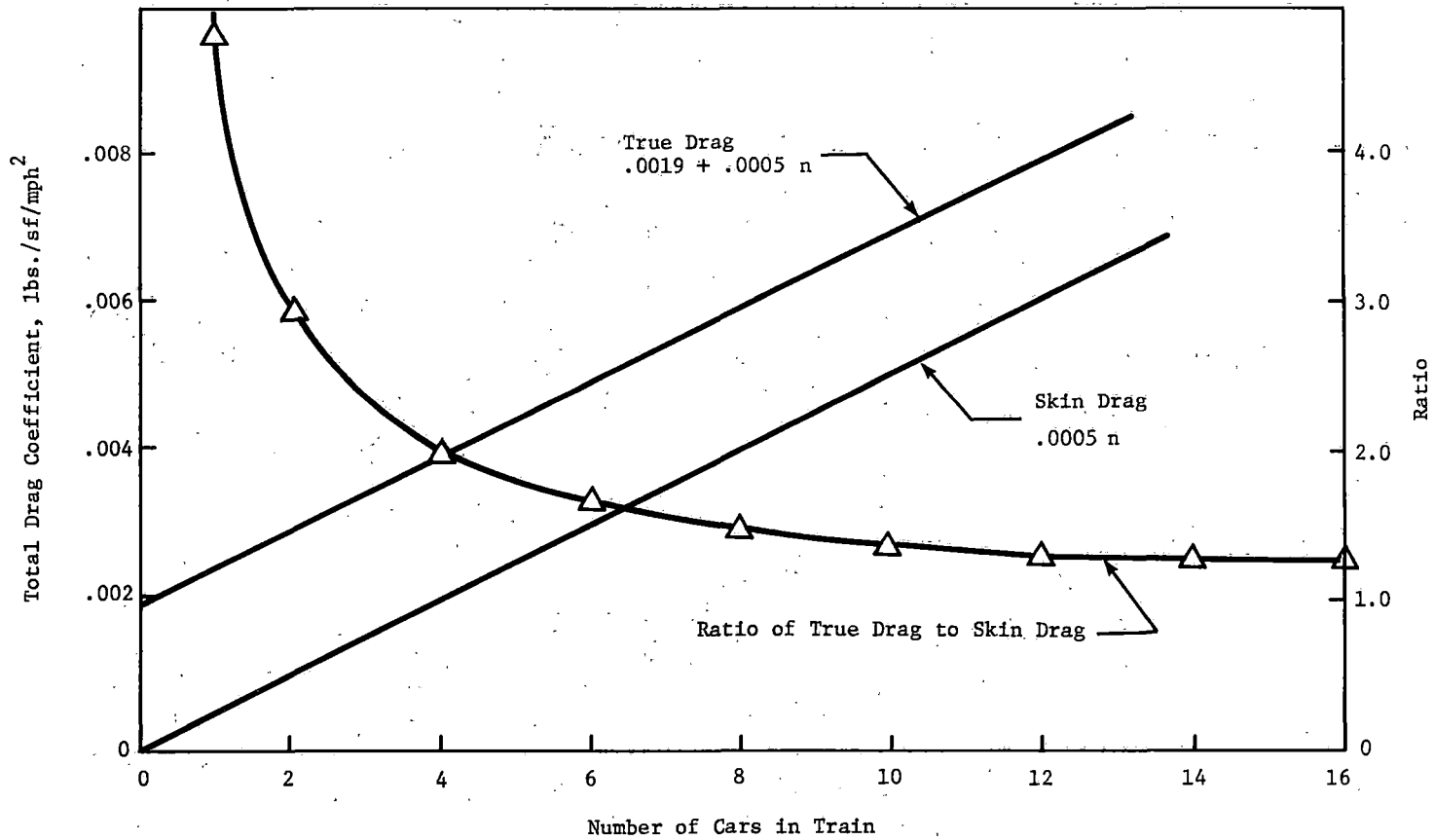

FIGURE 14
RELATIONSHIP OF TRUE DRAG TO SKIN DRAG

It can safely be said that even for a train of similar vehicles, misleading results may materialize from simple substitution of numbers into the Davis formula or the modified Davis formula, which takes the same form, if the train is short enough. Such calculation considers only the skin friction, and the pressure drag is being implicitly absorbed by the locomotive at no cost to the train. In actuality, even if only the drag of the cars following the locomotive is to be determined, much, if not most, of the pressure effect must be assigned to the last car, if the evidence of Bernard and Gluck is correct. Such considerations may have contributed to discrepancies in the past among the results from different investigators. However, this particular effect is relatively small for a uniform train. For a train with a mixed consist, particularly with one utilizing some of the more modern pieces of rolling stock, the importance of segregating pressure effects and skin effects in arriving at an accurate determination of air resistance of a train is magnified. The discussion in the next section describes a methodology by which this problem may be handled, and a first attempt at quantifying the effect.

7.0 A METHODOLOGY FOR APPROACHING THE AERODYNAMIC DRAG PROBLEM

7.1 Introduction

While Davis recognized that skin friction was the dominant factor in producing air drag on both passenger trains and freight trains, at least those consisting of closely coupled, nearly uniformly sized cars, in his day speeds for freight trains were relatively slow, and most trains were trains of boxcars of approximately the same size, or mixtures of boxcars, hopper cars, gondola cars and tank cars. It is perhaps indicative of the types of rolling stock in most common use at that time and earlier that Professor Schmidt used only boxcars and gondola cars in the five of his tests for which such information is available, as quoted in Davis [1]. The comparative cross-sectional areas of the gondolas was 70 ft.^2 , compared to 98 ft.^2 for the boxcar, so that the gondolas, although obviously smaller, were not significantly different from the other cars. It is realistic to believe that the Davis formula was meant to apply to trains consisting solely of boxcars, as illustrated in Figure 15(a), or to an ordinary mix of cars as illustrated in Figure 15(b).

While the modified Davis formula corrected some of the shortcomings of the Davis formula by giving more recognition to air drag and less to mechanical resistance, which had diminished somewhat with the advent of roller bearings, it still is not suitable for application to certain types of modern rolling stock, as shown with regard to unit trains of piggy-back cars or autorack cars by the Erie-Lackawanna tests [14]. While for those types of rolling stock the E-L formulation is certainly an improvement, the problem of how to ascertain the resistance of a mixed consist, in which widely different types of rolling stock are randomly mixed, still remains. An example of such a consist is illustrated in Figure 16. It is not difficult to believe that the air drag in this consist will be significantly different from the preceding

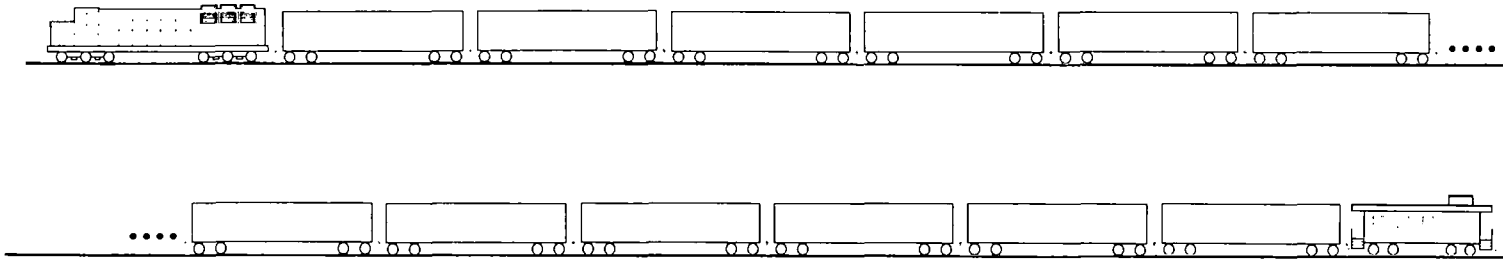

(a) Unit Boxcar Train

49

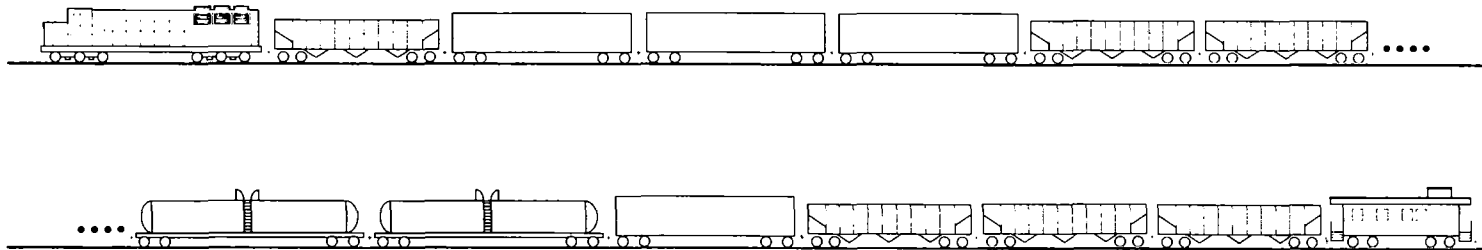

(b) Ordinary Mixture

FIGURE 15
REPRESENTATIVE CONVENTIONAL FREIGHT TRAINS

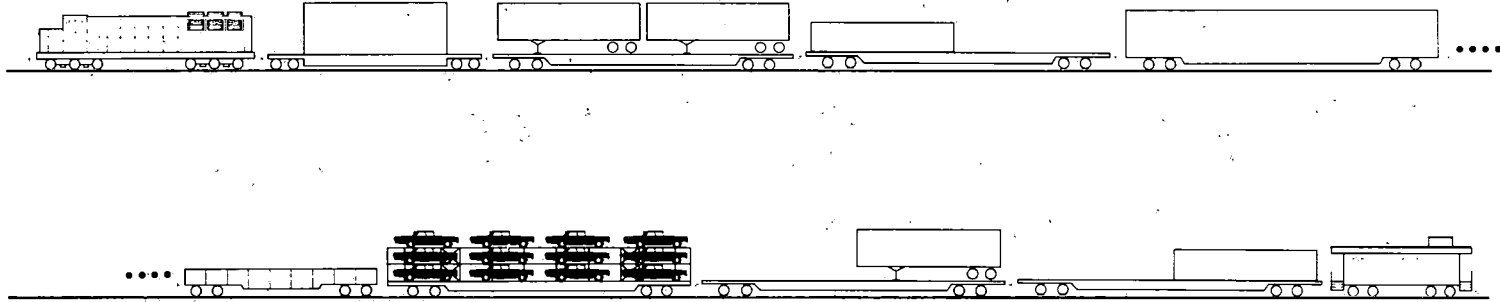

FIGURE 16
MIXED CONSIST OF LESS CONVENTIONAL ROLLING STOCK

examples because of the exposure of more of the fronts and rears of cars to the free airstream. It is to address this problem that the following methodology is offered as an initial step in quantifying the resistance of such a consist.

7.2 Division of Air Drag into Three Effects

It has been noted in the previous section that the air drag on railroad cars may be regarded as being divided into three factors: front pressure effect, skin friction along the sides and roof of the car, and the rear pressure effect. It will be convenient herein to continue this division, although, as noted before, certain authors have seen fit to combine the front and rear pressure effects into a single coefficient.

Consider the case illustrated in Figure 17. The center car will be the subject in each case. In (a), the boxcar is almost completely exposed to the free air stream, both front and rear; the shielding of the car by the flat cars is minimal. In this case it would be necessary in determining the air drag on this car to take into consideration all three effects to almost their fullest extent. In case (b), because the cars are closely coupled and identical as well, the pressure effects at either end will be minimal, and need only be considered to a very small extent; the main drag component will be friction drag on the sides and roof of the car; this case approximates the conditions for which the formulas were conceived. In case (c), the pressure effect at the rear will be substantial, while minimal at the front, and the condition in case (d) is vice versa.

The approach taken will be to determine the air drag of each car in the train, and then to sum these drags to determine the total air drag of the train. For each car, the drag due to each of these three

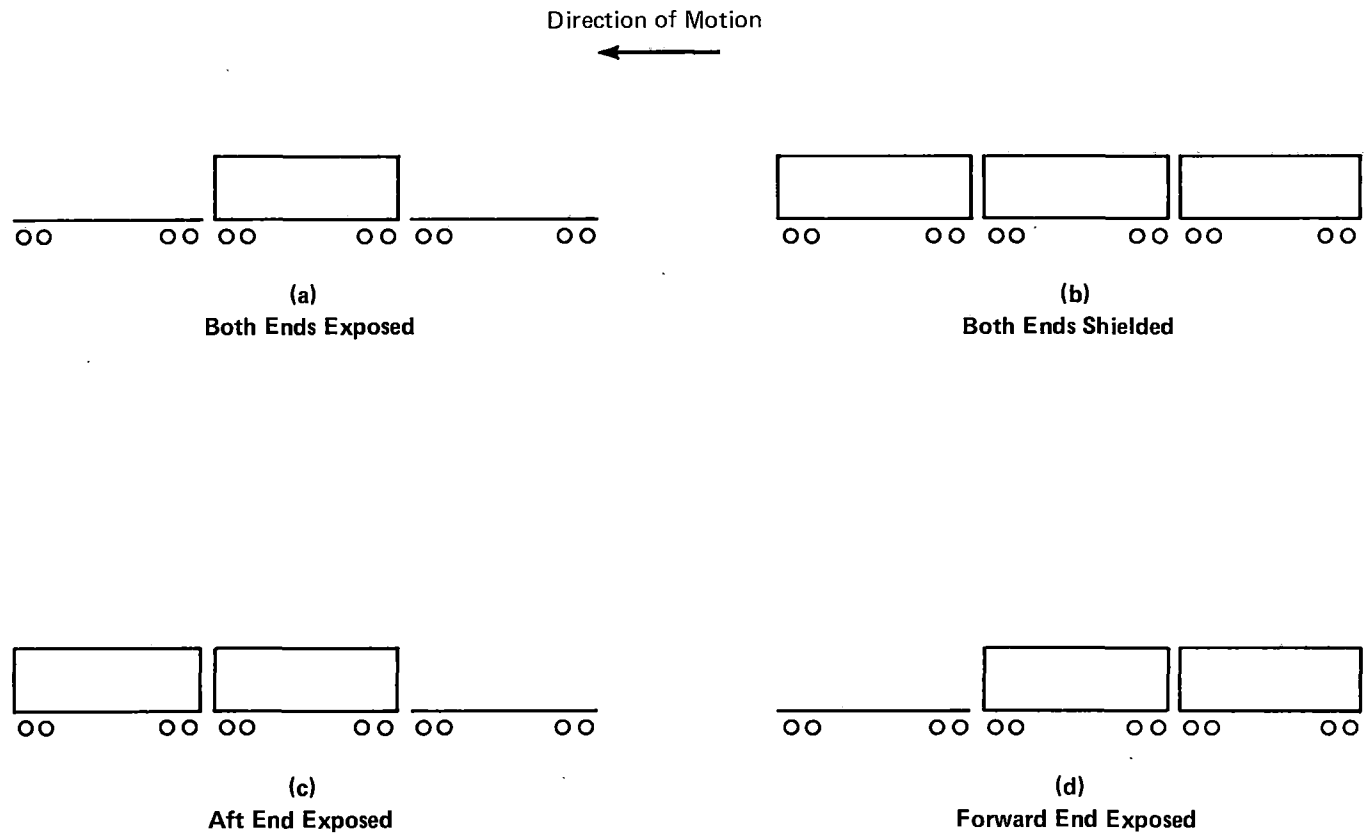

52

FIGURE 17
EXAMPLES OF VARIOUS SHIELDING EFFECTS ON CENTER CAR

effects will be determined. It will be assumed that the skin friction, contrary to the pressure effects, is unaffected by the presence of vehicles in front of or behind the vehicle in question. Since the skin friction problem does lend itself to relatively simple analysis, it will be discussed first.

7.2.1 Skin Friction Considerations

A friction drag coefficient may be assigned to each type of car, or even to the entire class of freight cars, based upon theory or results from wind tunnel and full scale testing; surface areas may be calculated from actual measurements of length, width, and height; and drag may be calculated from the standard formula.

Data on skin friction coefficients are remarkably consistent, enough to ensure that large errors will not be incurred by use of the data. Conversion of the aerodynamic coefficients for intermediate cars in relatively smooth passenger trains given by Hara for the New Tokaido line trains [29], Bernard for the SCNF TGV001 train [27], and Gluck for several German trains [5] to dimensionless skin friction coefficients based upon surface area reveals the following:

$$\begin{aligned}C_f &= .0041 \text{ (New Tokaido Line)} \\C_f &= .0042 \text{ (SCNF-TGV001)} \\C_f &= .0058 \text{ (DBB-VT601)} \\C_f &= .0063 \text{ (Davis, passenger train)} \\C_f &= .0074 \text{ (Davis, motor car)}\end{aligned}$$

Unfortunately, no data are available for freight cars but it may be safely concluded that the surface of the average freight car is rougher than that of streamlined passenger vehicles and might be equivalent to something near the value for the old Davis motor car.

It is possible to compute from the Davis and modified Davis formulas what the skin coefficient would be if a certain drag for the trucks is assumed and a surface area and a cross-sectional area selected.³ After doing so, values for the surface coefficient are .0053 and .0117 respectively. The average value of .0085 appears to be realistic in view of the other data and is used hereafter in this report. The difference between the values obtained is an indication of the present minimal understanding of the true aerodynamic drag of a railroad freight car. The figure used is consequently approximate, and the considerations with regard to its value are mentioned only to show that the order of magnitude for the chosen figure has some basis.

7.2.2 Front and Rear Pressure Effects

In contrast to the skin friction effect, the magnitude of the front and rear forces will be modified from what could be considered to be the analogous forces if the objects were alone in a free air stream, by the proximity and shape of other vehicles in front of the vehicle in question and behind it. In particular, the pressure effects at front and rear will be affected by the proximity of the car at either end, even if the cross-sectional areas are identical. Hammitt [11] has done some recent work to determine the effects of such gaps between vehicles. The extent to which the pressure effects will be mitigated will be a combination of both the proximity of the areas which might be effective in shielding the subject car from the effect and the relative sizes of the areas doing the shielding. The four possible extreme cases are illustrated in Figure 18. Case (a) shows good proximity with matching area; in this case, the pressure effects on either car are

³Respective values used were 40 lbs/truck at 60 mph, 1600 ft.², and 88 ft.². The truck drag for four-wheeled freight car trucks was taken as 2/3 of the 119 lb. drag reported for 3 axle passenger trucks in Davis [1], the only figure for truck drag found.

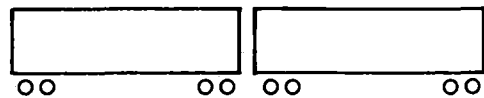

(a)
Good Proximity, Good Area Match



(b)
Poor Proximity, Good Area Match

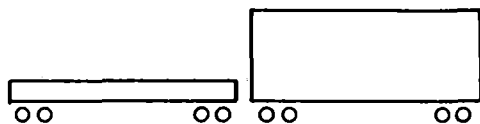

(c)
Good Proximity, Poor Area Match

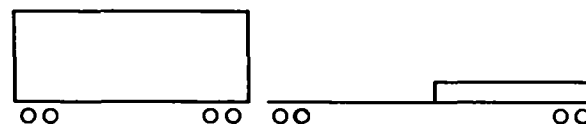

(d)
Poor Proximity, Poor Area Match

FIGURE 18
EXAMPLES SHOWING PROXIMITY AND AREA MATCH EFFECTS

minimal. Case (b) shows matching areas, but proximity so poor that the pressure effects on both vehicles will be virtually the same as if they were each in the free air stream. Case (c) shows the shielding areas to be closely coupled, but there is a bad mismatch in areas; the flat car has virtually no shielding effect on the boxcar, whereas the boxcar bully shields the rear of the flatcar from any rear pressure effect. Case (d) shows both mismatched areas and poor proximity.

In determining the true drag of a single railroad car in a train of other vehicles, consideration must be given to not only the extreme cases shown but cases lying in between, to various degrees. Consider the cases illustrated in Figure 19, the center boxcar again being the car of interest. In case (a), the car is overshadowed in the front because of the oversize Stak-Pak or Hi-Cube car ahead of it; it is undershielded in the rear because the gondola car behind it is smaller. In case (b), at the front of the boxcar, there is partial shielding only from the large piece of freight on the preceding flatcar, as the equal areas are not close enough to be completely effective in shielding; at the rear of the boxcar there is a combination of partial effects from the container well car with respect to both proximity and area match.

In simplistic terms, most interfaces between cars, with regard to the extent of shielding each other from the effects of a free air stream, can be characterized by an appropriate combination of proximity effects and area effects. This will be the approach taken in the further development of this methodology below. It must be noted, however, that it is not simple; not only will air drag characteristics vary with each type of car, but they will also vary with the placement in the consist: (1) the effect the car in front has on the car behind is not necessarily the same as the effect the car behind has on the car in front; (2) if the car positions are reversed, or even if one car is turned around by

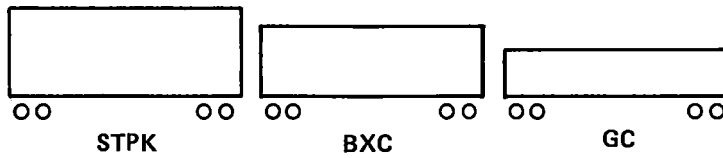

(a)
Area Mismatches (Partial)

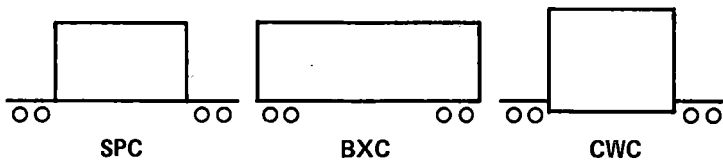

(b)
Partial Proximity Effect and Combination of
Partial Proximity and Partial Area Effects

FIGURE 19
EXAMPLES SHOWING PARTIAL PROXIMITY AND AREA MATCH EFFECTS

itself, the pressure effects are changed; and (3) the effect of the car in front upon the car in the rear is not constant; rather, it depends upon the car in the rear, and vice versa. Thus the front and rear pressure effects cannot simply be tabulated for a given car.

7.3 Computer Model

As a consequence of the factors discussed in the previous sections, it is not possible to characterize a car solely by itself through extensive testing. One cannot simply assign various coefficients to each car type to quantify each of the three effects for that type car, calculate the drag for that car, and add it to the drag similarly calculated for all the other cars in the train to arrive at the drag for the train. The drag of each car in the train depends upon the car in front and the car behind.

It is, however, possible from the known geometry of the car to tabulate certain dimensions which relate to the size of a potential shielding area and to its proximity to the face of the coupler. Other similar data for calculating skin friction can be tabulated, and a computer model devised which will take as an input the number of cars in the train and the order of the types of cars, examine each vehicle interface, look up in the tabulation of data the characteristics of each vehicle relevant to that particular interface, compute by means of a specially devised algorithm the extent to which the pressure effects on each vehicle are mitigated by the presence of the other vehicle, perform this operation for each end of each vehicle, calculate the total air drag by adding to the modified pressure effects the skin drag, computed by examining the appropriate data in the same table, and sum the drag of each car to obtain the total drag. This would be a tedious job to perform manually, but once the procedure is established the computation by computer is trivial. This is the task which the

computer program which has been devised performs. The program itself and further detailed considerations of its development and its use are described in the appendices. Given realistic data for each car type utilized by railroads, it permits the ready computation of total drag for any consist.

Model limitations at present are that realistic data for drag coefficients are sorely lacking for conventional rolling stock, and in order to utilize the program, coefficients had to be assigned in the basis of best available information or by appropriate ratioing from known data. The mechanical and velocity-dependent terms of the resistance equation which forms the basis for the model are taken directly from the modified Davis formula; calculation of the air resistance has been adjusted to take into consideration open spaces in the consist by means of the algorithm in the computer program fully explained in Appendix B, while for an unbroken string of identical conventional items of rolling stock the skin resistance coefficient used is a compromise between those derived from the Davis and modified Davis formulas, as explained earlier. While it is believed that the procedure for calculating the resistance is realistic, the magnitude of changes induced in the resistance of the train by having a different consist can be no more reliable than the data tabulated for the vehicles, which, as noted earlier, is believed to be as accurate as can presently be determined. However, basic information on ordinary rolling stock, not to mention more unusual items of equipment, is notoriously lacking.

7.4 Results from Program Runs

Consider the three trains illustrated in Figures 15 and 16 which were previously used as examples. Although the computer program is predicated upon an unverified technique for treating the open space problem as well as upon relatively sketchy data of dubious accuracy,

the results for the three trains nevertheless confirm intuitive beliefs about the relative resistance of the trains, contributing to the degree of confidence in the program.

Each of the three trains was approximately the same length, although the conventional trains had more cars. Each car of the two more conventional trains was loaded with 78 tons of freight; the small difference in total weight between the two trains was due to slight differences in the empty weights of the cars. In contrast, the less conventional train, shown originally in Figure 16 and reillustrated in Figure 20(a), was considerably lighter.

Results of calculating the total resistance of the trains by means of the computer program are given in Table I.

The resistance of the unit boxcar train is seen to be the lowest, with the mixed consist of conventional rolling stock only slightly higher. The small difference in resistance is attributable mainly to slight mismatches in cross-sectional areas and the slightly more adverse proximity factor for the tank cars.

The resistance of the least favorably arranged consist of less conventional modern rolling stock is the greatest. While the mechanical resistance and velocity dependent resistance combined are more than a thousand pounds less than for the heavier train, the air drag is more than 2600 lbs. greater, contributing to the 1500 to 2000 lb. excess over the conventional trains.

Had the consist been more favorably arranged, the resistance of even the adverse mix of rolling stock of Figure 20(a) could be improved. Deliberate grouping of large cars together and open spaces

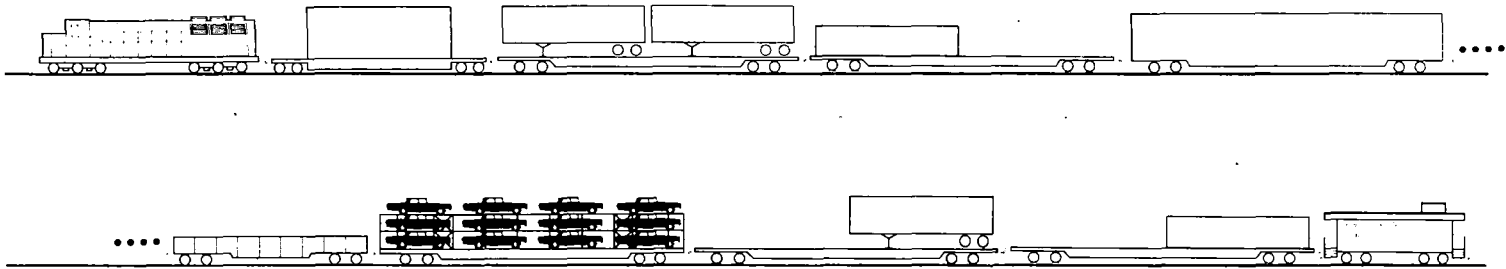

(a)
Random Consist

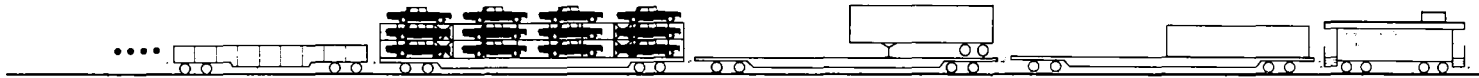

(b)
Rearranged Consist

FIGURE 20
DIFFERENT ARRANGEMENTS OF CONSIST OF
LESS CONVENTIONAL ROLLING STOCK

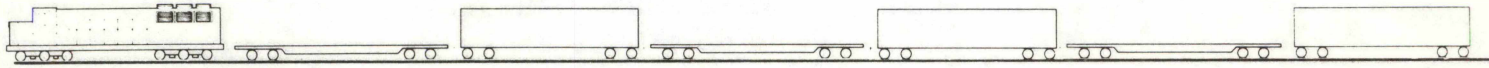

(a)
Adverse Grouping

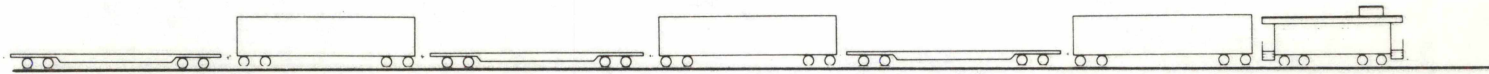

62

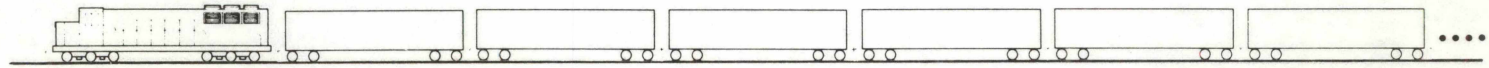

(b)
More Favorable Grouping

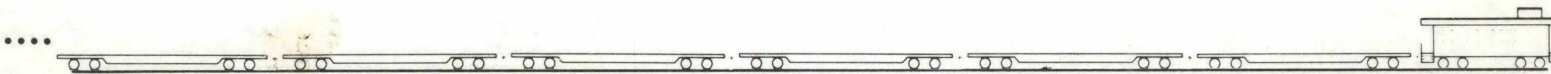

FIGURE 21
DIFFERENT ARRANGEMENTS OF CONSIST OF CONVENTIONAL ROLLING STOCK

TABLE I
RESULTS OF DETERMINATION OF TRAIN RESISTANCE FROM PROGRAM

EXAMPLE NUMBER	FIGURE NUMBER	DESCRIPTION	TOTAL WEIGHT (TONS)	TOTAL RESISTANCE @ 60 MPH (LBS.)	RESISTANCE LBS./TON
1	15(a)	UNIT BOXCAR TRAIN	1454	7098	4.9
2	15(b)	MIXED CONSIST OF BOXCARS, HOPPER CARS, GONDOLA CARS, AND TANK CARS	1314	7536	5.7
3	16,20(a)	MIXED CONSIST OF LESS CONVENTIONAL MODERN ROLLING STOCK, ARRANGED ADVERSELY	790	9040	11.4
4	20(b)	SAME CONSIST AS ABOVE, ARRANGED MORE FAVORABLY	790	7024	8.9

together with an attempt to match cross sectional areas in adjacent cars results in a 22% reduction in total drag at 60 mph (28% air drag reduction). See Figure 20(b).

Even with conventional rolling stock (including flatcars), wide variations in train resistance are attributable solely to the arrangement of the consist. An extreme example is shown in Figure 21. The first train shown in (a) is the same consist as that shown in Figure 15(a) except that every other boxcar has been replaced by a flatcar. Although the drag of a single flatcar will be substantially less than that of a single boxcar, the adverse arrangement shown exposes every boxcar except the last one almost fully to the air stream and the total drag is considerably higher (69%) than that of the unit train of Figure 15(a). A rearrangement of the consist so as to group similar cars together (Figure 21(b)) lowers the total drag considerably so that it is only 6% higher than that of the unit train. The resistances for these two trains and the unit boxcar train of Figure 15(a) are shown in Figure 22 as a function of velocity, assuming a uniform cargo load of 78 tons per car.

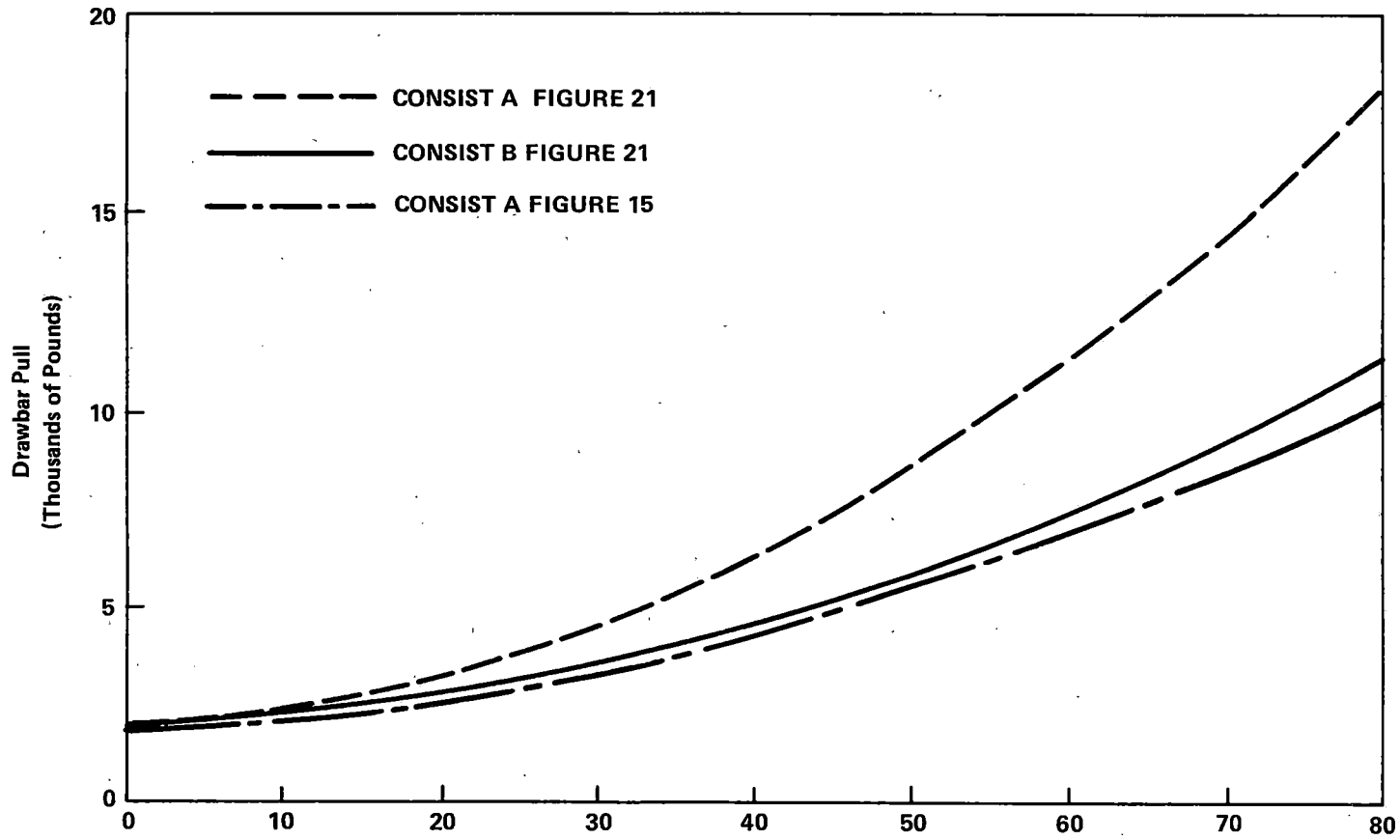

FIGURE 22
TOTAL TRAIN RESISTANCE FOR THREE CONSISTS

8.0 PRELIMINARY ESTIMATES OF FUEL AND COST SAVINGS FROM REDUCED TRAIN RESISTANCE

Several areas are potential candidates for the reduction of train resistance. Reduction of bearing friction and use of lighter weight equipment will reduce the constant term and weight-dependent term of the resistance equation. Minimization of truck hunting and parasitic carbody oscillations will reduce the velocity dependent term and reduction of aerodynamic drag will of course reduce the velocity-squared term of the equation.

These are the major areas in which meaningful reductions in train resistance can be expected. The magnitude of the contribution of these several candidates to the reduction of train resistance on level tangent track will now be determined. Use will be made of the methodology developed during this investigation. Because it is believed that there are still inherent inaccuracies in the computation from lack of reliable data, the results must be regarded as only preliminary. Estimates of accuracy are given where possible.

In order to draw meaningful conclusions regarding the relative merits of certain modifications to equipment which might be made to reduce train resistance, it is necessary to compare each example on the same basis, i.e., with the same number of cars, the same type of cars, the same lading weight, and also, as has been shown, the same order in the consist.

What should this train consist of? It was felt desirable, if not necessary, to make it as average a train as possible. From statistics in the Yearbook of Railroad Facts [31] an average train was compiled, after rounding off the figures. The average freight train has 67 cars (page 39), and if the average train reflects the total numbers of

boxcars, hopper cars, flat cars, gondola cars, and tank cars, an average train consists of 23 boxcars, 24 hopper cars, 6 flat cars, 7 gondola cars, and 7 tank cars. Although some of the flat cars are undoubtedly of the nature of the extra long TTX cars for TOFC/COFC service, for this example they were all taken to be more standard 60 ft. cars. Since there are so few of them, any error incurred will be small. The average net ton-miles/freight train mile is given as 1943, so that the total load for the train will be approximately this figure. The ratio of empties to loaded cars can be determined by using the figure of 61 tons per car (page 40) and the 67 cars per train to compute an average load figure of 4097 tons per train if every car is loaded. Hence, in round figures, of the 67 cars of the average train, 35 are empties. If the empties are proportioned among the different varieties, after the figures are rounded, the train becomes as shown in Table II.

TABLE II
 AVERAGE TRAIN CHARACTERISTICS⁴

<u>Number</u> <u>Loaded</u>	<u>Cars</u>	<u>Number</u> <u>Empty</u>	<u>Total</u>
11	Boxcars	12	23
12	Hopper Cars	12	24
3	Flat Cars	3	6
3	Gondola Cars	4	7
<u>3</u>	Tank Cars	<u>4</u>	<u>7</u>
32		35	67

⁴Lumping refrigerator cars into the boxcar category for these purposes, and ignoring the small portion (~2%) of the remaining categories.

Train resistance apparently does not depend upon where the load is placed in the consist, so 32 loads of 61 tons each were dispersed at random through the consist. The loaded flatcars were assumed to look like the "Bulky Freight on Flat Car" illustrated in Figure 1; whether the other cars were loaded or not was assumed not to affect the aerodynamic drag. The order, however, might, so a random order was used. A 67-card deck of cars with one card for each car was assembled and shuffled thoroughly, and the order of the cards taken as the order of the consist. Although a different order could have been chosen by this same method, the chances are that the order is representative, and for a train composed of this selection of standard rolling stock, a random rearrangement of the consist would not be expected to result in a significant change in train resistance.

8.1 Improved Roller Bearing Seals

Mechanical resistance which is not deemed to be velocity-dependent is generally divided into a weight-dependent term and a term representing a fixed drag per axle. (See Section 5). The weight dependent term can be thought of as a coefficient of rolling friction. The term which is not weight-dependent can be thought to represent parasitic torsional drag of the bearing itself; the figure of 20 lbs. per axle in the modified Davis formula corresponds closely with results of torsional tests of freight car roller bearings [32] as related to a 34.5" dia. wheel.

It is possible to show that the power loss from a torsional resistance of 86 in.-lbs. per bearing amounts to 10.6 HP per car at 50 mph if the car is equipped with the wheels above. If this torque can be reduced to 59 in. lb., as suggested in [32], a reduction of 31%, the HP per car can be reduced to 7.3 HP. In the average train, this amounts to 496 HP if the caboose is included. The reduced drag is shown in comparison with normal drag in Figure 23 for the average train.

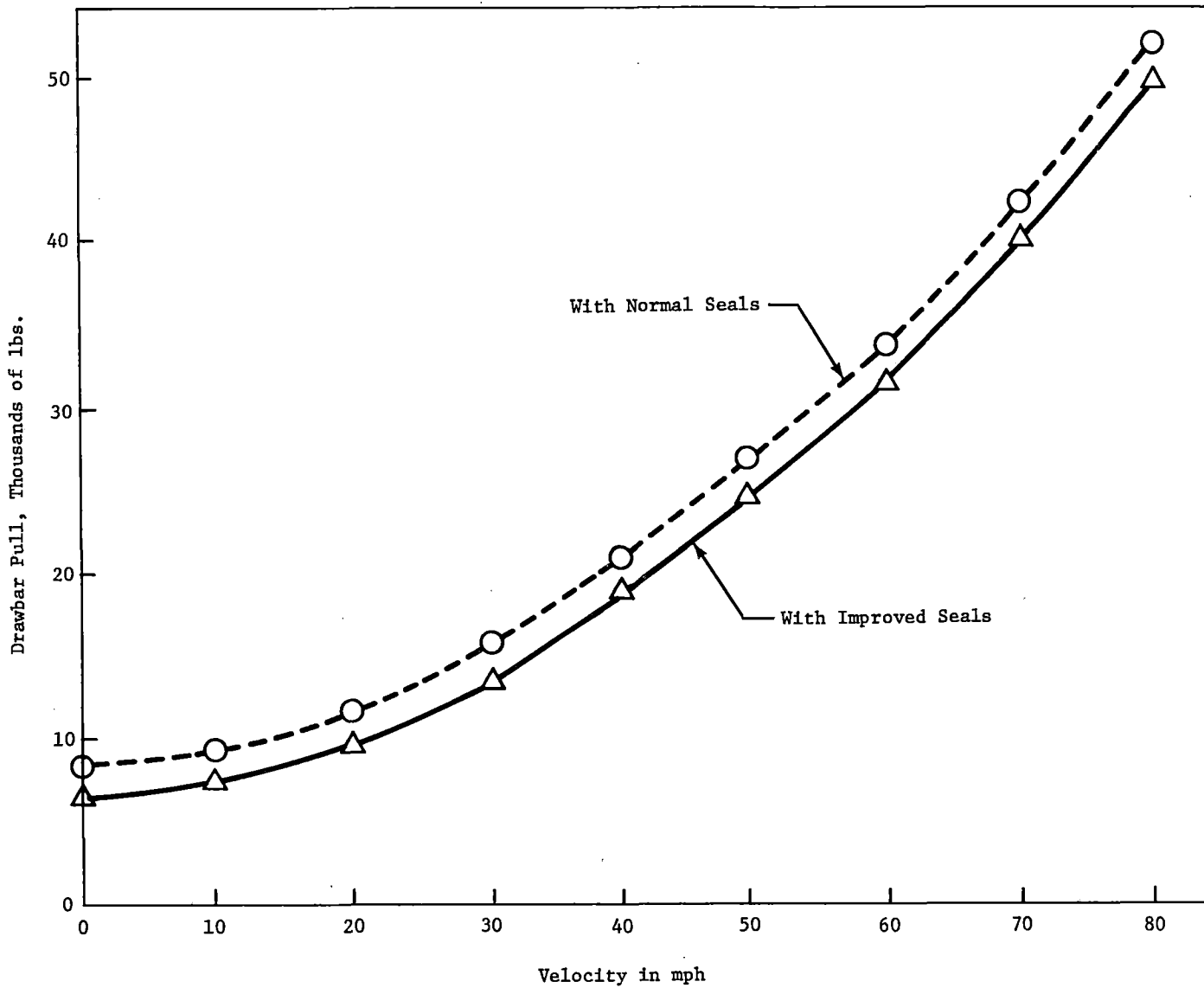

FIGURE 23
REDUCTION OF RESISTANCE OF AVERAGE TRAIN
WITH IMPROVED BEARING SEALS

How can this be translated into fuel savings? The mechanical drag represents a large **proportion of total drag at lower velocities**; hence reductions in mechanical drag at lower speeds will be more advantageous proportionately than at higher speeds.

Since the mechanical drag is fixed in value, possibly a relationship to energy per mile rather than power would be more meaningful. This reduction in rolling friction means for the average train a reduction of 1769.6 lbs. drag, or $9.34 \cdot 10^6$ ft. lbs. per train mile. Such a reduction would represent for the $424 \cdot 10^6$ freight train miles per year a saving of $3.96 \cdot 10^{15}$ ft. lbs. per year to the railroads in this country. At a penalty of 11 HP-hr. delivered by the locomotive per gallon of fuel [32], this represents $181.8 \cdot 10^6$ gallons of fuel per year or at the 1976 average price for diesel fuel of 31.64 c/gallon [31], a value of \$57.5 million per year. This also is equivalent to approximately 4.5% of gross fuel consumption and cost.

These figures are based upon comparison with the least favorable competition to the improved seal; on the average, only a reduction of 18% is claimed. This reduces the savings proportionately, so that only \$33.4 million are saved. Nevertheless this is a substantial amount.

How many bearings are there in use? For the approximately 1.7 million cars, there are 27.2 million seals, assuming all are four-axle roller-bearing-equipped cars. The cost of the seal and the labor for replacement must be suitably weighed against the savings, using the methodology presented in Section 9.

8.2 Light Weight Equipment

8.2.1 Aluminum Hopper Cars

The conventional 3400 cu. ft. steel hopper car used as an example in this report weighs 59600 lbs. [33]. With the 263,000 lb. gross wt. limitation, this car can carry 203400 lbs. of coal or similar commodity. The aluminum hopper car designed to replace it weighs only 47,000 lbs. This weight reduction could be reflected in reduced train resistance for the same load, or additional load for the same train resistance. The advantages will be examined in both cases, although it seems likely that the car would normally be loaded to the allowable capacity, making the latter case the normal operating strategy.

Both a fully loaded unit train and a unit train of average load per car are used as examples, as the proportion of total resistance represented by weight effects will be different. An average length train of 67 cars is used in each case. The total resistance of the steel hopper car train at 60 mph over level, tangent track is found to be 31,717 lbs. and of the aluminum train 31,211 lbs., a reduction of only 1.6%. For the train with an average number of empties (35), and with the loaded cars only loaded to the average load (61.0 tons), the respective figures are 25,883 lbs. and 25,377 lbs., a reduction of 2.0%.

Both of these figures represent a diminution of drag force for the train of 506 lbs. at 60 mph. This reduction is dependent upon speed, and the reduction at 20 mph is found to be only 338 lbs. But the average freight train speed, taking the 39,124 net ton-miles per freight-train-hour divided by 1943 net ton-miles per freight-train-mile from [31], is almost that figure (20.1 mph). If this figure is used, by the same reasoning as in the previous section, this represents a

saving of \$3.9 million per year to the railroads in fuel costs taking into consideration that only 35% of the railroads' rolling stock is hopper cars.

A more attractive scenario is that the lighter weight cars can produce more revenue by hauling more freight. The aluminum car can haul 6.3 more tons per trip. Taking 35.1% of the $28514 \cdot 10^6$ car miles per year for hopper cars and multiplying by the 1943/4097 proportion of loaded car miles to empty car miles yields $4746 \cdot 10^6$ actual loaded hopper car miles per year. At 6.3 additional net tons and an average revenue of \$.02164 per ton-mile this means average annual additional revenue of \$656 million for the railroad hopper car fleet, or \$1101 per car per year.

The additional cost for aluminum hopper cars is estimated to be between \$36,000 and \$44,000 in 1975. The weight advantage analyzed above has at least been partially diminished by the appearance of lighter weight steel hopper cars. Both of these above factors have contributed to the fact that aluminum hopper cars have not been manufactured for some time in this country.

It is conceivable that in unit train operation in mountainous areas greater savings could be effected, when the energy going up a grade is not recovered. The amount recovered would depend upon the route traversed, the velocity profile, the grades, etc., in short, the operational strategy. Analysis of such real train operations will be the subject of further research. For the present, the decision to curtail manufacture of aluminum hopper cars is some indication of the meagreness of the savings which can be effected through reduction of carbody weight for ordinary mileage cars operated over level track.

8.2.2 Lightweight Flatcars

The cars selected are specifically related to TOFC/COFC operation. Since little information is available concerning the makeup of TOFC/COFC trains, a train of average length of 67 cars was used. Three variations of consist were selected as representative trains to be analyzed for each type of intermodal operation; trailer cars were not mixed with container cars. The consists used are described below:

- a. a unit train, with 67 cars, each with twin trailers or containers fully loaded (61 tons net);
- b. a similar train, with 67 cars, each with two trailers or containers, but only 32 cars carrying loads (61 tons net);
- c. a mixed consist of 33 twin trailer or container cars and 34 single trailer or container cars, with each trailer or container fully loaded (30.5 tons each).

The net load figures are for the flatcar and include the container or trailer weights. The order in the mixed consist was selected by means of a shuffled card deck.

The results for the TOFC and COFC consists respectively are shown in Figures 24 and 25. The curves for the TOFC operation show a reduction of 768 lbs. in drawbar pull at 60 mph regardless of consist. As expected, the mixed consist with empty spaces between trailers shows a significantly higher resistance. Of the two consists completely filled with trailers, the lighter train has the least resistance. The curves for the COFC operation are similar and show an overall reduction of 1214 lb in drawbar pull at 60 mph regardless of consist, and the relationship among the curves is the same as with the TOFC curves. The scale of the curves in general is lower for the COFC operation, as wind tunnel tests have demonstrated the superior drag characteristics of COFC equipment. The reduction is larger for the COFC equipment because the COFC lightweight flatcar is lighter than its TOFC counterpart and the reduction in weight is greater.

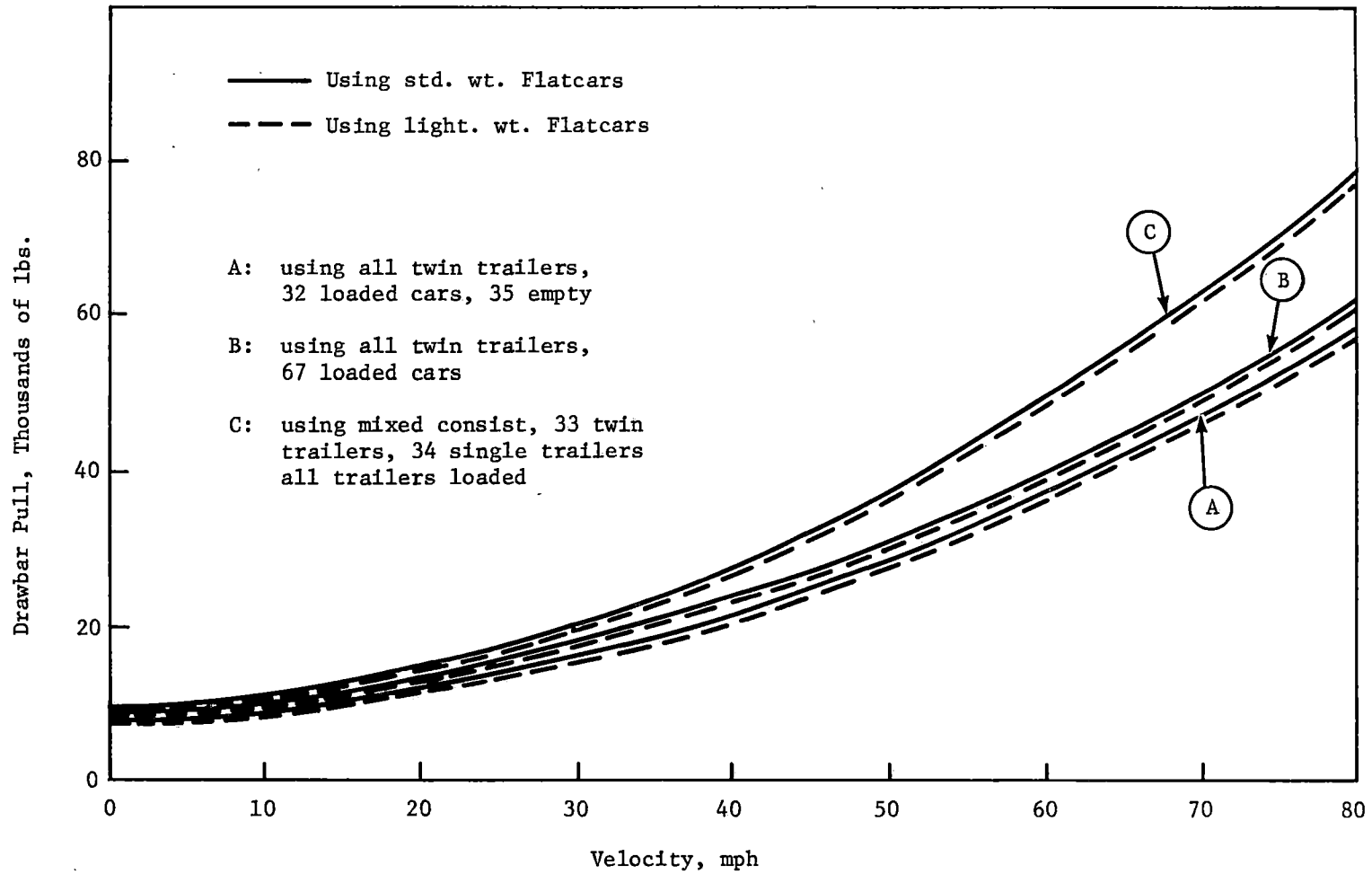

FIGURE 24
 COMPARATIVE TRAIN RESISTANCE OF SELECTED TOFC
 CONSISTS ON LEVEL TANGENT TRACK

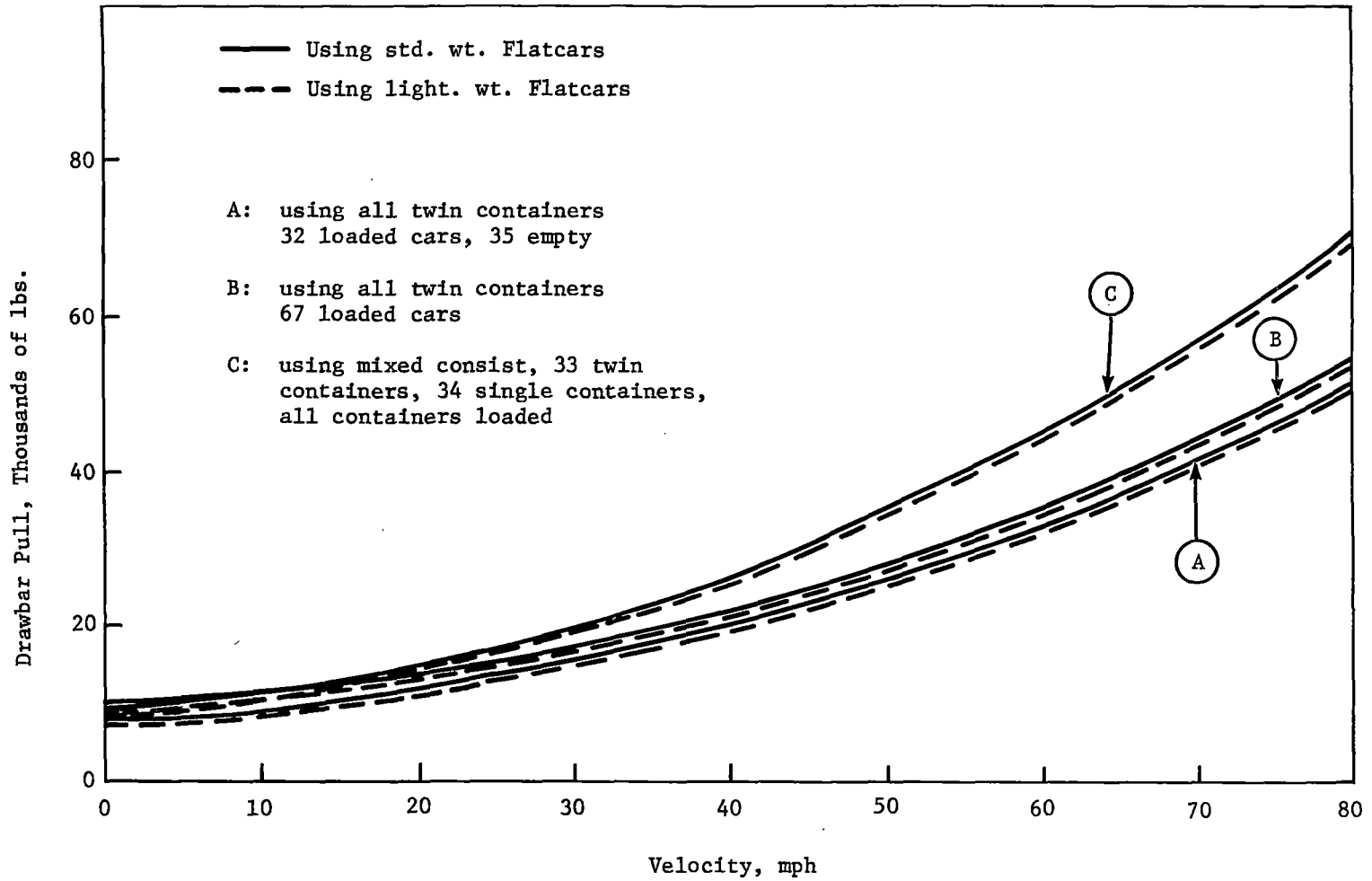

FIGURE 25
 COMPARATIVE RESISTANCE OF SELECTED COFC
 CONSISTS ON LEVEL TANGENT TRACK

From examination of the curves it appears that the reduction in resistance through the use of lightweight flatcars is insignificant; the curves appear to be almost on top of one another. The actual percentage reduction at 60 mph for the more lightly loaded TOFC and COFC operations (curves "A") were 2.1% and 3.6% respectively. The reason the reduction is so small is that the reduction in the weight of the car is only a portion of the weight of the car; the weight of the car is only a portion of the gross weight of the loaded car; and the portion of the resistance contributed by the gross weight of the car is only a portion of the entire resistance, especially at the higher speeds, where air resistance assumes so much more importance.

It should be emphasized that the results are predicated upon operation over level tangent track and that results for an operation in mountainous regions might be significantly different. Moreover, the percentage reduction at lower speeds is higher, as the mechanical resistance assumes more importance. The percentage reductions for the same TOFC and COFC operations at 20 mph were 4.2% and 6.7% respectively.

Whether these results are actually significant depends upon how they translate into dollar savings. The approach used in Section 9.2 to evaluate the savings attributable to the use of improved bearing seals could be utilized if the proportion of TOFC and COFC operation mileage to total railroad operation mileage were known. TOFC/COFC carloadings represent approximately 7% of all carloadings [34], and if it can be assumed these travel the same distance as other carloadings on the average, the fuel consumed by the TOFC/COFC operations will conservatively be proportional to this figure as a percentage of total railroad fuel. Thus using an approximate figure of 826 lbs. reduction in drag over the 7% of total railroad mileage attributable to TOFC/COFC operation yields an annual savings to the railroads of \$1.9 million in fuel costs.

As with the bearing seals, the cost of replacement must be weighed against the savings, using the methodology of Section 9.

8.3 More Favorable Consist Makeup

The concept of a more favorable consist makeup was explored briefly in Section 7, where several examples were given to illustrate the dependence of train resistance upon the arrangement of cars in the consist. The relative importance of the arrangement of the consist will now be examined for several specific types of trains.

8.3.1 Average Train

The average train discussed in the beginning of Section 8 was used as an example. Three other orders were established through a random process to determine the approximate spread of values of train resistance which could be expected with random arrangements of the same consist. The four values for the resistance of this average train which were obtained were, for 60 mph: (1) 33306, 34252, 34736, and 34798 lbs. The approximate spread about a mean value is + 1.4%.

How can such a train be rearranged more favorably? The simplest arrangement, and probably in this case the most favorable, would be to group all the boxcars together, followed by the hopper cars together, then the empty flat cars, the loaded flatcars, and finally the tank cars in front of the caboose, thus creating a minimum number of air gaps in the train. This resulted in the resistance dropping to 29659 lbs., or a reduction of 13.5% from the same mean value before. The percentage reduction is considerably larger than the spread due to the random placement of cars in the consist.

The placement of the flatcars together probably produced most of the reduction of resistance. As an approximate limit, the resistance

would approach that of a unit boxcar or hopper car train. For the same loading (32 loaded and 35 empties) a unit boxcar train shows a resistance of 27885 lbs. at the same speed, a further 6% reduction over the last figure.

Is this worth considering? If one grants the present validity of the calculation, a 13% reduction in the resistance of the average train at 60 mph is certainly worth considering. Even if actual speeds today are less, the reduction at 30 mph is 7.5%. The total fuel bill of the nation's railroads, as noted before, is over \$1.2 billion [30]. Even a 5% reduction is equal to \$60 million.

8.3.2 TOFC/COFC Operation

Savings which can be effected in TOFC/COFC operation are completely dependent upon the ratio of empty flatcars and flatcars carrying only a single trailer or container to the number of flatcars carrying two such items. No savings can be effected on a unit COFC train, and the possible savings that might be effected through heading the trailers in the correct direction on the flatcar so that the overall drag is minimized seem negligible. However, arranging the train where gaps exist so that the gap placement is favorable shows considerable promise. It remains to be determined how often such trains are run, as opposed to complete unit trains. Such an extensive analysis of intermodal operations is beyond the scope of this report, and possibly such information is not available anywhere, but examination of an example will nevertheless be illuminating.

The partially empty TOFC/COFC trains previously conceived for examination of the lightweight flatcar problem were used as examples for lack of more representative trains. Only a rearrangement of such a partially empty (gap-wise) train is meaningful, as the resistance

of a complete unit train cannot be diminished by rearrangement. First, as with the average train of the previous section, the resistances of several random orderings of these consists were computed in order to establish an approximate value for the spread due to randomness. The resulting resistances at 60 mph with these random orderings were, for the trains originally discussed in Section 8.2, as follows: 49042, 48604, 47762 and 49280 lbs. for the TOFC train and 45345, 44766, 44178, and 45446 for the COFC train. The approximate spread about a mean value is $\pm 1\%$.

It is obvious how such a train should be arranged to minimize aerodynamic drag. All cars with two trailers or containers should be grouped together behind the locomotive, while pairs of cars with single trailers or containers, arranged so that the single trailers or containers are back to back, as illustrated in Figure 26, should follow. Such an arrangement for the same consist results in the resistance at 60 mph dropping to 43071 lbs. in the TOFC train, and 39903 lbs. in the COFC train, a reduction of approximately 11% in each case.

Unfortunately, until more detailed information is available on TOFC/COFC operations, it is impossible to predict the potential full savings implicit in such rearrangement. If the consist is reasonably representative, however, the savings could be substantial.

8.3.3 More Unusual Trains

A train used as an example of a least favorable consist would be one in which TOFC/COFC cars, or the unusually large pieces of rolling stock such as the auto-rack car and the Hi-Cube or Stak-Pak car, are interspersed with conventional rolling stock. The train illustrated in Figure 16 was an approximation of this type, although

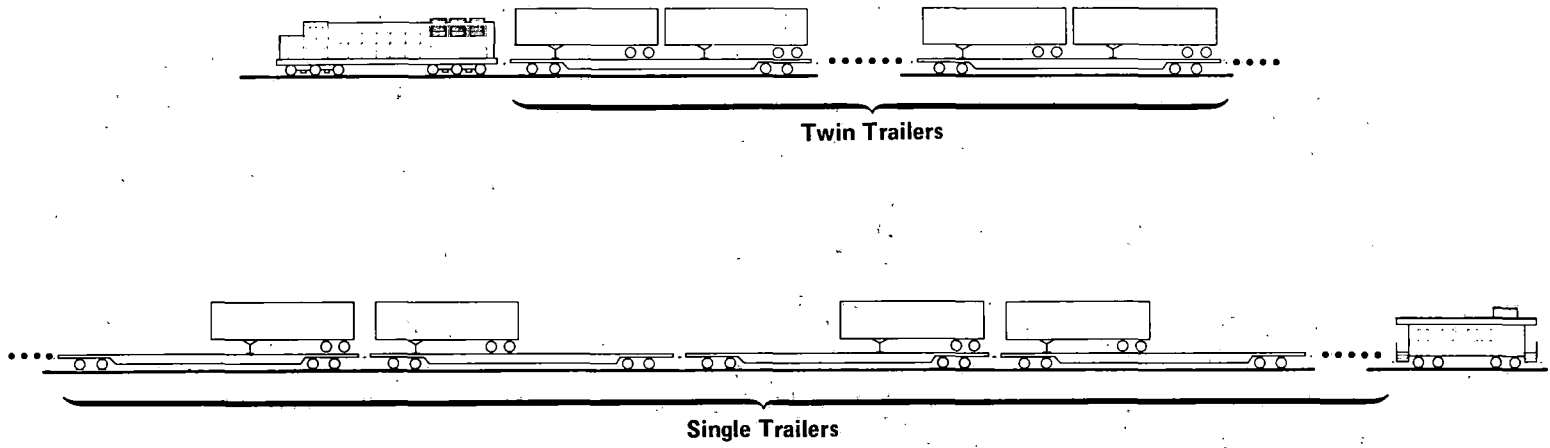

FIGURE 26
REARRANGEMENT OF MIXED TOFC CONSIST

there was only one conventional piece of rolling stock among the eight freight cars. It was shown that the train resistance of this consist can be reduced 22% by rearrangement.

This is certainly an extreme case. The number of cars other than what might be called conventional rolling stock is very small, only 32250 out of a total of 1,699,027 cars [30]. However, flatcars represent a larger proportion, 141,781 cars, or 8.3%. It must be presumed that this last figure includes flatcars used for TOFC/COFC service. Hence, a train truly representing a cross section of all rolling stock, including that categorized as "other freight cars" would not be significantly different in aerodynamic characteristics from the "average" train already discussed.

Nevertheless, a train with a mixed consist of half conventional rolling stock and half TOFC/COFC or unusual cars might be of interest as a further example. Such a train was created using the same proportions of conventional rolling stock as on the "average" train for half of the cars, and dividing the other half among TOFC/COFC cars, auto-rack cars, and Stak-Pak or Hi-Cube cars. The resulting consist is shown in Table III.

TABLE III
CHARACTERISTICS OF AN "UNUSUAL" TRAIN

NUMBER LOADED	CARS	NUMBER EMPTY	TOTAL
6	Boxcars	6	12
6	Hopper Cars	6	12
1	Gondola Cars	2	3
1	Flatcars not TOFC/COFC	2	3
1	Tank Cars	2	3
3	TOFC, twin	3	6
2	TOFC, front	2	4
2	TOFC, rear	2	4
3	COFC, twin	3	6
2	COFC, front	2	4
2	COFC, rear	2	4
1	Auto-rack car	2	3
<u>2</u>	Hi-cube car	<u>1</u>	<u>3</u>
32		35	67

The cars were initially arranged in random order and subsequently arranged in three other random orders. The loaded cars were given the average load of 61 tons previously used. The resulting resistances at 60 mph were: 45082, 44084, 45579, and 43552 lbs. respectively, showing a deviation of the average of the two highest and lowest from the mean of 1.7%.

The consist was subsequently rearranged in what appeared to be a favorable arrangement, with the cars grouped as follows: first all the boxcars, then the hopper cars, tank cars, gondola cars, empty flat cars, loaded flat car, single container COFC in pairs with containers back to back, single trailer TOFC grouped similarly, double container COFC, double trailer TOFC, auto rack cars, and Hi-Cube cars, with of course the locomotives in the front and the caboose in the rear. The resistance was lowered by such rearrangement to 36,244 lbs., a reduction of 19% from the mean. However, as this consist is by no means

representative and was only conceived as an illustrative example, such reductions should not be expected from rearrangement of an ordinary train or on an overall basis throughout the railroad industry.

8.3.4 Summary of Consist Makeup Results

It has been seen from the trains used as examples in this section that the variation of train resistance due to random ordering is on the order of $\pm 2\%$. It has also been seen that reductions of train resistance attributable to rearrangement of the consist ranged from 11% to 19%. While because of the poor data base from which the figures were derived and the unproven methodology there is considerable uncertainty at this time in these figures, nevertheless there appear to be good possibilities for considerable reduction in fuel consumption through consist rearrangement. Whether it can be made cost-beneficial is a subject for Section 9.

8.4 Improvement of Track Rigidity

The previous sections have demonstrated the dominance of air resistance of the consist at higher speeds. Still, an absolute reduction of train resistance of any nature is desirable. The possibility that the track itself may contribute substantially to the resistance to forward motion has been raised earlier by Scales [21], as mentioned in Section 7.2. He emphasized that differences in track construction in various countries were responsible for apparently large differences in train resistance.

There is reasonably compelling evidence that this is true, as shown in Figure 8 earlier. However, two questions are raised with regard to the subject and its applicability here. How much can the resistance be diminished if the track and substructure are rigidized, and how much track in this country is already at such a high level of rigidity that the likelihood of a financial benefit through improving the track would be minimal? The first question will be addressed first.

If the formula by which train resistance is calculated is at all meaningful, there is an absolute limit to what can be achieved. The correspondence between the figure of 20 lbs. per axle in the modified Davis formula and the bearing seal friction was noted in Section 8. As the distinction between those effects not speed-related and those which are is somewhat blurred [3], it is difficult to say what portion of the remaining constant term and the velocity-dependent term in the equation is attributable solely to track conditions. However, Keller, in the same article [3], points out that a 1937 AREA study showed that the theoretical resistance contributed by the deflection of the rail and track substructure was between .44 and .84 lbs. per ton, depending upon rail weight per yard. It is not unreasonable to relate the .6 lbs. per ton figure in the modified Davis formula to this phenomenon.

This figure was therefore removed from the calculation for the purposes of examining the effect of this phenomenon. The results of this operation on the average train are shown in Figure 27 over the usual velocity range compared with the resistance of the same train as previously calculated. The resistance of the train on rigid track is 2636 lbs. less across the entire velocity range.

Probably some of the velocity-dependent term is a function of this phenomenon as well, since it can be argued that energy is dissipated in what is effectively the damping effect of the ground as the train causes the track to move up and down. At 60 mph the velocity-dependent term accounts for an additional 2637 lbs. resistance. Attributing only 364 lbs. of this amount to the previous 2636 lb. figure from rail and subgrade rigidity means that drawbar pull can be reduced 3000 lbs. through stiffening of the track. This is approximately 9% of the resistance at 60 mph. At lower speeds, the percentage reduction is considerably larger: at 20 mph, the reduction is 26%.

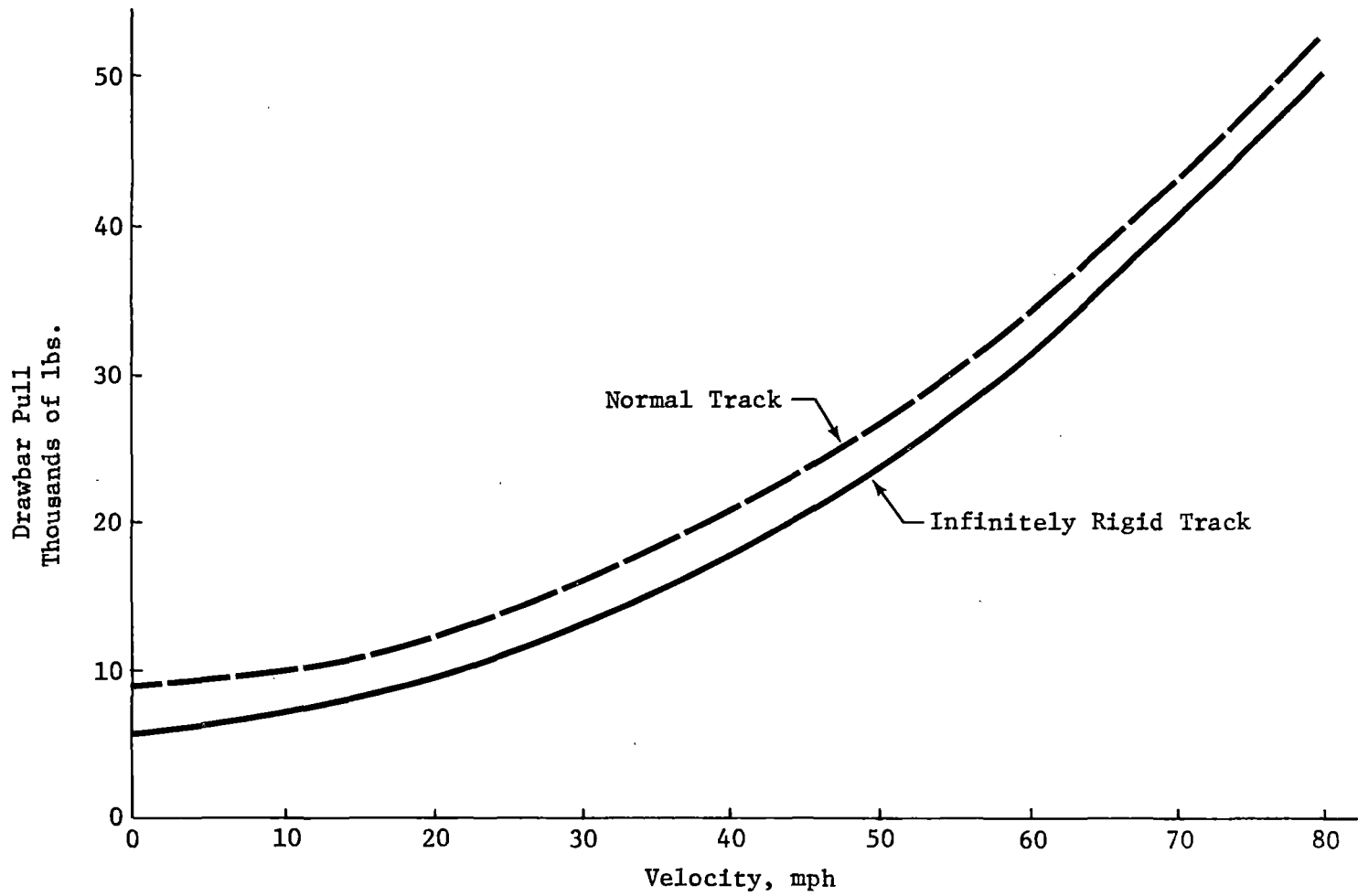

FIGURE 27
REDUCTION IN RESISTANCE OF AVERAGE TRAIN
DUE TO INFINITELY STIFF TRACK

These are substantial reductions. However, we must turn to the second question of present track rigidity. It already appears that American track is substantially stiffer than most, the only known exception being that of the Soviet Union. How can the American construction be made more rigid? It has been noted that tie spacing has a considerable effect upon track resilience. But it appears unlikely that as a practical matter American ties can be placed more closely together. Possibly laying the track on a rigid concrete beam, as has been done experimentally in several countries, would improve the rigidity, but it is beyond the scope of this paper to analyze such a phenomenon. A final alternative is to stiffen the rail itself, thus spreading the load over a larger number of ties. That this alone has a marked effect has already been noted (see Section 7.2). But whether such a move would be cost beneficial must remain the subject of a future study.

8.5 Improved Truck Design

Excessive carbody motion is usually attributed to poor truck design, which permits a relatively large excitation force to act upon the carbody. This motion results in the dissipation of energy which must ultimately be obtained from the locomotive. In addition, if the truck is not assembled properly, the truck will tend to run crab-fashion and general flange resistance will be magnified. These effects are discussed briefly in Keller [3] and Koffman [35]. Keller implies that because of the inconvenience of dealing with the phenomenon directly the effect of this source of resistance is spread throughout the several factors of the general formula. However, Koffman implies that it is the velocity-dependent term which accounts for this phenomenon. Since such energy dissipation is considered intuitively to be velocity-dependent, it appears more likely that the latter presumption is correct. For the remainder of this discussion, then, it will be assumed that truck effects are those associated with the velocity-dependent terms of the equations.

Such an assumption permits, as with the phenomenon of track resistance, a calculation of the absolute limitation upon the energy available to be saved through elimination of truck hunting and carbody oscillations. The velocity-dependent term is simply made equal to zero in calculation of the resistance.

Again, this calculation was performed for the average train in several arrangements of the consists and the results compared with results previously obtained for the average train. The resistances at 60 mph were found to be 48119, 50772, 50663, and 49100 lbs. from the four runs, for an average value of 49664 lbs. This is smaller than the previous average value of 51632 lbs. by 1968 lbs. or 3.8%.

This is smaller than most of the other potential gains discussed previously but larger than those for lightweight cars. It must, however, be realized that this figure is a limit, to be achieved only if all such energy dissipation is eliminated. It seems more likely that improvement of truck design will eliminate only a small portion of this velocity-dependent resistance, and that benefits to be obtained through such improved design must accrue through other less tangible benefits than reduction of train resistance. An obvious example is reduction of lading damage, but it is beyond the scope of this report to assess possible returns in that area. Unless a larger portion of the general train resistance can be attributed to other than the velocity-dependent term there appear to be few benefits regarding fuel consumption to be derived from pursuing improved truck design. However, because this possibility is real, the potential gains should not be dismissed without further investigation.

8.6 Other Modifications

There are not many other areas where train resistance can be improved, if the formulas have meaning. The effect upon train resistance of diminishing each of the several terms in the resistance equation has already been explored. Other effects appear to be of a secondary nature and have not been found to warrant a separate term in the equation. However, there may be additional effects. A good example of this is the portion of train resistance attributable to the loss of kinetic energy in jumping the gaps in the rail at the joints. This can be shown to be dependent upon the square of the velocity [34] and its effect has no doubt been attributed to air drag since the conception of the resistance equations. However, Koffman points out that at 60 mph the resistance may be as much as 2.7 lbs. per ton for a 1/4" gap. For the average train previously used as an example, with a gross train weight of 4395 tons, this indicates that the drag attributable to this phenomenon may be on the order of 11000 lbs. over jointed rail. Another probably more accurate formula taking into consideration the length of rail sections, and consequently the frequency of impact over the joints, gives a resistance of only 1.4 lbs./ton, or almost 6200 lbs., still a substantial portion (20%) of the total drag. If only half of this could be recovered through the use of welded rail, the savings in fuel consumption would be comparable to any of the methods of approach considered earlier. Certainly it lends itself to retrofitting more readily than other approaches, as rail must be replaced periodically anyway.

9.0 BENEFIT COST METHODOLOGY

The approaches to reducing train resistance outlined in the preceeding sections could lead to fuel savings, but before they are adopted, they must prove to be profitable for the railroads. This section presents a methodology for evaluating the profitability of the various approaches to train resistance reduction. The methodology will point out the principal savings and costs, ways of calculating them, and how to compare them to determine the attractiveness of each approach.

9.1 Improved Roller Bearing Seals

Reduced resistance from improved roller bearing seals reduces the energy required to pull the car. This saving can be in fuel saved, less power required per train, or higher speeds achieved with the same power and fuel use. Depending on its own operating needs, a railroad may find different combinations of these benefits appropriate to different trains; for example, less power on coal drags, more speed on TOFC trains. Fuel savings will be the most important savings, at least at first, since only a small portion of cars will be equipped with the improved bearings. The small reduction in horsepower required per train or small increase in speed achievable will be lost in the "noise" level for trains with only 2 or 3 cars equipped with improved bearings. Fuel savings are estimated at .006 gallons/mile/car. Therefore, to estimate the savings from equipping a car with improved bearings, the number of miles traveled per year would be multiplied by .006 gallons times the price of diesel fuel to get savings per year. These savings would be weighed against the cost of the bearings, differences in labor to install, differences in routine maintenance costs, and differences in bearing life. If it is assumed that bearing life, maintenance costs, and installation costs are the same for both types of bearings and any savings from reduced wear on draft car or

other impacts from the bearings are disregarded, the benefits and costs can be computed by determining the value of fuel saved, as illustrated in this example:

Savings:

Yearly Mileage (assume 20,000)		20,000
.006 gallons	x	<u>.006</u>
Gallons saved per year		120
Price of Diesel Fuel (\$.32 per gallon)	x	<u>.32</u>
Yearly savings		38.40

Costs:

The costs of using the improved bearings depend on how a railroad would introduce the bearings. There are three alternatives: (1) order new cars with the improved bearings, (2) replace unserviceable bearings with the improved bearings and (3) retrofit cars with currently serviceable bearings with the improved bearings.

Ordering cars with improved bearings would mean the costs would be the extra cost of the bearings alone, but the extra cost would have to be depreciated along with the rest of the car. The cost of replacing unserviceable bearings with the improved bearing would also be only the extra cost of the improved bearing, but the cost would be treated as an expense for tax purposes. Finally, retrofitting existing cars would include the extra cost of the new bearing and the remaining life of the old bearing, as well as the labor to install the bearing.

- Case 1 Extra cost of bearing Seal: BC
 Life of bearing seal = n years
 Depreciation (subtract from savings for each year)
 gives yearly savings = Y_1, Y_2 etc. for year 1, year 2, etc.

Internal Rate of Return is r (before tax, assume 1/2 for after tax)

$$BC = \frac{Y_1}{1+r} + \frac{Y_2}{(1+r)^2} + \frac{Y_3}{(1+r)^3} + \frac{Y_n}{(1+r)^n}$$

Case 2 Extra Cost of bearing seal - tax rate (assume 1/2) = BC
 Life of bearing seal = n years
 Yearly savings = Y_1, Y_2 , etc. for years 1, 2 etc.

Internal Rate of Return is r (before tax, assume 1/2 for after tax)

$$BC = \frac{Y_1}{1+r} + \frac{Y_2}{(1+r)^2} + \frac{Y_3}{(1+r)^3} + \frac{Y_n}{(1+r)^n}$$

Case 3 Extra cost of bearing seal - tax rate (assume 1/2) = BC
 Present values of unused bearing life = PV
 Installation labor = L
 Life of bearing seal = n years
 Yearly savings = Y_1, Y_2 etc. for years 1, 2 etc.

Internal Rate of Return is r (before tax, assume 1/2 for after tax)

$$BC + PV + L = \frac{Y_1}{1+r} + \frac{Y_2}{(1+r)^2} + \frac{Y_3}{(1+r)^3} + \frac{Y_n}{(1+r)^n}$$

9.2 Lightweight Equipment

9.2.1 Lightweight Hoppers

Light-weight equipment reduces train resistance, thereby conceivably saving fuel, reducing horsepower requirements, or speeding operations. Lightweight hopper cars operated at 20 mph would save .0012 gallons of fuel per mile per car, based on the figures presented in Section 8.2.1. Determining costs and benefits can be approached in the same

way as was done for improved bearing seals. Benefits can be determined by multiplying annual mileage by .0012 gallons saved then multiplying that figure by the cost of fuel, .32¢ a gallon. At average freight car mileage of 20,000 miles a year, savings of \$7.68 per car per year would be achieved. In unit train operations, with say 100,000 miles a year, annual savings would be \$38.40. These savings would have to offset the additional first cost of car. Given that aluminum cars are \$36,000 to \$44,000 more expensive, savings about 100 times as large as these would be required to make the investment worthwhile in terms of fuel savings. Additional savings from dragging less weight around would result from less wear on track structure and reduced energy in pulling grades.

9.2.2 Lightweight Flatcars

Lightweight flatcars for TOFC/COFC service might be adopted partially because of fuel savings. Using the figures in Section 8, a TOFC train of lightweight cars shows a reduction of 768 lbs. in drawbar pull at 60 mph. This is equivalent to .0027 gallons of fuel per car-mile. A lightweight flatcar operated 20,000 miles a year at 60 mph would use 54 gallons of fuel less than its heavier counterpart. Using \$.32 a gallon as the price of fuel, the savings in a year would amount to \$17.28. A COFC train, due to lighter weight, would have 1214 lbs. less drawbar pull at 60 mph than its conventional equivalents. This amounts to .0043 gallons per car-mile or 86 gallons a year for 20,000 miles of operation. At the current price of diesel fuel, annual savings would be \$27.52. If the flatcars covered larger distances in a year, the savings would be proportionately greater. These savings alone may not justify lighter cars, but if the other advantages of lighter cars, such as reduced wear on track structure, draft gear and other elements affected by weight are great enough, then the savings might be worthwhile.

9.3 More Favorable Consist Makeup

The arrangement of cars in a consist appears to have a significant effect on air drag and therefore fuel consumption. Arranging the cars of the "average" train of Section 8 optimally led to a 4614 lbs. reduction in train resistance, the difference between the mean of the resistance of the four random consists and the optimum consist described in the same section. This can be translated into saving 1.1 gallons of fuel per train mile for the 67 car average train. With diesel fuel at \$.32 a gallon, a 1000 mile trip with an optimally arranged consist could save \$352 over random consists.

The cost of arranging the consist optimally involves no capital expenditure, only the extra switching expense in making up and breaking up the train. Since the savings are greater the faster and longer the train travels, rearranging consists is most worthwhile on long, uninterrupted hauls, such as Chicago to the west coast.

Using the savings figures above, a railroad could look at how many switching moves are required to rearrange the consist and with the cost per switching move, determine the cost of the rearranging. Since a railroad would not wish to go to the trouble of performing these calculations for every train, they might after some experimentation decide to rearrange certain regular trains that consistently show a benefit from rearranging. If switch crews are not fully employed, they may be used for some rearranging at little extra cost.

The decision to rearrange would have to be made on the examination of specific, regularly scheduled trains, with knowledge of average resistance, optimal resistance, potential savings, and switching costs. The effect of rearranging on blocking and service must also be considered. Another area of interest may be to establish rules for making up blocks, such as putting similar cars together when a choice exists.

9.4 Improvement of Track Rigidity

Greater track rigidity could lead to savings from decreased fuel use. It is very difficult to estimate savings from incremental increases in track rigidity. However, using the figures of Section 8 as a limit, an infinitely rigid track would save .64 gallons per train per mile, or \$.20 at \$.32 a gallon for diesel fuel. If a mile of infinitely rigid track carries 5000 average trains a year (4000 tons a train), 20 million gross tons a mile, the savings would be \$1,022 per mile of track. While the cost to make track in effect infinitely rigid would be prohibitive, an improvement in rigidity might lead to a significant gain in fuel saved. In addition, more rigid track has additional benefits in terms of decreased lading damage and reduced wear on rolling stock and track structure. Further research is needed in order to determine the costs and savings from various methods of increasing track stiffness.

9.5 Improved Truck Design

The drag attributable to trucks was determined to be 1968 lbs. for an average train. If "perfect" trucks were used and this drag was eliminated, fuel consumption per car mile would decrease by .007 gallons. If a car travels 20,000 miles a year, the savings would be 140 gallons of fuel a year, or \$44.80 if diesel fuel cost \$.32 a gallon. For unit trains traveling 100,000 miles a year the savings would be \$224.00 a year. These figures are limits, the maximum savings possible if truck drag could be eliminated. However, the figures do show that truck drag is a factor to be considered, and better design might reduce fuel costs, as well as other costs associated with trucks.

10.0 FRUITFUL AREAS FOR NEW RESEARCH

Several possibilities for reducing train resistance and consequently improving fuel economy have been examined in the previous section in the light of existing knowledge about the subject. Preliminary estimates of potential savings by implementation of these modifications have been given. Most of the areas indicated that savings of some magnitude could be made. Some, however, appeared to have better prospects than others.

However, it must be noted that these estimates of potential savings are at this time quite preliminary. Unfortunately, the state of knowledge about train resistance at this time does not permit completely definitive answers. Some information of the most fundamental nature on air drag is lacking, the validity of the standard formulas used to compute train resistance is to a certain degree questionable, and the effect of many parameters is considered to be lumped into the effect of others or is ignored altogether. In short, it is not surprising if the results of many investigators either fail to substantiate existing formulas or fail to correspond closely with the results of other investigators.

Before more definitive results can be obtained, there are several areas which need study. These are discussed below:

- a. In order to establish a more firm theoretical basis from which to analyze train resistance, the origins of the modified Davis formula and the rationale behind its development should be determined. While many investigators in the field will contend that this formula agrees more closely with results of current testing and that it was conceived to reflect the more modern equipment in use today, the rationale behind its development must be determined so that its own accuracy can be improved. Although the mean resistance determined by use of this formula may more nearly reflect the true mean of resistance today, the deviation from the mean has probably not improved much. On what basis and under what conditions was the .07 coefficient for the V^2 term obtained? Was the constant term truly intended to correspond with bearing seal friction? What kinds of trucks were the freight cars used in these tests

equipped with? Or were actual tests not run, and the formula deduced on theoretical grounds? The answers to questions such as these regarding the Modified Davis formula should be answered so that there is some sound theoretical backing for the basic resistance formula before sweeping conclusions are drawn from its use.

- b. Some up-to-date confirmation of the magnitude of bearing friction is needed together with its weight and velocity dependence. Present theory excludes bearing friction from velocity dependence, but there is considerable evidence that in fact it is dependent upon velocity [11]. Moreover, in view of the considerable power consumed in the friction offered by the seals, some confirmation of the magnitude to be saved through improved seals is needed to substantiate or reject manufacturer's claims. Because of the partial dependence of such mechanical drag on weight and the recent emphasis upon weight reduction as a means of saving energy, the weight dependence of bearing friction also assumes importance.
- c. Fundamental data on the air drag of ordinary rolling stock is needed. If the methodology developed in this report for calculating the air drag of mixed consists is meaningful, arrangement of the consist can contribute heavily to the overall drag. Unfortunately the exact extent of this effect can only be guessed at this time because fundamental data are lacking. What is lacking is two-fold: (1) fundamental drag data on a single car, separated if possible into skin friction effects and pressure effects, and (2) drag data on the effect of one car upon another. Such data should be used to supply the methodology developed in the report with the required constants to permit air drag calculation of mixed consists.
- d. The methodology developed in this report for calculating the air drag of mixed consists should be pursued and confirmed as a meaningful and valid method for solving this problem, or a methodology similar in results produced should be developed independently and subsequently confirmed. The apparently large dependence of the resistance of the consist upon its arrangement makes the calculation of resistance of different arrangements important, and it is desirable if not imperative to have a convenient and proven method for doing so.
- e. Confirmation of the theoretical prediction of substantial reductions in train resistance on welded rail from values over jointed rail should be made. This phenomenon has

received too little attention and yet has apparently significant effects. In addition, its effect must be separated from the other drag also dependent upon V^2 , the air drag, lest mistaken conclusions be drawn about either. The additional reduction in train resistance attributable to stiffer rail and track substructure should also be pursued in conjunction with this investigation.

- f. Effects of truck design upon train resistance are generally included in the velocity-dependent term of the various formulas. There is a considerable discrepancy between the standard Davis formula and the modified Davis formula in the relative magnitude of this term. Therefore, an investigation should be made of the effect of truck design and particularly the truck hunting phenomenon upon train resistance. The investigation should entail both field testing and theoretical examination.
- g. Additional information beyond what appears to be available presently regarding TOFC/COFC operation needs to be assembled in order to be able to draw meaningful conclusions regarding possible changes in its operations. The most significant modification which can be made is deliberate arrangement of the consist when a significant number of flatcars are loaded with only one trailer. The ratio of the mileage travelled by such cars to that of doubly-loaded cars needs to be determined.
- h. A representative route needs to be established, over which simulations of train runs could be made, in order to draw more meaningful conclusions regarding railroad operations, rather than drawing conclusions based on operation over level tangent track. Train performance simulators are designed for this purpose, and generally they are run over specific sections of track. What is needed is a statistically representative track, simulation of a train run over which will give a true representation of all operations for a given railroad.



LIST OF REFERENCES

1. Davis, W. J., Jr., "The Tractive Resistance of Electric Locomotives and Cars," General Electric Review, October 1926, page 3.
2. Hay, W. W., Railroad Engineering, John Wiley & Sons, 1953, pages 68-84.
3. Keller, William M., "Variables in Train Resistance," American Society of Mechanical Engineers, Paper #58-A-265, 1958.
4. Marks, Lionel S., Mechanical Engineers' Handbook, Seventh Edition, McGraw Hill Book Co., New York, N.Y., 1967.
5. Gluck, H., "Energy Consumption at High Speeds," Railway Gazette International, V. 129, No. 12, December, 1973, pages 462-465.
6. Lipetz, A. I., "Air Resistance of Railroad Equipment," American Society of Mechanical Engineers, Paper RR-59-4, Transactions, 1937,
7. Ural, A., "Simplified Formula for the Calculation of the Tractive Resistance of Freight Trains," Glaser's Annalen ZEV, V. 97, No. 4, April 1973, pages 177-178, (German).
8. Koffman, J. L., "Tractive Resistance and Riding of Railcars," Diesel Railway Traction, November, 1963, pages 428-432.
9. Schmidt, E. C., "Freight Train Resistance; Its Relation to Average Car Weight," University of Illinois Engineering Experiment Station Bulletin No. 43, Urbana, Illinois, May 1910, reprinted July, 1934.
10. Tuthill, J. K., "High-Speed Freight Train Resistance: Its Relation to Average Car Weight," University of Illinois Engineering Bulletin, 376, 1948.
11. Hammitt, A. G., "Aerodynamic Forces on Freight Trains, Volume 1, Wind Tunnel Tests of Containers and Trailers on Flatcars," U.S. Department of Transportation, Federal Rail Administration, Report No. FRA/OR&D-76-295.1, December, 1976, pages 47-48.
12. Tope, Don, "Rolling Resistance of Freight Cars," The Timken Co., June 1971.
13. Hopkins, John, "Railroads and the Environment - Estimation of Fuel Consumption in Rail Transportation, Volume 1, Analytical Model;" U.S. Department of Transportation, Federal Rail Administration, Report No. FRA-OR&D 75-74.I, October, 1975.

14. "E - L Test Piggyback, Rack Car Resistance," Railway Locomotives and Cars, October 1966, pages 23-54.
15. Buckwalter, R. V., "Roller Bearing Service in Locomotive, Passenger, and Freight Equipment," American Society of Mechanical Engineers, Paper #RR-56-1, Transactions, 1934, V. 56.
16. Luebke, R. W., "Evaluation of TOFC Aerodynamic Resistance," Research Services Report, Planning Department, The C&O-B&O Railroad Company, December, 1966.
17. Hoerner, S. F., "Fluid Dynamic Drag," published by the author, Midland Park, N.J., Second Edition, 1965.
18. Koffman, J. L., "Tractive Resistance of Bogie Wagons," Railway Engineering International, September 1972.
19. Harada, M., "Experimental Study on the Running Resistance of JNR Freight Cars, General Equation of Resistance and Its Variance," Railway Technical Research Institute, Japanese National Railways, V. 8, No. 2, June, 1967.
20. Schmidt, E. C., and Marquis, F. W., "Effect of Cold Weather Upon Train Resistance and Tonnage Ratings." University of Illinois Engineering Experiment Station Bulletin 59, 1912, Urbana.
21. Scales, B., "Rolling Resistance and Track," Railway Engineering Journal, Institution of Mechanical Engineers, V. 2, No. 3, May 1973, (English)
22. Caldwell, W. N. and Marcotte, P., "Articulated Truck Development," Canadian National Rail Research, Montreal, Quebec, June, 1977.
23. Hammitt, A. G., The Aerodynamics of High Speed Ground Transportation, Western Periodicals Co., 13000 Raymer St., North Hollywood, Calif., 91605, 1973, pages 47-58.
24. Committee 16 on Economics of Railway Location and Operation, "Effect Upon Train Resistance of Lateral Forces Due to Side Winds," A.R.E.A. Proceedings, Vol. 43, 1942, pages 56-71, A.R.E.A., Chicago.
25. "Train Resistance Test - COFC vs. TOFC," Santa Fe Railroad Research Report, October.
26. Matthews, J. T. and Barnett, W. F., "Wind Tunnel Tests of a Scale Model Railroad Automobile Rack Car," U.S. Department of Transportation: Office of High Speed Ground Transportation, NTIS Publication No. PB-180198, June 1968.

27. Bernhard, M., "New Knowledge About Train Resistance at Very High Speed, (Tests with the TGV 001 Train)," French Railway Techniques, V. 18, No. 2; 1975, pages 31-36.
28. Haase, R. H. et.al., "Performance of Land Transportation Vehicles," Rand Corporation Report No. RM-3966-RC, published by National Technical Information Service, Report No. AD-428-668, January, 1964.
29. Hara, T., Kawaguti, M., Fukushi, G., and Yamomota, A., "Aerodynamics of High Speed Trains," High Speeds Symposium, Vienna International Railway Congress Association Bulletin, V. 45, N. 11, 1969.
30. Marks, Lionel S., Mechanical Engineers' Handbook, Seventh Edition, McGraw Hill Book Co., New York, N.Y., 1967.
31. Yearbook of Railroad Facts, 1977 Edition, Economics and Finance Department, Association of American Railroads, Washington, D.C.
32. "New Fuel Economics Through Roller Bearing Seals," Brenco Inc. Petersburg, Virginia, 1976.
33. Car and Locomotive Cyclopedia, 1970 Edition, Simmons Boardman Publishing Co., New York, N.Y.
34. "Market," Railway Age, June 27, 1977, page 63.
35. Koffman, J. L., "Tractive Resistance of Rolling-Stock," Railway Gazette, November 6, 1964, pages 899-901.



APPENDIX A

METHODOLOGY OF TRAIN RESISTANCE CALCULATION AND RELATED COMPUTER PROGRAM

1.0 GENERAL CONSIDERATIONS BEHIND METHODOLOGY

Because the methodology behind the train resistance calculations used in this report was specially developed to fill an apparent gap in technique of determining train resistance, some detailed explanation is required. While certain theoretical aspects of the train resistance problem have previously been explained in the main body of this report, this appendix is devoted more to the considerations behind the development of this particular methodology.

First, recognition had to be given to the fact that each piece of rolling stock is relatively unique and will contribute to train resistance in a unique fashion. This is contrary to previous pre-suppositions underlying the Davis and modified Davis formulas, which treat each car in the same fashion and calculate the train resistance on a lb. per ton basis. Such an approach was probably desirable in former times when calculation of train resistance on any other basis would have been a tedious time-consuming task. The advent of computer technology makes possible radical changes in techniques used to solve this problem. The tedious calculations become trivial, and large amounts of data can be permanently stored and instantly accessed for use in the computation.

Once this recognition has been granted, the second need is for a data bank of information pertinent to such train resistance calculations. For the purposes of the calculations in this report, what were felt to be representative pieces of rolling stock were selected and various parameters used in the calculations recorded. The pieces of rolling stock selected are illustrated in Figures A-1 through A-7. The selection

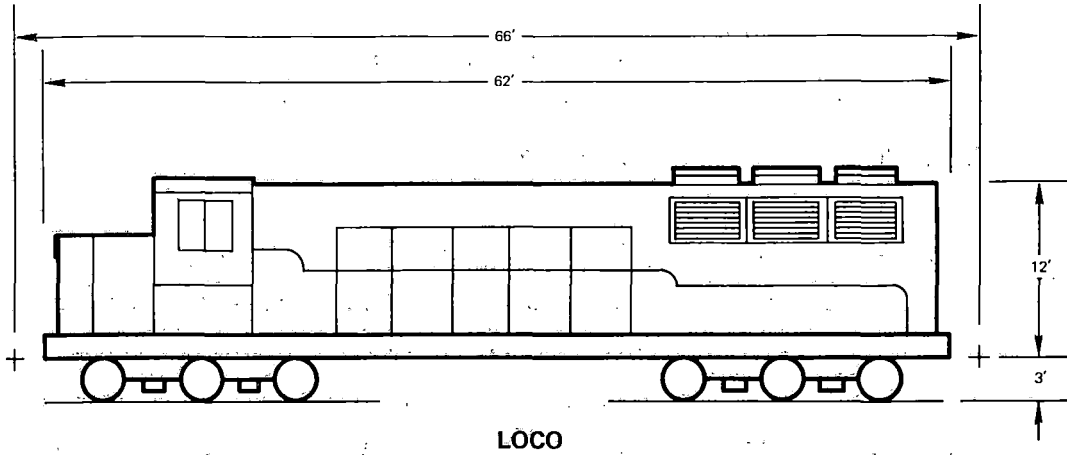

LOCO

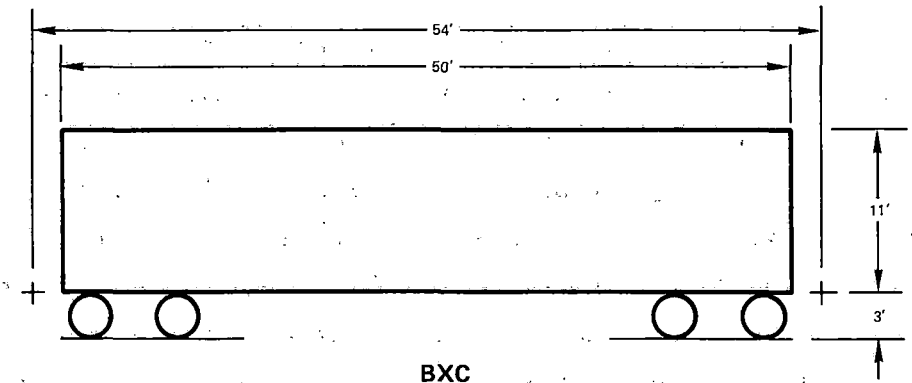

BXC

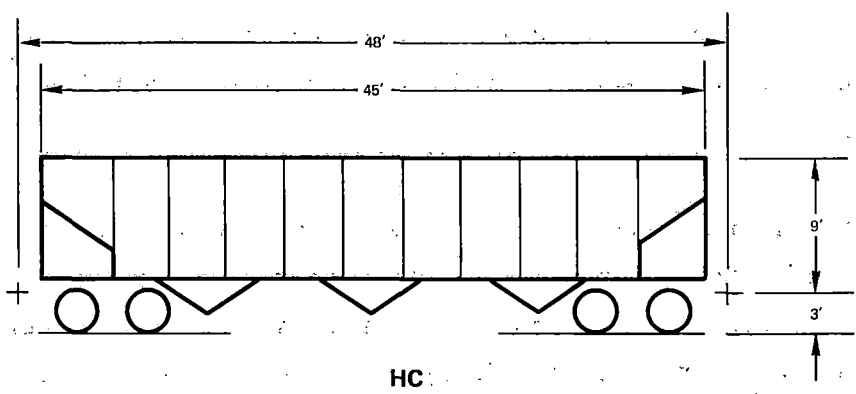

HC

**FIGURE A-1
LOCOMOTIVE, BOX CAR, HOPPER CAR**

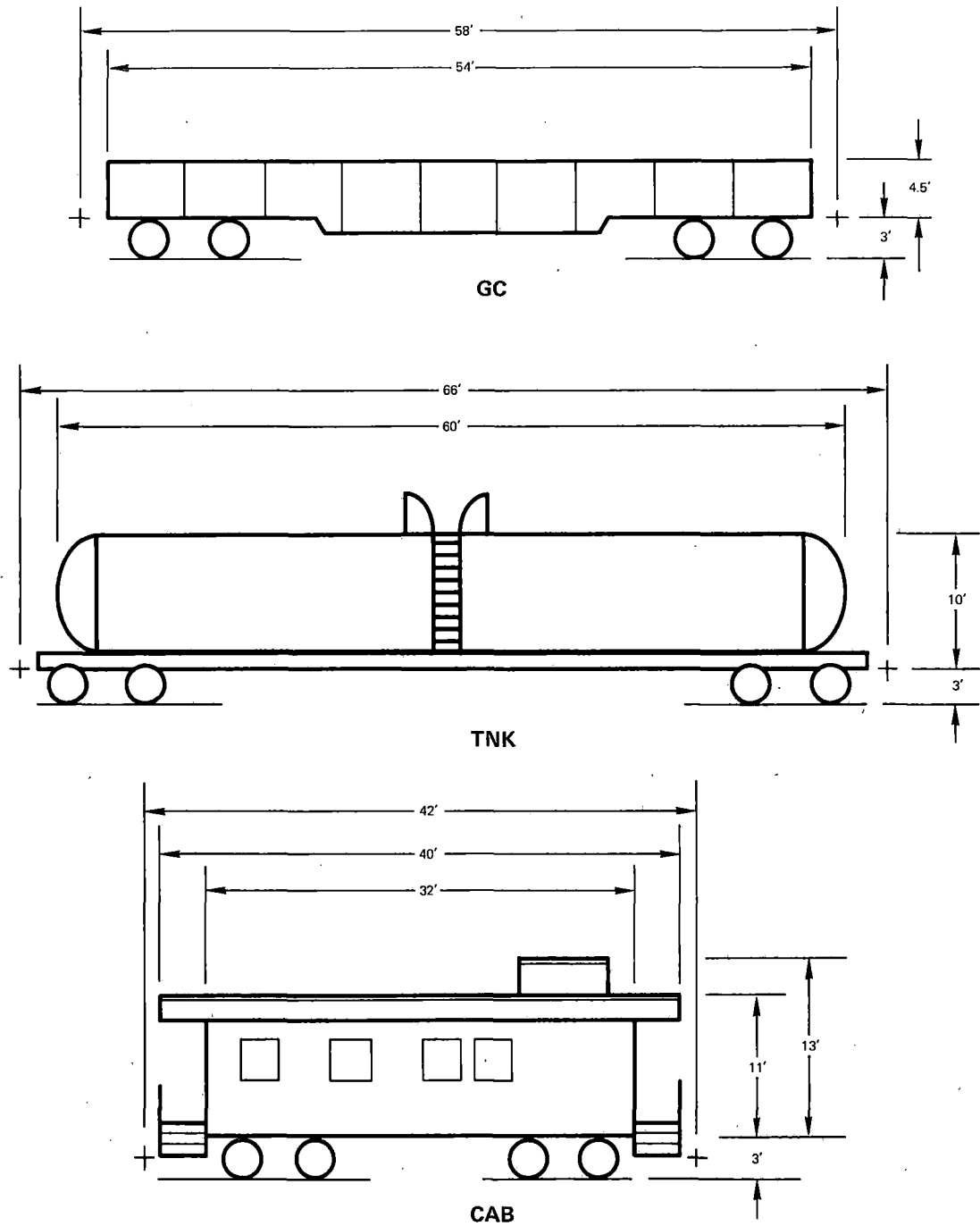

**FIGURE A-2
GONDOLA, TANK CAR, CABOOSE**

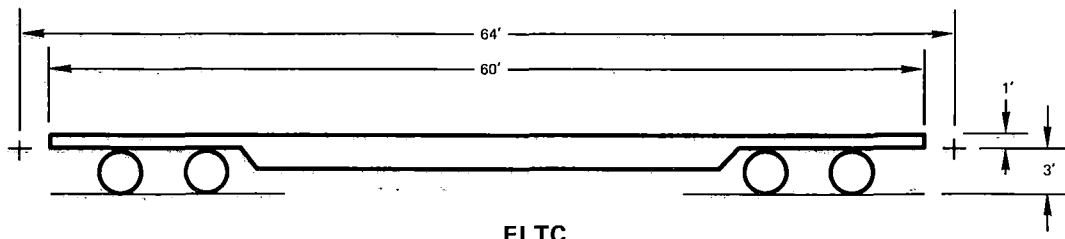

FLTC

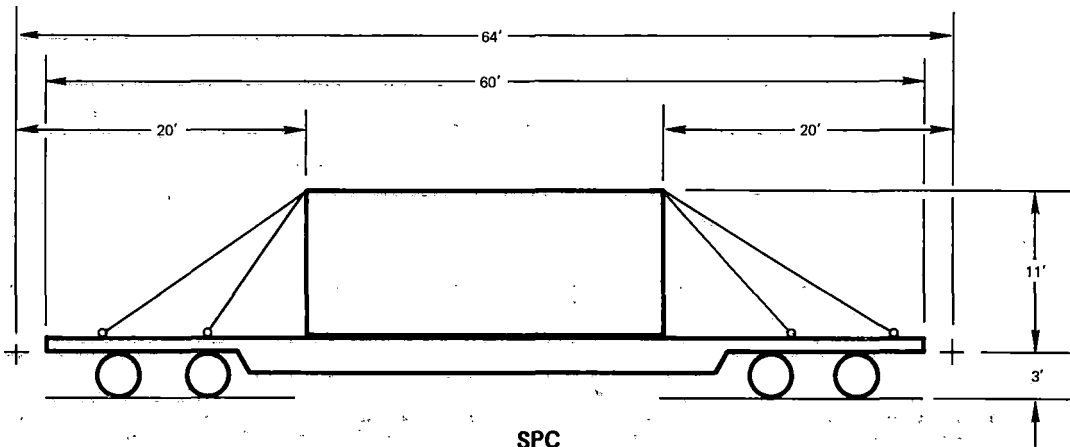

SPC

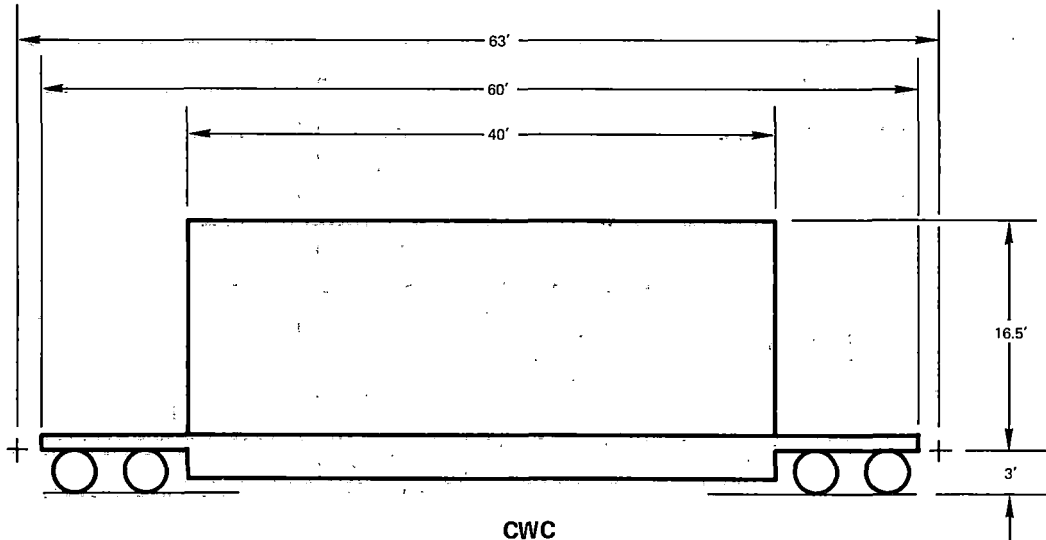

CWC

FIGURE A-3
FLAT CAR, FLAT CAR WITH SPECIAL FREIGHT,
CONTAINER WELL CAR

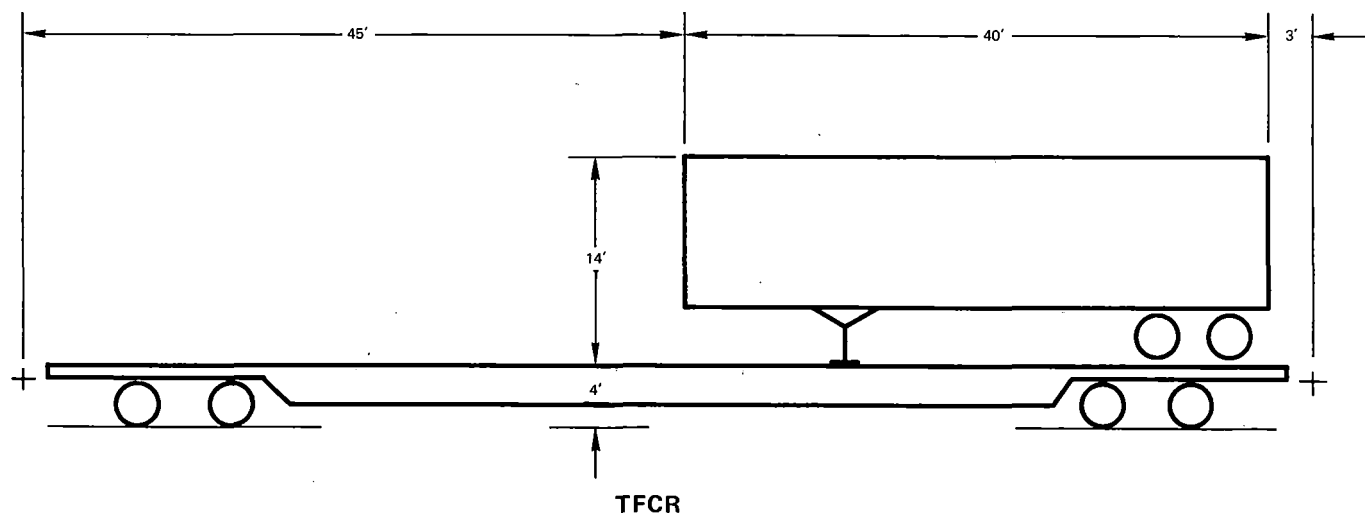
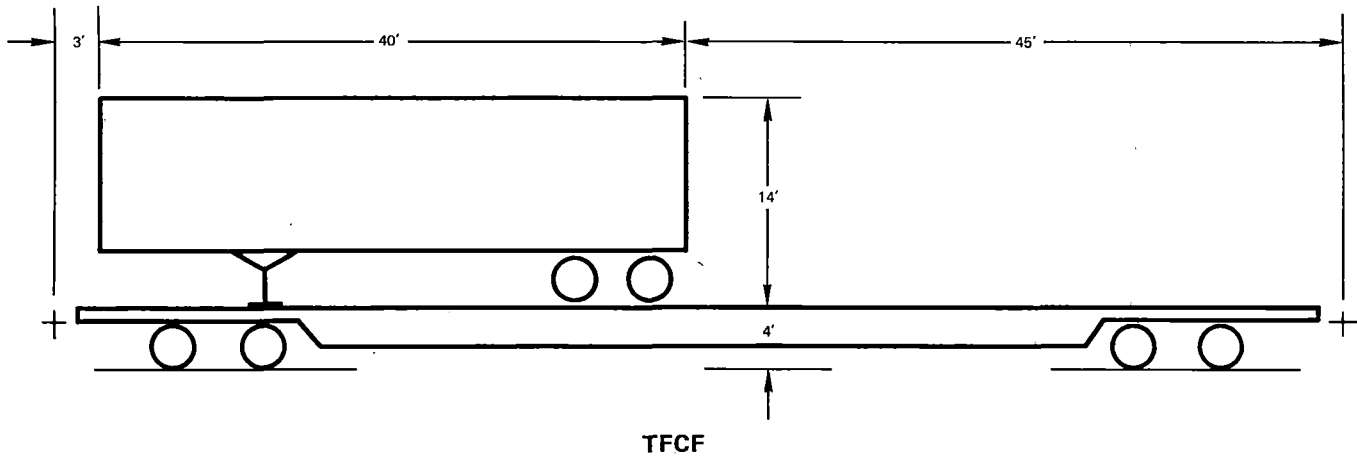

107

FIGURE A-4
TOFC WITH SINGLE TRAILERS, FRONT AND REAR

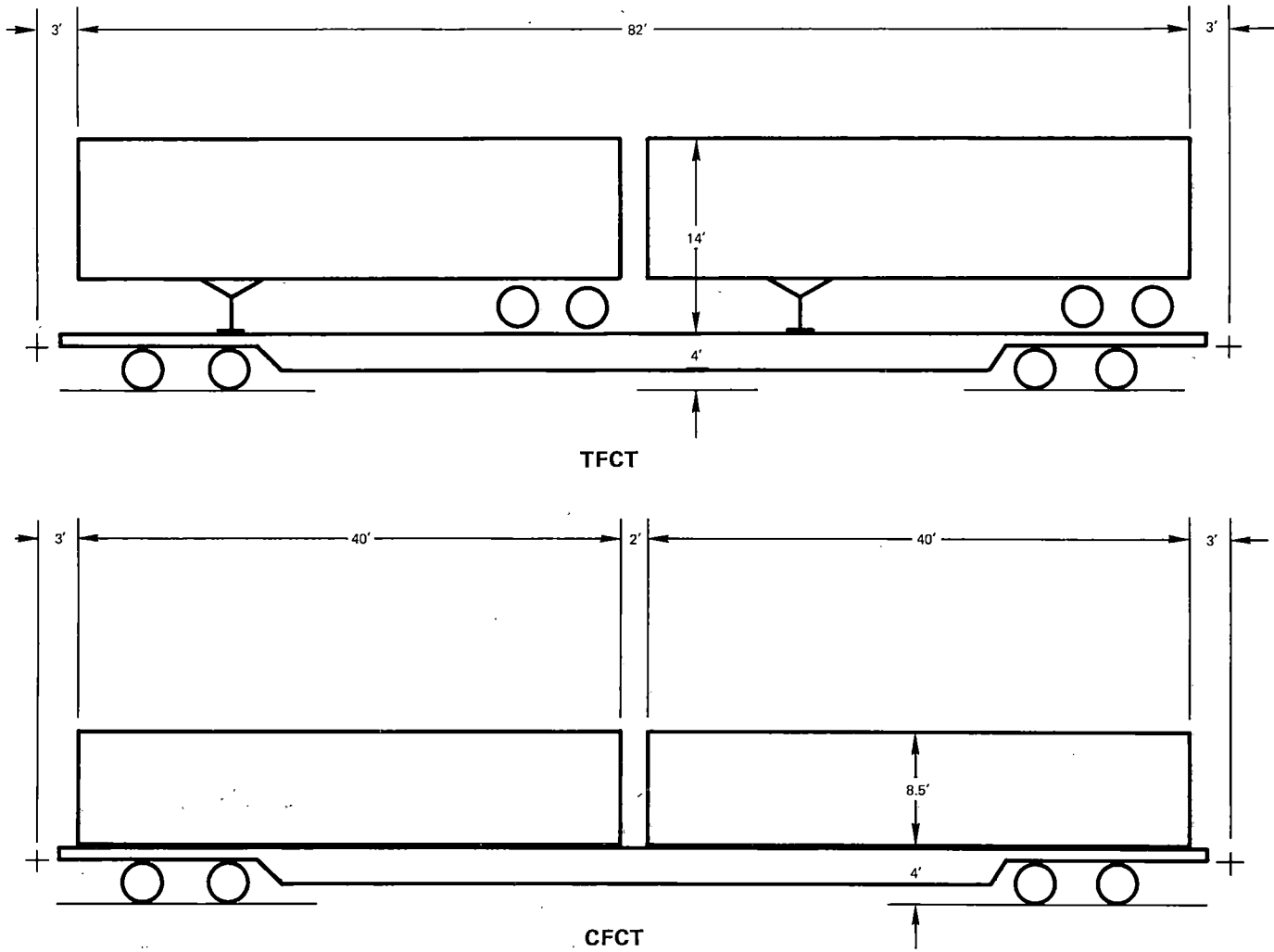

FIGURE A-5
TOFC AND COFC, WITH TWIN TRAILERS AND CONTAINERS

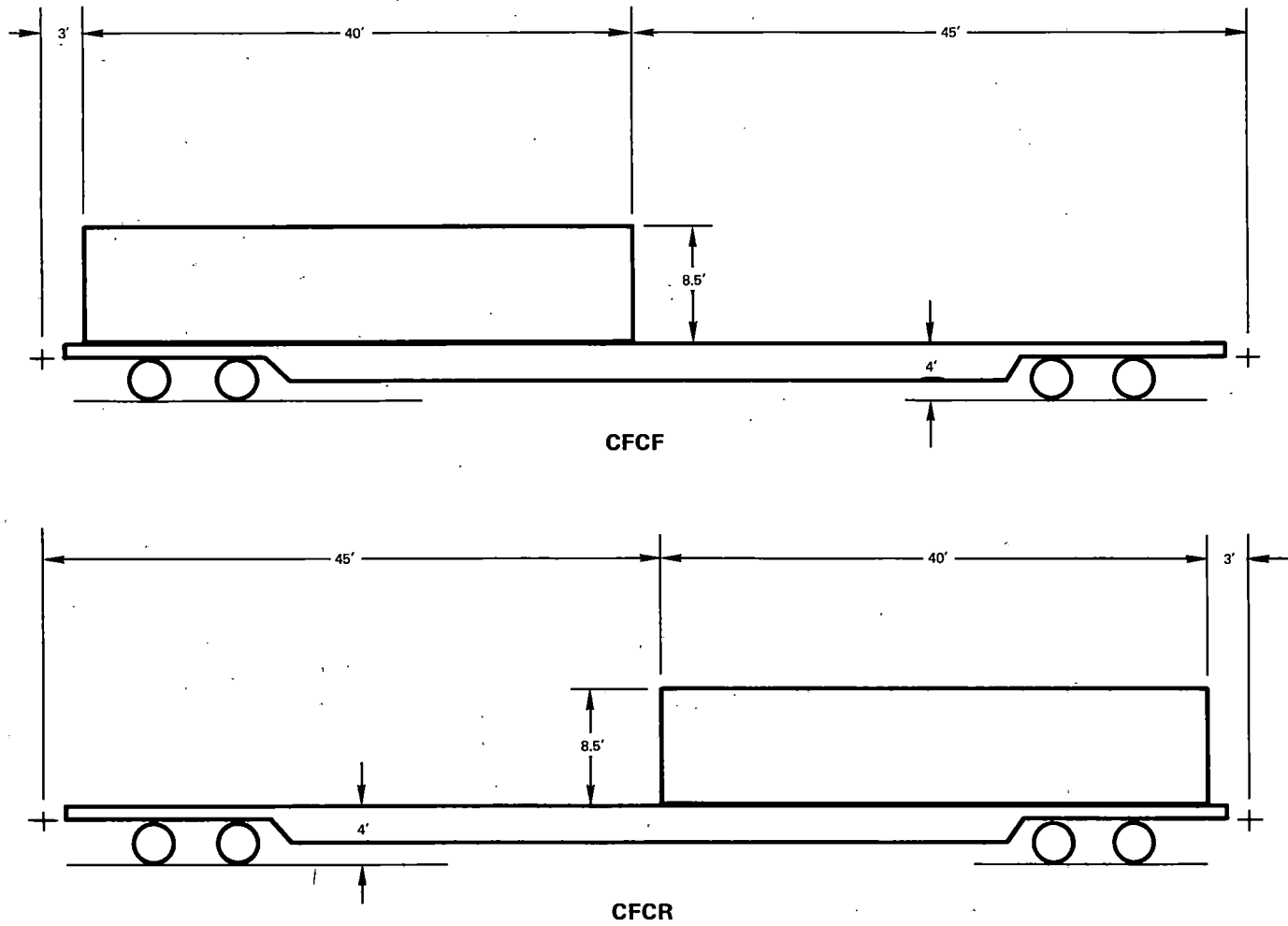
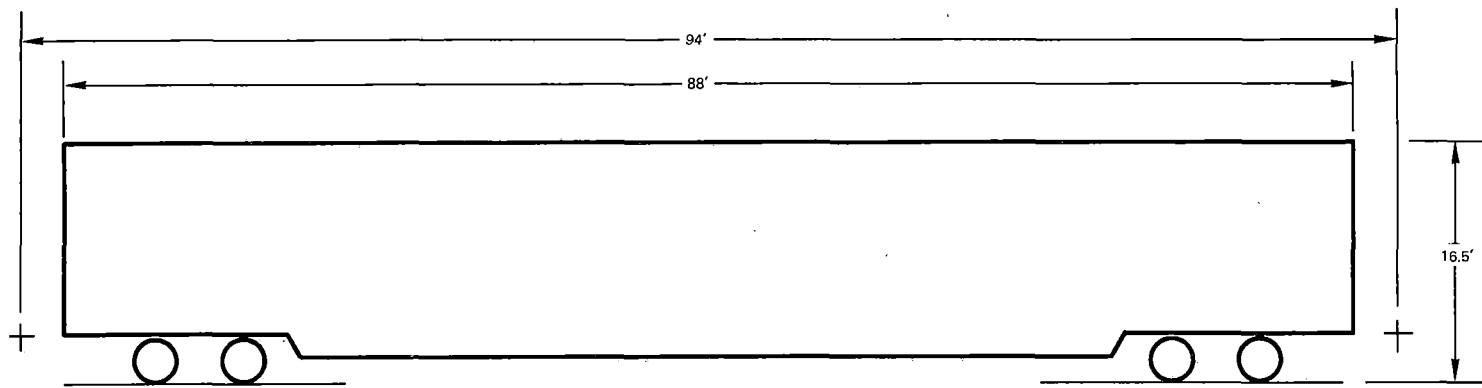
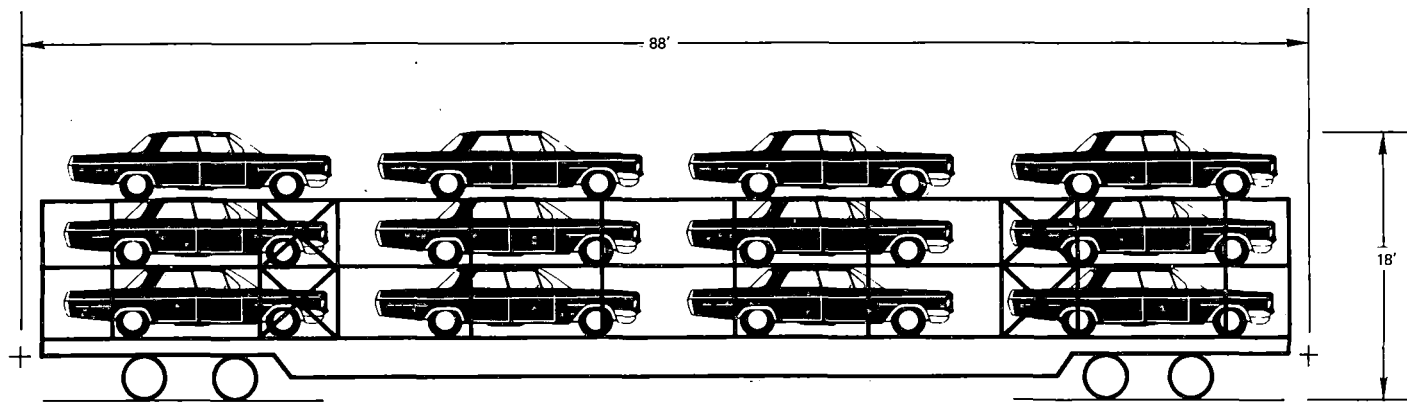

FIGURE A-6
COFC, WITH SINGLE CONTAINERS, FRONT AND REAR



STPK

110



ARCL

FIGURE A-7
STAK PAK OR HI-CUBE CAR, AUTO RACK CAR

comprises ordinary rolling stock and more unique items; however, it does not at this stage purport to be complete, nor completely accurate. The dimensions shown on the figures have been deliberately rounded off in order to illustrate the methodology more clearly, and in any case are only approximate, as the required information occasionally had to be scaled from a photograph. Significant dimensions were taken from the values shown on the figures and together with other pertinent information for use in the calculation were compiled into a table showing ten parameter values for each type of eighteen different pieces of rolling stock. These values, together with the symbol identifying the type of rolling stock, are shown in Table A-1; an explanation of the symbols, a description of the item, and the source for the data are shown in Table A-2. Most of the drag areas were taken from Hammitt [11] and appropriately adjusted, as noted in the following section, for use in this program. The information shown in the table forms a permanent portion of the computer program used to perform the calculation. However, as more information becomes available, the table can of course be expanded or modified.

The rationale behind the new methodology requires that the drag on each car be calculated separately. The availability of computer technology to make this calculation contributes a flexibility of approach which fortunately permits the separate calculations to be performed easily; probably the lack of this capability in the past inhibited investigators from considering such an approach. Nevertheless, the modified Davis formula has been used herein for the basic calculation of resistance. The modified Davis formula was selected because it reflects the resistance of more modern equipment than that used as the basis for the standard Davis formula.

TABLE A-1
DATA FOR ROLLING STOCK

TYPE	SYMBOL	AREA*, FRONT, FT ²	AREA*, REAR, FT ²	a, FT	b, FT	C _{DA} FRONT, FT ²	C _{DA} REAR, FT ²	C _f -	s FT	ℓ FT	EMPTY WEIGHT LBS
1	LOCO	120	120	3	2	50.4	50.4	.0085	34	62	250,000
2	BXC	110	110	2	2	46.1	46.1	.0085	32	50	60,700
3	HC	90	90	1.5	1.5	37.8	37.8	.0085	28	45	59,600
4	GG	45	45	2	2	18.9	18.9	.0085	19	54	68,900
5	FLTC	10	10	2	2	4.2	4.2	.0085	12	60	79,500
6	TFCF	122	10	3	45	23.7	23.7	.0085	25	85	76,200
7	TFCR	10	122	45	3	23.7	23.7	.0085	25	85	76,200
8	TFCT	122	122	3	3	23.7	23.7	.0085	38	85	76,200
9	CFCF	78	10	3	45	21.6	21.6	.0085	20	85	76,200
10	CFCR	10	78	45	3	21.6	21.6	.0085	20	85	76,200
11	CFCT	78	78	3	3	21.6	21.6	.0085	28	85	76,200
12	CWC	124	124	11.5	11.5	19.8	19.8	.0085	29	60	79,500
13	ARC	150	150	2	2	86.0	86.0	.018	40	85	76,200
14	SPC	110	110	20	20	46.1	46.1	.0085	22	60	79,500
15	STPK	135	135	3	3	56.6	56.6	.0085	37	88	119,200
16	TNK	74	74	3	3	31.0	31.0	.0085	30	60	77,600
17	CAB	110	130	5	5	46.2	54.4	.0085	32	40	56,600
18	TTX	10	10	2	2	4.2	4.2	.0085	12	85	76,200

* Front area as measured "a" feet back from front coupler, rear area as measured "b" feet forward of rear coupler.

TABLE A-2
EXPLANATION OF SYMBOLS

TYPE	SYMBOL	DESCRIPTION	FIGURE	REFERENCE ¹
1	LOCO	D-E LOCOMOTIVE	A1	Page 854
2	BXC	BOXCAR	A1	Page 101
3	HC	OPEN HOPPER CAR	A1	Page 183
4	GC	GONDOLA CAR	A2	Page 160
5	FLTC	FLAT CAR	A3	Page 275
6	TFCF	TOFC, SINGLE TRAILER, FRONT	A4	Composite
7	TFCR	TOFC, SINGLE TRAILER, REAR	A4	Composite
8	TFCT	TOFC, TWIN TRAILERS	A5	Composite
9	CFCF	COFC, SINGLE CONTAINER, FRONT	A6	Composite
10	CFCR	COFC, SINGLE CONTAINER, REAR	A6	Composite
11	CFCT	COFC, TWIN CONTAINERS	A5	Composite
12	CWC	CONTAINER WELL CAR	A3	Page 40 ²
13	ARC	AUTO RACK CAR	A7	Page 303 ³
14	SPC	FLAT CAR WITH SPECIAL FREIGHT	A3	Page 275
15	STPK	STACK-PAK CAR OR HI-CUBE CAR	A7	Page 115
16	TNK	TANK CAR	A2	Page 249
17	CAB	CABOOSE	A2	Page 206
18	TTX	FLAT CAR FOR INTERMODAL SERVICE	NOT ILLUSTRATED	Page 306

113

¹Page numbers refer to page in Car and Locomotive Cyclopeda, 1970 Ed., Ref. [33] unless otherwise noted.

²Ref. [11].

³Illustrated in [33], page noted. Basic data from [26].

The methodology also requires that train resistance be determined on an absolute basis (lbs. drawbar pull) for a given consist, rather than on a lbs. per ton basis. This is because it is inherent in the methodology that the resistance of the consist is dependent upon the arrangement of the cars in the consist, and hence the same train may have different resistances, depending upon the arrangement, although the weight of the consist remains unchanged.

This dependence upon arrangements is solely related to air drag; although it is conceivable that train resistance might be dependent upon placement of the loads in the consist, there are no known indications that that might be the case, and no consideration is given to such an idea in the calculation. Consequently, the calculation uses the first two terms of the modified Davis formula in a standard fashion, and it is only in the calculation of air drag that the calculation differs from a standard application of the resistance formula.

The rationale behind the calculation is that the air drag of a given car cannot be determined a priori, but rather it depends completely upon its placement in the consist; whether it is shielded or not from the undisturbed air stream, and to what extent, at both front and rear, determines the resulting drag. Such a rationale requires that in calculating the drag of a given car consideration be given to the preceding car and the following car. This idea is discussed at length in the following paragraphs.

2.0 RATIONALE BEHIND AIR DRAG CALCULATIONS

It has been hypothesized in the main text of this report, based upon the findings of many investigators, that air drag of a railroad car may be realistically broken into front and rear pressure effects and the skin friction. This writer has chosen to add another category to account for the drag of the trucks and friction on the underneath side of the vehicle. Thus in the calculation of air drag in this report, four separate calculations are made for each car and the results are added to find the air drag for that car. The air drag for the entire train is obtained by summing the air drags of the individual cars.

Following Hammitt's very plausible rationale [11], drag areas ($C_D A$) are used consistently throughout rather than simple drag coefficients, as they seem more appropriate to a freight car whose cross-sectional area is not always neatly defined. Wind tunnel or other experimental data have been used wherever available to generate the figures entered into the table of data (Table A-1), which forms a permanent portion of the computer program which calculates train resistance. But because such experimental air drag data encompass all four of the above effects, in using such data within the framework of the methodology above one must adjust the data appropriately. First, it is necessary to subtract out an appropriate amount to allow for skin friction and undercarriage drag, which are separately calculated. Second, the remainder must be appropriately divided between front and rear effects. Both of these have been done before entering drag areas into the table.

A discussion of the calculation of skin friction and undercarriage drag will be given later in this section. With regard to the division of the remainder of the drag area into front and rear effects, there is some justification for assuming that the rear pressure effect is larger than the front one [27], but since the evidence stemmed from experiments

on streamlined passenger trains it may not be applicable here. Hence in the calculations in this report, the portion of total drag attributable to front and rear pressure effects has been divided equally between front and rear as a first approximation. This means that the drag areas ($C_D A$) listed in the table of data (Table A-1) which forms a portion of the computer program are one-half the measured drag areas for the particular cars when they were fully exposed to the air stream, after an appropriate amount has been subtracted out to account for skin friction and undercarriage drag, as noted before.

The foregoing rationale and the hypothesis that the front and rear pressure effects on a given car depend upon both the proximity of the two significant end areas of the cars and their respective sizes form the basis for the development of the air drag calculation. The end areas of the cars which are held to be significant aerodynamically in these calculations and which will be referred to hereafter simply as the "end areas" will be defined as the dominant cross-sectional area of the car. In the case of an ordinary boxcar, this area is located in both the front and rear of the car only a few feet from the coupling point; in the case of a more singular car, such as a TOFC car assymmetrically loaded with a single trailer, the dominant area at one end of the car will be some thirty to forty feet distant from the coupling point. These distances from the coupling point are entered into the same table of data (Table A-1) for each type of car. What will be called the "coupling factor" is a function of these distances and is a measure of the effect of the physical gap between these areas upon the aerodynamics of the train.

The other effect which must be considered is the effect of differences in cross-sectional areas between adjacent cars. If the aft end of the leading car is larger than the fore end of the trailing car, the front

end of the trailing car will be completely shielded from the free air stream; however, the aft end of the leading car will be only partially shielded from the air stream by the smaller front end of the trailing car. To give consideration to such a case and to other cases, some of which were discussed in Section 7, what will be called the "area factor" will be a function of the significant end areas of the cars and is a measure of the extent of the shielding effect of one car upon another.

The air drag of the car caused by front or rear pressure effects will then be the classical $1/2 \rho V^2 C_D A$ modified by an appropriate combination of the two factors. The method of calculation of the respective factors, the rationale behind the "appropriate" combination, and the calculation of skin friction and undercarriage drag, as reflected in the computer program, are given below

2.1 Coupling Factor

Dimensions "a" and "b" are recorded for each type of car (see Table A-1). These are the dimensions from the coupling point to the front end area and the rear end area, respectively, as shown in Figure A-8(a) and A-8(b) for a symmetrical car and a hypothetical assymmetrical car. It is clear that the effective gap between vehicles is the sum of the dimension "a" from the trailing vehicle and the dimension "b" from the leading vehicle, as shown in Figure A-8(c). This gap will be used in the determination of the rear pressure effect on the leading car and the front pressure effect on the trailing car.

The coupling factor was set up to have a range of values between zero and one, reflecting its modification of the classical air drag. If the factor is zero, the cars are effectively so close that the pressure effects upon their respective areas are zero and the classical air drag should be multiplied by zero; if the factor is one, the cars

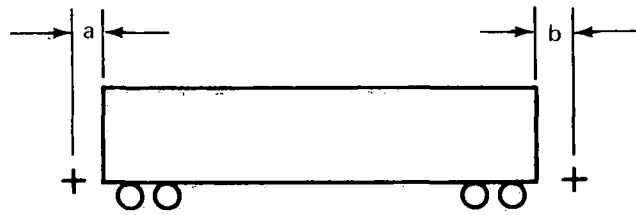

(a)

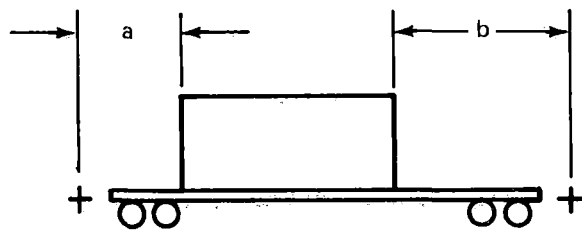

(b)

Note: All front ends of vehicles are to left

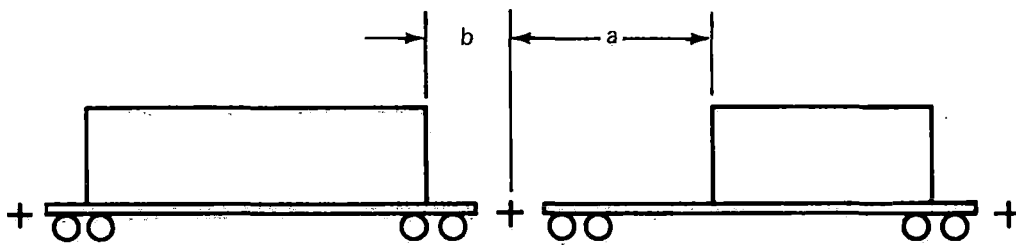

(c)

**FIGURE A-8
DERIVATION OF EFFECTIVE GAP SIZE**

are effectively so far apart that the classical air drag should be multiplied by unity. Other cases lie in between. It was arbitrarily decided that a gap of thirty feet or larger should be equivalent to an infinite gap aerodynamically, and an exponential curve was designed to make the transition to the thirty foot gap. The logic of the computer program is set up so that the coupling factor as a function of gap is as shown in Figure A-9. Note that for cars that are coupled reasonably closely, the pressure effect is small ($CF \approx 0$) but rises smoothly but rapidly to the full effect ($CF \approx 1.0$) as the gap approaches thirty feet. The particular curve is completely arbitrary but is believed to be realistic. The need exists to establish the validity of such a curve in wind tunnel tests if such a methodology is to be utilized.

2.2 Area Factor

The area factors are essentially the difference between the two end areas of adjacent cars normalized to the end area of the car in question; the program logic is set up so that it too ranges in value from zero to one; again, if the factor is zero, shielding is complete, there is no pressure effect, and the classical drag is multiplied by zero; similarly, if the factor is one, there is no shielding, and the classical drag is multiplied by unity, taking its full effect into consideration.

2.3 Combination of Factors

These factors cannot merely both multiply the classical drag values simultaneously, even though the effects must be considered simultaneously. It is necessary that if one effect is large enough, it mitigates the other effect and is itself dominant. For instance, it will be considered that if the areas are far enough apart, i.e., if the coupling factor equals one, their size does not matter and the effect of the area difference is eliminated. Similarly, if the areas are different enough, so that the area factor is one, the proximity does not matter and the effect

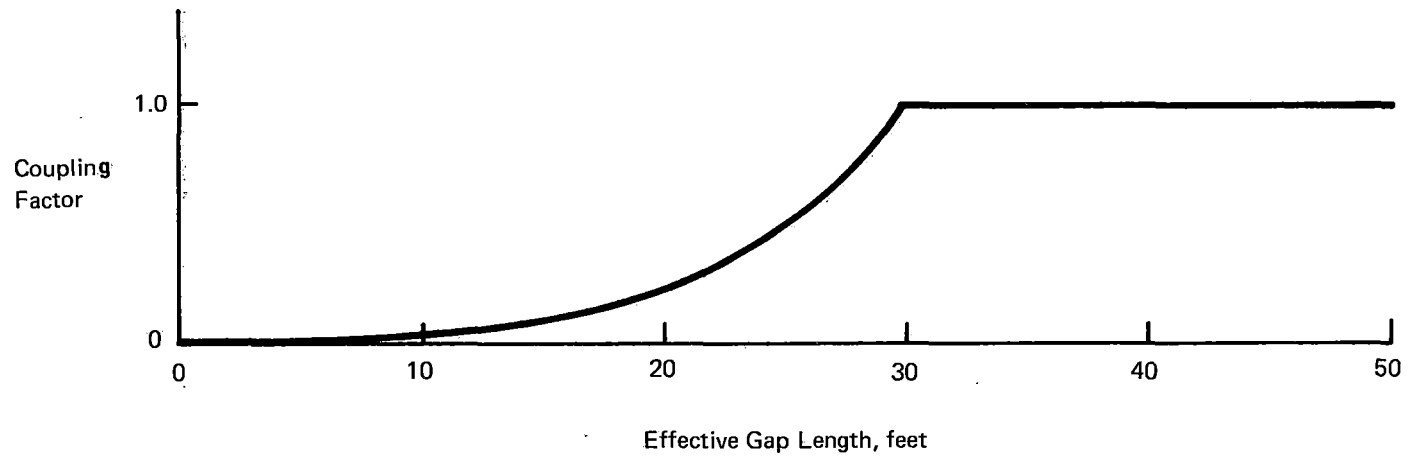

FIGURE A-9
COUPLING FACTOR AS A FUNCTION OF GAP LENGTH

of the gap is eliminated. The coupling factor and the area factor have been combined in such a fashion algebraically in the program (see lines 1660 and 1670) to yield FF for the front of the vehicle in question and FA for the rear of the vehicle. The equations are, in algebraic rather than FORTRAN notation:

$$F_f = 1 - (1 - CF_f) (1 - AF_f)$$

$$F_a = 1 - (1 - CF_a) (1 - AF_a)$$

where CF and AF refer to coupling factor and area factor respectively, and the subscripts f and a refer to fore and aft. The logic of this combination can be shown to mean that (a) only if both factors are zero will F be zero; (b) if either factor is zero, F becomes equal to the value of the other factor; and (c) if either factor is one, F becomes equal to one. Other cases lie between these values. The values of F for the possible combinations of factors with values of 0, 1/2, and 1 are shown in Table A-3 to illustrate this logic. This logic means that proximity must be perfect and areas must match equally in order that there be no pressure effect, that if the effect of either factor can be ignored only the effect of the other is considered, and finally that if either effect needs to be considered fully, the drag reverts to the classical aerodynamic drag.

It can be seen that simple multiplication of the two factors does not create the same logical impact.

Precedent to this straight algebraic combination, however, there are some practical constraints which modify this simple logic. The distance from the coupling point to the significant end area of any car is at least 1.5 ft. (hopper car), making the minimum gap between cars three feet. Thus there is always a slight gap effect, however small. However, this is not the case with regard to the area factor.

TABLE A-3
COEFFICIENT COMBINATION LOGIC

CF	AF	F
0	0	0
0	1/2	1/2
0	1	1
1/2	0	1/2
1/2	1/2	3/4
1/2	1	1
1	0	1
1	1/2	1
1	1	1

It is assumed, and is reflected in the logic of the program, that if one area is larger by any amount than the other area, the blockage or shielding is total, so that there may be instances when the area factor AF shows a value of zero, whereas the coupling factor CF as a practical matter will not assume this value. In addition, for the first vehicle of the train the front area factor is automatically one, and likewise the rear area factor of the last vehicle of the train.

The F factors are used to multiply the adjusted classical aerodynamic drag to obtain the front and rear pressure effect drag for the car in question. These drags are added to the skin friction and the undercarriage drag which are calculated as below, to determine the complete drag for the car.

2.4 Skin Friction

It was explained in Section 7.3 that a skin friction coefficient of .0085 had been used in the calculations in this report. The skin friction is then

$$\text{skin friction} = 1/2 \rho V^2 (.0085 S)$$

where S is the surface area to be considered. Here, since the drag of the underside of the vehicle is combined with the drag of the trucks and calculated separately, S represents the area of the two sides of the car plus the roof area. At this time the program merely multiplies the "length" of the vehicle (Column 9 of Table A-1) by the distance "s", normally the height of the two sides plus the width of the vehicle to obtain the equivalent exposed area. Unfortunately, certain types of vehicles do not lend themselves to such simplistic calculation of the exposed area; a TOFC flatcar with a single trailer is a good example of such a vehicle. In such instances, the exposed area has been manually calculated and divided by the length of the vehicle to obtain the dimension "s". The length "L" entered into the table is the actual distance between ends of the car, not between coupling points.

2.5 Undercarriage Drag

The undercarriage drag calculated by the program is only a coarse approximation of the actual drag contributed by the underside of the vehicle and the trucks. Only one figure for truck drag was found in the literature and that was for three-axle passenger car trucks [1]. The drag was ratioed, and based upon a corresponding cross-sectional area of 16 ft.² [1] an effective drag coefficient of .272 was calculated and used in the program. This gives a drag for each truck of 40 lbs. at 60 mph. Since the program calculates the drag for each car, twice the drag for a single truck is simply added to the calculation.

No information at all was found on the drag of the underneath side of the car. It is known from wind tunnel testing considerations that to a certain extent the air under the vehicle is carried along with the vehicle, and thus the surface area cannot be exposed to the velocity of the free air stream in the same fashion as the roof and

sides of the vehicle. Hence the drag based upon surface area must be less, but not zero. In the face of no better information than that, a first approximation of one-half the value of the skin-friction coefficient used for the roof and sides was made for the underside of the vehicle. As with the trucks, the friction on the underside is simply added to the other drags. Because the total drag for a vehicle is actually the summation of five separate calculations,⁵ the effect of even a large error in any one is mitigated if they are all relatively close in value. If the error occurs in one value considerably smaller than the others, there will be little effect at all. Thus it probably differs very little if the true effective skin friction coefficient for the bottom of the car is one-quarter, one-half, or three-quarters of that for the sides and roof; what is important is that some approximation be separately made for each effect.

2.6 Summary

A discussion of the rationale behind the calculation of the air drag of a railroad car in a train of cars has been presented. While the methodology is as yet unproven and certainly needs refinement, and while it is presently based upon limited information and necessary extrapolation from it, it is believed that the resulting calculation is more accurate than the simple use of either of the formulas in wide use today, which simply take a broad average of air drag characteristics of rolling stock.

⁵Front pressure effect, rear pressure effect, skin effect, underside drag, and truck drag.

3.0 COMPUTER PROGRAM

The computer program was devised to make the train resistance calculation in a convenient fashion. Stored in it are known data on various types of rolling stock, such as tare weights, dimensions, and other constants used in the calculation. The only inputs required are fundamental: the types of cars used in the consist, their order in the consist, and the net load carried by each car. The program has been arranged so that a "train file" may be prepared for a given train, and an "order file" may be prepared for a given order of cars; however, this was mostly for convenience in making the calculations required for this report, and these options could of course be easily modified.

A more detailed explanation of the methodology and the computer program is given below. Since both are closely related the explanation will be a mingling of both. The program itself is a FORTRAN program devised for the GE time-sharing system and utilizes line numbers. The present form of the program is shown in the listing of Figure A-10.

Lines 100-270

These lines merely list items required by the program itself, in particular the various arrays.

Lines 280-293

Here are listed the names of various files which later in the program the user is given the option of calling upon. The train files list, in order, the type of car and the net load for each car of the given consist. The order files list a particular order for a given number of cars. The latter were created solely for convenience in reordering a given train; if the desired order is known in advance, the train file can set the cars up in that order to begin with. In that case the order file is as with "ORDER2" (see Appendix B, where

several sample train and order files are given), simply 1,2,3,4... (n-2), (n-1), n, where n is the number of cars (including the locomotives and caboose).

An example will be useful. Consider a short train, characterized by the "TRAIN1" file. The first column merely lists line numbers. The second column lists numbers corresponding to car types. Tables A-1 and A-2 identify the car types used in the program and relate them to these numbers. For instance, the sequence of numbers in the second column, 1,16,2,5,17, identifies a locomotive, a tank car, a boxcar, a flatcar, and a caboose in that order. The third column of the train file lists the net load the car is carrying in tons.

If it were desired to determine the resistance of that consist in that order, order file "ORDER1" should be used. In that file the first column lists line numbers and the second the order of the cars from the train file. Once the trail file is established, if it is desired to reestablish the order as locomotive, flatcar, tank car, boxcar, caboose, order file "ORDER2" must be created. The second line of the file merely says that the fourth car of the specified train will be in second place now, the second car in third place, the third car in fourth place, and so on.

These files must be created and stored for the later use of the program. Format requirements are given following the corresponding "READ" statements. The number of cars in the order file should correspond to the number of cars in the train being examined.

Lines 300-330

These lines define Z, a dimensioned constant used in line 1340, and K_d , K_e , and K_f , which are used in lines 1720, 1730, 1750 and 1760 to convert coefficients computed elsewhere to proper units and values. K_d combines the mass density of air and a conversion from fps to mph. It has the numerical value .002548.

RR41 14:32EDT 10/25/77

```
100 DIMENSION W(100),A(100),B(100),C(8)
110 DIMENSION CAA(100),CBB(100),CC(100),DD(100),EE(100)
120 DIMENSION D(100),E(100),F(100),G(100),R(100,10)
130 DIMENSION V(100),RR(100),H(6)
140 DIMENSION COEFF (18,10)
150 DIMENSION ORDER(100)
160 DIMENSION GA(100),GF(100),CFF(100),CFA(100)
170 DIMENSION AFF(100),AFA(100),AA(100),BB(100,10),GG(100,10)
180 DIMENSION DENDM(100),FF(100),FA(100)
190 DIMENSION SUM2(100),SUM3(100)
200 DIMENSION NET(100),TARE(100),GROSS(100)
210 INTEGER ARRAY
220 DIMENSION ARRAY(100),DATA(100,2)
230 EQUIVALENCE (ARRAY,DATA)
240 INTEGER FILE,ORDER,P
250 INTEGER OPTION
260 REAL NET
270 REAL KD,KE,KF,MN
280 FILELIST "TRAIN1","TRAIN2","TRAIN3","TRAIN4","TRAIN5","TRAIN6",
290 & "TRAIN7","TRAIN8","TRAIN9","TRAIN10","ORDER1","ORDER2","ORDER3",
291 & "ORDER4","ORDER5","ORDER6","ORDER7","ORDER8","ORDER9","ORDER10",
292 & "TRAIN11","TRAIN12","TRAIN13","TRAIN14","TRAIN15","TRAIN16",
293 & "TRAIN17","TRAIN18","TRAIN19","TRAIN20"
300 Z = .16447
310 KD = .0763*88.0**2/(32.2*60.0**2*2.0)
320 KE = KD
330 KF = KD
340 V(1) = 0.0
350 V(2) = 10.0
360 V(3) = 20.0
370 V(4) = 30.0
380 V(5) = 40.0
390 V(6) = 50.0
400 V(7) = 60.0
410 V(8) = 70.0
420 V(9) = 80.0
430 DATA COEFF/120.0,110.0,90.0,45.0,10.0,122.0,10.0,122.0,78.0,
440 & 10.0,78.0,124.0,150.0,110.0,135.0,74.0,110.0,10.0,
450 & 120.0,110.0,90.0,45.0,10.0,10.0,122.0,122.0,10.0,
460 & 78.0,78.0,124.0,150.0,110.0,135.0,74.0,130.0,10.0,
470 & 3.0,2.0,1.5,2.0,2.0,3.0,45.0,3.0,3.0,
480 & 45.0,3.0,11.5,2.0,20.0,3.0,3.0,5.0,2.0,
490 & 2.0,2.0,1.5,2.0,2.0,45.0,3.0,3.0,45.0,
500 & 3.0,3.0,11.5,2.0,20.0,3.0,3.0,5.0,2.0,
510 & 50.4,46.1,37.8,18.9,4.2,23.7,23.7,23.7,21.6,
520 & 21.6,21.6,19.8,86.0,46.1,56.6,31.0,46.2,4.2,
530 & 50.4,46.1,37.8,18.9,4.2,23.7,23.7,23.7,21.6,
540 & 21.6,21.6,19.8,86.0,46.1,56.6,31.0,54.5,4.2,
550 & .0085,.0085,.0085,.0085,.0085,.0085,.0085,.0085,.0085,
560 & .0085,.0085,.0085,.018,.0085,.0085,.0085,.0085,.0085,
570 & 34.0,32.0,28.0,19.0,12.0,25.0,25.0,38.0,20.0,
580 & 20.0,28.0,29.0,40.0,22.0,37.0,30.0,32.0,12.0,
590 & 62.0,50.0,45.0,54.0,60.0,85.0,85.0,85.0,85.0,
```

FIGURE A-10
PROGRAM LISTING

```

600 & 85.0,85.0,60.0,85.0,60.0,88.0,60.0,40.0,85.0,
610 & 250000.0,60700.0,59600.0,68900.0,79500.0,
620 & 76200.0,76200.0,76200.0,76200.0,76200.0,
630 & 76200.0,76200.0,51500.0,76200.0,79500.0,
640 & 119200.0,77600.0,56600.0,76200.0/
650 PRINT," INPUT,NCAR"
660 INPUT,NCAR
670 PRINT," INPUT,TRAIN DATA FILE NO."
680 INPUT,FILE
690 READ (FILE,51) ((DATA(N,L),L=1,2),N=1,NCAR)
700 51 FORMAT (4X,I3,F6.1)
710 PRINT," INPUT, CAR ORDER FILE NO."
715 INPUT,FILE
720 READ (FILE,52) (ORDER(N),N=1,NCAR)
725 52 FORMAT (5X,I3)
730 PRINT," DATA PRINT OPTION, TYPE 1 FOR YES,0 FOR NO"
740 INPUT,OPTION
750 PRINT," DATA PRINT OPTION2, TYPE 1 FOR YES,0 FOR NO"
760 INPUT,OPTION2
770 IF (OPTION.EQ.0) GO TO 312
780 PRINT 51, ((DATA(N,L),L=1,2),N=1,NCAR)
790 PRINT 41
800 312 CONTINUE
810 SUM4 = 0.0
820 DO 307 P = 1,NCAR
830 307 SUM4 = SUM4+DATA(P,2)
840 PRINT 308,SUM4
850 308 FORMAT (" NET TRAIN WEIGHT, TONS:", F10.2)
860 PRINT 41
870 DO 311 K = 1,NCAR
880 311 GROSS(K) = DATA(ORDER(K),2)+COEFF (ARRAY (ORDER(K)),10)/2000.0
890 SUM5 = 0.0
900 DO 309 K = 1,NCAR
910 309 SUM5 = SUM5+GROSS(K)
920 PRINT 310,SUM5
930 310 FORMAT (" GROSS TRAIN WEIGHT,TONS:",F10.2)
940 PRINT 41
950 DO 20 I = 1,NCAR
960 DO 25 K = 1,NCAR
970 IF (I.GT.1) GO TO 42
980 NET(K) = DATA(ORDER(K),2)
990 TARE(K) = COEFF (ARRAY (ORDER(K)),10)
1000 A(K) = (NET(K)+TARE(K)/2000.0)*.6+80.0
1010 B(K) = .01*(NET(K)+TARE(K)/2000.0)
1020 IF (K.EQ.1) GO TO 37
1030 GF(K) = COEFF (ARRAY (ORDER(K)),3)+COEFF (ARRAY (ORDER(K-1)),4)
1040 GO TO 38
1050 37 GF(K) = 30.1
1060 38 IF (K.EQ.NCAR) GO TO 39
1070 GA(K) = COEFF (ARRAY (ORDER(K)),4)+COEFF (ARRAY (ORDER(K+1)),3)
1080 GO TO 24
1090 39 GA(K) = 30.1
1100 24 IF (OPTION.EQ.0) GO TO 25
1110 PRINT 26,K,A(K),B(K),GF(K),GA(K)
1120 26 FORMAT ( 1H ,2X,I2,4(F12.2))

```

FIGURE A-10 (CONTINUED)

```

1130 25 CONTINUE
1140 PRINT 41
1150 SUM1 = 0.0
1160 DO 97 M = 1,NCAR
1170 97 SUM1 = SUM1+A(M)
1180 IF (OPTION.EQ.0) GO TO 405
1190 PRINT 98,M,SUM1
1200 98 FORMAT ( 1H ,2X,I2,F12.2)
1210 405 CONTINUE
1220 IF (I.GT.1) GO TO 42
1230 PRINT 41
1240 IF (OPTION.EQ.0) GO TO 401
1250 PRINT 171
1260 171 FORMAT ("      I          CFF          AFF          CFA          AFA")
1270 PRINT 41
1280 401 CONTINUE
1290 41 FORMAT (/)
1300 42 CONTINUE
1310 IF (I.GT.1) GO TO 60
1320 IF (I.EQ.1) GO TO 70
1330 60 IF (GF(I).GT.30.0) GO TO 70
1340 CFF(I) = EXP(Z*(GF(I)-30.0))
1350 GO TO 75
1360 70 CFF(I) = 1.0
1370 75 IF (I.LT.NCAR) GO TO 80
1380 IF (I.EQ.NCAR) GO TO 90
1390 80 IF (GA(I).GT.30.0) GO TO 90
1400 CFA(I) = EXP(Z*(GA(I)-30.0))
1410 GO TO 100
1420 90 CFA(I) = 1.0
1430 GO TO 100
1440 100 IF (I.EQ.1) GO TO 110
1450 CAA(I) = COEFF(ARRAY(ORDER(I)),1)
1460 CBB(I) = COEFF(ARRAY(ORDER(I-1)),2)
1470 IF (CAA(I)-CBB(I)) 201,202,202
1480 201 AFF(I) = 0.0
1490 GO TO 120
1500 202 AFF(I) = (CAA(I)-CBB(I))/CAA(I)
1510 GO TO 120
1520 110 AFF(I) = 1.0
1530 120 IF (I.EQ.NCAR) GO TO 140
1540 CC(I) = COEFF(ARRAY(ORDER(I)),2)
1550 DD(I) = COEFF(ARRAY(ORDER(I+1)),1)
1560 IF (CC(I)-DD(I)) 203,204,204
1570 203 AFA(I) = 0.0
1580 GO TO 149
1590 204 AFA(I) = (CC(I)-DD(I))/CC(I)
1600 GO TO 149
1610 140 AFA(I) = 1.0
1620 149 IF (OPTION.EQ.0) GO TO 402
1630 150 PRINT 67,I,CFF(I),AFF(I),CFA(I),AFA(I)
1640 67 FORMAT ( 1H ,2X,I2,4(F12.3))
1650 402 CONTINUE
1660 FF(I) = 1.0-(1.0-CFF(I))**(1.0-AFF(I))
1670 FA(I) = 1.0-(1.0-CFA(I))**(1.0-AFA(I))

```

FIGURE A-10 (CONTINUED)

```

1680 IF (OPTION.EQ.0) GO TO 403
1690 PRINT 170,I,FF(I),FA(I)
1700 170 FORMAT ( 1H ,2X,I2,F12.3,F24.3)
1710 403 CONTINUE
1720 D(I) = KI*COEFF (ARRAY (ORDER (I)),5)*FF (I)
1730 E(I) = KE*COEFF (ARRAY (ORDER (I)),7)*COEFF (ARRAY (ORDER (I)),8)*
1740 * COEFF (ARRAY (ORDER (I)),9)
1750 F(I) = KF*COEFF (ARRAY (ORDER (I)),6)*FA (I)
1760 EE (I) = 2.0*.272*16.0*KI+.003*KI*COEFF (ARRAY (ORDER (I)),9)*10.0
1770 G(I) = D(I)+E(I)+F(I)+EE (I)
1780 IF (OPTION.EQ.0) GO TO 20
1790 PRINT 76,I,D(I),E(I),F(I),EE (I),G(I)
1800 76 FORMAT ( 1H ,2X,I2,5(F12.3))
1810 PRINT 41
1820 20 CONTINUE
1830 DO 127 J = 1,9
1840 DO 117 I = 1,NCAR
1850 R(I,J) = A(I)+B(I)*V(J)+G(I)*V(J)**2
1860 BB(I,J) = B(I)*V(J)
1870 GG(I,J) = G(I)*V(J)**2
1880 IF (OPTION.EQ.0) GO TO 117
1890 PRINT 87,I,J,V(J),A(I),BB(I,J),GG(I,J),R(I,J)
1900 87 FORMAT ( 1H ,2X,I2,2X,I2,3X,F5.1,4(F13.2))
1910 117 CONTINUE
1920 127 CONTINUE
1930 PRINT 41
1940 IF (OPTION2.EQ.0) GO TO 453
1950 DO 451 I = 1,NCAR
1960 451 PRINT 452,I,G(I)
1970 452 FORMAT (1H ,4X,I2,F12.3)
1980 453 CONTINUE
1990 DO 152 J = 1,9
2000 SUM2(J) = 0.0
2010 DO 153 I = 1,NCAR
2020 153 SUM2(J) = SUM2(J)+BB(I,J)
2030 SUM3(J) = 0.0
2040 DO 154 I = 1,NCAR
2050 154 SUM3(J) = SUM3(J)+GG(I,J)
2060 152 CONTINUE
2070 PRINT 41
2080 RR(J) = 0.0
2090 DO 137 J = 1,9
2100 DO 30 I = 1,NCAR
2110 30 RR(J) = RR(J) + R(I,J)
2120 PRINT 50,J,V(J),SUM1,SUM2(J),SUM3(J),RR(J)
2130 137 CONTINUE
2140 50 FORMAT ( 1H ,4X,I2,3X,F5.1,4(F13.2))
2150 STOP
2160 END

```

FIGURE A-10 (CONCLUDED)

Lines 340-420

These lines merely list the velocities in mph at which the calculations will be made.

Lines 430-640

These lines list the data in Table A-1 in the appropriate format. Various parameters for each type of car are listed herein. The parameters and their use in the calculation of train resistance are explained in the main text of the report.

Lines 650-725

The program is established in an interactive basis. These lines permit the entry at this point in the program of the number of cars in the train (including locomotive and caboose), the train data file to be used, and the order file to be used.

Lines 730-800

These lines were established to permit the user to avoid printing out all the data computed. Typing of ones in response to both queries will result in a complete print out; typing of zeros will result in only the final data being printed. See examples 1 and 2 respectively.

Lines 800-940

In these lines the net weight and gross weights of the train are calculated by extraction of appropriate data from the train file and the data storage file in lines 430-640.

Lines 950-1130

These are an inner "DO" loop which calculates the mechanical and velocity-dependent terms of the resistance equation plus the gap coefficients GF and GA, for the fore and aft coupling factors.

Lines 1140-1210

These lines calculate the sum of the mechanical resistances for the train; neither these resistances nor their sum are a function of velocity.

Lines 1220-1300

These lines merely prescribe certain options and formats.

Lines 1310-1430

These lines calculate the fore and aft coupling factors CFF and CFA from the gap coefficients GF and GA, according to the functional relationship shown in Figure A-9. The section of the curve between 0 and 30 ft. is presently described by the function in lines 1340 and 1400.

Lines 1440-1650

These lines extract cross sectional area information from the data bank in the program and calculate from it the fore and aft area factors AFF and AFA.

Lines 1660-1710

These lines calculate the fore and aft pressure effect factors by appropriately combining the coupling factors and the area factors. The rationale behind the appropriateness of the combination is given in Section 2 of this appendix. These factors are used to multiply directly the adjusted classical air drag term $1/2 \rho V^2 AC_D$.

Lines 1720-1820

These lines compute the front and rear pressure effect coefficients D(F) and F(I) respectively, the skin friction effects coefficient E(I), and the drag from the underside of the vehicle combined with the truck drag EE(I), and sums them to yield a combined coefficient which is subsequently used to multiply V^2 directly. The dimensions of the D, E,

EE, and F terms have been adjusted by the K_d , K_e , and K_f coefficients so that this may be done in a meaningful fashion. The magnitude of the G coefficients is therefore on the order of, and analogous directly to, the .07 coefficient used in the modified Davis equation.

Lines 1830-1930

These lines calculate, and print if requested, the mechanical, velocity-dependent, and air resistances, plus the total resistance, for each car at each velocity. For a long train this amounts to many items of data and it is best to avoid printing this unless required for verification or checking purposes.

Lines 1940-1980

These lines print, if requested, the "G" coefficient for each car. This enables one to compare the computed air drag coefficient for a given car with the .07 coefficient which is used in the modified Davis formula for every car.

Lines 1990-2160

These lines compute and print out the information which is most nearly fundamental: the mechanical, velocity-dependent, and air resistances, plus the total resistance, of the train, at each of the velocities prescribed.



APPENDIX B

EXAMPLES OF PROGRAM INPUT FILES, DATA, AND OUTPUT FORMATS

This appendix illustrates several "TRAIN" and "ORDER" files which might be used or have been used in connection with the computer program by means of which the results reported in this document were calculated.

In Figure B-1, three sample files for a five-car train are illustrated. The "TRAIN1" file is for a train consisting of a locomotive, a tank car, a boxcar, a flatcar, and a caboose, in that order. The net weight carried by the three middle cars is 61.0 tons each. The format is (4X, I3, F6.1). The two "ORDER" files illustrate the means by which the train is rearranged. The "ORDER1" file is used to input the train in its original order, i.e., as shown in the "TRAIN1" file. The "ORDER2" file is used when a particular different order of cars is selected.

Figures B-2 through B-5 show "TRAIN" and "ORDER" files for two 70-car trains used in the report and two possible arrangements of these trains: the as-originated order, and a random rearrangement. Final Figures B-6 and B-7 show samples of the program data output, with minimum data printed and with complete data, respectively.

The minimum data output option prints only the net and gross train weights and the mechanical, velocity-dependent, and air resistances, plus the total resistance, in their respective columns, for the train at each velocity.

The complete data printout is very long, even for only a five car train. The program was set up for this option to print out all intermediate data, and in particular, all coefficients used in the determination

TRAIN1 08:38EST 11/01/77

100	1	0.0
110	16	61.0
120	2	61.0
130	5	61.0
140	17	0.0

ORDER1 08:38EST 11/01/77

100	1
110	2
120	3
130	4
140	5

ORDER2 08:39EST 11/01/77

100	1
110	4
120	2
130	3
140	5

FIGURE B-1
SAMPLE "TRAIN" AND "ORDER" FILES

ORDER3		08:48EST	11/01/77
101	1	136	36
102	2	137	37
103	3	138	38
104	4	139	39
105	5	140	40
106	6	141	41
107	7	142	42
108	8	143	43
109	9	144	44
110	10	145	45
111	11	146	46
112	12	147	47
113	13	148	48
114	14	149	49
115	15	150	50
116	16	151	51
117	17	152	52
118	18	153	53
119	19	154	54
120	20	155	55
121	21	156	56
122	22	157	57
123	23	158	58
124	24	159	59
125	25	160	60
126	26	161	61
127	27	162	62
128	28	163	63
129	29	164	64
130	30	165	65
131	31	166	66
132	32	167	67
133	33	168	68
134	34	169	69
135	35	170	70

FIGURE B-2
NORMAL "ORDER" FILE FOR 70 CAR TRAIN

ORDERS		08:50EST	11/01/77
101	1	136	47
102	2	137	19
103	65	138	57
104	45	139	56
105	34	140	46
106	66	141	43
107	18	142	55
108	29	143	41
109	27	144	33
110	49	145	69
111	20	146	8
112	21	147	13
113	17	148	54
114	31	149	6
115	11	150	5
116	42	151	62
117	38	152	15
118	10	153	23
119	12	154	24
120	48	155	44
121	53	156	28
122	35	157	60
123	16	158	67
124	61	159	32
125	9	160	30
126	3	161	64
127	40	162	37
128	25	163	4
129	58	164	7
130	26	165	39
131	22	166	68
132	59	167	14
133	52	168	50
134	51	169	63
135	36	170	70

**FIGURE B-3
RANDOM "ORDER" FILE FOR 70 CAR TRAIN**

TRAINS			08:44EST	11/01/77		
101	1	0.0		136	2	0.0
102	1	0.0		137	3	61.0
103	5	0.0		138	2	0.0
104	14	61.0		139	2	61.0
105	3	61.0		140	2	61.0
106	3	0.0		141	2	61.0
107	3	61.0		142	14	61.0
108	3	0.0		143	2	0.0
109	16	0.0		144	2	0.0
110	3	0.0		145	5	0.0
111	4	61.0		146	14	61.0
112	16	0.0		147	3	61.0
113	3	61.0		148	3	0.0
114	2	0.0		149	3	0.0
115	3	0.0		150	3	0.0
116	2	0.0		151	3	61.0
117	2	61.0		152	3	61.0
118	2	61.0		153	3	0.0
119	2	0.0		154	16	61.0
120	3	61.0		155	2	61.0
121	4	0.0		156	2	61.0
122	4	61.0		157	2	61.0
123	3	61.0		158	3	0.0
124	2	0.0		159	2	0.0
125	3	0.0		160	3	0.0
126	2	61.0		161	2	61.0
127	16	61.0		162	4	0.0
128	4	0.0		163	3	61.0
129	4	61.0		164	16	0.0
130	2	0.0		165	16	61.0
131	3	61.0		166	4	0.0
132	5	0.0		167	3	61.0
133	16	0.0		168	2	0.0
134	3	0.0		169	2	61.0
135	2	0.0		170	17	0.0

FIGURE B-4
 "TRAIN" FILE FOR "AVERAGE" TRAIN

TRAIN11 08:42EST 11/01/77

101	1	0.0	136	8	61.0
102	1	0.0	137	8	61.0
103	6	30.5	138	8	61.0
104	6	30.5	139	7	30.5
105	8	61.0	140	8	61.0
106	8	61.0	141	8	61.0
107	6	30.5	142	8	61.0
108	8	61.0	143	8	61.0
109	6	30.5	144	8	61.0
110	6	30.5	145	8	61.0
111	8	61.0	146	8	61.0
112	7	30.5	147	8	61.0
113	7	30.5	148	6	30.5
114	8	61.0	149	7	30.5
115	6	30.5	150	8	61.0
116	8	61.0	151	7	30.5
117	8	61.0	152	7	30.5
118	7	30.5	153	8	61.0
119	7	30.5	154	7	30.5
120	8	61.0	155	8	61.0
121	7	30.5	156	8	61.0
122	7	30.5	157	7	30.5
123	6	30.5	158	8	61.0
124	8	61.0	159	6	30.5
125	8	61.0	160	8	61.0
126	7	30.5	161	7	30.5
127	6	30.5	162	6	30.5
128	6	30.5	163	6	30.5
129	7	30.5	164	8	61.0
130	6	30.5	165	7	30.5
131	8	61.0	166	6	30.5
132	8	61.0	167	8	61.0
133	8	61.0	168	6	30.5
134	8	61.0	169	7	30.5
135	6	30.5	170	17	0.0

FIGURE B-5
"TRAIN" FILE FOR MIXED TOFC CONSIST

```

INPUT, NCAR?5
INPUT, TRAIN DATA FILE NO.?1
INPUT, CAR ORDER FILE NO.?11
DATA PRINT OPTION, TYPE 1 FOR YES, 0 FOR NO?0
DATA PRINT OPTION2, TYPE 1 FOR YES, 0 FOR NO?0

NET TRAIN WEIGHT, TONS:    183.00
GROSS TRAIN WEIGHT, TONS:  445.20

```

1	0.	667.12	0.	0.	667.12
2	10.0	667.12	44.52	86.92	798.56
3	20.0	667.12	89.04	347.68	1103.84
4	30.0	667.12	133.56	782.29	1582.97
5	40.0	667.12	178.08	1390.74	2235.94
6	50.0	667.12	222.60	2173.03	3062.75
7	60.0	667.12	267.12	3129.16	4063.40
8	70.0	667.12	311.64	4259.14	5237.90
9	80.0	667.12	356.16	5562.95	6586.23

```
PROGRAM STOP AT 2150
```

FIGURE B-6
SAMPLE DATA OUTPUT, MINIMUM

INPUT, NCAR?5

INPUT, TRAIN DATA FILE NO.?1

INPUT, CAP ORDER FILE NO.?11

DATA PRINT OPTION, TYPE 1 FOR YES, 0 FOR NO?1

DATA PRINT OPTION2, TYPE 1 FOR YES, 0 FOR NO?1

1 0.
16 61.0
2 61.0
5 61.0
17 0.

NET TRAIN WEIGHT, TONS: 183.00

GROSS TRAIN WEIGHT, TONS: 445.20

1	155.00	1.25	30.10	5.00
2	139.88	1.00	5.00	5.00
3	134.81	0.91	5.00	4.00
4	140.45	1.01	4.00	7.00
5	96.98	0.28	7.00	30.10

5 667.12

	CFF	AFB	CFA	AFB	
1	1.000	1.000	0.016	0.393	
1	1.000		0.393		
1	0.128	0.046	0.051	0.027	0.252
2	0.016	0.	0.016	0.	
2	0.016		0.016		
2	0.001	0.039	0.001	0.027	0.068
3	0.016	0.327	0.014	0.909	
3	0.338		0.910		
3	0.040	0.035	0.107	0.026	0.207
4	0.014	0.	0.023	0.	
4	0.014		0.023		
4	0.000	0.016	0.000	0.027	0.043
5	0.023	0.909	1.000	1.000	
5	0.911		1.000		
5	0.107	0.028	0.139	0.025	0.299

FIGURE B-7
SAMPLE DATA OUTPUT, COMPLETE

1	1	0.	155.00	0.	0.	155.00
2	1	0.	139.88	0.	0.	139.88
3	1	0.	134.81	0.	0.	134.81
4	1	0.	140.45	0.	0.	140.45
5	1	0.	96.98	0.	0.	96.98
1	2	10.0	155.00	12.50	25.16	192.66
2	2	10.0	139.88	9.98	6.84	156.70
3	2	10.0	134.81	9.13	20.74	164.68
4	2	10.0	140.45	10.08	4.28	154.80
5	2	10.0	96.98	2.83	29.92	129.73
1	3	20.0	155.00	25.00	100.63	280.63
2	3	20.0	139.88	19.96	27.34	187.18
3	3	20.0	134.81	18.27	82.95	236.03
4	3	20.0	140.45	20.15	17.10	177.70
5	3	20.0	96.98	5.66	119.66	222.30
1	4	30.0	155.00	37.50	226.42	418.92
2	4	30.0	139.88	29.94	61.52	231.34
3	4	30.0	134.81	27.41	186.63	348.85
4	4	30.0	140.45	30.23	38.48	209.16
5	4	30.0	96.98	8.49	269.24	374.71
1	5	40.0	155.00	50.00	402.52	607.52
2	5	40.0	139.88	39.92	109.36	289.16
3	5	40.0	134.81	36.54	331.79	503.14
4	5	40.0	140.45	40.30	68.42	249.17
5	5	40.0	96.98	11.32	478.65	586.95
1	6	50.0	155.00	62.50	628.94	846.44
2	6	50.0	139.88	49.90	170.88	360.66
3	6	50.0	134.81	45.68	518.43	698.91
4	6	50.0	140.45	50.38	106.90	297.73
5	6	50.0	96.98	14.15	747.88	859.01
1	7	60.0	155.00	75.00	905.67	1135.67
2	7	60.0	139.88	59.88	246.07	445.83
3	7	60.0	134.81	54.81	746.53	936.15
4	7	60.0	140.45	60.45	153.94	354.84
5	7	60.0	96.98	16.98	1076.95	1190.91
1	8	70.0	155.00	87.50	1232.72	1475.22
2	8	70.0	139.88	69.86	334.93	544.67
3	8	70.0	134.81	63.95	1016.12	1214.87
4	8	70.0	140.45	70.53	209.53	420.50
5	8	70.0	96.98	19.81	1465.85	1582.64
1	9	80.0	155.00	100.00	1610.08	1865.08
2	9	80.0	139.88	79.84	437.45	657.17
3	9	80.0	134.81	73.08	1327.17	1535.06
4	9	80.0	140.45	80.60	273.67	494.72
5	9	80.0	96.98	22.64	1914.58	2034.20

FIGURE B-7 (CONTINUED)

1	0.252
2	0.068
3	0.207
4	0.043
5	0.299

1	0.	667.12	0.	0.	667.12
2	10.0	667.12	44.52	86.92	798.56
3	20.0	667.12	89.04	347.68	1103.84
4	30.0	667.12	133.56	782.29	1582.97
5	40.0	667.12	178.08	1390.74	2235.94
6	50.0	667.12	222.60	2173.03	3062.75
7	60.0	667.12	267.12	3129.16	4063.40
8	70.0	667.12	311.64	4259.14	5237.90
9	80.0	667.12	356.16	5562.95	6586.23

PROGRAM STOP AT 2150

FIGURE B-7 (CONCLUDED)

of the air drag for each car. The data from the train file is first listed as a check. Next, the net and gross train weights are printed. The next group of data lists for each car in sequence the car number, the mechanical resistance of the car in lbs., the factor which multiplies the velocity, and the effective gap between vehicles at the front and rear of the vehicle. Note that the gaps at the front and rear of the train are greater than 30 feet; the program both establishes that and also treats any gap larger than 30 feet as infinitely large for aerodynamic purposes. The gap at the rear of the forward vehicle is naturally the same as the gap at the front of the trailing vehicle. The following single quantity is the sum of the individual mechanical resistances and is hence the mechanical resistance for the entire train, in lbs..

The next group of data is printed in three lines, again for each car. The first line lists the coupling and area factors, CF and AF, as noted in the column headings. The next line lists the F factor, for fore and aft respectively, combining these, as noted in the text of the report. The final line of this group lists the coefficients entering the calculation of the air drag for each car: the coefficients for the front pressure effect, the skin drag, the rear pressure effect, and the underside and truck drag, respectively; these four are dimensionally consistent and are summed to form the fifth-listed coefficient which multiplies the square of the velocity directly to obtain the air drag. As noted in the text of the report, the magnitude of the fifth coefficient is on the order of the magnitude of the .07 coefficient of the modified Davis equation and is directly analogous to it. Examination of this coefficient and comparison with .07 reveals the difference between the true air drag contributed by a single car and the drag as computed by the modified Davis expression.

The following group of data lists the car number, the velocity index, the velocity for which the calculation is made, and the mechanical, velocity-dependent, and air resistances, plus the total resistance, for each car at each velocity.

The next small group of data is a separate listing, for convenience, of the final air drag coefficient used in the calculation to multiply the square of the velocity directly. As explained before, these values compare with the .07 coefficient of the modified Davis coefficient.

The final group of data is the same as that printed under the minimum data option and gives the several types of train resistances at each velocity.

BIBLIOGRAPHY

- Bernhard, M., "New Knowledge About Train Resistance at Very High Speed. (Tests with the TGV 001 Train)," French Railway Techniques, V. 18, No. 2; 1975, pages 31-36.
- Bernhard, M., "Recent Measuring of the Resistance to Forward Motion of Rolling Stock," Revue Generale des Chemins de Fer, April, 1976, pages 243-255, (French).
- Buckwalter, R. V., "Roller Bearing Service in Locomotive, Passenger, and Freight Equipment," American Society of Mechanical Engineers, Paper #RR-56-1, Transactions, 1934, V. 56.
- Caldwell, W. N., and Marcotte, P., "Articulated Truck Development," Canadian National Rail Research, Montreal, Quebec.
- Cox, I. E., Shoemaker, R. J., Pearce, E. S., "Solid Type Journal Bearings in High-Speed Freight Service," Transactions, ASME, 1950.
- Davis, W. J., Jr., "The Tractive Resistance of Electric Locomotives and Cars," General Electric Review, October 1926, page 3.
- Gluck, H., "Energy Consumption at High Speeds," Railway Gazette International, V. 129, No. 12, December, 1973, pages 462-465.
- Haase, R. H. et.al., "Performance of Land Transportation Vehicles," Rand Corporation Report No. RM-3966-RC, published by National Technical Information Service, Report No. AD-428-668, January, 1964.
- Hammitt, A. G., "Aerodynamic Forces on Freight Trains, Volume 1, Wind Tunnel Tests of Containers and Trailers on Flatcars," U.S. Department of Transportation, Federal Rail Administration, Report No. FRA/OR&D-76-295.I, December, 1976, pages 47-48.
- Hammitt, A. G., The Aerodynamics of High Speed Ground Transportation, Western Periodicals Co., 13000 Raymer St., North Hollywood, Calif., 91605, 1973, pages 47-58.
- Hara, T., Kawaguti, M., Fukushi, G., and Yamomota, A., "Aerodynamics of High Speed Trains," High Speeds Symposium, Vienna International Railway Congress Association Bulletin, V. 45, No. 11, 1969.
- Harada, M., "Experimental Study on the Running Resistance of JNR Freight Cars, General Equation of Resistance and its Variance," Railway Technical Research Institute, Japanese National Railways, V. 8, No. 2, June 1967.

Hay, W. W., Railroad Engineering, John Wiley & Sons, 1953, pages 68-84.

Hoerner, S. F., "Fluid Dynamic Drag," published by the author, Midland Park, N.J., Second Edition, 1965.

Hopkins, John, "Railroads and the Environment - Estimation of Fuel Consumption in Rail Transportation, Volume 1, Analytical Model"; U.S. Department of Transportation, Federal Rail Administration, Report No. FRA-OR&D 75-74.I, October, 1975.

Hopkins, John B. et.al., "Fuel Consumption in Rail Freight Service: Theory and Practice," paper presented at Annual Meeting, Transportation Research Board, Washington, D.C., January 1977.

Keller, William M., "Variables in Train Resistance," American Society of Mechanical Engineers, Paper #58-A-265, 1958.

Koffman, J. L., "Tractive Resistance of Bogie Wagons," Railway Engineering International, September 1972.

Koffman, J. L., "The Tractive Resistance of Diesel Locomotives," The Railway Gazette, December 29, 1961, pages 733, 739.

Koffman, J. L., "Tractive Resistance of Rolling-Stock," Railway Gazette, November 6, 1964, pages 899-901.

Koffman, J. L., "Tractive Resistance and Riding of Railcars," Diesel Railway Traction, November, 1963, pages 428-432.

de Koranyi, L., "Energy Requirements of High-Speed Trains," Railway Gazette, July 1, 1966, page 533.

Lipetz, A. I., "Air Resistance of Railroad Equipment," American Society of Mechanical Engineers, Paper RR-59-4, Transactions, 1937, Vol. 59.

Luebke, R. W., "Evaluation of TOFC Aerodynamic Resistance," Research Services Report, Planning Department, The C&O-B&O Railroad Company, December, 1966.

Luebke, R. W., "Economics of Railroad Automobile Rack Car Aerodynamic Drag," U.S. Department of Transportation, OHS>, NTIS Accession No. PB183845, March 1969.

Matthews, J. T. and Barnett, W. F., "Wind Tunnel Tests of a Scale Model Railroad Automobile Rack Car," U.S. Department of Transportation, Office of High Speed Ground Transportation, NTIS Publication No. PB-180198, June 1968.

Marks, Lionel S., Mechanical Engineers' Handbook, Seventh Edition, McGraw Hill Book Co., New York, N.Y., 1967.

Scales, B., "Rolling Resistance and Track," Railway Engineering Journal, Institution of Mechanical Engineers, V. 2, No. 3, May 1973. (English)

Schmidt, E. C., "Freight Train Resistance; Its Relation to Average Car Weight," University of Illinois Engineering Experiment Station Bulletin No. 43, Urbana, Illinois, May 1910, reprinted July 1934.

Schmidt, E. C., and Marquis, F. W., "Effect of Cold Weather Upon Train Resistance and Tonnage Ratings," University of Illinois Engineering Experiment Station Bulletin 59, 1912, Urbana.

Tope, Don, "Rolling Resistance of Freight Cars," The Timken Co., June 1971.

Tuthill, J. K., "High-Speed Freight Train Resistance: Its Relation to Average Car Weight," University of Illinois Engineering Bulletin, 376, 1948.

Ural, A., "Simplified Formula for the Calculation of the Tractive Resistance of Freight Trains," Glaser's Annalen ZEV, V. 97, No. 4, April 1973, pages 177-178, (German).

"Train Resistance Test - COFC vs. TOFC," Santa Fe Railroad Research Report, October, 1956.

"Measurement of Train Resistance," Railway Gazette, V. 100, 12 February 1954, page 173, (English).

Committee 16 on Economics of Railway Location and Operation, "Effect Upon Train Resistance of Lateral Forces Due to Side Winds." A.R.E.A. Proceedings, Vol. 43, 1942, pages 56-71, A.R.E.A., Chicago.

"Resistance of 95-Ton Ore Cars and 70-Ton Hopper Cars Equipped with Timken Roller Bearings," TRB Physical Laboratory Project Test Report 333-B, April 21, 1955.

"Car Rolling Characteristics Data Developed by USSR Railroad" Railroad Transport, Railroad Transport Editorial Board, Moscow, USSR, No. 2, 1967.

"E - L Test Piggyback, Rack Car Resistance," Railway Locomotives and Cars, October 1966, pages 23-54.

Resistance of a Freight Train in Forward Motion,
John D. Muhlenberg, 1977
21-Freight Operations

SMEAD 00 VP59SA