

## **FEDERAL RAILROAD ADMINISTRATION UPDATE ON ELECTRONICALLY CONTROLLED PNEUMATIC BRAKES**

The Federal Railroad Administration (FRA) continues to promote the adoption of electronically controlled pneumatic (ECP) brakes. On October 16, 2008, the FRA amended Title 49 Code of Federal Regulations Part 232, Brake System Safety Standards for Freight and Other Non-Passenger Trains and Equipment, by publishing new regulations (*see* Federal Register Vol. 73, No 201) that address the maintenance and operation requirements for ECP brake systems. The final rule became effective January 12, 2009.

FRA continues to believe that ECP brakes provide numerous safety and business benefits over conventional air brake systems. ECP brake technology provides simultaneous and graduated application and release of brakes on all rail cars within a train, resulting in shorter stopping distances. Trains equipped with ECP brakes provide locomotive engineers with better train control, lowering the risk of derailment. ECP brakes also permit longer trains to operate at higher speeds with improved fuel efficiency and reduced emissions. It also complements other rail safety technologies like Positive Train Control systems and Wayside Detection Systems.

The final rule requires that ECP brake systems fully comply with existing industry standards and that certain railroad operating rules and training programs be modified to ensure workers have the knowledge and skills required to properly utilize the systems. While the final rule does not mandate adoption of ECP brakes, it establishes performance standards for their use. With the final rule in place, FRA is confident that it will facilitate more widespread deployment of the technology to the benefit the rail industry. The rule permits trains to travel up to 3,500 miles without stopping periodically for certain routine brake inspections—more than double the current limit—because ECP brake systems contain continual, electronic, self-diagnostic “health-check” capabilities that inform train crews when maintenance is required. For example, an ECP brake-equipped intermodal container train originating from the ports of Los Angeles-Long Beach may safely travel all the way to Chicago without stopping for a routine brake test. Similarly, ECP brake-equipped coal trains will be able to make faster deliveries from western coal fields to power plants in eastern and southern States.

The Association of American Railroads (AAR) has played a significant role in advancing ECP brake implementation and has worked with different brake manufacturers on achieving interoperability between the two currently available products. AAR has developed and adopted industry standards for rail cars and locomotives equipped with ECP brakes.

FRA continues to examine the potential business benefits of ECP brakes and has contracted with Booz Allen Hamilton to work with several of the railroads and shippers currently operating ECP brake-equipped trains to gather operational and performance data to assess realized improvements in train cycle times, reduced fuel consumption, and reduced annual expenditures for wheel replacement and brake shoes. Through better

cycle times, there is potential for enhanced asset utilization and increased capacity on the rail system. FRA believes that by demonstrating the advantages that ECP brakes offer, railroads, railcar owners, and shipping companies will increasingly realize safety and business benefits, which will prompt the industry and its customers to make the necessary investments in this technology.

**Updated: March 10, 2009**

**Contact: James Wilson (202) 493-6259**



**Federal Railroad Administration**  
**ECP Brake System for Freight Service**

**Final Report**

---

Booz | Allen | Hamilton

Released August 2006

## Table of Contents

I.	Executive Summary .....	I-1
I.1.	ECP Brake Study Background .....	I-1
I.2.	ECP Stakeholders .....	I-2
I.3.	ECP Implementation Principles .....	I-4
I.4.	Selecting an Implementation Alternative .....	I-9
I.5.	Next Steps .....	I-13
II.	Rail Brake Operations and Safety Impacts .....	II-1
II.1.	How Rail Brakes Currently Work .....	II-1
II.2.	Operation Under ECP Brake Technology .....	II-3
II.3.	Operating Benefits of ECP Brake Technology .....	II-4
II.4.	Safety Benefits and Failure Rates of ECP Brake Technology .....	II-6
III.	ECP Implementation Cost and Benefits .....	III-1
III.1.	Conversion Costs for Freight Cars .....	III-1
III.2.	Stand-Alone Versus Overlay Conversion .....	III-1
III.3.	Installation Economies of Scale and Experience .....	III-2
III.4.	Anticipated Fuel Savings with ECP Brake Technology .....	III-2
III.5.	Wheel Savings .....	III-3
III.6.	Savings on Brake Inspections .....	III-4
III.7.	Savings on Brake Shoes .....	III-4
III.8.	Increases in Network Capacity .....	III-5
III.9.	Other Cost Savings .....	III-5
III.10.	Safety Benefits .....	III-6
IV.	Three ECP Implementation Alternatives .....	IV-1
IV.1.	PRB Implementation Plan .....	IV-1
IV.2.	One Railroad Implementation Plan .....	IV-3
IV.3.	New Equipment Implementation Plan .....	IV-4
V.	Conclusions and Next Steps .....	V-1
	Appendix A. Railroad Braking Technology: The History and Advances .....	A-1
	Appendix B. Expert Panel Members .....	B-1
	Appendix C. Value Measuring Methodology .....	C-1
	Appendix D. Industry Experience with ECP Brake Technology .....	D-1
	Appendix E. VMM Results for the PRB Alternative .....	E-1

## List of Tables

Table I-1. PRB Implementation Plan: Quantifiable Costs and Benefits .....	I-11
Table IV-1. PRB Implementation Plan: Quantifiable Costs and Benefits.....	IV-3

## List of Figures

Figure I-1. Five Key Stakeholders and Roles .....	I-3
Figure I-2. Seven Principles of ECP Implementation Alternatives.....	I-4
Figure I-3. ECP Potential Approach and Timeline .....	I-12
Figure I-4. Phased Implementation of ECP .....	I-13
Figure II-1. Automatic Air Brake System – Charging.....	II-2
Figure II-2. Automatic Air Brake – Brake Application .....	II-2
Figure II-3. Automatic Air Brake – Brakes Released .....	II-3
Figure II-4. Key Locomotive and Freight Car Components of and ECP Technology System.....	II-4
Figure II-5. Safety Benefits.....	II-7
Figure V-1. ECP Conversion.....	V-1

## I. Executive Summary

**Electronically Controlled Pneumatic (ECP) brakes are a tested technology that offers major benefits in freight train handling, car maintenance, fuel savings, and network capacity. Their use could significantly enhance rail safety and efficiency.**

**The expected benefits of ECP braking technology appear to justify the investment, provided that the conversion is focused first on the high-mileage, unit-train-type services that would most benefit from its use, and subsequent conversions incorporate lessons learned.**

**The challenge of ECP brake implementation is threefold:**

- 1) How to equitably distribute the ECP brake benefits and conversion costs that fall unevenly between the freight railroads and private car owners**
- 2) How to focus ECP brake conversion on the particular types of trains and corridors that would most benefit from the technology without disrupting capacity-constrained rail freight operations**
- 3) How to manage the operating mix of ECP brake and non-ECP brake cars and locomotives during a lengthy conversion process.**

**This report by Booz Allen Hamilton (Booz Allen) for the Federal Railroad Administration (FRA) addresses these considerations, and presents three alternative plans for ECP brake implementation, as well as a recommended approach.**

### I.1. ECP Brake Study Background

ECP brakes are a relatively new technology that could eventually replace the conventional air brake system currently in use on freight trains, which had its origins in the 19<sup>th</sup> century research of George Westinghouse. (Appendix A provides a detailed review of the history of brake technology.)

With the present system, freight train cars brake individually, at the speed of the air pressure moving from car to car, along trains that are often well over a mile in length. This conventional braking contributes to excessive in-train forces, challenges in train handling, longer stopping distances, and safety risks of prematurely depleting air brake reservoirs. These problems are greatly reduced in the ECP brake mode of operation, during which all cars brake simultaneously, driven by an electronic signal.

After a competitive procurement in FY2005, the U.S. Department of Transportation's (DOT's) FRA selected Booz Allen to conduct this study of the benefits and costs of ECP brakes for the U.S. rail freight industry.

FRA is interested in several deliverables from this study:

- **A Literature Search of prior analyses of the benefits and costs of ECP brakes** – Booz Allen collected and reviewed a wide array of documents on prior ECP brake research from the rail industry and other sources and made them available to members of the Expert Panel on a password-protected project Web site. The literature generally reflected two themes: (1) that ECP brakes have been extensively and successfully tested in a variety of freight services in the U.S. and abroad; and (2) that the costs and benefits are significant, but their quantification not readily agreed upon, due largely to the complexity of comparing conventional versus ECP brake operations in different types of rail services.
- **Formation of an Expert Panel to advise on study analysis and outcome** – Booz Allen assembled 20 experts knowledgeable about ECP brakes from the rail industry and individual railroads, from major private car owners and from the brake supplier community. These individuals met with Booz Allen in three sessions over a total of six days in June, August, and November 2005 to review study progress and results. FRA representatives attended these sessions as observers. (Appendix B lists members of the Panel.)
- **An Office of Management and Budget (OMB)-compliant approach to Benefit-Cost Analysis** – For the study, Booz Allen used its Value Measuring Methodology (VMM) tool, which was developed specifically to assess benefit, cost, and risk tradeoffs in business settings that have aspects of both private investment considerations and public policy—as is the case with ECP braking technology. VMM is compliant with the benefit-cost requirements of the OMB’s Circular A-4, and is discussed in Appendix C.
- **Development of three Implementation Alternatives for ECP brake conversion** – Booz Allen has developed these plans, together with the most cost-effective alternative. Two key conditions underlie each of these plans:
  1. To achieve a viable, risk-adjusted benefit-cost outcome, it is critical to implement ECP brakes in a manner that minimizes the amount of time between the impact of conversion costs and the commencement of benefits.
  2. The operating realities of the rail industry are such that, for a significant number of freight cars, overlay operation will be unavoidable for some time. Overlay is defined here as the capability of a freight car to operate in either conventional or ECP brake service.

## I.2. ECP Stakeholders

As shown in **Figure I-1**, the following five principal stakeholders in the conversion of U.S. freight railroading to ECP braking technology have a crucial—and distinct—role to play in the implementation process:

1. Suppliers
2. Railroads
3. Private car owners
4. Association of American Railroads (AAR)<sup>1</sup>
5. FRA.

---

<sup>1</sup> Including the American Short Line and Regional Railroad Association (ASLRRRA)

Figure I-1. Five Key Stakeholders and Roles

Going forward, five key stakeholders will need to work together to design the initial ECP conversions and the resulting monitoring

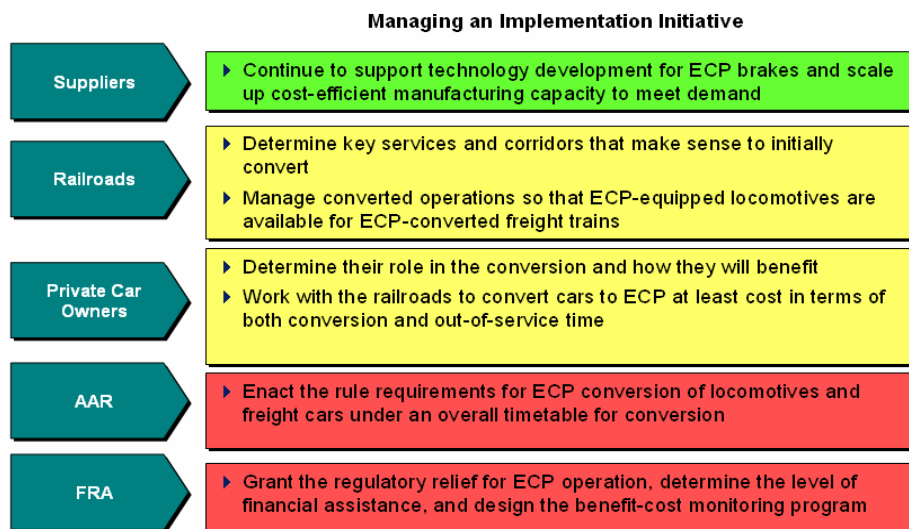

Booz Allen’s Expert Panel for this study brought together each of these stakeholders, with FRA participating as an observer. The Expert Panel added significant value to the study, with each member having:

- **Historical familiarity** with the past decade of experimentation with ECP braking technology and the practical barriers to the rail freight industry’s implementation of it, despite the technology’s diverse benefits.
- **Analytical participation** in the numerous studies of the costs and benefits of ECP brakes, and appreciation of the data limitations on the ability to reliably quantify many of the benefits of widespread application of them.
- **Understanding of the “tipping points”** required to end the inertia on implementing ECP brakes through joint stakeholder discussion of the internal hurdles each stakeholder must overcome to begin implementation.
- **Direct role in implementation** in that the Panel represents the diverse interests who would actually be involved in a broad-scale implementation of ECP technology, and could be reconvened, if desired, to guide the implementation process.
- **Potential participation in monitoring and reporting** the actual benefit-cost outcome of initial implementation to shape the intermediate and end phases of full industry conversion to ECP technology.



The Expert Panel is a valuable resource that, as a result of the study, is now accustomed to working together on ECP technology. FRA may wish to consider keeping the Panel together to assist in future implementation of ECP technology.

### I.3. ECP Implementation Principles

As a result of Booz Allen’s review of the extensive literature on ECP technology<sup>2</sup> and interaction with the Expert Panel over six days in 2005, we have identified several principles that should shape the advancement of ECP technology implementation.

Based on our analysis, and the work of the Expert Panel, Booz Allen has identified seven principles to guide the implementation of ECP technology and avoid the pitfalls that have stalemated its adoption for several years.

The principles are designed to overcome the barriers that have stalled the rail freight industry’s implementation of ECP technology to date by addressing the real-world financial and operating constraints.

The principles are summarized in **Figure I-2** and discussed individually below.

**Figure I-2. Seven Principles of ECP Implementation Alternatives**

**Based on the Expert Panel’s work to date, seven distinct principles emerge for successfully driving ECP implementation alternatives**

	Focus	Principle
1	Initial Conversions	Maximize the benefit-cost ratio for the first conversions
2	New Equipment	Require conversion “kits” for all new cars and locomotives
3	Federal Support	Provide incentives through regulatory relief, other programs
4	Gainsharing	Resolve equitably the stakeholder financial imbalance
5	Date Capture	Collect and publish results of the initial conversions
6	Intermediate Conversions	Capitalize on the experience of the initial conversions
7	End State	Set a detailed timetable to make full conversion transparent

<sup>2</sup> This literature is found on the ECP website developed for FRA by Booz Allen as part of the study.

1. Prioritize the Initial Conversions

This first principle involves a careful focus on which types of train services and over which rail corridors should be the first to convert to ECP brakes to maximize the benefit-cost ratio of the conversion. To a large extent, the most effective way to conduct this prioritization is to allow the rail marketplace itself to make this decision. Within this context, however, Booz Allen's research indicates that the most favorable benefit-cost ratios for ECP technology are likely to be found for services that meet **each** of the following criteria:

- Are heavy-haul, high-mileage movements in capacity-constrained corridors, such as Powder River Basin (PRB) coal to midwestern and eastern utilities or doublestack intermodal movements to and from the West Coast
- Involve unit train fleets in which the trainsets are generally kept intact for significant periods of time
- Minimize the number of parties required to complete the conversion and manage the resulting ECP train operations.

This last criterion is particularly important. For example, long-haul PRB coal movements that require, at most, two railroads from mine origin to utility destination and in which the utility or a major lessor owns many of the trainsets involved are inherently easier to reach conversion agreement on—and stage the conversion for—than services involving numerous railroads, car owners, and shippers. Gainsharing (Principle #4 discussed below) is also easier to achieve with a smaller set of participants.

2. Set ECP Technology Standards for All New Equipment

Newly manufactured locomotives and freight cars are long-lived assets that will be active in the rail equipment fleet for decades to come. Accordingly, and in keeping with Principle #7 regarding the importance of setting a transparent end state for conversion, it is essential to ECP technology's success that dates be established by the industry under which all new equipment will have to be ECP "compliant."

"Compliant" should have different meanings for locomotives than for freight cars and, perhaps, even for specific freight car types. Several basic economic drivers need to be taken into account:

- **Number of Units:** In a typical year, less than 1,000 new locomotives are added to the fleet versus 30,000 to 75,000 new freight cars.
- **ECP Unit Cost:** The cost to equip a new locomotive with ECP controls is approximately \$40,000, which is on the order of 10 times the incremental amount required to equip a new freight car with ECP brakes.<sup>3</sup>
- **Use of the Unit:** Road locomotives that are ECP-equipped are more likely to be used in ECP service more quickly than are certain car types, such as general use boxcars or low-mileage tank or other chemical cars, which will likely only be in ECP train service during the latter phases of the conversion schedule.

<sup>3</sup> As discussed in this report, the cost to equip a new freight car with ECP brakes varies depending on whether the car is given an ECP stand-alone system, or has dual-mode capability.

These drivers, and the imperative to convert to ECP technology in a cost-effective manner, makes it vital that the industry group that sets interchange equipment standards (i.e., the AAR) develops a conversion timetable for new equipment that has two components:

1. Dates and standards by which all **new locomotives** are fully ECP operational
2. Dates and standards by which all **new freight cars** are equipped with ECP “starter kits,” (i.e., equipment that is more cost-effective to install during manufacture of the car than to retrofit, but that takes into account that the car may not operate in ECP service for several years).<sup>4</sup>

The AAR will also need to set dates and standards for final conversion to ECP technology of all equipment used in interline service, as discussed in Principle #7.

### 3. Provide Federal Incentives

This principle is grounded in the fact that conversion of the rail freight industry to ECP service can best be accomplished through a public-private partnership (PPP) involving both private sector financial benefits and sound public policy.

The Expert Panel concluded that Federal financial support is a critical component to overcoming the inertia on ECP installation. This might seem surprising in light of the significant projected financial returns discussed in this report for the recommended conversion of Powder River Basin coal movements to ECP service. However, federal regulatory relief makes up a significant component of those returns. In addition, the Expert Panel felt, and Booz Allen agrees, that federal incentives, as discussed below, and the accompanying federal pressure to use the incentives to begin the change could make the difference between implementing conversion to ECP in the near-term and the continued absence of action which has characterized this issue for the past decade.<sup>5</sup>

This federal support takes two distinct forms:

1. **Regulatory relief** from specific non-statutory<sup>6</sup> inspection requirements within the purview of FRA. ECP operation provides for continuous electronic monitoring of air brake condition and pressure, removing the need for certain of the physical brake inspections currently conducted because such constant monitoring is not available with conventional air brake technology.

As discussed in the Section III of this report, such regulatory relief could include relaxation or removal of costly brake inspection requirements for trains operating in ECP mode for:

- Intermediate terminal inspection
- Single-car air brake test

---

<sup>4</sup> For example, the starter kit could include mounting brackets and the conduit pipe for ECP brakes that runs through the length of the car, but may exclude the wiring inside the pipe, which would deteriorate if not in actual ECP use for a protracted period, and which can easily be installed in the pre-existing conduit when the car is ready to be placed in ECP service. The conduit adds only several hundred dollars to the cost of a freight car.

<sup>5</sup> The industry has been developing papers on the economic benefits of ECP since at least 1994. See for example, “*Economic Analysis of Braking Systems*,” Thomas S. Guins, November 1994 (TD94-021) published by AAR’s Research and Test Department.

<sup>6</sup> Non-statutory is used here to indicate those provisions that are part of the Code of Federal Regulations (CFR), not the U.S. Code itself—hence, they can be changed through the regulatory process, rather than requiring new legislation.

- Percent operable brakes at initial terminal departure.<sup>7</sup>

#### 4. Provide for Gainsharing

2. **Loan or grant assistance** to railroads and private car owners could fund the costs of initial conversions on a first-come, first-served basis up to some pre-determined total program level. Low-cost, long-term loans, or outright grants, would augment the financial benefits from federal regulatory relief and increase the potential for more rapid, voluntary conversion to ECP.

As discussed in the benefits section of this report, most of the benefits of ECP technology accrue to the railroads, rather than to private car owners who now provide more than half of the U.S. freight car fleet. Among the principal financial benefits likely to be realized by the railroads from ECP technology are:

1. Reduced fuel consumption
2. Savings in premature wheel and brake shoe wear
3. Reduced costs and delay from brake inspection relief
4. Increased capacity as entire corridors are converted to ECP technology
5. Reduced collisions and derailments from improper train handling
6. Reduced or eliminated accident damage with shorter stopping distances
7. Easier locomotive engineer training.

Private car owners fall into two major categories: (1) **User Owners** such as utilities who own or lease cars on a long-term basis for their own shipments, and (2) **Lessor Owners** such as financial institutions for whom freight car ownership is strictly a portfolio of assets leased out to earn a return on investment.

User owners are likely to benefit directly from item 2 above and eventually from item 4, which should increase turnaround of their trainsets and reduce their overall requirements for equipment. Lessor owners are not likely to benefit directly from any of these items, as they realize their primary financial return from maximizing lease rates and leased days for rolling stock that is in demand in the market.

The financial foundation of gainsharing is that, if ECP technology has favorable net benefits for the rail industry as a whole, but the benefits accrue primarily to the railroads, **and** if the costs of freight car conversion for more than half the fleet fall to the private car owners, some sharing of benefits from railroads with private car owners could smooth the conversion path. The gainsharing could take one of two forms:

1. **Direct dollar contribution** from the railroads for a portion of the cost of freight car conversion
2. **Sharing of the benefits** through more favorable rate and service agreements with car owners who help the railroads run ECP trains by converting their private cars.

---

<sup>7</sup> This provision is important to facilitate conversion because it would allow a certain percentage of cars (e.g., 15 percent) with either conventional or ECP brakes to be placed safely in a train operating in the opposite brake mode prior to full industry conversion to ECP technology. Note that placing conventional cars in an ECP train is more difficult than the reverse due to the need to run the ECP cable around the conventional cars.

The gainsharing options considered must complement the federal loan or grant assistance that is also made available.

### 5. Capture the Conversion Results

As discussed in Appendix D, there has been a diverse array of actual field experience with ECP technology in freight service in the U.S., Canada, and several other countries around the world. This experience shows very promising operating and financial benefits from ECP technology.

At the same time, however, there is no rigorously collected set of pre- and post-conversion performance data. There are three basic reasons for this lack of data:

1. **Operational complexity** that resulted in ECP experiments being prematurely truncated due to the inability to keep the small number of ECP-equipped locomotives in the fleet continuously available for ECP-converted freight cars
2. **Post-conversion changes** in operations, such as moving to longer train length, that rendered difficult direct comparisons of before and after performance data
3. **Proprietary data considerations** that led railroads to withhold full public disclosure of all pre- and post-ECP performance metrics.

Any PPP created to shepherd the initial conversions to ECP technology should provide for full performance monitoring and public reporting. Such an effort will not only clearly define the benefits of ECP in the current U.S. rail freight environment, but will also guide the latter stages of conversion by helping to prioritize the types of services and corridors to focus on after initial conversions are completed.

### 6. Design Intermediate Conversions

After a significant number of ECP-equipped unit trains are in operation in the U.S., most likely in PRB coal services, the services to prioritize next must be determined.

Conceptually, this intermediate stage of conversion could take several different forms:

1. **Gaining experience with other service types** by initiating conversions of previously non-tested services such as grain trains, auto rack shipments, manifest freights, or other such movements not part of the initial conversion
2. **Completing conversion of entire markets** such as for PRB coal or West Coast intermodal to extend the operational benefits of ECP technology to some of the fastest growing segments of the rail freight traffic base
3. **Converting specific capacity-constrained corridors** to all-ECP service to realize the greater train throughput offered by ECP technology.

The PPP formed to oversee initial implementation could be retained to shape the intermediate stage, with the close involvement of the AAR and FRA. The twin goals of this intermediate state should be to:

1. Continue to maximize the benefits of ECP while minimizing cost and operational complexity
2. Shape the conversions so as to isolate a steadily decreasing residual of non-ECP services that can be readily converted as part of a final full-industry deadline.

## 7. Fix the End State for ECP Conversion

While this last principle deals with the end state for ECP conversion, it is crucial that an overall conversion program be designed and publicized throughout the industry prior to the initial conversions. This will provide the certainty that conversion to ECP technology is going forward and set the deadline for all interline operations that are to be converted.

The end-state planning must also address the disposition of certain traffic categories for which the economics of conversion may be difficult to justify financially. For example:

- **Cars and locomotives beyond a certain age** due for retirement during or shortly after the conversion schedule
- **Low-mileage cars** that are used more for storage than for transit<sup>8</sup>
- **Equipment owned by smaller shortlines** that may not have the financial capability to fund conversion.

The key will be to remove the institutional and regulatory uncertainty of the conversion process for all stakeholders by reaching the key decisions laid out in the above principles before the conversion to ECP technology begins.

### I.4. Selecting an Implementation Alternative

The seven implementation principles reviewed above do not support one possible alternative for ECP installation, that of an “undifferentiated” requirement for ECP technology. “Undifferentiated” means establishment of a rule that some percentage of the entire locomotive and freight car fleets would have to be converted to ECP technology each year on a gradual basis.

There are some 29,000 freight locomotives in the U.S. fleet, and approximately 1.4 million freight cars in service.<sup>9</sup> Equipping this entire fleet with ECP brakes at a cost of \$40,000 per locomotive and \$4,000 per freight car would total approximately \$6.8 billion.<sup>10</sup> To put this number in context, it is more than the combined annual capital expenditures of all the Class I.

Even if the investment were spread over 20 years, at a rate of \$350 million per year, it would require \$47 million in annual benefits over 20 years for each investment installment to achieve even a relatively modest return of 12 percent. Realizing such sizeable benefit streams from an undifferentiated approach to ECP installation is highly unlikely, as the operational difficulties of making ECP-equipped locomotives available for ECP-converted cars, and vice-versa, means that few trains would actually operate in the ECP mode until the majority of the fleet was converted. Thus, near-term costs would outstrip more distant benefits.<sup>11</sup>

<sup>8</sup> For example, plastic pellet cars and coil steel gondolas average less than 8,000 miles per year compared to more than 60,000 miles annually for cars in utility coal service.

<sup>9</sup> The car count includes about 100,000 cars owned by non-Class I railroads in the U.S. and another 100,000 cars owned by Canadian-based railroads that are also operated within the U.S.

<sup>10</sup> This is before making three adjustments: (1) for inflation; (2) for economies of ECP manufacturing scale and implementation experience not yet factored into the per-unit costs used here; and (3) to reflect that some portion of road locomotives, perhaps as high as 20 to 25%, operate as permanent trailing locomotives, and require only an ECP run-through cable at minimal cost, not full cab conversion.

<sup>11</sup> Keeping ECP locomotives available for ECP freight cars has been one of the chief obstacles in railroad experiments to date with ECP. In addition, one study estimated that, even after 99% of all freight cars were equipped with ECP, the probability of *randomly* assembling a 100-car all-ECP train would be only

As noted earlier, a more economically rational approach to ECP migration is to tailor the initial installations to rail freight services that have the following characteristics:

- Are heavy-haul, high mileage
- Use freight cars that remain together in dedicated trainsets
- Are concentrated on selected rail corridors
- Account for a significant percentage of rail traffic
- Have relatively few stakeholder participants in the movements
- Have stakeholders familiar with and interested in ECP issues.

PRB coal service best meets all of these criteria. Cars with PRB loads in excess of 100 tons travel an average of 1,100 miles from mine to utility.<sup>12</sup> The trainsets are units that circulate continuously, with coal gondolas averaging in excess of 60,000 miles per year—the highest of any bulk car type.<sup>13</sup> Some 322 million tons of PRB coal moved in 2004 over the 95-mile Burlington Northern Santa Fe (BNSF) – Union Pacific (UP) joint line in Wyoming, accounting for 130 trains per day, loaded and empty.<sup>14</sup> In addition, another 80 million tons moved out of the PRB over BNSF's Northern Corridor. PRB coal represented an estimated 26 percent of total Class I revenue ton-miles in 2004, more than a quarter of all rail traffic.<sup>15</sup> The trainsets are often owned by the utilities themselves, or leased by the utilities from major rail equipment financial owners, such as GE Rail Services.

Many of the stakeholders involved in the movement of PRB coal follow ECP developments, and attended one or more of the meetings of the Expert Panel.<sup>16</sup> Both railroads (e.g., BNSF) and utilities (e.g., Southern Companies) have initiated experiments with ECP technology, and also collaborate on rail-related studies where ECP technology offers significant benefits, such as wheel life.<sup>17</sup> Given the sheer operating scale and stakeholder technology awareness for PRB coal traffic, focusing ECP implementation here makes both economic and practical sense.<sup>18</sup>

There are currently an estimated 2,800 road locomotives and 600 trainsets dedicated to the movement of PRB coal.<sup>19</sup> Thus, less than 10 percent of the industry's locomotive roster, and less than 6 percent of its freight car fleet, are generating 26 percent of its physical activity,

---

37%. (Study by New York Air Brake as cited in Leonard McLean's paper to the September 2001 Chicago meeting of the Air Brake Association.)

<sup>12</sup> Energy Information Administration, Coal Transportation Rate Database, April 2004.

<sup>13</sup> Based on AAR data analysis for 2001.

<sup>14</sup> Presentation of UP VP and General Manager, Doug Glass, September 27, 2005.

<sup>15</sup> Based on 1.66 trillion revenue ton-miles in 2004.

<sup>16</sup> This includes current or former officers of BNSF and UP, representatives of GE Rail and 3 major utilities: American Electric Power (AEP), Ameren Energy, and Detroit Edison (DE).

<sup>17</sup> For example, AEP, DE, BNSF, and Norfolk Southern (NS) – which was also represented at the Expert Panel – participated in a wheel life study for coal gondolas published by the Transportation Technology Center, Inc. (TTCI) in November 2004 (TD-04-020). TTCI is also a Panel member.

<sup>18</sup> As another indication of the interest in ECP of coal shippers, the National Coal Transportation Association has scheduled a major session on ECP brakes for the June 2006 meeting of its Operations and Maintenance Committee. The Association includes utilities, coal producers, car and component suppliers and railroads.

<sup>19</sup> Based on extrapolation of BNSF's coal fleet.

measured in revenue ton-miles.<sup>20</sup> This leverage of equipment to activity is the clear focal point for ECP implementation.

Significant PRB experience with ECP operation in revenue service would lay a solid foundation for conversion to ECP in the grain and intermodal arenas, particularly on congested mainline corridors where PRB coal movements compete for track space with other unit train operations. In the aggregate, unit trains of all types account for almost two-fifths of all Class I car-miles,<sup>21</sup> and would be the focus of second-stage conversion to ECP.

If each of the quantifiable benefits considered in Sections III-3 through III-9 is factored into the analysis, the results become even more significant, as shown in **Table I-1**. One-time conversion costs of a PRB fleet of 2,800 locomotives and 80,000 freight cars total \$432 million, and annual benefits from fuel, wheel, brake inspection, and brake shoe savings total approximately \$170 million, using the assumption that PRB coal's share of revenue ton-miles is a good proxy for its share of total Class I savings in each benefit category

**Table I-1. PRB Implementation Plan: Quantifiable Costs and Benefits**

One-Time Costs	Amount (\$ million)	Annual Benefits	Amount (\$ million)
Locomotive Conversion	112	Fuel Savings	78
Freight Car Conversion	320	Reduced Wheel Defects	45
		Brake Inspection Savings	45
		Brake Shoe Savings	2
<b>Total</b>	<b>432</b>	<b>Total</b>	<b>170</b>

Booz Allen conducted a detailed, risk-adjusted analysis of this alternative using VMM, which assumed a three-year equipment conversion period. The results are contained in Appendix E and indicate, even at the highest discount rate of 12%:

- A payback period of three years (i.e., 2011, if the conversion program begins in 2008)
- An IRR of 47 percent
- A net present value (NPV) of almost \$700 million.

In effect, conversion of PRB coal services to ECP brake technology is a “showcase” conversion not only because it is significant in size and appears to be financially sound, but also because it involves all of the five stakeholder groups and creates railroad operating benefits and efficiencies in a premier area of railroad service vital to the Nation’s energy generation. Successfully implementing a plan for ECP technology in PRB coal would create a model for conversion of the next set of major services, such as intermodal, auto, or unit train grain.

**Figure I-3** shows a potential 15-year schedule for total conversion to ECP, broken into three phases.

<sup>20</sup> Assuming an average of 133 coal cars per trainset.

<sup>21</sup> Based on AAR data for 2004.



Figure I-3. ECP Potential Approach and Timeline

A leveraged approach to ECP conversion should balance near term benefits with sustainable implementation

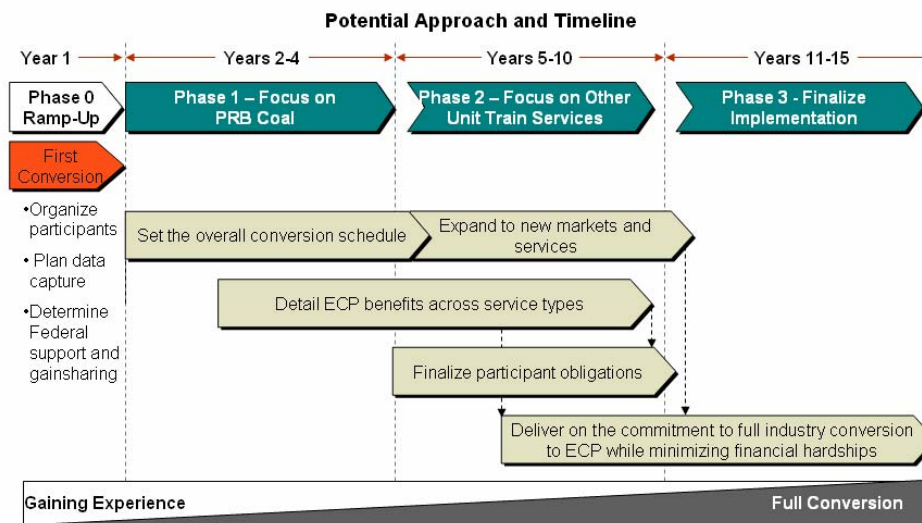

**Phase 1** would focus on the PRB coal services discussed above, converting these to ECP technology over a carefully planned several year timetable. Capturing the actual costs and benefits of the conversion and comparing it to the projections for the U.S., and the experiences in Canada and overseas, is vital to the next stages of the effort.

**Phase 2** would expand the conversion to other unit train services (grain, intermodal, auto, and so forth), beginning first on congested mainline corridors already handling PRB coal, so that the capacity-related benefits of ECP technology could be extended beyond the PRB joint line. The objective of this stage would be to complete all unit train conversions, thus accounting for about 40 percent of Class I rail volume, as measured in car-miles.

**Phase 3** would likely be the most challenging stage. Even though it would build on significant conversion to date, it would be focused on mixed freight trains with multiple types of traffic, origins, and destinations, which will be harder to convert. Handling the shortlines equipment fleets will also be a challenge at this stage. Successful navigation of this stage will require setting the final timetable for ECP conversion, and the identification of equipment that will not convert, as part of Phase 1.

**Figure I-4** presents the end state for ECP conversion, with the current impediments replaced by benefits in PPP financing, data evaluation, train diagnostics, and employee training and lifestyle.

Figure I-4. Phased Implementation of ECP

## Phased implementation of ECP will transform the current stagnation to a viable brake technology end state for the industry

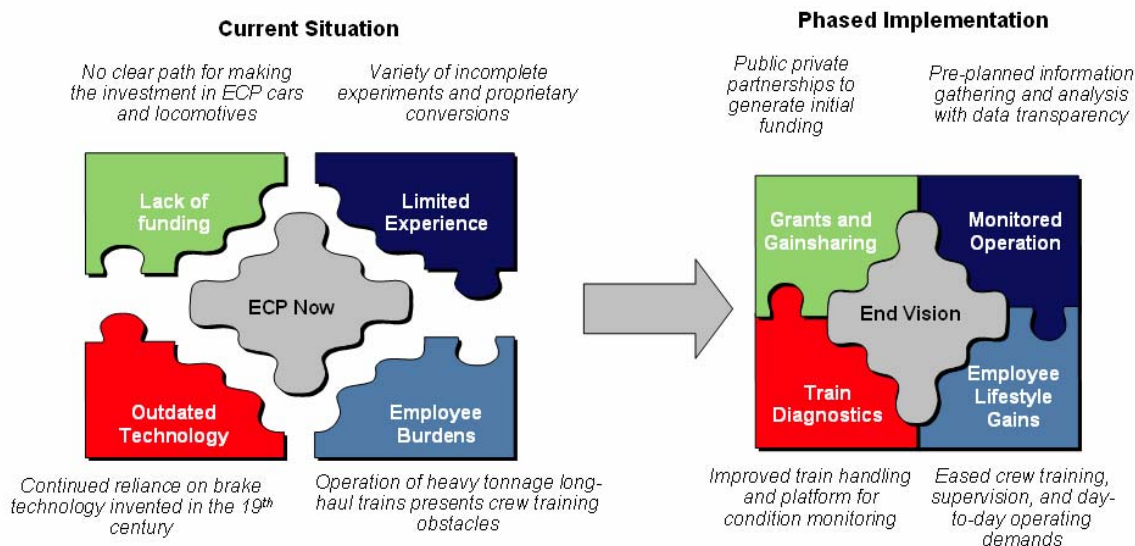

This end state would also have a significant positive impact on rail safety in several respects:

- **Shorter stopping distances** estimated at 60 to 70 percent for the heavy Spoornet coal trains, and on the order of 40 percent for lighter or shorter trains, would reduce train collisions and grade crossing accidents in which stopping distance is a key factor.
- **Improved train handling** will reduce the chances of runaway trains and resulting derailments.
- **Continuous brake pressure** with ECP technology will maintain the ability to stop the train at all times, removing the threat of prematurely depleting the air brake reservoirs before they are needed again.
- **Wiring the train** will provide a platform for the gradual addition of other train performance monitoring devices using sensor-based technology to maintain a continuous feedback loop on train condition for the crew and any centralized monitoring.

### I.5. Next Steps

Booz Allen suggests the following next steps toward ECP implementation for consideration by FRA and the other ECP stakeholders:

- Determine the role of the Expert Panel in the conversion process
- Formalize ECP conversion as near-term decision items for FRA and AAR
- Jointly address and reach agreement on the details of the seven principles to permit conversion to proceed on a voluntary industry basis
- Determine participants in the initial conversion
- Begin Phase 1.

## II. Rail Brake Operations and Safety Impacts

To understand the economic benefits and costs of ECP brake technology, it is necessary to appreciate how conventional brake technology currently works in the U.S. rail freight industry, why this technology is important to many aspects of railroad operations and safety, and what would change under ECP operation.

This section discusses these technology issues in summary, with Appendix A providing a more detailed treatment of the history of rail brake technology from its earliest application through current ECP performance.

### II.1. How Rail Brakes Currently Work

George Westinghouse developed the automatic air brake system in the 1870s. The following subsections summarize how it works.

**Figure II-1 through Figure II-3** demonstrates the Automatic Air Braking System stages.

#### II.1.1. Conventional Brake System Charging

- The locomotive has an air compressor that charges a main reservoir to about 150 psi (pounds per square inch).
- The controls in the locomotive charge the brake pipe with air from the main reservoir on the locomotive.
- The brake pipe is a single pipe, 1 and 1/4 inch in diameter, that runs the length of the train, and is connected between cars with a brake pipe hose.
- Each car has a two compartment auxiliary reservoir that is charged by air from the brake pipe to the same pressure of 90 psi.
- Each car has a brake cylinder that is connected to a series of rods and levers that apply and release the brakes. When air pressure is supplied to the brake cylinder, the resulting force presses the brake shoes against the wheel, and brake force results.
- The brake application is directed by the control valve, which is the successor to George Westinghouse's triple valve.

**Figure II-1. Automatic Air Brake System – Charging**

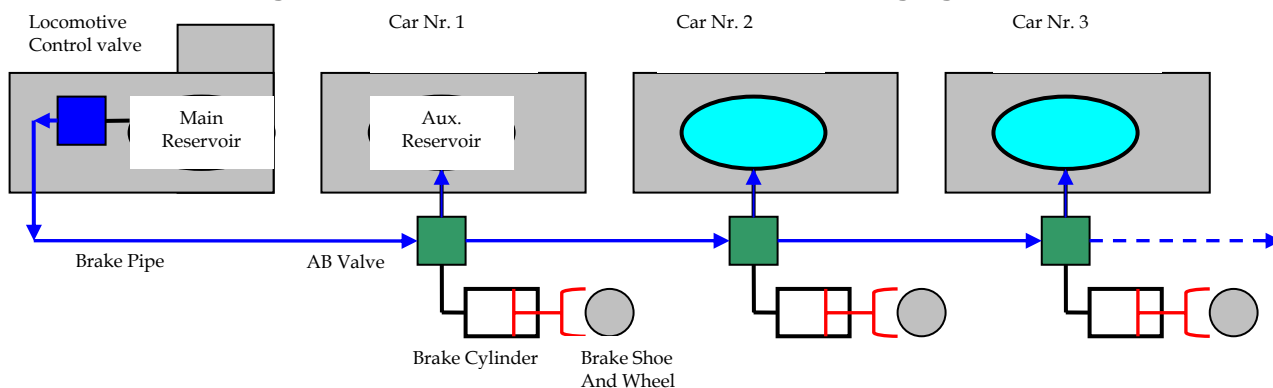

### II.1.2. Service Brake Application

- The control valve directs air from the brake pipe into the auxiliary reservoir when air pressure is rising in the brake pipe, in order to charge the auxiliary reservoir and be ready for a brake application.
- To perform a brake application, the locomotive automatic brake valve reduces pressure in the brake pipe by exhausting air.
- The drop in pressure in the brake pipe causes the car's control valve to direct air from the auxiliary reservoir into the brake cylinder. The pressure to the brake cylinder is approximately proportional to the drop in brake pipe pressure. A 26 psi reduction in brake pipe pressure is equal to a full service brake application on a fully charged brake pipe, and should result in a brake cylinder pressure adequate to achieve a full service braking effort (brake force).
- While the control valve is directing air into the brake cylinder, or holding air in the brake cylinder, it is NOT able to re-charge the auxiliary reservoir on each car.
- The engineer can apply the brakes in increments, a few psi at a time, or can go directly to a full service application of 26 psi reduction.

**Figure II-2. Automatic Air Brake – Brake Application**

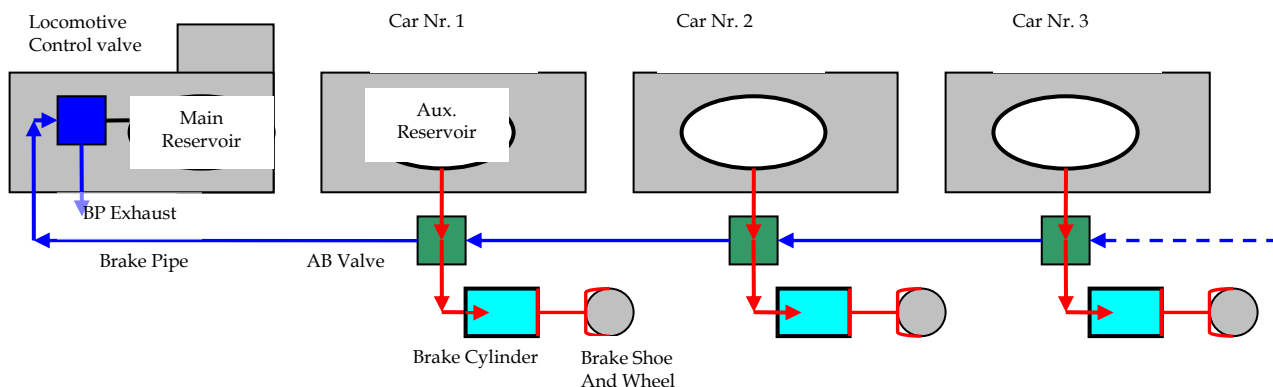

### II.1.3. Brake Release

Unlike a brake application, the **releasing** of brakes cannot be performed in increments. Brakes can only be released to zero, called a direct release, and the auxiliary reservoirs then begin to charge. Brake applications are possible, but are more complicated, from undercharged brake pipe and reservoirs. Recharging takes more time for a longer train because the air has to be sent down the length of the train's brake pipe—which can be up to a mile and a half.

Figure II-3. Automatic Air Brake – Brakes Released

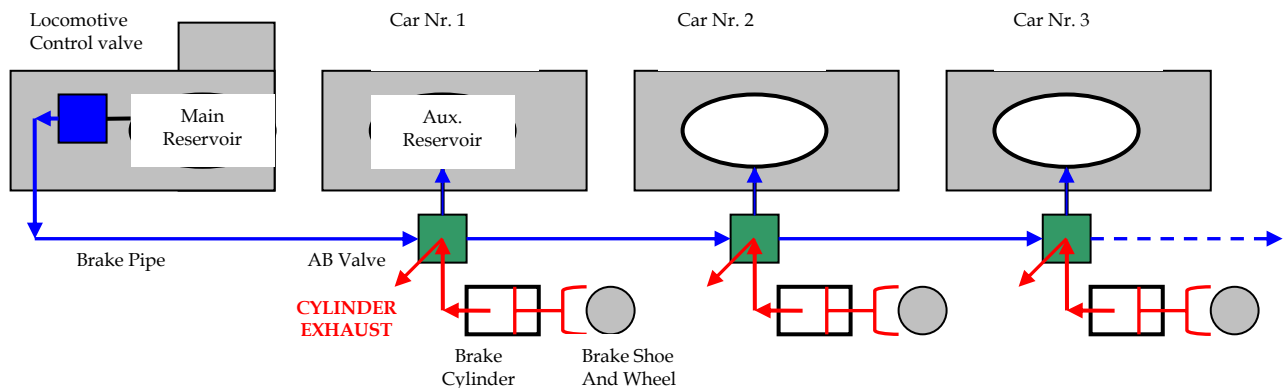

In addition, on extremely long trains, the brake pipe pressure on the last car may not reach 90 psi due to small leaks throughout the brake pipe, and there may be problems getting enough brake pipe pressure to fully release the brakes during cold weather.

### II.1.4. Emergency Brake Application

An emergency brake application can be initiated in several ways. The locomotive engineer can initiate the application by moving the brake handle to the emergency position, which exhausts air at a faster rate than the service application. The conductor's valve, located in the cab of the locomotive, can be opened to initiate an emergency brake application. It can also be initiated by a break-in-two, where the train breaks in two between cars and the brake pipe hoses separate, exhausting brake pipe pressure.

## II.2. Operation Under ECP Brake Technology

ECP brakes overcome the physical limitations inherent in conventional air brake technology by using electronic transmission of the braking signal through the train, but still use air pressure in the cylinder to apply the force to the brake shoes. ECP brakes also greatly simplify the extensive multiple valve equipment of conventional brakes by reducing it to a printed circuit board with microprocessor, one electrically activated application valve, and one electrically activated release valve, with feedback on brake cylinder pressure for control.

There are two slightly different arrangements of ECP systems that meet AAR standards. The first is the stand-alone system, which replaces the pneumatic logic completely, and allows the cars to only be operated in ECP mode. The second is the overlay system, which overlays the ECP logic on top of the existing pneumatic logic, and allows the cars to be operated either in

ECP mode or in conventional pneumatic mode, thus ECP-equipped cars can be hauled in a train operating with conventional brakes, or vice-versa.

To operate in ECP mode, compatible ECP equipment must be installed on the locomotive as well as on the freight car. **Figure II-4** shows the key locomotive and freight car components of an ECP system:

**Figure II-4. Key Locomotive and Freight Car Components of an ECP Technology System**

### Key locomotive and freight car components of an ECP brake technology system

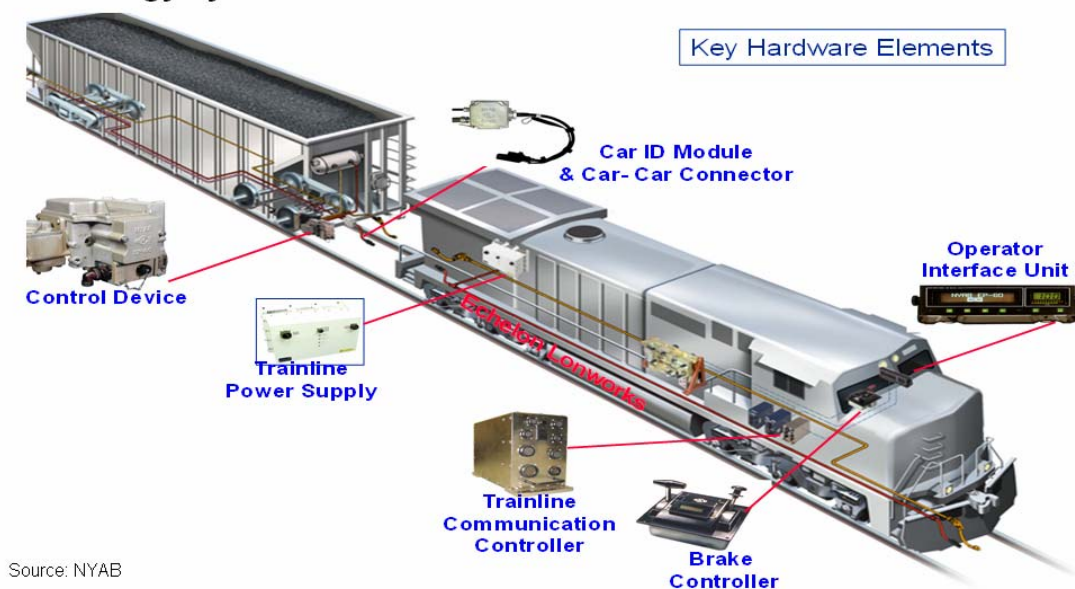

Source: NYAB

### II.3. Operating Benefits of ECP Brake Technology

ECP brake technology offers a number of distinct benefits compared to conventional rail freight braking technology:

- **Brake signal transmission rate** is increased with ECP brakes. Under conventional braking, an air signal transmits brake communications at approximately two-thirds of the speed of sound. The time it takes the air signal to reach the last car of a train is much slower than that of the ECP brake application and release signals. With ECP brakes, the signal is transmitted electronically—hence, it is instantaneous. This allows all cars (even those of the longest freight trains) to brake together, significantly reducing in-train forces (i.e., the push and pull of cars against each other that damages both rail equipment and cargo).

- **Brake application rate** is also controlled with ECP technology. Once each freight car in the train receives the signal, the rate at which the air is applied to the cylinder, or the rate at which the pressure is built up, is controlled so that cars maintain the same, or close, brake cylinder pressure at any point in time during the build up. This also reduces in-train forces caused by transient differences in cylinder pressure with conventional brakes.
- **Graduated brake release** is the ability to reduce brakes to a lower braking level after making a brake application. This enables adjustment of the braking level to more closely follow the safe speed limits. With ECP brakes, any train will have this capability.

Under conventional brake operation, once the operator has chosen a brake level, it cannot be reduced without completely releasing and resetting the brakes, which can only be safely done at very low speeds. In many cases, this leads to an unnecessary train stop. It may also lead to the operator making less of a brake application than needed initially, because it is always possible to add more pressure, but not to reduce it once applied. The lack of graduated release has long hampered train operations.<sup>22</sup>

- **Constant charging of reservoirs** is also a feature of ECP brake technology, for which the brake pipe acts as a reservoir supply pipe. The brake application is signaled electrically, and not by reducing brake pipe pressure. So the brake pipe is continuously supplying the reservoirs. Whether the brake application is released gradually, or by a sudden total release, the reservoirs are always recharged, and there is no waiting or risk of having no brake pressure.
- **Longer trains** are possible with ECP brakes. The use of electrical signals instead of air pressure for brake applications allows the brake pipe to be maintained at full pressure at all times. The uniform braking and constant pressure reduces end-of-train pressure problems and in-train forces that restrict current train lengths.
- **Higher average train speeds** are also possible, in some cases due to higher maximum speeds, but in all cases due to better ability to follow the safe speed limitations. The ability to perform a graduated release allows the engineer to reduce the brake application whenever it is too severe. Thus, there is no need to travel any distance at too slow a speed because of the inability to make a brake release.
- **Shorter re-starting times after train stops** are achievable under ECP operation. With the current brake technology, the auxiliary reservoirs on each car of the train must be recharged, and the brakes reset and ready before starting the train, if braking will soon be required. Thus, in areas of known descending grades there is a waiting period before the train can proceed after stopping en route

With ECP brakes, the brake pipe pressure is not lowered to signal a brake application. Instead, electric signal transmitted down the train on a wire indicates the brake application. The brake pipe remains charged at 90 psi and continues to supply the reservoirs during braking. Hence, there is no downtime needed for recharge after braking.

- **Elimination of power braking** is also feasible. Under conventional technology, when braking for a reduced speed area ahead, such as a curve or switch, the locomotive engineer may have to apply more brake effort than is required, and slow down far ahead of the speed restriction. The engineer cannot release the brakes because he may not be able to re-charge the reservoirs in time to safely negotiate the restriction, so he applies locomotive

---

<sup>22</sup> Lack of graduated release also increases fuel consumption because long, heavy freight trains are the least fuel efficient when starting up again after an unnecessary stop.



power while the brakes are applied, in order to optimize his speed (i.e., power braking). This is both a waste of fuel as well as unnecessary wearing of the brakes, as well as possible wheel damage, as they fight the locomotive pull. With graduated release, the engineer could simply reduce the braking force in order to optimize speed.

- **Reduction of undesired emergencies (UDEs)** is a significant benefit of ECP brake technology. UDEs are unexpected and unwelcome train stops due to sudden loss of air brake pressure. The current brake technology is built on the behavior of a complex system of air valves, springs, captured volumes of air at certain pressures, diaphragms between air volumes, and check valves. This mechanical technology is very susceptible to temperature, cleanliness of air, wear of rubber components, and inevitable leaks. Despite constant improvements of the valve technology, many ways remain for an unintended emergency brake application to be initiated.

By removing many of the valves, and turning brake applications over to electronic rather than air pressure controls, ECP brake technology sharply reduces UDEs, thus improving train performance and throughput.

- **Reduction in delays on severe grades** is also available with ECP brakes. With the current brake technology, on long and steep descending grades, the brakes are set at the top, and cannot be released until the train reaches the bottom of the grade and comes to a stop. Reservoirs cannot be recharged while the brakes are applied. There is the potential for leakage in the system to bring the reservoir pressure down to a level that is insufficient to make a stop. For this reason, the retainer was developed.

The retainer is a device on the brake cylinder exhaust that, when set, will maintain a minimum of approximately 13 psi in the brake cylinder even when the brakes on the train are released. Thus, the brakes can be released and reservoirs constantly recharged while the retainer bottles up about 13 psi in the cylinders. More braking can always be added if needed, but it will never drop below 13 psi when released. When used, retainers must be manually applied on every car of the train at the top of the hill. Retainers must then be released on every car of the train at the bottom of the hill. On long 100-plus car trains, this can mean walking over two miles and repeating 100 to 200 retainer switches, a considerable amount of time spent that can be eliminated with ECP brakes.

In sum, the operating benefits of ECP brakes are both diverse and significant. These operating benefits translate into major economic benefits as well, as reviewed in Section III of this report.

#### II.4. Safety Benefits and Failure Rates of ECP Brake Technology

The operation of freight trains using ECP brakes yields a number of significant safety benefits, as listed below and summarized in **Figure II-5**.

Figure II-5. Safety Benefits

**There is also agreement that there should be significant safety benefits from conversion to ECP brake technology**

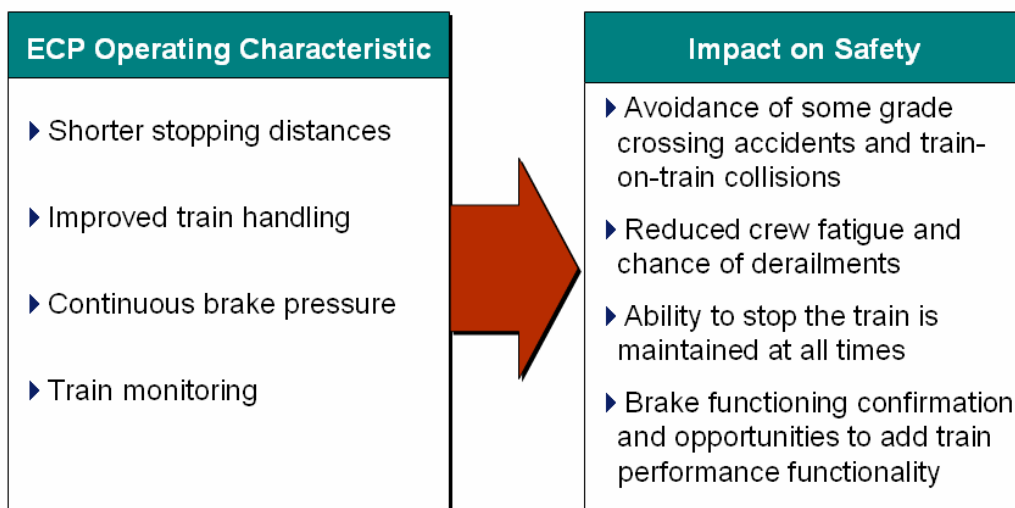

**Shorter stopping distances** due to the reduction of time for the brake signal to be transmitted to each car in a long train. Stopping distances for long trains with ECP brakes can be cut to about 40 to 60 percent of the conventional brake stop distances.

In its tests, for example, New York Air Brake has found that a loaded 100-car train moving at 50 mph requires nearly 4,100 feet to stop with conventional brakes compared to only 2,500 feet with ECP – a reduction of nearly 40%.<sup>23</sup>

Shorter stopping distances available with ECP brakes offer major safety benefits in helping to reduce collisions and grade-crossing accidents in which the engineer was able to see the threat on the tracks, but could not stop the train in time with conventional brakes. Even with ECP brakes, long, heavy-freight trains will not be able to “stop on a dime.” But the greatly reduced range of stopping distances will help avoid some accidents. In the above example, the 1,600 feet – nearly a third of a mile – saved with ECP could help train engineers in many grade crossing situations with clear lines of sight stop short of hitting an object in the crossing.

<sup>23</sup> New York Air Brake presentation to the first Expert Panel session, June 20, 2005.

**Improved train handling** will reduce derailments caused by in-train forces. With current brake technology, the first cars in the train begin to brake first, then braking is initiated progressively back through the train. This results in the cars in the back of the train running faster than the cars in the front of the train, and, thus, in compressing the train. This increases the potential that a car in the middle of a braking train being squeezed from both ends while on a curve will jump the outside rail and cause a derailment. ECP-equipped cars will brake simultaneously, so that there is no run-in from different braking of cars through the length of the train.

Improved train handling will also lessen the chance of operating error. Operating a train with current brake technology is an extremely complex task, requiring extensive knowledge of the rail line over which the train is running, and constant pre-planning of train speed and braking options several miles ahead. For example, on grades, the operator is constantly watching gauges, monitoring speed, air pressure, and dynamic brake effort, and must be prepared to make a decision instantly if something is wrong.

On level track, the consequences of improper train handling using conventional technology are not necessarily that the train becomes unstoppable, but rather that the train passes a signal and enters track that another train is occupying. The engineer is constantly making judgments on how much brake pressure to apply, knowing that the effort cannot be reduced once committed. This can cause the locomotive engineer to decide on less pressure when braking assuming, perhaps unwisely, that braking effort can always be added in time if needed.

This entire process becomes greatly simplified with ECP brakes because the engineer does not need to worry about applying too much braking effort, knowing that he can gradually release the brakes at any time.

**Train monitoring** allows ECP brakes to confirm the functioning of the brakes at all times, and at any time the brakes are applied. The engineer is immediately informed of any brake failure in any car on the train, and does not have to depend on the current physical inspections after every 1,000 miles of the trip.

**Continuous Brake Pipe Pressure** provides the ability to stop the train at all times, removing the threat of premature depletion of air reservoirs and runaway trains that are an issue with conventional brake technology.

**Real-time train status reporting** is possible utilizing the ECP brake system's wire-based communications platform to transmit information from each car back to the locomotive. This could include such information as bearing condition or wheel problems, with resulting benefits for safety.

**Reduced train crew fatigue** is also possible with ECP brakes. While no definitive data has yet been compiled, side-by-side ECP vs. non-ECP train simulator operations on the BNSF indicate that ECP-braked trains are far easier to operate. They do not require the operator to be constantly focusing on the pressure level in the brakes, as they are always fully charged. Thus the crew can concentrate on the operating environment in which the train is located, rather than also having to prepare for likely brake pressure levels miles ahead.

With respect to failure rates for ECP brakes versus conventional ones, Booz Allen has talked extensively to the brake manufacturers (New York Air Brake and Wabtec), to Quebec Cartier Mining, which has run ECP trains in Canada since 1998, and attempted to reach Spoornet, which is installing ECP on its coal export lines in South Africa. Unfortunately, while these

parties believe that ECP is at least as -- if not more -- reliable than its conventional counterpart, no one has real world operating data comparing failure rates for side-by-side train operations for the two systems.

One approach to securing such data is to capture it in the first conversions of PRB trains to ECP. This will allow conventional unit train brake reliability to be directly compared to the reliability of ECP brakes for technologically current, AAR-compliant ECP equipment for heavy haul, long distance coal movements in similar terrain.

### III. ECP Implementation Cost and Benefits

There are several key factors that directly drive ECP brake implementation costs and the benefit-cost ratio. Implementation decisions made regarding these costs are critical to the financial outcome of ECP brake systems for all stakeholders.

Similarly, there are several quantifiable ECP benefits that are also key to this outcome, in addition to a larger number of more difficult to measure operating and safety benefits.

#### III.1. Conversion Costs for Freight Cars

The potential freight car fleet (1.4 million units) to be converted to ECP technology dwarfs by nearly 50 to 1 the locomotive pool of approximately 29,000 units. Even if certain “storage-in-transit” car types are only converted to ECP technology late in the conversion program, the cost and complexity of ECP installation for over one million cars is still enormous—and is probably unprecedented in the rail industry.<sup>24</sup>

While the potential for cost savings in the \$40,000 per-unit price tag for converting a locomotive to ECP brake technology is obviously of consequence, any technology developments that offer significant savings in the per-unit cost of freight car conversion carry greater import, for car conversion at an average of \$4,000 per car is estimated to exceed 80 percent of total conversion costs.<sup>25</sup>

In light of the multiyear nature of the conversion program, stakeholders will need to pay continuing attention to technology developments that offer ECP implementation cost savings. A total conversion timeframe of, for example, 15 years should not be assumed to be a technology stagnant period.

#### III.2. Stand-Alone Versus Overlay Conversion

Decisions made on the share of conversions that are stand-alone versus overlay are another major ECP cost factor. For new freight cars, for example, the brake supplier industry estimates that, at this time, ECP stand-alone is expected to add about \$3,000 over and above the price tag for a freight car with conventional brakes. Equipping such new equipment with overlay capability could add another \$1,500 to this stand-alone cost per unit.

---

<sup>24</sup> The \$40,000/\$4,000 cost estimates are over and above the current cost of conventional brakes and include installation labor. The brake manufacturers do not presently expect there to be any significant long-run difference in maintenance costs between ECP and non-ECP brake systems, so the cost issue is primarily a one-time installation cost consideration. Booz Allen discussions with Quebec Cartier Mining, which has been running heavy-haul ECP trains of up to 180 cars in North America since 1998 – including in harsh winter conditions – confirm this conclusion.

<sup>25</sup> For example, there are certain “emulation” technologies which could permit overlay operation at less cost than overlaying ECP equipment on top of a conventional brake system. One such product has been tested in operations with Western Fuels and the Duluth, Missabe & Iron Range Railway.

Retrofitting existing conventionally braked freight cars introduces another cost parameter—estimated currently at \$5,000 per car to equip for overlay service.

It is clearly more cost-effective to move to stand-alone ECP brake systems instead of installing and maintaining two brake systems in overlay mode—but that, in turn, requires that ECP-equipped locomotives be available for the majority of a freight car's movements. This is part of the rationale for making dedicated services such as PRB coal the first conversion candidates; these self-contained movements have the highest likelihood of keeping ECP-converted locomotives available for stand-alone ECP coal trainsets.

### III.3. Installation Economies of Scale and Experience

The conversion costs mentioned above are based on small production volumes for ECP brake equipment and limited installation experience. When the decision is made to begin phased implementation, production will ramp up and more formalized installation arrangements will be initiated. Such volume-based conversion can be expected to reduce—perhaps significantly—the current ECP costs for both freight cars and locomotives.

Throughout this report, the comparisons of benefits to costs are less favorable than they are likely to be in reality, given the expected decline in conversion costs due to economies of scale and experience. While the direction of the anticipated change in costs is clear, it is impossible to project with accuracy the magnitude of the cost decline under large-scale implementation. Determination of these actual prices is another of the data benefits of conducting the initial phase of implementation, such as for a sizeable PRB coal fleet.

### III.4. Anticipated Fuel Savings with ECP Brake Technology

The diverse operating benefits of ECP brake systems discussed in Section II, such as graduated brake release and elimination of power braking and unnecessary train stops and starts, are expected to yield sizeable dollar benefits in reduced fuel consumption. The Class I railroads spent more than \$6 billion on diesel fuel in 2005.<sup>26</sup>

ECP-driven fuel savings are in the range of 5 to 10 percent, as estimated in prior studies and concurred with by the Panel. Using a conservative figure of five percent which is consistent with the experience of Quebec Cartier Mining's ECP operations in Canada (Appendix D), there is the potential for \$300 million in savings from industry-wide conversion to ECP brake systems at current fuel consumption and prices. To put this savings in context, it would support more than \$2.2 billion in initial investment at a rate of return of 12 percent over a 20-year period. Clearly, the potential for fuel savings must be taken into account in the ECP benefit-cost analysis, and procedures must be established for measuring as accurately as possible actual results during the first phase of implementation.<sup>27</sup>

<sup>26</sup> Total fuel spend will continue to escalate. Indeed, if the recent hedged fuel price of one major Class I of \$1.70 per gallon – 40 cents below the non-hedged price -- is applied to the 2004 level of Class I fuel consumption (the most recent publicly available) of 4.1 billion gallons, the resulting fuel bill approaches \$7 billion.

<sup>27</sup> The benefits of various technologies in terms of fuel savings are difficult to measure given the complexities inherent in railroad operations. The greatest opportunity to pin down the magnitude of such savings would be to repeatedly run similar heavy-haul trains of PRB coal in conventional and ECP modes between the same origins and destinations, and measure the resulting fuel consumption.

### III.5. Wheel Savings

Wheels are but one component of a freight car that could provide maintenance savings under ECP operation. However, the sheer magnitude of industry expenditure on wheel replacements warrants singling them out as a significant benefit of conversion to ECP brake system.

A recent study by the Transportation Technology Center, Inc. (TTCI) found that the rail freight industry spends some 37 percent of its annual freight car repair cost of \$1.5 billion on wheel replacements—representing \$555 million.<sup>28</sup> These data are for calendar year 2000, and the costs are undoubtedly higher now, particularly in light of recent industry programs for early detection and replacement of wheel defects.

One of the key findings of this study of wheel life on approximately 2,100 coal gondolas from two North American Class Is and two private car owners is that:

Brake-related failures were found to reduce the life of wheelsets by more than 50 percent, from 393,006 miles on average to 195,406 miles. Using conservative assumptions, the net present value of the costs of brake-related wheel failures for this fleet was estimated in excess of \$8,100 per car, not including the value of out of service time.

Several items are noteworthy from this study. First, a savings of \$8,100 per car would be well in excess of the per-car conversion cost to ECP—estimated at about half that amount. Second, wheel replacement unit costs have risen since the study, which used a per-wheelset cost of \$1,000. Information from Panel 3 indicated that per wheelset replacement costs are now at least \$1,250, and could range as high as \$1,500.

Even using the lower end of this range (\$1,250), the resulting 25-percent increase in per-unit wheel replacement costs translates into a conservative estimate of \$700 million in annual wheel repair expenditures when applied to the year 2000 data.

Despite the TTCI study, the Expert Panel did not feel comfortable assuming that ECP brakes would eliminate **all** brake-related wheel defects. It conservatively settled on half of such defects, which would translate into \$175 million annually for the entire freight car fleet. Heavy-haul, high-mileage cars would account for a disproportionately high share of these savings.<sup>29</sup>

---

<sup>28</sup> *Weibull Analysis of Coal Car Wheel Life*, Tom Guins, Chris Pinney and Patrick Little, November 2004 (TD-04-020).

<sup>29</sup> One of the ways in which ECP contributes to a reduction in premature wheel wear is by lowering the average brake friction temperature on the wheels through more consistent braking. Excessive build up of heat in the wheels is a major contributor to wheel failure. On the South African Railway Spoornet, Wabtec has reported that initial ECP runs with Spoornet's export coal trains showed average wheel temperatures at the bottom of long grades of 89 degrees Celsius (C), with a 99<sup>th</sup> percentile temperature of 139C, compared to wheel temperatures with conventional brakes averaging 110 degrees C, and the 99<sup>th</sup> percentile at 280C. (Wabtec presentation to Panel #1, June 2005)

### III.6. Savings on Brake Inspections

Assuming that FRA granted regulatory relief, the single largest cost savings in the brake inspection category appears to be the elimination of the 1,000-mile intermediate terminal brake test for trains operating in the ECP mode.

Under current regulations, conventionally braked trains are required to stop at a terminal for inspection every 1,000 miles where the brakes on each car are inspected to determine whether they are fully functioning.<sup>30</sup> This requirement is not only expensive in terms of direct inspection cost, but, more importantly, in terms of overall train delay as trains have to be pulled from over-the-road service to queue in congested terminals awaiting inspection.

With ECP brake systems, there is constant wire-based monitoring of the brake condition on all cars and hence no need to “pull over” and physically inspect the brakes every 1,000 miles after initial terminal departure.

There were an estimated 250,000 trains subject to the intermediate terminal brake inspection in 2004.<sup>31</sup> More than 10 years ago, the AAR calculated the cost of the intermediate brake test to be \$450 per train, including both the direct and delay costs of the inspection.<sup>32</sup> Given inflation, and the growing congestion of the rail network, it is conservative to assume that this cost is at least 10 percent greater 10 years later. At \$500 per train for 250,000 trains, the annual cost for the intermediate brake test equals \$125 million.

A second type of air brake test required under current regulations is the periodic single car air brake test (SCABT). The self-diagnostic capabilities of ECP brake systems streamline much of this periodic test, reducing its cost by approximately 75%.<sup>33</sup> Based on AAR data, there are almost 800,000 SCABTs performed on the freight car fleet annually, at a cost of about \$84 per car. If this test were streamlined as indicated, this would translate into an additional savings of approximately \$48 million.

### III.7. Savings on Brake Shoes

In addition to wheelsets, a second freight car component whose service life can be significantly extended under ECP operation is brake shoes. While the unit cost of a brake shoe is small (on the order of \$7), aggregate purchases by the railroads consume a larger spend. AAR data presented at Panel #3 indicate that the railroads spent in excess of \$70 million on brake shoe replacement during a recent 19-month period, or an annualized \$45 million.

Experience with actual ECP operations in the heavy-haul services of the Quebec Cartier Mining Railroad in Canada indicates that brake shoe life can be prolonged by 20 to 25 percent with ECP brake systems. Using the lower savings bound, this equates to another \$9 million in benefits per year.

---

<sup>30</sup> Trains which meet FRA's extended haul requirements are given 1,500 miles between intermediate terminal brake inspections. These requirements limit the number of times a train on extended haul can pick up or set out cars enroute, and impose additional record keeping. Many long-haul unit trains are extended haul trains.

<sup>31</sup> Based on AAR statistics and TTCI estimates.

<sup>32</sup> “*Economic Analysis of Braking Systems*,” Thomas S. Guins, November 1994 (TD94-021).

<sup>33</sup> Ibid.



### III.8. Increases in Network Capacity

One of the potentially most significant benefits of conversion of mainline corridors to all-ECP service is enhanced capacity, without the need for major new equipment or infrastructure investment. In its initial use of ECP brake technology, for example, Spoornet found that it reduced its export coal cycle time by 9 percent.<sup>34</sup>

ECP brake systems permits more rapid over-the-road movement because trains do not have to be artificially slowed or stopped to meet the recharging and lack of graduated release limitations of conventional air brakes. This results in greater throughput even within existing signal block configurations.

Given sharply growing demand for rail freight service, the financial potential of this added capacity for the railroads is substantial. For example, Union Pacific Railroad (UP) recently estimated that, for each 1 mph (or 5 percent) improvement in its overall system average velocity (now about 21 mph), UP saves 250 locomotives and 5,000 freight cars that would otherwise be required.<sup>35</sup> This represents about 3 percent of its locomotive fleet and 5 percent of its total freight cars. At a cost of \$2 million per locomotive and an average of \$50,000 per freight car, this savings represents \$750 million for UP alone.

UP's fleet represents about one-third of Class I locomotives and one-fourth of Class I owned freight cars. Extrapolating the \$750 million in UP savings on this basis to the U.S. Class Is as a group translates into in industry-wide equipment savings of **\$2.5 billion** from a 1 mph gain in network velocity.

No systematic studies have been done in this country on the relationship between ECP train handling and potential gains in average velocity. Establishing linkages between given investments such as in ECP brake systems and changes in average network velocity are likely to be even more difficult than tracking the fuel savings from ECP brake systems. In addition, projected equipment savings from higher over-the-road train speeds need to be managed, or the gains can be lost in added terminal delay.

In light of the Spoornet cycle time experience, however, and the capital expenditure savings at stake, the potential for ECP brake systems to yield capacity gains and equipment savings well in excess of its cost savings in fuel and car components needs to be further explored during the Phase 1 implementation process.

### III.9. Other Cost Savings

There are additional potential cost savings from conversion to ECP brakes that should not be overlooked, even if they are not readily quantifiable.

For example, the wired features that ECP brakes offer to a converted train would likely reduce the costs associated with purchase and maintenance of end-of-train (EOT) devices. ECP brake

<sup>34</sup> Wabtec presentation to the 1<sup>st</sup> Expert Panel, June 2005. Spoornet has made the internal business case for converting its entire export coal fleet of 6,600 cars to ECP. (Information provided at Expert Panel #4 on May 23, 2006.)

<sup>35</sup> Based on information provided at Expert Panel #3.

systems could also reduce excess in-train forces from conventional braking damage couplers and, occasionally, lading, and such damage. Power braking takes a toll not just on wheels but also on the track structure, necessitating changeouts for premature rail wear, which ECP brake systems can also reduce.

The key to monitoring all of the benefits (and costs) of ECP brake systems will be to design a data capture program as part of the initial installation process so that each potential benefit and cost can be addressed in terms of pre- and post-ECP measurement and comparison.

### III.10. Safety Benefits

There are many quantitative unknowns about the safety benefits of ECP brake systems. For example, it is clear that the stopping distance of the longest, heaviest trains with ECP brakes would be reduced by as much as 70 percent relative to the current situation with conventional brakes. For a long coal train with a current stopping distance of almost two miles, that reduction represents a material improvement in safety and potential avoidance of both en route and grade crossing collisions. How future accidents would be preventable with such enhanced safety is difficult to quantify, even if the benefits are real.

One, albeit incomplete, measure of the safety benefits of ECP, however, is the reported damage and injuries from rail accidents in the FRA's database that have cause codes associated with conventional brake failures or human error associated with brake-related train handling. For the five-year period ending in December 2004, there was a total of nearly \$40 million in reportable damage and 18 non-fatal injuries from such accidents.<sup>36</sup>

In addition to preventable accidents, reductions in accident severity are an important benefit of ECP. If a train with ECP can significantly reduce its speed prior to an otherwise unavoidable collision, this could reduce the level of injuries and property damage compared to current outcomes with conventional brakes.

---

<sup>36</sup> Based on Booz Allen analysis of FRA's Office of Safety Analysis Accident/Incident Website.

## IV. Three ECP Implementation Alternatives

FRA's statement of work for this assignment called for three alternatives for implementing ECP brake technology in the U.S. freight rail industry. Based on Booz Allen's analysis, and the work of the Expert Panel, the following three discrete and feasible alternatives are available that advance the status of ECP brake systems within the industry:

1. PRB Implementation Plan
2. One Railroad Implementation Plan
3. New Equipment Implementation Plan

Each of these plans is reviewed in detail below.

### IV.1. PRB Implementation Plan

As noted earlier, an economically rational approach to ECP migration is to tailor the initial installations to rail freight services that have potential benefits most likely to exceed their implementation costs **and** in which a practical migration plan can be fashioned.

Booz Allen believes that PRB coal movements best meet these criteria because they possess each of the following characteristics:

- Are heavy-haul, high mileage
- Use freight cars that remain together in dedicated trainsets
- Are concentrated on selected rail corridors
- Account for a significant percentage of rail traffic
- Have relatively few stakeholder participants in the movements
- Have stakeholders familiar with and interested in ECP issues.

Cars with PRB loads in excess of 100 tons travel an average of 1,100 miles from mine to utility.<sup>37</sup> The trainsets are units that circulate continuously, with coal gondolas averaging in excess of 60,000 miles per year—the highest of any bulk car type.<sup>38</sup> Some 322 million tons of PRB coal moved in 2004 over the 95-mile BNSF –UP joint line in Wyoming, accounting for 130 trains per day, loaded and empty.<sup>39</sup> In addition, another 80 million tons moved on the BNSF's Northern Corridor out of the PRB. The Energy Information Administration of the U.S. Department of Energy has estimated that this volume of PRB coal could double by the year 2025—assuming the railroads can increase capacity to handle it.

PRB coal represented an estimated 26 percent of total Class I revenue ton-miles in 2004, more than a quarter of all rail traffic.<sup>40</sup> The trainsets are often owned by the utilities themselves, or leased by the utilities from major rail equipment financial owners, such as GE Rail Services.

<sup>37</sup> Energy Information Administration, Coal Transportation Rate Database, April 2004.

<sup>38</sup> Based on AAR data analysis for 2001.

<sup>39</sup> Presentation of UP VP and General Manager, Doug Glass, September 27, 2005.

<sup>40</sup> Based on 1.66 trillion revenue ton-miles in 2004 (AAR).

Many of the stakeholders involved in the movement of PRB coal follow ECP developments, and attended one or more of the meetings of the Expert Panel.<sup>41</sup> Both railroads (e.g., BNSF) and utilities (e.g., Southern Companies) have initiated experiments with ECP technology, and also collaborate on rail-related studies where ECP offers significant benefits, such as wheel life.<sup>42</sup> Given the sheer operating scale and stakeholder technology awareness for PRB coal traffic, focusing ECP implementation here makes both economic and practical sense.<sup>43</sup>

There are currently an estimated 2,800 road locomotives and 600 trainsets dedicated to the movement of PRB coal.<sup>44</sup> Thus, less than 10 percent of the industry's locomotive roster, and less than 6 percent of its freight car fleet, are generating 26 percent of its physical activity, measured in revenue ton-miles.<sup>45</sup> This leverage of equipment to output is the most promising entry point for ECP implementation.

One could envision other types of service that meet many of the characteristics discussed above, such as unit train grain traffic or West Coast intermodal movements. However, these services have operating or commercial complexities beyond those of PRB coal, which make them better intermediate stage conversion candidates than first tier ones.

For example, grain train operations involve an extensive unit train elevator gathering network more geographically dispersed than the Southern Powder River Basin coal mining area, and grain tends to move based more on market prices, rather than throughout the year like utility coal. Intermodal traffic, particularly the single largest flows of import containers over the West Coast, is more commercially complex than PRB coal, with numerous third-party logistics providers involved in the movements—hence more parties to bring to the table to discuss the dynamics of ECP conversion.

Significant PRB experience with ECP operation in revenue service would lay a solid foundation for conversion to ECP brake systems in the grain and intermodal arenas, particularly on congested mainline corridors where PRB coal movements compete for track space with other unit train operations. In the aggregate, unit trains of all types account for almost two-fifths of all Class I car-miles,<sup>46</sup> and would be the focus of second-stage conversion to ECP brake systems.

If each of the quantifiable benefits considered in Sections III.4 through III.9 is factored into the analysis, the results become even more significant, as shown in **Table IV-1**. One-time conversion costs of a PRB fleet of 2,800 locomotives and 80,000 freight cars total \$432 million, and annual benefits from fuel, wheel, brake inspection, and brake shoe savings total approximately \$170 million, using the assumption that PRB coal's 26-percent share of total

---

<sup>41</sup> This includes current or former officers of BNSF and UP, representatives of GE Rail and 3 major utilities: American Electric Power (AEP), Ameren Energy, and Detroit Edison (DE).

<sup>42</sup> For example, AEP, DE, BNSF and Norfolk Southern (NS) – which was also represented at the Expert Panel – participated in a wheel life study for coal gondolas published by the Transportation Technology Center, Inc. (TTCI) in November 2004 (TD-04-020). TTCI is also a Panel member.

<sup>43</sup> As another indication of the interest in ECP of coal shippers, the National Coal Transportation Association has scheduled a major session on ECP brakes for the June 2006 meeting of its Operations and Maintenance Committee. The Association includes utilities, coal producers, car and component suppliers and railroads.

<sup>44</sup> Based on extrapolation of BNSF's coal fleet.

<sup>45</sup> Assuming an average of 133 coal cars per trainset.

<sup>46</sup> Based on AAR data for 2004.

revenue ton-miles is a good proxy for its share of total Class I savings in each benefit category.<sup>47</sup>

**Table IV-1. PRB Implementation Plan: Quantifiable Costs and Benefits**

One-Time Costs	Amount (\$ million)	Annual Benefits	Amount (\$ million)
Locomotive Conversion	112	Fuel Savings	78
Freight Car Conversion	320	Reduced Wheel Defects	45
		Brake Inspection Savings	45
		Brake Shoe Savings	2
<b>Total</b>	<b>432</b>	<b>Total</b>	<b>170</b>

Even if the entire \$432 million conversion cost were sustained in the first year of the implementation—an impossible result from the standpoint of physical conversion capacity—the payback period is a less than three years and the internal rate of return equals nearly 40 percent measured over a 15 year life.<sup>48</sup>

Booz Allen conducted a more detailed, risk-adjusted analysis of this alternative using VMM, which assumed a three-year equipment conversion period. The results are contained in Appendix E and indicate even at the highest of the three discount rates:

- A payback period of 3 years (i.e., 2011, if the conversion program begins in 2008)
- An IRR of 47 percent
- An NPV of almost \$700 million

In effect, conversion of PRB coal services to ECP brake technology is a “showcase” conversion not only because it is significant in size and appears to be financially sound, but also because it involves all of the five stakeholder groups and creates railroad operating benefits and efficiencies in a premier area of railroad service vital to the Nation’s energy generation. Successfully implementing a plan for ECP brake technology in PRB coal services would create a model for conversion of the next set of major services, such as intermodal, auto, or unit train grain.

## IV.2. One Railroad Implementation Plan

This second implementation alternative is a scaled-down, reduced-risk version of the first. The primary differences between it and the first plan are:

1. It would be limited to one railroad to reduce the initial conversion complications of having more than one road and the interline movements involved, with their potential risk for ECP locomotive availability problems.

<sup>47</sup> Costs which do not change as between conventional and ECP operations – such as brake maintenance -- are not properly part of the quantitative analysis.

<sup>48</sup> An industry-wide fuel bill approaching \$7 billion would add \$13 million in annual benefits to the data in this table.

2. It would be confined to railroad-owned freight cars to remove issues associated with potential conversion cost sharing between the roads and private car owners.

In Booz Allen's view, this implementation alternative should only be undertaken if the PRB Implementation Plan is found to be too ambitious for initial conversion. In essence, with the One Railroad Implementation Plan, a willing Class I railroad would work closely with three of the other stakeholders (the AAR, FRA, and the brake suppliers) to further test and validate the costs and benefits of ECP technology in a larger set of controlled single line revenue movements than those that have been conducted to date in the various experiments on the U.S. Class I's.

The principle advantage of this alternative relative to the PRB Implementation Plan is that it is simpler to execute. The primary disadvantage is that it is less of an initial conversion and more of a continuation of the string of experiments carried out to date.

On balance, it could send a negative signal to the rail community that ECP brake technology is not really ready for broad implementation, but remains to be further proven in discrete settings by a Class I "volunteer." As such, it is somewhat of a "running in place" relative to the proof of concept testing of ECP technology that has been done in North America and overseas.

Booz Allen's view is that this alternative is inferior to the PRB Implementation Plan, but is superior to the present state of ECP stagnation if, for some mix of reasons, the stakeholders cannot coalesce to execute against the first alternative.

Assuming that the single railroad service(s) chosen for inauguration under this alternative are heavy-haul, unit-train type services, the benefit-cost result should be favorable, just as it is under the first alternative. However, from an absolute standpoint, the financial benefits would be much smaller, given the inherent limitations of the scope of services to be converted.<sup>49</sup> In any event, pre-planned data capture and reporting would also need to be conducted under this alternative to provide the analytical foundation for future conversion.

### IV.3. New Equipment Implementation Plan

The third implementation approach is not oriented to discrete rail freight services like the first two approaches, but rather to ensuring that all new equipment coming into the fleet—both locomotives and cars—is ECP compatible. The strategy underlying this alternative is to establish a sustained rate of introduction of ECP-compatible equipment into the fleet—without incurring the cost of retrofitting existing equipment—until conversion is complete.

In this alternative, all five stakeholders (i.e., railroads, private car owners, brake suppliers, FRA, and the AAR) would need to reach agreement on an ECP conversion schedule for new equipment. Key decisions to be made under this alternative include:

- **The Pace of New Locomotive Conversion:** This is a critical determinant of the conversion process under this alternative because the rate at which ECP locomotive availability is achieved is the most important single factor driving the level of ECP operations. This is due to the relatively free running nature of most locomotive pools in which realizing high levels of locomotive utilization is more important than dedicating expensive power to specific trains or

---

<sup>49</sup> For example, a broader and longer use of ECP in BNSF's coal, grain, taconite or intermodal services, which were the focus of earlier BNSF experiments as referenced in Appendix D, would be one illustration of this alternative.

corridors. For this alternative to result in pronounced ECP conversion in any reasonable multiyear timeframe, a more aggressive deadline for all new locomotives to be ECP equipped than the corresponding deadline for freight cars may be required.

- **Stand-Alone versus Overlay versus Kit Only Conversion:** This is the mix of new freight cars that will fall into one of the following three categories:
  1. Cars that are equipped only with the ECP brake system and cannot operate without ECP locomotives
  2. Cars that are dual equipped to operate in either the conventional or ECP brake mode, which adds to their operational flexibility, but requires the increased installation cost and maintenance of two brake systems
  3. Cars that are conventionally equipped but that also have the core ECP conversion kit added as part of the original equipment manufacturing process to reduce the cost and time required for later full conversion to ECP brake technology.
- **The “Cutover” Point:** This refers to the mandatory timetables by which new locomotives and equipment will have to meet the ECP conversion standards. As such, this point represents the beginning of the end of the non-ECP era, for no new equipment will be allowed into the industry without satisfying whatever level of ECP requirements are established for it.

Compared to the first two service-based alternatives, this approach is:

1. More flexible in the sense that the industry itself would determine the pace and service focus of ECP conversion by its locomotive and freight car purchases
2. More discretionary in that railroad and private purchasers of freight cars could determine which of the three types of cars they would order, dependent upon their expectations for use in ECP or conventional trains
3. Less expensive from an installation standpoint in that there is no expectation for the need to retrofit existing equipment; the focus is entirely on the new parts of the fleet
4. Less determinable from a benefit-cost standpoint in that the specific conversion process for discrete types of train services would be left more to market forces and the decisions of individual railroads and equipment providers.

In Booz Allen’s view, this alternative could be a stand-alone approach, or could also be used in combination with either the first or second implementation plans, because it is complementary to each of them. In addition, a timetable for conversion of new equipment to ECP technology should be regarded as the minimum baseline for any serious approach to ECP conversion. As long as new equipment with expected service lives measured in the decades is allowed to continue to come into the U.S. rail freight industry without being ECP compatible (at least in terms of a core conversion kit), the prospect of widespread migration to ECP technology remains fixed in neutral.

## V. Conclusions and Next Steps

Booz Allen’s review to date as part of this study and the three meetings with the Expert Panel indicate that ECP brake systems are ripe for adoption, both technologically and financially. The seven principles for ECP implementation, reviewed in the Executive Summary of this report, are critical to overcoming the multiyear stalemate on such implementation.

As indicated in **Figure V-1**, successfully broadening the “pyramid” of ECP operations in the U.S. freight rail industry beyond the current tip of experimentation is also dependent on careful selection of the initial conversion platform—a key ingredient of any implementation alternative.

**Figure V-1. ECP Conversion**

**Thoughtful design of the initial ECP conversion is critical to the success of later stages and eventual widespread adoption of ECP**

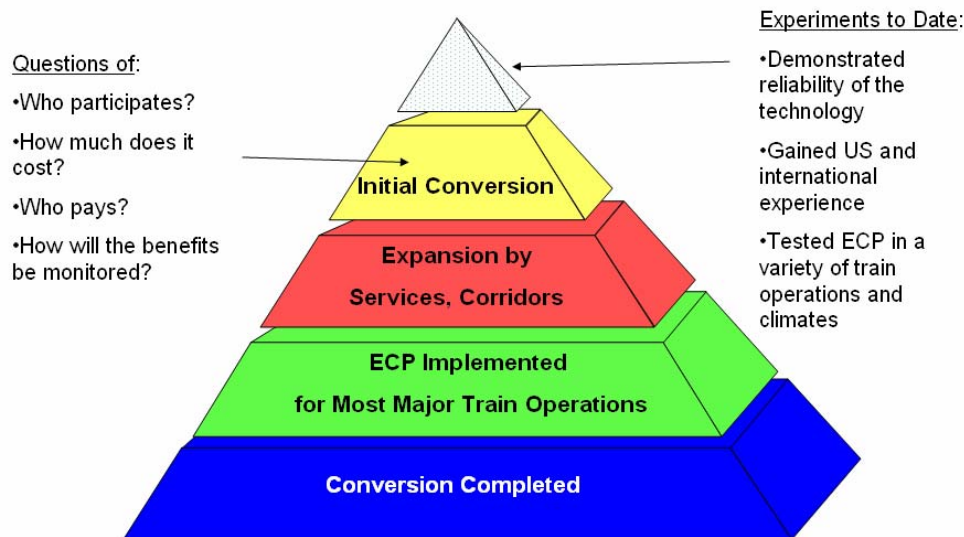

For reasons previously documented in this report, the first choice for that initial platform should be PRB coal. As discussed in the Executive Summary, the five stakeholders now must extend their effective work on the Expert Panel to reach agreement on a detailed vision for complete conversion and how the initial and intermediate stages of conversion fit into that overall plan. Thereafter, Phase 1 implementation should begin.



Developing the benefits and costs of a complete implementation plan for ECP over a three-phase timetable of, for example, 15 years as discussed in the Executive Summary, requires data not presently available to Booz Allen. Primarily, these data involve a disaggregation of the output (for example, in revenue ton miles) and equipment (locomotives and freight cars) of other unit train operations, just as was developed for PRB coal.

These other unit train operations include:

- non-PRB coal
- grain
- intermodal
- automotive
- ores, aggregates and minerals

Because these movements are not as geographically and operationally segregated as are PRB unit coal trains, it is not possible to determine the ratio of equipment to output as was done for PRB coal. But these data are key to determining benefits and costs for Phase 2 of the conversion, the residual of equipment and operations that would remain for Phase 3 conversion, and the overall benefits and costs of the complete three phase program.

It is possible that, through working with the AAR, FRA and perhaps the individual railroads the necessary data can be developed on a non-proprietary basis (such as aggregating across individual Class I railroads) to develop the information needed for Phase 2.

## Appendix A. Railroad Braking Technology: The History and Advances

### Historical Development of Railroad Air Brake Technology<sup>50</sup>

#### Post Civil War Period

The development of air brake technology as an industry-wide norm, began with standardization work following the Civil War. Efforts during the Civil War to move men and equipment over long distances and several railroads highlighted the differences between the railroads in areas such as gauge, braking, grades, couplers, and more. Efforts to create standardization in braking began shortly after the war ended.

Braking in 1860 consisted mostly of allowing the inherent friction of the bearings to bring the train to a gradual stop. In emergencies, or on grades, mechanical brakes would be applied by brakemen scampering over the tops of cars and turning handbrake wheels at the end of some cars (not all cars had brakes). Turning the handbrake wheels tightened the handbrake rigging under the car, forcing cast iron or wrought iron brake shoes against the wheel.

During this period, braking was applied slowly and unevenly throughout the train. Turning the handbrake wheels was time consuming due to the high multiplication ratio necessary to apply the generally accepted braking force. Consequently, the first cars to which the brakeman applied force did most of the braking, causing brake force to vary widely among braked cars. In addition, the brake forces also varied from one axle to the next on the same car, increasing wheel slides.

In the early 1870s, several improvements arrived in the delivery and application of the brake force that drastically changed railroad braking. They included power brakes (air power) and inside hung balanced metallic brake beams. These technical advances greatly increased the speed of brake application, the amount of force, and the evenness of the brake force between wheels.

#### PERFORMANCE

- 10 to 20 mph

*End of the 1870s*

#### TECHNOLOGY

- 25,000 lb fully loaded car weights
- 300 to 500 hp steam engine
- Braking by inherent friction and brakemen
- Not all cars braked, no uniform brake rate

<sup>50</sup> Most of the material for this section on the history of air brake technology, whether a direct quotation or not, was obtained from Engineering Design of Railway Brake Systems, Rev. 2, 2004, copyright 1975 Air Brake Association.

## Straight Air Brakes

Beginning in 1870, straight air brakes used air power stored in a *main reservoir* on the locomotive. When brakes were called for, it delivered the air through a *brake pipe* to *brake cylinders* on each car. The pressure on the *brake cylinder* piston rods then provided the force to the *brake rigging* which applied the *brake shoes* against the wheel.

Straight air brakes could be gradually applied or released. As the train slowed down, and the coefficient of friction increased, the brakes could be “graduated off” in order to keep the train braking force at a comfortable nominal level. A maximum of about twelve 50-foot cars could be handled by straight air brakes.

Straight air brakes had several critical disadvantages. First, for example, even though faster than the brakemen, the time required to push the volume of air necessary to fill all of the *brake cylinders* on every car of the train through a single *brake pipe* was significant. Second, if the *brake pipe* broke, air would be exhausted, and the brakes released.

## Automatic Air Brakes

From 1873 to 1875, George Westinghouse solved both of these problems by 1) storing the air in an *auxiliary reservoir* on each car, which reduced the time from reservoir to *brake cylinder*, and 2) turning the *brake pipe* into a normally charged pipe that applies brakes as pressure drops, which makes it an inherently safe system even if the brake pipe is broken. Exhaust of the brake pipe would result in application of brakes. This was made possible by the use of a *triple valve* (later known as the *plain triple valve*).

The *plain triple valve* has three functions. Based on the pressure of the brake pipe, it will 1) charge the reservoir from the brake pipe, 2) apply air to the *brake cylinder* from the reservoir, and 3) exhaust the air from the *brake cylinder* to atmosphere. A much lower volume of air is required to flow through the train to lower the pressure as a signal to the *plain triple valve*, in order to apply the brakes. It still takes considerable time to recharge the *auxiliary reservoirs* after brake applications. The triple valve was developed for 50 cars with 34 feet of brake pipe per car (1,700 feet), thus greatly increasing train lengths and use of rail line capacity relative to prior brake technology.

The basic relationships between brake pipe pressure and brake cylinder pressure were set at this time. With a 70 psi brake pipe, a 20 psi reduction would result in a 50 psi brake cylinder pressure. Larger brake cylinders and different lever ratios in linkage would result in different brake shoe forces.

### **AUTOMATIC AIR BRAKE DESIGN (1870s) set the standards**

- **70 psi charged brake pipe**
- **20 psi reduction resulted in 50 psi in brake cylinder**
- **Brake Ratio: 100% of empty car weight at 50 psi**

The best term to describe braking levels is brake ratio. The actual braking on the car varies as the shoe-to-wheel coefficient of friction varies with speed and conditions. The term brake ratio means the total of the forces on the brake shoes of a car, divided by the weight of the car. Loaded brake ratio would be the forces on the brake shoes divided by the loaded weight of the car, and empty brake ratio would be divided by the empty weight of the car.

One drawback of the plain automatic triple valve was that it had only direct release. That is, once a brake application had been made, whether it was 100, 50, or only 25 percent of the maximum effort, the only way that the brake effort could be reduced is to go directly to brake release. There was no possibility to reduce the brake effort to some intermediate lower level of braking, referred to as graduated release. With a direct release, there was also a time required for all reservoirs to recharge before brakes would reset and could be fully operable again.

This made train handling difficult on long grades—a problem that continues to this day. No grade is perfectly uniform, and when the grade decreases over a section, the brake pressure cannot be reduced to maintain speed, so the train slows down. Brakes may not be released for fear of a train “running away” before the brakes could be fully recharged and fully reapplied. If brakes were applied for a long time, the normal brake pipe leakage would affect an ever-increasing brake effort on the cars until eventually the train stalled.

Advances in brake beam and truck designs in the same period include the inside hung brake beam, symmetrical brake rigging with equal forces to all wheels, flexible connections between power brake and handbrake, and the metallic brake beam. These advances served to equalize the braking forces between wheels, reduce the effect of truck spring deflection on brake forces, and allow higher and more uniform brake forces.

## Grade Handling With Automatic Air Brakes

To begin to address the grade handling problems of the triple valve, George Westinghouse invented the *pressure retainer* in 1883. The *retainer* would hold a minimum pressure in the *brake cylinder* while allowing brake release and recharging, so that the train was always charged and ready for brake application. The retainer was a *check valve* in the *brake cylinder exhaust* that maintained no less than a 15 psi pressure level in the *brake cylinder* regardless of the *brake pipe* pressure level. *Retainers* were used for descending long grades where leakage might have an impact. The *retainers* had to be set on each car, by closing a one-fourth inch cutout cock, before descending the grade, and then had to be released at the bottom of the grade. If any sections in the middle of the grade required less than 15 psi to maintain safe speed, there was no way to reduce the *brake cylinder pressure* below the *retainer* setting, and trains simply slowed down.

## Quick Action Automatic Air Brakes

Over the years, the automatic air brake system made constant incremental technological advances, all in an attempt to overcome shortcomings that constrained the length of the train, or the speed of the train. From the triple valve of 1875, the *quick action triple valve* was designed in 1883 to sense the rate of reduction of *brake pipe* pressure.

The *quick action triple valve* would then allow *brake pipe* air to directly enter the *brake cylinder*, thus accelerating the *brake cylinder* pressure build up, although less controlled, and it would vent *brake pipe* air locally, thus accelerating the brake signal to the next car. This action, called an *emergency brake*, increases the pressure in the brake cylinder above normal service,

increases the speed of the brake cylinder build up, and increases the speed that the signal is transmitted through the train. This emergency brake function still uses air from the auxiliary reservoir which can be depleted after extended service braking—a problem that is solved in later changes.<sup>51</sup>

## High-Speed Automatic Air Brake

The *high-speed automatic airbrake* is a modification of the *quick action airbrake* or *quick action triple valve* to adapt to higher train speed operation. The coefficient of friction between the wheel and brake shoe changes with speed, while the adhesion between the wheel and rail remains constant. When the brake friction force on the wheel exceeds the adhesion level, the wheels will slide. In lower speed freight operation, the range of speeds and corresponding friction is small enough that a single braking level is sufficient. In higher speed operation, the coefficient of friction becomes so small that it would take an excessively long time to brake the train with the low speed brake ratio.

In order to brake the train in a reasonable and safe distance, there needed to be a higher brake ratio at high speeds that reduced at lower speeds. To this end, the *high-speed airbrake* included a *high-speed reducing valve* added to the *brake cylinder*. The *high-speed reducing valve*, developed in 1894, compensates for the difference in the coefficient of friction between high speed and low speeds by allowing a higher cylinder pressure for a period of time, and then reducing that to a lower pressure. This enabled smooth stops for high-speed trains of 60 to 80 mph, was better than repeated application and release of brakes but was best for a specific speed and braking effort, and still required a release of brakes at the very low speeds.<sup>52</sup>

### PERFORMANCE

*End of the 1890s*

- Train capacity 1,000 to 1,500 tons (50 cars, 20 to 30 ton cap.)
- 25 mph

### TECHNOLOGY

*End of the 1890s*

- 1200 hp steam engines, pulling 2,000 to 2,500 trailing tons
- Quick action automatic air brakes (1889), and 2,000 ft trains
- Brake Ratio: 70 percent of light weight

## Graduated Release

“In 1906, passenger and freight brake equipment parted company once and for all with the development of the graduated release passenger triple valve or the type L (triple valve).”<sup>53</sup> The graduated release function was important to smooth braking efforts on high-speed passenger trains, in various speed and braking conditions. With graduated release, braking forces could be controlled by the operator by reducing cylinder pressures gradually as the train came to a stop. Graduated release did not work on trains with brake pipe lengths over 1500 to 2000 feet, so freight braking had to retain direct release.

<sup>51</sup> “The Air Brake and Train Air Signal, Operation of Locomotive Equipment”, No. 99-A-3, Copyright Pennsylvania Railroad, Issued March 1, 1916, page 8 – Quick Action Automatic Airbrake.

<sup>52</sup> Ibid, page 9 - High Speed Airbrake

<sup>53</sup> Ibid Engineering and Design of Railway Brake Systems, page I-19

The type K-triple valve, for freight, was developed in 1906, and extended train length from 80 to 100 car trains with 41 feet of brake pipe per car (4,000-foot brake pipe).

<b>PERFORMANCE</b> <ul style="list-style-type: none"><li>• Train Capacity: 3,000 tons (100 cars, 30 ton cap.)</li></ul>	<b>End of 1910s</b>
<b>TECHNOLOGY</b> <ul style="list-style-type: none"><li>• Type K Triple Valve</li><li>• 4000-foot trains (80 to 100 cars, 41 feet each)</li></ul>	

### The Interstate Commerce Commission (ICC) and the Automatic Brake (AB) Valve

In the 1920s, the ICC instigated development and testing of a new air brake valve with the following goals:

- An emergency brake application is always possible, even after fully depleting the auxiliary reservoir through train handling and leakage. This emergency brake application is made possible by having a second protected reservoir for emergency only. The auxiliary reservoir supplies the brake cylinder in service braking; the emergency reservoir is used for emergency only.
- Emergency brake application is at a controlled pressure level higher than full service braking. This is accomplished by a separate emergency valve portion with its own set of pneumatic logic, valves, and reference volumes.
- Brakes are capable of graduated release—that is, the ability to reduce a brake pipe pressure and corresponding brake effort without having to go to a full release position and wait to recharge the reservoirs and reset the brakes.

<b>Goals for the AB Valve</b> <ol style="list-style-type: none"><li>1. Emergency brakes always available</li><li>2. Emergency brake at controlled higher level</li><li>3. Graduated release of brake applications</li></ol>
---

At this point in time, freight trains were already at 100 cars and 5000 feet of brake pipe.

After five years of testing by the AAR at Purdue University (from 1924 to 1929) and several years of field testing (from 1929 to 1931), it was decided that graduated release would not work on freight trains. “Graduated release was tried in field tests on trains of 70 cars and it was found to be impossible to adequately control trains on grades without stalling, hot wheels, or stuck brake problems. Graduated release as a freight brake function was dropped, and direct release was retained...”

This failure to achieve graduated release for freight brakes still impacts the industry today. With the failure of graduated release comes train handling and grade handling issues and the safety issues of direct release, recharging time, and leakage.

The AB brake was approved in 1933, and brought significant advances to freight braking including:

- Emergency brake available after depletion of service brake
- Emergency brake at 20-percent higher pressure than service brake
- Graduated release for the typically short passenger trains.

However, it did not bring the desired graduated release function needed for better train handling and safety of long freight trains.

**One of the ICC proposed specification requirements was for a graduated release function ...**

**“[After unsuccessful field testing] Graduated release as a freight brake function was dropped, and direct release was retained for long trains.”**  
*Engineering and Design of Railway Brake Systems*

An incidental change resulting from the AB valve development was in the brake system pressures. Brake designs before the AB valve had been calculated for cars based on 50-psi brake cylinder pressures, and brake pipe pressure of 70 psi. As a result of the AB valve development, brake cylinder pressures of 60 to 90 psi were possible based on a brake pipe pressure of 90 psi.

### Efforts to Reduce In-Train-Forces

In-train forces result from differences in the braking of the various cars in the train. Shortly after the Civil War, trains consisted of some cars that were braked, and some cars that were not braked at all. Railroad in high-grade areas may have required a higher percentage of cars braked. Clearly, cars that are not braked are going to “run-in” to cars that are braked. The uneven braking between cars results in coupler forces in draft (pulling on couplers) and buff (pushing on couplers). These cause damage to the car equipment, to the lading, potential delays upon break-in-two, and both costly and dangerous derailments.

Cars will brake evenly and in-train-forces will be the least when: 1) cars brake at the same time and 2) cars brake with the same brake ratio. As discussed earlier, brake ratio is the ratio of the braking shoe force on the wheel per the weight of the car. An even braking ratio on all cars throughout the train promotes lower in-train-forces.

The brake ratio can be specified because it is a constant of the brake system. A specified pressure in the brake cylinder will apply a specific force on the brake shoe against the wheel.

The actual braking effort or force retarding the car cannot be specified by car design because it varies with the speed of the car and the heating of the wheels. However, since all the cars in the train are traveling at the same speed, and all the wheels have been heated similarly, the variation is assumed to affect all cars in common, and its effect on uneven braking between cars can be disregarded.

Even after all cars were required to be braked, the braking efforts and ratios of all the cars were not often the same. The differences in braking efforts and resulting in-train forces caused damage, delay, and danger.

In addition to technological efforts to speed up the brake application signal in order to brake the cars more closely in time, regulatory efforts were being made to reduce the variation between the brake efforts of cars, in order to further reduce in-train forces.

Technology brought about lighter weight but stronger alloy cars. This meant that the ratio of the loaded weight to empty weight was growing. This was a problem that was unique to freight, as passenger cars had a much smaller change from empty to full load, given the relatively small weight gain of a full passenger train relative to an empty one.

If brake cylinder pressures were set to meet a specific braking effort in the loaded condition, then the braking effort may be too much, and the wheels may slip when in the unloaded condition. On the other hand, if pressures were set to meet a specific braking effort in the unloaded condition, then the braking effort at the fully loaded condition would be much lower and the car may run-in to the car in front of it.

In 1936, only minimum brake ratios were specified. Loaded brake ratios were limited to a minimum of 20 percent at 50-psi brake cylinder pressure, and the resulting empty brake ratio was not specified. However, in 1941, both maximum and minimum brake ratios were specified. Requirements were changed to 75 percent maximum for empty cars, and 18 percent minimum at the axle load limit (maximum permissible weight), at 50 psi reference pressure. This represented a move to bring the brake ratios, in a typical train of mixed cars, closer together to reduce the in-train forces.

**BRAKE RATIO – 1941**  
**Minimum 18% (Loaded)**  
**Maximum 75% (Empty)**

Empty/load equipment was developed in order to enable the car to switch the cylinder pressure, and resulting brake ratio, based on whether the cars were loaded or unloaded. Cars with “empty/load” equipment that could be switched to two different brake ratios were restricted to not more than 50-percent empty, and between 27 and 33-percent loaded. The differences between the extremes of braking ratios got closer.

**CARS WITH EMPTY LOAD EQUIPMENT – 1941**  
**Minimum Brake Ratio 27 to 33% (Loaded)**  
**Maximum Brake Ratio 50% (Empty)**

Brake ratios changed again in 1960 to allow for larger 70-ton and 100-ton capacity cars. New limits were 75 percent preferred (80 percent maximum) empty and 20 percent preferred (18 percent minimum) loaded at 50-psi reference.

Brake ratios changed again in response to the introduction in 1955 of composition brake shoes, which replaced cast iron brake shoes. Composition brake shoes have about twice the coefficient of kinetic friction as cast iron shoes. Friction on composition shoes varies less with speed, so they are less likely to cause wheel slides at lower speeds.

Brake ratios changed again in response to the introduction in 1955 of composition brake shoes, which replaced cast iron brake shoes. Composition brake shoes have about twice the coefficient of kinetic friction as cast iron shoes. Friction on composition shoes varies less with speed, so they are less likely to cause wheel slides at lower speeds.

### Automatic Brake Valve Enhancements (1930s – 1990s)

In 1964, the ABD valve (an improvement over the AB valve) was introduced, bringing with it a more modern valve construction. It included an accelerated service release function, which used



a serial propagation of a release signal to obtain faster release time on long freight trains. This allowed running releases at low speeds, which greatly improved train handling.

The ABDW valve incorporated improvements that greatly accelerated emergency brake application, including:

1. Decreased in-train forces in emergency by a more synchronous braking of all cars
2. Decreased overall stopping distances in emergency, increasing the rapidity of emergency application, thereby improving rail safety.

The ABDX valve / DB-60 valve changes incorporated in 1994 involved changes in internal valve construction to increase brake signal transmission rates.

An A-1 reduction relay valve was added for cars with over 100-foot brake pipe length, which also improved brake build up times.

<p><b>PERFORMANCE</b></p> <ul style="list-style-type: none"> <li>• Train Capacities up to 7,000 to 11,000 tons                     <ul style="list-style-type: none"> <li>– 70, 100, and 125-ton car cap., 50 to 90 ft. cars</li> </ul> </li> <li>• Speeds to 80 mph</li> </ul> <p><b>TECHNICAL</b></p> <ul style="list-style-type: none"> <li>• 10,000 to 16,000 hp tractive power, from multiple units                     <ul style="list-style-type: none"> <li>– Train trailing tons of 4,000 to 15,000</li> <li>– 263,000 to 286,000 lb loaded car weight</li> </ul> </li> <li>• ABDX or DB-60 control valves (1994)</li> <li>• Train Length 5,000 to 8,000 ft.</li> <li>• 26-L pressure maintaining locomotive automatic air brakes</li> <li>• High friction composition brake shoes</li> <li>• Truck mounted direct acting brake equipment</li> <li>• Inter-train, remote controlled, distributed locomotives</li> </ul>	<p><i>End of the 1990s</i></p>
--	--------------------------------

## Summary of Developments

The efforts in railroad brake development have retained the same focus since the first initiatives in the post Civil War period—how to improve capacity, efficiency and safety. The details involve the more obvious variables such as freight car carrying capacity, train length, maximum speeds, train handling, and others that all relate back to the primary goals.

Technological advances in other train components have increased the stakes for braking technology. Technological advances in materials increase carbody strength and carrying capacity, increasing weight. Technological advances in bearings and in wheel resistance reduce drag, and technological advances in locomotives increase engine efficiency and power—increasing speed and train length. Unless brake technology can safely stop heavier, longer, and faster trains, these advances are limited. As documented, brake demands and technology have advanced from the late 1800s to today (see **Table A-1**).

**“Brake technology must advance in parallel to the car and locomotive advances in order for the potential capacity, efficiency, and safety benefits to be fully realized.”**

**Table A-1. 100 Years of Railroad Advancement**

	1890s	1990s
Train Capacity	1,500 tons (50 car x 30 ton)	7,000 tons (115 cars, 70/100/125 ton cars)
Train Speed	25 mph	80 mph
Motive Power	500/800 hp steam, (2,000 trailing tons)	10,000 to 16,000 hp diesel (4,000 to 15,000 trailing tons)
Brake Technology	Quick Action Automatic Airbrake, (2000 ft train) (50 car x 40ft)	ABDX or DB-60, (5,000 to 8,000 ft train) (115 cars, 65 ft, -7,500 ft coal train)

Advancements have also been made in brake technology to facilitate better performance, higher speeds, and longer trains:

- Faster propagation of
  - service brake signal through brake pipe
  - emergency brake signal through brake pipe
  - brake release signal through brake pipe
- Faster actuation of
  - Brake applications and releases, once the signal is received
- More even braking from axle to axle
  - Inside mounted brakes 1870s
  - Truck mounted brakes 1990s
- Grade handling solutions
  - Retainers

However, since the inception of automatic air brakes by George Westinghouse in the 1870s, brake signal propagation has been limited by the nature of air and the speed of sound. Other adjustments have sought to alleviate this deficiency, but have left the basic system unaltered. ECP brakes radically alter the propagation causing it to be limited not by the speed of sound, but by the speed of light.

### **ECP Brakes: The Latest Development**

ECP brakes overcome this physical limit by using electrical transmission of the braking signal through the train, but still use air pressure in the cylinder to apply the force to the brake shoe. There are two slightly different arrangements of ECP systems that both meet AAR standards. The first is the stand-alone system, which replaces the pneumatic logic completely, and enables the cars to only be operated in ECP mode. The second is the overlay system, which overlays the ECP logic on top of the existing pneumatic logic, and allows the car to be operated either in ECP mode or in conventional pneumatic mode, thus ECP-equipped cars can be hauled in a train operating with conventional brakes.

Compatible ECP equipment must be installed on the locomotive as well as on the car. The main components of the ECP system on the cars include:

- Car Control Device (CCD), which includes combined electric and pneumatic logic and controls air to the brake cylinder as long as brake pipe is intact
- Vent valve to rapidly vent brake pipe air during an emergency, and accelerate transmission of a pneumatic emergency down the train
- Identification Module (IDM), which contains the car identification
- Two conductor 230 Vdc trainline cable, conduit, junction boxes, and inter-car connectors for 230 Vdc power and for communications
- Brake cylinders, linkage, truck-mounted brake units (as for conventional brakes)
- Brake pipe, cut out cocks, connecting hoses, and fittings (as for conventional brakes).

The CCD derives power from the 230 Vdc trainline, as well as communicates through it. The CCD includes its own battery, which the 230 Vdc charges. The brake pipe provides a constant source of charging air for the air reservoirs on the car even when brakes are applied.

The pneumatic emergency brake is always active as a back-up function if the brake pipe falls below a set pressure, and the car equipment includes a vent valve to both vent the brake pipe and accelerate transmission of the pneumatic emergency signal.

## ECP Brake Functional Improvements

ECP brake systems increase brake signal transmission rate. One of the main goals of advancing brake technology has long been to decrease the time of the brake application signal along the train. The time for the signal to reach the last car of a train noticeably increases with the length of the train since the signal is transmitted by airflow, moving often at about two-thirds the speed of sound. Since the development of the automatic air brake in the late 1870s, the ECP brake system is the greatest leap in braking technology because it transmits the signal electrically, traveling at the speed of light. Compared to the pneumatics and all other variables in the system, the signal is instantaneous, allowing even brake pressure to be applied at the same time to all cars on the train. One hundred years of advancement have been working towards this achievement.

ECP brake systems also control the brake application rate. Once the car receives the signal, the rate at which the air is applied to the cylinder, or the rate at which the pressure is built up, is controlled so that cars are very close to the same percentage of brake cylinder pressure at any point in time during the build up. This goes even further toward reducing in-train forces caused by transient differences in cylinder pressure during build-up.

Constant charging of reservoirs is possible because, under normal conditions, the brake pipe acts as a reservoir supply pipe. The brake application is signaled electrically, and not by reducing brake pipe. So the brake pipe continuously supplies the reservoirs. Whether the brake application is a gradual release (see next paragraph) or a sudden total release, the reservoirs are always recharged, and there is no waiting.

Graduated release is possible for long freight trains using ECP brakes. After 100 years of development, and several attempts at achieving graduated release for freight, ECP brakes enable graduated release by allowing the brake pipe to constantly charge the reservoirs. Graduated release is the ability to reduce the brakes to a lower braking level after making a

brake application. This makes it possible to adjust the braking level to more closely follow the safe speed limits. Under conventional brake operation, once the operator has chosen a brake level, it cannot be reduced without completely releasing and resetting the brakes, which can only be done safely at very low speeds. In many cases, this leads to a forced stop. It may also lead to the operator making less of a brake application than needed initially, because it is always possible to add more pressure, but not to reduce it once applied.

Real-time train status reporting is possible utilizing the ECP brake systems communications to transmit information from each car back to the locomotive.

Train handling improvements with ECPolicy: TBDP brakes add significant improvements in capacity, efficiency, and safety.

## Capacity

Train capacity is improved in several ways, including the following:

- Higher average speeds are possible, in some cases, due to higher maximum speeds, but in all cases, due to a better ability to follow the safe speed limitations. Graduated release allows the operator to reduce the brake application when it is too severe. Thus, there is no need to travel any distance at too slow a speed because of the inability to make a brake release.
- Longer trains are possible, with distributed power, due to the uniform braking and reduced in-train forces (e.g., Quebec Cartier Mining up to 182 cars).
- The communications system of the ECP brakes supports distributed power communications by wire, aiding in increasing train size.
- Delays are reduced due to the virtual elimination of undesired emergency brake applications based on field experience.
- Setting retainers on severe grade becomes unnecessary, and the time delay for setting them is eliminated.
- Inspections mandated by federal safety regulation may, pending realignment of regulations to account for ECP, allow automatic intermediate terminal brake inspections, eliminating the need for manual intermediate terminal brake inspections.

## Efficiency

Train efficiency is improved in several ways, including the following:

- The reduction in inter-train-forces reduces damage in two ways—the outright breakage of couplers and knuckles due to excessive force and the gradual fatiguing of coupler knuckles due to oscillating longitudinal forces that result from inter-train-forces are almost completely eliminated.
- Wheel damage is reduced due to more uniform braking and better train handling.
- Component condition feedback leads to reduced maintenance costs because it utilizes condition-based maintenance (CBM) rather than time-based maintenance.

- Pending realignment of regulations to account for ECP, inspections may allow less costly automatic inspections, and may allow higher levels of non-operating brakes based on the real-time feedback of any further brake malfunctions.

## Safety

Train safety is improved in several ways, including the following:

- With faster transmission of the brake signal, faster stops are possible.
- With virtually simultaneous application and uniform build up of brake cylinder pressure, run-in between cars braking at different speeds and the potential for derailment is greatly reduced.
- With graduated release, train operators have more flexibility in applying and releasing brakes, are less likely to under brake, and do not have to go to a full release to reduce the brake level.
- With continuous charging of the reservoirs, there is never a waiting period after brake release, when the brakes are not available or the application is made complicated. Brakes can be reapplied immediately after they are released.
- Improvements in grade handling include:
  - Eliminating the requirements for retainers
  - Graduating application and release allows the use of dynamic brake for base brake level supplemented by friction to adapt to changing grade
  - Constant charging.

## Appendix B. Expert Panel Members

Name	Company	Title
Pat Ameen	AAR	Assistant VP Technical Services
John Anderson	ZEFTRON	General Manager
Robert Blank	Norfolk Southern	Director, Research and Tests
Tom Bouve	FRA	Operations Research Analyst
Dennis Buda	Detroit Edison	Manager Railcar Maintenance
Olga Cataldi	FRA	Senior Electronics Engineer
Chris Crafton	Booz Allen Hamilton	Senior Associate
Kevin Foley	Booz Allen Hamilton	Associate
Tom Guins	Technology Test Center Inc.	Economist
Erin Hackmann	Booz Allen Hamilton	Associate
Paul Krupowicz	GE Rail Services	AAR Operations Programs Manager
Robert Kull	WABTEC Railway Electronics	Director, Business Development
Robert Lauby	Booz Allen Hamilton	Associate
Art Lewis	American Electric Power	Manager of Railcar Maintenance
Aldo Liberatore	ZTR	Manager, Special Projects
Dana Maryott	BNSF	Director, Locomotive and Air Brake
Bryan M. McLaughlin	New York Air Brake	Manager Freight Systems Engineering and Applications
Ed Moore	Booz Allen Hamilton	Associate
Tim Murphy	Booz Allen Hamilton	Senior Associate
Terry Owens	New York Air Brake	Business Development Engineer
Mary Plache	FRA	Economist
John Punwani	FRA	Research and Development
Walter Rosenberger	Norfolk Southern	Operations Engineer
Steve Slobidsky	Union Pacific	Manager of Mechanical Engineering
Brian Smith	Technology Test Center Inc.	Principal Investigator
Jerry Solt	WABTEC Railway Electronics	Regional Sales Manager
W. Kurt Sorter	Ameren Energy Fuels & Services	General Executive, Coal Delivery
Carl P. Stendhal	BNSF (retired)	Director, Car and Locomotive Air Brakes (former)
Jim Wilson	FRA	Railroad Safety Specialist, Motive Power & Equipment
Tom Wisniewski	Booz Allen Hamilton	Senior Associate
Chuck Wolf	WABTEC Railway Electronics	Principal Systems Engineer

## Appendix C. Value Measuring Methodology

A business case articulates a business challenge, identifies alternative solutions for meeting that challenge, and determines which of those alternatives will provide the most advantageous mix of value, risk and cost. When approached in an objective and structured manner, business case analysis provides not only the justification for a decision, but also the foundation for developing the plans required to ensure that the results predicted in the business case are realized.

### Results-Based Decision Making

To bridge the gap between decision making and achieving results, many decision makers in the government have sought out new approaches to conducting cost, benefit, and risk analyses. The focus of these efforts has been to find or develop methodologies that could credibly and reliably assess the predicted or actual financial and non-financial benefits of a particular initiative.

Academics and practitioners have been examining this question for some time, and have developed number of approaches. . Some attempt to convert all non-financial benefits into financial terms, but these efforts tend to be cumbersome, counterintuitive, and difficult to replicate. Other approaches recommend viewing investments from multiple perspectives, but provide no means for quantifying what is seen. Still others have developed business case analysis tools that limit analysis to a few predetermined choices provided on pull down menus.

Through research and practice, Booz Allen Hamilton has found that in order to ensure with some level of certainty that a program will yield desired results, those results must be considered from the beginning, and factored into decision making process. Decision making itself has to be results-oriented. For example:

**Government decision makers must be provided with the information they need to compare cost, benefit (both financial and non-financial) and risk that quantifies projected results in a meaningful and accurate manner.**

- If a program is intended to serve the men and women of the armed forces and those that manage them, the benefits to be realized by those individuals have to be identified, defined and factored into the decision making process.
- If a program is funded by taxpayers, the effectiveness of the program should be considered, as should the ability of the program to ensure that taxpayer funds are protected from the threats of government fraud, waste and abuse.
- If an investment will create a foundation for future investments, the relative value of that foundation should be considered in quantifiable terms when making investment decisions.

**The quantitative analysis of non-government / non-financial benefits should not take the place of the financially focused analytics, but rather augment them.**

## The Value Measuring Methodology: History and Overview

The following section discusses the flexibility, scalability and reliability of the Value Measuring Methodology (VMM), which may be tailored to assess all programs in a manner that fulfills a wide range of needs. VMM is designed to:

- Provide results for both IT and Non IT projects
- Qualitatively and quantitatively measure direct and indirect benefits
- Provide the information and analysis necessary for the reasonable accounting for the probability of program success
- Provide the approach required to conduct risk assessments and reasonably predict outcomes
- Focus on certainty, rather than specificity, providing probability and distribution ranges of outcomes
- Scale to accommodate spending decisions of all magnitudes
- Provide a complete cost-benefit analysis for both direct and indirect cost savings

### VMM History

#### VMM Development Timeline

VMM was developed by Booz Allen and academics affiliated with Harvard University's Kennedy School of Government under contract with SSA and GSA

- ▶ January 2002 - Building a Methodology for Measuring the Value of e-Services is released
- ▶ June 2002 - GSA tasked the Booz Allen Team to refine and test through application to 2 cross-agency e-Gov initiatives
- ▶ October 2002 - Release of the VMM How-To Guide and VMM Highlights document by the Best Practices Committee of the CIO Council
- ▶ April 2003 - VMM Rollout – Event held by the Council for Excellence in Government in cooperation with the Best Practices Committee of the Federal Chief Information Officers Council (CIOC), SSA, OMB, GSA, and the National Defense University
- ▶ July 2003 – On behalf of GSA, Booz Allen presented a series of VMM Workshops entitled Practical Training for Practical Application
- ▶ February 2004 – VMM is incorporated into the curriculum of the Strategic and Tactical Advocates for Results (STAR) program, a major CIOC / GSA initiative

In July 2001, SSA's Office of Electronic Services, in cooperation with GSA, initiated the task of developing an effective methodology to assess the value of electronic services (e-Services) that would be:

1. compliant with current federal regulations and OMB guidance;
2. applicable across the federal government, and
3. "do-able."

To aide them in this effort, SSA and GSA contracted a team of Booz Allen analysts and academics affiliated with Harvard University's Kennedy School of Government.

The original focus of this effort targeted the development of a means to quantify "value" - specifically the non-financial benefits associated with electronic government services. However, this focus was broadened



during the development of the methodology, when it became apparent that an analysis of value alone had little worth when considered in isolation. Additionally, it became clear that this methodology could provide important insight into the business value of other investments, such as those associated with the re-alignment of an organization, the overall impact of policies or regulations, and the acquisition of information technology (IT) systems.

### VMM Guiding Principles

The application of VMM is based on the following series of guiding principles:

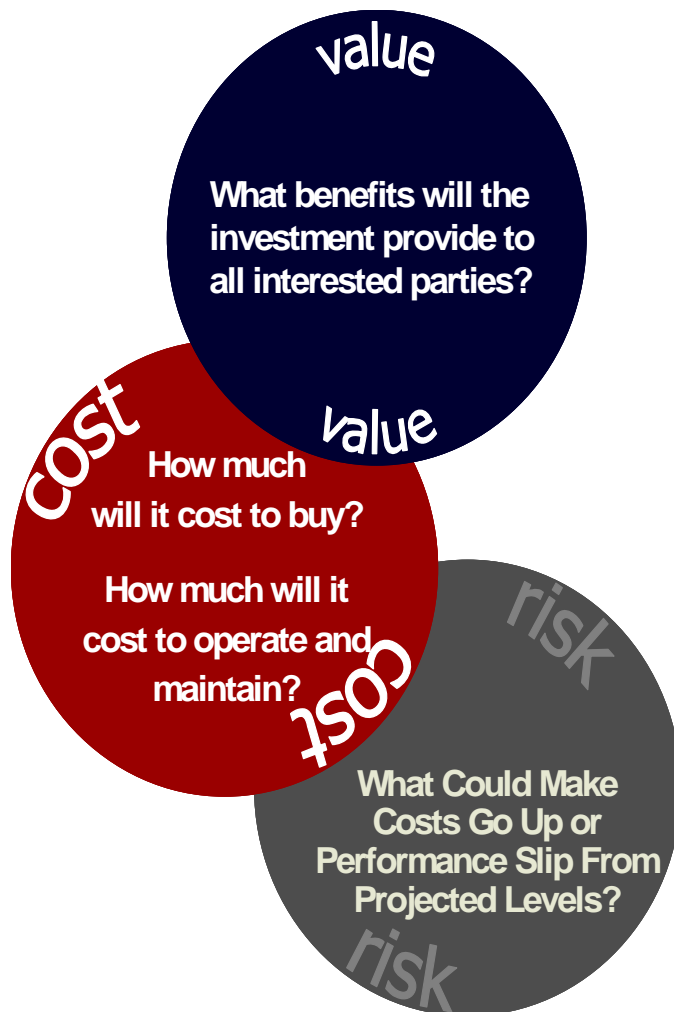

- Sound decisions must be based on an understanding of value, risk, and cost and the interactions among them.
- No government program exists in isolation; its value must be measured within the context of an organization-wide strategic vision.
- To accurately measure value, it must be understood, defined and quantified.
- Value is perceived, defined and communicated differently from different points of view.
- The data used to measure value must become more accurate, more detailed and more in-depth as an initiative moves from vision to implementation.
- The quality of information is determined by certainty, not specificity (i.e., benchmarks are preferred over guesswork).
- Avoid analysis paralysis by matching information (depth, quality, sources) to the phase of implementation.
- Define all benefits in quantifiable terms. Avoid, to the greatest extent possible, the use of survey type metrics (e.g., good, fair, medium, etc.)

### Using VMM

VMM was developed to be flexible, scaleable, and customizable. Its guiding principles and consideration of risk, value and cost are universally applicable in the government environment. Organizations may use VMM on a project-by-project basis or across the enterprise. The following section provides a general overview of the methodology, step-by-step.

## VMM Step-by-Step Overview

The following is a high-level overview of VMM. A more in-depth, step-by-step description of the methodology may be found in the VMM How-to-Guide, which may be accessed through the CIO Council's Best Practice Committee's website at: [http://www.cio.gov/documents/ValueMeasuring\\_Methodology\\_HowToGuide\\_Oct\\_2002.pdf](http://www.cio.gov/documents/ValueMeasuring_Methodology_HowToGuide_Oct_2002.pdf).

The VMM process may need to be tailored in situations where most or all of the costs and benefits, including any up-front investment cost, are coming from the private sector rather than government.

### Step 1. Develop a Decision-Framework

The cornerstone of VMM is the decision framework. Comprised of three structures - value, cost and risk - the framework provides decision makers with a blueprint for defining, analyzing and comparing alternatives. In addition, it ensures that decision makers will have the depth and granularity of information necessary to make and justify sound business decisions.

#### Identify & Define the Value Structure

The Value Structure describes the benefits to be derived from undertaking the project. Consideration of each value is required in order to understand the full breadth and depth of value offered by an initiative. Decision making that fails to consider value from multiple perspectives results in decisions that are based on faulty assumptions, including:

- Cheaper is better
- Faster is better
- What is “good” for government, is “good” for citizens
- A good investment is one that demonstrates a positive return in the short term
- A sound overall investment is necessarily good for each of the stakeholders involved

For many project, the values will be financial benefits, such as cost savings or cost avoidance. It is important to understand that these financial benefits may be derived from various stakeholders, including non-government stakeholders.

#### Identify & Define the Risk Structure

The Risk Structure provides a starting point for identifying and documenting an inventory of risks. It enables program managers to build a sense of confidence that all factors that may jeopardize an initiative's success are considered when defining and analyzing each alternative solution. The risk structure is comprised of the following:

**Risk inventory** – A risk inventory identifies and documents the risks associated with an initiative. The identification of risk should occur during working sessions with technical and policy staff or representatives of partner agencies. Issues and challenges raised

Narrative Risk Level	Probability	Cost Impact	Value Impact
High	50%	25%	-25%
Medium	30%	15%	-15%
Low	25%	5%	-5%

↑ Likelihood of Occurring      ↑ Causes Cost to Increase      ↑ Causes Value to Decrease

during preliminary planning sessions should be documented and defined. They will be used during the definition of alternatives to ensure that risk is mitigated to the greatest degree possible.

**Risk probability and impact scale** – Depending on the initiative, a risk probability and impact scale can be used to translate narrative assessment of the probability and impact of risk (e.g., high, medium and low) to percentages. The table to the right is an example of a risk scale.

## Identify & Define the Cost Element Structure

A Cost Element Structure (CES) deconstructs cost into its individual components, helping to ensure a complete, comprehensive cost estimate and to alleviate the risk of missing costs or double counting. It is important to tailor the CES to the requirements of a particular initiative. Steps to develop a tailored CES include the following:

- Review existing CESs developed for analogous initiatives
- Review / incorporate business best practices and government lessons learned
- Incorporate elements as necessary to address costs associated with achieving value and mitigating risk

## Begin Documentation

At the end of each of the VMM Steps is a task associated with documentation. Step 1 documentation should include, at a minimum:

The decision framework (Value, Risk and Cost Structures)

Global assumptions (e.g., economic factors such as the discount and inflation rates)

Documentation of research and prioritization sessions

### Step 2. Alternatives Analysis (estimate value, cost, & risk)

An alternatives analysis requires “thinking-through” possible ways in which an issue may be addressed, yielding the data required to not only justify an investment or course of action and support the completion of budget justification documentation (e.g., OMB Exhibit 300), but also to provide an expected baseline of value, costs, and risks to guide the management and on-going evaluation of an investment.

An alternatives analysis must consistently assess the value, cost, and risk associated with more than one alternative for a specific initiative within the specific parameters of the decision framework without stalling the planning processes in the quagmire of “analysis paralysis.” The estimation of cost and projection of value must, to the greatest extent possible, predict actual costs and value. This is accomplished in part by using ranges to define specific elements of cost and measures of performance, and then subjecting those ranges to an uncertainty analysis to develop a range of expected value. A sensitivity analysis identifies the variables that have a significant impact on this expected value. Although these analyses will increase confidence in the accuracy of an estimate of cost and prediction of performance, it does not consider how other factors may drive up expected costs or degrade predicted performance: to do so requires the performance of a risk analysis.

## Identify & Define Alternatives

The starting point for developing alternatives should be the information in the Value and Risk Structures and preliminary value drivers identified. Using this information will help to ensure that the alternatives and, ultimately, the solution chosen, accurately reflect a balance of performance, priorities, and business imperatives. Successfully identifying and defining alternatives requires cross-functional collaboration and discussion among the managing agency, partner agencies, business line staff, technologists and engineers, and policy staff.

## Estimate Value and Cost

The CES and Value Structure are used as a framework for estimating cost and value, respectively. The first step to developing these estimates is to collect information. The data sources used will vary based on what is being estimated and the phase of the project. For example, if the project being analyzed is in the early stages of development, data sources for both value and cost will typically include benchmarks and data from analogous projects.

Despite our best attempts, initial cost estimates and value projections are very rarely accurate within an acceptable percentage of error. Additional analyses, specifically uncertainty analyses, help analysts increase their confidence that they have identified the most likely cost and value of each alternative. Uncertainty analyses are most easily and accurately performed using a software tool such as Crystal Ball®, which has the capability to run simulations (e.g., a Monte Carlo simulation). Monte Carlo simulations run thousands of scenarios that combine randomly selected values from within the specified ranges.

Additionally, when costs and benefits are not well defined, Crystal Ball can be used to provide a range of inputs to the analysis. For example, if a new project is being undertaken and the savings to the project are not agreed upon by the various stakeholders, Crystal Ball can be used to bound the range of uncertainty. For example, instead of using “\$100,000 savings per year” as an input, Crystal Ball enables the analyst to use “between \$75,000 and \$125,000 savings per year, normally distributed” as an input. Most importantly, the use of Crystal Ball enables the analyst to uncover impacts that are often overlooked when simple “point estimates” for benefits are used. The use of tools like Crystal Ball also enable detailed sensitivity analysis as well as detailed graphical display of the resulting benefits.

## Conduct a Risk Analysis

Even the most comprehensive risk mitigation efforts will leave behind some level of residual risk that will cause value to slip and / or cost to increase. VMM requires that the impact of each risk factor on both cost and value be considered. This provides analysts with information necessary to determine the interaction between impact and probability and predict how that interaction will change the value and cost of the investment under consideration.

Risk	Probability	Cost Impacted		Impact
Insufficient Technical Resources	Med (30%)	1.0 System Planning & Development	\$5.1 M	Low (5%)
Lack of Internal Consensus	High (50%)	2.0 System Acquisition & Implementation	\$11.4 M	Med (15%)
		3.0 System Maintenance & Operations	\$15.0 M	Low (5%)
TOTAL PROJECT COST			\$31.5M	

Probability X Impact		Expected Cost Impacted	Effect of Risk
(30% X 5%)	X	\$5.1 M	\$0.8M
(50% X 15%)	X	\$11.4 M	\$.86M
(50% X 5%)	X	\$15.0 M	\$.38M
		<b>\$31.5M</b>	<b>\$1.32M</b>

**\$31.5M + \$1.32M = \$32.82M Risk Adjusted Cost**

The risk analysis is performed as follows:

- The probability and impact of each risk are estimated at the lowest practical level of cost element and value measure. This initial assessment is performed using a narrative scale (e.g., low, medium, high).
- If sufficient information is available, the narrative assessments can be translated into percentages using the risk scale established in Step 1.

### On-going Documentation

For each alternative, the initial documentation of the general assumptions and risks are expanded to include a description of the alternative being analyzed; a complete, comprehensive list of both cost and value assumptions; and assumptions regarding the risks associated with a specific alternative, including expansion of the initial risk inventory.

### Step 3: Communicate and Document

The outputs of VMM may be used to communicate the overall value of an initiative to a variety of stakeholders. The analysis and planning required by VMM produce outputs that fully satisfy or strongly support many requirements for justifying investment or budget requests.

## Appendix D. Industry Experience with ECP Brake Technology

### Initial Experience in the 1990s

In 1990, the AAR Research and Test Department had the task of investigating advanced freight railroad braking concepts. From May 19 to 21, 1992, the AAR held a workshop on High Performance Freight Train Braking. Discussion in 1993 at the Air Brake Association focused on initial or “near term” overlay system experiments such as Electro Pneumatic Assist (EPA); radio repeaters, and long-term possibilities of stand-alone systems that would achieve graduated release and variable empty/load control of brakes.

### ECP Brake Timeline

At the Air Brake Association meeting in September 1993, the AAR presented the results of testing on Canadian Pacific of the Q-tron test EPA brake experiments. The experiments made the minimum intrusion into the existing system, making connections at existing test ports, and attempting to rapidly transmit the emergency brake signal down the train electrically and measure the difference in braking distances.

- 1993 – AAR begins to experiment with EPA**
- 1993 – AAR Economic Analysis of High Impact Load Wheels**
- 1994 – An Experimental Electric Assist Brake System, results of lab testing (AAR TD94-007)**
- 1994 – Economic Analysis of Electric Braking Systems (AAR TD94-021)**
- 1995 – AAR begins testing of ECP brakes in revenue service**
  - Confirmed dramatic reduction in wheel replacement**
  - Confirmed lower dynamic coupler forces (slack action)**
  - Brake shoe wear was higher (possibly due to train handling)**
  - Design change recommendations included more robust electrical connector**
- 1997 – Draft Specification for ECP Brake Systems delivered to AAR Working Committee**
- 1997 – ECP Brake Financial Analysis Workbook (AAR TD 97-002)**
- 1999 – FMECA for ECP Brakes Designed to AAR Standard S-4200 (AAR Final Report)**

The AAR initially tested the system on a 150-car rack at the AAR test facility in Chicago, which was set up to simulate 25 double-stack cars, and 300 feet of brake pipe per car (7,500 feet per train). Results showed significant reduction in braking distance at higher speeds, and dramatic reductions at lower speeds on descending grades.

### Revenue Test Trains

Both railroads and car owners showed great interest in the potential of this technology, and a flurry of test installations by various railroads and car owners followed. A few key test installations are outlined below with their initial goals, equipment, methodology, and results.

- 1995 – BNSF *Testing* in Revenue Service of ECP begins (NYAB & TSM equipment)
  - 2 Double stack trains, Chicago – Los Angeles, testing Wheels & Brake Shoes
  - 1 BNSF Double Stack, Chicago to Seattle
  - 2 BNSF Unit Coal Trains, Powder River to Becker, MN, - Testing ECP Connectors
  - 1 BNSF Taconite Trains Superior WI to St. Louis - Testing ECP Connectors
  - 1 BNSF Unit Coal Train, Kansas City to Galveston
  
- 1995 – Conrail *Testing* in Revenue Service of ECP begins (TSM Equipment)
  - 1 Unit Coal Train with ECP
  - 1 Unit Coal Train with Conventional
  
- 1995 – CP Rail *Testing* in Revenue Service with ECP begins
  - 1 Intermodal Train Toronto to Montreal
  
- 1998 – QCM Quebec Cartier Mining, *Revenue Service* begins
  - 1 Unit Iron Ore Train of 150 cars
  
- 2000 – Southern Company & CSX *Testing* in Revenue Service begins
  - 1 Unit Coal Train
  
- 2000 – Spoornet, South Africa, *Revenue Service* begins
  - 1 Unit Coal Train

## Key Experiments to Date

### Burlington Northern Santa Fe Railway (BNSF) Experiments on Diverse Trains and Routes<sup>54 55 56</sup>

BNSF today has more diverse experience with ECP brakes than any other Class 1 railroad. BNSF, working with the AAR, purposefully began experimenting with ECP brakes on several different train types on different routes. Eventually, they included three double-stack trains, three unit coal trains, and one Taconite train. Their purpose was to gain experience with operating ECP brakes and learn the economic and operating challenges and benefits of different train type and route characteristics.

BNSF began working with ECP trainsets in 1994 with both TSM and New York Air Brake (NYAB) equipment, using a 60-car coal train in Beardsville, IL. Initial testing showed 30 to 70 percent reduction in stopping distance, and BNSF gained experience in operating an ECP trainset. Initial TSM equipment was 120 volt, and was later modified to 230 volt per AAR developing standards.

Initial testing on BNSF coal trains showed a 30- to 70-percent reduction in stopping distance.

<sup>54</sup> Rick Stauffer/BNSF, “*Evaluation of Electronic Controlled Pneumatic Braked Trains in Revenue Service*”, Proceedings of the Air Brake Association, September 1997.

<sup>55</sup> Rick Stauffer/BNSF, “*Evaluation Update of Electronic Controlled Pneumatic Braked Trains in Revenue Service*”, Proceedings of the Air Brake Association, September 1999.

<sup>56</sup> Fred Carlson/AAR Technical Digest TD 97-008, “*ECP Brake Revenue Service Testing Update*”

The BNSF testing on revenue trainsets used ECP brake equipment from NYAB and TSM (later TSM/Rockwell/Wabtec). They chose four types of trains to equip with ECP brakes:

1. BNSF Double-Stack Train(Los Angeles, CA to Chicago, IL & Return)

Two trainsets of double-stack cars began operation in November 1995, running from Chicago to Los Angeles.

2. BNSF Taconite Train (Hibbing, MN to Allouez, WI)

One taconite trainset of 180 cars operated in the northeast Minnesota iron ore range. Cars were equipped with a 230-volt

**BNSF could operate a longer taconite train of 180 cars due to the improved handling with ECP brakes as opposed to 140 cars with conventional brakes**

overlay system. BNSF retrofitted about 90 cars and bought the rest new with ECP brakes on them. BNSF found that they could operate a longer train of 180 cars in length with the improved train handling of ECP brakes as opposed to 140 cars with conventional brakes.

3. BNSF Coal Train (Powder River Basin, Montana to Becker, MN)

BNSF experimented with coal trains, with 286,000 lb GRL (Gross Rail Load), aluminum body, coal cars. Two trainsets of 120 cars each, or 240 cars total, were equipped with 230 volt, ECP overlay systems. They started operating in 1996 between Powder River basin and Northern Minnesota.

An additional set of 120 aluminum body, rotary gondola, coal cars started in service in 1997, with a TSM overlay system.

4. BNSF Grain Train (Kansas City, MO to Galveston, TX)

One trainset of 120 cars, steel body, covered hoppers were retrofit with ECP overlay system. The grain cars operated between the Midwest and the Pacific Northwest, or Gulf of Mexico carrying corn.

Locomotives require a head end unit (HEU), a power converter, an ECP brake event recorder, and train line wiring to connect the lead locomotive to the first ECP-equipped car. Initially, the wiring was temporary, but later BNSF committed to put train-line wiring in all locomotives, wired to terminal boxes at both ends of the locomotives. ECP equipment could then easily be added to the locomotive.

### **Problems**

The main problem in getting good data was the intermittent operation of ECP brakes on the trains. There might not be ECP-equipped locomotives at the initial terminal, or non-ECP-equipped locomotives might be added en route. Operation with the non-ECP-equipped locomotives meant that the ECP-equipped cars operated in conventional brake mode rather than in ECP mode. As a result, through uneven braking or UDEs, this non-ECP operation could cause the very same wheel damage that the ECP brake system was intended to prevent. This wheel damage on the ECP cars would “muddy” the results.

Operating only a train or pair of trains out of the entire fleet of each type was difficult, and could at best be maintained for a limited test period.



## Benefits

Charts for brake shoe replacement and wheel replacement for the intermodal trains, taconite trains, and coal trains reveal the following.

### Intermodal

The intermodal test trains operated intermittently in ECP mode. They appear to have varied between almost zero percent in some months to about 75 percent at best. They never had a month when they operated in ECP mode 100 percent of the time.

**In the first revenue ECP Brake train sets, the intermodal trains, BNSF noticed a significant reduction in wheel changes due to tread defects.**

Wheel replacement showed a significant decrease with ECP brakes as shown below in Table D-1. As the percent of ECP operation dropped over the test period, the wheel replacement grew closer to the wheel replacement for conventional brakes.

The AAR<sup>57</sup> reports on wheel results on the BNSF double-stack trains after 150,000 miles, operating between Chicago and Los Angeles since December 1995.

**Table D-1. Wheel Defect**

Defect	Conventional	ECP
Wheels replaced for slid flats – hand brake axle	7	0
Wheels replaced for slid flats – non handbrake axle	1	0
Wheels replaced for shells or spalls	7	0

Note: Shells or spalls are defects on the wheel tread that can require removal and replacement of the wheel. Shelling is a rolling contact fatigue of the metal on the contact surface resulting in pieces of metal falling out of the surface, but is often confused with spalling. Spalling is a phenomenon that results from overheating of the wheel tread surface followed by fast cooling. This heating can result from severe braking, or sliding as with stuck brakes, and will change the material properties of the metal. The result is cracking on the tread surface and fracture of pieces of metal from the tread surface.

Brake shoe replacement was extremely high at the beginning, but declined as the operator became accustomed to ECP brakes. This is believed to be because of the change in locomotive operation with ECP brakes. For example, because of graduated release, the locomotive engineer was not hesitant to use air brakes where he would have used locomotive dynamic brakes before. The brake shoe usage showed a reduction over the 1½ years of data displayed.

Brake shoe wear in the first 150,000 miles of the BNSF double-stack test was reported by the AAR<sup>58</sup> as indicated below in Table D-2, and reinforces the belief that crews increase use of the friction brakes because they are a new feature and greatly improve train handling.

<sup>57</sup> Fred Carlson/AAR Technical Digest TD 97-008, "ECP Brake Revenue Service Testing Update"

<sup>58</sup> Fred Carlson/AAR Technical Digest TD 97-008, "ECP Brake Revenue Service Testing Update"

**Table D-2. Brake Shoe Replacements**

<i>Brake Shoe Replacements</i>	<i>ECP</i>	<i>Conventional</i>
BNSF Double Stack, Chicago to Los Angeles	585	85
Conrail	8	7

BNSF’s results, reported by at the Air Brake Association, show a greater brake shoe replacement for ECP than for conventional braking in the beginning, but the ECP brake shoe replacements declined with time, as the crew became accustomed to train handling with ECP brakes.

*Taconite Trains*

The taconite trains operated at a much higher percent of the time in ECP braking than the intermodal trains, averaging around 75 percent, reaching 100 percent for two months, but never dropping below about 50 percent ECP operation in a month. Replacement of wheels and brake shoes follows the percent ECP operation.

Brake shoe replacement on the taconite trains was at a level well below the conventional braked train, but increased following periods of low ECP usage. There seemed to be a one- or two-month delay between low ECP usage and the response in higher brake shoe replacement. Brake shoe replacement for the conventional train peaked in the coldest months, while the brake shoe replacement for the ECP braked train was unaffected by the cold.

Wheel replacement on the taconite trains also was significantly below the conventionally braked trains, except for a period just following the time when the ECP brakes were operating only 50 percent of the time.

The AAR reports show approximately 60-percent decrease in stop distance for a test on a loaded BNSF taconite train of 20,000 tons, 165 cars and 6,000 feet, traveling at 38 mph:

Conventional brakes	ECP brakes
~4,500 ft.	1,830 feet

But as the AAR paper notes, the greatest advantage is not the stop distance, but the train handling improvement with graduated release.

**Taconite trains maintained low brake shoe replacement in the cold winter months when the conventional train brake shoe replacement skyrocketed.**

*Coal Trains*

The percent of ECP operation started out high at 100 percent, but later dropped to about 25 percent and varied from 100 percent to 25 percent in any month.

Brake shoe replacement on the ECP braked train set remained significantly below the conventionally braked train set.

Wheel replacement also remained significantly below the conventionally braked train set. The coal trains showed the most dramatic difference in wheel replacements between the conventional and ECP braked train sets. Wheel replacement for the ECP train peaked with the low point in percent of ECP operation and approached the replacement level for the conventionally braked train. But when the percent of ECP operation increased again, the wheel replacements for the ECP braked train dropped back down to a negligible number in comparison to the conventionally braked train.

**BNSF Coal trains showed the most dramatic reduction in wheel replacements of all of the tested train types.**

BNSF reported in 1999 that it is buying all new cars and locomotives either equipped (conduit and terminal boxes in place) for or equipped and wired for ECP brakes, and it was working with NYAB to integrate ECP into the locomotive cab control and display.

### Quebec Cartier Mining (QCM) Experiments<sup>59 60 61</sup>

QCM carries iron ore in unit trains of 156 rotary dump ore cars; 16,000 tons per train; and 260 miles from Mount Wright, Quebec to Port Cartier on the St. Lawrence River. Annual tonnage hauled is approximately 17 million tons. There are six trainsets. The cars are 50,000 lb lightweight and 263,000 lb GRL. It should also be noted that the environmental conditions on this railroad are severe with extreme cold.

QCM has been looking for improved performance, and the justification for converting to ECP brakes was economic based on fuel savings predicted by simulation between two trains—one with conventional and one with ECP brake systems. However, there were other problems to be solved as well. In the coldest periods of winter, QCM had to reduce train length to 100 cars, due to the excessive brake leakage and resulting UDEs. QCM's solution was to place a compressor car about one-third of the way back in the consist to support the brake pipe, which allowed QCM to run 150-car trains again. QCM still had one UDE on the average for every 10 trains.

QCM converted to stand-alone ECP brakes (rather than an overlay system) because of the cost and efficiencies involved in converting once rather than converting first to an overlay system and then again to a stand-alone system. QCM saw stand-alone as the final goal. Operation on its own private line freed QCM from any compatibility concerns.

QCM experimented first with shorter trains in ECP service, and in March 1998, ran its first 156 car ECP train. In April of 1998, QCM started the ECP train in revenue ECP service.

QCM's personnel performed the conversion themselves, and reportedly the conversion from conventional to stand-alone ECP brakes took eight man-hours per car. QCM's personnel also converted the locomotives, and that conversion took 16 man-hours per lead locomotive.

<sup>59</sup> Bryan McLaughlin/NYAB, "ECP Brakes First Stand-Alone Test Train", Proceedings of the Air Brake Association, September 1998.

<sup>60</sup> Bryan McLaughlin/NYAB, "EP-60 ECP Train Operation Data at Quebec Cartier Mining", Proceedings of the Air Brake Association, September 1999

<sup>61</sup> Gerard Sirois/QCM, "ECP Operation on Quebec Cartier Mining," Proceedings of the Air Brake Association, September 2000.

## **Benefits**

The results show that while ECP does bring potential benefits, other changes in yard and operating procedures must be made to take advantage of the potential or to adapt to the different system.

For example, operators are accustomed to using dynamic brakes for train handling to prevent slack action and potential derailment that results from it. Slack action is no longer a concern with ECP brakes, which allows the operator to use friction brakes exclusively. But use of friction brakes exclusively will lead to higher brake shoe wear. There are still economic benefits to using dynamic brakes, which can reduce brake shoe wear. Operating procedures need to be revised for the use of dynamic brakes.

### *Fuel Savings*

Fuel savings, mentioned as a driving goal in the 1998 paper, were achieved. Initial figures in 1998 show a 2.1-percent improvement in fuel consumption, which grew to 3.5 percent in 1999 due to improved train handling and locomotive management. In 2000, QCM reported fuel savings of 4.9 percent overall, which was attributed mainly to reduced power braking. But looking only at the period after increase of the train length from 156 to 182 cars, the fuel savings was 5.7 percent. Thus the potential fuel savings were not realized with the change to ECP equipment alone, but only after combinations of the equipment change and changes in train handling procedures, and coincident with an 15-percent increase in train length and capacity.

**QCM attributes a fuel savings of 5.7 percent to reduced power braking and increased train length from 156 to 182 cars, after installing ECP brakes.**

### *Reduced UDEs*

Prior to ECP brakes, QCM needed to either reduce its train in winter months to a maximum of 100 cars, or add a compressor car about one-third of the way back into the train in order to avoid excessive UDEs due mainly to brake pipe leakage. They experienced one UDE in every 10 trains. After ECP brakes, QCM not only eliminated the need for a compressor car, and virtually eliminated UDEs, but was able to increase train length by 15 percent as well.

**Use of ECP brakes eliminated UDE's compared to 1 UDE per every 10 trains before ECP.**

### *Wheel Wear*

Reduced wheel changes did not immediately materialize. In fact, wheel wear with ECP brakes was slightly worse than it was with conventional brakes. QCM attributes this to two reasons. First, the crews were not using switch mode, therefore dragging wheels created flat spots.<sup>62</sup> Second, QCM has a practice of removing wheels from service with 2 mm of hollow tread. Both of these facts have clouded the issue.

<sup>62</sup> Switch mode is an ECP function that allows the trainline to be energized and brakes released, for switching cars, without an ECP end of train device applied on the last car.

### Brake Shoe Wear

Brake shoe wear has reduced significantly, and QCM attributes this to the even application of braking across the train, and to the reduction in power braking.

### Competing Benefits (Coupler Knuckle versus Increased Tonnage)

Coupler and knuckle damage should have been reduced due to the decrease in in-train forces. QCM confirms the decrease in in-train forces in its 2000 Air Brake Association paper. However, QCM admits there was no improvement in coupler and knuckle damage and associated delays. The reason for this is that QCM chose to take advantage of the reduced in-train forces and increase capacity, by increasing train length from 156 cars to 182 cars. Because QCM chose increased capacity, the coupler knuckle damage remained about the same for the 182-car ECP train as it was for the 156 car conventional braked train.

**Increased train length  
offset potential  
reduction in coupler  
knuckle damage.**

**Table D-3. Quebec Cartier Mining – Summary of Improvements**

	<i>Conventional</i>	<i>ECP</i>	<i>Improved</i>
Fuel Consumption gal/1,000 GTM	1,083	1,030	4.9% (5.9%)
Wheel Mileage	32,011	29,781	-7%
Brake Shoe Mileage	28,164	35,418	+27%
UDE's per train	0.091	0	100%
Car miles per coupler knuckle failure	2,274,255	2,112,055	-7%
Train Length	156	182	+17%
Train Delays, per 1,000 car miles	0.35	0.24	31%

GTM = Gross Ton Miles

### Southern Company, CSX, Wabco<sup>63</sup> Experiments with Coal Cars

Southern Company is one of the largest coal haul customers of Class 1 railroads. CSX had previous experience with TMS, now owned by Wabco. The experiment was originally intended by Southern Company for Western coal routes from Powder River Basin to the southeast U.S. The ability to include sensors for feedback of equipment condition was considered an important part of ECP installation by Southern Company.

The 2,000-mile route and 14 crew change points were considered too much of an investment in crew training for this experiment. The route was moved east for the initial train operations. CSX agreed to a 95-mile initial route from Corbin, Kentucky to the Georgia Power plant in Stilesboro, Georgia, with power supplied by two GE AC4400 locomotives, which reverse lead locomotives at the mine.

<sup>63</sup> Robert Kull, "Wabtec ECP System with Southern Company Utilities Coal Cars.", *Air Brake Association Conference Proceedings, 2001*

Southern Company equipped 4,000 coal cars with the TSM overlay system, which was later upgraded by Wabtec to include recent changes in the AAR specifications and make it an AAR compliant system. The system is designed to be converted to a stand-alone system with replacement of the service portion by an ECP Adapter Plate, and the emergency portion remains.

The installed AAR compliant system provides for the future addition of car and subsystem sensors, for example, for measuring carbody vibration, brake cylinder piston travel, wheel bearing temperature, wheel bearing vibration, truck hunting, handbrake monitoring/control, and for coal cars dump door monitoring.

CSX installed Wabtec integrated ECP locomotive equipment on the CSX GE AC4400 locomotives compliant with AAR S-4200, and integrated the ECP display to the control console, and ECP data to the locomotive event recorder.

Helper operation was used south of Corbin. The helper locomotive was normally connected via a "Helper Link" which is a portable system that controls the helper locomotive via radio link with the "TrainLink End of Train" (Trainlink EOT) providing a virtual brake pipe connection. This virtual brake pipe allows the helper locomotive to disconnect on-the-fly, without causing a brake-in-two. With ECP operation, the brake pipe no longer provided the braking signal. Wabtec modified the "TrainLink EOT" to provide a braking signal based on the ECP braking, to control the helper locomotive. "TrainLink EOT" is a combined function EOT device combining the FRA-mandated EOT function with the ECP end-of-train function.

Initial operation began in November 2000. Benefits predicted for this experiment where, as in earlier experiments:

- Better train handling and corresponding reduced fuel consumption
- Reduced wheel damage and wheel replacement
- Reduced overall trip time and increased equipment utilization through increased average speed from train handling, elimination of UDEs, reduction in coupler breakage, and elimination of manual inspection.

The main problem was getting equipped locomotives from the railroad and keeping them dedicated with equipped unit trains. This problem alone prevented the collection of reliable data and the continuation of the experiment.

Other problems included:

- Training and qualification of over 50 crews for ECP operation
- Keeping up with the changing AAR S-4200 specifications at that time (change of trainline transceivers from Echelon PLT-10A to PLT-22).

## Spoornet Experiments with Heavy Haul Operations <sup>64 65 66</sup>

Spoornet has two heavy-haul operations—COALink exports 27 million tons of coal per year, and Orex exports 24 million tons of iron ore per year.

Spoornet hauls coal on the Ermelo-Richards Bay line, with ruling grades in the loaded direction of 0.63 percent ascending and 1.52 percent descending, trailing loads of 200 cars, 22,800 gross tons, maximum axle load of 28.6 tons, and head end power (not distributed). The brake system is an AAR-compliant system, direct release, consisting of NYAB/Knorr DB-60s and Wabco ABDXs.

Spoornet’s objectives in changing its braking system include:

- Reduce derailments and train break-in-twos
- Reduce wheel wear (distribute thermal loads on wheels)
- Increase line capacity (by increasing average trip speed)
- Save energy (by elimination of power braking)
- Eliminate the need for a separate brake holding pneumatic line
- Provide a new standard for locomotive MU lines, so allow mixing of different types
- Stay with a standard technology (i.e., AAR standards) for long-term competitive supply.

Spoornet’s system will require 230 nodes, and therefore a repeater—a special adaptation to jump over the 160-node limitation of the Echelon PLT communications system. Spoornet also requires distributed power control over the ECP trainline.

The test train will have an ECP overlay system; however, Spoornet’s final goal is have a stand-alone ECP system.

### Benefits

During the testing, some of the first findings were that the locomotive engineers gave preference to dynamic braking first, and then used ECP brakes to adjust the braking effort. This procedure assured maximum brake shoe wear, and reduced overall wheel temperatures. It was also determined that the skill to operate the train and the stress on the engineer of operating this 200-car train were both considerably less than that with conventional pneumatic brakes.

Shorter stopping distance on descending 1.52 percent grade at 28 mph.

Stopping Distance	Conv.	+wired DP	ECP	Improved
Stopping distance, from 28 mph, on 1.52% descending grade.	4,600 ft.	3,000 ft.	1,500 ft.	~70%

<sup>64</sup> Dr. van der Muelen/Spoornet, “*Toward the Next Level of Train Handling Technology*”, Proceedings of the Air Brake Association, September 1998.

<sup>65</sup> Robert Kull/Wabtec, “*Spoornet Integrated ECP/DPC Pilot Project*”, Proceedings of the Air Brake Association, September 1999.

<sup>66</sup> Robert Kull/Wabtec, “*Evaluation of Wireline ECP Braking and DP on the Ermelo-Richards Bay Coal Export Line*”, Proceedings of the Air Brake Association, September 2000

Wheel temperatures on long descending grades were lower.

<i>Wheel Temperatures</i>	<i>Max</i>	<i>Min</i>
Conventional braking at 28 mph	236	91
ECP Braking at 31 mph	222	69

One of the main goals of Spoornet in beginning this project was to reduce the overall trip time. The ECP braked train was run at a 10-percent higher speed descending the grade. The first comparative run of the ECP and comparative conventionally braked train gave the following results:

<i>Overall trip time</i>	<i>Time</i>
Conventional Braked Train	17 ½ hours
ECP Braked Train	14 ¾ hours

The 10-percent higher descending speed was attributed to:

- Full use of dynamic brake, more even wheel heating, and no slowdown requirements out of concern for recharge times.
- 30-minute savings due to saved restart time, as a result of not having to stop at signals for recharging of brake reservoirs.
- When the holding brake is applied on the descending grade, it takes 45 minutes before the train can restart.

## Lessons Learned from the Experiments

The lessons learned from the experiments fall into two categories. The first is the confirmation of the anticipated benefits of ECP brake technology, and the second is the surprises that were not initially anticipated results of ECP technology.

### Reduced Stopping Distance

The first and simplest result is that the stopping distance of the train is greatly reduced with ECP brakes compared to conventional service. The exact amount of reduction depends on speed, grade, and weight of the train. Greater improvements in stopping distance seem to come with greater descending grades.

### Graduated Release

Graduated release is even more important than the reduced stopping distance in that it allows better train handling, which enables shortening of trip time. It also eliminates the need for power braking, which is a significant contributor to fuel consumption and excess wheel wear.



## Fuel Savings

Fuel savings result not only from the elimination of power braking, but also from the new methods of train handling that are developed with ECP braking. The emphasis on use of dynamic braking must now be on fuel savings and brake shoe wear reduction, since the train handling and slack action reasons for dynamic braking have been eliminated by ECP technology.

## Train Handling

Operation with ECP brakes is less complex than with conventional brake systems, and safety has been made simpler and more assured with reduced in-train forces and constant charging and graduated release. However, there is still a need for operating techniques to ensure saving fuel and brake shoe wear reduction.

## Reasons for Halt in Experimentation

The experimenting railroads or car owners can be split into two groups. There are those that must operate in the North American rail system, with all of its interchange requirements and locomotive assignment problems. And there are those that operate independently on their own track, whose interest in standardized AAR systems is for the purpose of ensuring future competitive supply.

## General Railroad Experiments

The experiments such as those performed by BNSF, Conrail, Southern Company, and CP Rail involved the conversion of a few trains out of massive fleets. Those trains were assembled for testing of ECP brake benefits. Supply of ECP-equipped locomotives was essential to operating the train in ECP mode. The difficulty in supplying locomotives different from the fleet became more evident as the experiments proceeded.

The disruption caused by trying to split a fleet of common equipment, such as a coal fleet or intermodal fleet, into ECP and non-ECP cars and locomotives discourages continuation of the few experimental ECP trains after the experimentation is complete. As a result, these trains have either been converted back or are being used only in pneumatic brake mode.

## Private Line Experiments

QCM performed its experimentation with the first train set, converted the rest of its fleet, and is continuing to operate its equipment in ECP mode today. QCM operates on private lines, has control over its entire fleet, has converted its entire fleet, and so has no problems blending into a larger fleet or different equipment. QCM, therefore, can continue operation with ECP without the problems of a railroad operating in the general rail system.

## What We Have Gained from the Years of Experimentation

The experimentation with ECP brakes over the last 10 to 15 years has given us a proof of concept, application feedback to help develop and improve specifications, proof of feasibility in the real world, and proof of the real economic impacts from the use of ECP brakes.

Early experimentation was done using systems and equipment that would not stand up under regular use, but was sufficient to demonstrate the theoretical performance. These experiments proved that an ECP brake system in the real world could achieve the performance predicted.

Soon, work on a standard began, putting various schemes of ECP brakes under scrutiny in the harsh environment and demanding reliability requirements of the railroad industry.

Further experiments gave real-world feedback on the success or failure of particular ECP components, and led to improved specifications based on real operating experience.

Finally, experiments with revenue trains operating in the real railroad service proved that ECP brakes could not only do the job required, but these tests also demonstrated both the performance advantages predicted and the economic advantages in revenue operation.

Railroads that are not tied to the interchange world of the general North American Rail System, have demonstrated their confidence by fleet conversions and ongoing operation with stand-alone ECP brake systems (e.g., Quebec Cartier Mining and SpoorNet). Further experimentation does not seem to be required, as evidenced by those railroads with continuing ECP operations.

The operational stumbling block remaining to the implementation of ECP in North America is the difficulty in dealing with two different fleets of cars and locomotives. One fleet is equipped with conventional brakes and the other is equipped with ECP brakes. Any conversion to ECP must be made as a well thought-out, coordinated, system-wide conversion.

## Appendix E. VMM Results for the PRB Alternative

### Introduction

As discussed in Appendix C, the Value Measuring Methodology has been used to develop this benefit-cost analysis. This technique provides a framework to analyze benefits, costs, and risks on an equitable basis for multiple analyses. In this section, the details for the PRB Alternative are presented.

This analysis complies with the framework described in OMB's Circular A-4. The alternatives described are based on benefits and costs that were both quantifiable and non-quantifiable and represent a realistic assessment of both the current and potential future environments.

### Baseline Case Information

Circular A-4 requires the examination of a "baseline" case. For this analysis, the baseline case is to maintain the status quo for the industry, which represents the current situation of no implementation of ECP. In other words, if the baseline case were to be implemented, the benefits, costs, and risks involved in implementing the PRB alternative would be avoided. None of the quantitative or qualitative benefits would be realized, nor would there be exposure to the costs described in the body of this report. Note that many of the qualitative risks may still impact the industry, as uncertainty regarding fuel prices and maintenance costs exists with or without action by the industry.

### Basic Assumptions

For the PRB alternative considered, there were several basic assumptions. The primary assumption is that benefits will accrue as costs are realized. For unit trains, this assumption holds true.

A second major assumption is made with regard to the availability of ECP brakes to install. As there is limited current market demand for ECP brakes, if a significant supply of ECP brakes were required in a short period, it is unknown whether or not the existing market could meet demand. However, this is the rationale for a year's lead time on this alternative, and a three-year implementation period for conversion of a relatively limited number of locomotives and freight cars.

The methods used to generate the results within this Appendix are described in Appendix C: Value Measuring Methodology. The data used for this analysis were collected from a variety of sources, and verified by the Expert Panel. The analysis examined both the internal rate of return (IRR) as well as the net-present value (NPV) of the benefit-cost difference. Additionally, the analysis was performed assuming that there was no defined correlation between any of the inputs.

### Discount Rates

This analysis used three discount rates for comparison, at 3%, 7%, and 12%. The 3% and 7% rates are discussed in A-4. The 12% rate is more indicative of the return used by entities such

as investor owned utilities, which would have to put up much of the capital for conversion of utility owned freight cars in this alternative.

## Inputs

Total number of Cars: 80,000  
 Total number of Locomotives: 2,800  
 Initial installation year: 2008  
 Total Benefits, per year: \$170 million  
 Total Costs, one time: \$432 million  
 1/3 of the cars and locomotives are converted per year

## Results

Discount Rate	3%	7%	12%
Net Present Value (NPV)	\$1,901M	\$1,185M	\$694.3M
Internal Rate of Return (IRR)	60.1%	54.1%	47.2%
Payback Duration	3 Years	3 Years	3 Years
Break Even Year	2011	2011	2011
Total Discounted Cost Over 3 Years	\$395.5M	\$353.2M	\$308.8M

To deal with uncertainty, Crystal Ball was used to model the variation in the inputs for both the Total Benefits and Total Costs, as well as the number of cars and locomotives to be converted.

Total Benefits per year were given a range of \$161.5 million to \$178.5 million, with \$170.0 million as the most likely. Total Costs were given a range of \$407.0 million to \$457.0 million, with \$432.0 million as the most likely.

The number of cars was used as an input to capture the variability of installation over the three-year period. The model uses 72,000 cars as a low estimate, 88,000 as a high, and 80,000 as the most likely. For locomotives, the model uses 2,600 as a low estimate, 3,000 as a high estimate, and 2,800 as a most likely.

Using these four variables, both the NPV and Internal Rate of Return (IRR) can be calculated. For the three-year IRR, the results for the 7% discount rate are:

- Entire range is from 45.61 percent to 64.39 percent
- The mean is 54.21 percent
- After 5,000 trials, the std. error of the mean is 0.04 percent

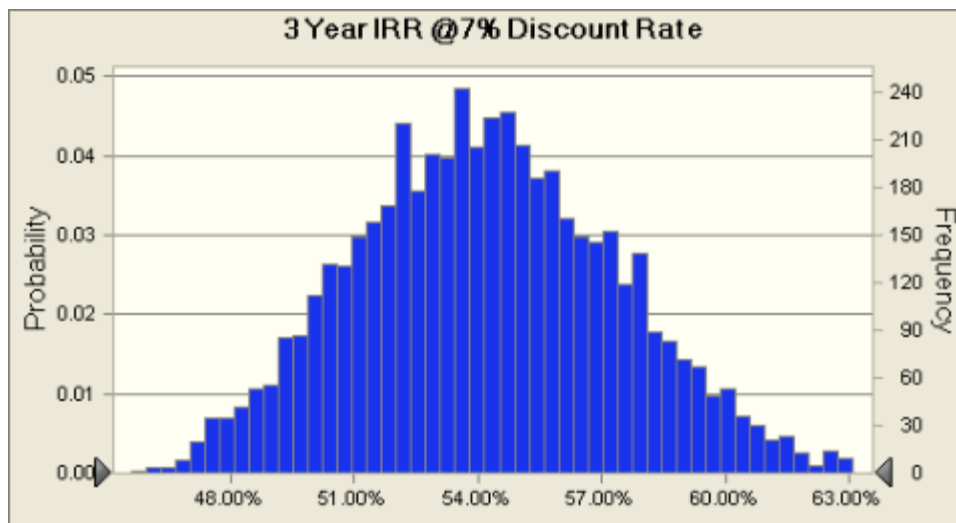

These results indicate that there is a very high level of certainty that the IRR will be greater than 45 percent (nearly 100 percent), and that there is also a 50-percent chance that the IRR will be greater than 54.1 percent.

For the NPV, the results for the 7% discount rate are:

- Entire range is from \$1,097,517,751 to \$1,273,755,855
- Mean is \$1,184,736,085
- After 5,000 trials, the std. error of the mean is \$461,654.

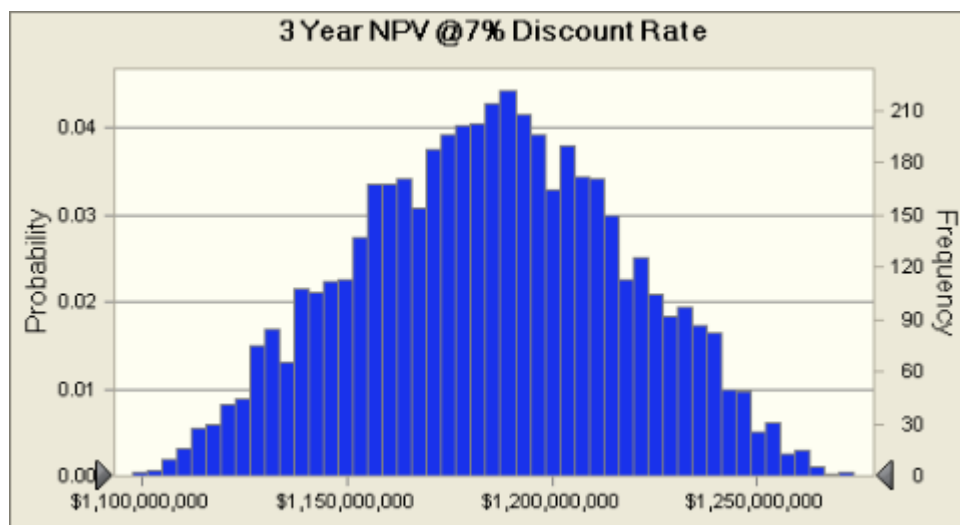

## Sensitivity Analysis

The sensitivity charts (Figures E-1 and E-2) illustrate the influence each input (e.g., Total Benefits and Costs) has on the given output (NPV, IRR). Crystal Ball ranks the importance of the given inputs on the outputs, which illustrates the relative importance of the inputs. Inputs

that are positively correlated with an output are illustrated as a positive number and a blue bar; negative correlations are negative numbers and red bars.

Figure E-1 shows the sensitivity analysis for the “3 Year IRR” calculation. This chart shows that the IRR is roughly twice as sensitive to changes in Total Benefits as Total Costs. Additionally, as Total Benefits increase, the IRR increases; and as Total Costs increase, the IRR decreases.

Figure E-2 shows the sensitivity analysis for the “3 Year NPV.” This chart shows that the NPV is considerably more sensitive to the variations in Total Benefits than Total Costs. In a similar fashion to IRR, Total Benefits are positively correlated with NPV, and Total Costs are negatively correlated. The primary difference between the magnitude of the two results is based on how the NPV is calculated, taking the timeframe for benefits and costs into consideration, which the IRR does not.

Since the NPV is positive, the investment should be undertaken. Also, note that neither the precise number of cars nor locomotives converted is a significant factor in either of these sensitivity analyses. This is due to the large variations in benefits and costs compared to the relatively small variation in number of cars and locomotives to be converted to ECP brake systems.

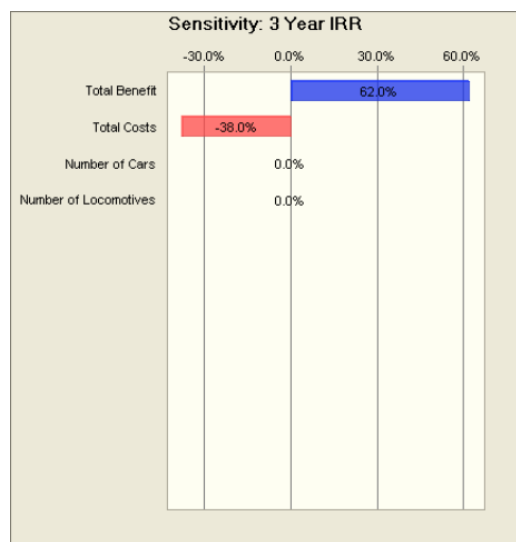

Figure E-1: IRR Sensitivity

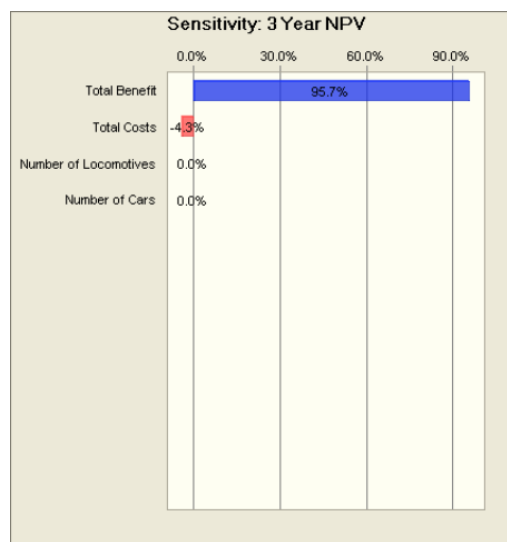
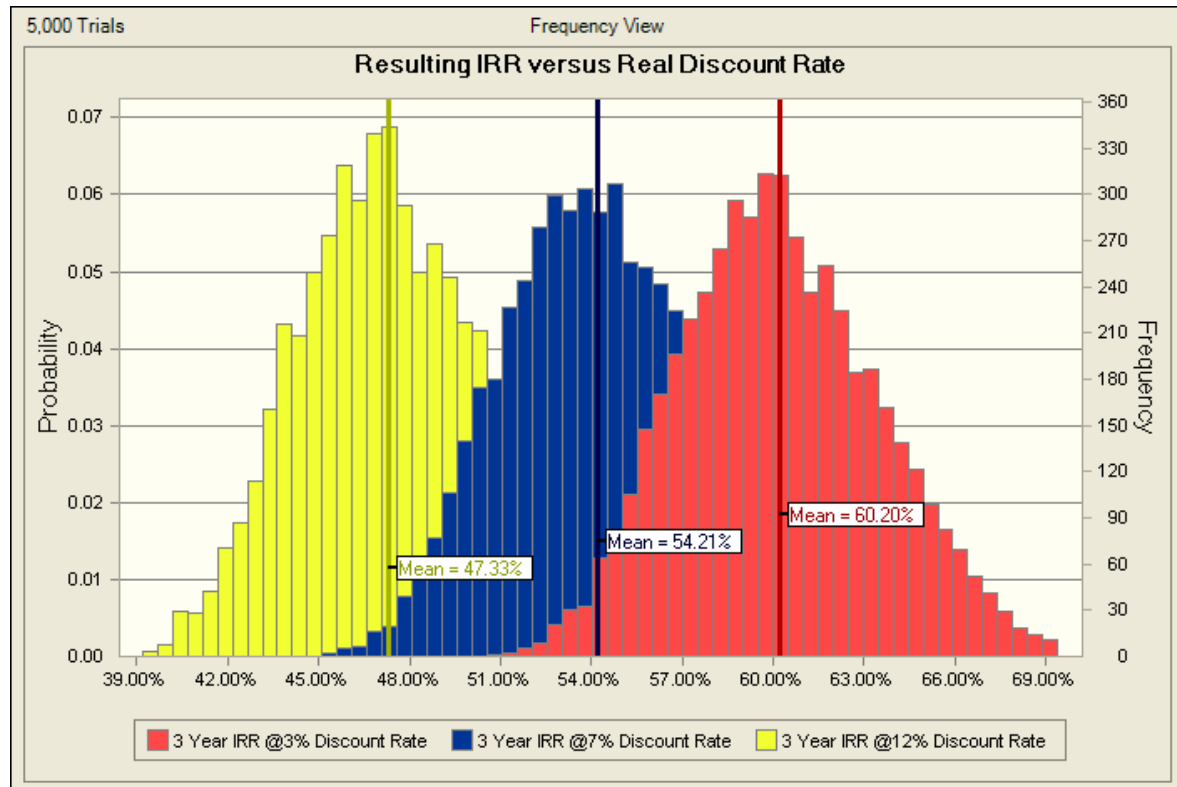

Figure E-2: NPV Sensitivity

The following charts and tables describe the sensitivity of the analysis to changes in real discount rate. As previously mentioned, three discount rates were examined: 3, 7, and 12%. The impact of these different rates is plotted against both the IRR and NPV. The major conclusion to be drawn from this is that while the discount rate has a significant impact on the results, the implementation maintains both a positive IRR and NPV.



**Resulting IRR versus Real Discount Rate Table**

Statistic	3% Discount Rate	7% Discount Rate	12% Discount Rate
Mean	60.20%	54.21%	47.33%
Median	60.03%	54.09%	47.19%
Standard Deviation	3.29%	3.15%	3.01%
Skewness	0.20701	0.16855	0.18825
Kurtosis	2.73	2.73	2.74
Coeff. of Variability	0.05458	0.05816	0.06365
Minimum	51.01%	45.38%	39.18%
Maximum	70.77%	64.38%	57.55%
Mean Std. Error	0.05%	0.04%	0.04%
Percentage Ranges			
10%	56.03%	50.16%	43.55%
50%	60.03%	54.09%	47.19%
90%	64.64%	58.41%	51.31%

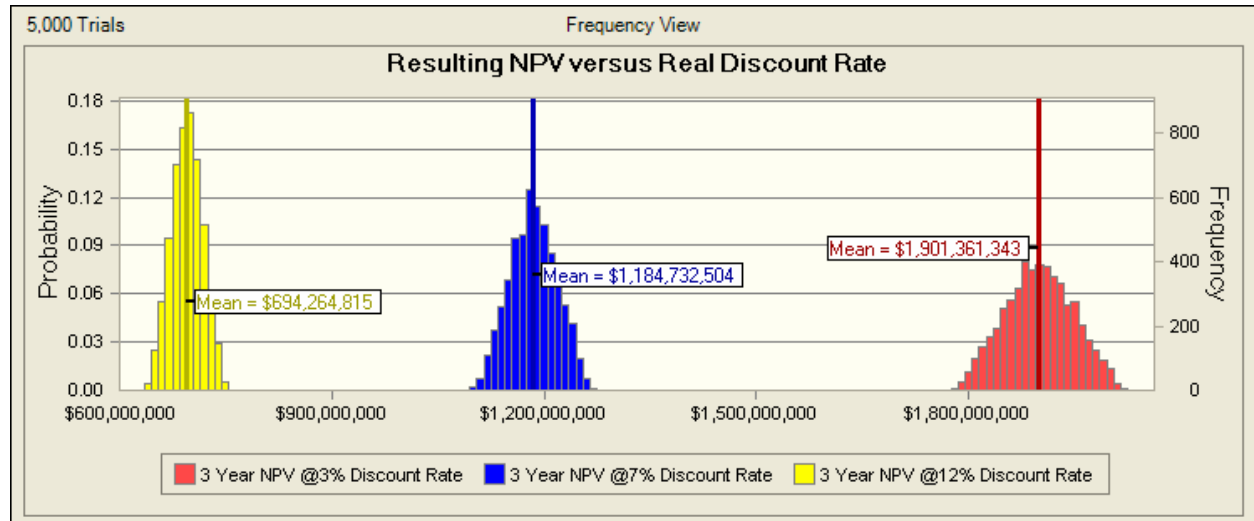

### Resulting NPV versus Real Discount Rate

Statistic	3% Discount Rate	7% Discount Rate	12% Discount Rate
Mean	\$1,901,361,343	\$1,184,732,504	\$694,264,815
Median	\$1,900,909,559	\$1,184,501,924	\$694,319,111
Standard Deviation	\$47,933,348	\$32,560,704	\$21,790,706
Skewness	0.00392	-0.00184	-0.00685
Kurtosis	2.44	2.47	2.54
Coeff. of Variability	0.02521	0.02748	0.03139
Minimum	\$1,773,560,308	\$1,094,732,269	\$633,368,372
Maximum	\$2,026,851,827	\$1,271,008,349	\$755,395,256
Mean Std. Error	\$677,880	\$460,478	\$308,167
Percentage Ranges			
10%	\$1,836,545,323	\$1,141,206,168	\$665,451,368
50%	\$1,900,909,559	\$1,184,501,924	\$694,319,111
90%	\$1,965,303,962	\$1,229,009,872	\$723,410,636





U.S. Department of Transportation  
Federal Railroad Administration

# Electronically Controlled Pneumatic (ECP) Brakes

Briefing for Release of ECP Implementation Report and  
Announcement of Regulatory Initiative

August 2006



## How Are ECP Brakes Different From Current Train Brakes?

- Electronically Controlled Pneumatic (ECP) brakes are a tested technology that offers major benefits in freight train handling, car maintenance, fuel savings, and network capacity.
- Their use could significantly enhance rail safety and efficiency.



## How Are ECP Brakes Different From Current Train Brakes?

- With the present system (developed in the 1870's), freight train cars brake individually, at the speed of the air pressure moving from car to car, along trains that are often well over a mile in length.
- This conventional braking contributes to excessive in-train forces, challenges in train handling, longer stopping distances, and safety risks of prematurely depleting air brake reservoirs. These problems are greatly reduced in the ECP brake mode of operation, during which all cars brake simultaneously, driven by an electronic signal.



# How Are ECP Brakes Different From Current Train Brakes?

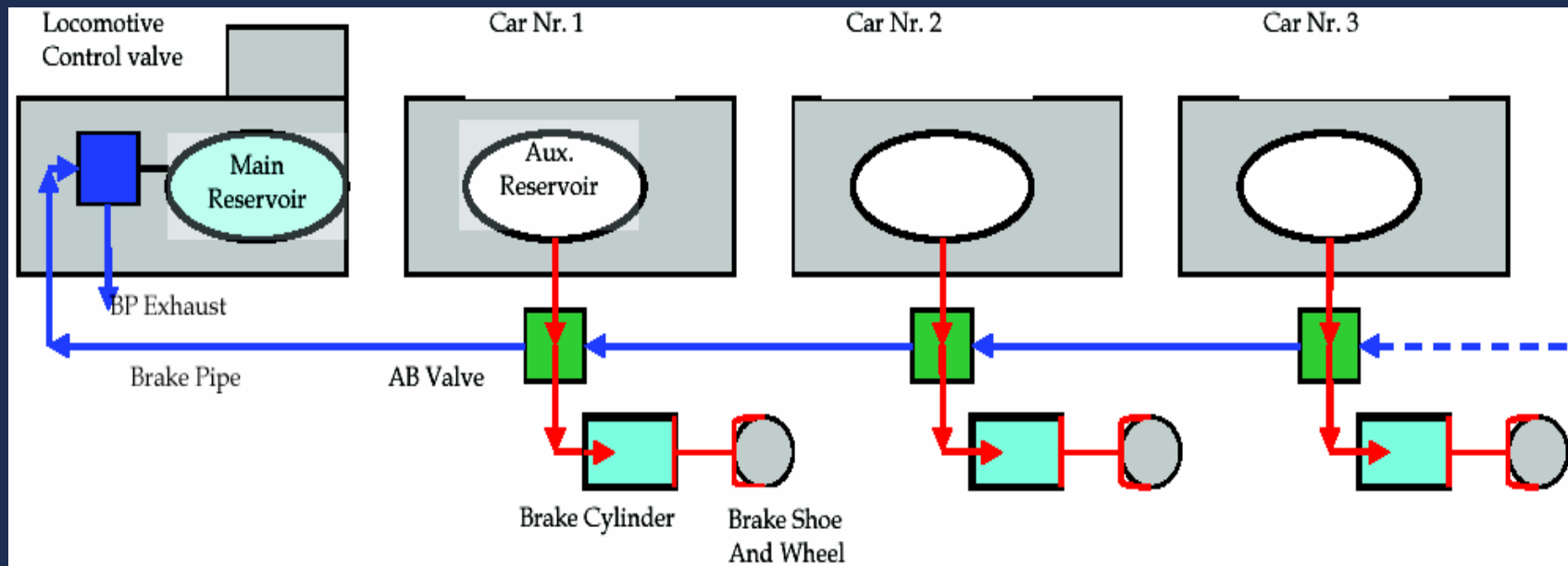

With current braking systems, after the brakes are applied in the front of the train, the rear of train is still waiting for the signal to travel to put the brakes on, and the rear of the train is still running without brakes applied causing in-train Forces.



## How Are ECP Brakes Different From Current Train Brakes?

- ECP systems *simultaneously* apply and release freight car airbrakes
  - Through a hard-wired electronic pathway down the length of the train.
  - No delay, and no run-in of slack from the rear of the train.



## How Are ECP Brakes Different From Current Train Brakes?

- Brake releases cannot be operated in a graduated manner with current brakes.
- ECP brakes allow the engineer to “back off” braking effort to match track grade and curvature, without completely releasing the brakes.
  - Saves fuel and reduces emissions
  - Reduces wear/stress on wheels and brake shoes
  - Reduces chance of run-away from overheating of the brake shoe/wheel interface



## How Are ECP Brakes Different From Current Train Brakes?

- Current train handling procedures require anticipation of draft (pulling) and buff (compressive) forces within the train, particularly in hilly terrain.
  - Any misstep can result in derailment.
- ECP brakes provide a tool to manage in-train forces and reduce train handling derailments.



## How Are ECP Brakes Different From Current Train Brakes?

- Current brakes are operated through use of brake pipe pressure reductions, which signal valves to release air from individual reservoirs into the brake cylinders on each car.
  - Repeated brake pipe reductions can deplete the brake pipe and cause a run-away train.
- ECP-braked trains are controlled by electronic messages, so that the brake pipe is not depleted of air and is constantly being charged during the brake application.





## How Are ECP Brakes Different From Current Train Brakes?

- Current brakes are very complex and subject to failure, which is a maintenance challenge and a safety concern. For instance, current brakes—
  - Are prone to causing undesired emergency applications (UDEs), which can result in delay and even derailment;
  - Can stop working on individual cars en route without the locomotive engineer being aware.
- ECP brakes are not susceptible to UDEs, and the health of the braking system on all cars is reported to the locomotive engineer in real time.



## What does this mean for Safety?

- Shorter stopping distances, in the range of 40-60 percent.
  - Reduced number and severity of collisions with obstacles on the railroad, including vehicles stuck on grade crossings; and
  - Reduced or less severe train-to-train collisions.
- Reduced chances of runaway trains, reduced train handling derailments.
- Wiring the train provides a platform for the gradual addition of other train performance monitoring devices using sensor-based technology to maintain a continuous feedback loop on train condition for the crew.



# Why hasn't this been done already?

- ECP brake technology was developed in the 1990's by the railroads and brake suppliers, but...
- Cost-effective applications will require “stand alone” ECP brakes, which will have only limited compatibility with conventional systems.

## ECP Tests and Conversions

- 1995: BNSF testing of ECP on selected unit coal, taconite and doublestack trains
- 1995: CR testing of ECP on one unit coal train
- 1995: CP testing of ECP on one intermodal train
- 1998: Quebec Cartier Mining begins converting its iron ore trains to ECP
- 2000: CSX and Southern Companies conduct limited tests of ECP on unit coal trains, which are hampered by the inability to match ECP power to ECP cars



# Why hasn't this been done already?

- ECP brakes are a major capital investment (on the order of \$6 billion for all locomotives and cars).
- The majority of costs will fall on car owners (most cars are privately owned by shippers or leasing companies); however, the majority of benefits will flow to the railroads.
- Moving from conventional to ECP brakes will be logistically difficult, and small railroads will face significant costs downstream.
- All North American freight railroads will eventually need to convert.



## Why should it happen now?

- In the interest of safety, FRA commissioned a report by Booz Allen Hamilton to describe a path to ECP implementation. The Report suggests that—
  - ECP technology can return substantial benefits;
  - As applied to western coal service, the business case is substantial; and
  - ECP implementation in other market sectors appears plausible as industry gains confidence.
- Rail capacity issues are critical
- Non-capacity related ECP savings lie in three areas: fuel, wheel wear and avoiding the necessity of an intermediate brake test (regulatory adaptation)



# US Class I Railroad Major ECP Cost Savings

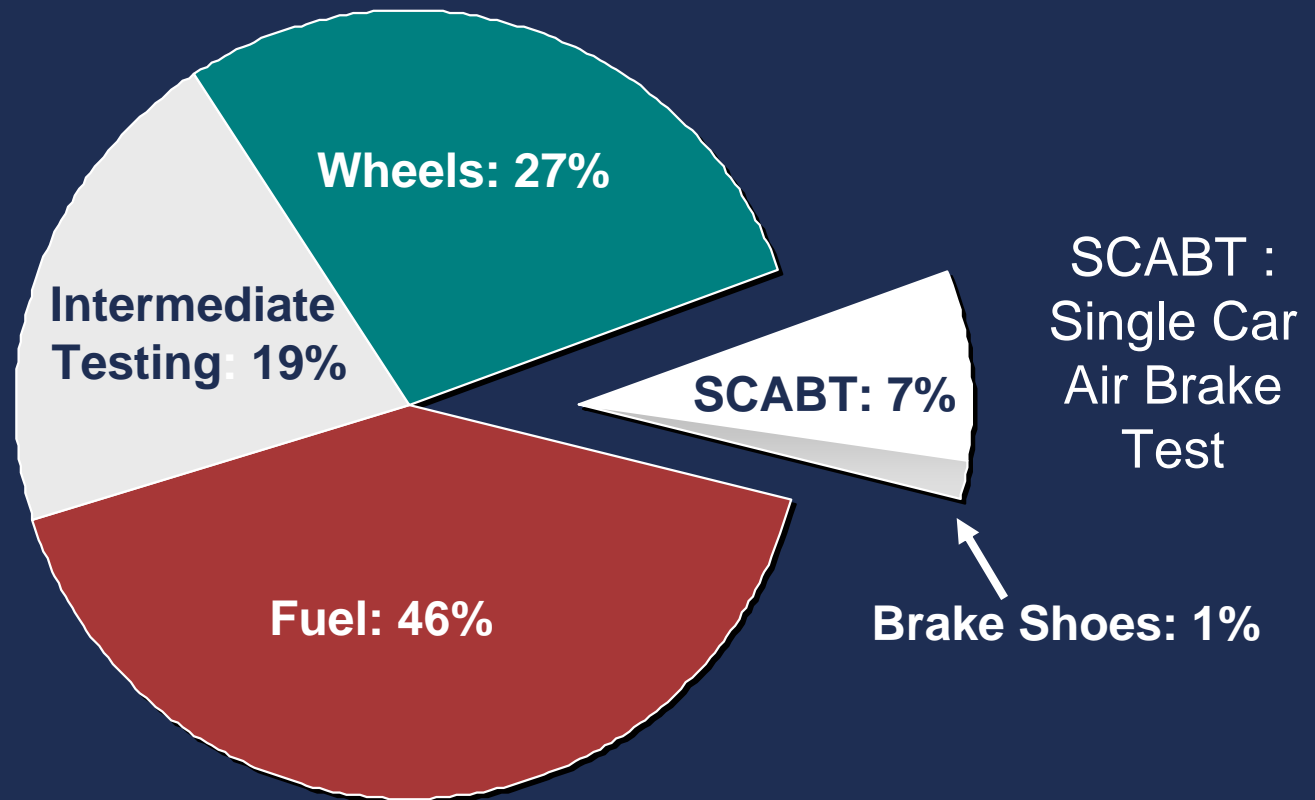

**Total = \$650 million per year**

Source: Booz Allen analysis



**Preliminary financials for Powder River Basin coal service implementation indicate a 3-year payback, an internal rate of return of 47%, and a net present value of almost \$700 million**

One-Time Costs	Amount (\$ million)	Annual Benefits	Amount (\$ million)
Locomotive Conversion @ \$40,000 per unit	112	Fuel Savings	78
Freight Car Conversion @ \$4,000 per car	320	Reduced Wheel Defects	45
		Brake Inspection Savings	45
		Brake Shoe Savings	2
<b>Total</b>	<b>432</b>	<b>Total</b>	<b>170</b>

Source: Booz Allen analysis, using a discount rate of 12%



## How do we know it's ready and will work as advertised?

- ECP brakes have previously been tested and demonstrated in the U.S., and they have been adopted in revenue service by railroads in Canada, Australia and South Africa.
- South Africa's Spoornet has embraced ECP for its huge export coal operations, reporting savings in train energy consumption of 23%.
- Electronic monitoring on Spoornet's ECP-equipped trains has increased capacity, reducing turn times by 9%.







## How do we know it's ready and will work as advertised?

- Growth in demand for U.S. coal and for import goods, coupled with limits on motor carriers' ability to expand due to driver shortages and other factors, indicate that North American rail network congestion will be a major concern for the foreseeable future.
- ECP-braked trains will move more efficiently.
- Higher velocity will result in greater network capacity.
- Industry-wide equipment savings of up to \$2.5 billion will result from a 1 mph gain in network velocity.



## Rail network capacity and operational benefits of ECP brakes



- Better braking performance will provide railroads the opportunity to increase consist lengths, but actually reduce the need to block road crossings for long periods of time.
- Increased braking efficiency will support reduced train spacing.
- Locomotive engineers can operate their trains more effectively knowing their air supply will not need as frequent charging and their stopping distances are reduced.



# What do we need to do to make it happen?

- Provide regulations that fit
- Start where the benefits are clear
- Build confidence
- Prepare for the transition
- Roll out by market sector





# What do we need to do to make it happen?

- Provide regulations that fit
  - Industry and FRA have studied ECP brake safety issues, and a substantial body of standards and analysis is already available
  - FRA is developing a Notice of Proposed Rulemaking that will describe safety requirements for ECP-braked trains
- Issue NPRM in May 2007
  - Many requirements of existing regulations will be inapplicable
  - New regulations will address acceptance of electronic systems using a performance-based approach



# What do we need to do to make it happen?

- Start where the benefits are clear

## Intermodal

### Grain



### Coal



High Mileage  
Dedicated Trains  
High Traffic Percentage

### Non-metallic minerals



### Ores



### Set-up Automobiles





# What do we need to do to make it happen?

- Build confidence
  - Need to take data from initial implementations and validate the business case
- FRA role with railroads and shippers
  - Shippers need reassurance that service will remain stable through carrier provision of ECP-equipped locomotives
  - Locomotive and train crew members will need to have training and gain experience using this technology to the best effect



# What do we need to do to make it happen?

- Prepare for the transition
  - Immediate shift to ECP brakes is not possible
  - Obstacles include capital requirements and logistical difficulties
  - Adoption of industry interchange standards that make new equipment ECP-ready (e.g., more easily converted) will be critical
    - Association of American Railroads already has proposed standards changes under consideration
  - FRA will work with parties to help overcome other obstacles



# What do we need to do to make it happen?

- Roll out by market sector
  - Railroads and major shipping communities need to define relevant sectors and begin making plans
  - Practical obstacles must be identified and overcome







# Who will benefit from ECP Brakes?

- ***Railroads***, through more efficient operations
- ***Rail shippers and car owners***, through improved asset utilization, improved service, and reduced costs
- ***Railroad employees and the public***, through improved safety on the railroad and by keeping shipments on the rails that would otherwise burden congested highways
- ***The National economy and the environment***, by making better use of fossil fuels and contributing to transportation capacity