



U.S. Department of
Transportation

Federal Railroad
Administration

Linear Friction Welding for Constructing and Repairing Rail for High Speed and Intercity Passenger Service Rail

Office of Research,
Development,
and Technology
Washington, D.C. 20590



NOTICE

This document is disseminated under the sponsorship of the Department of Transportation in the interest of information exchange. The United States Government assumes no liability for its contents or use thereof. Any opinions, findings and conclusions, or recommendations expressed in this material do not necessarily reflect the views or policies of the United States Government, nor does mention of trade names, commercial products, or organizations imply endorsement by the United States Government. The United States Government assumes no liability for the content or use of the material contained in this document.

NOTICE

The United States Government does not endorse products or manufacturers. Trade or manufacturers' names appear herein solely because they are considered essential to the objective of this report.

REPORT DOCUMENTATION PAGE			<i>Form Approved</i> <i>OMB No. 0704-0188</i>	
Public reporting burden for this collection of information is estimated to average 1 hour per response, including the time for reviewing instructions, searching existing data sources, gathering and maintaining the data needed, and completing and reviewing the collection of information. Send comments regarding this burden estimate or any other aspect of this collection of information, including suggestions for reducing this burden, to Washington Headquarters Services, Directorate for Information Operations and Reports, 1215 Jefferson Davis Highway, Suite 1204, Arlington, VA 22202-4302, and to the Office of Management and Budget, Paperwork Reduction Project (0704-0188), Washington, DC 20503.				
1. AGENCY USE ONLY (Leave blank)		2. REPORT DATE August 2016		3. REPORT TYPE AND DATES COVERED Technical Report – September 2015
4. TITLE AND SUBTITLE Use of Translational Friction Welding for Constructing and Repairing Rail for High Speed and Intercity Passenger Service Rail			5. FUNDING NUMBERS DTFR53-13-C-00041	
6. AUTHOR(S) Seth Shira				
7. PERFORMING ORGANIZATION NAME(S) AND ADDRESS(ES) EWI 1250 Arthur E. Adams Drive Columbus, OH 43221			8. PERFORMING ORGANIZATION REPORT NUMBER EWI Report No. 54368GTH	
9. SPONSORING/MONITORING AGENCY NAME(S) AND ADDRESS(ES) U.S. Department of Transportation Federal Railroad Administration Office of Railroad Policy and Development Office of Research, Development, and Technology Washington, DC 20590			10. SPONSORING/MONITORING AGENCY REPORT NUMBER DOT/FRA/ORD-16/32	
11. SUPPLEMENTARY NOTES COR: Cameron D. Stuart				
12a. DISTRIBUTION/AVAILABILITY STATEMENT This document is available to the public through the FRA Web site at http://www.fra.dot.gov .			12b. DISTRIBUTION CODE	
13. ABSTRACT (Maximum 200 words) This project developed a solid-state welding process based on linear friction welding (LFW) technology. While resistance flash welding or thermite techniques are tried and true methods for joining rails and performing partial rail replacement repairs, large heat inputs and residual stresses (associated with rail shortening) can degrade the performance of the welded area. LFW greatly reduces material loss, minimizes shortening of the rail assembly, and reduces weld heat input when compared to traditional rail joining methods. EWI teamed with APCI and LLC to develop a unique 150-ton LFW system, which uses mechanical oscillation and is relatively compact when compared to traditional hydraulic oscillation systems. Weld trails were completed using 136 lb rail. The experiments showed that using LFW to join rail was not only feasible but the technology has the potential to greatly improve the quality of continuously welded rail. Future research efforts should focus on obtaining optimum weld process parameters and reducing weld cycle times by adjusting pre-heat temperatures, oscillation forces, and durations.				
14. SUBJECT TERMS Rail, rail welding, rail joining, linear friction welding, heat affected zone, translational friction welding			15. NUMBER OF PAGES 43	
			16. PRICE CODE	
17. SECURITY CLASSIFICATION OF REPORT Unclassified	18. SECURITY CLASSIFICATION OF THIS PAGE Unclassified	19. SECURITY CLASSIFICATION OF ABSTRACT Unclassified	20. LIMITATION OF ABSTRACT SAR	

METRIC/ENGLISH CONVERSION FACTORS

ENGLISH TO METRIC

METRIC TO ENGLISH

<p>LENGTH (APPROXIMATE)</p> <p>1 inch (in) = 2.5 centimeters (cm)</p> <p>1 foot (ft) = 30 centimeters (cm)</p> <p>1 yard (yd) = 0.9 meter (m)</p> <p>1 mile (mi) = 1.6 kilometers (km)</p>	<p>LENGTH (APPROXIMATE)</p> <p>1 millimeter (mm) = 0.04 inch (in)</p> <p>1 centimeter (cm) = 0.4 inch (in)</p> <p>1 meter (m) = 3.3 feet (ft)</p> <p>1 meter (m) = 1.1 yards (yd)</p> <p>1 kilometer (km) = 0.6 mile (mi)</p>
<p>AREA (APPROXIMATE)</p> <p>1 square inch (sq in, in²) = 6.5 square centimeters (cm²)</p> <p>1 square foot (sq ft, ft²) = 0.09 square meter (m²)</p> <p>1 square yard (sq yd, yd²) = 0.8 square meter (m²)</p> <p>1 square mile (sq mi, mi²) = 2.6 square kilometers (km²)</p> <p>1 acre = 0.4 hectare (he) = 4,000 square meters (m²)</p>	<p>AREA (APPROXIMATE)</p> <p>1 square centimeter (cm²) = 0.16 square inch (sq in, in²)</p> <p>1 square meter (m²) = 1.2 square yards (sq yd, yd²)</p> <p>1 square kilometer (km²) = 0.4 square mile (sq mi, mi²)</p> <p>10,000 square meters (m²) = 1 hectare (ha) = 2.5 acres</p>
<p>MASS - WEIGHT (APPROXIMATE)</p> <p>1 ounce (oz) = 28 grams (gm)</p> <p>1 pound (lb) = 0.45 kilogram (kg)</p> <p>1 short ton = 2,000 pounds (lb) = 0.9 tonne (t)</p>	<p>MASS - WEIGHT (APPROXIMATE)</p> <p>1 gram (gm) = 0.036 ounce (oz)</p> <p>1 kilogram (kg) = 2.2 pounds (lb)</p> <p>1 tonne (t) = 1,000 kilograms (kg) = 1.1 short tons</p>
<p>VOLUME (APPROXIMATE)</p> <p>1 teaspoon (tsp) = 5 milliliters (ml)</p> <p>1 tablespoon (tbsp) = 15 milliliters (ml)</p> <p>1 fluid ounce (fl oz) = 30 milliliters (ml)</p> <p>1 cup (c) = 0.24 liter (l)</p> <p>1 pint (pt) = 0.47 liter (l)</p> <p>1 quart (qt) = 0.96 liter (l)</p> <p>1 gallon (gal) = 3.8 liters (l)</p> <p>1 cubic foot (cu ft, ft³) = 0.03 cubic meter (m³)</p> <p>1 cubic yard (cu yd, yd³) = 0.76 cubic meter (m³)</p>	<p>VOLUME (APPROXIMATE)</p> <p>1 milliliter (ml) = 0.03 fluid ounce (fl oz)</p> <p>1 liter (l) = 2.1 pints (pt)</p> <p>1 liter (l) = 1.06 quarts (qt)</p> <p>1 liter (l) = 0.26 gallon (gal)</p> <p>1 cubic meter (m³) = 36 cubic feet (cu ft, ft³)</p> <p>1 cubic meter (m³) = 1.3 cubic yards (cu yd, yd³)</p>
<p>TEMPERATURE (EXACT)</p> <p>$[(x-32)(5/9)]\text{ }^\circ\text{F} = y\text{ }^\circ\text{C}$</p>	<p>TEMPERATURE (EXACT)</p> <p>$[(9/5)y + 32]\text{ }^\circ\text{C} = x\text{ }^\circ\text{F}$</p>

QUICK INCH - CENTIMETER LENGTH CONVERSION



QUICK FAHRENHEIT - CELSIUS TEMPERATURE CONVERSION

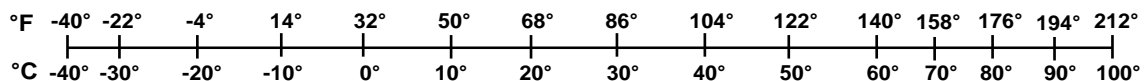

For more exact and or other conversion factors, see NIST Miscellaneous Publication 286, Units of Weights and Measures. Price \$2.50 SD Catalog No. C13 10286

Updated 6/17/98

Acknowledgements

We express thanks to APCI, our partner in this effort. Their innovative Linear Friction Welding (LFW) technology, their commitment to advancing manufacturing, and their in-kind contributions are the key to our success, without which this project would never have been possible.

Contents

Acknowledgements.....	iv
Executive Summary.....	1
1. Introduction.....	2
1.1 Background.....	2
1.2 Project Objectives.....	3
2. Phase 1 Overview.....	4
3. Phase 2 – Machine Design, Fabrication, and Run Off.....	11
3.1 Linear Friction Welding System Design.....	11
3.2 Machine Fabrication.....	12
3.3 Operational Validation and Machine Run Off.....	14
4. Experimental Welding Trials.....	18
4.1 Welding Trials.....	18
4.2 Weld Quality Evaluation.....	20
5. Discussion and Conclusions.....	27
6. Future Research.....	31
7. References.....	33
Abbreviations and Acronyms.....	34

Illustrations

Figure 1. LFW Process Illustration.....	3
Figure 2. Phase 2 Work Plan.....	3
Figure 3. 100T LFW System Developed by APCI (<i>courtesy APCI</i>).....	4
Figure 4. Two, 4-in. Long Rail Test Samples of 136RE	4
Figure 5. Hardness Traverse of Web and Section View Depicting the Area of Indentations.....	9
Figure 6. Macro View of Weld 944 Taken from Base of Rail.....	10
Figure 7. Isometric View of LFW System.....	11
Figure 8. Electric Drive Motor.....	12
Figure 9. Large Oscillator Bearings Shown during Assembly	13
Figure 10. Side View of Frame; Forging Support (left), and Forging Bed (right)	13
Figure 11. Assembled System Platform and Accessories with Hydraulics and Controls in Place	14
Figure 12. 3-in. ² Welds Made under Testing Conditions	15
Figure 13. Plot of Weld 81 Machine Data	16
Figure 13. Weld No. 84 Viewed from above (note uniform flash curl)	16
Figure 14. Cross Section of Upper Section of Rail Head for Weld 84.....	17
Figure 15. Example of a Machine Output Plot	19
Figure 16. Weld 107 in the As-received Condition	20
Figure 17. Weld 109 Web Being Laser Scanned for Alignment	21
Figure 18. Positions of Alignment Measurements.....	22
Figure 19. Cross Section of Weld 107 Head.....	23
Figure 20. Macrograph of Weld 103 Web (right) with Location of 500× Micrograph (left) Marked	24
Figure 21. Example of Sulfide Stringer in Weld	24
Figure 22. Tempered Martensite Forming in a Prior Austenite Grain.....	25
Figure 23. Deformation Induced Martensite Bands.....	25
Figure 24. Typical Hardness Traverse Taken from Center of Head, 5 mm below Running Surface (red line).....	26
Figure 25. Hardness Traverse of FBW on 34.1 HRC Rail with Average LFW Hardness	28
Figure 26. Hardness Traverse of FBW on 39.6 HRC Rail with Average LFW Hardness	29
Figure 27. LFW and Heating Profile for Current and Resistance Pre-heated Process	32

Tables

Table 1.	Weld Data for 136RE Rail Samples Welded on APCI 100-ton Welder.....	7
Table 2.	Destructive Test Results for Welds.....	8
Table 3.	Welding Conditions for Run-off Welds.....	16
Table 4.	Welding Conditions as Programmed in the 150-ton LFW System.....	19
Table 5.	Machine Output Results of Experimental Test Welds.....	20
Table 6.	AREMA Standard for Post Weld Alignment ⁽⁶⁾	21
Table 7.	Alignment Measurements Taken with Laser Height Sensor	23
Table 8.	Mechanical Test Results from Select Experimental Trials.....	27
Table 9.	Mechanical Test Results Compared to Minimum Rail Strength Requirements.	31

Executive Summary

This project developed a unique linear friction welding (LFW) machine and process for joining full size rail as an alternative to the flash butt welding (FBW) and the thermite welding processes. The objective was to demonstrate a new weld process which improved weld quality over traditional rail joining methods. The project consisted of two distinct phases.

In Phase 1, EWI (a leader in developing advanced manufacturing technology) determined that the rail could be welded using linear friction welding. After mechanical testing of select welds, EWI found that they had good mechanical properties in comparison to the base rail. This created the potential for far fewer repairs to new continuous welded rail lines in the future. Initial testing revealed that the current welding machine capacity was insufficient to join 136RE rail and thus, work was halted. While successful welds were made, the welder's capability limited the range of weld conditions. A larger LFW machine was needed to make welds with better properties.

Phase 2 was broken into two tasks. First, an LFW machine was designed and constructed for the purpose of welding 136 RE rail. Second, a series of weld trails and post-weld analyses were completed to demonstrate the capabilities of the machine and welding process. The main objective of Phase 2 was to design and fabricate a new LFW system suitable for welding full-section 136RE rail. In order to complete this work, a partnership was created between APCI, a leader in LFW machine design, and EWI.

The areas of focus for the Phase 2 team were twofold: (1) provide energy storage to ensure that friction heating is produced as desired; and (2) impose machine rigidity to ensure the system can handle the processes' demands. APCI used the recommendations and experience of EWI to build the LFW machine design. The new LFW machine consisted of a flywheel connected to the drive motor for energy storage and a rigid structure capable of withstanding a high load. APCI built in a minimum safety factor of 1.5. Once fabricated, the run-off consisted of manufacturing three full-section rail samples using conditions that were chosen to test the machine's capability envelope. These welds were an acceptable test of the system.

In the final part of Phase 2, EWI and APCI collaborated to design an experimental trial set of up to 16 welds to explore the process window for LFW of 136RE rail. EWI evaluated the weld quality of 12 welds that were made successfully via visual inspection, metallographic analysis, and a hardness traverse performed on the head section. Most welds were measured for rail alignment with five selected for reduced section tensile testing. The overall results were positive. LFW performed as well as FBW with respect to rail head hardness. The soft heat-affected zone (HAZ) of the weld shifted toward the weld centerline and in some cases narrowed. The hardness of the HAZ was lower than the FBW in most cases, but after this limited experimental trial, LFW proved to have significant potential.

Further refinements of the equipment and welding process are now possible: LFW on rail has a manufacturing readiness level (MRL) between MRL5 and MRL6, production prototype components (i.e. experimental trial samples) have been produced, and the base concept for the LFW equipment is set.

1 Introduction

Both new construction and repair of continuously-welded rail (CWR) can benefit from advancements in rail joining processes. Current thermite and flash butt rail welding processes have drawbacks in quality. The weld zone is softer than the surrounding base material which leads to deterioration in the rail running surface over time. Rail welds in CWR rail are frequently cut out and repaired, but the repair strength is limited by the quality of the welding method and the quality of the weld execution.

EWI proposed that linear friction welding (LFW) could be used to weld high-speed rail. LFW is a mature, solid-state controlled welding process that can produce welds that have close to base metal properties. If weld strength is closer to that of the base material, less frequent and higher quality repairs as well as improved performance of new rail segments will result. EWI partnered with APCI to build a welding system for joining 136RE rail. EWI and APCI have a mutually beneficial relationship that utilizes the strengths of each organization. Through a collective design process, EWI and APCI developed an LFW welding system with the ability to test a range of welding parameters on 136 RE rail. EWI determined the welding conditions that provided a combination of good weld mechanical properties and cycle efficiency.

1.1 Background

LFW, also known as translational friction welding (TFW), is a friction-based welding process. An illustration of the process can be seen in Figure 1. The LFW process involves oscillating one part that is on a linear path parallel to the contact face to create heat between it and a stationary part through friction and pressure at the contact interface. While maintaining oscillation, the parts squeeze together, bringing the materials to a plastic (not melted) state. Upon reaching a set burn-off length or oscillation time, the oscillation stops with the parts aligned and compressive pressure is increased to forge the two parts together.

LFW is a solid-state welding process which has as-welded properties often superior to other welding processes. As the name implies, solid-state welding processes take place in a temperature range below the melting point of the materials being joined. Weld properties are improved in LFW because its heat input and peak temperatures are lower than other processes that deal in molten material, like thermite and FBW. Also, casting-type discontinuities and defects will not occur with LFW, as they can in thermite welding.

FBW is also considered a solid-state welding process and has a similar process sequence. The parts are butted together then heat and pressure are used to join the parts. The base material is consumed (flushed out) in the forging process forming the joint. FBW generates heat by pulling the interface open and passing an electric arc between the two faces. During this portion of the FBW process, the joint faces are molten. In contrast, LFW generates heat through friction and while micro-scale localized melting can occur in the interface, it is not exposed to the atmosphere. LFW requires less rail disruption (loss) if a new rail section must be inserted as part of a repair. The process requires less rail shortening than flash welding.

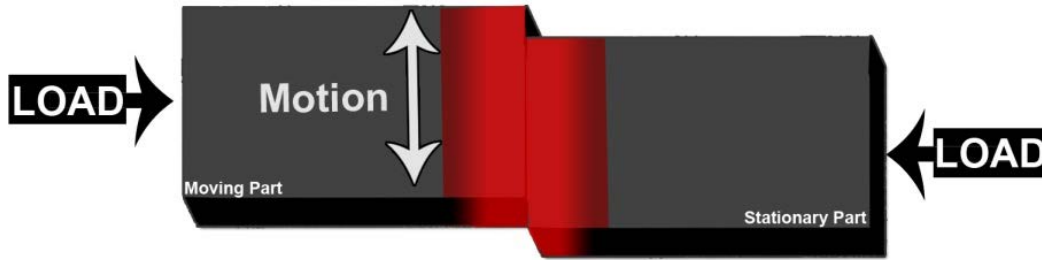

Figure 1. LFW Process Illustration

1.2 Project Objectives

The project’s goal was to demonstrate a new welding process with weld quality that is superior to traditional rail joining methods. The project consisted of two distinct phases. In Phase 1, an initial feasibility study was conducted with an existing 100 ton LFW machine. After a project gate review was done, a machine for welding 136 RE rail was designed and constructed, a series of weld trials were undertaken, and post-weld analyses were performed on the specimens. The Phase 2 work structure is shown in Figure 2.

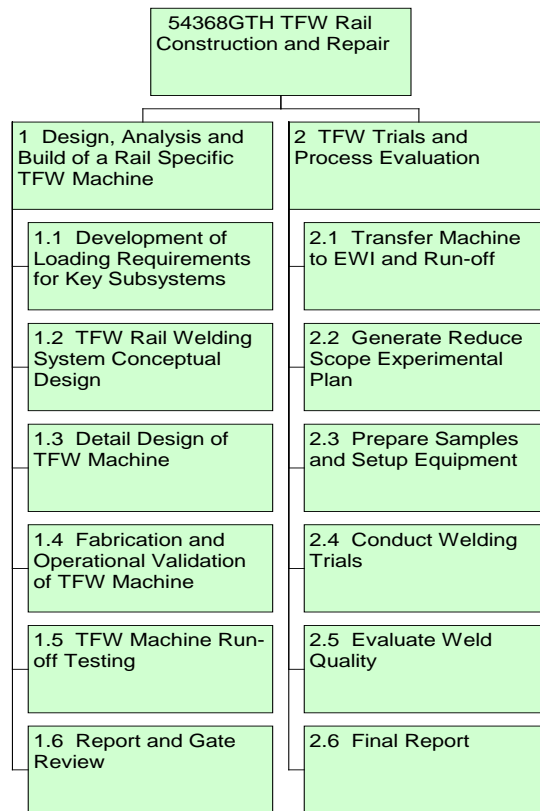

Figure 2. Phase 2 Work Plan

2 Phase 1 Overview

The project team performed investigative welding with an APCI 100-ton translational friction welding machine. The unit is shown in Figure 3. This machine's axial force is supplied by a hydraulic system and translational forces provided by two 75-HP motors. In this study, two 4-in long specimens of rail were joined to produce evaluation samples that were about 8-in long.



Figure 3. 100T LFW System Developed by APCI (courtesy APCI)



Figure 4. Two, 4-in. Long Rail Test Samples of 136RE

Table 1 provides the data for all welding trials. After some initial set-up trials, a series of process iterations were examined, including varying the actual weld area (by reducing the section size) as well as the weld normal force. These combinations were used to create variations in weld interface contact stresses.

Table 1. Weld Data for 136RE Rail Samples Welded on APCI 100-ton Welder

Sample Number	Weld Date	Special Conditions Testing Objective	Weld Area in ²	Weld Pressure * (ksi)	Time (Sec)	Forge Pressure * (ksi)	Amplitude (in)	Frequency (Hz)	PreHeat Used	COMMENTS
548	6/10/2011	Initial weld trials 546 thru 552	13.33	4.0	8	11.0	0.20	60	Furnace 932 F	partial weld (in web)
549	6/13/2011		13.33	7.0	4	11.0	0.20	60	Furnace 932 F	no weld....machine stopped
550	6/13/2011		13.33	2.0	15	11.0	0.20	60	Furnace 932 F	Broke after 3 hours
551	6/13/2011	Reduced area	4.80	6.0	3	14.0	0.20	60	Furnace 932 F	Oscillation ceased in last step before forge
552	6/14/2011		4.80	7.0	3	14.0	0.20	60	Furnace 932 F	Assembly fractured while aging
753	6/14/2011	Testing after Oscillator mods - new oscillator forward	2.68	7.0	2.5	18.0	0.24	50	Furnace 932 F	Assembly fractured while aging
754	6/15/2011	Reduced area	4.80	7.0	3.2	14.5	0.24	50	Furnace 932 F	fixture clamp hydraulic pressure 2.5 ksi
755	11/3/2011	Testing after Oscillator mods - new oscillator forward	4.80	7.0	3	14.5	0.24	50	Furnace 932 F	fixture clamp hydraulic pressure 2.5 ksi
756	11/4/2011	Reduced area	4.80	6.0	3.2	14.5	0.29	50	Furnace 932 F	fixture clamp hydraulic pressure 3.0 ksi
757	11/4/2011	Reduced area	4.80	2.2	10	14.5	0.29	50	Furnace 932 F	fixture clamp hydraulic pressure 3.0 ksi
758	11/4/2011	Begin use of manual clamp tie bolts, increase rigidity of tooling	13.33	2.0	15	14.5	0.29	50	Furnace 932 F	
759	11/4/2011	Special end shape to one rail	13.33	0.5 to 2	22	14.5	0.29	50	Furnace 932 F	
760	11/7/2011	Same as 759	13.33	0.5 to 1.9	25	14.5	0.29	50	Not Recorded	
780	11/8/2011	Same as 759	13.33	2.0	30	14.5	0.29	50	Not Recorded	weld cycle terminated
781	11/8/2011	Same as 759	13.33	2.0	30	14.5	0.29	50	Not Recorded	weld cycle terminated 85% of full interface, at EWI
782	11/14/2011	Reduced area	1.80	7.0	3.2	14.5	0.24	50	None	
783	11/15/2011	Same as 759	13.33	2.2	40	14.5	0.29	50	Furnace 932 F	90% of full interface, see met, at EWI
848	11/15/2011	After testing of 783 at EWI more trials with longer times to get full interface	13.33	1 to 1.9	60 - 20	11.5	0.29	50	None	cycle stopped no forge, upset 0.232,
849	12/9/2011		13.33	1.0	80	11.5	0.29	50	None	near full interface, upset 0.4 in, see met & mech, at EWI
850	12/9/2011		13.33	1.0	70	11.5	0.29	50	None	cycle stopped, no forge, fixture loose on bottom
851	12/9/2011	Center area relieved 0.020 in	13.33	1.0	70	11.5	0.29	50	None	cycle stopped, no forge, fixture loose on bottom
852	12/10/2011		13.33	1.0	70	11.5	0.29	50	Furnace 932 F	At EWI weld fractured after 1 week aging
853	12/10/2011	Center area relieved 0.005 in	13.33	1.0	70	11.5	0.29	50	None	cycle stopped, no weld, idler broke
854	12/10/2011	Center area relieved 0.005 in	13.33	1.0	70	11.5	0.29	50	Torch 1000 F	cycle stopped, no forge, upset 14.3 mm
919	1/16/2012	Repeating process of 849, weld cycle held until reach burnoff distance 0.15 in.	13.33	1.0	3.8-mm dist	11.5	0.29	50	Torch 1000 F	full interface, upset 0.35 in, forge held 10 sec, at EWI, see met & mech Damaged Welder
944	1/31/2012	One additional weld, weld cycle held until reach burnoff distance 0.16 in.	13.33	1.0	4.1-mm dist	11.0	0.29	50	Torch 1000 F	upset 0.35, full interface, forge held 10 sec, at EWI, see met & mech Damaged Welder

* Weld and Forge Pressure are the compressive stress for the weld interface applied by hydraulic force normal to weld plane

Table 2 lists the strength test results from selected specimens. The web and head specimen failed in a softened zone after significant necking. Metallographic sections were also prepared and evaluated.

Table 2. Destructive Test Results for Welds

Weld Number & Rail Section	Tensile 0.2% Yield	Ultimate Strength Mode & Stress	Bend Test Set 15% Elongation	Bend Test Set 10% Elongation	Met Section
	ksi	ksi	Angle Deg	Angle Deg	Quantity
849					
Head	78	Softened Zone 140	Parent 28° <	na	2
Web	90	Softened Zone 146	Parent 28° <	na	2
Base	88	Near BL 128	Weld 60°	na	2
919					
Head	110	Near BL 137	na	Parent 25° <	1
Web	103	Softened Zone 161	na	Weld 80°	1
Base	110	Near BL 119	na	Weld 80°	1
944					
Head	107	Near BL 148	na	Weld 80°	1
Web	96	Softened Zone 154	na	Weld 80°	1
Base	107	Near BL 144	na	Weld 80°	1
Base Metal					
Head	106	188	na	na	na
Web	110	175	na	na	na
Base	102	177	na	na	na

Next, microstructure and hardness results were collected for sections from the web, head, and base of each weld. Figure 5 provides example results from the web section of Weld 849. In this figure, hardness data is superimposed over a micrograph of the weld area. Two hardness traces are shown, with different spacing of indents. Generally, the hardness traverse values were symmetric about the bond line.

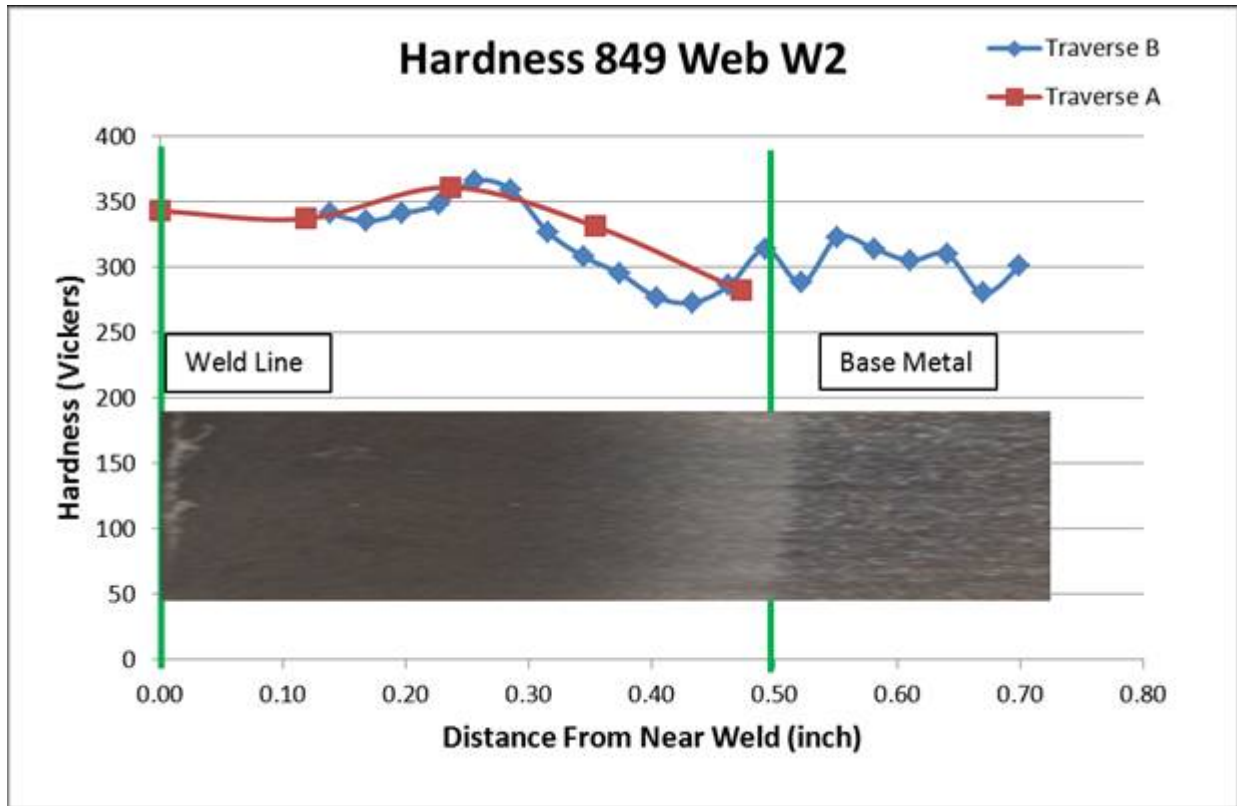

Figure 5. Hardness Traverse of Web and Section View Depicting the Area of Indentations

Figure 6 shows the macro section from the base of Weld 944. Here it can be seen that the HAZ was about 0.39 in. on both sides of the bond line. The flash is relatively symmetric indicating material displacement in both directions of oscillation. The base metal shows a coarse austenite grain size and a substructure of mixed bainite and pearlite. The area near the bond line was largely characterized by fine prior austenite grains that were transformed to an acicular ferrite/bainitic microstructure.

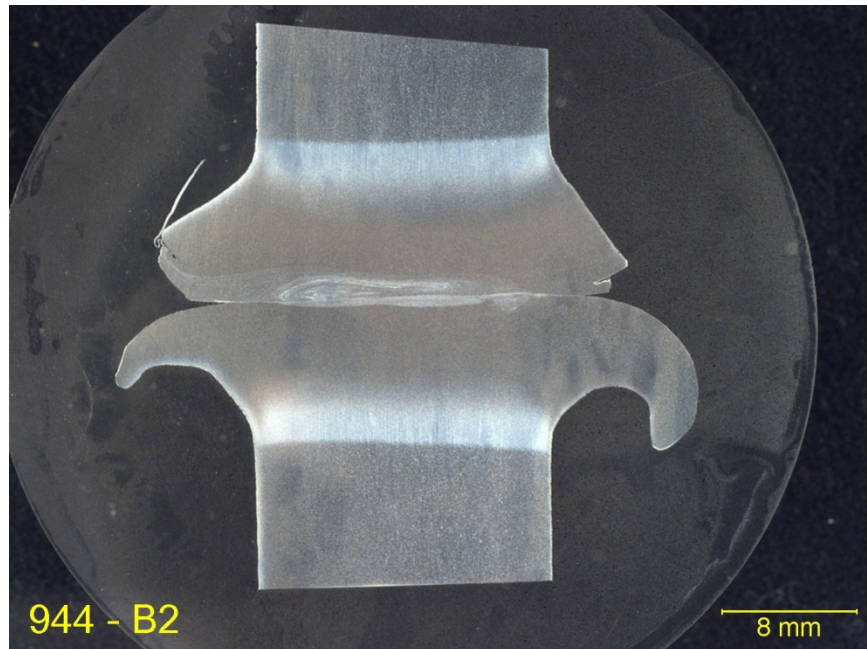

Figure 6. Macro View of Weld 944 Taken from Base of Rail

The conclusion of Phase 1 resulted in full-area or near full-area welds utilizing available equipment at the time. The LFW equipment available at APCI for Phase 1 was based on a direct-drive/programmable cam concept. Using iterative experimentation methods, 100-mm long rail segments were welded together by the LFW process producing weld samples that are roughly 200-mm long. Full-area rail sections (136RE), 13.3 in.² (8597 mm²) were welded, achieving near parent metal strength. However, the weld system had to be operated beyond its capability in order to accommodate the large weld area. Higher weld forces would be required to better control full-area contact integrity and to minimize temperature gradients between the rail head, web, and base. The lateral force generated by the existing oscillator-based equipment was insufficient for the high weld stresses required. A new welder, with higher oscillating forces to overcome the peak loads generated by the high friction excursions of the process, and greater structural rigidity, was required to test the weld process on 136RE rail.

3 Phase 2 – Machine Design, Fabrication, and Run Off

3.1 Linear Friction Welding System Design

In the beginning of Phase 2, EWI developed loading requirements for a new, more robust, high capacity LFW machine with a focus on energy storage and machine rigidity. Energy storage was needed to minimize the size of the electrical drive motor while ensuring that sufficient energy was available for friction heating of the rails. Additionally, the machine design must accommodate the high stresses and vibration resulting from the weld process while maintaining precise alignment of the rail sections. An engineering evaluation of the LFW process was performed to determine the key design characteristics - weld stress, oscillation frequency, and amplitude. Limits were placed on these characteristics that conform to both the desired welding condition window and sensible design rules. The output of this effort was a road map for the design of the machine.

- Peak weld stress (σ) = 100-125 MPa (14.5-18.1 ksi)
- Frequency = 40-50 HZ
- Amplitude (d) = 2-5 mm (0.079 – 0.197 in.)

APCI created a new LFW machine design from their extensive experience and the design parameters supplied by EWI. It has a flywheel connected to the drive motor for energy storage and a rigid structure capable of withstanding a high load. A minimum factor of safety of 1.5 was built into each component.

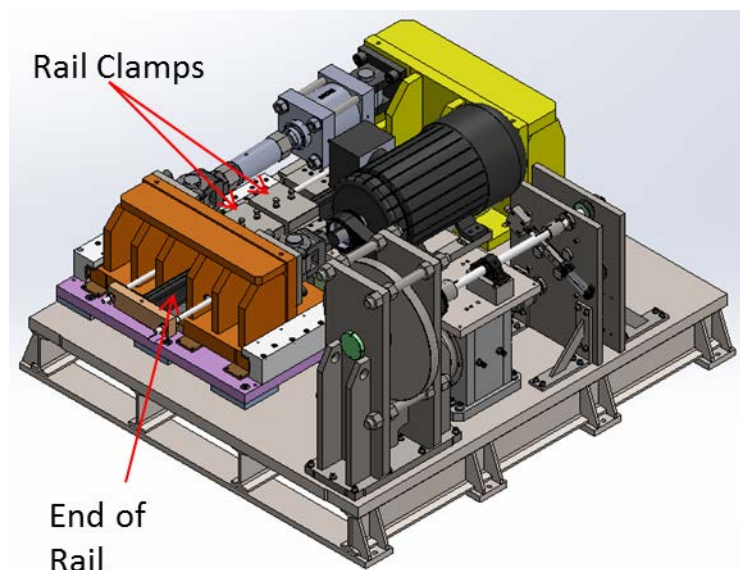

Figure 7. Isometric View of LFW System

LFW is a mature welding process that is regularly used in industry, but using LFW to full-section rail, with a non-uniform, large cross section made from high alloy steel is experimental. This machine design is not well suited for on-track welding, but this design provides the necessary capability for adjusting process variables and to isolate the best weld process for full-sized rail. The size of the system designed provides a suitable platform for development.

3.2 Machine Fabrication

The LFW machine was fabricated from September 2013 to February 2014. APCI has talented fabricators on staff and a well-equipped facility, but some components and assembly steps required subcontracting due to the size of the system.

The first step in the fabrication process was the identification and ordering of long -lead items to ensure they would be on hand at the needed time during assembly. Some of these long -lead items were the electric motor and large oscillation transmission bearings (Figure 8 and Figure 9).



Figure 8. Electric Drive Motor



Figure 9. Large Oscillator Bearings Shown during Assembly

The system is mostly comprised of fabricated steel parts. Subcontractors built the frame and forging support structure (see Figure 10).



Figure 10. Side View of Frame; Forging Support (left), and Forging Bed (right)

Finally, APCI scheduled the manufacturing and assembly of components that would be made in-house. Fabricators added controls and hydraulics after the platform and its accessories were

assembled (Fig. 11). The control system uses a Linux-based software that allows for flexible programming of process variables.

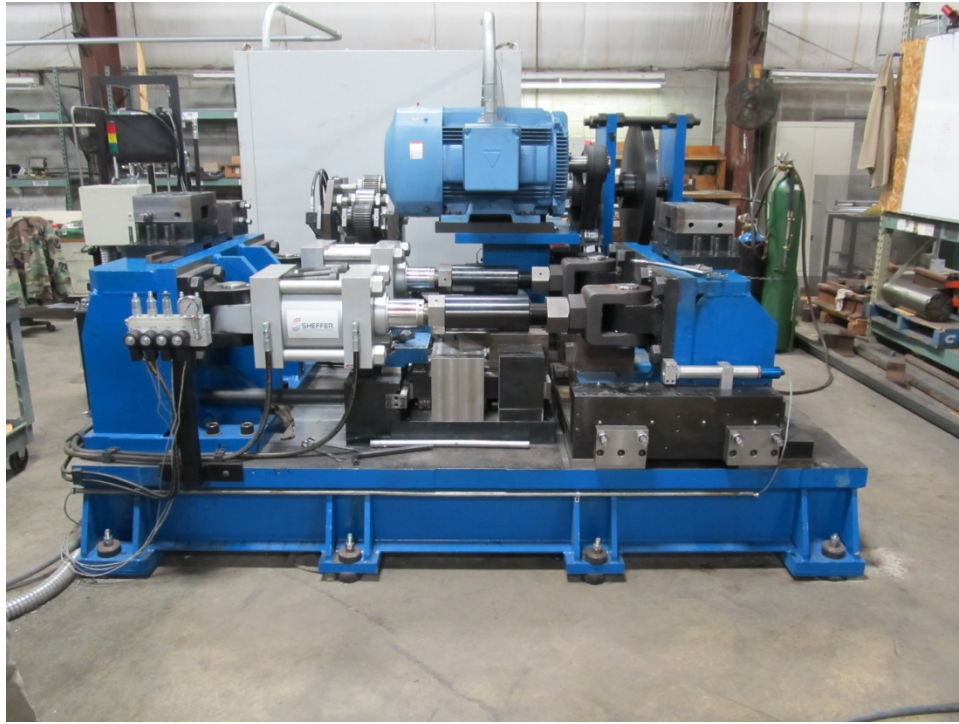

Figure 3. Assembled System Platform and Accessories with Hydraulics and Controls in Place

3.3 Operational Validation and Machine Run Off

Once the machine fabrication and software debugging were complete, APCI began operational validation. To reduce the chances of catastrophic failure on the first attempted weld, a number of samples with reduced cross section area (3 in^2 and 6 in^2) were welded before they attempted to weld a piece of full-section rail (13.3 in^2)

Figure 12 shows two of the preliminary welds: The one on the left was made during Phase 1 on the 100-ton machine and the one on the right was made with the new 150-ton system. These welds were part of an effort to determine if the new machine could produce similar looking welds to the Phase 1 machine.

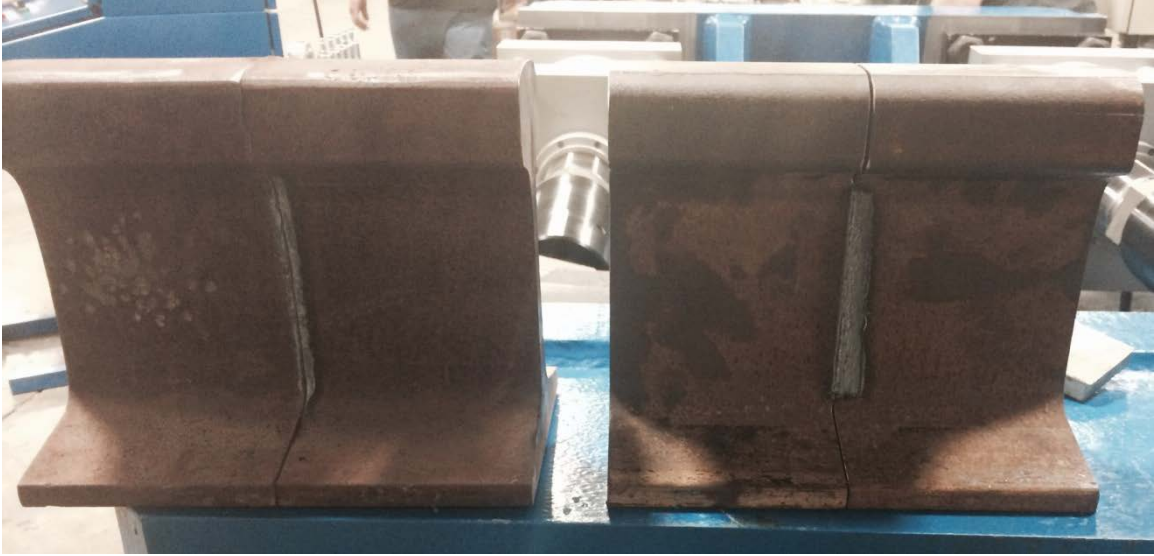

Figure 12. 3-in.² Welds Made under Testing Conditions

The run-off weld conditions were designed to test the performance envelope of the machine. Welding conditions for the run-off welds were chosen from the machine's calculated operating range. The conditions chosen for the run-off welds can be seen in Table 3, along with two variables of output data, the total distance, and the total time.

Table 3. Welding Conditions for Run-off Welds

APC		Linear Friction Weld Trials Report										162	
Customer:		EWI/FRA			Date of Weld Trials:			2-Jul-14					
Material & Part Description:					Rail Road Track 136								
		SCRUB			WELD			FORGE				RECORDED	
WELD NO.	SQ. IN.	KSI	DIST. (in.)	TIME (SEC.)	KSI	DIST. (in.)	TIME (SEC.)	KSI	TIME (SEC.)	AMP (in.)	FREQ (HZ)	TOTAL DIST. (in.)	TOTAL TIME (SEC.)
81	14	0.65	0.15	80	7.5	0.200	2	15	10	0.394	45	0.251	30.3
82	14	0.65	0.15	80	7.5	0.200	2	15	10	0.394	45	0.289	32.6
84	14	0.65	0.15	80	7.5	0.200	2	15	10	0.394	45	0.395	69.1

Plots were made from the provided machine pressure data as well as the oscillator and plate position for each weld. Figure 13 shows the plot of Weld 81 with the forge and scrub stages labeled.

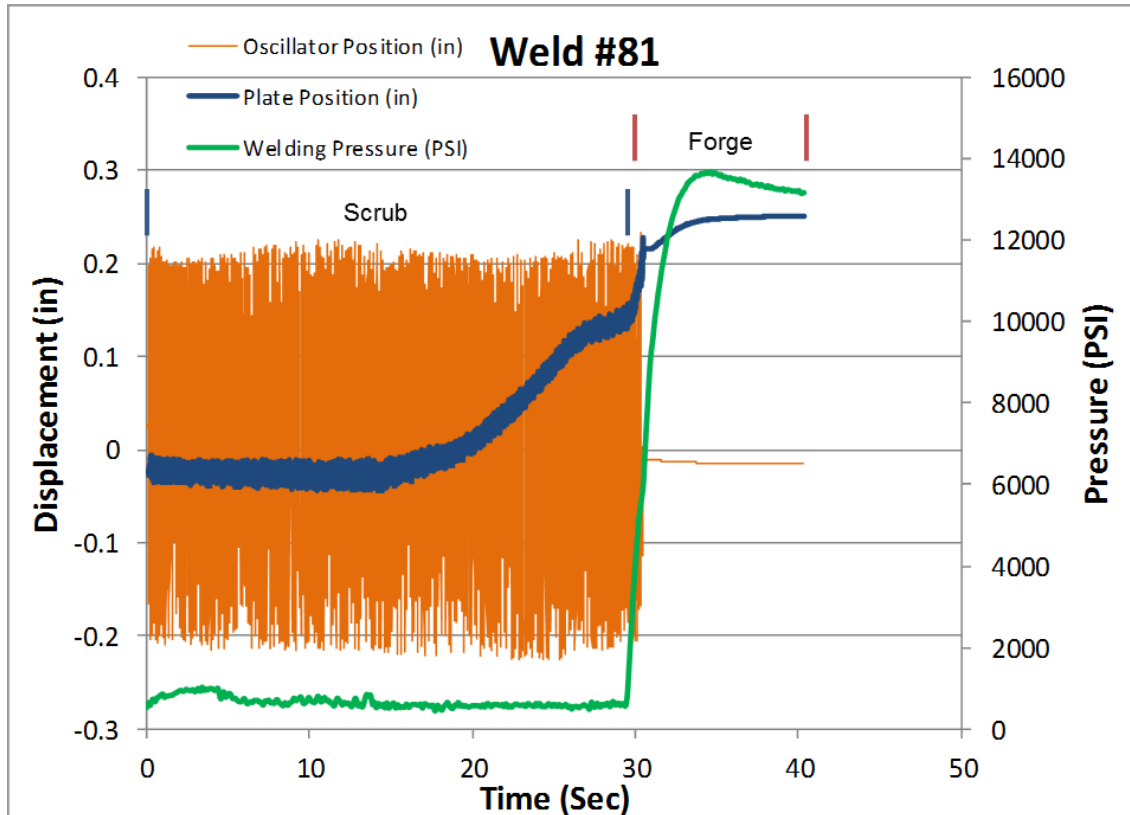

Figure 13. Plot of Weld 81 Machine Data

When the flash is examined, the welds appeared to be full-section welds that were consolidated over the entire joint face. Figure 14 shows the flash as viewed from the running surface of Weld 84.



Figure 14. Weld No. 84 Viewed from above (note uniform flash curl)

EWI performed cross-sectional analyses on Weld 82 and Weld 84, and first impressions from examining the cross section from Weld 82 (not shown) and Weld 84 (Fig. 15) was that the samples have fully-consolidated weld areas. The welds could be ground flush with no weld divot, including the areas with misalignment.

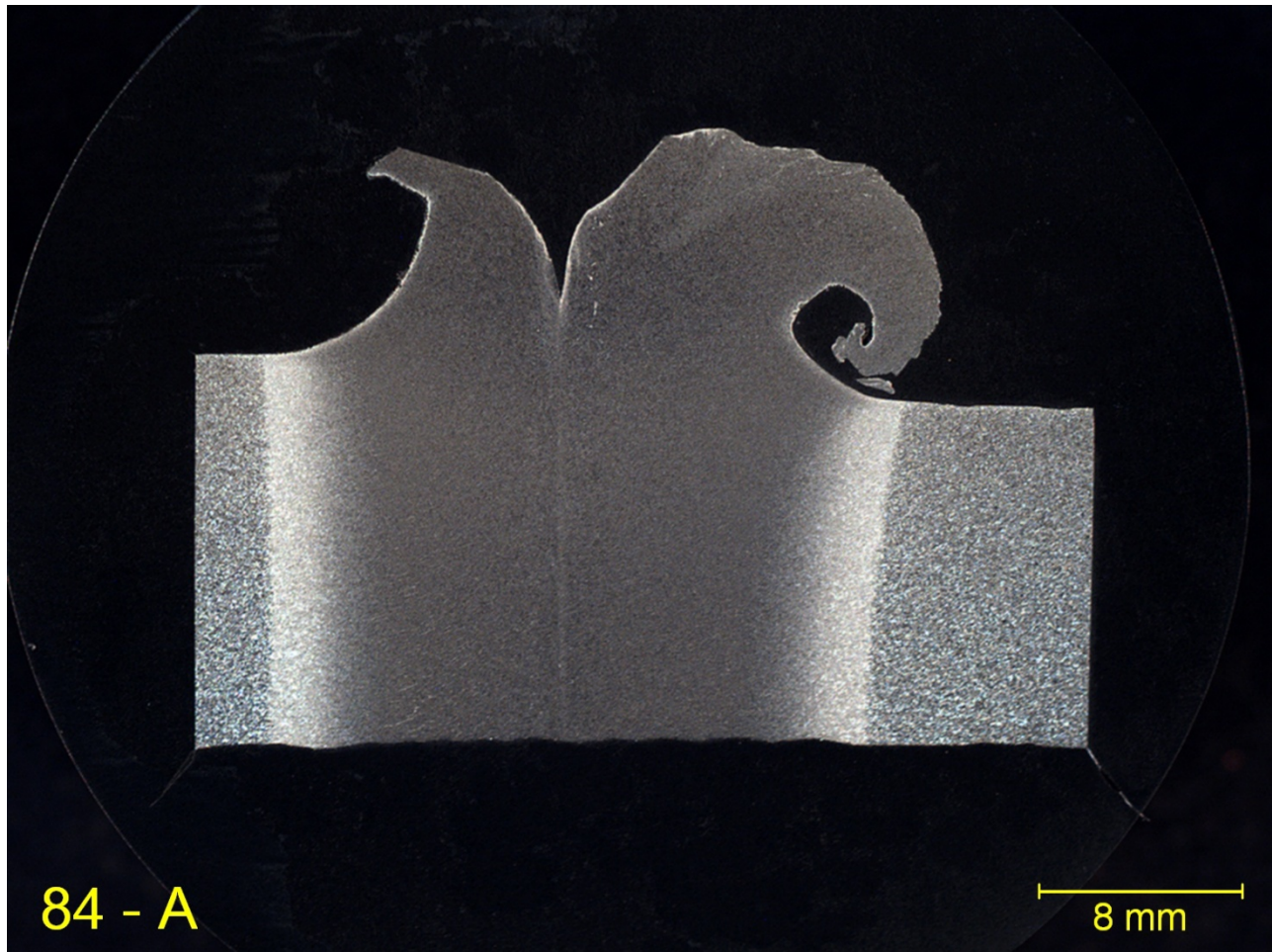

Figure 15. Cross Section of Upper Section of Rail Head for Weld 84

4 Experimental Welding Trials

4.1 Welding Trials

The experimental welding trials were divided into three rounds. The first two rounds were iterative and APCI provides information about the complete welds, including the machine output data and the general condition of the welded sample. The final round included three welds and the conditions were run as provided. EWI sent APCI twenty one conditions and received twelve welds for quality evaluation (Table 4). Not all welding conditions produced a usable sample. The weld area for all samples was the full cross section of 136RE rail, 13.3 in².

Table 4. Welding Conditions as Programmed in the 150-ton LFW System

Experimental Set	APCI Weld Number	Pre-heat	Frequency	Amplitude	Pre-Scrub Pressure	Pre-Scrub Distance	Pre-Scrub Time	Scrub Pressure	Scrub Distance	Scrub Time	Welding Pressure	Welding Distance	Welding Time	Forging Pressure	Forging Time	Weld Outcome
#	#	F	Hz	IN	PSI	IN	sec	PSI	IN	Sec	PSI	IN	Sec	PSI	Sec	
1	104	500	45	0.394	700	0.04	20	750	0.15	60	3750	0.3	3	10,000	10	Fail
1	105	500	50	0.453	700	0.04	20	750	0.15	80	3750	0.3	3	10,000	10	No Start
1	106	500	50	0.453	700	0.04	20	750	0.15	80	3750	0.3	3	10,000	10	No Start
1	107	500	45	0.453	700	0.04	20	750	0.15	80	3750	0.3	12	10,000	10	Pass
1	108	500	45	0.394	700	0.04	20	1500	0.2	60	5000	0.4	10	15,000	10	Pass
1	109	500	45	0.453	700	0.04	20	1500	0.2	80	5000	0.4	10	15,000	10	Pass
1	110	600	40	0.295	700	0.04	20	2000	0.15	40	7500	0.3	4	10,000	10	Seize
1	111	600	45	0.335	700	0.04	20	2000	0.2	80	7500	0.35	4	10,000	10	Pass
2	112	RT	45	0.335	700	0.1	50	2000	0.25	20	7500	0.45	5	12,500	15	Seize
2	113	RT	45	0.453	700	0.1	40	1500	0.2	80	5000	0.4	10	15,000	15	Seize
2	114	RT	49	0.472	700	0.1	60	2500	0.2	60	7500	0.35	4	12,500	15	No Attempt
2	115	500	45	0.335	700	0.04	20	3000	0.15	40	7500	0.4	4	12,500	15	Pass
2	116	500	45	0.453	700	0.04	20	2000	0.15	20	7500	0.45	8	12,500	15	Pass
2	117	500	45	0.394	700	0.04	20	3000	0.2	80	9500	0.35	4	15,000	15	Pass
2	118	RT	45	0.335	500	0.1	50	2000	0.25	20	7500	0.45	5	12,500	15	Seize
2	119	350	45	0.453	500	0.1	50	1500	0.2	80	5000	0.4	10	15,000	15	Pass
2	120	350	45	0.335	400	0.04	60	3000	0.15	40	7500	0.4	8	15,000	15	Seize
2	121	500	45	0.394	500	0.1	40	2000	0.2	80	7500	0.35	4	15,000	15	Pass
3	122	500	45	0.394	500	0.04	30	3000	0.125	80	9500	0.35	10	15,000	15	Pass
3	123	500	45	0.394	500	0.1	40	2000	0.125	40	7500	0.35	30	15,000	15	Pass
3	124	500	45	0.453	500	0.1	40	3000	0.2	60	7500	0.35	15	15,000	15	Pass

Table 5. Machine Output Results of Experimental Test Welds

APCI Weld Number	Pre-heat	Amplitude	Pre-Scrub Pressure	Actual Pre-Scrub Distance	Actual Pre-Scrub Time	Scrub Pressure	Actual Scrub Distance	Actual Scrub Time	Welding Pressure	Actual Welding Distance	Actual Welding Time	Forging Pressure	Forging Time	Actual Forging Distance	Final Burn off	Total Weld Time	Overall Burn Rate
#	F	IN	PSI	IN	Sec	PSI	IN	Sec	PSI	IN	Sec	PSI	Sec	IN	in	Sec	in/sec
107	500	0.453	700	0.010	20.01	750	0.126	80.02	3750	0.249	12.03	10,000	10	0.209	0.594	122	0.0049
108	500	0.394	700	0.015	20.02	1500	0.143	60.02	5000	0.274	8.585	15,000	10	0.251	0.683	98	0.0070
109	500	0.453	700	0.013	20.02	1500	0.186	80.02	5000	0.235	4.97	15,000	10	0.274	0.708	113	0.0063
111	~600	0.335	700	0.026	20.02	2000	0.136	36.9	7500	0.202	3.4	10,000	10	0.111	0.475	70.3	0.0068
115	500	0.335	700	0.067	19.8	3000	0.102	3.13	7500	0.095	4.11	12,500	15	0.002	0.266	27	0.0099
116	500	0.453	700	0.011	20.02	2000	0.056	20.01	7500	0.325	8.02	12,500	15	0.095	0.487	59.9	0.0081
117	500	0.394	700	0.017	20.02	3000	0.235	43.91	9500	0.153	2.51	15,000	15	0.214	0.619	80.9	0.0077
119	350	0.453	500	0.012	50.01	1500	0.211	80.02	5000	0.239	5.86	15,000	15	0.347	0.809	150.9	0.0054
121	500	0.394	500	0.053	40.02	2000	0.206	34.66	7500	0.089	2.36	15,000	15	0.363	0.711	91.4	0.0078
122	500	0.394	500	0.022	30.02	3000	0.147	24.22	9500	0.221	3.54	15,000	15	0.247	0.637	72.2	0.0088
123	500	0.394	500	0.017	40.02	2000	0.141	40.02	7500	0.193	4.07	15,000	15	0.410	0.761	98.3	0.0077
124	500	0.453	500	0.084	40.02	3000	0.181	25.12	7500	0.143	2.53	15,000	15	0.230	0.638	82.1	0.0078

Table 5 he completed weld output conditions for the twelve welds. The actual segment duration, time, and distance is listed along with the overall weld time and burn off distance. Time and distance for each segment is for the individual segment (not a cumulative value from the start).

Machine output data files were provided by APCI for all welds except 105, 106, and 114, which never reached the data collection point. The weld data output was plotted and analyzed for proper machine operation and the location of segment transitions (Figure 16). The 150-ton system operated as programmed during each weld. During the experimental trials, there were no mechanical issues aside from damage caused by occasional weld seizure.

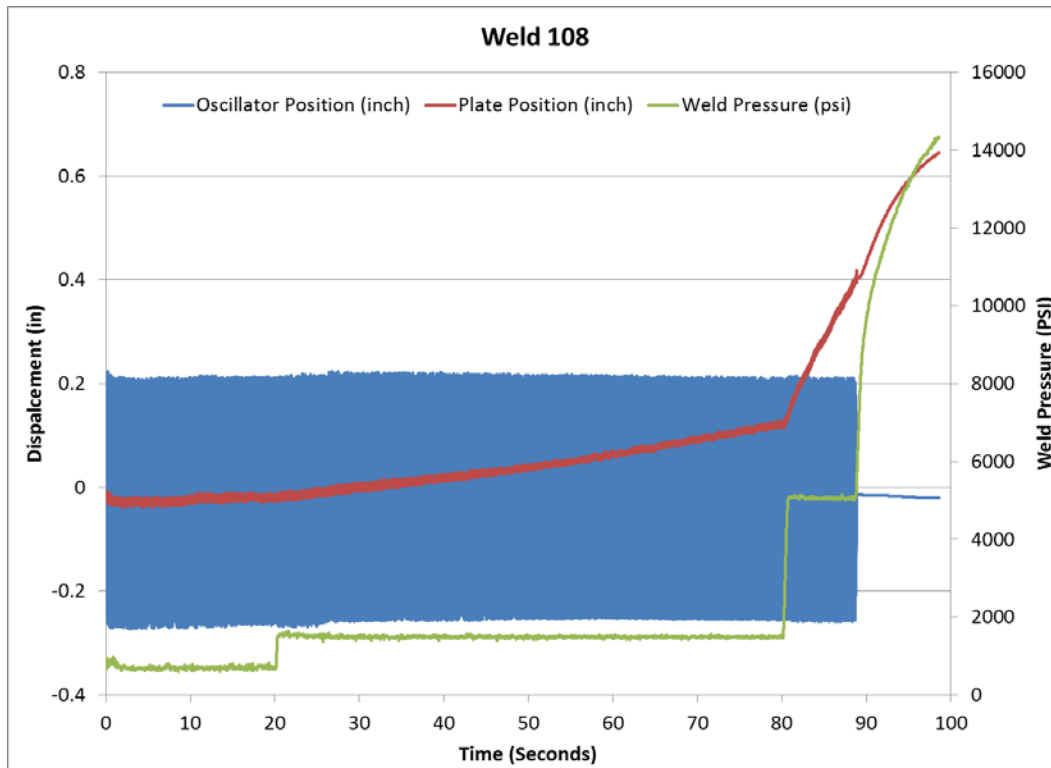

Figure 16. Example of a Machine Output Plot

4.2 Weld Quality Evaluation

The weld evaluations revealed that the rail material used for the experimental trials was from two or more different batches. Review of the preliminary hardness results from the first round of welds showed one batch was standard grade and the other a premium grade rail. No effort was made to separate the two types before the remaining experimental welds were produced. This led to an additional level of difficulty in determining how welding conditions affected the resulting weld hardness as some welds were made between the standard and premium rails.

EWI first evaluated each weld visually. The feature most evaluated in all friction-based welds is the flash. Most welds exhibited a similar flash profile to that shown in the pictures of Weld 107 below, Figure 17.



Figure 17. Weld 107 in the As-received Condition

Rail alignment was measured on a sample set of joints after welding and compared to the AREMA Chapter 4 standard for post-weld alignment, Table 6.

Table 6. AREMA Standard for Post Weld Alignment

Post Weld Rail Alignment	
Rail Head	inches
Vertical Offset	0.030
Horizontal Offset	0.050
Horizontal Kink	0.025
Vertical Crown	0.060
Combination Vertical Offset and Crown	0.060*
Combination Horizontal Offset and Kink	0.060*
Rail Base	
Horizontal Offset	0.125

The alignment was laser-height measured for samples 109, 111, 116, and 121. Figure 18 shows the laser measurement sensor traversing along the web of Weld 109.

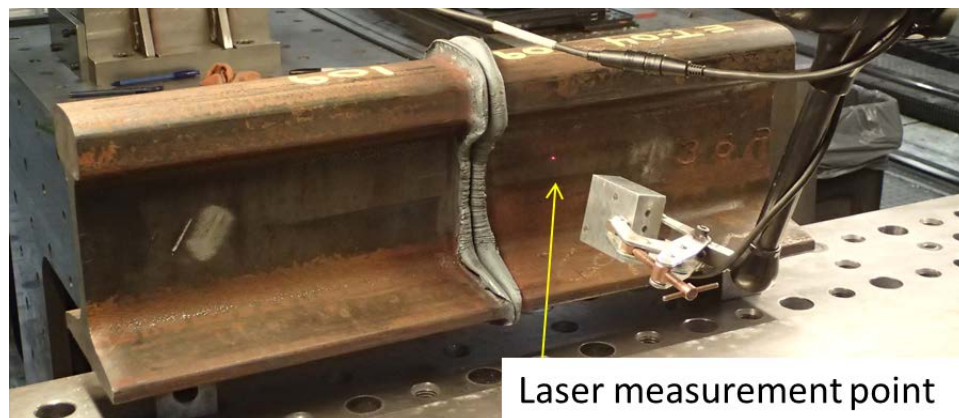

Figure 18. Weld 109 Web Being Laser Scanned for Alignment

The data from all samples were analyzed for compliance with AREAM standards. EWI tabulated measurements for four welds at the locations shown in Figure 19. The X-axis value is the position of the measurement along the rail and the Y-axis value is the offset from a selected zero position. Table 7 has the measurement data for all four welds. Overall the rail offset was good.

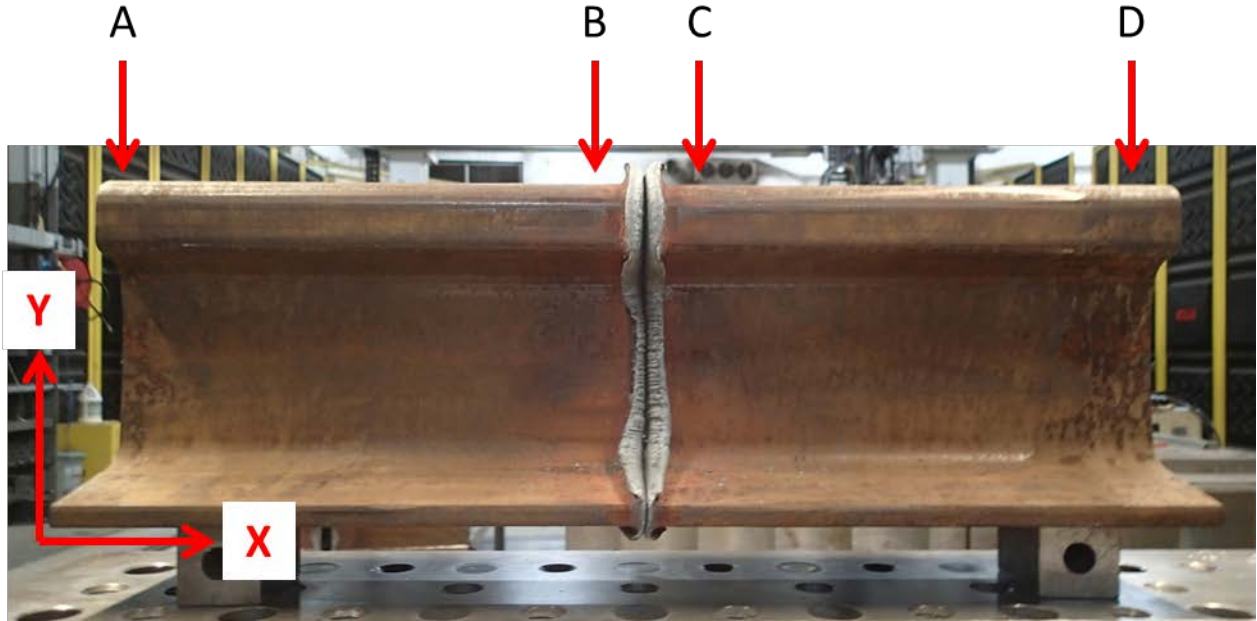

Figure 19. Positions of Alignment Measurements

Table 7. Alignment Measurements Taken with Laser Height Sensor

Weld No.	107		109		111		116	
Location	Side of Head		Side of Head		Side of Head		Side of Head	
Axis	X	Y	X	Y	X	Y	X	Y
A	0.959	0.0019	0.891	-0.0043	1.191	0.0161	0.893	-0.0393
B	11.626	0.0000	11.897	0.0000	12.144	0.000	10.807	0.0000
C	12.713	0.0269	13.264	0.0685	13.324	0.0402	13.453	-0.0067
D	23.466	0.0259	23.164	0.0844	24.184	0.0449	22.907	0.0225
Location	Top of Head		Top of Head		Top of Head		Top of Head	
Axis	X	Y	X	Y	X	Y	X	Y
A	1.359	0.0194	0.825	-0.0001	1.165	0.0000	0.301	0.0093
B	11.112	0.0000	11.685	0.0000	11.832	0.0000	10.307	0.0000
C	12.665	0.0093	13.265	0.0067	13.239	-0.0330	12.874	0.0148
D	22.679	0.0021	23.251	0.0117	23.712	-0.0082	23.034	0.0174

Note: Pink cells are out of specification, AREMA CH. 4. Alignment requirements shown in Table 6.

EWI cut weld samples for cross-sectional analysis and metallography. In general, two cross sections for each weld were mounted and polished. One section was taken from the head near the center of the rail and another section was taken from the web. An initial examination of all

cross sections was done to ensure the joint was fully fused. The location where the two flash curls come together to form the weld must be outside the rail, Figure 20. None of the weld cross sections showed signs of a lack of fusion.

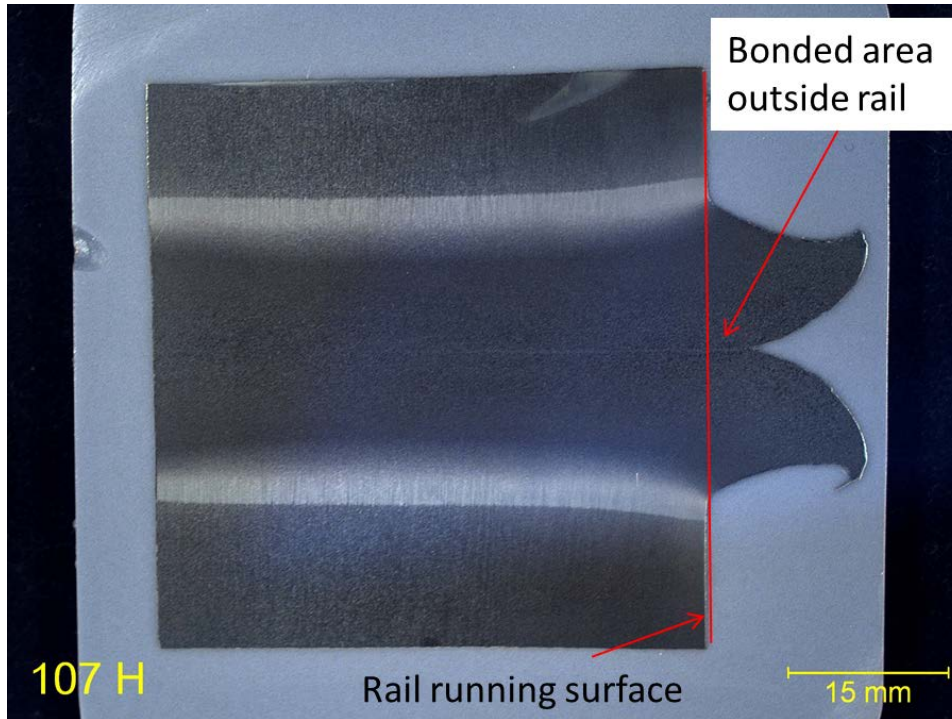

Figure 20. Cross Section of Weld 107 Head

The weld cross sections were examined for metallurgical attributes and defects, and a few common characteristics were found for most welds. The weld metal is mostly pearlite with a finer microstructure than the parent rail material (Figure 21). Small, wide-spread sulfide and alumina inclusions were present (Figure 22). Bands of martensite were found in all welds except weld 103. The martensite was found in two forms, tempered martensite and deformation-induced martensite. The tempered martensite is seen in and around prior austenite grains (Figure 23). Deformation-induced martensite bands are located in the weld near the HAZ (Figure 24). The formation of these bands is driven by the high strain rate due to material forging. Either form of martensite will be harder than the surrounding pearlite microstructure with the deformation-induced variety being the hardest.

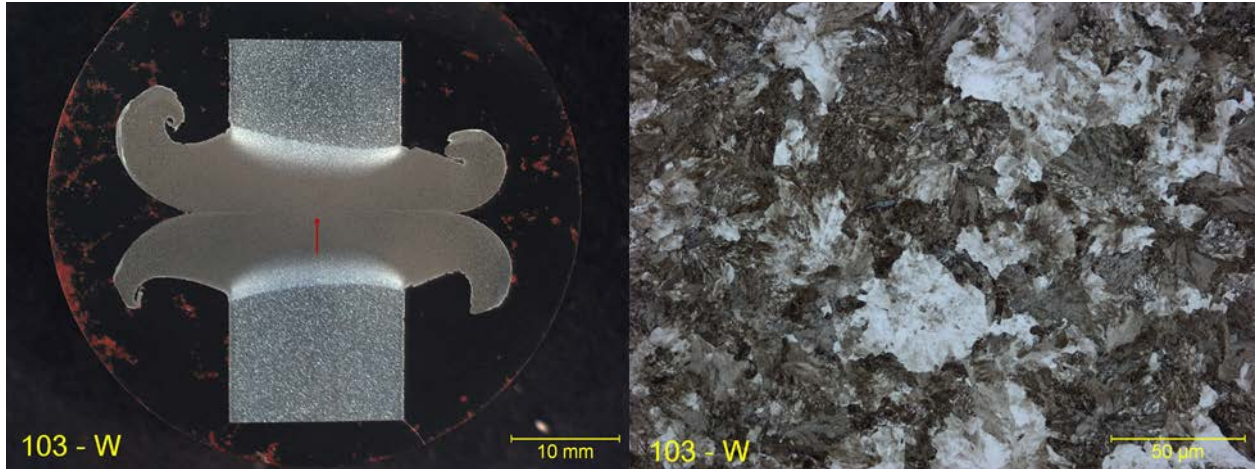

Figure 21. Macrograph of Weld 103 Web (right) with Location of 500× Micrograph (left) Marked

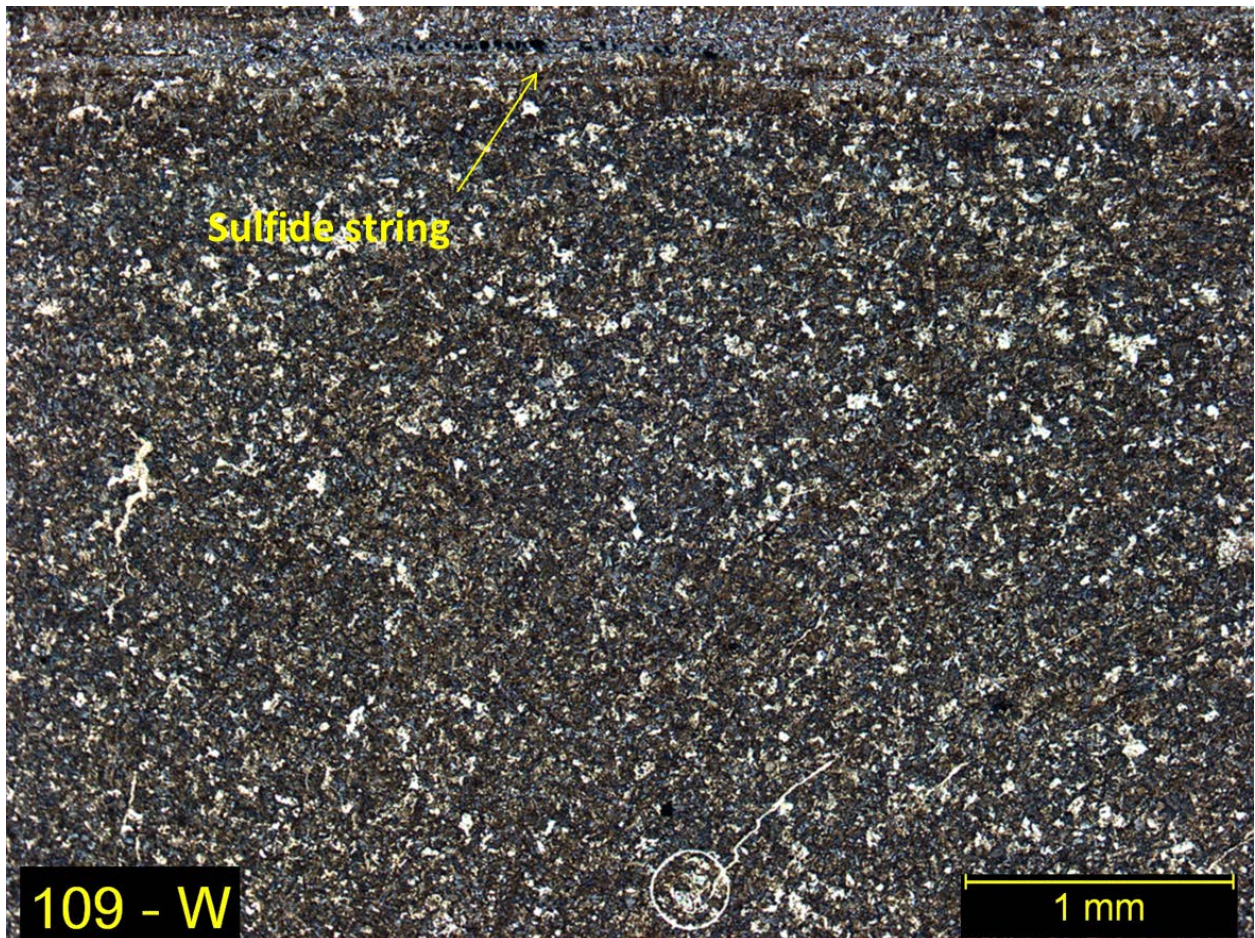

Figure 22. Example of Sulfide Stringer in Weld

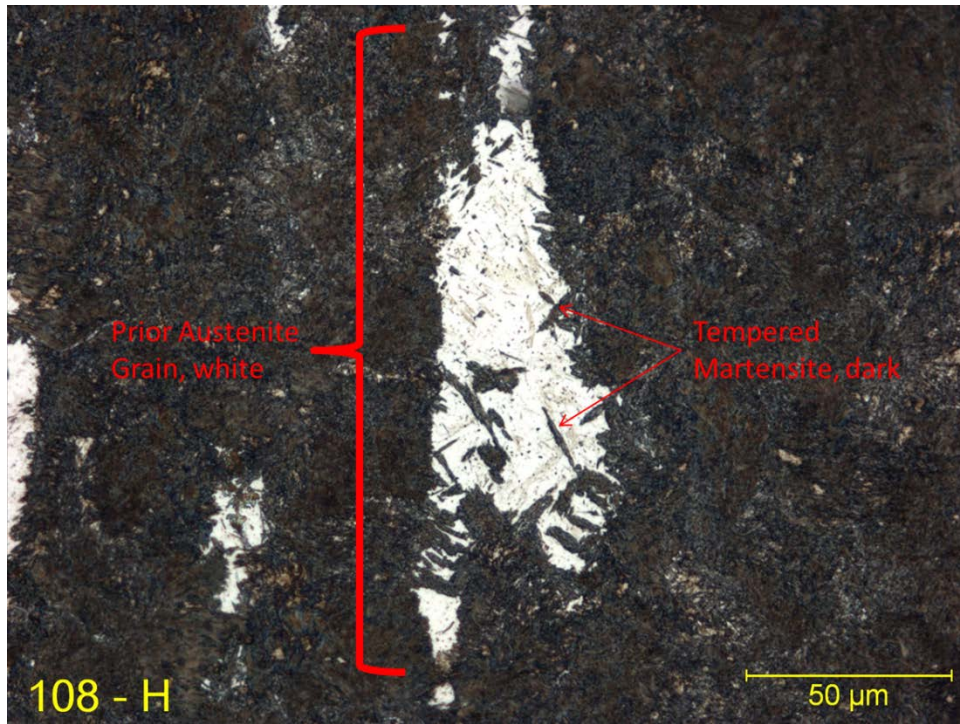

Figure 23. Tempered Martensite Forming in a Prior Austenite Grain

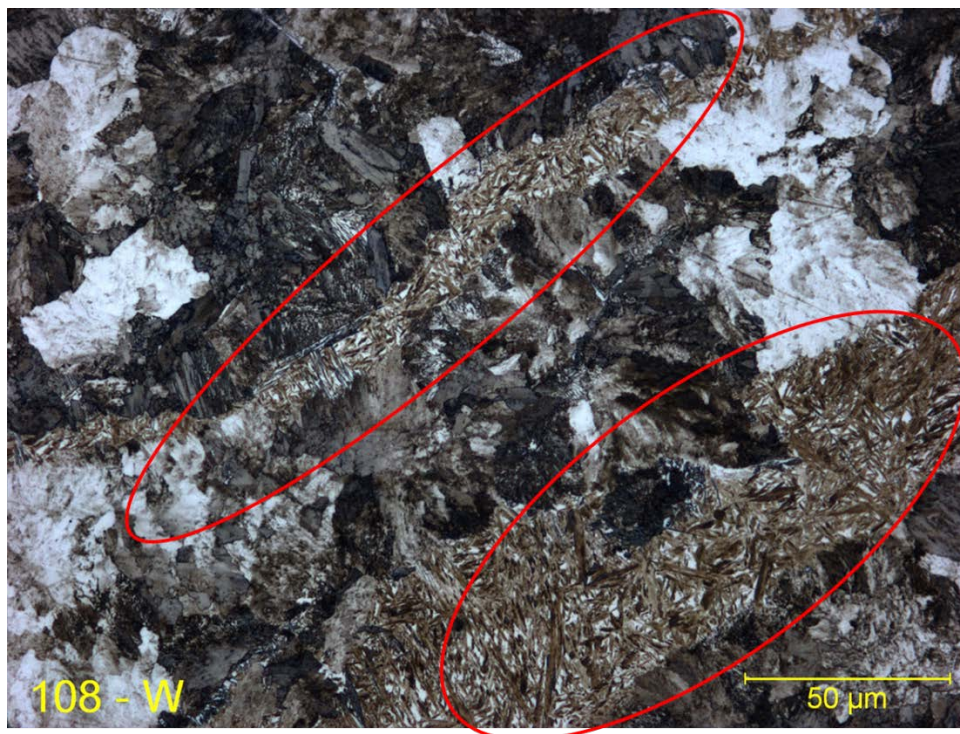

Figure 24. Deformation Induced Martensite Bands

EWI made hardness traverses on all head cross sections. All the welds have a similar hardness profile (Fig. 25). The interface of the weld is a little softer than the general weld material. The weld metal for all samples is in the range of 43-37 HRC. The HAZ is the softest region of the weld and can be as low as 26 HRC. The hardness traverses were extended into the base material to provide a clear view of the type of rail material used.

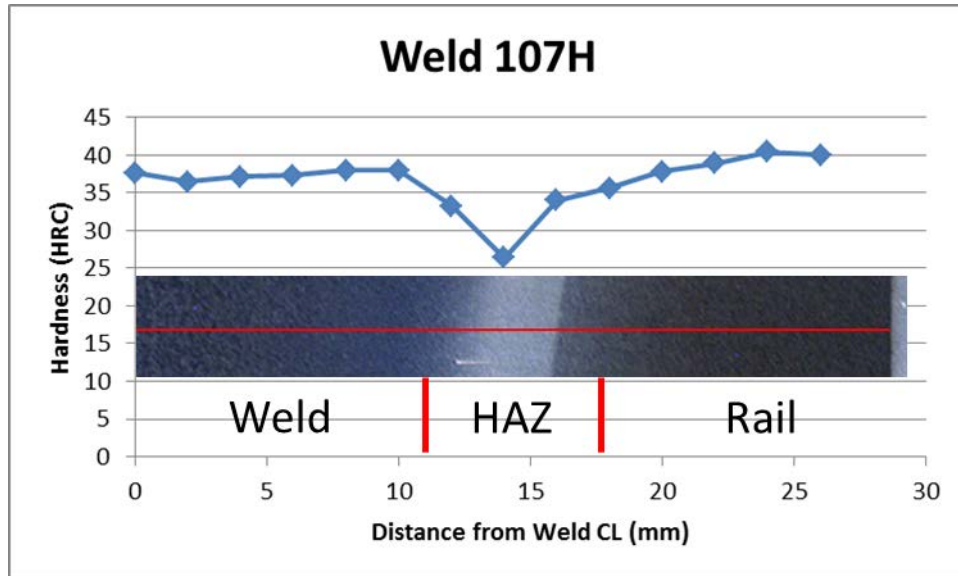

Figure 25. Typical Hardness Traverse Taken from Center of Head, 5 mm below Running Surface (red line)

EWI machined six tensile bars from five welds. Ultimate and yield strength along with elongation data were collected (Table 8).

Table 8. Mechanical Test Results from Select Experimental Trials

Specimen Identification	Specimen Diameter		Ultimate Strength		0.2% Yield Strength		Elongation (%)	Reduction of Area (%)	Failure Location	Knock Down	
	(mm)	(in.)	(MPa)	(ksi)	(MPa)	(ksi)				UTS (%)	YTS (%)
121W	6.4008	0.252	982.8	142.5	686.9	99.6	6.2	13.8	Near radius	19%	9%
117	6.4262	0.253	1036.6	150.3	677.9	98.3	7.0	17.4	Test area	20%	7%
124	6.4262	0.253	1038.6	150.6	682.8	99	5.9	25.1	Test area	20%	7%
122	6.4008	0.252	1067.6	154.8	682.8	99	3.6	19.6	Test area	18%	7%
115	6.4008	0.252	1034.5	150	655.2	95	10.4	19.6	Test area	20%	10%
121H	6.4008	0.252	1041.4	151	682.1	98.9	9.0	22.4	Test area	20%	7%

5 Conclusions

The project successfully designed and fabricated a new LFW system around the requirements to join 136RE rail, and an expanded view of the process window for joining rail with LFW was created. The potential range of welding conditions for joint rail with LFW has introduced possible approaches to improving mechanical properties. Welds that are near base material mechanical properties were created using this new process. The result of the experimental test welding showed that using LFW to join rail was not only feasible, but LFW has the potential to greatly improve the quality of continuously welded rail. LFW, as a solid -state welding process, reduces the potential for forming inclusions when compared to FBW.

Rail steel is a hard, high-strength material. Both strength and hardness are driven by the high carbon content of the material, near 0.9 percent (it is grade and manufacturer dependent). The carbon content at these levels narrows the weld process window for making welds within the hardness requirements and with insensitivity to crack development. The preferred method for avoiding martensite formation in high-carbon steel welds is to use a pre-heat or post-weld heat treatment (PWHT). This allows the weld to cool slowly, or controls the cooling rate, to prevent portions of the weld microstructure that have become austenite from forming martensite. There is an inherent danger that the weld's HAZ could be severely softened due to cooling too slowly. This requires a balanced approach to keep hardness in the weld and HAZ within an acceptable range in all weld processes, including LFW.

Weld hardness is a critical measurement of quality. A rail manufacturer provided typical flash butt welded rail hardness results to EWI for comparison with the LFW results. The results of hardness traverses taken on LFW samples were plotted against the corresponding FBW results (Figure 26).

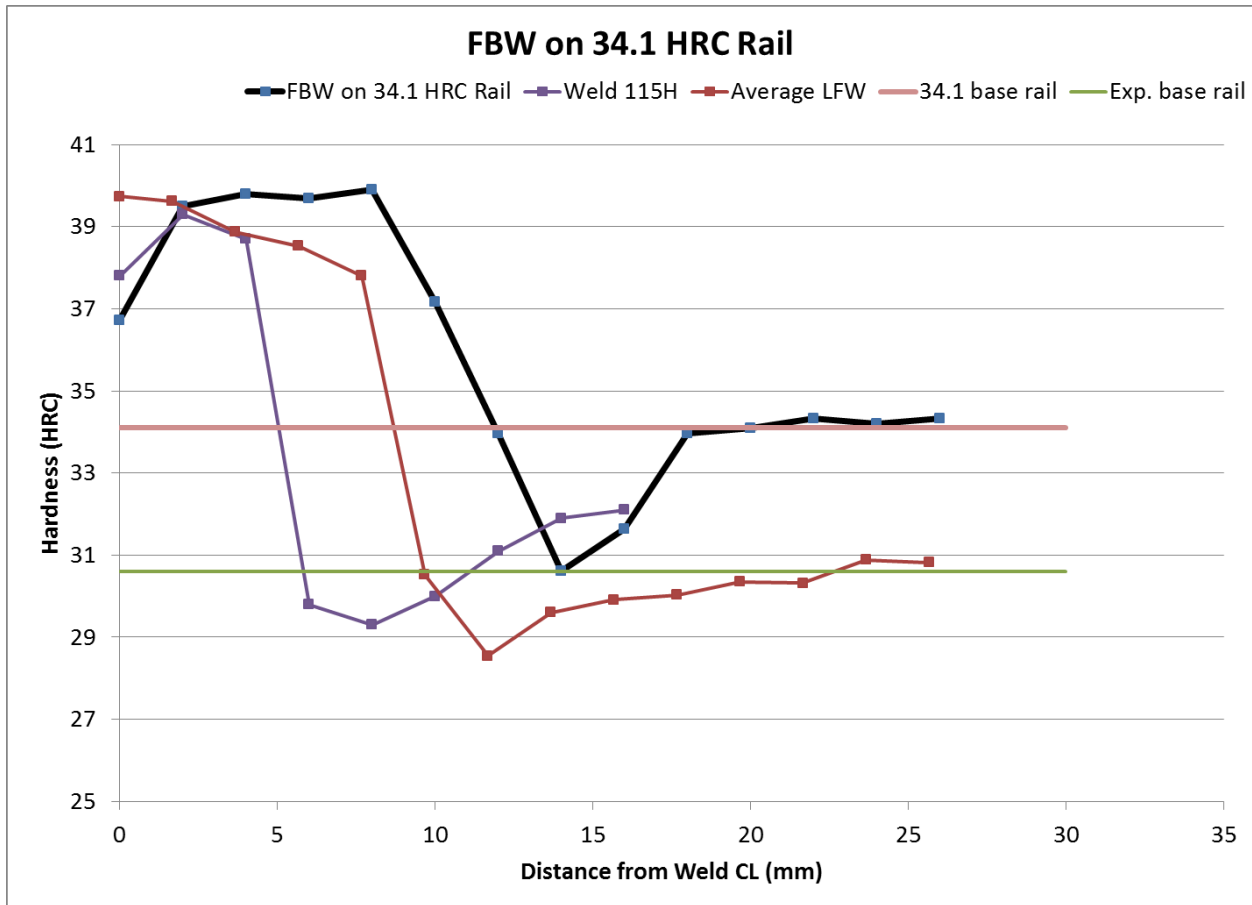

Figure 26. Hardness Traverse of FBW on 34.1 HRC Rail with Average LFW Hardness

Three features were noted from the hardness results: the hardness in the weld area, the location, and the hardness of the HAZ. The HAZ hardness is of particular interest as this region is softer than the surrounding weld and rail material. Hardness in the rail was limited to 43 HRC to keep the joint from becoming brittle. An overall view of the hardness results on standard rail (34.1 HRC) when compared to FBW was that the weld metal hardness was comparable, the HAZ hardness was lower, and the HAZ location was moved in toward the weld centerline. However, the drop for the average of the LFW welds from the base rail hardness was smaller than FBW, 2 HRC versus 3.5 HRC.

The hardness of the LFW samples on the premium grade material (39.6 HRC) was compared to FBW and it was similar to standard grade results. The HAZ hardness was lower than the FBW, but its location had moved in toward the centerline. The weld metal hardness was comparable between both welding methods (Figure 27).

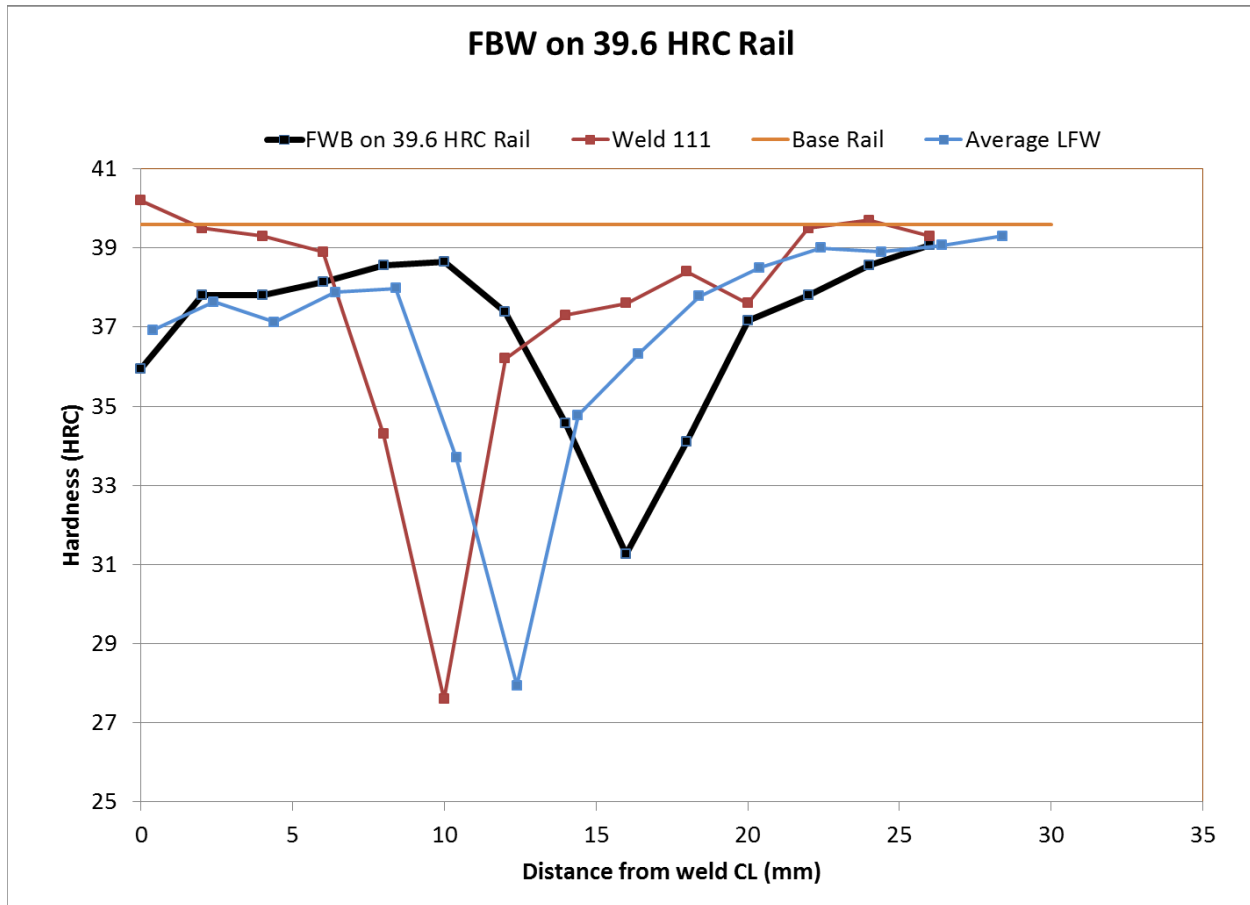

Figure 27. Hardness Traverse of FBW on 39.6 HRC Rail with Average LFW Hardness

Table 9. Mechanical Test Results Compared to Minimum Rail Strength Requirements.

Specimen Identification	Ultimate Strength		Elongation	Change	
	UTS	%E		UTS	%E
	(MPa)	(ksi)	(%)	(%)	(%)
117	1036.6	150.3	7.0	12%	-30%
124	1038.6	150.6	5.9	12%	-41%
122	1067.6	154.8	3.6	10%	-64%
115	1034.5	150.0	10.4	12%	4%
121W	982.8	142.5	6.2	-17%	-38%
121H	1041.4	151.0	9.0	-12%	-10%
Standard ⁽⁶⁾	983.0	142.5	10.0	Increase	
High Strength ⁽⁶⁾	1180.0	171.1	10.0	Decrease	

The mechanical testing results were tightly grouped, ± 3 ksi for the specimens taken from the head of the rail within ultimate and yield strength. The results of the testing were compared to minimum required strength values for standard and high strength rail. LFW appeared to perform very well versus the minimum strength requirements. All specimens taken from the head

exceeded the standard rail strength requirement and the specimen taken from the web, 121W, was only below by 0.2 MPa. The welds from Weld 121, shown in Table 9, were compared to high strength rail. The elongation for the welds did not meet the minimum percent elongation requirements except for Weld 115, which was 0.4 percent above the required 10 percent. These very promising results indicate that LFW has the potential to be a great benefit for continuously welded rail.

6 Future Research

There are a number of areas for improvement in the LFW rail welding process. Process variables and their effect on the quality of the completed weld can be isolated, especially in the areas of HAZ hardness, weld length and process time and control variables.

With the limited experimentation that has been done with LFW, there remains additional potential to narrow the weld zone further. The experimental trials done under this project should be viewed as a scoping trial that would lead into a large designed experiment. Monitoring the temperature of the parts during the entire weld cycle can establish key correlations between machine parameters and conditions at the joint during welding. This should include the pre-heat process, welding, and the cooling until the parts are below any critical temperatures. Steps that would be taken to narrow the weld zone will be the same as those that increase the hardness in the HAZ.

Future research should focus on welding conditions that directly drive the weld cycle shorter. The weld time during the experimental trials was often greater than 60 seconds to allow time for heat to soak into the rails. Some welds made during the experimental trials had process conditions designed to reduce the weld cycle time, but those welds let the time be dependent upon upset position. The most successful of these welds was 115 which actually seized and did not run out the intended cycle. However, this weld demonstrated that the extended scrub and weld trials used for most welds may have been unnecessary. A statistically significant set of trial welds could be devised to determine how welding parameters impact mechanical properties.

Another approach to improve weld properties is to allow the welding conditions at the joint control segment advancement. Once the entire interface is plasticized and burn off is occurring at a steady rate, the oscillation can be stopped and forging begun. Adding a control in this area would allow the real-time conditions of the weld to dictate when transitions take place and would also ensure that the weld cycle only lasts as long as needed. Changes of this nature to the process control system would require that the LFW system software be modified. Changes to the control hardware may also be required depending on the sampling rate.

When steel is heated with a torch, significant heat soak occurs during the pre-heat. By pre-heating the joint with a different method that creates a high-temperature gradient centered at the joint, the weld cycles can be kept very short. For example, using resistance heating across the joint to warm the interface before welding begins. Once the LFW cycle is complete, the resistance heat could be turned back on to control the cooling rate in the weld zone. Figure 28 shows the proposed welding and temperature cycle with this resistance heating added to the process. Building a system that would control the pre-heating and cooling rate through non-contact pyrometers would make the process highly repeatable.

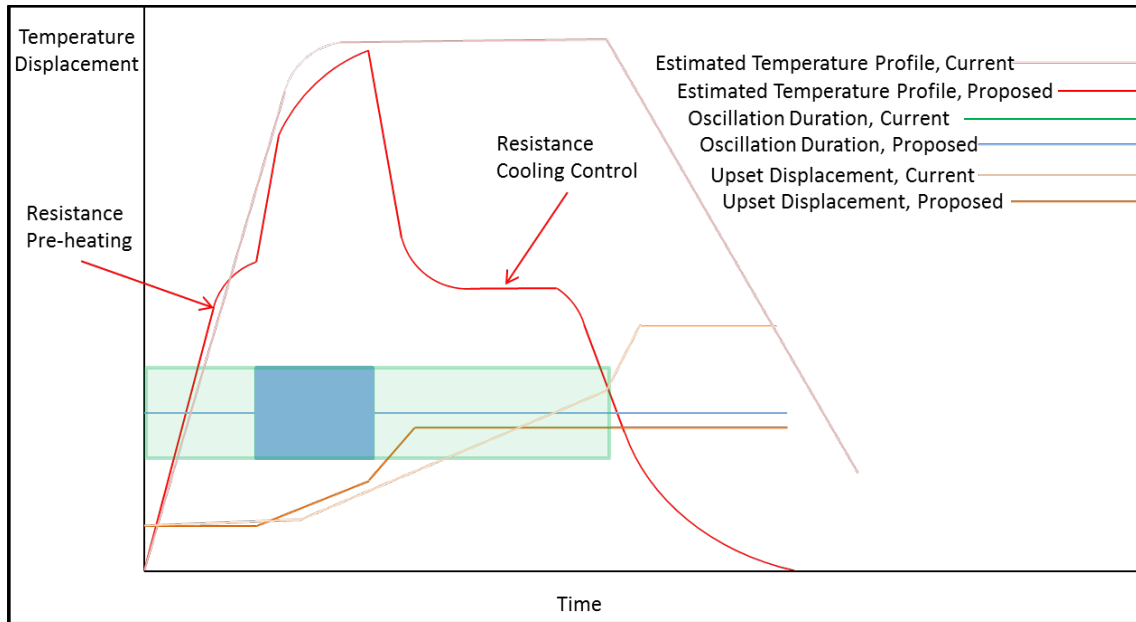

Figure 28. LFW and Heating Profile for Current and Resistance Pre-heated Process

An optimized LFW process with high gradient pre-heating may be able to produce welds with a very narrow HAZ. These improvements may also include a shorter weld time, a reduction in burn-off, improved weld quality, and a hardness profile that will be more resistant to forming batter defects.

The next round of research for the LFW rail could be outlined as follows:

1. Design of Experiment Development – A DOE will be developed to select a set number of input variables for creating welds. The output variables will be the hardness profile and mechanical properties of the weld. The objective will be to identify the input variables that most strongly influence the outputs.
2. Reduced Weld Time Process Modification – In this task, real time process control through burn rate monitoring and alternative pre-heating methods, like resistance, will be tested.
3. Implementation and Impact Study – Existing practice for joining rail will be examined and benchmarked against LFW. The results of this study will be a reference document to help rail manufacturers see the benefits of LFW.

7 References

- (1) Gould, J. and Johnson, W., “Translational friction weld rail repair – Phase I final report”, *EWI Project No. 52765GTH*, FRA Contract No. DTFR53-11-C-00004.
- (2) Ofem, U., Addison, A., and Russell, M., “Energy and force analysis of linear friction welds in medium carbon steel,” *Science and Technology of Welding and Joining*, Vol. 15, No. 6, pp. 479, (2010).
- (3) Shira, S., “The use of translational friction welding for constructing and repairing rail for high speed and intercity passenger rail – Phase II design report”, *EWI Project 54368GTH Task 1 – 3*, FRA Contract No. DTFR53-13-C-00041.
- (4) Shira, S., “FRA LFW machine design phase 2 – Loading requirements document”; *EWI Project 54368GTH Task 1*, FRA Contract No. DTFR53-13-C-00041.
- (5) AREMA Manual, Chapter. 4 – Rail, 2007 Edition.
- (6) Arcelor Mittal train rail mechanical properties, AREMA 2007, Retrieved from: <http://rails.arcelormittal.com/en/mechanical-properties.html>.

Abbreviations and Acronyms

FBW	Flash butt welding
FRA	Federal Railway Administration
HAZ	Heat-affected zone
LFW	Linear friction welding
MRL	Manufactured readiness level
PWHT	Post-weld heat treatment
TFW	Translational friction welding