



U. S. Department of
Transportation
Federal Railroad
Administration

Single Passenger Rail Car Impact Test Volume II: Summary of Occupant Protection Program

Office of Research
and Development
Washington, D.C. 20590

Rail Passenger Equipment Collision Tests



DOT/FRA/ORD-00/02.2
DOT-VNTSC-FRA-00-02

Final Report
March 2000

This document is available to the
public through the National Technical
Information Service, Springfield, VA 22161
This document is also available on the FRA
web site at www.fra.dot.gov

NOTICE

This Document is disseminated under the sponsorship of the Department of Transportation in the interest of information exchange. The United States Government assumes no liability for its contents or use thereof.

NOTICE

The United States Government does not endorse products or manufacturers. Trade or manufacturers' names appear herein solely because they are considered essential to the objective of this report.

REPORT DOCUMENTATION PAGE*Form Approved*
OMB No. 0704-0188

Public reporting burden for this collection of information is estimated to average 1 hour per response, including the time for reviewing instructions, searching existing data sources, gathering and maintaining the data needed, and completing and reviewing the collection of information. Send comments regarding this burden estimate or any other aspect of this collection of information, including suggestions for reducing this burden, to Washington Headquarters Services, Directorate for Information Operations and Reports, 1215 Jefferson Davis Highway, Suite 1204, Arlington, VA 22202-4302, and to the Office of Management and Budget, Paperwork Reduction Project (0704-0188), Washington, DC 20503.

1. AGENCY USE ONLY (Leave blank)		2. REPORT DATE March 2000		3. REPORT TYPE AND DATES COVERED Final Report November 1999 – December 1999	
4. TITLE AND SUBTITLE Single Passenger Rail Car Impact Test Volume II: Summary of Occupant Protection Program				5. FUNDING NUMBERS RR028/R0122	
6. AUTHOR(S) Caroline VanIngen-Dunn*					
7. PERFORMING ORGANIZATION NAME(S) AND ADDRESS(ES) Simula Technologies, Inc.* 10016 S. 51 st Street Phoenix, AZ 85044				8. PERFORMING ORGANIZATION REPORT NUMBER DOT-VNTSC-FRA-00-02	
9. SPONSORING/MONITORING AGENCY NAME(S) AND ADDRESS(ES) U.S. Department of Transportation Federal Railroad Administration Office of Research and Development 1120 Vermont Avenue NW – Mail Stop 20 Washington, DC 20590				10. SPONSORING/MONITORING AGENCY REPORT NUMBER DOT/FRA/ORD-00/02.2	
11. SUPPLEMENTARY NOTES *Under contract to: U.S. Department of Transportation Research and Special Programs Administration John A. Volpe National Transportation Systems Center 55 Broadway Cambridge, MA 02142-0193					
12a. DISTRIBUTION/AVAILABILITY STATEMENT This document is available to the U.S. public through the National Technical Information Service, Springfield VA 22161 This document is also available on the FRA web site at www.fra.dot.gov .				12b. DISTRIBUTION CODE	
13. ABSTRACT (Maximum 200 words) A test in which a single rail passenger car was crashed into a fixed wall at 35 mph was conducted at the Transportation Technology Center on November 16, 1999. The car was instrumented to measure (1) the deformations of critical structural elements, (2) the vertical, lateral, and longitudinal deceleration of the carbody and trucks, and (3) displacements of suspension systems. The objective of the interior tests was to determine the corresponding level of occupant safety for that impact scenario. Several interior configurations were tested with the appropriate data acquisition technology and quantified occupant injury parameters and seat strength characteristics. The car was equipped with anthropomorphic test devices (ATDs) in the following three arrangements: <ol style="list-style-type: none"> 1. Forward-facing unrestrained occupants seated in rows, compartmentalized by the forward seat in order to limit the motions of the occupants. 2. Forward-facing restrained occupants with lap and shoulder belts. 3. Rear-facing unrestrained occupants. The principal goal of this full-scale rail car impact test and the overall test program was to obtain scientific data that define a realistic rail car crash pulse, structural response, and corresponding level of occupant safety.					
14. SUBJECT TERMS Transportation, safety, crashworthiness, occupant protection, passenger rail vehicles				15. NUMBER OF PAGES 32	
				16. PRICE CODE	
17. SECURITY CLASSIFICATION OF REPORT Unclassified	18. SECURITY CLASSIFICATION OF THIS PAGE Unclassified	19. SECURITY CLASSIFICATION OF ABSTRACT Unclassified	20. LIMITATION OF ABSTRACT		

PREFACE

The work described in this report was performed as part of the Equipment Safety Research Program at the Volpe National Transportation Systems Center (Volpe Center), sponsored by the Federal Railroad Administration. Dr. Tom Tsai, Program Manager, and Claire Orth, Division Chief, Equipment and Operating Practices Research Division, Office of Research and Development, Federal Railroad Administration direct this program. David Tyrell, Senior Engineer, Volpe Center, developed the test requirements and initiated and monitored this work.

Gunars Spons, FRA Resident Engineering Manager at the Transportation Technology Center, directed and coordinated the activities of all the parties involved in the test. Dr. Barrie Brickle, Senior Engineer, Transportation Technology Center, Inc., implemented the equipment-related portions of the test.

METRIC/ENGLISH CONVERSION FACTORS

ENGLISH TO METRIC

METRIC TO ENGLISH

<p>LENGTH (APPROXIMATE)</p> <p>1 inch (in) = 2.5 centimeters (cm)</p> <p>1 foot (ft) = 30 centimeters (cm)</p> <p>1 yard (yd) = 0.9 meter (m)</p> <p>1 mile (mi) = 1.6 kilometers (km)</p>	<p>LENGTH (APPROXIMATE)</p> <p>1 millimeter (mm) = 0.04 inch (in)</p> <p>1 centimeter (cm) = 0.4 inch (in)</p> <p>1 meter (m) = 3.3 feet (ft)</p> <p>1 meter (m) = 1.1 yards (yd)</p> <p>1 kilometer (km) = 0.6 mile (mi)</p>
<p>AREA (APPROXIMATE)</p> <p>1 square inch (sq in, in²) = 6.5 square centimeters (cm²)</p> <p>1 square foot (sq ft, ft²) = 0.09 square meter (m²)</p> <p>1 square yard (sq yd, yd²) = 0.8 square meter (m²)</p> <p>1 square mile (sq mi, mi²) = 2.6 square kilometers (km²)</p> <p>1 acre = 0.4 hectare (he) = 4,000 square meters (m²)</p>	<p>AREA (APPROXIMATE)</p> <p>1 square centimeter (cm²) = 0.16 square inch (sq in, in²)</p> <p>1 square meter (m²) = 1.2 square yards (sq yd, yd²)</p> <p>1 square kilometer (km²) = 0.4 square mile (sq mi, mi²)</p> <p>10,000 square meters (m²) = 1 hectare (ha) = 2.5 acres</p>
<p>MASS - WEIGHT (APPROXIMATE)</p> <p>1 ounce (oz) = 28 grams (gm)</p> <p>1 pound (lb) = 0.45 kilogram (kg)</p> <p>1 short ton = 2,000 pounds (lb) = 0.9 tonne (t)</p>	<p>MASS - WEIGHT (APPROXIMATE)</p> <p>1 gram (gm) = 0.036 ounce (oz)</p> <p>1 kilogram (kg) = 2.2 pounds (lb)</p> <p>1 tonne (t) = 1,000 kilograms (kg) = 1.1 short tons</p>
<p>VOLUME (APPROXIMATE)</p> <p>1 teaspoon (tsp) = 5 milliliters (ml)</p> <p>1 tablespoon (tbsp) = 15 milliliters (ml)</p> <p>1 fluid ounce (fl oz) = 30 milliliters (ml)</p> <p>1 cup (c) = 0.24 liter (l)</p> <p>1 pint (pt) = 0.47 liter (l)</p> <p>1 quart (qt) = 0.96 liter (l)</p> <p>1 gallon (gal) = 3.8 liters (l)</p> <p>1 cubic foot (cu ft, ft³) = 0.03 cubic meter (m³)</p> <p>1 cubic yard (cu yd, yd³) = 0.76 cubic meter (m³)</p>	<p>VOLUME (APPROXIMATE)</p> <p>1 milliliter (ml) = 0.03 fluid ounce (fl oz)</p> <p>1 liter (l) = 2.1 pints (pt)</p> <p>1 liter (l) = 1.06 quarts (qt)</p> <p>1 liter (l) = 0.26 gallon (gal)</p> <p>1 cubic meter (m³) = 36 cubic feet (cu ft, ft³)</p> <p>1 cubic meter (m³) = 1.3 cubic yards (cu yd, yd³)</p>
<p>TEMPERATURE (EXACT)</p> <p>$[(x-32)(5/9)]^{\circ}\text{F} = y^{\circ}\text{C}$</p>	<p>TEMPERATURE (EXACT)</p> <p>$[(9/5)y + 32]^{\circ}\text{C} = x^{\circ}\text{F}$</p>

QUICK INCH - CENTIMETER LENGTH CONVERSION

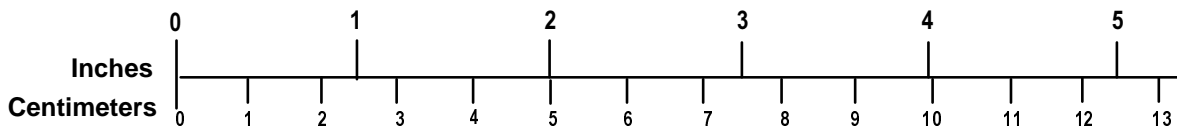

QUICK FAHRENHEIT - CELSIUS TEMPERATURE CONVERSION

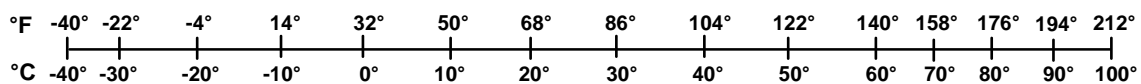

For more exact and or other conversion factors, see NIST Miscellaneous Publication 286, Units of Weights and Measures. Price \$2.50 SD Catalog No. C13 10286

Updated 6/17/98

TABLE OF CONTENTS

<u>Section</u>	<u>Page</u>
1. INTRODUCTION.....	1
2. SEAT/OCCUPANT EXPERIMENTS.....	3
2.1 Experiment No. 1 – Row-to-Row Commuter Seats.....	3
2.2 Experiment No. 2 – Row-to-Row Amtrak Seats with Restraints.....	5
2.3 Experiment No. 3 – Rear-Facing Commuter Seat.....	5
2.4 Experiment Layout in Rail Car	5
3. TEST RESULTS AND OBSERVATIONS.....	9
3.1 Experiment No. 1, Row-to-Row Commuter Seats.....	9
3.1.1 Seat Result.....	10
3.1.2 ATD.....	12
3.2 Experiment No. 2, Row-to-Row Intercity Seats with Restraints	12
3.2.1 Seat Result.....	12
3.2.2 ATD.....	14
3.3 Experiment No. 3, Rear-Facing Commuter Seat.....	14
3.3.1 Seat Result.....	15
3.3.2 ATD.....	17
4. CONCLUSIONS AND RECOMMENDATIONS	19
4.1 Conclusions	19
4.2 Recommendations	19
APPENDIX - SEAT ATTACHMENT LOADS	A-1
REFERENCES.....	R-1

LIST OF FIGURES

<u>Figure</u>	<u>Page</u>
1. Commuter Rail Seats Tested.....	4
2. Pre-Test Photo of Experiment No. 1 – Row-to-Row Commuter Seats.....	4
3. Pre-Test Photo of Experiment No. 2 – Row-to-Row Amtrak Seats with Restraints	6
4. Pre-Test Photo of Experiment No. 3 – Rear-Facing Commuter Seat	6
5. Rail Car Seat Experiment Layout for Test No. 1.	7
6. Experiment No. 1 – Loss of Passenger Compartmentalization.....	10
7. Experiment No. 1 – Front-Row Seat Pedestal Collapse and Seat Deformation	11
8. Experiment No. 1 – Front-Row Seat Frame Deformation and Weld Seam Failure	11
9. Experiment No. 2 – ATD Not Compartmentalized.....	13
10. Experiment No. 2 – ATD Knee Markings on the Deformed Seat Back	13
11. Experiment No. 2 – Metal Floor Attachment Bar Deformed Under Load	14
12. Experiment No. 3 – Seat Pedestal Sheared Near the Floor Attachment	16
13. Experiment No. 3 – Failed Weld Seams at the Side Wall Mounts	16

LIST OF TABLES

<u>Table</u>	<u>Page</u>
1. Injury Criteria.....	9
2. Experiment No. 1 – Row-to-Row Commuter Seats - Occupant Injury Loads.....	12
3. Experiment No. 2 – Row-to-Row Intercity Seats with Restraints - Occupant Injury Loads	15
4. Experiment No. 3 – Rear-Facing Commuter Seats - Occupant Injury Loads.....	17

EXECUTIVE SUMMARY

On November 16, 1999, at the Transportation Technology Center in Pueblo, Colorado, a test was conducted of a single rail passenger car colliding with a fixed wall at 35 mph. The car was equipped with instrumented anthropomorphic test devices (test dummies) in three interior arrangements:

1. Forward-facing unrestrained occupants seated in rows, compartmentalized by the forward seat in order to limit the motions of the occupants.
2. Forward-facing restrained occupants with lap and shoulder belts.
3. Rear-facing unrestrained occupants.

The purpose of the test was to obtain data to validate and calibrate computer models for analyzing crashworthiness of rail passenger vehicles.

Three-position production seats of commuter rail passenger cars were used in both the first and third arrangements. Modified intercity coach seats were used in the second arrangement. This seat design is a proof-of-concept design. This report summarizes a preliminary analysis of the data – a more in-depth analysis of the test results is ongoing.

Both the rear- and forward-facing commuter seats failed under the impact loads of the severe test condition. Points of failure include the pedestal, the side wall attachment on the frame, and the elbow juncture at the seat back/pan hinge point on the frame. Generally, the attachment bolts remained intact at the floor and side wall mounts. The unrestrained test dummies were not compartmentalized.

The modified intercity seat with lap and shoulder belts performed well under the impact loads. The restrained occupants remained seated, although the neck moment in the 5th-percentile female exceeded the injury criterion. This finding was consistent with previous predictions made through modeling and analysis efforts. One of the unrestrained occupants did catapult over the seat ahead, eventually coming to rest on top of one of the restrained dummies.

1. INTRODUCTION

Two full-scale impact tests of rail cars fitted with seat/occupant experiments have been scheduled; the first test was conducted at the Transportation Technology Center, Pueblo, Colorado, on November 16, 1999. This report describes that test which involved a single rail car impacting a rigid barrier at approximately 35 mph. The second test, scheduled to occur in the spring, will involve two rail cars coupled together impacting a rigid barrier at approximately 25 mph.

The principal goal of this full-scale rail car impact test and the overall test program was to obtain scientific data that define a realistic rail car crash pulse, structural response, and corresponding level of occupant safety. The objective of the interior tests was to determine the corresponding level of occupant safety for that impact scenario. Several interior configurations were tested with the appropriate data acquisition technology and quantified occupant injury parameters and seat strength characteristics.

Three seat/occupant experiments were on board the first full-scale rail impact:

1. Two row-to-row commuter seats with three unrestrained 50th-percentile anthropomorphic test devices (ATDs) in the rear seat.
2. Two row-to-row intercity seats with two unrestrained 95th-percentile ATDs in the rear seat and two restrained ATDs (one 5th- and one 95th-percentile) in the front-row seat that had been modified with lap and shoulder belts.
3. One rear-facing commuter seat with three unrestrained 95th-percentile ATDs.

The instrumentation, lights, cameras, power sources, and fixtures required to fully document and evaluate the experiments also were on board the rail car.

The results of the three seat/occupant experiments from Impact Test No. 1 are provided in this Test Summary Report along with a description of the experiments (Section 2), the test results and observations (Section 3), and conclusions and recommendations (Section 4).

2. SEAT/OCCUPANT EXPERIMENTS

The seat/occupant experiments that were incorporated into the full-scale rail car impact test represent typical commuter and intercity seat configurations with typical-size occupants. The current-production commuter rail passenger seats were not designed to meet the recently published FRA dynamic standards [1]. One of the objectives of the test was to determine the potential impact tolerance of the existing commuter seats. These experiments were designed to be compared to baseline data produced previously from dynamic sled tests [2], as well as to provide new information about seat/occupant responses in more realistic environments (compared to the controlled test environment provided by sled tests). The intercity seat/occupant experiment was designed to provide information about restraint systems in rail seats. This experiment involved an intercity seat modified with restraints – there is no seat like this in service today - and used 95th-percentile male ATDs and one 5th-percentile female ATD. These large and small ATDs were used rather than average-size ATDs to represent a more severe environment – both for the 5th-percentile ATD and the seat.

The commuter rail seats used on this test were M-style seats manufactured by Coach and Car Equipment Corporation (CCEC). The intercity seats tested were provided by Amtrak.

Three seat/occupant experiments were conducted and are described in the following sections.

2.1 EXPERIMENT NO. 1 – ROW-TO-ROW COMMUTER SEATS

Experiment No. 1 consisted of two row-to-row three-place passenger commuter seats – specifically the M-style seat manufactured for transit authorities such as Metro North, Long Island Railroad, Southeast Pennsylvania Transit Authority (SEPTA), Northern Indiana, New Jersey Transit, and the Maryland Area Rail Commuter System. A schematic of the seat is shown in Figure 1. The seat pitch between the seats was 32 in., and the rear seat was occupied by three 50th-percentile male ATDs. This experiment was installed aft in the rail car, in front of the rear body bolster, on the right side (orientations are made with respect to a forward-facing occupant, facing the impacting end of the rail car).

The seats were bolted onto retrofitted steel bars (2.00 in. x 0.75 in.) that replaced the original wooden floor. These steel bars represented the retrofit floor design in SEPTA's Silverliner 3 rail car. Two floor load cells were installed between the seat pedestal and the steel floor bar. At the wall mounting points, two load cells were installed between the seat attachment and the heater guard – a lip that extends horizontally from the wall of the car. The rear-row seat was similarly installed, but instead of load cells, spacer blocks of equivalent height were used.

The focus of this experiment was on the head/neck forces experienced by the front-facing occupants, and the reaction load at the seat attachment points. A pre-test photo of Experiment 1 is shown in Figure 2.

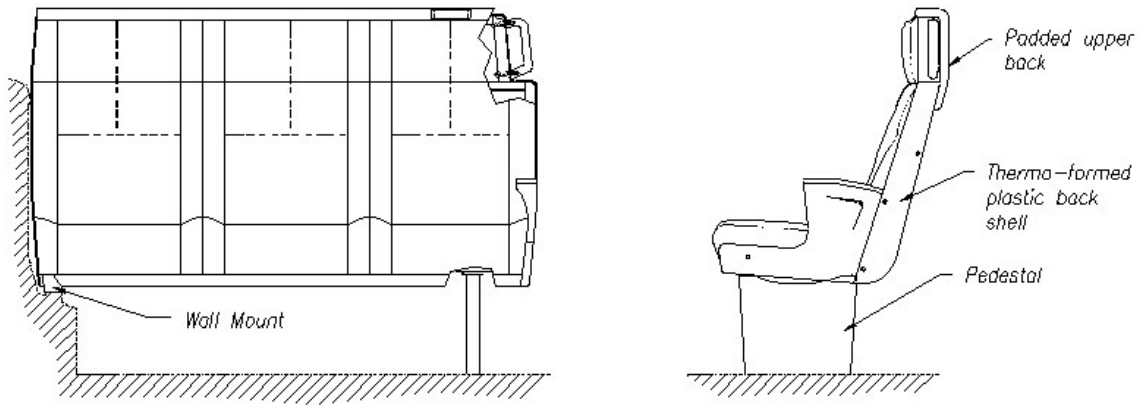

3 Passenger M-Style Seat

Figure 1. Commuter Rail Seats Tested



Figure 2. Pre-Test Photo of Experiment No. 1 – Row-to-Row Commuter Seats

2.2 EXPERIMENT NO. 2 – ROW-TO-ROW AMTRAK SEATS WITH RESTRAINTS

Experiment No. 2 consisted of two row-to-row two-place passenger intercity seats provided by Amtrak. These intercity seats were manufactured by AMI of Colorado Springs, Colorado, and the front-row seats were modified with lap and shoulder belts. The seat back panel and hinge-point between the seat pan and the seat back were both strengthened to bear the load of the lap and shoulder belts, as well as the load of unrestrained occupants impacting the seat from behind. Energy-absorbing devices were also incorporated into the modified seat to bear some of the impact load. The two original seat pedestals were replaced with higher strength pedestals. The rear seat was occupied by two unrestrained 95th-percentile ATDs, and the front seat was occupied by two restrained ATDs (a 5th-percentile in the window seat and a 95th-percentile in the aisle seat).

The Amtrak seats were floor mounted and bolted onto steel bars (2.00 in. x 0.75 in.) that replaced the original wooden floor. Two floor load cells were installed between each seat pedestal and the steel bars to which they were attached. The rear row seat was similarly installed, but instead of load cells, spacer blocks of equivalent height were used.

The focus of this experiment was on the rear-seat occupants impacting the front-row seat occupied with restrained ATDs, and observing the reaction of the front-row seat, the restrained occupants in this seat, and the unrestrained ATDs impacting the seat from behind. A pre-test photo of Experiment 2 is shown in Figure 3.

2.3 EXPERIMENT NO. 3 – REAR-FACING COMMUTER SEAT

Experiment No. 3 consisted of a single, rear-facing M-style commuter seat. This rear-facing seat was occupied by unrestrained ATDs – one Hybrid III 95th-percentile male ATD in the aisle seat and two 95th-percentile ATDs, manufactured by GARD, in the middle and window seats. It was later determined that while these GARD ATDs represented the 95th-percentile male population in size, they only represented the 50th-percentile male population by weight (172 lb).

This seat was installed exactly like the front-row seat of Experiment No. 1. Two floor load cells were installed between the seat pedestal and the steel floor beam. At the wall mount, two load cells were installed between the seat attachment and the heater guard.

The focus of this experiment was the crash pulse and the applied force of the seated occupants and the reaction of the seat. The head/neck reaction of the occupants also was observed. A pre-test photo of Experiment 3 is shown in Figure 4.

2.4 EXPERIMENT LAYOUT IN RAIL CAR

A modeling analysis effort, performed at the Volpe Center on a single car, predicted the acceleration pulse and structural response of the car during impact. The results suggested that a vertical (upward) pitch would occur to both the front and aft ends of the car. This information helped determine the preferred location for each seat/occupant experiment inside the car. The experiments were all installed between the trucks of the car (to allow the ends of the car to crush without damaging any interior experiments).



Figure 3. Pre-Test Photo of Experiment No. 2 – Row-to-Row Amtrak Seats with Restraints



Figure 4. Pre-Test Photo of Experiment No. 3 – Rear-Facing Commuter Seat

Experiment No. 1 was installed approximately 36 in. forward of the rear-facing seat (Experiment No. 3) which was installed 24 in. from the rear body bolster. The seats in Experiment No. 1 were installed 32 in. apart. Experiment No. 2 was installed toward the front of the car, approximately 40 in. from the front body bolster with a 41-in. seat pitch. Figure 5 is a layout of the seat experiments in the rail car.

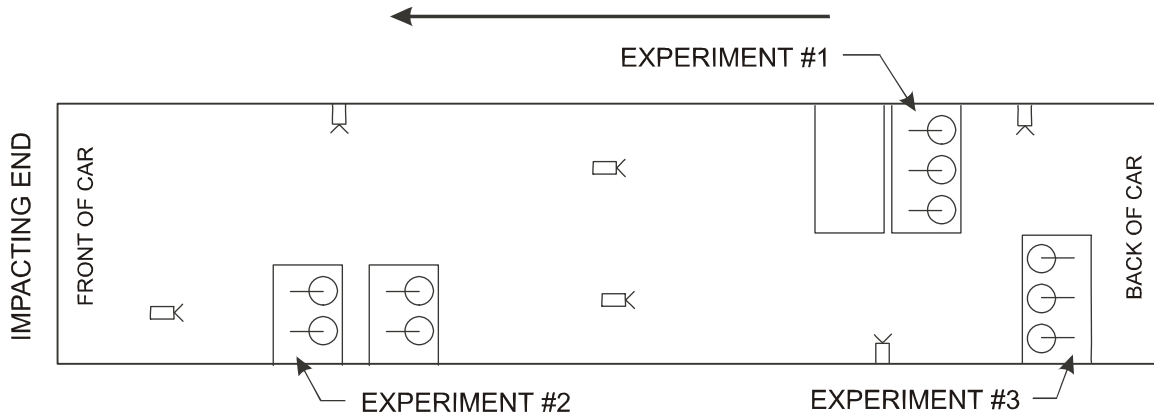

Figure 5. Rail Car Seat Experiment Layout for Test No. 1

3. TEST RESULTS AND OBSERVATIONS

The impact of the single car into a rigid barrier produced an acceleration pulse that compares favorably to the pulse predicted in the simulations. This acceleration pulse is more severe than would be anticipated in an accident that consists of a train of coupled rail cars. However, it provides useful information that can, in turn, be extrapolated out of data from future tests that involve more than one rail car. Future tests will provide data that could be used to confirm the preliminary observations made about this test.

Preliminary results of the seat and ATD responses in each experiment are provided in the following sections. Seat attachment loads and the key ATD injury loads are presented in tables with corresponding injury criteria. The injury criteria used are shown in Table 1. Only the data from the first 400 msec have been analyzed and the data in the table represents the peak loads (due to secondary impacts) from this time range.

Table 1. Injury Criteria*

	5th (F)	50th (M)	95th (M)
HIC	1,000 ⁽²⁾	1,000 ⁽¹⁾⁽³⁾	1,000
Neck Fx (lb)	+/- 438 ⁽²⁾	+/- 697 ⁽²⁾	+/-856
Neck Fz (lb)	+468 / -567 ⁽²⁾	+742 / -900 ⁽²⁾	+910/-1,104
Neck My (ft-lb)	+70 / -21 ⁽²⁾	+140/-42 ⁽²⁾	+190/-58
Chest (G)	60	60 ⁽¹⁾	60
Femur (lb)	-1,530 ⁽²⁾	-2,250 ⁽¹⁾⁽³⁾	-2,594

*Melvin, J.W., Nahum, A.M., Eds. *Accidental Injury: Biomechanics and Prevention*, Springer-Verlag, 1993.

⁽¹⁾FMVSS 208 Requirement

⁽²⁾FMVSS Proposed Rule

⁽³⁾FAA Requirement

3.1 EXPERIMENT NO. 1, ROW-TO-ROW COMMUTER SEATS

Gross failure of the seat pedestal in Experiment No. 1 allowed the seat to be pushed out of the way, resulting in a complete loss of occupant compartmentalization (see Figure 6). Overall, the measured occupant injuries were low because the seat offered little or no restraint value and the ATDs were tethered. There were no further obstacles for the occupant to impact before landing on the floor. The Hybrid III 50th-percentile ATD in the rear window seat was instrumented, and recorded a lower neck extension moment that exceeded the injury criterion.



Figure 6. Experiment No. 1 – Loss of Passenger Compartmentalization

3.1.1 Seat Result

The aft-row seat pedestal deformed under inertial loads. There was little to no deformation in the wall bracket attachment and the seat and floor attachments stayed relatively intact. The aft-row seat cushions all detached.

The front-row seat pedestal deformed completely forward, causing the seat to rotate forward until the front edge of the seat pan contacted the floor (Figure 7). The seat deformation was severe, occurring in the frame at the seat/pan hinge (Figure 8). The floor attachments to the pedestal remained intact. The side wall attachment brackets on the side frame of the seat separated at the weld seam, leaving the attachment on the side wall intact (Figure 8). The front-row seat cushions detached.



Figure 7. Experiment No. 1 – Front-Row Seat Pedestal Collapse and Seat Deformation



Figure 8. Experiment No. 1 – Front-Row Seat Frame Deformation and Weld Seam Failure

3.1.2 ATD

All injury load measurements were made from instrumentation installed in the Hybrid III 50th-percentile ATD seated in the aft row, window seat. The knees of this ATD impacted the seat back ahead of it, which contributed significantly to the deformation of the front-row seat. The knees impacted the seat back at approximately 57 msec, and the head impacted at approximately 150 msec, deforming the seat severely and allowing the ATD to continue traveling forward. While the overall injury measurements were low, the lower neck extension measured in the instrumented ATD exceeded the injury criterion (See Table 2).

Table 2. Experiment No. 1, Row-to-Row Commuter Seats - Occupant Injury Loads

	Hybrid III 50 th , Window Seat Occupant	
	Criteria	Recorded Loads
HIC	1,000	202
Neck Fx (lb)	+/-697	+242/-45
Neck Fz (lb)	+742/-900	326/-45
Upper Neck My (ft-lb)	+140/-42	37/-17
Lower Neck My (ft-lb)	+140/-42	33/-94
Chest (G)	60	14
Left Femur (lb)	-2,250	-670
Right Femur (lb)	-2,250	-806

3.2 EXPERIMENT NO. 2, ROW-TO-ROW INTERCITY SEATS WITH RESTRAINTS

The increased strength of the modified Amtrak seats resisted the loads imposed by the impact accelerations, prevented secondary impact of the occupants, and absorbed the loads produced by the restraints. The restrained ATDs hardly moved — the seat provided excellent restraint value. Compartmentalization for the unrestrained rear-seat ATDs was somewhat effective because the seat backs withstood the loads of the impacting ATDs. However, had the rear-seat ATDs not been tethered to the floor behind the seat, it appears that they would have projected farther over the seats toward the front of the rail car (Figure 9). Seat pitch may be a significant factor in the success of compartmentalization.

3.2.1 Seat Result

The forward motion of the front-seat back panel was somewhat controlled by the energy-absorbers at the seat back/pan hinge. The front-seat back panel appeared to deform under the impact load of the rear occupant's knees (Figure 10). The longitudinal metal bars to which the seat was attached were both severely deformed as a result of the load transferred to them from the seat (Figure 11). The modified seat performed exceptionally well under the circumstances. The seat frame and pedestals did not deform, so the seat can be easily refurbished with new seat backs for use in future testing.



Figure 9. Experiment No. 2 – ATD Not Compartmentalized

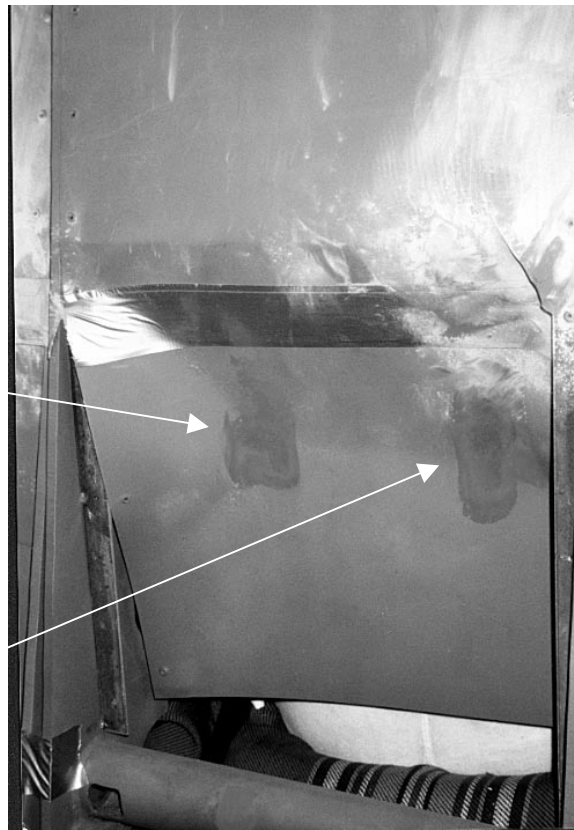

Figure 10. Experiment No. 2 – ATD Knee Markings on the Deformed Seat Back



Figure 11. Experiment No. 2 – Metal Floor Attachment Bar Deformed Under Load

3.2.2 ATD

The head, chest, and femurs of the rear-seat occupants impacted the front-row seat backs, causing seat-back deformation. The ATD's knees impacted the seat back at approximately 127 msec, and the head impacted the seat after the knees did at about 184 msec. The 95th-percentile ATD in the rear window seat was instrumented, and recorded a right femur load that exceeded the injury criterion. This ATD also experienced neck flexion and shear loads that exceeded the corresponding injury criteria. The head injury criterion was just below the injury criteria (Table 3). While the modified Amtrak seat absorbed some of the impact energy through its energy-absorbing tubes, the stiffness of the modified seat back contributed to these excess injury loads. Placing padding on the seat back and using a longer range for the energy-absorber to stroke would likely improve these injury loads. The restrained occupants in the front row remained seated, although the neck moment in the 5th-percentile female exceeded the injury criterion.

3.3 EXPERIMENT NO. 3, REAR-FACING COMMUTER SEAT

Gross failure of the seat pedestal and the attachment fittings allowed the seat to rotate backward (toward the impact direction), resulting in a loss of occupant compartmentalization. The 95th-percentile ATD in the aisle seat was instrumented and recorded a shear neck load that exceeded the injury criterion. It is likely that the 95th-percentile ATD in the aisle seat created a high moment about the pedestal and side wall attachment, causing increased rotation about these

attachments. Replacing the existing pedestal with a stronger pedestal and improving the weld at the side wall attachment should improve the seat’s attachment to the rail car.

Table 3. Experiment No. 2 – Row-to-Row Intercity Seats with Restraints - Occupant Injury Loads

	Hybrid III 5th-, Window Seat, Front-Row Occupant		Hybrid III 95th-, Window Seat, Back-Row Occupant	
	Criteria	Recorded Loads	Criteria	Recorded Loads
HIC	1,000	(not measured)	1,000	854
Neck Fx (lb)	+/- 438	+15/-126	+/-856	+1,510/-99
Neck Fy (lb)	+/- 438	+17/-13	+/-856	+30/-461
Neck Fz (lb)	+468 / -567	+251/-28	+910/-1,104	+539/-709
Neck Mx (ft-lb)		+3/-4		+89/-46
Neck My (ft-lb)	+70 / -21	+22/-23	+190/-58	+305/-44
Neck Mz (ft-lb)		+1/-0		+19/-41
Chest (G)	60	(not measured)	60	27
Left Femur (lb)	-1,530	(not measured)	-2,594	-1,959
Right Femur (lb)	-1,530	(not measured)	-2,594	-3,116

3.3.1 Seat Result

The seat offered minimal resistance to the inertial loads; i.e., the pedestal was sheared off near the floor attachment at the aft end (Figure 12), while the bolts attaching the pedestal to the load cell mount remained intact. The pedestal failure caused the seat to rotate backward and failed the weld seams on the side wall mounts (Figure 13).



Figure 12. Experiment No. 3 – Seat Pedestal Sheared Near the Floor Attachment



Figure 13. Experiment No. 3 – Failed Weld Seams at the Side Wall Mounts

3.3.2 ATD

The 95th-percentile ATD in the aisle seat was instrumented with an upper neck load cell that recorded shear loads in excess of the injury criterion (Table 4).

Table 4. Experiment No. 3 – Rear-Facing Commuter Seats - Occupant Injury Loads

	Hybrid III 95th-, Aisle Seat Occupant	
	Criteria	Recorded Loads
Neck Fx (lb)	+/-856	+1,835/-277
Neck Fz (lb)	+910/-1,104	+226/-62
Neck My (ft-lb)	+190/-58	+28/-47

4. CONCLUSIONS AND RECOMMENDATIONS

4.1 CONCLUSIONS

The commuter seats collapsed under the impact loads of the severe test condition. Areas of failure occurred in the pedestal, side wall attachment on the frame, and at the elbow juncture at the seat back/pan hinge point on the frame. Generally, the attachment bolts remained intact at the floor and side wall mounts. The unrestrained ATDs were not compartmentalized.

The modified intercity seat with restraints performed well under the impact loads. The restrained occupants remained seated, although the neck moment in the 5th-percentile female exceeded the injury criterion. This finding was consistent with previous predictions made through modeling and analysis efforts. The unrestrained rear-seat occupants were compartmentalized; however, injury loads measured in the knees, head, and neck exceeded or nearly exceeded injury criteria.

Relative to human survivability, the dynamic environment generated in this single-car test was considered very severe. The neck and knees appear to be the predominant body areas where measured injury loads exceeded the injury criteria.

4.2 RECOMMENDATIONS

The following recommendations will be incorporated into Test No. 2:

- Reproduce all the seat/occupant experiments in the lead car of Test No. 2 to compare the responses in this dynamic environment (a single car impacting a barrier) to those observed in Test No. 2 (two coupled cars impacting a barrier).
- Modify a similar commuter seat for Test No. 2 with a stronger pedestal and weld seams on the seat frame and compare the test outcomes to Test No. 1.
- Refurbish the intercity seat with new seat back panels and reuse it in Test No. 2.
- Tether all the ATDs to prevent them from traveling toward the front end of the rail car and to prevent significant damage to the ATDs.
- Conduct the rear-facing seat experiment with the same weight ATDs to reduce the torsion effect about the pedestal and wall mount.
- Consider placing all the instrumented ATDs in aisle seats where they may be better viewed by the cameras.

APPENDIX
SEAT ATTACHMENT LOADS

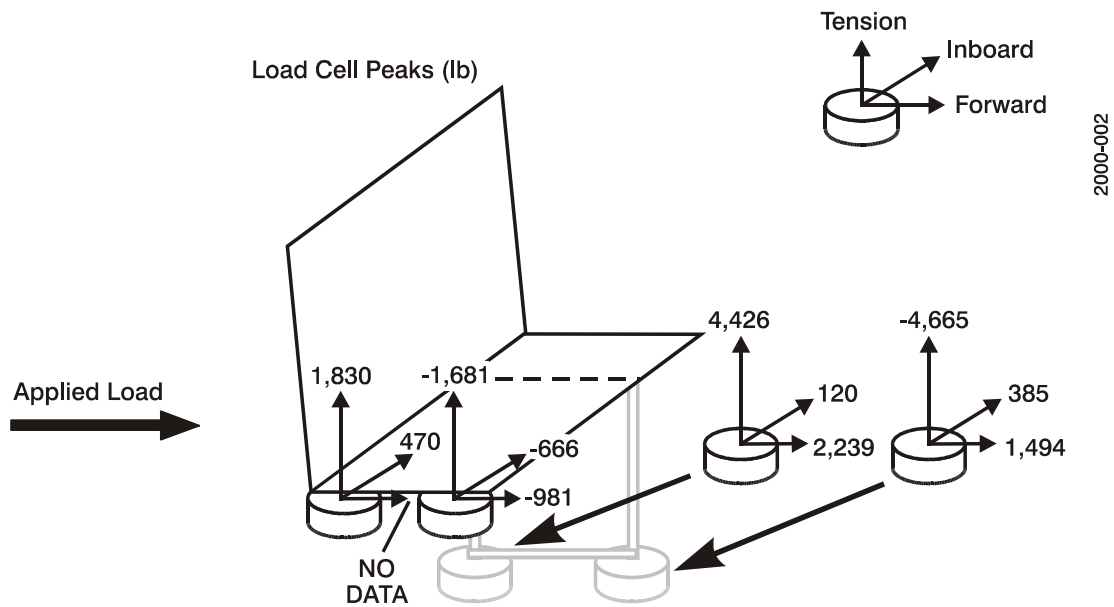

Figure A-1. Experiment No. 1 – Row-to-Row Commuter Seats – Front-Row Seat Attachment Loads (Maximums)

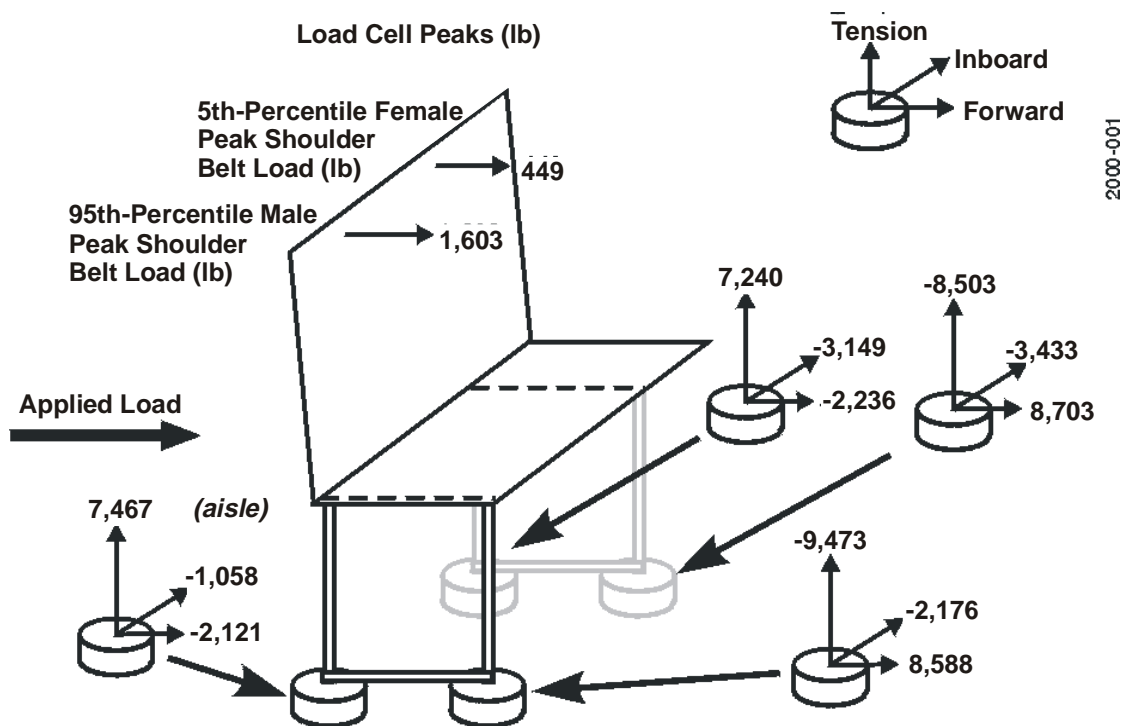
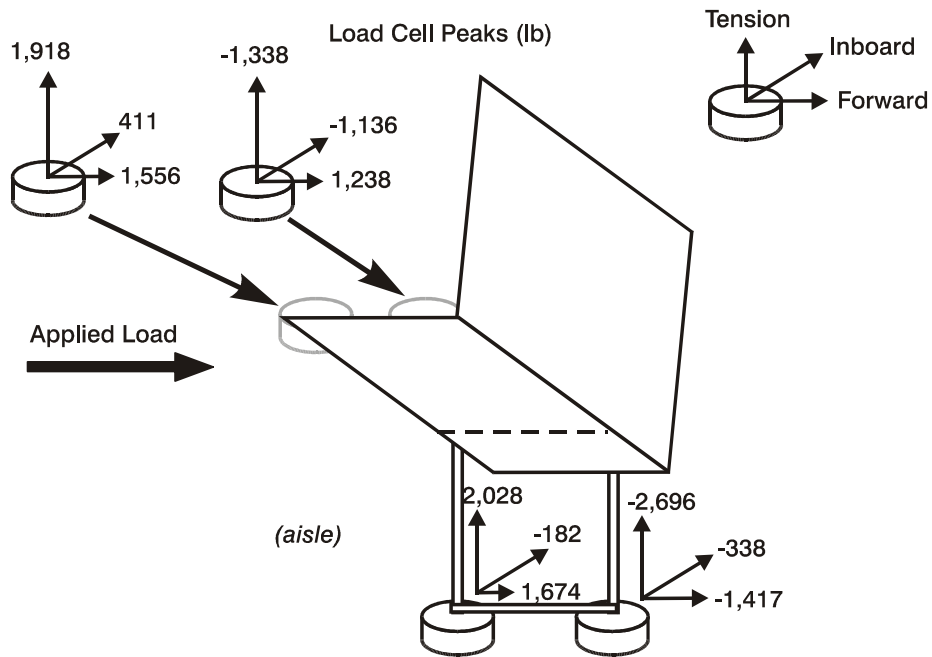

Figure A-2. Experiment No. 2 – Row-to-Row Intercity Seats – Front-Row Seat Attachment Loads (Maximums)



2000-003

Figure A-3. Experiment No. 3 – Rear-Facing Commuter Seat - Seat Attachment Loads (Maximums)

REFERENCES

1. U.S. Department of Transportation, Federal Railroad Administration, "49 CFR Part 216 et al., Passenger Equipment Safety Standards; Final Rule," Federal Register, Wednesday, May 12, 1999.
2. Tyrell, D., and K.J. Severson, "Crashworthiness Testing of Amtrak's Traditional Coach Seat," U.S. Department of Transportation, DOT/FRA/ORD-96/08, October 1996.