



U.S. Department
of Transportation
**Federal Railroad
Administration**

Safety of High Speed Guided Ground Transportation Systems

Office of Research
and Development
Washington, D.C. 20590

Collision Avoidance and Accident Survivability Volume 3: Accident Survivability

Arthur D. Little, Inc.
Acorn Park
Cambridge, MA

Calspan Corporation
Syracuse, NY

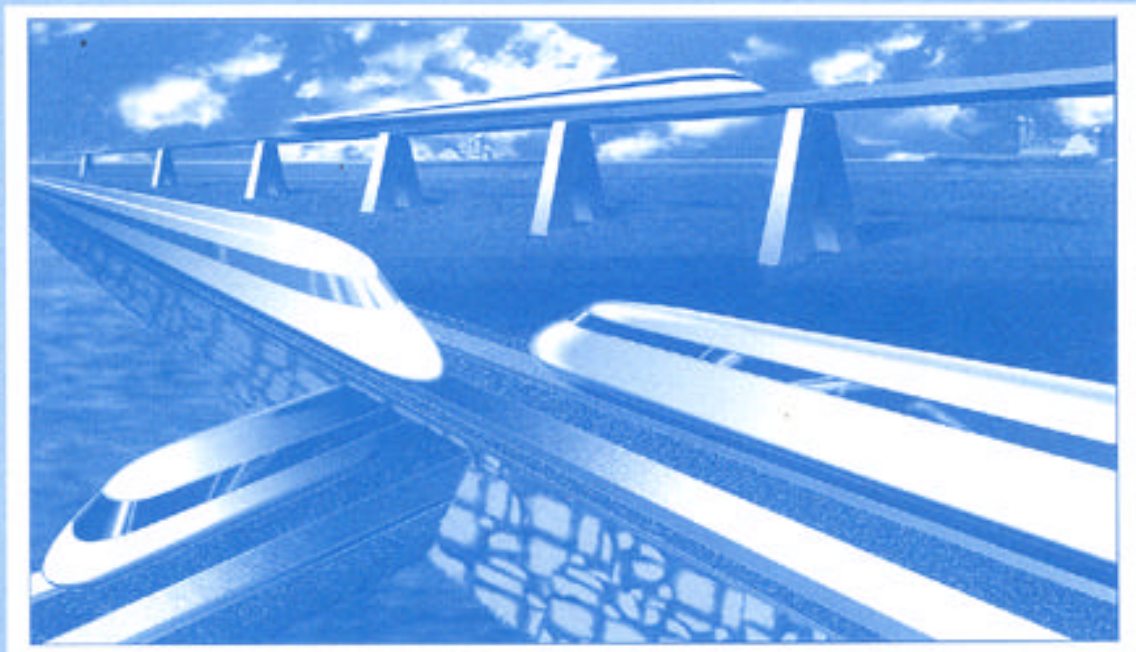

DOT/FRA/ORD-93/02.III
DOT-VNTSC-FRA-93-2.III

Final Report
March 1993

This document is available to the
public through the National Technical
Information Service, Springfield, VA 22161

NOTICE

This document is disseminated under the sponsorship of the Department of Transportation in the interest of information exchange. The United States Government assumes no liability for its contents or use thereof.

NOTICE

The United States Government does not endorse products or manufacturers. Trade or manufacturers' names appear herein solely because they are considered essential to the object of this report.

REPORT DOCUMENTATION PAGE

Form Approved
OMB No. 0704-0188

Public reporting burden for this collection of information is estimated to average 1 hour per response, including the time for reviewing instructions, searching existing data sources, gathering and maintaining the data needed, and completing and reviewing the collection of information. Send comments regarding this burden estimate or any other aspect of this collection of information, including suggestions for reducing this burden, to Washington Headquarters Services, Directorate for Information Operations and Reports, 1215 Jefferson Davis Highway, Suite 1204, Arlington, VA 22202-4302, and to the Office of Management and Budget, Paperwork Reduction Project (0704-0188), Washington, DC 20503.

1. AGENCY USE ONLY (Leave blank)		2. REPORT DATE March 1993	3. REPORT TYPE AND DATES COVERED Final Report May 1991 – October 1992	
4. TITLE AND SUBTITLE Collision Avoidance and Accident Survivability Volume 3: Accident Survivability			5. FUNDING NUMBERS RR393/R3015	
6. AUTHOR(S) Robert A. Galganski				
7. PERFORMING ORGANIZATION NAME(S) AND ADDRESS(ES) Arthur D. Little, Inc. Acorn Park Cambridge, MA 02140-2390			8. PERFORMING ORGANIZATION REPORT NUMBER DOT-VNTSC-FRA-93-2.III	
9. SPONSORING/MONITORING AGENCY NAME(S) AND ADDRESS(ES) U.S. Department of Transportation Research and Special Programs Administration Volpe National Transportation Systems Center Kendall Square, Cambridge, MA 02142-1093			10. SPONSORING/MONITORING AGENCY REPORT NUMBER DOT/FRA/ORD-93/02.III	
11. SUPPLEMENTARY NOTES This research is sponsored by the Federal Railroad Administration, Office of Research and Development, Washington, DC 20590				
12a. DISTRIBUTION/AVAILABILITY STATEMENT This document is available to the public through the National Technical Information Service, Springfield, VA 22161			12b. DISTRIBUTION CODE	
13. ABSTRACT (Maximum 200 words) <p>This report is the third of four volumes concerned with developing safety guidelines and specifications for high-speed guided ground transportation (HSGGT) collision avoidance and accident survivability. The overall approach taken in this study is to first formulate collision scenarios to which an HSGGT system may be exposed. Then existing U.S. and foreign rules, regulations, standards, and practices concerned with either preventing the occurrence of a collision, or mitigating the consequences of a collision are reviewed, together with pertinent practices from other forms of transportation, leading to the formulation of guidelines and specifications for collision avoidance and accident survivability.</p> <p>The volume provides a detailed discussion of survivability of HSGGT vehicles and trains. An opening chapter describes the basic mechanics of collision between vehicles, including the two primary causes of vehicle occupant casualties, loss of occupant space through crushing and penetration, and impacts between occupants and vehicle interiors. Further chapters describe measures of human tolerance of impacts and injury criteria, methods of assessing transportation vehicle collision performance and crashworthiness regulations and practices applicable to transportation vehicles of all types. The volume concludes with recommendations and guidelines for crashworthiness design and evaluation of HSGGT vehicles and trains to be operated in the United States.</p>				
14. SUBJECT TERMS Transportation, safety, crashworthiness, human injury criteria, maglev, high-speed rail, high-speed guided ground transportation, structural analysis, structural testing			15. NUMBER OF PAGES 152	
			16. PRICE CODE	
17. SECURITY CLASSIFICATION OF REPORT Unclassified	18. SECURITY CLASSIFICATION OF THIS PAGE Unclassified	19. SECURITY CLASSIFICATION OF ABSTRACT Unclassified	20. LIMITATION OF ABSTRACT	

METRIC/ENGLISH CONVERSION FACTORS

ENGLISH TO METRIC

METRIC TO ENGLISH

<p>LENGTH (APPROXIMATE)</p> <p>1 inch (in) = 2.5 centimeters (cm)</p> <p>1 foot (ft) = 30 centimeters (cm)</p> <p>1 yard (yd) = 0.9 meter (m)</p> <p>1 mile (mi) = 1.6 kilometers (km)</p>	<p>LENGTH (APPROXIMATE)</p> <p>1 millimeter (mm) = 0.04 inch (in)</p> <p>1 centimeter (cm) = 0.4 inch (in)</p> <p>1 meter (m) = 3.3 feet (ft)</p> <p>1 meter (m) = 1.1 yards (yd)</p> <p>1 kilometer (km) = 0.6 mile (mi)</p>
<p>AREA (APPROXIMATE)</p> <p>1 square inch (sq in, in²) = 6.5 square centimeters (cm²)</p> <p>1 square foot (sq ft, ft²) = 0.09 square meter (m²)</p> <p>1 square yard (sq yd, yd²) = 0.8 square meter (m²)</p> <p>1 square mile (sq mi, mi²) = 2.6 square kilometers (km²)</p> <p>1 acre = 0.4 hectare (he) = 4,000 square meters (m²)</p>	<p>AREA (APPROXIMATE)</p> <p>1 square centimeter (cm²) = 0.16 square inch (sq in, in²)</p> <p>1 square meter (m²) = 1.2 square yards (sq yd, yd²)</p> <p>1 square kilometer (km²) = 0.4 square mile (sq mi, mi²)</p> <p>10,000 square meters (m²) = 1 hectare (ha) = 2.5 acres</p>
<p>MASS - WEIGHT (APPROXIMATE)</p> <p>1 ounce (oz) = 28 grams (gm)</p> <p>1 pound (lb) = 0.45 kilogram (kg)</p> <p>1 short ton = 2,000 pounds (lb) = 0.9 tonne (t)</p>	<p>MASS - WEIGHT (APPROXIMATE)</p> <p>1 gram (gm) = 0.036 ounce (oz)</p> <p>1 kilogram (kg) = 2.2 pounds (lb)</p> <p>1 tonne (t) = 1,000 kilograms (kg) = 1.1 short tons</p>
<p>VOLUME (APPROXIMATE)</p> <p>1 teaspoon (tsp) = 5 milliliters (ml)</p> <p>1 tablespoon (tbsp) = 15 milliliters (ml)</p> <p>1 fluid ounce (fl oz) = 30 milliliters (ml)</p> <p>1 cup (c) = 0.24 liter (l)</p> <p>1 pint (pt) = 0.47 liter (l)</p> <p>1 quart (qt) = 0.96 liter (l)</p> <p>1 gallon (gal) = 3.8 liters (l)</p> <p>1 cubic foot (cu ft, ft³) = 0.03 cubic meter (m³)</p> <p>1 cubic yard (cu yd, yd³) = 0.76 cubic meter (m³)</p>	<p>VOLUME (APPROXIMATE)</p> <p>1 milliliter (ml) = 0.03 fluid ounce (fl oz)</p> <p>1 liter (l) = 2.1 pints (pt)</p> <p>1 liter (l) = 1.06 quarts (qt)</p> <p>1 liter (l) = 0.26 gallon (gal)</p> <p>1 cubic meter (m³) = 36 cubic feet (cu ft, ft³)</p> <p>1 cubic meter (m³) = 1.3 cubic yards (cu yd, yd³)</p>
<p>TEMPERATURE (EXACT)</p> <p>$[(x-32)(5/9)] \text{ } ^\circ\text{F} = y \text{ } ^\circ\text{C}$</p>	<p>TEMPERATURE (EXACT)</p> <p>$[(9/5)y + 32] \text{ } ^\circ\text{C} = x \text{ } ^\circ\text{F}$</p>

QUICK INCH - CENTIMETER LENGTH CONVERSION

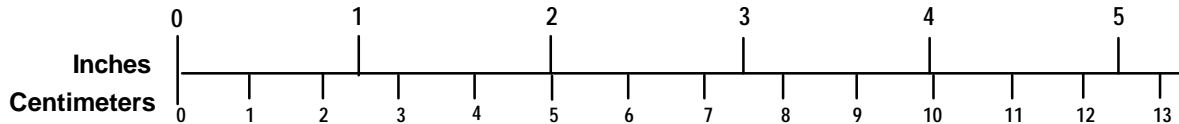

QUICK FAHRENHEIT - CELSIUS TEMPERATURE CONVERSION

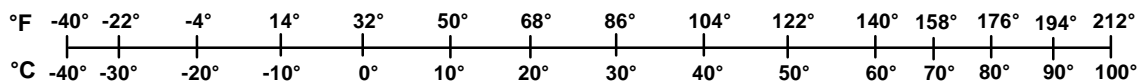

For more exact and or other conversion factors, see NIST Miscellaneous Publication 286, Units of Weights and Measures.
Price \$2.50 SD Catalog No. C13 10286

Updated 6/17/98

PREFACE

In recent years there has been increased interest in high speed guided ground transportation (HSGGT). In May of 1991 the state of Texas awarded a franchise for the construction of a high speed rail system linking Dallas/Ft. Worth, San Antonio, and Houston, and in January of 1992 a detailed franchise agreement was signed for construction of a system using the French Train à Grande Vitesse (TGV). In June of 1989 the Florida High Speed Rail Commission (now part of the Florida Department of Transportation) recommended awarding a franchise for construction of a maglev system linking Orlando airport and a major attractions area on International Drive in Orlando, and in June of 1991 a franchise agreement was signed by the state of Florida for construction of a system using the German Transrapid TR07. In November of 1992 Amtrak began testing the Swedish X2000 tilt-train on the Northeast Corridor and in 1993 Amtrak will test the German Inter-City Express (ICE) train on the Northeast corridor. In 1991 four contracts were awarded for the development of a U.S. designed maglev system, as part of the National Maglev Initiative. The Intermodal Surface Transportation Efficiency Act (ISTEA) of 1991 provides for the further development of a U.S. designed maglev system. In addition to the current active projects, there have been numerous proposals throughout the country for new high speed systems and for increasing the speeds on current rail corridors.

All of the systems proposed for operation at speeds greater than current practice employ technologies that are different from those used in current guided ground transportation systems. These different technologies include advanced signaling and control systems, and lightweight car-body structures for all or most HSGGT systems. The differences in technology, along with the increased potential consequences of an accident occurring at high speeds, require assurances that HSGGT systems are safe for use by the traveling public and operating personnel.

This report on collision safety is part of a comprehensive effort by the Federal Railroad Administration (FRA) to develop the technical information necessary for regulating the safety of high speed guided ground transportation. Other areas currently being studied by the FRA as part of its high speed guided ground transportation safety program include:

- Maglev Technology Safety Assessments (both electromagnetic and electrodynamic)
- Development of Emergency Preparedness Guidelines
- Electromagnetic Field Characteristics
- Guideway Safety Issues
- Automation Safety
- Human Factors and Automation

Collision safety comprises the measures taken to avoid collision and also to assure passenger and crew protection in the event of an accident. The results of this study, presented in the four-volume report, provide a basis for evaluating the collision safety provided by a given HSGGT system. These measures must be evaluated concurrently for a coordinated, effective approach. Based on the results of this study, work is currently planned to evaluate the collision safety of a proposed system and to evaluate the effectiveness of modifications on the collision safety of an existing conventional system.

ACKNOWLEDGMENT

This four volume report was prepared for the Volpe National Transportation Systems Center (Volpe Center) in support of the United States Department of Transportation, Federal Railroad Administration Office of Research and Development. The authors wish to thank David Tyrell, the Technical Monitor for this task, Robert Dorer, other staff of the Volpe Center, and Arne Bang and his colleagues at the Federal Railroad Administration for their support and assistance during this project.

Table of Contents

<u>Section</u>		<u>Page</u>
1.	INTRODUCTION.....	1-1
2.	FUNDAMENTALS OF HSGGT VEHICLE CRASHWORTHINESS	2-1
2.1	HSGGT Crash Conditions	2-1
2.2	Vehicle Crashworthiness Design	2-4
2.2.1	Vehicle Structure	2-4
2.2.2	Vehicle Interior	2-15
3.	HUMAN INJURY IN VEHICLE CRASHES	3-1
3.1	Background Information	3-1
3.2	An Overview of Biomechanical Research on Impact Trauma	3-3
3.3	Current Human Injury Criteria	3-9
3.4	Future Human Injury Criteria Research Efforts	3-10
4.	VEHICLE CRASHWORTHINESS EVALUATION TECHNIQUES	4-1
4.1	Experimental Techniques	4-1
4.1.1	Full-Scale Crash Testing	4-1
4.1.2	Sled Testing	4-3
4.1.3	Component Testing	4-4
4.2	Analysis Techniques	4-7
4.2.1	Train Consist Kinematic and Individual Vehicle Crash Analyses.....	4-10
4.2.2	Secondary Collision Analyses	4-22
5.	CURRENT PASSENGER TRANSPORT VEHICLE DESIGN, CONSTRUCTION AND OCCUPANT SURVIVABILITY EVALUATION PRACTICE	5-1
5.1	Vehicle Safety Features	5-1
5.1.1	Intercity Passenger Coach and Power Car Structure	5-2
5.1.2	Vehicle Structures in Other Transportation Modes	5-20

Table of Contents (Cont.)

<u>Section</u>	<u>Page</u>
5.2	Vehicle Interior Features.....5-34
5.2.1	Mass Transit Vehicle and Intercity Passenger Coach Interior Features.....5-34
5.2.2	Vehicle Interiors in Other Transportation Modes.....5-50
5.3	Occupant Survivability Standards and Regulations.....5-54
6.	RECOMMENDATIONS AND GUIDELINES FOR IMPROVED HSGGT VEHICLE CRASHWORTHINESS DESIGN AND EVALUATION6-1
6.1	Whole-Body Vehicle Evaluation.....6-1
6.2	Occupant Injury Potential Evaluation6-4
6.3	Vehicle Subsystem Evaluation6-5
6.4	Proposed HSGGT Vehicle Crashworthiness Research and Development Activities 6-7
7.	REFERENCES7-1

List of Figures

<u>Figure</u>		<u>Page</u>
2-1	Total Kinetic Energy Absorbed in a Collinear Vehicle Collision	2-9
2-2	Rail Vehicle Axial Crush Requirements for a Rectangular Crash Pulse: Collinear Impact with an Identical, Stationary Vehicle	2-15
2-3	Hypothetical Vehicle and Unrestrained Occupant Velocity Profiles: Frontal Collision Mode	2-17
2-4	Comparison of Automobile Compartment and Belt-Restrained Passenger Acceleration Responses: 56 km/h (35 mph) Flat Frontal Barrier Crash Test.....	2-20
4-1	Kinematics of a Five-Car Train Angled Barrier Impact: FNC DYNA3D Simulation	4-16
4-2	Collapse of a Passenger Rail Coach Body in a Flat Barrier Impact: FNC DYNA3D Simulation	4-17
4-3	Typical IITrain Transit Car Model.....	4-20
4-4	ATB Fifteen-Segment Man-Model.....	4-23
4-5	Typical View-Generated Plot	4-24
4-6	Occupant Motion in a 24 km/h (15 mph) Passenger Rail Coach Flat Barrier Impact: FNC DYNAMAN Simulation	4-27
5-1	Highliner Cab End Structure	5-13
5-2	Highliner Force-Deflection Curves for Three Structural Response Conditions	5-15
5-3	Cross Sections of Two Circa 1970 European Intercity Passenger Coach Body Types	5-17
5-4	Typical Talgo HSGGT Passenger Coach Superstructure	5-19
5-5	Transrapid TR-07 Maglev Train	5-21
5-6	Transrapid TR-07 Suspension Systems	5-21

List of Figures (Cont.)

<u>Figure</u>	<u>Page</u>
5-7	Cross Section of a Transrapid TR-07 Vehicle Body and Lower Frame Structure5-22
5-8	Typical Body-Over-Frame Automobile Structure5-27
5-9	Typical Unibody Automobile Structure5-29
5-10	FMVSS Side Door Static Strength Test Setup5-32
5-11	FMVSS 216 Roof Static Crush Test Setup5-32
5-12	Transport Canada Motor Vehicle Safety Standards for Automobiles.....5-35
5-13	Transport Canada Motor Vehicle Safety Standards for School Buses.....5-37
5-14	Amtrak Passenger Coach Interior Seating for Short-Distance and Overnight Trains5-40
5-15	Amtrak Lounge Car Interior5-41
5-16	Amtrak Cafe and Buffet-Style Dining Car Interiors5-42
5-17	Amtrak Dining Car Interior5-43
5-18	Typical Amtrak Passenger Car Sleeping Accommodations.....5-44
5-19	Typical TGV Atlantique Train Passenger Car Interior Configurations5-46
5-20	TGV Atlantique Train Passenger Car Second Class Cabin with Children's Play Area 5-47

List of Tables

<u>Table</u>		<u>Page</u>
3-1	Abbreviated Injury Scale	3-4
3-2	Correlation of Typical Body Region Injury with AIS Level	3-4
3-3	Current Human Injury Criteria Employed in Transport Vehicle Crash Safety Standards and Regulations	3-11
3-4	FMVSS 208 Occupant Injury Criteria	3-12
5-1	Crashworthiness Standards for North American Intercity Passenger Coach and Power Car Structure	5-4
5-2	Crashworthiness Standards for European Intercity Passenger Coach and Power Car Structure	5-8
5-3	Accident Survivability Features of Selected Foreign High-Speed Trains Currently in Operation	5-18
5-4	Crashworthiness Standards for Vehicle Structure Utilized in Other Transportation Modes.....	5-23
5-5	FMVSS Overall Automobile Structure Performance Requirements and Evaluation Procedures	5-31
5-6	FMVSS Small-Volume Compartment Motor Vehicle Interior Performance Requirements and Evaluation Procedures	5-52
6-1	Experimental Approach Envisioned for Proposed HSGGT Vehicle Crashworthiness Evaluation Plan	6-7
6-2	Proposed HSGGT Vehicle Research and Development Activities to Establish Crashworthiness Evaluation Specifications	6-13

Abbreviations and Terminology

Many abbreviations are in common use for railroad organizations and high-speed rail systems and their components. This list provides a convenient reference for those used frequently in this report. Note that some abbreviations, particularly those used for different train control systems (ATC, ATCS, ATP, etc.), may not have the same meaning for all users. Commonly accepted meanings are given.

AAR	Association of American Railroads
ATC	Automatic Train Control - systems which provide for automatic initiation of braking if signal indications are not obeyed or acknowledged by train operator. Usually combined with cab signals
ATO	Automatic Train Operation - a system of automatic control of train movements from start-to-stop. Customarily applied to rail rapid transit operations
ATCS	Advanced Train Control Systems - a specific project of the AAR to develop train control systems with enhanced capabilities
ATP	Automatic Train Protection - usually a comprehensive system of automatic supervision of train operator actions. Will initiate braking if speed limits or signal indications are not obeyed. All ATP systems are also ATC systems
AWS	Automatic Warning System - a simple cab signalling and ATC system used on British Rail
DB	Deutsche Bundesbahn - German Federal Railways
DIN	Deutsches Institut for Normung - German National Standards Institute
EMI	Electro-Magnetic Interference - usually used in connection with the interference with signal control circuits caused by high power electric traction systems
FCC	Federal Communications Commission (United States)
FRA	Federal Railroad Administration of the United States Department of Transportation
FTA	Federal Transit Administration
HSGGT	High-Speed Guided Ground Transportation
HSR	High-Speed Rail
HST	High-Speed Train - British Rail high-speed diesel-electric trainset

ICE	Inter-City Express - a high speed train-set developed for German Federal Railways consisting of a locomotive at each end and approximately 10 intermediate passenger cars
ISO	International Standards Organization
Intermittent	A term used in connection with ATC and ATD systems to describe a system that transmits instructions from track to train at discrete points rather than continuously
JNR	Japanese National Railways - organization formerly responsible for rail services in Japan. Was reorganized as the Japan Railways (JR) Group on April 1, 1987, comprising several regional railways, a freight business and a Shinkansen holding company
JR	Japan Railways - see JNR
LCX	Leakage co-axial cables - LCX cables laid along a guideway can provide high quality radio transmission between the vehicle and wayside. LCX is more reliable than air-wave radio, and can be used where air waves cannot, for example, in tunnels.
LGV	Ligne à Grand Vitesse - French newly-built high-speed lines. See also TGV
LRC	Light Rapid Comfortable. A high-speed tilt-body diesel-electric train-set developed in Canada
LZB	Linienzugbeeinflussung - Comprehensive system of train control and automatic train protection developed by German Federal Railways
MU	Multiple Unit. A train on which all or most passenger cars are individually powered and no separate locomotive is used
NBS	Neubaustrecken - German Federal Railway newly-built high-speed lines
NTSB	National Transportation Safety Board (U.S.)
PSE	Paris Sud-Est. The high-speed line from Paris to Lyon on French National Railways
RENFE	Rede Nacional de los Ferrocarriles Espanoles - Spanish National Railways
SBB	Schweizerische Bundesbahnen - Swiss Federal Railways
SJ	Statens Jarnvagar - Swedish State Railways
SNCF	Societe Nationale des Chemin de Fer Francais - French National Railways

TGV	Train à Grand Vitesse - French High-Speed Train. Also used to refer to complete French high-speed train system
UMTA	Urban Mass Transportation Administration of the U.S. Department of Transportation. The name of this agency has now changed to the Federal Transit Administration (FTA)
U.S. or US	United States
Vital	A "vital" component in a signal and train control system is a safety-critical component which must be designed to be fail-safe and/or have a very low incidence of unsafe failures.
VNTSC	Volpe National Transportation Systems Center

1. INTRODUCTION

This report constitutes the third volume of a four-volume report for a program of research entitled "Collision Avoidance and Accident Survivability," which addresses the collision avoidance and accident survivability concerns of high-speed guided ground transportation (HSGGT) systems. Three major studies were performed to support the development of this effort:

1. A review of the collision threat, leading to a set of collision scenarios and a summary of how foreign HSGGT system developers have protected against these scenarios (Volume 1).
2. A review of the state-of-the-art with respect to collision avoidance systems, leading to guidelines for collision avoidance (Volume 2).
3. A review of the state-of-the-art with respect to accident survivability, given in this volume.

Volume 4 contains a set of specifications for HSGGT collision avoidance and accident survivability.

The objective of this document is twofold: (1) to describe the state-of-the-art accident protection technology and the techniques employed to assess the crashworthiness performance of selected ground and air transport vehicles, and (2) to outline how this technology should be applied to HSGGT vehicles to develop guidelines for the evaluation of their accident survivability performance. Information included in this study was drawn from a review of the available literature describing design, test, and analytical techniques that are applied to North American and foreign intercity passenger coaches, North American mass transit vehicles, transport category commercial airplanes and a variety of passenger-carrying motor vehicles. This survey also reviewed applicable current rules, regulations, standards, and accepted industry practices which address vehicle design and performance from the standpoint of crashworthiness.

Occupant casualties in train accidents generally stem from five different sources: (1) occupant compartment crush and the consequent reduction of survival space; (2) penetration of the compartment by parts of the impacting or struck object or vehicle; (3) occupant ejection through damaged windows or doors; (4) occupant impacts with compartment interior surfaces, other occupants, or loose objects; and (5) occupant exposure to fires, toxic gases or explosions. The events comprising source 5 are primarily post-crash consequences of the impact and are not addressed in this effort.

Train vehicle occupant survivability in a given crash scenario is a function of the kinematic behavior of the entire consist, the integrity and collapse characteristics of the structure of each vehicle and the overall interior configuration of a compartment and occupant/surface contact characteristics. The vehicle kinematic and structural deformation action alone constitutes an extremely complex interaction between deformable bodies that can undergo multiple impacts, fracture, and massive crushing. The physics of the problem becomes even more difficult when the relative motions and subsequent contact(s) of the vehicle's occupants within the confines of a collapsing or breached compartment are taken into account.

Chapter 2 of this report provides background material and a brief introduction to the general physical principles involved in the design of ground passenger transport vehicles to provide adequate protection for occupants for a given crash scenario. This discussion also highlights those particular design characteristics of guided ground vehicles that must be considered to achieve this objective.

The occupants of all types of transport vehicles involved in a crash are subjected to impulsive loadings as a result of contacts within their compartment and/or interaction with a restraint system. Chapter 3 highlights the status of ongoing research that is attempting to relate such loadings to human body injury mechanisms and maximum tolerance levels. This section also presents a description of currently accepted criteria for human body region force, acceleration, and displacement tolerance levels employed by various segments of the transportation safety community in an attempt to evaluate the potential for serious injury in simulations of vehicle crashes or other rapid dynamic maneuvers.

Evaluation of vehicle crashworthiness is carried out by means of two general approaches: experiment and analysis. Both methodologies encompass a number of different techniques, each with its own inherent advantages and disadvantages relative to expense (time and money) and correspondence to real-world accidents. Chapter 4 presents an overview of the various techniques employed by vehicle safety researchers and identifies currently available analyses that may be appropriate for use in the crash simulation of HSGGT consists, individual vehicles and their occupants.

Chapter 5 outlines current structure and compartment interior design features employed in selected intercity wheel-on-rail vehicles, with passenger coach cars examined in detail. Design requirements mandated by current rules, regulations, standards and accepted rail industry practice are also described, as well as design deficiencies that compromise the crashworthiness of these vehicles. This section also surveys vehicles from several other selected transportation modes to ascertain what concepts are employed to achieve compliance with pertinent crashworthiness-related performance objectives and to determine what methods are utilized to determine such compliance. Four such transportation modes were examined: (1) North American mass transit vehicles; (2) automobiles, multipurpose passenger vehicles, light trucks, and small buses; (3) large buses; and (4) transport category commercial airplanes. Chapter 5 also outlines the procedures employed to evaluate occupant accident survivability potential for vehicle classes in those transportation modes that must demonstrate compliance with existing government standards and regulations.

Finally, Chapter 6 presents recommendations to evaluate the accident survivability performance of HSGGT vehicles. This plan permits vehicle crashworthiness to be assessed at two different levels in response to prescribed, representative impact conditions: (1) at the global level by the overall vehicle configuration and structural design, and (2) at the local or component level by specific structural components and vehicle compartment interior systems. This chapter also recommends compartment interior design concepts that should be examined as part of a proposed comprehensive, parallel HSGGT vehicle research and development program.

2. FUNDAMENTALS OF HSGGT VEHICLE CRASHWORTHINESS

The term "crashworthiness" originated in the area of aviation safety and was generally used in reference to the capacity of an aircraft to protect its occupants during potentially **survivable** crashes.

Somewhat later, it was adopted by the automotive safety community and extended to describe the occupant protection performance afforded by all types of motor vehicles during various kinds of highway accident. The expression is also applicable to both the wheel-on-rail and magnetic levitation vehicles of HSGGT consists, i.e., trains.

Occupant survivability in any ground passenger transport vehicle accident is dependent on the configuration and severity of the accident, as well as the degree of crashworthiness engineered into the overall vehicle design. There are accidents involving vehicles from all modes of private and public transportation in which total protection against death and serious injury **cannot** be provided, regardless of how crashworthy the vehicle is. This issue is discussed both in Section 2.1 in the specific context of HSGGT consist collision threat, and in Section 2.2, which presents a broad overview of the problem of transport vehicle crashworthiness design. The latter section discusses vehicle crashworthiness from both a general perspective in order to describe the physical processes involved, and in terms of specific vehicles in an effort to illustrate the consequences of different structural design of vehicles, interior geometry, occupant packaging and restraints on occupant response and potential bodily harm in a vehicle crash.

2.1 HSGGT CRASH CONDITIONS

HSGGT consists are subject to a variety of collision hazards in their normal operational modes. The severity of these accidents, and hence the extent of potential bodily harm to train occupants, is a function of a number of factors. These variables include guideway configuration, types of trains, number of vehicles and position of each vehicle relative to the crash interface, impact speeds, and masses of the colliding consists, lead vehicles involved, nature of the obstruction on the guideway, etc. Volume 1 of this four-volume report classified these collisions into four distinct groups:

- o Collision with a similar high-speed train on the same guideway.
- o Collision with an obstruction on the guideway or with an object propelled at the train. This group includes intrusions from an adjacent guideway, whether in a shared right-of-way or not.
- o Collision with a dissimilar train or vehicle on the same guideway.
- o Single-train events, e.g., derailments of wheel-on-rail trains or unintended set-down in the case of Maglev systems. These events also include collisions with structures adjacent to the guideway.

As noted therein, the scenarios contained within each of these groups do **not** have equal probabilities of occurrence. Factored into these probabilities are planned HSGGT system collision

avoidance measures designed to lessen the frequency of those events that could severely compromise the survivability of train occupants.

Unlike ground vehicles such as automobiles and single-unit trucks of various sizes, a train constitutes a multilinked system of vehicles. As such, certain vehicles in the consist can undergo override, buckling or rollover motions during an accident. These motions, coupled with many other factors discussed in this chapter and in Volume 1 of the Final Report, increase or decrease the probability of an individual vehicle occupant being killed or seriously injured during a train accident.

Train kinematics during an accident are also highly dependent on both the nature and extent of the constraint provided by its guideway, as well as the type of connection between vehicles in the consist. Thus, for example, Maglev train vehicles that wrap around the guideway are subject to considerably more constraint than the vehicles of a wheel-on-rail train and consequently are not subject to rollover. As a second example, articulated and permanently coupled coach consists on certain foreign HSGGT systems provide greater individual vehicle and overall train stability than the four-axle railroad vehicle consists in North America and elsewhere that utilize knuckle coupler linkages. This improvement in stability is principally due to the reduced number of links in the consist and the increased length of individual links.

A particularly important subset of the comprehensive HSGGT system collision threat matrix provided in the Volume 1 final report is the train-to-train collision. These impacts can occur at low, medium, and high operating speeds, with one or both trains in motion. Because of the large consist mass involved, such collisions can generate extremely high kinetic energy levels and impact forces of the order of 4.45 MN (one million pounds), even at moderate impact speeds. Train-to-train collisions (especially head-end and rear-end impacts, which constitute a significant proportion of train accidents), often produce massive structural collapse and can lead to serious and fatal injuries to the train crew and passengers. Consequently, it is imperative that these type of impacts be examined in great detail. (However, as noted above, collision avoidance systems are designed to render very high-speed, high-severity collisions extremely rare.) This accident mode can be divided into three categories as outlined below:

o Head-end Collision. This type of accident involves an impact between the lead locomotives of two trains operating on the same track.

o Rear-end Collision. In this type of accident, the lead vehicle of one train (often a locomotive) impacts the rear of another train operating on the same track. The vehicle at the rear of one train can be a passenger car or a pusher locomotive.

o Side Impact. This accident type, which is not as common as the two noted above, can occur in a variety of ways: (1) as a result of vehicle encroachment onto an adjacent track (e.g., at a switch location), (2) contact between two vehicles in the same consist which has undergone lateral buckling, and (3) contact between vehicles in different trains on adjacent guideways. Side impact may also occur between a vehicle in a train and a ground vehicle such as an automobile or truck as discussed in Volume 1.

The motion of the center of gravity of each vehicle involved in a train-to-train collision is determined by the initial conditions describing the impact, as well as the inertial and structural properties of all the vehicles in both consists. If initially in motion at the time of impact, it may undergo a variety of translational and rotational motions and decelerate to a stop; or accelerate and decelerate along some path and then stop, if stationary at the time of impact. The accompanying vehicle dynamics are manifested in a number of different overall vehicle responses, either alone, or in some combination that affect the integrity and acceleration environment of the occupant compartment (see discussion in Section 2.2). These responses and attendant occupant motions are described below:

- o *Straight-line Acceleration or Deceleration.* This response occurs if, after a collision, all cars remain on the track or, if derailed, all cars remain upright and essentially parallel with the track. Vehicle occupants tend to be accelerated or decelerated in the direction of impact.

- o *Override.* This response describes a situation in which the underframe of one vehicle overrides the underframe of an adjacent vehicle, subjecting the frame-mounted equipment and superstructure to severe loading or crushing. Override may occur between impacting locomotives, a locomotive impacting a passenger car, or between passenger cars in the same consist. For such occurrences, the occupants of the overridden vehicle may be subjected to severe crushing conditions if the surrounding compartment structure cannot withstand the applied loads.

- o *Jackknife.* When a vehicle derails for whatever reason, rotation about its vertical axis (i.e., lateral buckling) can occur until it points in a direction at an angle to the direction of the track. Although the overall vehicle accelerations are generally low, the short-term inputs from sliding or running over track elements, rough terrain, or even other segments of the train consist can produce a hazardous environment inside the vehicle. The vehicle remains essentially upright throughout the entire jackknifing phase.

- o *Rollover.* Rollover can occur while the vehicle is in line with the direction of the track or, subsequent to a jackknife reaction, with the vehicle at some angle relative to the track. Rollover is more likely to occur at high consist impact speeds where the overturning inertia forces are greater. The primary difference between this action and a jackknife maneuver is that during a rollover, vehicle occupants can be thrown large distances inside the vehicle or, in extreme cases, out of the vehicle through openings created by broken doors and windows.

As noted earlier, the vehicles of certain foreign trains feature an articulated consist and are equipped with universal or ball joint intervehicle connectors that allow limited vehicle rotational freedom in all three planes. In some of these train sets, the interior coaches share a truck, forming an articulated and permanently-coupled unit. Such restrictions on possible vehicle motions minimize the potential for vehicle rigid body buckling kinematics such as override and jackknife.

2.2 VEHICLE CRASHWORTHINESS DESIGN

As noted previously, a crashworthy transport vehicle is one which provides a safe environment for its occupants during the crash-related events that occur in a given accident scenario. Vehicle occupants can be injured or killed as a result of two principal mechanisms that arise from sudden acceleration or deceleration of a vehicle or train, or because of mechanical damage to the vehicle's structure or equipment: (1) a first or primary collision of the vehicle with another vehicle, object, or ground feature; and (2) one or more secondary collisions between the occupant and the interior of the vehicle at some time following the initiation of the primary impact¹. Occupant protection against the effects of the primary collision involves vehicle design elements that address the overall collapse of the vehicle's structure and kinetic energy management characteristics, occupant compartment integrity, and compartment acceleration environment. (In a train, the kinematic behavior of the entire consist determines the initial impact conditions experienced by each vehicle during the accident.) Protection against injuries resulting from secondary collisions entails consideration of the interior configuration of the vehicle compartment and its surface force-deflection properties, as well as human biomechanical response to impact-induced forces and accelerations. It should be noted that the nature and severity of these secondary collisions are also related to the overall vehicle acceleration response because this acceleration influences the contact velocity of the occupant relative to the compartment interior.

The interaction of these two mechanisms, that occur in crashes involving all types of transport vehicles, is discussed below from the perspective of general vehicle structure and interior design. Specific examples and illustrations of the processes involved are keyed to wheel-on-rail vehicles. A discussion of mechanisms of injuries sustained by human occupants and associated tolerance levels is presented in Chapter 3.

2.2.1 Vehicle Structure

Civil engineering types of structures, such as bridges and buildings, are designed such that their individual structural elements sustain maximum stresses well within the elastic limit of the material. From the macroscopic point of view, this means that the small deformation induced in each element disappears completely upon release or removal of the applied load, i.e., the member exhibits an elastic response. Other structural elements, such as a rotating shaft in a machine or motor, are designed to resist fatigue failure as well, i.e., material failure (fracture) within its elastic limit stress level which results from an extremely large number of repeated loadings.

Vehicle structures provide both service- and crashworthiness-related functions and are designed to resist two kinds of loading. The materials of such a structure must first elastically resist the effects of stresses and deformations while meeting a variety of normal operational objectives during its useful life. For example, the load carrying structure of an automobile must support the weight of its occupants, cargo, and surrounding components, as well as resist the dynamic loads transmitted to it from the wheel/tire/suspension system. These service-related objectives must be met for a wide range of environmental conditions that involve hot and cold temperatures,

¹Occupant casualties also result from post-crash events such as exposure to electrical shock, fires, toxic gases or explosions. These hazards are not addressed in this report.

moisture, corrosive action, etc. Moreover, they are subject to a variety of constraints such as size, weight, cost, manufacturing/assembly time, and aesthetic considerations.

The second loading condition constitutes a **one-time occurrence** arising from the effects of impact that stress the material beyond its elastic range into the so-called plastic response range. In this part of the material's stress-strain relationship, structural element deformation persists upon release or removal of the load (i.e., the material incurs a permanent set). The structure is sacrificed via its large-displacement response and subsequent collapse to protect something of value; for an automobile or any type of vehicle, that "something" is its cargo and/or occupants. How well the structure performs this function is one of the topics addressed in this subsection.

The exterior of **any** vehicle provides two basic crashworthiness-related functions: (1) to act as a protective shell or capsule around the compartment housing its occupants; and (2) to dissipate, in a controlled manner, the maximum possible kinetic energy of impact throughout the structure as it undergoes some acceptable amount of damage. The latter action also serves as a mechanism to limit the overall acceleration within the occupant compartment in an effort to reduce the number and mitigate the severity of secondary collisions. These roles of the vehicle structure are discussed below.

The size of the object impacted by (or propelled against) the vehicle is an important part of the first structural function. Collisions with large/massive objects (e.g., as in a train-to-train impact) entails consideration of the overall structural integrity of the vehicle. Here the emphasis is on the preservation of adequate occupant compartment space (i.e., limit its crush) to prevent harm to occupants from intruding compartment surfaces. Conversely, small objects propelled at the vehicle shell (e.g., a bullet or a rock) require an assessment of localized puncture resistance in the immediate vicinity of the impact. This distinction will be seen to be very important when the subject of HSGGT vehicle crashworthiness evaluation is addressed.

The second function addresses the issue of dissipating the kinetic energy of the moving vehicle masses involved in a collision. In general, transport vehicle kinetic energy is dissipated during an accident by means of mechanical and frictional work. For wheel-on-rail vehicles, this energy is consumed by the following physical processes:

- o Controlled vehicle structural deformations (i.e., crush without buckling and/or fracture)
- o Structural buckling
- o Sliding/rolling (e.g., vehicle wheels cutting through track ties, ballast, surrounding roadbed surfaces, etc.)
- o Impacts with wayside structures

Because only vehicle structure crush can be controlled, it is imperative that the structure be carefully engineered to collapse in a planned, sequential manner. That is, it must be designed to collapse at predetermined locations and under specific loads in order to absorb a maximum

amount of kinetic energy.² It should be noted, however, that the effectiveness of this process is limited by the total vehicle crush space available and the energy absorbing capacity of the structure itself (see discussion below).

Crash events subject vehicle structure to a severe loading environment characterized by high-intensity, short-duration forces. These forces cause transient deformation ranging from small elastic deformation and small strain to large plastic (i.e. permanent) deformation with large (finite) strain. The plastic deformation of a ductile metal vehicle structure subjected to impact loading can constitute an effective means of dissipating at least some portion of the initial kinetic energy of the moving masses. By appropriate design, vehicle structure can serve as an economical and efficient impact attenuation device to help protect occupants in a collision. The degree of success of such an endeavor is dependent upon many vehicle design factors, as well as the particular crash configuration and impact speed under consideration.

The manner in which a vehicle structure collapses under impact loading is manifested in the form of an acceleration environment that varies from point to point on the vehicle. The spatial average acceleration-time response experienced by the occupant compartment is commonly referred to as the vehicle crash pulse. The overall shape, magnitude, and duration of the entire crash pulse has a significant influence on vehicle occupant kinematics and injury potential arising from secondary collision contacts within the compartment and/or occupant interactions with an occupant restraint system that may be in place.

Ideally, one might design the vehicle structure to permit an acceptable level of compartment crush, while generating a nearly constant crash pulse (with a rapid onset rate) during a collision. In the real world, this objective can never be fully realized, but can often be approximated closely enough to provide the best possible compromise. Moreover, experience has shown that for those vehicles equipped with restraint systems, controlling the shape of the actual crash pulse within a design envelope that approximates this idealized acceleration response produces favorable conditions for the optimum functioning of these devices.

The third crashworthiness-related function, discussed above, of the vehicle structure can be viewed in terms of a kinetic energy *management* (in addition to merely a kinetic energy absorption) role. Thus, from the standpoint of occupant crash protection, *how* the crash energy is converted to mechanical work is just as important as the total quantity of energy that the structure can dissipate for a given accident scenario. It should be noted that the provision of a crash pulse amenable to satisfactory occupant crash protection does *not* guarantee the prevention of serious occupant injury in an accident to a train or any other means of transportation. The "friendliness" of the compartment interior design and the type and effectiveness of occupant restraint system (if any), discussed in Section 2.2.2, also play a major role in this regard.

Two fundamental physical concepts govern the overall structural response of vehicles involved in a collision: the laws of conservation of momentum and conservation of total energy. The simple

²Permanent deformation of the structural elements arising from this action converts much of the energy into mechanical work done on the structure.

case of collinear impact³ between two ground vehicles will be examined to derive expressions for the amount of kinetic energy that must be dissipated (primarily) by the vehicle structure and to illustrate other interesting facts about vehicle collisions in general. It should be noted that such impacts impose the most severe velocity change and energy absorption requirements on the striking vehicles of all inter-vehicular crash configurations.

The law of conservation of momentum (in this case, linear) requires that:

$$M_1 V_1 + m_2 V_2 = M_1 V_1' + m_2 V_2' \quad (1)$$

while the conservation of energy (here, translational) mandates that:

$$\frac{1}{2}M_1 V_1^2 + \frac{1}{2}m_2 V_2^2 = \frac{1}{2}m_1 (V_1')^2 + \frac{1}{2}m_2 (V_2')^2 + E_d \quad (2)$$

where

m_1, m_2 represent the mass of vehicles 1 and 2, respectively;

V_1, V_2 are the pre-impact velocities of vehicles 1 and 2 respectively;

V_1', V_2' are the post-impact velocities of vehicles 1 and 2 respectively; and

E_d is the total energy dissipated in the two vehicles during the crash as a result of permanent deformation of their structures.

Consistent with common practice, the energy dissipated by frictional forces (e.g., from tire/roadway or wheel/track sliding action after impact) will be neglected in the derivation presented herein.

To simplify the problem further, assume that the structures of both vehicles possess totally plastic (i.e., without elastic recovery) material properties in the region where crush occurs. In that case, the two vehicles remain in contact after the collision and acquire a common, post-impact velocity, V_f , i.e.:

$$V_f = V_1' = V_2' \quad (3)$$

Substitution of Equation 3 into Equation 1 leads to the solution for the common velocity V_f :

$$V_f = (m_1 V_1 + m_2 V_2) / (m_1 + m_2) \quad (4)$$

Substitution of Equations 3 and 4 into Equation 2 results in an expression for the total amount of energy dissipated in the collision:

³A collinear intervehicular impact is one in which the longitudinal axes of both vehicles are aligned along the same straight line at the moment of impact. Examples of such crash configurations are a head-on frontal collision and an aligned, front-to-rear impact.

$$E_d = m_1 m_2 (V_1 - V_2)^2 / 2(m_1 + m_2) = m_1 m_2 V_c^2 / 2(m_1 + m_2) \quad (5)$$

where

$$V_c = V_1 - V_2 \quad (6)$$

is the pre-impact closing velocity of the two vehicles.

It should be noted that E_d , the total energy absorbed in the collision, can be regarded as an indicator of potential damage that can be inflicted on the vehicles by the collision. Equation 5 shows that there will be less of this energy available to damage the vehicles for the case where one or both are lightweight compared to the case where both vehicles are heavy.

It is instructive to compute the dissipated energy for identical-velocity, collinear collisions involving vehicles from three widely different ground transportation modes. For two, 1134 kg (2500 lb) automobiles impacting at a closing velocity of 80 km/h (50 mph), Equation 5 indicates that 142 kJ (1.04×10^5 ft-lb) of energy must be absorbed in the collision. For two 27216 kg (60,000 lb) heavy trucks, the same impact condition produces 3.42 MJ (2.51×10^6 ft-lb) of energy that must be absorbed. The heavy truck energy absorption parameter is 24 times that of its automobile counterpart. If the identical collision were between two five-vehicle trains comprising 36288 kg (80,000 lb) vehicles, E_d would be 22.8 MJ (16.7×10^6 ft-lb), potentially 160 times more destructive than the impact between the two automobiles cited above. The same impact between the above-noted automobile and heavy truck would necessitate that 0.27 MJ (2.0×10^5 ft-lb) of kinetic energy be dissipated, nearly twice the amount present in the automobile-to-automobile impact. Figure 2-1 illustrates these relationships for closing velocities between 0 and 80 km/h (50 mph).

Equations 4 and 5 show that the final common velocity of the two idealized vehicles after impact and the kinetic energy that must be dissipated in both vehicles is determined only by the masses and pre-crush velocities of the two vehicles and are totally independent of their individual crush characteristics. That is, these parameters are unaffected by the construction of the impacting vehicles. Equation 5 also reveals that a large-mass, stationary vehicle impacted by a small-mass vehicle moving at a given velocity results in the same total energy absorption that would be generated for the case of the stationary, lighter vehicle being impacted by the heavier vehicle moving at the same velocity.

It should be noted that Equation 5 does not reveal what percentage of the permanent structural deformation, and hence energy absorption, occurs in each vehicle. For every collision there is a fixed magnitude of kinetic energy that must be absorbed by the two vehicle structures. How this energy is distributed between them depends on the structural design and material used in their construction. In general, an accurate determination of this distribution requires knowledge of the force-deflection properties of the vehicle regions that deform during a collision.

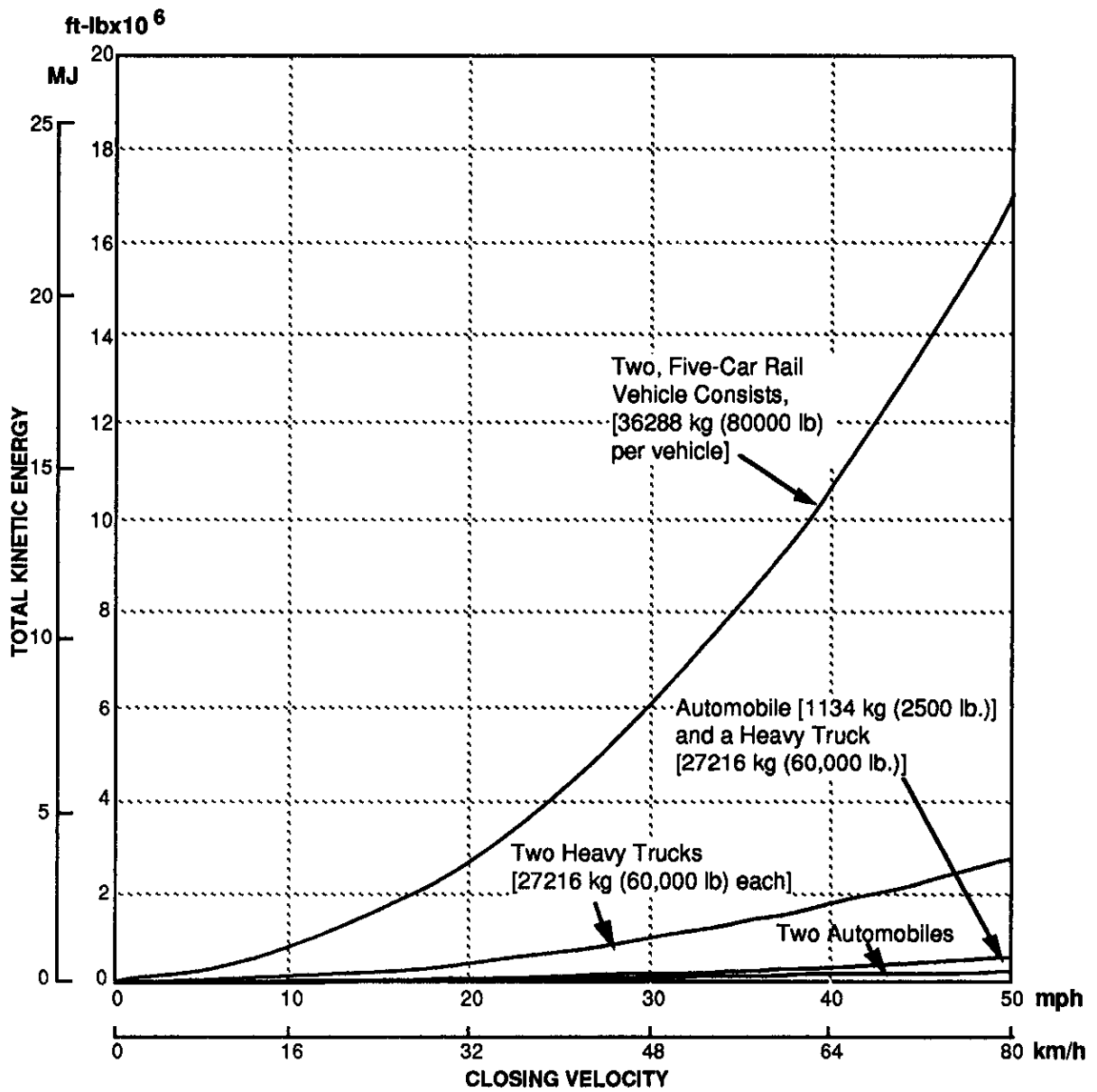

Figure 2-1 Total Kinetic Energy Absorbed in a Collinear Vehicle Collision

Actual vehicles are composed of structural elements and functional components/assemblies that exhibit an elastic-plastic response to deformation. Thus, in the absence of override and/or entangled structure, two such vehicles involved in a collinear impact would begin to separate at the time of maximum total vehicle crush, i.e., at the instant Equation 5 is satisfied (time t_d). As elastic recovery of the compressive strain begins at t_d , the distorted vehicle structures would expand somewhat, resulting in the generation of a differential velocity between them. Vehicle rebound motion would ensue and this recovered energy would be released from the structure, reducing the magnitude of consumed kinetic energy. Elastic recovery energy, however, is negligibly small compared to the energy absorbed by the vehicle structure in a high-speed crash. Thus its effect on E_d and similar relationships is usually neglected in most analyses.

The derivation of Equation 5 does not account for another source of kinetic energy absorption. Vertical accelerations, resulting from an offset between the height of the vehicle's center of gravity and the effective crash force vector, produce pitching motion and some energy dissipation during even a collinear impact. This energy absorption usually constitutes a relatively small percentage of its impact-direction counterpart and is also usually neglected.

It is well known that most frontal or rear motor vehicle accidents do not conform to the perfectly aligned collision case employed to generate the above-noted energy dissipation expression. The vast majority of such collisions involve some eccentricity and/or angularity between vehicles. The net effect of these real-world crash conditions is manifested in the form of vehicle redirection and rotation. The associated translation and rotational kinetic energy retained by the vehicle thus need not be dissipated by the deformation of its structure. This situation provides some relief from the velocity change and energy absorption requirements given by Equations 4 and 5, respectively.

It should be noted that the equations formulated above are also theoretically applicable to front-to-side perpendicular collisions between two vehicles. However, this impact configuration generally produces substantial energy dissipation arising from tire/roadway friction or wheel/rail/roadbed deformation and friction which cannot be neglected. This complication introduces an unknown error into the expression for the energy absorbed during the impact.

The total energy absorbed by the permanently deformed vehicle structures can be expressed as:

$$E_d = E_{d1} + E_{d2} \tag{7}$$

where E_{d1} and E_{d2} represent the energy absorbed by vehicles 1 and 2, respectively. Using the equivalence of energy and work, Equation 7 can be written:

$$E_d = (F_{AV})_1 L_1 + (F_{AV})_2 L_2 \tag{8}$$

where $(F_{AV})_1$ and $(F_{AV})_2$ are the respective magnitudes of the average force acting on vehicles 1 and 2 at the crash interface, while L_1 and L_2 are the respective dynamic crush of vehicles 1 and 2.

By Newton's second law of motion:

$$(F_{AV})_1 = m_1 (a_{AV})_1 \quad (9-a)$$

$$(F_{AV})_2 = m_2 (a_{AV})_2 \quad (9-b)$$

where $(a_{AV})_1$ and $(a_{AV})_2$ are the average accelerations of the center-of-mass of vehicles 1 and 2, respectively. It should be noted that use of the center of mass accelerations in Equations 9-a and -b constitutes a first-order, rigid body approximation to the average force developed at the crash interface. This observation is based on the fact that these equations fail to account for a number of factors: (1) the inertial effects of the various large, stiff mass concentrations that are found in any vehicle (e.g., the truck assembly of a rail vehicle) which generally do not dissipate much kinetic energy but can significantly affect the structure collapse mode; (2) reduced vehicle mass undergoing acceleration and deceleration during structural collapse as the structure and functional components come to a stop at the crash interface; and (3) the corresponding change in the location of the center of mass during this action.

By Newton's third law of motion, the interface forces between the colliding vehicles are equal. It follows from Equations 9-a and -b that:

$$(a_{AV})_1 = m_2 (a_{AV})_2 / m_1 \quad (10)$$

Equation 10 shows that:

$m_2 = m_1$ (equal weight vehicles)⁴ $(a_{AV})_1 = (a_{AV})_2$, i.e., both vehicles experience equal average acceleration magnitudes during the collision.

$m_2 > m_1$ (vehicle 2 heavier than vehicle 1) $(a_{AV})_1 > (a_{AV})_2$, i.e., the lighter vehicle experiences a higher average acceleration magnitude than the heavier vehicle during the impact.

Substitution of Equations 9 and 10 into Equation 8 yields:

$$E_d = m_2 (a_{AV})_2 (L_1 + L_2) \quad (11)$$

Consider the case where the colliding vehicles have identical mass and vehicle 2 is stationary. This renders:

$$m_1 = m_2 = m \quad (12-a)$$

$$(a_{AV})_1 = (a_{AV})_2 = a_{AV} \quad (12-b)$$

$$V_1 = V_0 \quad (12-c)$$

$$V_2 = 0 \quad (12-d)$$

Substitution of Equations 12-a and 12-b into Equation 11 yields:

⁴The weight of a body of mass m is equal to mg , where g denotes the magnitude of the acceleration of a body due to gravity. A magnitude of 9.81 m/s^2 (32.2 ft/sec^2) is commonly used for g in crash mechanics applications.

$$E_d = ma_{AV} (L_1 + L_2) \quad (13)$$

while substitution of Equations 12-a, 12-c and 12-d into Equation 5 results in:

$$E_d = mV_0^2/4 \quad (14)$$

The latter two equations can be solved for the total vehicle crush $L_1 + L_2$ in terms of the impact velocity of the striking vehicle and the average acceleration level of both identical-mass vehicles, i.e.:

$$L_1 + L_2 = V_0^2/4a_{AV} \quad (15)$$

As was the case with Equation 5, Equation 15 cannot, in general, be used to ascertain the crush magnitude for either vehicles 1 or 2; only the total crush can be calculated. If, however, the two lead vehicles have identical structural force-deflection characteristics in the region of impact and override does not occur, then the structures of both vehicles undergo an identical crush L , i.e.:

$$L_1 = L_2 = L \quad L_1 + L_2 = 2L \quad (16)$$

and Equation 15 becomes, for this special case:

$$L = V_0^2/8a_{AV} \quad (17)$$

Consider an accident in which a moving vehicle strikes an identical, standing vehicle head-on while moving at velocity V_0 . Each vehicle will undergo a crush L given by Equation 17. Assume that the vehicles are designed to produce an idealized, rectangular-shaped crash pulse during a collinear collision. Equation 17 can be used to generate curves depicting the dynamic crush as a function of impact velocity at various levels of constant acceleration. Figure 2-2 shows that if, for example, the allowable occupant compartment acceleration level for both identical vehicles is 2 g's, a 200 km/h (125 mph) collision will produce 20m (65 ft) of crush in each vehicle. This distance decreases as the level of permissible compartment acceleration increases (e.g., a 5 g allowable compartment acceleration threshold requires 8m (26 ft) of crush in each vehicle to stop the vehicle at the same speed).

An expression for the energy that must be dissipated by the vehicle structure for the case of perpendicular vehicle impact with non-yielding, flat wall (i.e., a "rigid" barrier) can be obtained from Equation 5. This equation can be written as:

$$E_d = m_1(V_1 - V_2)^2/2(m_1/m_2 + 1) \quad (18)$$

With $m_1 = m$ (the vehicle mass), wall mass $m_2 \gg m_1$, (i.e., m_2 assumed much greater than the vehicle mass), vehicle impact velocity $V_1 = V_0$, and fixed wall mass velocity $V_2 = 0$, Equation 18 becomes, in the limit, as m_2 approaches infinity:

$$E_d = mV_0^2/2 \quad (19)$$

For the flat barrier impact condition, the rigid barrier does not move during the collision. Therefore, the second term in Equation 8 drops out, leaving:

$$E_d = F_{AV}L = ma_{AV} L \quad (20)$$

Because E_d is constant, Equation 20 can be satisfied for all combinations of F_{AV} and L . This means that for a given energy dissipation level E_d , a vehicle can be designed to be very "stiff" (i.e., undergo relatively little collapse at a high force level) or very "soft" (i.e., undergo massive collapse at a low force level), or be designed to resist some level of force and crush in between these two extremes. This tradeoff between these two impact response parameters holds true for any impact configuration.

Equation 20 can also be satisfied for all combination of a_{AV} and L . Thus a stiff structure subjects the vehicle compartment to a high-magnitude acceleration pulse with relatively little dynamic collapse, while a soft structure imparts a much lower crash pulse level to the compartment at the expense of greater collapse. This tradeoff between acceleration and crush is also valid for all crash configurations.

From Equations 19 and 20:

$$L = V_0^2/2a_{AV} \quad (21)$$

represents the corresponding crush of the vehicle for the flat barrier impact configuration.

The tradeoff between allowable crush and crash pulse magnitude can also be examined in the context of the vehicle strength-to-weight ratio in the direction of impact. Here, high strength is synonymous with both high vehicle crush resistance and compressive force developed during a certain collision condition. Vehicle strength can sometimes be increased significantly with only a small attendant weight penalty by means of judicious design practice, such as the appropriate selection of structural member material, cross section, and orientation; the selective use of stiffness; and maintaining integrity between connecting vehicle elements. The optimum combination of strength and weight is grounded in practical considerations such as manufacturing and operating costs (i.e., fuel economy) as well as maximum passenger and cargo capacities.

The vehicle strength-to-weight ratio (STWR) is also indicative of the acceleration environment experienced by vehicle occupants. Thus the low axial STWR characteristic of a typical passenger coach, together with a relatively long crash pulse duration, generally produces a very low crash pulse amplitude (of the order of several g's for up to several seconds) for a typical train-to-train collision. On the other hand an automobile, which has a higher axial STWR, generates a significantly higher time-average crash pulse over a shorter (by an order of magnitude) duration (15 g's over about 100 milliseconds are representative numbers) in a typical vehicle-to-vehicle impact.⁵ It should be noted that the occurrence of vehicle override significantly reduces the

⁵A millisecond is one-thousandth of a second.

calculated STWR of the overridden vehicle, thereby wasting its potential to absorb the kinetic energy of impact.

The area of the structure which engages and resists an impacted obstacle also influences the vehicle crash pulse and total compartment intrusion. For example, consider a vehicle moving at a given velocity. In case 1, assume that the vehicle impacts a narrow, rigid pole head-on, collinear with its longitudinal centerline, while in case 2, it impacts a flat, rigid wall head-on. The average crash pulse magnitude sustained by the vehicle in case 1 will be lower than that experienced by the vehicle in case 2. However, the occupant survival space in the case 1 vehicle may be significantly compromised as a result of greater compartment crush relative to that of the case 2 vehicle.

Finally, it should be noted that because of practical design and cost considerations and the tremendous amount of kinetic energy involved in many accidents involving all types of transport vehicles, it may not be economically feasible to design a vehicle to prevent fatalities or serious casualties for all possible accident scenarios. This situation can be illustrated by referring to the case of the idealized collinear, train-to-train collision shown in Figure 2-2. Examination of this graph shows that substantial total dynamic crush can occur even at moderate allowable compartment acceleration levels (i.e, up to 10 g's) for the case of impact speeds near 160 km/h (100 mph). A coach design that raised the acceptable compartment acceleration level in an effort to decrease the total dynamic crush would most likely require the use of more and/or heavier structural elements, resulting in a significant, undesired weight penalty. Moreover, as will be seen in Section 2.2.2, an extremely stiff vehicle structure would substantially increase the relative contact velocity between unrestrained coach occupants and the coach interior, aggravating the level of potential injury severity.⁶

As a second example, the side impact of a passenger coach by a locomotive at even a moderate speed would probably produce massive coach sidewall crush for virtually any practical coach design. Numerous and severe coach occupant casualties in and immediately adjacent to the impact zone would probably be unavoidable in this accident mode.

The latter sobering acknowledgment of reality, however, should not preclude vehicle designers from making a concerted effort to upgrade the overall vehicle structure collapse resistance and integrity. By doing so, occupant injury risk for less severe and/or different accident configurations could be significantly reduced. For the case of the passenger coach cited above, such a crashworthy structure would provide increased occupant protection for a lower-speed axial impact (Example 1) and perhaps reduce occupant harm in a side impact by an inherently "softer" vehicle such as an observation car in a backing train accident (Example 2). Rollover protection could also conceivably be enhanced by a more crashworthy structural design.

⁶In the limiting case, an extremely stiff vehicle design such as a military tank, would subject fully restrained occupants to an intolerable acceleration level during a high-speed crash.

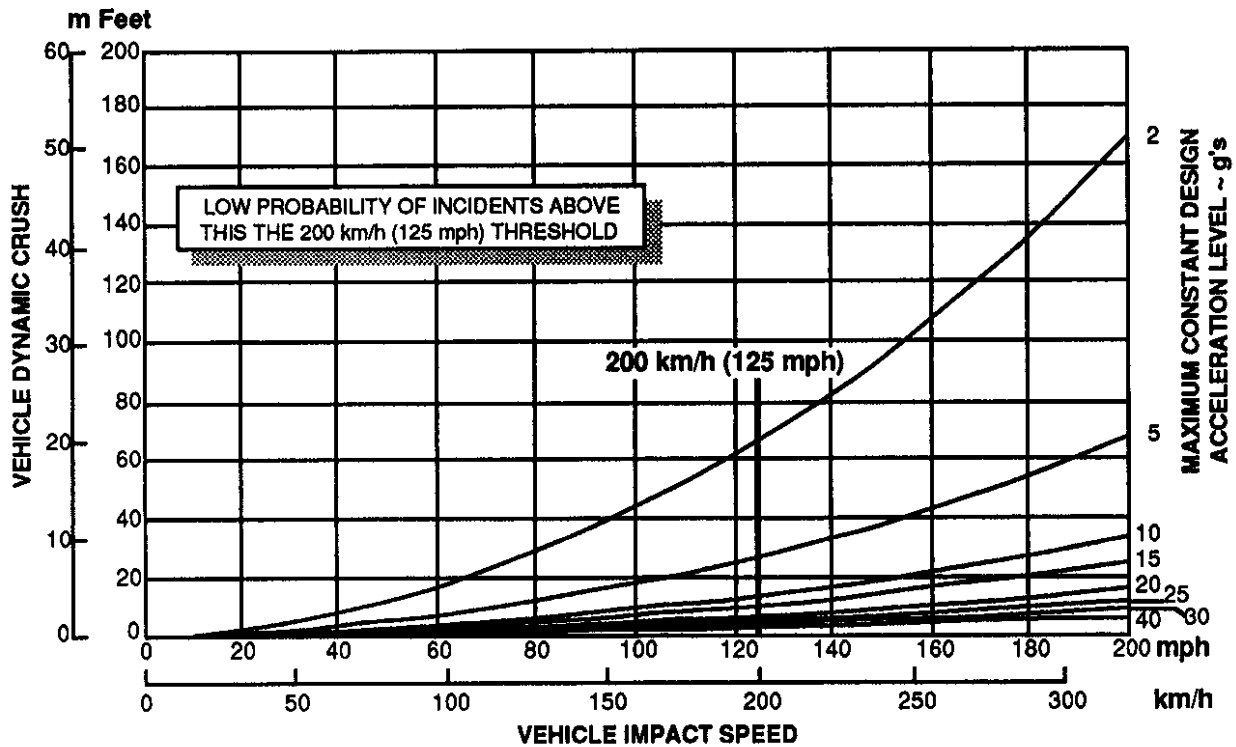

Figure 2-2 Rail Vehicle Axial Crush Requirements for a Rectangular Crash Pulse: Collinear Impact with an Identical, Stationary Vehicle

2.2.2 Vehicle Interior

As noted in the preceding section, the overall and local integrity and energy management characteristics of a vehicle structure provide a cushioned, protective capsule for vehicle occupants during a collision. The provision of adequate structural integrity ensures that the vehicle occupants will not be crushed by encroaching vehicle structure, struck by projectiles, impaled by parts of the object or other vehicle impacted, or ejected from the vehicle. It was also noted that the structure energy management characteristics manifest themselves in the form of the vehicle crash pulse (occupant compartment acceleration-time response), which also affects the response of the occupant during the crash.

The crash pulse and potential for occupant/interior contacts can vary substantially within the compartment of large-volume vehicles (e.g., buses, commercial transport aircraft, mass transit vehicles, and intercity passenger coaches) and from vehicle to vehicle in a multilinked system of vehicles (i.e., a train). In vehicles having a small-volume compartment (e.g., automobiles, multipurpose passenger vehicles and light trucks), the occupants must remain seated while in the vehicle and are provided with belt (and possibly airbag) restraint systems. Surrounding compartment surfaces have, to the extent feasible, been designed to be "friendly" (i.e., they have smooth surfaces and force-deflection characteristics designed to absorb kinetic energy and distribute impact loads over a relatively large portion of the body) in an effort to minimize the risk of occupant injury from an interior contact. **Without restraint systems and compartment interior cushioning features, the occupants of the latter type vehicles would have no chance of surviving the typical moderate-speed accidents that occur on roadways.**

The occupants of large-volume compartment vehicles are subject to a greater variety of potential (and often more dangerous) interior contacts in a collision, even though the crash pulse itself may not be severe, because of the reasons noted below:

- o The large volume of the compartment itself and the absence of an adequate restraint system, permitting undesirable high relative occupant/compartment velocities (see later discussion)⁷
- o Myriad potential impact surfaces, many of which are inherently "unfriendly," i.e., exhibit an irregular contour and/or have a low energy absorption capacity⁸
- o Seats facing in various directions⁹
- o The presence of standing/walking occupants
- o The possibility of being struck by loose objects moving about the compartment

In a vehicle collision, the velocity of the vehicle (and hence its occupant compartment) changes rapidly. If there is an open space between an unrestrained occupant and the compartment interior, the occupant's velocity in the direction of vehicle travel will differ somewhat from that of the compartment. The characteristics of the vehicle crash pulse and the distance the occupant moves before contacting a compartment surface determines the relative velocity of the contact. A simple example of the physics involved in a typical secondary impact of an unrestrained occupant is described below.

The motion of an unrestrained occupant (regarded, for the sake of simplicity, as a single mass) in a forward-facing seat during a vehicle frontal collision can be divided into the three phases shown in Figure 2-3. As the vehicle impacts an object and starts to decelerate, the occupant continues to move forward at nearly the initial vehicle impact velocity, V_1 . This period of "free flight", denoted as Phase I, ends when the available translation space of the vehicle interior is used up,

⁷Lap-type seat belts are available but are not always used by transport airplane passengers during all phases of a flight.

⁸Here a "surface" can be constructed as a compartment wall, partition, floor or ceiling; seat; baggage; another occupant; etc.

⁹This situation does not apply to airplanes.

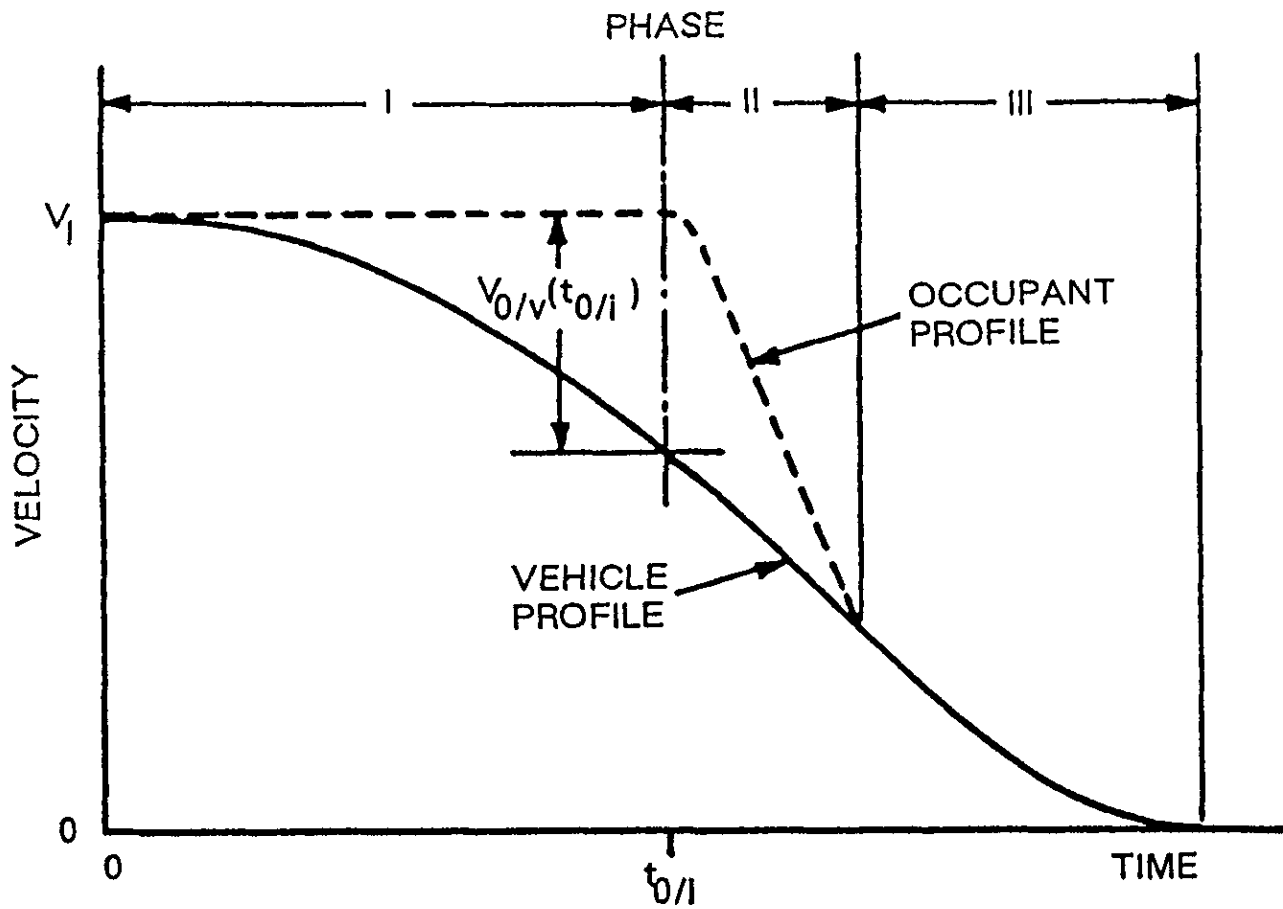

Figure 2-3 Hypothetical Vehicle and Unrestrained Occupant Velocity Profiles: Frontal Collision Mode

i.e., when occupant contact with an interior surface occurs at the time $t_{0/i}$. This time marks the beginning of Phase II; the occupant has a relative velocity with respect to the vehicle that is denoted by $V_{0/v}(t_{0/i})$.

As noted in Section 2.2.1, a vehicle crash pulse which exhibits a high average acceleration level and/or a relatively early high peak magnitude over a sufficiently long duration would cause the vehicle velocity profile depicted in Figure 2-3 to change more rapidly and consequently approach zero much faster than a comparatively "milder" crash pulse would. As a result, the relative

unrestrained occupant/vehicle interior impact velocity $V_{0/v}(t_{0/i})$ would be greater in the former case and would cause a higher severity injury.

During Phase II, the occupant is decelerated until his relative velocity with respect to the vehicle is zero. In Phase III, for an assumed ideally plastic occupant/interior surface impact (shown in Figure 2-3), the occupant remains in contact with the compartment interior surface (i.e., reacts like a part of this surface) and decelerates to zero velocity with the vehicle. **0** The latter phase is referred to as the "ridedown" interval of a collision.

The greatest potential for occupant injury exists during Phase II compartment interior engagement. The kinetic energy associated with the occupant's relative velocity with respect to the vehicle compartment is dissipated through deformation of the vehicle compartment interior (assumed well-contoured/padded and reasonably deformable) and the occupant himself. As noted previously, injury potential during this phase is a function of both the occupant/compartment relative impact velocity $V_{0/v}$ and the force-deflection characteristics of the vehicle interior.⁽¹¹⁾ Thus, for example, a seated occupant in a front-to-front train collision would ride down the impact by engaging the seat back in front of him. A properly designed seat back (i.e., one which would yield and cushion the impact, thus limiting forces and accelerations to acceptable human tolerance levels) could provide acceptable occupant restraint for *this particular accident scenario*. Such an occupant retention mechanism would not be useful for some other accident configuration, e.g., side impact or rollover.

As alluded to earlier, the risk of injury is likely to be particularly severe for standing or walking passengers because of the greater distance they may move before striking, at possibly a very high relative velocity, some obstacle in the compartment (see Figure 2-3).

The basic principle behind the use of a restraint system is the deployment of a specially designed load-carrying, deformable mechanism between the occupant and the compartment interior. Restraint systems serve a twofold purpose. They enable a vehicle occupant to decelerate (or accelerate) with the vehicle during an accident, permitting him to undergo a more controlled motion within the confines of the available stroking distance (i.e., free space) in the compartment.⁽¹²⁾ As a result, the velocity and motion of the occupant relative to that of the

(10) Actual occupant/compartment interior impacts are generally partially elastic, resulting in occupant rebound.

(11) In an ideal crashworthy vehicle, controlled collapse of its exterior structure results in a crash pulse which minimizes the magnitude of $V_{0/v}$.

(12) An example of a passenger rail coach compartment stroking distance is the horizontal clearance between the front of the passenger's head (relative to his normal, pre-crash seated position) and the rear surface of the seat back in front of him.

compartment is reduced, preventing, or at least attenuating the severity of contact(s) with compartment surfaces or other occupants. A properly restrained occupant will experience a modulated form of the overall average vehicle crash pulse which reflects the force-deflection characteristics of the restraint system, the local acceleration environment at the seat and restraint system mounting points, as well as at all seated occupant/compartment contact areas (e.g., seat and floor), and the compliance between the restraint system and the occupant's body over the area where such contact occurs.

Restraint systems also distribute the force of the vehicle crash over the body parts that can best withstand it. For example, for the case of an occupant restrained by a 3-point belt system, the force is spread diagonally over the entire chest and the abdomen over the strong pelvic bones. A typical chest acceleration response measured in a 3-point belt-restrained Hybrid II dummy in the right-front passenger seating position during an actual 56 km/h (35 mph) flat frontal barrier automobile crash test is depicted in Figure 2-4. The crash pulse (i.e., the compartment acceleration-time response in the direction of impact) is shown superimposed on the chest acceleration profile. Examination of this figure shows that the chest acceleration lags the crash pulse (by about 25 milliseconds) until the restraint system retractor locks and tensile belt restraint forces begin to develop. As the belts load and stretch, occupant forward motion is smoothly arrested at a relatively low average deceleration level over a long duration. Indeed, the maximum resultant chest acceleration magnitude (not shown) over a three millisecond duration, indicative of the potential for serious chest injury, was only 45 g's, well below the 60 g allowable FMVSS 208 limit.(13) The dummy experienced no contacts with compartment interior surfaces during the test.

In marked contrast, when an unrestrained occupant strikes an interior surface, he usually experiences a large impact force over a small area of the body. The high pressure generated produces extremely high accelerations in the contacted body region, often causing severe injuries or death. For example, an unrestrained right-front passenger Hybrid II dummy in the same test exposure discussed above would slide forward on the seat, the knees would engage the lower portion of the dash panel and the chest would slam into the upper dash at a relative impact speed $V_{0/v}$ somewhat under 56 km/h (35 mph). Head contact would occur with the upper dash panel and/or the lower surface of the windshield. The chest x acceleration profile would exhibit vastly different characteristics compared to the curve depicted in Figure 2-4. The unrestrained dummy test chest acceleration waveform would be extremely narrow (i.e., be concentrated over a very short time interval) with a peak magnitude approximately two to three times higher than that registered in the restrained dummy test. Resultant chest acceleration, HIC and perhaps even the femur force levels would all exceed maximum permissible injury tolerance values.

(13) Passenger HIC was 558, maximum left and right femur forces were 1433 and 1722 N (322 and 387 lbf), respectively, well below their FMVSS 208 stipulated tolerance levels. These injury indicators are discussed in Section 3.

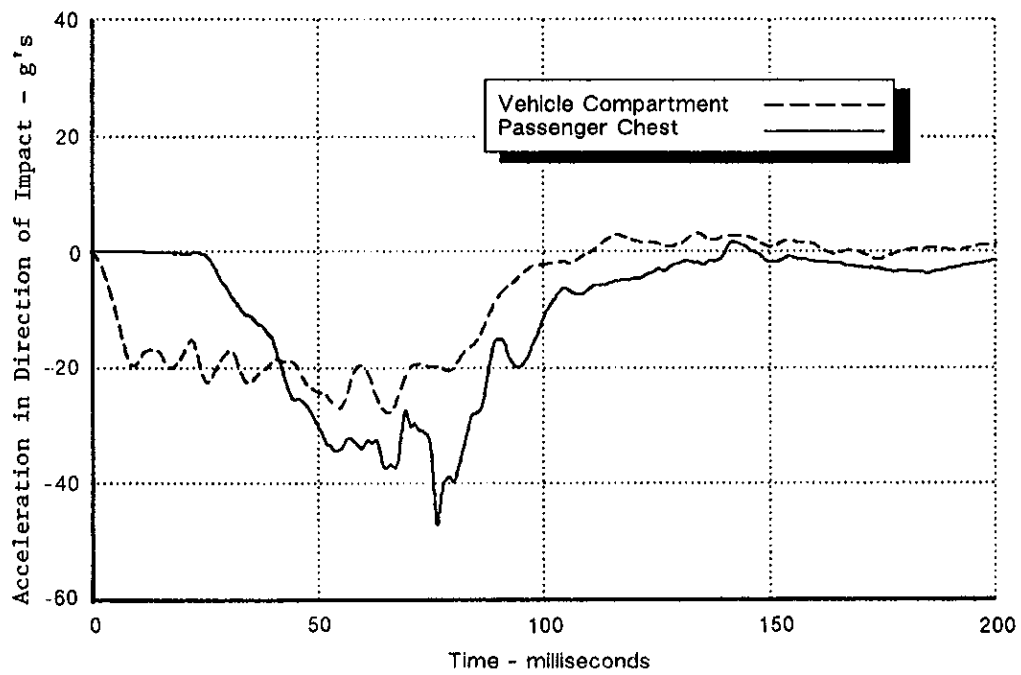

Figure 2-4 Comparison of Automobile Compartment and Belt-Restrained Passenger Acceleration Responses: 56 km/h (35 mph) Flat Frontal Barrier Crash Test

3. HUMAN INJURY IN VEHICLE CRASHES

This chapter presents a broad overview of the research that has been conducted in an effort to understand the mechanisms involved in occupant injury resulting from vehicular accidents. Section 3.1 provides a brief introduction to the subject, including a general discussion of the mechanics of occupant impact, human tolerance to impact, and the manner in which data that could be useful for describing human response to impact are obtained. The next section (3.2) present a brief history of some of the more notable findings in the area of biomechanical research on impact-induced physical trauma. Values that are currently accepted as thresholds that indicate the possibility of serious occupant injury in vehicle crashworthiness evaluation simulations are summarized in Section 3.3. Finally, Section 3.4 outlines some of the current work in the field of biomechanical research that will someday help provide a more definitive assessment of occupant injury in a vehicle crash environment.

3.1 BACKGROUND INFORMATION

Two general classes of casualties can occur in a vehicle crash. The first kind, referred to here as Type A casualties, occur as a result of a breakdown of the overall or local vehicle structural integrity. Such failures produce either crush of the occupant's body because of a loss of minimum compartment survival space, or penetration of the body by a projectile or some part of a relatively slender intruding obstacle. The other kind, termed Type B casualties, stem from relatively blunt contacts between the occupant and any portion of the compartment interior (including other occupants) and/or from concentrated loadings stemming from the interaction between the occupant and the restraint system (if any). These secondary collision effects can cause physical trauma even though the vehicle structure maintains some measure of acceptable compartment survival volume and resistance to local penetration.

Analyses of road vehicle and passenger train accident data has revealed that most occupant casualties are of the Type B variety, i.e., they occur as a result of secondary collisions within the vehicle compartment. The kinetic energy of impact is absorbed by the body in the form of forces and moments. These impulsive loadings and associated accelerations sustained by the occupant cause both visually apparent injuries, such as contusions (bruises), lacerations (cuts), fractures and dislocations, as well as internal injuries to organs, soft tissues, and the nervous system.

For an **unrestrained** vehicle occupant involved in a crash event, Type B injury potential is dependent upon a number of different factors, e.g., occupant mass, relative occupant/compartment impact velocity, body region/compartment impact configuration, area of body contact, energy absorption capacity of the compartment surface(s) contacted, and the amount of body support provided (e.g., by a seat) during the event.

The severity of such injuries sustained by a **restrained** occupant is influenced by additional factors such as the effectiveness of the restraint system, which may or may not prevent portions of his body from contacting the vehicle interior or other occupants. Loadings applied to the body by virtue of the restraint system itself and other vehicle interior/occupant localized contact areas (e.g., varying pressure distributions exerted on the occupant by the floor and seat) constitute another set of factors that affect restrained-occupant injury potential in vehicle crash exposures.

Regardless of their source, localized loadings imparted to the body via these mechanisms strain (and hence stress) the body at their points (areas) of application; if the strain is excessive, bodily injury occurs. Factors influencing the extent of injury (if any) are the magnitude, direction, and onset rate of the load acting on a specific region of the body, and the duration of this load relative to the response time of the body region upon which it acts. The ratio of the time of load application to the body region response time is also important; this parameter governs the magnitude of load that is actually felt.

Biomechanical research on physical trauma caused by impulsive loadings has been ongoing for a relatively long time. This work, that has been conducted principally with automotive and aircraft occupant crash safety applications in mind, addresses a variety of topics. It includes the collection of data to identify significant parameters that can be used to determine body region injury producing mechanisms caused by impact loads and accelerations; the development of human impact tolerance levels (i.e., human injury criteria); the development of occupant restraint and other compartment interior protective systems; and the development of anthropomorphic test devices (i.e., ATDs or dummies) used to apply the injury criteria and to evaluate the effectiveness of those systems in a dynamic test environment. Such testing is performed by various segments of the vehicle research community as part of the development and evaluation of crash safety vehicle systems. In the latter work, production vehicles or various systems from such vehicles are tested using instrumented dummies to ascertain compliance with government-mandated standards or regulations that define the onset of probable serious Type B occupant harm.

A broad spectrum of impact biomechanical response studies have been performed in an effort to quantify the dynamic response and injury tolerance limits of body regions and components subjected to such short-duration loadings. Unfortunately, the wide range of variation in human tissue strength and stiffness characteristics has rendered the determination of such average responses and associated injury criteria an extremely difficult task. Age, sex, and physical conditions are only a few of the variables that affect the tolerance of humans to impact [3-1 and 3-2]. Age is of particular importance, with the degree of injury for a given impact increasing markedly at the higher age level. In some exposures, however, the tolerance level is low for young people. With the variation from person to person in the ability to sustain impact without injury, it should be realized that in any given environment a person least able to withstand the impact will be injured by a collision of relatively low severity, while the more resistant person will sustain no injury whatsoever under the same conditions. In any event, the strength of the nebulous "average" young male in good health is the basis for the establishment of human injury tolerance levels.

Human tolerance to such physical trauma is difficult to establish because of the obvious impracticality of subjecting humans to dynamic loading conditions which could cause serious injuries. Consequently, other means are employed to develop this data, most notably, human

(1) A human tolerance parameter may be defined as a test measurement, or quantity derived from a test measurement (e.g., measured on a human cadaver), whose value correlates with the occurrence of injury. Thus, it is a measure of physical stress and an indicator of whether or not that stress is sufficient to cause injury. In this report, a human tolerance level will denote the level of loading/acceleration on a body region or component that results in serious, but not life-threatening, injury.

surrogates whose mechanical and kinematic responses to impact approximate those of a living human being. Human cadavers are one such surrogate utilized for this purpose. Bruising, bone fractures and internal injuries sustained by cadavers in impact tests are often similar to those suffered by people involved in corresponding accident exposures. However, many questions exist as to how applicable these postmortem data are to living humans. For example, if the skull of a cadaver fractures at some known force, would a live vehicle occupant experience skull fracture at the same force level? In addition, most cadaver test subjects were old at the time of death and thus had relatively brittle bones. This factor also erroneously skews the correlation of cadaveric fracture force data to the range of such values for living humans.

Various vertebrate animals are also employed in impact biomechanics research because their life systems are similar to that of humans. Use of such surrogates does present problems because of major differences in anthropometry and anatomical structure between man and most animals. In addition, extreme difficulties are encountered trying to scale animal response and tolerance data to the human level.

Virtually all crash researchers employ the Abbreviated Injury Scale (AIS) to classify injury severity levels. The most recent version of this rating scale, designated as AIS 85, is shown in Table 3-1. This scale contains several categories of injury severity. They range from AIS-0, which denotes no injury, to AIS-6, which indicates injuries so severe that they would most likely be fatal. Table 3-2, reproduced from [3-3], provide some examples of AIS values corresponding to typical injuries which occur to different body regions. This reference also presents an in-depth discussion of the use and interpretation of this injury scale. The AIS provides vehicle crash researchers anywhere in the world with a standardized, consistent numerical methodology for describing and ranking the nature and severity of injuries sustained by all regions of the body.

3.2 AN OVERVIEW OF BIOMECHANICAL RESEARCH ON IMPACT TRAUMA

Because most survivable vehicle accident injuries occur as a result of concentrated loadings applied to individual body areas (i.e., type B trauma), human tolerance to injury is studied on the basis of localized impact and acceleration responses, rather than in terms of whole-body acceleration response. This subsection presents a brief history of impact biomechanical research performed on various regions of the human body. This survey is by no means meant to be exhaustive; it is merely intended to illustrate the nature of the work done in this field. The reader is referred to references [3-3, 3-4, 3-5, and 3-6] for a more comprehensive and updated discussion of this topic.

Head

Head injury involves the skull, scalp and/or brain and results from direct impact or inertial loading. (Facial injury is regarded as a separate category of physical trauma.) The former mechanism involves a short-duration impulsive loading and a high-acceleration peak while the latter is associated with a purely translational (i.e., linear) and/or angular acceleration pulse over a significantly longer time period. Brain injury may be produced by both mechanisms while fractures occur as a result of impact only.

**Table 3-1
Abbreviated Injury Scale**

AIS Code	Injury Severity
0	None
1	Minor
2	Moderate
3	Serious
4	Severe
5	Critical
6	Maximum Injury (virtually unsurvivable)

**Table 3-2
Correlation of Typical Body Region Injury with AIS Level**

AIS Code	BODY REGION				
	Head	Thorax	Abdomen and Pelvic Contents	Spine	Extremities and Bony Pelvis
1	Headache or dizziness	Single rib FX	Abdominal wall: superficial laceration	Acute strain (no FX or dislocation)	Toe FX
2	Unconscious less than 1 hour; linear FX	2-3 rib FX; sternum FX	Spleen, kidney or liver laceration or contusion	Minor FX without any cord involvement	Tibia or pelvis or patella: simple FX
3	Unconscious 1-6 hours; depressed FX	≥4 rib FX; 2-3 rib FX with hemothorax or pneumothorax	Spleen or kidney: major laceration	Ruptured disc with nerve root damage	Knee dislocation; femur FX
4	Unconscious 6-24 hours; open FX	≥4 Rib FX with hemothorax or pneumothorax; flail chest	Liver: major laceration	Incomplete cord syndrome	Amputation or crush above knee; pelvis crush (closed)
5	Unconscious more than 24 hours; large hematoma (100 cc)	Aorta laceration (partial transection)	Kidney, liver or colon rupture	Quadriplegia	Pelvis crush (open)

Note: FX denotes fracture

The relative contribution of translational and angular accelerations in head injury has been a contentious matter for a long time. Experiments performed by Stalnaker [3-7] and Ommaya [3-8] indicate that either mechanism acting singly or in conjunction with the other may produce brain injury. The type of injury produced may differ according to the type of loading. For example, contrecoup (opposite the point of impact) lesions are observed primarily in cases of direct impact when translational accelerations are very high while diffuse brain injuries occur more often as a result of head rotation. From these as well as other types of tests performed on the head, it was concluded that a resultant translational acceleration of 80 g's was a representative head injury tolerance limit.

For the case of direct impact to the head, Melvin [3-9] estimated the skull fracture force level of head impacts with an unpadding flat surface to be in the range of 2.23-9.79 kN (500-2200 lb), depending upon the impact conditions. A small area of impact was consistent with the lower limit, while the upper limit was associated with a large area of impact. Impact to the frontal bone with a flat surface covered by approximately 19 mm (0.75 in.) of padding showed no fractures at forces up to 11.7 kN (2640 lb) in a study by Patrick [3-10]. Nahum [3-11] quotes minimum and average fracture forces of 4.0 and 4.9 kN (900 and 1100 lb), respectively, for impact to the frontal bone with a one-square-inch impactor.

Hodgson [3-12] reported on probably the most significant study with respect to occupant impact with small-diameter surfaces. He impacted cadavers with cylindrical steel unpadding impactors of 8- and 25-mm (5/16- and one-inch) radii and found that the average fracture level was 5.5 kN with a range of 3.1 to 7.7 kN (1250 lb with a range of 700 to 1730 lb).

Head injury criteria, derived from tests of cadavers, animals, and human volunteers, are based upon skull fracture or brain concussion. Cadavers have been used to obtain levels of skull fracture resulting from being subjected to impacts which fall at the short-duration, high-magnitude end of acceleration-time correlations. Lower magnitude, long-duration acceleration-time limits have been obtained used human volunteers. Animals are also used in an attempt to extrapolate human data from tolerable to intolerable acceleration and forces. Analyses of these data over many years led to the formulation of the Wayne State Tolerance Curve for head fracture, a plot of resultant linear head acceleration as a function of pulse duration [3-13]. The Wayne State relationship was used in the derivation of the Head Injury Criterion (HIC), which was later incorporated in Federal Motor Vehicle Safety standard (FMVSS) 208 as the head impact tolerance specification. The HIC is calculated using a weighted measure of the area under the resultant linear acceleration pulse experienced by the head center of gravity (see Table 3-4 in Section 3.3). Its maximum permissible magnitude has been established at 1000 for 50th percentile male dummies, above which severe injury is assumed to occur. The same HIC level is stipulated in current Federal Aviation Administration (FAA) airworthiness standards for the same size dummies and in FMVSS 213 for a 3-year-old child dummy in a child restraint seat.

Numerous additional indices of brain injury have been proposed. A point worth noting is a study by Hodgson [3-14] which concluded that the critical HIC interval must be less than 15 milliseconds (0.015 seconds) in duration in order to pose a concussion hazard. This investigation was based on cadaver, animal, and human volunteer tests of football helmet impacts, airbag tests, and windshield strikes where the direct results of head impact could be determined. Effective accelerations of the heads were measured and correlated with time durations. An analysis of these

data indicated that a concussion almost always occurred during time durations of 15 milliseconds or less. Considerable research with the HIC has been accomplished since then; the critical time duration for head impacts is currently 36 milliseconds or less for the same threshold of 1000.

The HIC was formulated using data obtained from head impacts in the anterior-posterior (i.e., front-back) direction. Very little data has been collected for other impact directions or for angular accelerations. Some lateral impact studies employing cadavers and primates have been reported by Stalnaker [3-15]. They concluded that the threshold of irreversible closed-skull brain injury to humans occurred when the translational head acceleration reached a peak of 76 g's with a pulse duration of 20 milliseconds.

Face

Fracture of the facial bones and laceration of the skin constitutes the two most common types of facial injuries. The principal facial bones generally impacted in a vehicle crash are the mandible (lower jaw), maxilla (upper jaw) and the two zygomas (cheekbones). Fractures of these bones are sensitive to the area of impact and to the hardness of the surface contacted. The minimum fracture force levels defined by Schneider [3-16] and Nahum [3-11] are based upon facial impact by a 25-mm (one-in.) diameter impactor covered with a 2.5-mm (0.1-in.) thick layer of crushable foam. With such a small impactor, the force is concentrated on the bone in question. If the impact is with a large padded surface, the force is distributed over several facial bones and the tolerance level increases dramatically. For example, the minimum fracture level, as reported by Hodgson [3-17] for impact to the zygoma using a 3355-mm² (5.2-square in.) impactor covered with a 25-mm (one-in.) thick urethane pad, was 1.6 kN (360 lb) or almost twice that reported by Schneider. The mandible fracture force level was also considerably higher with the padded impactor.

Fracture of the nose occurs at low force levels. A very soft padding of one inch or more in thickness will protect the nose by permitting the nose to sink into the padding, permitting the major force developed to be transferred to other parts of the face.

Lacerations of the soft facial tissue occur as a result of impact with breakable glass or other sharp surface [3-18]. Facial impact with a very small, hard surface such as a knob produces what appears to be a laceration but is actually a compression or explosion type of injury. Soft tissue injury arising from impact with hard surfaces can also be minimized by the use of adequate padding to distribute impact the force over the surrounding area.

Automotive safety researchers have developed various scales to assess the overall severity of facial lacerations. All such procedures involve covering a head form or an actual dummy head with two layers of moist chamois to represent the two layers of human skin. Following a test exposure (e.g., impact with a windshield or glass surface), the chamois is inspected to determine the number, length and depth of cuts in each layer. One such scale, called The Laceration Index, is delineated in [3-19]. It should be noted, however, that current human injury criteria do not address lacerative injuries to the face or any other part of the body.

Impacts to the face which fracture bones or cause lacerations are not considered life threatening; consequently, tolerance limits have not yet been established for such injuries.

Neck

From the standpoint of accidental injury, the neck does not appear to react to impact in the same manner as other body regions because some low-velocity impacts can produce the same or even higher-severity injuries as high-velocity impacts. Most neck injuries occur as a result of overbending and/or overextension. When the torso is violently accelerated or decelerated, the head is "left behind" until the limit of neck travel is reached. Large, potentially injurious neck forces or deflections are generated during this process. Neck bending can occur in any of the following directions: (1) backward bending, called extension; (2) forward bending, termed flexion, and; (3) sideward bending, called lateral flexion. The center of rotation of the head with respect to the neck is defined to be at the occipital condyles (i.e., upper area of the neck behind the jawbone).

Research performed by Mertz [3-20 and 3-21] has shown that the torque at the occipital condyles is the best measure of injury potential stemming from inertial loading in flexion or extension. In addition to the torque at the occipital condyles from inertial loading, there is a shear and axial load applied at the same points. Experimental results indicate that these loads are well below the voluntary static limit when the torque exceeds the injury limit. Therefore, the shear and axial load under inertial loading conditions are not limiting factors.

During extension of the head and neck during inertial loading (the so-called whiplash syndrome), soft tissue is injured more often than bone. Ligaments, muscles, and complex tissue attachments between the cervical vertebrae are vulnerable to injury. Experimental programs with volunteers and cadavers indicate that there are no injuries until the angle between the head and neck reaches or exceeds a critical value. Consequently, hyperextension and hyperflexion injuries can be avoided by providing a suitable support to keep the head from rotating more than a predetermined amount with respect to the torso. The limiting angle appears to be approximately 80 degrees between the head and the torso relative to the normal head position.

Under conditions producing flexion of the head and neck, the chin strikes the chest in hyperflexion. The external force applied to the chin is not easily measured without modifying the angle through which the head and neck can travel. Therefore, Mertz [3-21] has calculated an equivalent torque in which the force on the chin is assumed to produce a change in the head acceleration equivalent to a given torque at the occipital condyles.

Chest

The human chest (thorax) is a ribbed shell which contains the following important organs: heart, lungs, trachea, esophagus, great blood vessels, and nerves. Thoracic injuries fall into two categories: injuries to the internal organs and injuries to the rib cage. Internal injuries include arterial and ventricular ruptures, aortic ruptures, damage to the electrical conducting system and the cardiac muscle, pneumothorax, hemothorax, pulmonary contusions, and rupture of the bronchi. Actual impact tolerance limits for these organs in humans are not readily found in the literature. However, data for the impact resistance of the rib cage are available. Patrick [3-10] claimed that human tolerance to chest impact is dependent upon the area of contact and reported that approximately 4.5 kN (1000 lb) can cause rib fracture from an impact with a 150-mm (6-in.) diameter padded target. Kroell [3-22] reported about 3.6 kN (800 lb) as the fracture limit with a

150-mm (6-in.) diameter unpadding impactor. Kroell further noted that force is not as good a criterion as chest deflection for indicating injury potential.

Chest impact with a well-padded surface should produce a distributed force which will minimize the danger of rib fractures or other injury from concentrated forces. For automobile collisions, where the chest may impact the steering assembly or dash panel, the current FMVSS 208 resultant acceleration tolerance limit is 60 g's, except for intervals whose cumulative duration is not more than 3 milliseconds.

An additional FMVSS 208 chest impact injury criterion has been recently-established which imposes a 75-mm (3-in.) limit on the deflection of the sternum relative to the spine to limit chest injury to AIS-3. Hybrid III dummies are equipped with instrumentation to measure this deflection under dynamic test conditions.

Abdomen

Blunt (i.e., nonpenetrating) abdominal trauma is a common cause of accidental injury and death, with most of these casualties arising from motor vehicle accidents. The sources of abdominal loading inside an automobile include steering wheel rims, lap belts, armrests, and protruding dash panel components such as knobs and levers. Ejection of vehicle occupants during a crash also frequently produces severe injuries to the abdominal region. The organs most frequently injured in this manner include the liver, kidneys, spleen, pancreas, and intestines.

A large body of clinical literature has evolved over the years that documents the various forms of injuries produced by blunt abdominal trauma. In contrast, there are very little quantitative data available on the loading conditions, force levels and impact velocities that characterize typical accident situations. To date, animal testing has been the prime method for evaluating abdominal injury tolerance. Extrapolation of this data to humans has been tenuous at best but suggests that abdominal penetration is a reasonable first-order measure of human physical trauma to this region. It is postulated that abdominal compression of order 30 to 40 percent is survivable.

Spine

The human body is able to withstand much greater forces when the forces are applied perpendicular to the long axis of the body. A significantly lower tolerance is shown when the forces are applied parallel to the spinal column. A primary reason for this is the susceptibility of the lumbar vertebrae, which must support most of the upper torso load, to compression fracture. Also, the skeletal configuration and mass distribution of the body are such that vertical loads cannot be distributed over as large an area as can loads applied in other directions. These vertical loads, therefore, result in greater stress per unit area on the spine. Finally, along the direction of the long axis, the body configuration allows for greater displacement of the viscera within the body cavity. Forces applied parallel to the long axis of the body place a greater strain on the suspension system of the viscera than do forces applied in the fore-aft direction, thereby increasing the susceptibility of the viscera to injuries. For forces applied toward the head, collinear with the spinal column, the acceleration tolerance level seems to be approximately 20 g's over a maximum 50 millisecond duration [3-23].

Human volunteers have survived uninjured when subjected to accelerations in which restraint belt forces of 8.9 kN (2000 lb) or more have been measured. The results of these tests led to the formulation of the current Federal Aviation Administration criterion for the maximum tensile force in upper torso restraint straps worn by aircraft crewmembers.

Pelvis and Lower Extremities

Fracture of the principal bones of the lower extremities, i.e., pelvis, femur (thigh or upper leg bone), tibia and fibula (the lower leg bones) and patella (the knee cap), constitutes the most common type of lower extremity injury. Axial force data on the patella and femur have been generated as a result of automobile crash protection research involving padded and unpadded impact of the patella [3-24]. As a general observation, it was found that if padding is provided, failure of the femur is the dominant injury mode. Without padding, fracture of the patella may be expected to occur first. In automobile crashes, where there is a good chance of the femurs being loaded axially through contact with the lower dash panels, the current FMVSS 208 injury tolerance level is set at 10 kN (2250 lb). The same criterion is employed in a current applicable FAA airworthiness standard.

Injury studies involving the femur have also provided indirect data on pelvis fracture. It has been established that the femur is more vulnerable to fracture than the pelvis when the pelvis is loaded through the femur. Although the pelvis can sustain considerably higher loads than the femur for this loading direction, an accepted pelvis fracture tolerance level has not yet been established.

Another type of injury to the lower extremities found in rail vehicle and bus accidents is the bending fracture or sprain to the lower limbs from an entrapment of the leg between the floor and the bottom of the seat in front of the occupant. Kramer [3-25] conducted impact pendulum tests on the lower limbs of cadavers at locations from just below the knee to the distal end of the tibia. Measured fracture forces ranged from 1.0 to 5.8 kN (225 to 1300 lb).

Upper Extremities

Injuries to the upper extremities (e.g., the upper and lower arm bones, etc.) are not considered to be of a life-threatening nature. Consequently, relatively little impact research has been conducted with these parts of the body.

3.3 CURRENT HUMAN INJURY CRITERIA

As noted earlier, the human injury criteria (i.e., maximum impact tolerance levels) developed using animal and cadaver test subjects are applied in dynamic experiments using anthropomorphic test devices, also referred to as ATDs or dummies. Selected human injury criteria are currently prescribed by the U.S. Government for use in the experimental evaluation of potential accident survivability for occupants of passenger-carrying motor vehicles and various aircraft. These criteria are delineated in regulations contained in the Code of Federal Regulations (CFR):

- o Title 49, CFR: Part 571, Federal Motor Vehicle Safety Standard (FMVSS) 208, "Occupant Crash Protection"

- o Title 49, CFR: Part 571, FMVSS 213, "Child Restraint Systems, Seat Belt Assemblies, and Anchorages"
- o Title 14, CFR: Parts 23, 25, 27 and 29, Federal Aviation Agency, "Improved Safety Standards"

Table 3-3 summarizes the contents of the injury criteria specified in these safety standards. They prescribe maximum allowable accelerations, forces, and displacements that may be experienced by various instrumented dummy body regions or components in rigorous dynamic test procedures. Four types of dummies are employed in these tests: 50th percentile male Hybrid II and Hybrid III, 3-year-old child and 6-month-old infant. (It should be noted that other sizes and types of dummies, i.e., 5th percentile female, 6-year-old child, 95th percentile male and a variety of side impact dummies exist, but are currently used in developmental, rather than evaluation testing.)

The injury criteria portion of FMVSS 208 is shown in greater detail in Table 3-4. This standard pertains to the outboard-position front-seat occupants of automobiles, multipurpose passenger vehicles and light trucks with a 4536 kg (10,000 lb) maximum gross vehicle weight rating, and drivers of small buses. Injury criteria contained in the FAA regulations are defined for the occupants of small airplanes, transport category airplanes, and normal and transport category rotorcraft. FMVSS 213 specifies requirements for motor vehicle and aircraft occupants using child restraint systems.

It should be noted that there are no standards or regulations which stipulate injury criteria specifications for the occupants of any type of vehicle that occurs on North American or foreign mass transit or intercity passenger train consists.

3.4 FUTURE HUMAN INJURY CRITERIA RESEARCH EFFORTS

It is evident from the discussions in Section 3.2 and the content of Table 3-3 that current human injury criteria define the onset of serious impact-related injuries to specific body regions in an extremely crude fashion. For example, it was pointed out that the HIC evolved primarily from data obtained from drop tests of cadaver heads onto rigid and padded surfaces. As such, post-test examination of the head could reveal only the occurrence of skull fracture and gross physical brain damage. Without a living subject it is impossible to determine the occurrence of other possible problems such as paralysis or memory loss stemming from neurological damage. Such shortcomings have led many researchers to question the validity of the HIC as a comprehensive indicator of impulse-induced head injury. Questions also have been raised whether the HIC is applicable to head accelerations which occur without impact. The 75-mm (three-in.) chest displacement limit is similarly open to question. Such a single-point measurement of chest compression is not a representative indicator of the overall chest deformation profile and hence, the potential for thoracic injury.

**Table 3-3
Current Human Injury Criteria Employed in Transport Vehicle Crash Safety Standards and Regulations**

Body Region or Component	Parameter(s) Recorded	Measurement Device	Dummy Types	Injury Criterion	Current Standard or Regulation
Head	Three translational components of acceleration at the center of gravity	Accelerometer	Hybrid II and Hybrid III; ³ 3-year-old child in child restraint	HIC \leq 1000	FMVSS 208 and 213; 14 CFR: FAR Parts 23, 25, 27 and 29
	Horizontal displacement	High-speed movie film	3-year-old child in child restraint seat	\leq 32 inches relative to vehicle seat back pivot point	FMVSS 213
	Displacement of center of gravity	High-speed movie film	6-month-old infant in infant carrier seat	Cannot rise above top of carrier seat back	FMVSS 213
Chest	Three translational components of acceleration at the center of gravity	Accelerometer	Hybrid II and Hybrid III; 3-year-old child in child restraint seat	\leq 60 g's for 3 millisecond maximum duration	FMVSS 208 and 213
	Compressive displacement of the sternum plate relative to the spine	Potentiometer	Hybrid III	\leq 3 inches	FMVSS 208
	Angle of infant carrier back rest relative to the vertical	High-speed movie film	6-month-old infant in infant carrier	\leq 70 degrees	FMVSS 213
Spine	Compressive axial force	Load cell	Hybrid II	\leq 1500 pounds	14 CFR: FAR Parts 23, 25, 27 and 29
	Tensile force in upper torso restraint strap(s) (crewmembers only)	Load cell (on belt)	Hybrid II	\leq 1750 pounds for a single strap restraint; < 2000 pounds total for a dual strap restraint	14 CFR: FAR Parts 23, 25, 27 and 29
Femur	Compressive axial force	Load cell	Hybrid II and Hybrid III ³	\leq 2250 pounds	FMVSS 208 and 14 CFR: Part 25
Knee	Horizontal displacement	High-speed movie film	3-year-old-child in child restraint seat	\leq 36 inches relative to vehicle seat back pivot point	FMVSS 213

Notes:

(1) FMVSS: Federal Motor Vehicle Safety Standards are defined in Title 49, Code of Federal Regulations: Part 571

(2) FAR: Federal Aviation Administration Regulations are defined in Title 14, Code of Federal Regulations

(3) Hybrid III dummies are not utilized in FAR evaluation tests

(4) Metric conversions: 1 inch = 25.4mm 1 lbf = 4.45N

**Table 3-4
FMVSS 208 Occupant Injury Criteria**

General: All portions of the test dummy shall be contained within the outer surfaces of the vehicle occupant compartment throughout the test			
Body Region	Dummy Type		Requirement
	Hybrid II	Hybrid III	
Head	X	X	<p>The resultant acceleration at the center of gravity of the head shall be such that the expression (the Head Injury Criterion, HIC):</p> $\left[\frac{1}{t_2 - t_1} \int_{t_1}^{t_2} a dt \right]^{2.5} (t_2 - t_1)$ <p>shall not exceed 1,000, where a is the resultant translational acceleration expressed as a multiple of g (the acceleration of gravity), and t₁ and t₂ are any two points in time during the crash of the vehicle which are separated by not more than a 36 millisecond time interval and which maximizes the integral</p>
Chest (Thorax)	X	X	<p>The resultant acceleration at the center of gravity of the upper thorax shall not exceed 60 g's, except for intervals whose cumulative duration is not more than 3 milliseconds</p>
Upper Leg (Femur)	X	X	<p>Compression deflection of the sternum relative to the spine shall not exceed 3 inches</p> <p>The compressive force transmitted axially through each upper leg shall not exceed 2,250 pounds</p>

Note: Metric Conversion

1 inch = 25.4mm

1 lbf = 4.45N

These concerns and others related to the other current injury criteria indicate that much additional research is needed in order to quantify human injury tolerances to impact loading in more specific terms. In this regard, attempts have been made to modify and expand the content of FMVSS 208 based on biomechanical data obtained in earlier and more recent research (see, e.g., [3-3]). However, such proposed changes have not yet been adopted.

Concerns also exist regarding the biofidelity (i.e., human-like response) of the dummies used to predict human injury in the various types of experiments conducted to simulate real-world vehicle collisions. These devices generally provide repeatable kinematics and injury indicator measurements in replicate test exposures. However, the motion undergone by an inherently less flexible dummy would most likely differ from that experienced by a living person of the same

size and weight in the same dynamic environment. Questions also exist relative to the correlation of dummy injury indicator measurements to corresponding human responses for the same impact exposure. For example, if the accelerometers mounted in the dummy chest cavity indicate a 50 g resultant acceleration in a crash test, would the human counterpart subjected to the same impact conditions also experience the same acceleration level?

In anticipation of future enhanced and more comprehensive human injury criteria, various organizations are attempting to develop more biofidelic and impact-sensitive dummies. The current Hybrid III dummy will eventually have the **potential** to measure 31 separate responses, compared to the maximum eight-response capability of its predecessor, the Hybrid II.² However, this dummy (as well as all other current-generation dummies now in use) was designed to measure the magnitude of mechanical responses which simulate the occurrence of anatomical injuries sustained in vehicle frontal-mode impacts only. Ideally, a multidirectional dummy (i.e., one sensitive to more than one direction of impact) should be developed.³ The use of such a dummy in impact-related tests would provide better estimates of occupant injury for other vehicular crash modes.

The above-noted ongoing research has resulted in the development of several new dummies designed expressly for use in motor vehicle side impact tests. One of these will be specified as part of the test procedure in the National Highway Traffic Safety Administration's planned upgraded side impact performance standard for selected motor vehicles (see Section 5.1.2).

²Current FMVSS 208 injury criteria measurements made with a Hybrid III dummy utilize nine data channels: three head accelerations, three chest accelerations, two femur loads and a chest displacement. Instrumentation is available to measure neck forces and moments, lower leg forces and knee shear forces.

³Such an endeavor would require the development of an extensive impact biomechanical research database to prescribe dummy mechanical response parameters which simulate comparable multidirectional human body region impact response.

4. VEHICLE CRASHWORTHINESS EVALUATION TECHNIQUES

It was noted in Chapter 2 that a crashworthy vehicle should provide adequate crash protection for its occupants against the effects of both the primary and secondary collisions that occur in crash-related accidents. A sound evaluation of vehicle crashworthiness must therefore be capable of assessing the performance of the vehicle structure with respect to its integrity and kinetic energy management as well as the effectiveness of the interior of the occupant compartment in mitigating the effects of potentially hazardous contacts within this protective container.

Two different approaches are currently employed by vehicle safety researchers to ascertain vehicle crashworthiness for development or evaluation purposes: experiment and analysis. It is conceivable that much of the technology and techniques utilized for this purpose could be applied to the determination of HSGGT vehicle crash safety performance. The two approaches are reviewed in Sections 4.1 and 4.2, respectively.

4.1 EXPERIMENTAL TECHNIQUES

A vehicle crash constitutes a severe dynamic loading environment displaying many different possible complex interactions between structural and inertial forces and vehicle occupant response. One way to assess the crashworthiness of a transport vehicle is to test it in a simulated impact environment. In this approach, the entire vehicle or some representative part of it is subjected to a dynamic loading condition which attempts to simulate, to the extent feasible, the initial impact conditions and subsequent vehicle response which occurs in a real-world crash exposure. This general approach encompasses three different techniques: full-scale crash, sled, and component testing. Each technique will be discussed in a separate subsection.

4.1.1 Full-Scale Crash Testing

In full-scale crash testing, a complete vehicle, heavily instrumented with electronic sensors (e.g., accelerometers, load cells, displacement potentiometers) and containing instrumented anthropomorphic dummies protected by the vehicle's standard or developmental-type restraint system, is towed or propelled along an approach lane and then released just prior to impacting another vehicle, object, structure or ground feature. High-speed movies of the crash are taken by a large number of motion picture cameras strategically placed to record various views of the reaction of the vehicle and dummies to the impact for later analyses and correlation of significant physical events with perturbations shown on plots of recorded electronic data. The capability to conduct such tests requires a large capital investment in the form of a test facility and all necessary equipment as well as experienced engineering and technical personnel to set up and perform the tests and to interpret the data generated.

With suitable instrumentation and high-speed motion picture coverage, a typical full-scale crash test executed by a highly-trained, experienced team of specialists can provide a wealth of valuable information regarding the performance of the vehicle and the response of its occupants to a given impact condition. As an example of this knowledge, the information commonly recorded, generated, compiled and documented in a typical automobile crash test includes but is not limited to:

- o values of occupant injury indicator parameters
- o slow-motion action of occupant kinematics, interaction with the restraint system, possible contacts with the vehicle interior and/or other intruding objects
- o time histories of occupant belt restraint forces (and airbag pressure, if applicable)
- o the vehicle crash pulse and other vehicle acceleration-time histories of interest
- o restraint system deployment and effectiveness
- o time histories of the vehicle compartment velocity and dynamic displacement (via first and second time integrations of compartment acceleration component data, respectively)
- o comparative time histories of vehicle dynamic displacement from high-speed film analysis
- o a mapping of compressive force-time histories recorded at the crash interface (barrier test only)
- o slow-motion action of vehicle exterior collapse and intrusion/penetration of compartment interior surfaces
- o a mapping of vehicle residual exterior crush and compartment intrusion via comparison of corresponding pre- and post-test measurements
- o comparative pre- and post-test still photographs of the vehicle and its occupants

Other test-specific information such as automobile steering system and dash panel dynamic displacements, windshield retention, vehicle kinematics in non-flat barrier tests, deformable struck object integrity and deformation, etc., can also be obtained by means of full-scale vehicle crash testing.

Formulation of a full-scale crash test matrix for the crashworthiness of a vehicle is predicated on both economic and practical considerations. Because such a procedure is extremely labor intensive and prototype or production vehicles of all kinds are expensive, it would be prohibitively costly to attempt to assess occupant accident survivability for even a few of the many possible serious accident scenarios using this technique exclusively. Consequently, various compromises must be made, both with respect to the selection and idealization of the real-world crash configurations considered for such evaluation, and in the actual number of tests performed.¹ An example of such a compromise is presented below. It is drawn from the automotive/light truck industry, which developed the various experimental test methodologies

¹Replicate tests should also be factored into the test matrix to average out the effects of inherent test data scatter present in all experimental test procedures. Cost considerations, however, usually limit full-scale evaluation crash testing of vehicles to a single exposure for a given collision configuration.

discussed in this section and which remains the pacesetter in vehicle crashworthiness development and evaluation work.

Automobile collisions occur with a variety of obstacles over a wide range of impact speeds and directions. In the mid-1960s automobile accident statistics were examined by researchers in an effort to determine which types of accidents presented the greatest injury hazard to automobile occupants. It was determined that the greatest likelihood of serious injury or death occurred in frontal impacts, where the conversion of kinetic energy to mechanical working of the vehicle structure was high and where minimal kinetic energy was dissipated by other means (e.g., frictional effects during vehicle displacement). This broad spectrum of accidents still represents roughly one half of all fatal motor vehicle accidents that occur in the U.S.

In response to this study, the U.S. Government, under the auspices of the Department of Transportation, National Highway Traffic Safety Administration (NHTSA), delineated in 1967 a formal test procedure to evaluate automobile compliance with (among other requirements) government-mandated occupant injury criteria. Embodied in Federal Motor Vehicle Safety Standard (FMVSS) 208, this evaluation is currently carried out by means of one or more full-scale crash tests of a production vehicle equipped with two instrumented, restrained dummies on the front seat. The specific type of tests(s) performed is keyed to the type of occupant restraint system installed in the vehicle at the driver and right-front passenger seating positions. In virtually all cases, this test consists of a nominal 48 km/h (30 mph), 90-degree frontal impact of the vehicle into a flat, rigid barrier.

Other full-scale crash tests which do not use dummies are also included in the current Federal Motor Vehicle Safety Standards. These tests are described in Chapter 5.

4.1.2 Sled Testing

Sled testing is an experimental technique that can be employed to simulate a crash test without actually damaging a vehicle. Sled tests are routinely performed by motor vehicle manufacturers and independent research and development firms for various reasons, including the development and evaluation of restraint systems, steering wheel/column assemblies, dash panel assemblies, surface padding, etc. This technique is also used in the development and Federal compliance assessment of aircraft seats and child restraint systems.

For most tests, only the framework of the vehicle structure surrounding the occupant compartment is used. It is first suitably reinforced and then mounted on the sled carriage. Inside this stiffened framework (commonly referred to as a body buck), all interior systems pertinent to the test being run are installed in their normal position (e.g., seats, dash panels, windshield, padding, etc. in an automobile). Fully instrumented dummies are placed in their respective positions and belt restraint systems (if used) fastened in place. High-speed movie cameras are set up to view all phases of the dummy motion as well as other compartment interior systems of interest. Other instrumentation is installed as deemed appropriate to the test (e.g., dynamic displacement transducers attached to the dummy pelvis, occupant/interior contact indicator switches and load cells between the seat frame and the floorpan).

The entire sled assembly (i.e., the carriage and the buck) is constrained to travel along a straight and level track. In a typical HYGE sled facility, a high-pressure gas mixture drives the sled according to a predetermined, repeatable acceleration-time program controlled by a metering pin located in the thrust column. Each metering pin is custom designed to produce a best-fit acceleration pulse which simulates a specific vehicle crash pulse. Various pulse characteristics can also be modified somewhat by varying the thrust column gas pressures and volume settings. Information obtained from a sled test is similar in many respects to the dummy response results collected in a corresponding full-scale crash exposure. Thus sled testing can provide an indication of occupant compliance with injury criteria as well as occupant kinematics and possible contacts within the compartment, restraint system loadings and effectiveness, etc. There are, however, notable differences between the two techniques.

Sled testing is more cost-efficient than full-scale crash testing because the body buck can be used repeatedly provided that it is inspected periodically to determine if permanent structural deformation has occurred and, if so, the body buck strengthened to prevent further distortion. Only the compartment interior systems affected by the test need be replaced prior to running subsequent tests. Depending on the number of such systems that have to be replaced, it is possible to perform two or more such tests per eight-hour work day.

The major disadvantage of sled testing relative to crash testing is that the buck cannot undergo the actual vehicle kinematics and sustain the possible occupant compartment intrusion experienced during the latter simulation. For example, the effects of motor vehicle pitch (i.e., a rotation about an axis perpendicular to the vehicle longitudinal-vertical plane) which occurs in a frontal crash test exposure cannot be instantaneously accounted for in a sled test simulation. Similarly, the progressive crush of the motor vehicle firewall in the same type of test cannot be duplicated. Such factors can significantly influence dummy kinematics and injury indicator measurements.

Researchers have attempted to compensate for these shortcomings by incorporating the end-result of some of these dynamic physical effects into the sled test methodology. Thus, if a vehicle exhibits substantial pitch during a full-scale crash test, the buck itself can be mounted in an inclined position for sled testing. For the case where significant firewall intrusion occurs, the dash panel can be moved inward, rendering the available occupant stroking distance more comparable to what it becomes during a crash test.

Other compartment deformations, however, are not amenable to such simulation. One example is the buckling of the floor pan (with possible consequent displacement and/or deformation of the seat) during an actual vehicle collision. Another is the movement of the belt restraint system anchorage locations caused by floorpan buckling and/or pillar/header distortion.

Despite its limitations, a comprehensive sled test program is a practical, relatively low-cost alternative to a similarly extensive, prohibitively expensive full-scale crash test effort.

4.1.3 Component Testing

Component testing is employed in the crashworthiness development or evaluation of specific vehicle components, systems, or sections of a complete vehicle. Corresponding examples for an

automobile would be the front structure rail, the steering system assembly (i.e., steering wheel, steering column, and attachment hardware) and the A-pillar/roof header portion of the vehicle occupant compartment, respectively. In general, component tests are generally relatively inexpensive to perform because they evaluate specific parts of a vehicle and hence require less equipment, preparation time, and manpower. However, some test procedures can be considerably more costly than others.

In the motor vehicle safety community, performance evaluation with this approach is strictly controlled by test procedures delineated in the Federal Motor Vehicle Safety Standards. These procedures require that special purpose test equipment (i.e., an impactor built to strict performance specifications) be utilized and the system under evaluation remain in place on (or at least on some representative portion of) the vehicle. In the developmental testing, those same systems could be removed from the vehicle, mounted on a general test fixture and tested using a device capable of delivering an equivalent dynamic loading. The reliability of the data obtained in the latter type tests is highly dependent on how well the physical boundary conditions (i.e., attachment to the test fixture) of the test specimen approximate those of its in situ installation. Failure to properly install a test specimen in an appropriate manner could significantly compromise the value of such data.

There are two general types of component testing: static and dynamic. When applied to a complete vehicle, an appropriately sized portion of a vehicle, or a properly installed off-vehicle setup, component testing can provide valuable crashworthiness-related developmental and evaluation data for specific components or regions of a vehicle. Motor vehicle applications of such testing are presented for each of the four types of techniques outlined below.

Static Crush and Tensile Test Devices

Static crush test devices (i.e., static crushers) are slow-speed, hydraulically controlled presses which can exert a quasi-static compressive force on a properly fixtured test specimen and crush it into the plastic range of deformation. The hydraulic load actuators used to apply the force range in size and loading capacity from a small, single cylinder which can apply up to 50 kN (10,000 lb) of force to vehicle components or assemblies, to extremely large cylinders capable of applying (when more than one are used in parallel) nearly 5MN (one million lb) of force and crushing an entire rail vehicle underframe structure. Certain static crush test apparatus can also be operated in the tensile mode (i.e., they can pull on, rather than compress, a test specimen).

In addition to their use in FMVSS compliance test evaluations, such devices are usually employed to develop uniaxial force-displacement data corresponding to compressive-type loadings. Force and corresponding displacement parameters are normally recorded by means of load cells and potentiometers, respectively, located at the regions of interest on the article being tested. Other data output usually consists of video and/or sequential still photographic coverage of the crush process and a written log documenting noteworthy observations (e.g., structural member collapse sequence or failure mode) made during the test.

Force-displacement data developed using this approach is particularly suitable for use as input data to certain analytical techniques described in Section 4.2. For such applications it is

imperative that the test article be installed in the test rig such that its static collapse mode duplicates, to the extent feasible, the actual collapse mode observed in the corresponding dynamic test exposure.

Dynamic Linear Impactor

A dynamic linear impactor is basically a gas-powered "gun" which propels a guided or free-flight mass into a test surface at a prescribed impact velocity. One such evaluation application of an impactor is in FMVSS 201, which specifies cushioning requirements for compartment interior surfaces frequently struck by occupants during a crash. Its overall objective is to provide the friendly interior surfaces mentioned in Section 2.2.2. In one such test, the front seat(s) and the doors on one side of a vehicle are removed and the firing mechanism of the impactor apparatus inserted in the occupant compartment. A head body form is attached to the end of the movable piston in the mechanism and positioned to strike a specified area on the dash panel. The body form is propelled into the dash panel at a designated velocity and its resultant acceleration-time response recorded by a triaxial acceleration package mounted on the back side of the body form. Peak acceleration pulse magnitude and duration measured in the test must satisfy criteria stipulated by FMVSS 201.

A dynamic linear impactor is also used to perform a similar vehicle system evaluation test described in FMVSS 203. In this test, the vehicle is severed laterally through the floorpan and upper A-pillar. The front portion of the dissected vehicle is then secured to a fixture and the firing mechanism of the impactor positioned such that its longitudinal axis is collinear with that of the steering column. A torso body form instrumented with a triaxial accelerometer package on its back side is oriented according to test specifications and secured to the end of the impactor piston. The body form is propelled into the steering wheel at a prescribed velocity; dynamic measures of the column force and axial stroke are recorded by a triaxial load cell and potentiometer, respectively. FMVSS 203 requires that the measured resultant column force and body form resultant acceleration meet specified criteria.

The usefulness of this experimental technique is limited by the weight and dimensions of the accelerated mass used in a test. Maximum impact velocity attainable can drop off substantially for a particularly heavy test form, e.g., an actual Hybrid II or Hybrid III dummy pelvic/torso assembly.

Drop Tower

This technique uses a rigid striking mass that falls along a vertical guideway and impacts the test article. Body forms or other contoured masses are usually attached to the lower surface of this mass. The tested article is mounted horizontally or at some angle on a fixture attached to the floor. Force, deflection, and acceleration profiles can be electronically recorded and the event action recorded on high-speed film. Tower drop height restrictions limit the magnitude of the maximum impact velocity that can be obtained to $\sqrt{2gh}$, where h is the drop height and g is the acceleration due to gravity.

Pendulum

This technique features a rigid striking mass that swings in a circular arc relative to a pivot point on the test apparatus support structure. The test article is mounted vertically on a fixture attached to the floor and is struck by the rigid mass itself or by some other object attached in front of this mass. As is the case with the drop tower, accelerations, forces and displacements can be recorded and the impact captured on film by high-speed motion picture cameras. Maximum pendulum

mass impact velocity is also limited to $\sqrt{2gh}$.

In addition to developmental-type test applications, pendulum test facilities are also employed to evaluate automobile bumper compliance with the requirements mandated in 49 CFR: Part 581.

4.2 ANALYSIS TECHNIQUES

It was noted in Section 4.1 that total reliance on the full-scale crash testing approach to vehicle crash safety performance evaluation would be a prohibitively expensive proposition if it were to be employed to simulate more than a small representative number of possible real-world accident exposures. The use of one such test configuration--the FMVSS 208 frontal flat barrier crash test--as the representative crash exposure for motor vehicle occupants was cited as an attempt to reach some practical compromise to this situation. Clearly, a mathematical model that could predict vehicle and occupant response to impact would be a very useful tool for performing vehicle crash safety performance evaluation. Ideally, such modeling would not be restricted to a limited number of impact configurations but would encompass a broad spectrum of the real-world vehicle collision threat.

In the strict sense of the term, analytical techniques are contained in some transport vehicle crashworthiness evaluation criteria. However, they focus on specific portions of the vehicle structure, involve the use of static structural analysis and fail to address occupant response to impact. (The nature of such current rules, regulations, standards, and industry practice will be reviewed in Chapter 5.) Suffice it to say that no dynamic analysis capable of predicting vehicle and occupant response to impulsive loading is currently employed to assess **formal compliance** with government- or industry-mandated vehicle safety performance standards and regulations.

Such computer codes do exist, however, and are applied by many diverse groups and organizations, e.g., the motor vehicle and aerospace industries, independent research and development firms, and researchers in universities, government agencies, and private consulting firms. The applications of these analyses are similarly varied. They include but are not limited to: (1) development of new vehicle design concepts, (2) use as an exploratory tool to examine the effects of systematic vehicle structure and restraint system design changes on predicted occupant survivability performance, (3) computer code development, (4) accident reconstruction, and (5) accident litigation cases.

The above-noted work is carried out with many different computer codes reflecting different generic approaches of varying levels of sophistication to vehicle crash and occupant response

detail. For the sake of brevity, only those codes which have been applied or show potential for application to the various aspects of train crashworthiness modeling are surveyed in this report.

A realistic simulation of a train collision must be capable of modeling the following physical events:

- o consist kinematics
- o the primary collision
- o the secondary collision

Each of these events is briefly discussed below.

Consist Kinematics

A train is a multilinked system of vehicles, each with its own stiffness and collapse characteristics for the various impulsive loadings it may be subjected to in any given accident scenario. The trajectory and failure/collapse mechanism exhibited by each vehicle in the consist will affect adjacent vehicles to various degrees, depending on train impact speed, collision mode, vehicle location in the consist relative to the impact interface, etc. An analysis which attempts to simulate consist response to the collision should be capable of describing the trajectory of each vehicle in the consist during the entire series of possible crash events which can occur during the accident. It should also be able to realistically model the type of connection used between vehicles in the consist.

In such analyses, each vehicle is idealized as a rigid body for the purpose of tracking its motion, with knowledge of the major vehicle mass concentrations, vehicle moment of inertia components, and nature of the constraints provided by the connection between vehicles being essential ingredients for a viable analysis. Although ordinarily not a consideration of kinematics in the pure sense of the term, the effects of vehicle crush as two adjacent coaches interact as well as frictional effects between the vehicles and the roadbed must be factored into this analysis. This phase of the analysis should be able to detect the occurrence of jackknifing, rollover and the full complement of possible crush/override mechanisms: crush without override, override and crush of the weaker vehicle, or crush with subsequent override of the weaker vehicle.

Primary Collision

The analysis of vehicle structural response resulting from crash loading is an extremely complex and challenging task. All vehicle structures, regardless of transportation mode, are an assemblage of beams, columns, shells, plates, corrugated panels and irregular bars, some of which contain holes, cutouts and beads (i.e., localized raised or depressed regions in the surface area). Dynamic elastic-plastic analysis of such a configuration is further complicated by the existence of material

and geometric nonlinearities resulting from large structural deformation.⁽²⁾ Experimental evidence has shown that the material yield strength of structural metals such as mild steel varies with the rate at which load is applied. Failure to include this nonlinear material behavior in the impact analysis of a vehicle containing such structural elements may lead to unrealistic predictions. The yield strength of mild steel (which is widely used in the automotive, truck and bus industries), and hence its energy dissipation capacity, increases significantly at high strain rates.

Other nonlinear effects inherent in vehicle crash analysis include structural element failures such as buckling and fracture as well as contacts between deformable structural members or between such members and essentially rigid masses attached to the structure.

A computer simulation of train primary impact response should be capable of providing the following minimum, basic information:

- o The vehicle compartment acceleration-time history at one or more locations. This profile is essential input to occupant dynamic analyses used in secondary collision modeling.
- o Vehicle structure collapse configuration, including maximum dynamic crush sustained by the occupant compartment.
- o Force and displacement components as a function of time for various regions of the structure.
- o Indications of loss of compartment structural integrity, e.g., as in the occurrence of override.

Some of these predictions may be obtained with models configured with relatively simple analyses requiring a few inputs such as total vehicle weight and the estimated overall vehicle axial force-deflection characteristics. Output from such computer codes will provide only gross, order-of-magnitude vehicle responses to impact. Other responses may be obtained only with models configured with highly sophisticated analyses requiring intensive labor effort and/or mainframe computer running time. In either situation, the usefulness of the predictions generated by a given analysis will be measured by the extent to which the analysis can adequately model the actual vehicle structure and the availability and reliability of critical input parameters such as the geometry of the vehicle structural configuration, as well as vehicle system strength, mass, and inertial properties.

Secondary Collision

Mathematical modeling of occupant response during the crash of any type of vehicle is, like simulation of the crash event itself, an extremely complex problem. Such simulations must provide estimates of occupant kinematics and subsequent interior impact response within a

²Material nonlinearity refers to that portion of its stress-strain curve where stress is no longer proportional to strain, resulting in the occurrence of plastic (permanent) deformation. Geometric nonlinearity is that condition in which the magnitude of the deformation sustained by the structure alters the action of the applied loads or the reactions to them, precluding use of the original, undistorted structure geometry in the analysis.

collapsing compartment whose crash pulse reflects the overall rigid body motion of the vehicle and the energy management characteristics of the vehicle structure.

Required inputs to an occupant dynamics model must include the vehicle compartment structural collapse and acceleration-time histories, compartment interior geometry and force-deflection properties, and (if employed) restraint system parameters such as belt configuration, anchor point locations and belt force-deflection characteristics. The accuracy to which these inputs can be specified is especially critical for train occupant crash response simulation because of the wide variety of occupant seating positions (e.g., forward facing, rearward facing, sideward facing and face-to-face), posture assumed in the seat or in a standing or walking configuration (e.g., with or without the assistance of a handhold or stanchion) and compartment interior surfaces (e.g., virtually any part of a seat [including cushionless framework], panels, stanchions, loose baggage or equipment and other occupants) which may be struck during the accident.

4.2.1 Train Consist Kinematic and Individual Vehicle Crash Analyses

Four different generic approaches can be employed to analyze train consist kinematics or vehicle structure response to crash loading (i.e., the primary collision):

- o lumped-mass analysis
- o finite element analysis
- o hybrid analysis
- o ultimate load analysis

It is also possible to combine some of these approaches in the overall analysis of a train collision. This concept is discussed later in this subsection.

Each of these techniques will be briefly described below and available computer codes utilizing these techniques cited. Unless otherwise stated, none of the rail vehicle-related simulations described in the remainder of this section were validated by comparing the predicted results with those obtained in a corresponding full-scale crash test.

Computer codes formulated to simulate occupant/compartment interior impact (i.e., the secondary collision) are surveyed in Section 4.2.2.

Lumped-Mass Analysis

Lumped mass analyses (LMA) model a vehicle as a series of concentrated, rigid masses connected by massless, deformable, nonlinear uniaxial resistances (i.e., springs). Dashpots may also be used in some analyses to simulate structural damping behavior. Most computer codes formulated with this approach feature a variable number of masses, springs and dampers, enabling the user to assemble a model which best represents the subject structural system. LMA

is extensively employed in the motor vehicle industry to simulate flat frontal barrier impacts, front-to-front and front-to-rear collinear, and front-to-side perpendicular intervehicular collisions.

LMA input consists of the initial impact speeds of the concentrated masses as well as the nonlinear force-deflection characteristics of vehicle components or assemblies in those regions which undergo large structural deformation. In road vehicle applications, force-deflection data are obtained by static crush testing individual vehicle components or assemblies installed in a test rig in such a manner that the static collapse mode duplicates, to the extent feasible, the actual collapse mode in a corresponding full-scale crash test. A separate structural analysis may also be performed to generate this data. When static crush test data are used, dynamic strain rate effects are grossly approximated by application of experimentally determined magnification factors.

Essentially noncrushable vehicle components are represented by lumped masses. For example, in an automobile frontal impact situation, typical systems idealized in this manner are the engine, transmission, suspension, and tire/wheel system; stiff frame crossmember(s); and the occupant compartment rearward of the firewall. Major crushable vehicle structural components/assemblies such as the longitudinal frame members, front sheet metal (or "isolated" portions of a unibody vehicle), firewall, engine mounts, bumper, and radiator are idealized as equivalent uniaxial resistances.

Output from a typical one-dimensional **LMA** computer code for a road vehicle impact simulation consists of a graphical and/or tabulated time history of the acceleration, velocity and displacement of each mass and the force- and displacement-time histories of each resistive element. The most useful part of the output generally consists of the occupant compartment acceleration characteristics and the overall vehicle maximum dynamic crush. The compartment acceleration-time data can be used as input to an occupant dynamics analysis to predict vehicle occupant response to a given collision scenario.

In road vehicle applications, **LMA**-configured vehicle models are "tuned" by adjusting various input parameters to provide satisfactory correlation between selected simulation predictions and corresponding full-scale crash test results. Such adjustments often exhibit no real-world rationale for their use other than the fact that good agreement is obtained by doing so. Indeed, "input-adjusted" models generally do not provide the same predictive capability when the model is exercised in a slightly different collision mode or even in the same mode at highly different impact speeds.

LMA constitutes a very useful tool currently in use by manufacturers of automobiles, multipurpose passenger vehicles, light trucks and buses. Its principal advantage is that its computational simplicity allows the analyst to run and interpret the results of many simulations using a personal computer. Parametric studies involving the primary properties of the vehicle can thus be easily performed and quickly give the design engineer physical insight into various aspects of gross, relative vehicle dynamic response at relatively little expense. For example, the model can be used to explore compartment crash pulse response trends by systematically varying certain inputs in its design, e.g., frame rail or lower integrated sheet metal/rail crush characteristics. This allows the design team to focus its efforts in the proper direction, helping to

reduce the size of the full-scale crash test matrix and perhaps limiting the scope of detailed structural analyses needed to obtain the desired crashworthy vehicle performance.

Predicted results obtained from road vehicle simulations of full-scale crash tests with the **LMA** approach have generally provided satisfactory correlation with corresponding compartment crash pulse and total vehicle dynamic crush experimental data. The degree of correlation is often a function of the particular vehicle structure under consideration. This agreement is highly dependent upon the manner in which the model is configured (i.e., the way in which the vehicle is idealized as a series of concentrated masses, nonlinear springs and [if used] dashpots), selection of strain rate magnification factors, and the crush test methodology employed to generate the static force-deflection data. The last factor is an especially critical and influential aspect of the technique. It is well known that the correspondence of the regional crush characteristics indicated by the data so generated relative to the actual force-deflection response experienced by the structure in an impact environment reflects the fixturing techniques employed on the static crush machine to isolate the selected "spring" elements from the designated mass concentrations and from each other. Moreover, the removal and relocation of test bed reaction structure during progressive vehicle crush is a highly subjective decision that can have a large effect on simulation results. In summary, the accuracy of an LMA simulation is primarily a matter of experience and judicious engineering judgment in both modeling the vehicle and in performing static crush testing.

LMA use in the road vehicle industry is beset with numerous deficiencies: (1) its use is essentially limited to existing vehicle configurations from which uniaxial force-deflection inputs can be obtained experimentally; (2) it relies on often expensive full-scale crush testing for force-deflection input data; (3) somewhat arbitrary dynamic amplification factors are used; and (4) localized structural deformation cannot be predicted. With respect to item 4, it should be noted that it is possible to relate LMA force-deflection data to certain regions of a road vehicle structure (e.g., lower-left front sheet metal/rail). However, specific components comprising the structural assembly in that region (e.g., the lower-left sheet metal alone) cannot generally be isolated as a separate input item to a given code.

Because of the relatively large curve radii encountered on main intercity guideway lines, virtually all train-to-train collisions can be regarded as one-dimensional impacts. One-dimensional **LMAs** have accordingly been employed to simulate such impact configurations. Calspan developed an early **LMA** computer code which provided gross estimates of crush and crash pulse of each vehicle in a consist subjected to a collinear impact condition [4-1]. Boeing Vertol also used their own, similar analysis to generate rail car crash pulse inputs for use in the design of compartment interior energy absorption provisions for occupant protection [4-2] and as part of a comprehensive analysis of locomotive impact with a caboose [4-3].

A two-dimensional **LMA** computer code, with vehicle motion restricted to the longitudinal-vertical vehicle plane (i.e., the vertical plane containing the track), was developed by Pullman-Standard to study car body pitching and vertical bounce and coupler slippage in consists of colliding rail vehicles [4-4]. This analysis, however, is restricted to linear elastic structural response, rendering it unsuitable for prediction of the onset of override.

Another unnamed **LMA** computer program, described in [4-3], was developed in an effort to provide insight into the vertical and pitching response of a lighter rail vehicle (e.g., a freight car) struck by a much heavier rail vehicle (e.g., a locomotive). This simplified, three degree-of-freedom analysis represents the less massive vehicle as a rigid body connected by springs to its trucks. The heavier vehicle is idealized as a horizontal spring that acts through the underframe. Because of the many simplifying assumptions made in this analysis, it is valid only for the time of initial contact between the colliding vehicles. The code therefore appears to have negligible value for use in the prediction of rail vehicle override.

Unfortunately, there is no static crush database for rail vehicles that could be used as source of input to existing one-dimensional **LMAs**. The analyst interested in studying the gross, relative effects of rail vehicle structural changes on overall vehicle crush and crash pulse can, however, use other approaches to obtain the required vehicle force-deflection input data. Estimates may be obtained from a detailed finite element analysis of the crushable structure, an analytical estimate (based on, for example, calculated static plastic collapse loads for the elements constituting the structural configuration of interest), or, as a last resort, an educated guess. Regardless of how this data is obtained (static crush data would be preferable), **LMA** can provide relative-trend, first-approximation simulations of rail vehicle primary collisions for collinear impact configurations.

Finite Element Analysis

The second approach to vehicle crash simulation involves the use of the finite element analysis (**FEA**) method. The vehicle structure under consideration is idealized as a grid or mesh of simple element configurations (e.g., beams, plates, shells, cubes, etc.) interconnected at a number of points (nodes) along the element boundaries. As such, it represents the actual vehicle structure configuration, member cross section geometry and material properties, and mass distribution. Each element is assigned force-deflection characteristics defined by classical structural theory and consistent with external and internal energy balance considerations. The response of the entire structure to a prescribed loading is obtained via the solution of a set of simultaneous equations for the deflections at each node point. Knowledge of these deflections permits computation of the state of stress within each element and the acceleration response of each mass point employed in the model.

There are many general-purpose, **FEA** computer codes currently available which have the capability to perform the dynamic elastic-plastic analysis using a mainframe computer, e.g., **ALGOR**, **ANSYS** and **MARC**. However, any attempt to idealize an entire (or even a part of) single vehicle structure in sufficient detail (i.e., with a fine enough mesh) to account for all the cross sectional complexities in the impact zone results in the generation of a model containing an inordinately large number of finite elements. Mainframe computer time costs associated with performing even a single-vehicle crash analysis with such **FEAs** would be prohibitive. This cost factor, coupled with model generation labor time (see later discussion) and the inability of such codes to account for the many complexities inherent in analyzing the dynamic, large-deformation response of complicated, three-dimensional structures, constitutes a major shortcoming of **FEA**.

It should be noted that several software developers have made available versions of their mainframe **FEA** codes which can be exercised on large-memory personal computers. However, these analyses are generally restricted to linear elastic or limit load structural applications (see ultimate load analysis discussion in this subsection).

Relatively new special-purpose codes have appeared which have partially alleviated the above-noted inherent impracticality of performing highly detailed vehicle crash analyses using general purpose **FEA** programs. Analyses such as **DYNA3D**, **PAM-CRASH** and **RADIOSS** can solve much larger dynamic problems relatively faster than their earlier FEA counterparts. Moreover, contact/impact algorithms contained in these programs are particularly conducive for use in the simulation of such collisions. However, the magnitude of effort required to create, analyze and evaluate a full vehicle model should not be underestimated. According to [4-5], it generally takes about three months to produce a high-density mesh model of an automobile. A supercomputer, or at least a minisupercomputer, is required to perform the analysis. Performing a simulation of an automobile frontal barrier impact can take an average of seven or eight hours of computation time on a typical Cray or Convex supercomputer, while the latest models have the potential to reduce that figure to about two hours. Computer time costs on such installations are very expensive. (Of course, once completed, the model can be used for many different simulations.) In such runs, only that portion of the vehicle which experiences plastic deformation (e.g., the front end of an automobile subjected to a frontal barrier impact) is modeled with a fine mesh needed for modeling structural impact. Those areas not expected to undergo permanent deformation (e.g., the region behind the automobile firewall) are usually modeled with a very coarse mesh.

Perhaps the greatest challenge associated with finite element crash analysis is identifying the required modeling detail to simulate the salient features of a crash, while still permitting the resulting analysis to be economically feasible. It should also be noted that while an accurate, versatile computer code is essential for an adequate crash analysis, it is not enough. Some expertise in the details of the design that is to be analyzed and in the "art" of modeling a vehicle for a nonlinear dynamic analysis is also required in order to produce sufficiently accurate results with a minimum of time and cost. The analyst who prepares the model and its input data for the computer code should have a thorough understanding of the capabilities of the theory as well as sufficient experience to know what will and will not work.

The results of the initial survey made for this report indicated that **FEA** applications in train collision modeling was limited to handling selected portions of the entire problem. That is, given the initial conditions (from a separate kinematics analysis) for **a selected vehicle in a single crash event** in the totality of such events that can occur during an accident, FEA could be used to compute the deformation and acceleration profile of that vehicle in that one scenario. This process could be repeated for all crash events involving all vehicles in the consist. And, as mentioned earlier, **FEA** could also be utilized to generate force-deflection input data for lumped-mass and hybrid analyses.

However, a recent study performed by the Frazer-Nash Consultancy Limited (**FNC**) in England demonstrated at least **conceptually** that **FEA** may be suitable for simulating all three of the physical processes--consist kinematics, primary collision and secondary collision--that occur during a train accident. This work, described in [4-6], was performed using a proprietary **FNC-**

modified version of the **DYNA3D** computer code. Assumed rail vehicle force-deflection, mass, and inertial properties were used as inputs to the example simulations presented therein. This special-purpose code has not yet been validated quantitatively.

To illustrate the vehicle kinematics capability of this code, **FNC** simulated the collision of a five-car rail consist into a rigid, angled barrier. Figure 4-1 presents two views of the simulation over a real-time period of 1.5 seconds. Vehicle shapes were modeled using rigid elements from the **DYNA3D** library; springs were employed to represent simple chain link couplers between the vehicles.⁽³⁾ This simulation is reported to be capable of including the effects of interactions between the vehicles in the consist as well as between the vehicles and the ground and/or wayside structures. Force-deflection data needed to account for these impacts would be provided via experiment or analysis (e.g., modeled with deformable elements from the **DYNA3D** library).

The Frazer-Nash Consultancy also simulated the structural and acceleration response of a vehicle to a primary collision using another module of the above-noted, modified **DYNA3D** code. This part of the code is formulated to model all physical processes present in the large-deformation response of inelastic (i.e., an idealized material that exhibits no elastic response to loading) structures to impulsive loading, including sliding contact and contacts between portions of the vehicle structure itself. Figure 4-2a depicts a qualitative assessment of the progressive state of the deformation of an entire, simplified coach body in a flat barrier impact (barrier not shown). A detailed representation of the plastic deformation generated in the body near the crash interface is shown in Figure 4-2b.

The use of a third module of the **FMC**-modified version of the **DYNA3D** computer code to model secondary impact is discussed in Section 4.2.2. It should be noted that the **FNC** FEA approach to **total** train accident simulation currently employs a manual interface between the three modules of the modified **DYNA3D** code. That is, pertinent results from the rigid body (kinematics) analysis are input to the vehicle crash/contact deformation analysis. Appropriate vehicle deformed geometry and acceleration response output from the latter run is then input to the occupant dynamics analysis to provide information regarding occupant kinematics, compartment interior contacts, and injury indicator estimates.

Hybrid Analysis

A third approach to determine the dynamic response of a vehicle subjected to crash loading is hybrid analysis (**HA**). Such analyses generally combine selected features of lumped mass analysis and finite element analysis to give the analyst greater flexibility in formulating a model of a vehicle structure. Hybrid analyses can model a vehicle using lumped masses connected by user-defined nonlinear springs or actual beam elements, thus reflecting a level of analytical sophistication somewhere between that of **LMA** and **FEA**. As is the case with **LMA**, representative structural components or assemblies can be built or cut from an existing vehicle

³The Frazer-Nash Consultancy report indicates that other types of couplers such as the buck-eye and the three-link can also be modeled with their FEA analysis.

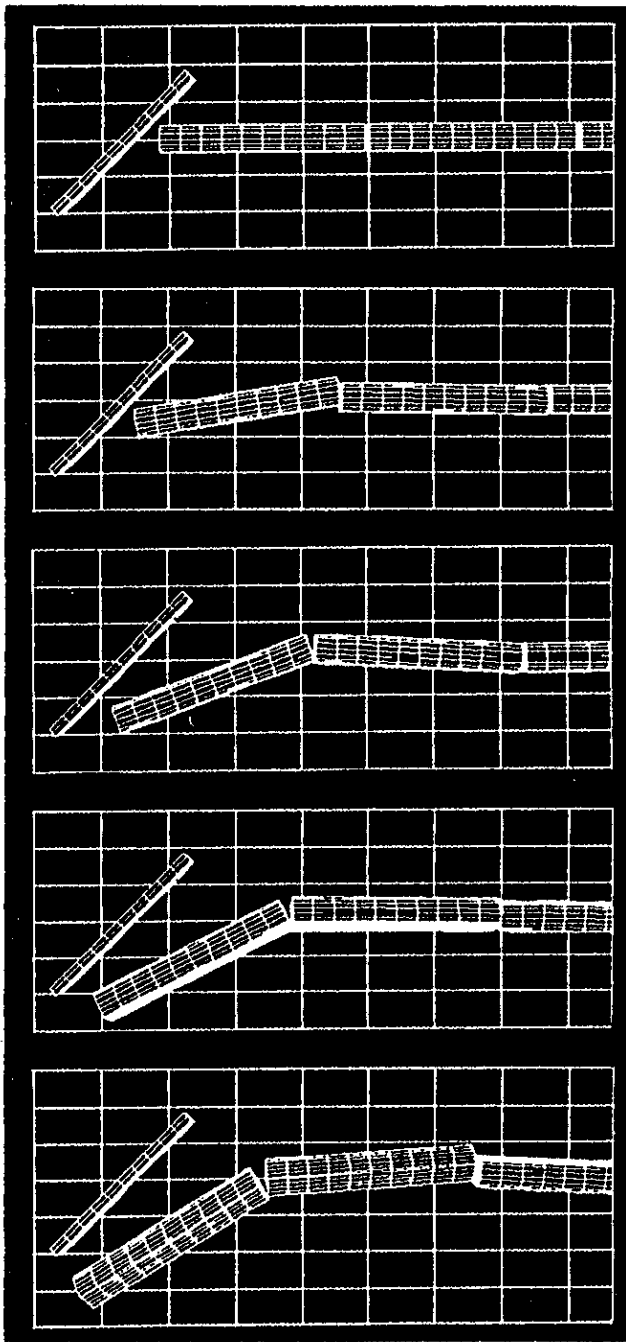

(a) PLAN VIEW

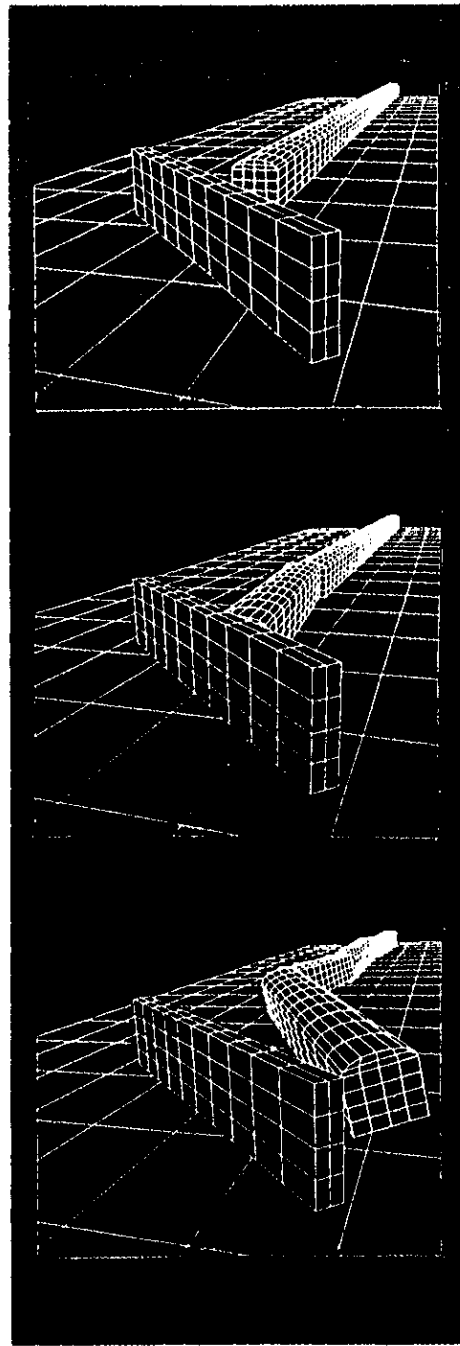

(b) PERSPECTIVE VIEW

Figure 4-1 Kinematics of a Five-Car Train Angled Barrier Impact: FNC DYNA3D Simulation

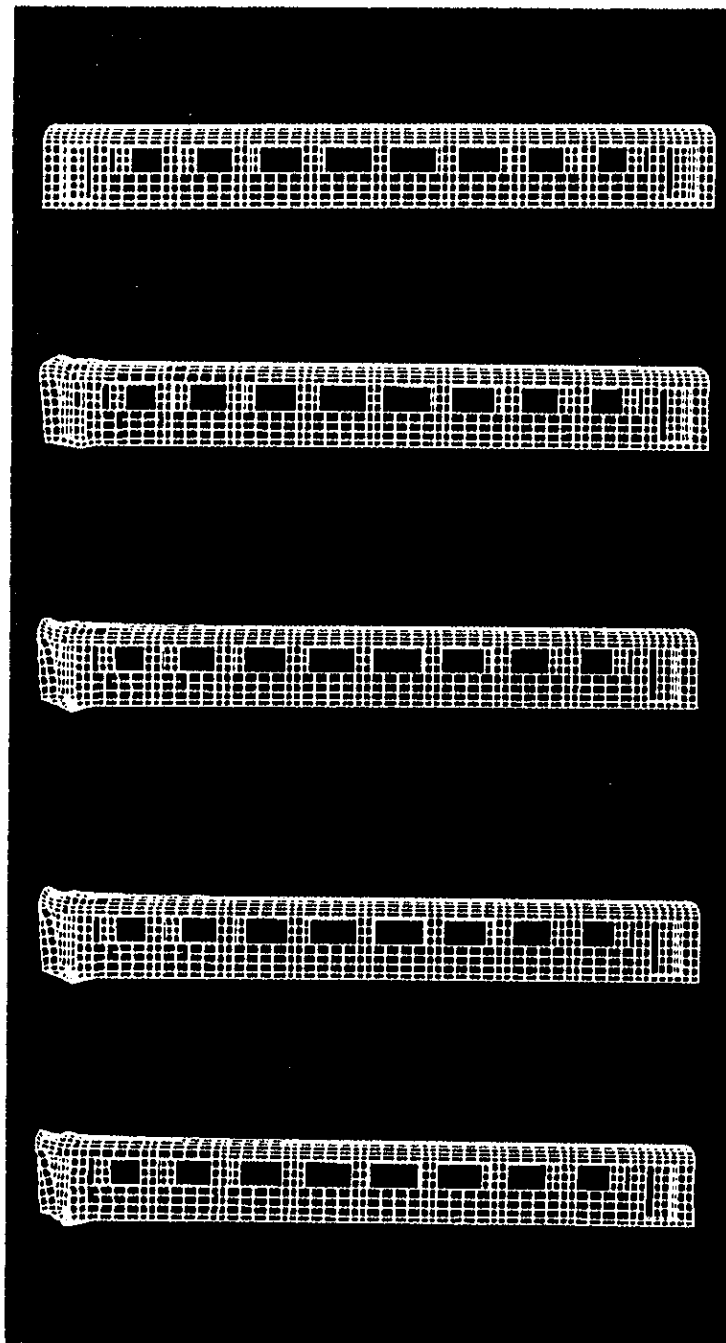

(a) OVERALL VIEW

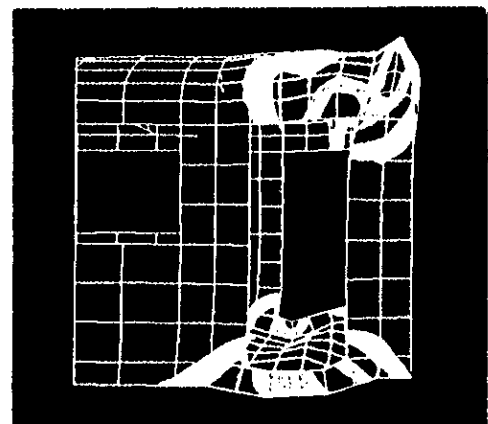
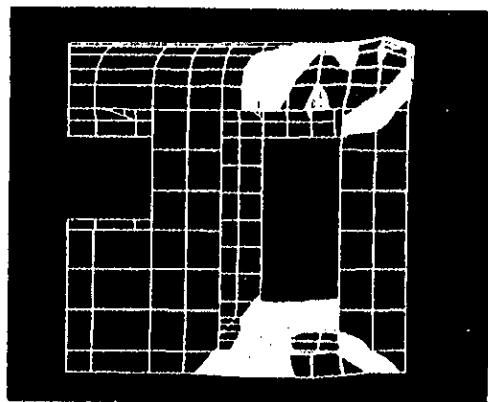
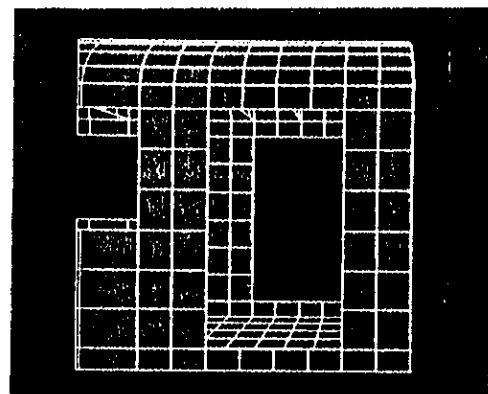

(b) IMPACT END DETAIL

Figure 4-2 Collapse of a Passenger Rail Coach Body in a Flat Barrier Impact: FNC DYNA3D Simulation

and crush tested to provide the required force-deflection input data to **HA** codes. Manufacturer-defined force-deflection data for commercially available energy absorbing devices (e.g., shock absorbers) can also be readily accommodated in a vehicle model. As noted previously, the use of such specified inputs helps simplify the computations required in the analysis of vehicle crash responses.

One such analysis, **KRASH**, described in [4-7], was developed by the Lockheed-California Company for the crashworthiness analysis of flight vehicles. **KRASH** can solve the coupled Euler equations of motion for a prescribed number of interconnected lumped masses, each with a maximum of six degrees of freedom. The interaction between the concentrated masses of rigid bodies is accounted for through interconnecting structural elements (beams) which are appropriately attached at their ends (pinned or clamped). These elements represent the stiffness characteristics of the structure between the masses and are specified by the user through selection of stiffness-deflection curves. The equations of motion are integrated to obtain the velocities, displacements and rotations of the lumped masses under the influence of external forces (e.g., gravitational, aerodynamic, impact), as well as forces due to internal elements. Incremental forces are calculated using a linear stiffness matrix and stiffness reduction factors from the user input information.

However, **KRASH**, like all analytical tools, has its limitations. One major problem is that the code uses force-deflection data obtained in a one degree-of-freedom (uniaxial translation) static crush test in situations where other translational displacement components and rotations can occur simultaneously. The effects of combined loading with regard to failure modes and force-deflection characteristics has not yet been fully assessed. In addition, **KRASH** can be applied only to the analysis of the impact of a single vehicle.

KRASH is regarded as a valuable analytical tool by airplane and helicopter manufacturers. Its predictions have provided generally good correlation with crash tests for several full-scale light- and rotary-wing aircraft. Improved methods or approaches, however, are needed for the assessment of the crash dynamics of large transport aircraft because of the large size of the structure, the numbers and range of occupants involved, and the diverse potential crash scenarios.

KRASH has also been applied to the simulation of rail vehicle collisions. For example, in the previously noted analyses performed by Boeing Vertol [4-3], the vehicles were modeled as a three-dimensional framework comprising elastic-plastic beam elements with the vehicle mass distributed at prescribed joints of the framework. Several assumptions, some consistent with the inherent program limitations, and others which simplified the problem, were made in the formulation of these models. Code limitations required that the impacting vehicle be regarded as a rigid structure and that relative motion between the two vehicles be ignored. In the model it was assumed that plastic hinges could form only at the location of masses and that local instabilities or element rupture did not occur.

The code was employed by Boeing Vertol as part of an extensive analysis process to develop recommendations for structural modifications to improve the crashworthiness performance of the Highliner self-propelled commuter car and the **EMD GP-40** locomotive. It should be noted, however, that the **KRASH** code cannot be used to predict the kinematics of a train collision.

ITT Research Institute developed a two-dimensional (in the longitudinal-vertical plane) hybrid analysis called **IITRAIN** [4-8 and 4-9]. This code employs a user-specified number of concentrated masses and various structural/mechanical elements to simulate the impact response of the vehicles in the train. **IITRAIN** can be used to determine whether the lead cars of two colliding consists crush, displace vertically and override, or crush with subsequent override. It can also predict the extent of such crushing and/or override sustained by each car in both consists, as well as the longitudinal, vertical and angular time histories of mass displacement, velocity, and acceleration. Internal forces and moments in the connecting elements are also provided by the analysis.

The **IITRAIN** code contains a wide variety of different elements, e.g., a deformable elastic-plastic beam, deformable linear and nonlinear axial springs, a deformable anticlimber spring, a rigid link, a pin joint, etc. The depth of the anticlimber and the initial vertical misalignment (if any) of the two colliding cars can also be taken into account. Figure 4-3 depicts a transit car modeled with the code. The vehicle body, underframe, trucks, coupler, draft gear and anticlimber are idealized as six concentrated masses and various deformable and constraint-type elements.

A partial validation of the **IITRAIN** analysis was conducted using low-speed, full-scale crash test data generated by Pullman-Standard for a collinear, elastic impact of consists of freight cars [4-10]. The code prediction of horizontal coupler striking force correlated very well with experimental results for up to about 120 milliseconds of real-time. It is not known if the code has been validated for high-speed, destructive collisions in the plastic range of material deformation.

Reference [4-10] also describes how **IITRAIN** was utilized in sensitivity studies to determine what effect various physical parameters had on the tendencies of colliding vehicles to crush, override, or crush with subsequent override. As is the case with **LMA**, vehicle longitudinal crush predictions are indicated by the amount of axial deflection sustained by appropriate elements (e.g., springs). The **IITRAIN** code indicates the **tendency** toward override as a function of the magnitude of the vertical force present at the anticlimber location of each vehicle. Reference [4-10] indicated that this force component increases in some unspecified manner as the tendency for override increases.

Based on the foregoing information, it appears that **IITRAIN** may have at least a limited potential for use in discriminating between override and crush behavior in train-to-train collisions. As is the case with all **LMA** and **HA** codes, however, the actual predictive value of such simulations is highly dependent on the availability of reliable vehicle structure component/assembly force-deflection data.

Another hybrid computer code worthy of consideration for application to train collision analysis is **ADAMS** (Automatic Dynamic Analysis of Mechanical Systems). Its developer, Mechanical Dynamics, Inc., claims that this sophisticated general-purpose code is the world's most widely used software program for multibody system static and dynamic analyses. It is currently being used in the automotive industry to simulate vehicle ride, handling, and durability studies; suspension and steering analyses; and drivetrain dynamics. **ADAMS** contains a comprehensive library of basic joints and motion generators, including universal, spherical, rack and pinion and

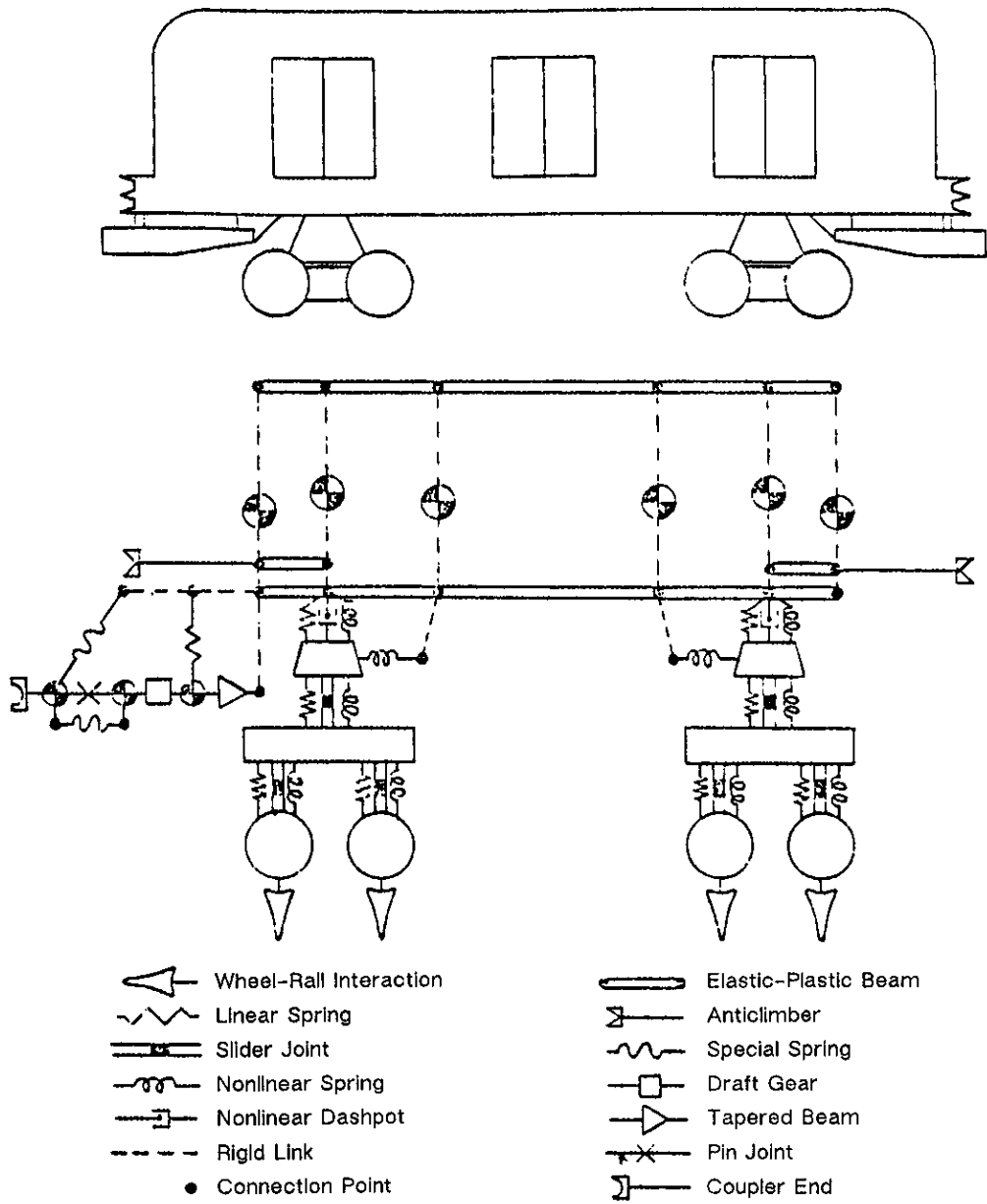

Figure 4-3 Typical IITrain Transit Car Model

screw joints. The code also features a similarly complete selection of forces, including gravitational, nonlinear effects, and both translational and rotational spring-dampers.

Because plastic material behavior can be modeled only in the joints between connecting bodies, ADAMS cannot be used to simulate the responses generated in a vehicle structure undergoing collapse (i.e., the primary collision). It may, however, have potential for use in modeling the kinematics experienced by a consist of vehicles, with the vehicles regarded as rigid bodies.

Ultimate Load Analysis

The final analytical approach considered herein is ultimate load analysis (ULA). ULA (also commonly referred to as limit load or quasi-static analysis) codes examine the behavior of structures which undergo relatively large plastic distortion prior to their collapse under static loading conditions. Such analyses can be applied to a vehicle rollover because of the relatively low impact speed involved and because the mass of the collapsing structure (e.g., roof/sidewall) is substantially less than the mass undergoing acceleration (i.e., the entire vehicle).

One such program, PLASH, developed in England by Atkins Research and Development, was employed in the design of the British Leyland T-45 truck cab [4-11]. The program predicts the static collapse load for a space frame comprising one-dimensional beam-column elements. Two different constitutive (i.e., stress-strain) relationships are available for material idealization: perfectly plastic (non-strain hardening) or elastic-plastic (strain hardening). Any one of three different yield criteria can be used to determine when a plastic hinge will form during loading.

Another similar, unnamed ULA code employed in vehicle framework crashworthiness studies by the Cranfield Impact Centre of England, is cited in [4-7]. The collapse mechanism predicted by the analysis was in excellent agreement with corresponding experimental results obtained in a full-scale bus rollover test.

Although both ULA codes were formulated for the case of a single vehicle undergoing a rollover event, they may be useful for providing some insight into the gross effects of rollover accidents involving one or more vehicles in a consist.

It should be noted that the four analytical approaches outlined above could be combined in order to simulate all aspects of a train collision scenario. This concept, which was alluded to earlier in the discussion of the FEA approach, was the subject of a research and development program described in [4-12]. Here it was postulated that FEA could be used to model with a high degree of detail the couplers, car bodies and trucks of directly impacted rail vehicles while the less detailed LMA could be employed to represent the other vehicles (i.e., those sufficiently far away from the crash interface) in the colliding consists. Such a concept was actually applied in the previously mentioned locomotive/caboose impact study described in [4-3]. And, as alluded to earlier, the concept appears to be suitable for use with the two vehicle-related modules constituting the Frazer-Nash Consultancy's modified version of the DYNA3D FEA code.

4.2.2 Secondary Collision Analyses

Many occupant dynamics computer codes are basically lumped mass analyses of varying levels of sophistication. As an example of a very simple analysis, Calspan modeled a rail vehicle occupant as a single mass connected by a spring to a lumped mass analysis representation of each vehicle in a consist [4-1]. Similarly, as part of its IITRAIN code development effort, IIT Research Institute used two relatively simple types of occupant analyses keyed to specific occupant configurations within the compartment [4-10]. In this effort, a single-mass body block was employed to model the kinematics of a freestanding occupant while two different linkage-type analyses were formulated using rigid body bars to model the motion of a seated occupant.

Simplified occupant dynamics codes such as those described above lack the capability to accept the detailed inputs required to adequately describe critical compartment acceleration pulse, interior configuration, and compliance (i.e., surface force-deflection) parameters. Such codes also fail to account for the articulated nature of the human body; as a result, they cannot simulate the effects of various regions of the body impacting the compartment interior surfaces or another part of the body. These modeling considerations and others which significantly influence the accuracy of occupant response predictions for a given vehicle crash scenario are contained in more sophisticated computer codes.

The Articulated Total Body (ATB) computer code, described in [4-13], is a highly sophisticated, three-dimensional occupant dynamics analysis extensively used as a valuable analytical tool by both the worldwide automotive/light truck community and the U.S. Air Force in motor vehicle crashworthiness and flight safety applications, respectively. ATB and other codes similar to it are concerned with the simulation of whole-body kinematics and inertial loadings of restraint systems and body areas that impact the vehicle interior, rather than a detailed treatment of biomechanical characteristics. The human body has, therefore, been approximated by an articulated assembly of rigid mass segments with dimensional and inertial properties that are sufficiently representative to provide characteristic motions of the head, torso, and extremities.

With ATB, the human body is typically represented as a system of fifteen segments connected by fourteen joints as illustrated in Figure 4-4. External forces are applied to each segment at its surface, which is approximated as an ellipsoid. Hundreds of inputs are required to describe the geometric, inertial, joint, and compliance properties of the crash victim.⁽⁴⁾ Other required inputs include the geometric and compliance properties of all seats and contact surfaces (i.e., vehicle components which may be struck by the occupant) and the acceleration components of the vehicle compartment. Output from the model includes time history printouts of the linear and angular accelerations, velocities and displacements of any segment selected, joint angles and torques, the location of and forces developed during occupant contacts, and the values of injury criteria such

⁴These parameters include the lengths of all three ellipsoid axes, the weight, center of gravity location, and principal moment of inertia about each of the three orthogonal axes of the ellipsoid, as well as joint torque characteristics as a function of the angular displacement and velocity of each joint.

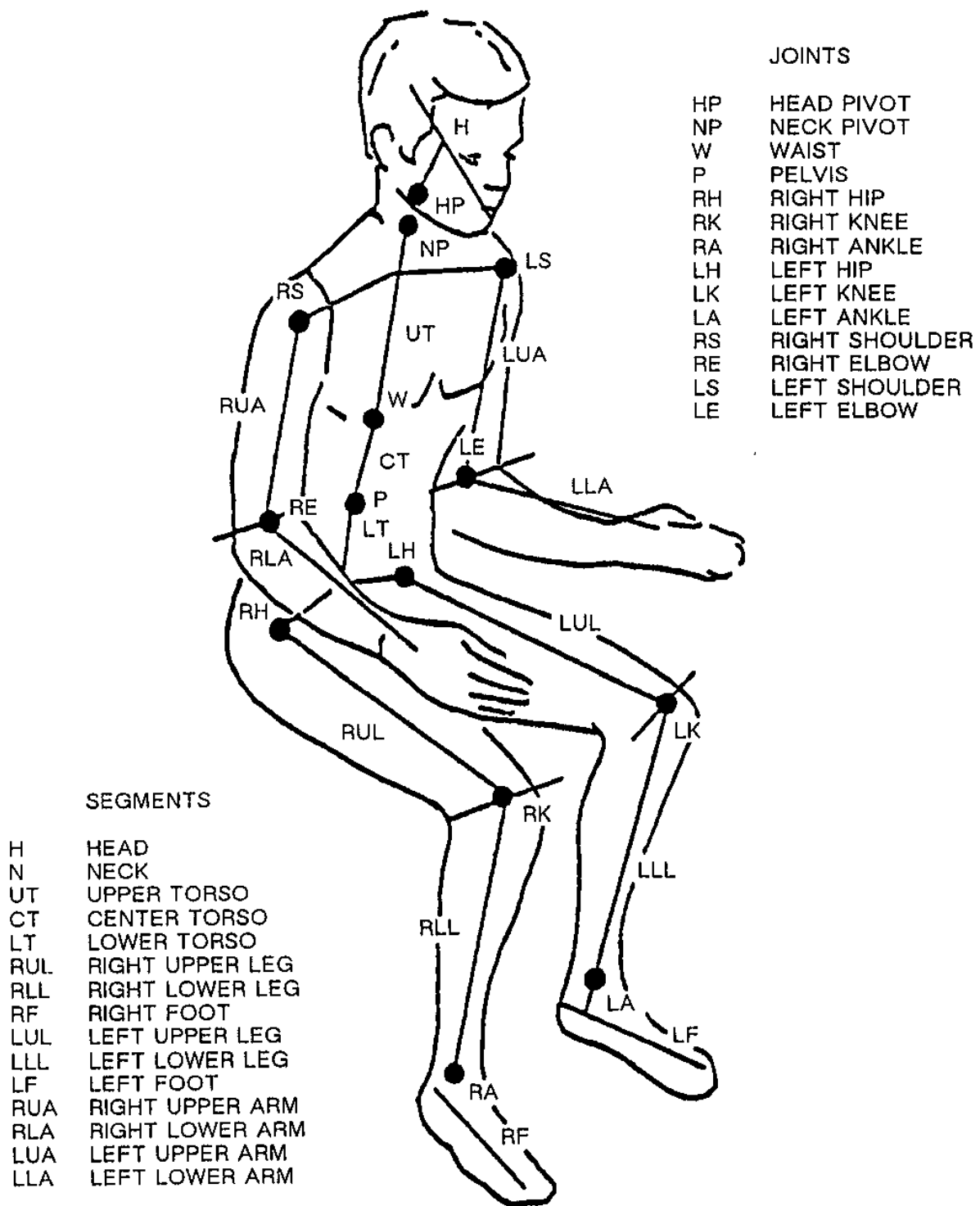

Figure 4-4 ATB Fifteen-Segment Man-Model

as the HIC, maximum head and chest resultant accelerations, and maximum femur loads. Provision is also made for the display of occupant kinematics at prescribed intervals of time using an associated three-dimensional computer program, VIEW [4-14]. Figure 4-5 presents a typical oblique side view of a VIEW-generated plot of an automobile occupant and potential contact planes in the compartment.

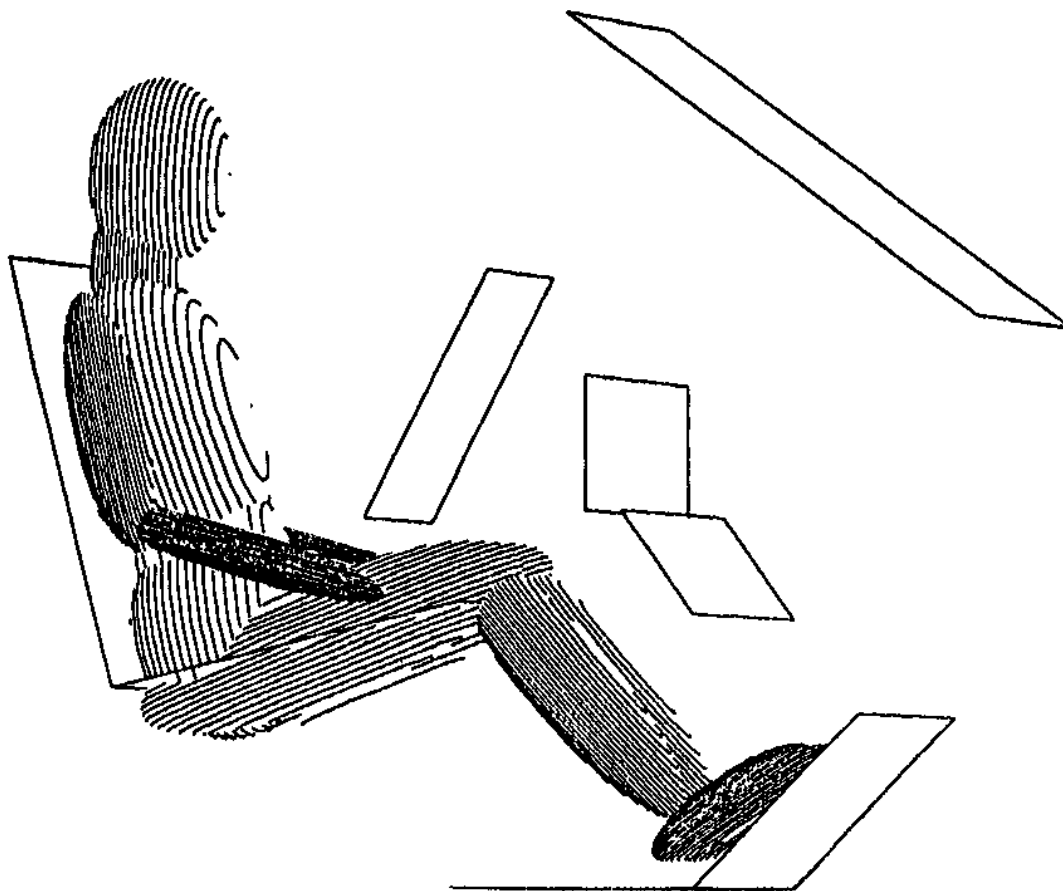

Figure 4-5 Typical View-Generated Plot

The ATB code also has the capability of simulating road vehicle restraint systems such as standard lap belts and 2- or 3-point belts, as well as airbag configurations. The dynamics of a freestanding occupant or a standing occupant grasping a stanchion or a handhold attached to the interior of a rail vehicle compartment could also be modeled with this analysis, provided the

quantitative data describing such grasping action is available. ATB has been exercised with two occupants in a single crash simulation. Future versions of this code may permit more body segments to be used and consequently, more occupants simulated in a given run.

Another three-dimensional occupant dynamics analysis similar to ATB is called MADYMO. Reference [4-15] and the TNO Road-Vehicle Research Institute (the developer of MADYMO) claim that the MADYMO code is more versatile than most of the other occupant simulation programs (such as ATB) because it gives the analyst more freedom in the choice of the number of segments that can be used for representation of a biomechanical system. The MADYMO analysis also permits an airbag to be modeled using a finite element representation. This feature will enable the complicated interactive processes which occur between the occupant, airbag and the airbag-support surface to be simulated in a more accurate manner. According to [4-16], MADYMO has been used to model at least three occupants during a single crash simulation.

Present FMVSS and FAA occupant injury criteria regulations are based on current generation instrumented anthropomorphic dummies developed by the automobile industry in conjunction with the Federal Government. Occupant dynamics codes attempt to match the physical characteristics of the dummy as closely as possible. Currently, the TNO Road-Vehicle Research Institute is working on enhancements to the MADYMO code which would allow sections of an occupant which undergo relatively large deformation to be considered as a deformable solid, rather than a rigid body. This modification would substantially increase accuracy of analysis, albeit at the cost of increased computation time. Segment deformation would be accounted for by modeling the surface of the body with finite elements, with the larger interior region still represented as a rigid body. Body surface deformation would reflect local properties of body segment interaction with a vehicle compartment interior contact plane.

Planned, future versions of MADYMO would enable the combined analysis of structural crash response and occupant motion by coupling the existing MADYMO code with highly sophisticated finite element codes such as DYNA3D and PAM-CRASH. This combined analysis would permit the structural deformation of the vehicle occupant compartment (e.g., real-time intrusion of an automobile firewall) and the action of the occupant to be modeled more realistically than with the geometry representing an undeformed or some prescribed deformed interior. Such a capability is conducive to sensitivity studies which would help optimize the crashworthiness performance of the vehicle structure, compartment interior, and restraint system.

The Frazer-Nash Consultancy Limited (FNC) appears to have developed such an occupant dynamics analysis using the capabilities of its previously mentioned proprietary modified version of the finite element analysis code DYNA3D (See Section 4.2.1). According to FNC [4-6], this version of the code, called DYNAMAN, possesses all the capabilities of its counterpart rigid body occupant dynamics codes in simulating occupant motion within the vehicle compartment. In addition, it can reportedly model the stiffness of selected portions of the occupant himself; account for multiple impacts from baggage, loose equipment, etc.; model the effects of compartment deformation in the vicinity of the occupants; simulate more than a single occupant in different positions and postures; and prescribe limiting values of occupant joint rotations. As noted above, use of the FEA approach to configure the surrounding compartment in an occupant dynamics simulation enables potential occupant contact surfaces to be modeled in a realistic

fashion, i.e., the effects of material yielding, failure, and nonlinear deformation can be included in occupant/compartment interior collisions.

Reference [4-6] provides an example of a qualitative prediction of occupant kinematics in a DYNAMAN 15 mph frontal barrier train crash simulation. Figure 4-6 depicts the motions of three occupants (two seated face-to-face and one standing holding on to a baggage rack mounted on the back of a seat) and the subsequent occupant-to-occupant and occupant/interior interactions at 100 millisecond intervals following the crash. The analysis modeled the standing occupant's grip on the rack as a spring. Contact between hand and rack was assumed to be broken at a prescribed force level. According to [4-17], the standing occupant's overall muscular control is also assumed lost at the moment of vehicle impact. The latter assumption may not be a realistic response at low compartment acceleration levels.

FNC indicated that video footage of dummy motion during a corresponding barrier test provided satisfactory qualitative validation of the occupant kinematics predicted by the DYNAMAN code for this particular collision scenario [4-18]. It was also indicated that numerical values of predictions of occupant injury indicator for this simulation were not calculated but can be routinely generated from DYNAMAN output.

As is the case with all FEA vehicle kinematics and crash/contact modeling, the cost of performing occupant dynamics analyses using this approach constitutes a major consideration in judging its viability. This cost increases as the number of occupants and potential contact surfaces increases. The number of occupants that can be modeled by DYNAMAN is a function of computer capacity. According to FNC [4-18], modeling six or more occupants would require running the program on a supercomputer.

4-27/4-28

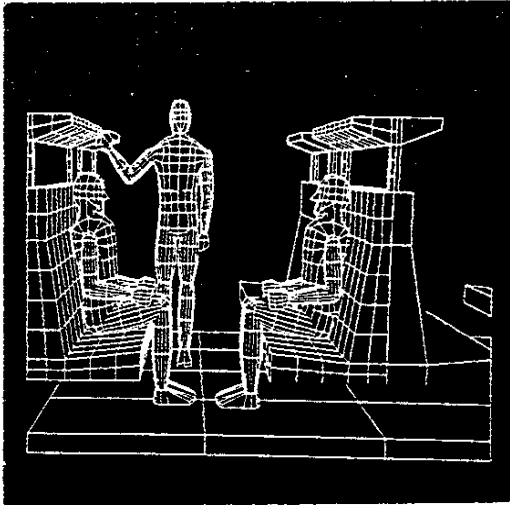

100 milliseconds

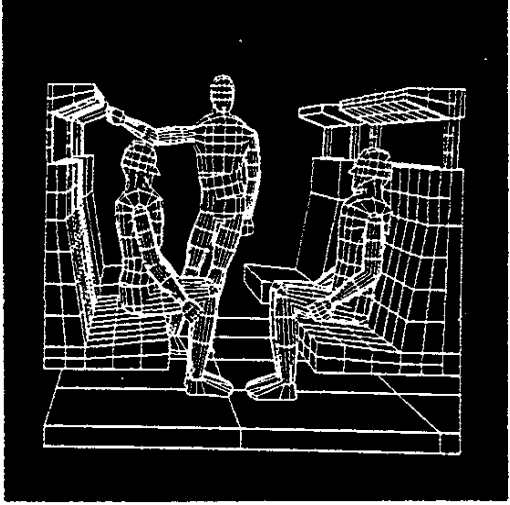

200 milliseconds

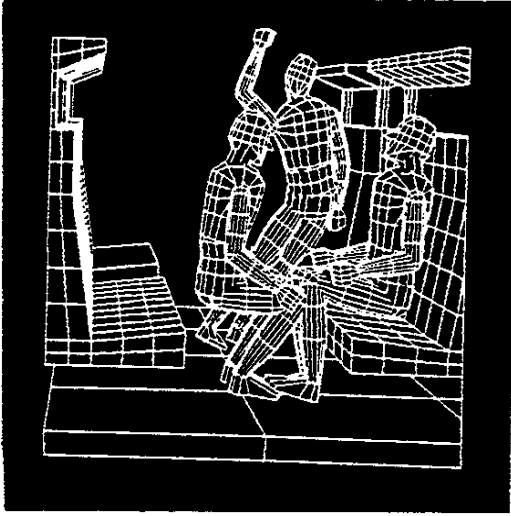

300 milliseconds

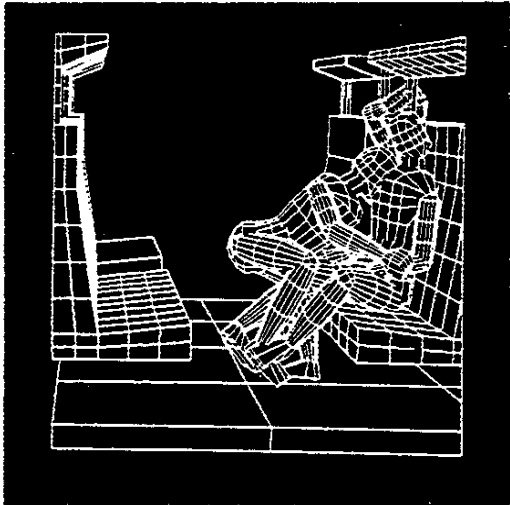

400 milliseconds

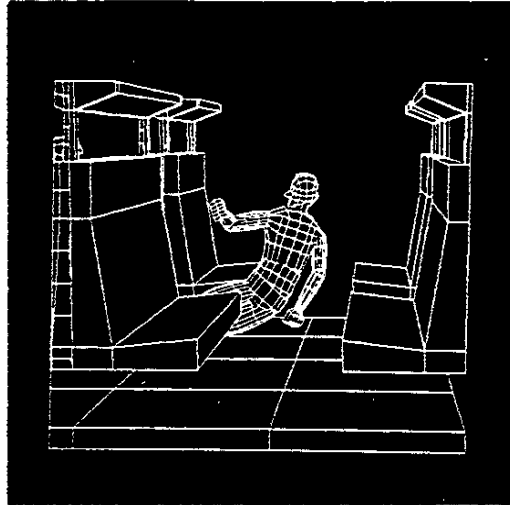

500 milliseconds

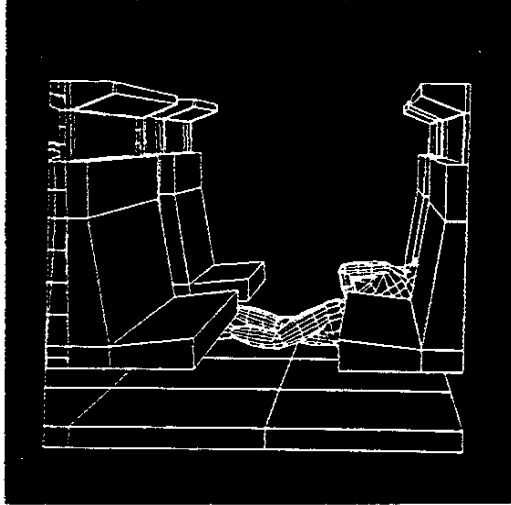

600 milliseconds

Figure 4-6 Occupant Motion in a 24 km/h (15 mph) Passenger Rail Coach Flat Barrier Impact: FNC DYNAMAN Simulation

5. CURRENT PASSENGER TRANSPORT VEHICLE DESIGN, CONSTRUCTION AND OCCUPANT SURVIVABILITY EVALUATION PRACTICE

Vehicles from different transportation modes face unique collision threats consistent with their normal operating environment. Vehicle designers take account of these differences to implement various structure and interior design strategies in an attempt to minimize the consequences of survivable crashes. Vehicle design and construction practices from five transportation modes were reviewed in an effort to ascertain what concepts are employed to satisfy general and vehicle-specific crash safety design and performance objectives. Methods used to determine production vehicle compliance with current rules, regulations, standards, and accepted industry practice governing vehicle crash safety were also examined for each of these categories.

The above surveys serve a two-fold purpose. First, the design approaches reflected by the various types of transport vehicles examined may be applicable for incorporation into the design of various portions of HSGGT vehicles. Second, knowledge of current crash safety performance compliance procedures should provide valuable guidance in the formulation of occupant survivability evaluation methodologies for HSGGT systems.

This chapter reviews pertinent design-related information for North American and foreign intercity passenger coaches and representative vehicles from four other transportation modes: (1) North American mass transit vehicles; (2) automobiles, multi-purpose passenger vehicles, light trucks, and small buses; (3) large buses; and (4) transport category commercial aircraft. Section 5.1 addresses vehicle structure features while Section 5.2 covers vehicle interior features. A brief discussion of the evaluation procedures employed in existing regulations and standards which address occupant survivability is presented in Section 5.3.

It should be noted that very little detailed design information was available for North American wheel-on-rail trains. Such information is believed to exist for their European counterparts but is not available. In addition, because virtually no technical information was available on the prototype German and Japanese maglev trains, the train-related discussions presented in this section use terminology employed in the description of wheel-on-rail vehicles.

5.1 VEHICLE SAFETY FEATURES

It was pointed out in Chapter 2 that for a given crash condition, a crashworthy vehicle absorbs the maximum possible amount of kinetic energy, preserves the integrity of the occupant compartment and limits the magnitude of restraint-generated occupant forces/accelerations and/or compartment interior contact velocity to tolerable levels. These general requirements can be translated into three generic HSGGT vehicle crash safety performance objectives:

1. Maintain at least a minimum occupant compartment survival space and ensure occupant containment (i.e., protect against occupant ejection) and post-crash egress for all possible impact conditions.
2. Limit occupant compartment acceleration characteristics to acceptable human tolerance levels.

3. Prevent penetration of the occupant compartment glazing and shell resulting from projectile impact.
4. Protect against occupant ejection.

Two other crash safety performance objectives that pertain principally to wheel-on-rail trains should also be addressed:

- o Limit lead vehicle frontal damage and protect the crew in grade crossing or guideway collisions with road vehicles, people, debris, animals, and similar obstructions.
- o Prevent the initiation of vehicle override in front and rear axial and side guideway impacts between rail vehicles.

It should be noted that the override issue is addressed in the first objective listed above. It is broken out separately here to enable the use of tabular comparisons of vehicle crash safety performance objectives relative to existing vehicle standards, regulations and industry practice.

For purposes of discussion, HSGGT vehicle "structure" will include the vehicle underframe and those attached functional mechanisms by which crash loads are transmitted to the vehicle (e.g., coupler assembly and truck-to-body attachment assembly); the superstructure (body shell), including glazing and doors; and design features which facilitate post-crash occupant egress from the compartment.⁽¹⁾ A similarly broad definition of structure will be employed for vehicles in the other transportation modes examined.

This section will briefly describe how crash safety performance objectives similar to those listed above for HSGGT vehicles are addressed (where applicable) by vehicles from the transportation modes considered in this survey. Noteworthy findings will be displayed in a tabular format. Within each category, the elements and assemblies which provide (or should provide) the intended function are identified, and existing performance requirements mandated by current rules, regulations, standards or accepted industry practice are briefly described. Critical performance issues not addressed by these guidelines will also be noted.

5.1.1 Intercity Passenger Coach and Power Car Structure

The structural design of current North American intercity passenger coaches operated in trains exceeding 272 tons (544,000 lb) total empty weight must satisfy Association of American Railroad (AAR) standards. These standards are identical to Federal Railroad Administration (FRA) standards formulated for the construction of multiple-unit (MU) locomotives. Although the AAR does not now formally issue passenger car standards, the standards originally developed by

¹In most wheel-on-rail vehicles, the underframe is very stiff, especially at both ends, where it is reinforced to accommodate the coupler assembly components. In comparison, the attached superstructure constitutes a very "soft" enclosure that can be easily penetrated and/or torn away from the underframe under certain impact conditions.

this organization have been adopted by Amtrak and all other providers of rail passenger service in the U.S. and Canada. Car specifications issued by operators of intercity rail service must comply with these standards, which constitute design requirements rather than formal regulations.

Table 5-1 presents a summary of existing structural crash safety standards for North American passenger coaches and power cars within the framework of the HSGGT vehicle structural performance objectives enumerated above. The key vehicle body strength categories noted therein are: buff (overall axial), collision post attachment, truck/body attachment, and vertical shear. Separate requirements apply to trains weighing less than 272 tonnes (600,000 lb) and to trains weighing 272 tons (544,000 lb) or more for three of the four standards. For those standards affected, however, the only difference in such specifications is the magnitude of the strength parameter itself. Key requirements pertaining to the first two of the above-listed strength criteria are discussed below.

Buff Strength

For trains exceeding 272 tonnes (600,000 lb) empty weight, regulation Title 49, Code of Federal Regulations (CFR), Part 229.141 (on strict interpretation, applicable to MU locomotives only) states:

"The body structure shall resist a minimum static end load of 3560 kN (800,000 lb) at the rear draft stops ahead of the bolster on the center line of draft, without developing any permanent deformation in any member of the body structure."

Association of American Railroad Standard AAR-S-034-69 also specifies the same strength requirement for passenger coaches in a slightly different wording.

Though the above requirement refers to "body structure," it actually is a measure of the underframe strength. It is also possible to put all the required strength into the center sill (without making that member unreasonably heavy or broad) and to leave the sidesill members and roof longitudinal members, which are more important for occupant protection, extremely light. Because the only significant test required for compliance with the standards is in the axial direction, this type of underdesign can go undetected.

Vertical Shear Strength

For trains exceeding 272 tonnes (600,000 lb) empty weight, 49 CFR 229.141 stipulates, for MU locomotives:

"An anti-climbing arrangement shall be applied at each end that is designed so that coupled MU locomotives under full compression shall mate in a manner that will resist one locomotive from climbing the other. This arrangement shall resist a vertical load of 445 kN (100,000 lb) without exceeding the yield point of its various parts or its attachments to the body structure."

**Table 5-1
Crashworthiness Standards for North American Intercity Passenger Coach and Power Car Structure**

Performance Objective and Applicable Accident Modes	Relevant Structural Elements and Assemblies	Current Structural Design Requirements				Unspecified Critical Structural Performance Issues/Remarks
		Subsystem Response ¹	Load Direction ²	Design Verification	Regulation or Standard ³	
Limit power car frontal damage and protect the crew in grade crossing or guideway collisions with road vehicles, people, debris, animals and similar obstructions	Power car underframe, superstructure and glazing	All glazing must withstand specified projectile impact requirements Each lead locomotive must be equipped with an end plate spanning both rails. a pilot or a snowplow		Dynamic test Observation	49 CFR: 223 49 CFR: 229.123	The nose of the power car should have the capability of deflecting a guideway obstruction from its path to prevent possible derailment or loss of levitation. Protection of the crew cab from penetration and/or local collapse of the shell from such Impacts and the minimization of structural damage as a result of a low -speed frontal Impact should also be Incorporated into the design.
Prevent the initiation of vehicle override in front and rear axial and side guideway impacts between rail vehicles	Coupler assembly and adjacent support underframe components; truck-to-body attachment assembly	Coupler assembly must resist 100,000 (75,000) pounds of static force without causing permanent deformation of the components comprising It or any other part of the car. Truck must remain attached to the body under a 250,000 pound static shear force. Permanent deformation is permitted. Metric equivalents given in Note 4 below.	Vertical (shear) Longitudinal (shear)	Calculations Calculations	49 CFR: 229.141 and AAR-S-034-69 49 CFR: 229.141 and AAR-S-034-69	Structural assemblies noted must transfer impact loads to the longitudinal underframe rails and limit the vertical vehicle motion in the early phase of the collision. The AAR code defines a vertical shear requirement for an anticlimber device. Such devices, however, are not utilized by most North American intercity passenger rail vehicles.

(1) Loads noted apply to cars employed in trains having a total empty weight exceeding 272 tonnes (600,000 lb). Loads in parentheses apply to trains weighing less than 272 tonnes (600,000 lb).

(2) Relative to vehicle longitudinal axis.

(3) 49 CFR 229.141 (applicable to MU locomotives only) and AAR-S-034-69 (applicable to passenger cars only) both stipulate the same structural strength requirements.

(4) Metric Equivalents: 100,000 lbf= 445 kN, 75,000 lbf = 334 kN, 250,000 lbf = 1112 kN

Table 5-1 (Continued)
Crashworthiness Standards for North American Intercity Passenger Coach and Power Car Structure

Performance Objective and Applicable Accident Modes	Relevant Structural Elements and Assemblies	Current Structural Design Requirements				Unspecified Critical Structural Performance Issues/Remarks
		Subsystem Response ¹	Load Direction ²	Design Verification	Regulation or Standard ³	
Maintain at least a minimum occupant compartment survival volume and ensure occupant containment and post-crash egress for all possible impact conditions	Underframe sill, cross-members and shear plates; collision posts; superstructure frame members (including corner posts) and skin; reinforcement members	Buff strength criterion: draft gear and underframe components must sustain 800,000 (400,000) pounds of static force applied at the draft gear centerline without causing permanent deformation in any part of the vehicle structure.	Longitudinal (compression)	Static test	49 CFR: 229.141 and AAR-S-034-69	The two requirements fail to address the large-deformation/energy absorption issue in compartment design. The structure at the collision interface must withstand the Impact without massive local failure, i.e., preserve some minimum acceptable portion of the original compartment volume. This entails that the connections between individual elements remain intact, allowing the Impact loading to be transferred to other parts of the vehicle. This will permit each element to develop its full energy absorbing potential and allow the total structure to collapse in an orderly, sequential manner. Doors should remain attached to the surrounding shell and be capable of being easily opened or removed after the accident. An anti-lacerative glazing material in a high-retention capacity window frame should be employed. AAR-S-034-69 provides guidance for recommended passenger coach construction practice: allowable design stresses, connections, member cross sectional property requirements, etc.
		Each of two collision posts must resist 300,000 (200,000) pounds of static force applied 18 inches above the top of the underframe. Permanent structural deformation is permitted.	Longitudinal (shear)	Calculations	49 CFR: 229.141 and AAR-S-034-69	
		Metric equivalents given in Note 4 below.				

(1) Loads noted apply to cars employed in trains having a total empty weight exceeding 272 tonnes (600,000 lb). Loads in parentheses apply to trains weighing less than 272 tonnes (600,000 lb).

(2) Relative to vehicle longitudinal axis.

(3) 49 CFR 229.141 (applicable to MU locomotives only) and AAR-S-034-69 (applicable to passenger cars only) both stipulate the same structural strength requirements.

(4) Metric Equivalents: 800,000 lbf = 3560 kN, 400,000 lbf = 1780 kN, 300,000 lbf = 1335 kN, 200,000 lbf = 890 kN

Table 5-1 (Continued)
Crashworthiness Standards for North American Intercity Passenger Coach and Power Car Structure

Performance Objective and Applicable Accident Modes	Relevant Structural Elements and Assemblies	Current Structural Design Requirements				Unspecified Critical Structural Performance Issues/Remarks
		Subsystem Response	Load Direction	Design Verification	Regulation or Standard ¹	
Maintain at least a minimum occupant compartment survival volume and ensure occupant containment and post-crash egress for all possible impact conditions	Compartment interior; door and window assemblies	Sliding doors only shall be used Maximum window size is limited to 1100 square inches ² At least four emergency escape exits of prescribed minimum size must be provided A wrecking tool cabinet, with an axe and sledge-hammer must be provided Emergency lighting must be provided		Observation Observation Observation Observation	AAR-S-034-69 Current practice AAR-S-039-69 AAR-S-039-69 AAR-S-039-69	These five requirements pertain to coaches only.
Limit occupant compartment acceleration characteristics to acceptable human tolerance levels	Entire vehicle	None specified				Whole-vehicle acceleration response to Impact is a function of its mass, stiffness and collapse characteristics as well as crash conditions, such as the specific vehicle region experiencing initial contact, impact velocity and striking (or struck) vehicle or object. A relatively "soft" structure will limit the acceleration imparted to the compartment but will compromise occupant survival space. In view of the massive kinetic energy involved in some Impact scenarios, some trade-off must be made between maximum permissible compartment acceleration level and maximum survival volume.
Prevent penetration of occupant compartment glazing and shell resulting from projectile impact	Glazing and superstructure surrounding occupied volumes	All glazing must withstand specified projectile impact requirements		Dynamic test	49 CFR: 223	Penetration of superstructure other than glazing not considered

(1) 49 CFR 229.141 (applicable to MU locomotives only) and AAR-S-034-69 (applicable to passenger cars only) both stipulate the same structural strength requirements.

(2) Metric Equivalent: 1100 sq. in = 0.71m²

"The coupler carrier and its connections to the body structure shall be designed to resist a vertical downward thrust from the coupler shank of 445 kN (100,000 lb) for any horizontal position of the coupler, without exceeding the yield points of the materials used. When yielding type of coupler carrier is used, an auxiliary arrangement shall be provided that complies with these requirements."

Standard AAR-S-034-69 also specifies the 445 kN (100,000 lb) vertical strength requirement for passenger coaches.

The requirement states that an anti-climbing arrangement "shall mate in a manner that will resist one locomotive from climbing the other." It appears to address only that climbing that can occur between identical cars within a train, since no information or criteria are given relating to a height range for anti-climbers to prevent climbing between different types of cars. Indeed, coupler override was a major factor in the high-fatality Highliner accident described later in this section. It should also be noted that the standards require only a 445 kN (100,000 lb) climbing load to be resisted by the anti-climber. This is a force of about 1 g in terms of rail car weights, and can be satisfied by a relatively small effective anti-climber cross sectional area. It would appear that the anti-climber load requirement should be related to a rational analysis of possible vertical velocities and impact forces.

The above two body strength standards, as well as the collision post and truck/body attachment strength requirements paraphrased in Table 5-1, share certain common features:

- o The standards address the problem of static strength, with little or no provision for the consideration of massive vehicle deformation, high kinetic energy dissipation requirements, or general structural integrity.
- o Strength requirements deal primarily with individual components and are not comprehensive in terms of specific or overall structure. Moreover, levels of strength required appear to be low in comparison with car and train weight, and proper strength distribution over the car shell is not ensured.
- o Effective means of checking compliance with the four key body strength criteria is limited to the full-scale buff strength longitudinal compression test; this test can be satisfied by cars having inadequate strength over most of the car structure. Stress analysis is employed to demonstrate compliance with the other three strength criteria.
- o Little or no control is maintained over materials and processes which can affect long-term vehicle strength, durability and energy absorption capacity.

Table 5-2 presents a similar summary of existing International Union of Railways (UIC) crashworthiness criteria for European intercity wheel-on-rail passenger train vehicles. The UIC code specifies two requirements to help prevent the onset of override, and several multilevel compression tests to evaluate occupant compartment integrity in longitudinal intervehicular collisions. As is the case with their North American counterparts, the latter compartment-related standards are formulated using linear elastic (i.e., non-permanent) deformation requirements. It

**Table 5-2
Crashworthiness Standards for European Intercity Passenger Coach and Power Car Structure**

Performance Objective and Applicable Accident Modes	Relevant Structural Elements and Assemblies	Current Structural Design Requirements				Unspecified Critical Structural Performance Issues/Remarks
		Subsystem Response	Load Direction ¹	Design Verification	Regulation or Standard	
Limit power car frontal damage and protect the crew in grade crossing or guideway collisions with road vehicles, people, debris, animals and similar obstructions	Power car underframe, superstructure and glazing	Forward-facing glazing must withstand penetration by sharp objects; broken glass must not have sharp-edged fragments. Safety glass used for all other glazing.		Dynamic test	UIC 617-4, 617-7 and 651	<p>The nose of the power car should have the capability of deflecting a guideway obstruction from its path to prevent possible derailment or loss of levitation. Protection of the crew cab from penetration and/or local collapse of the shell from such impacts and the minimization of structural damage as a result of a low-speed frontal impact should also be incorporated into the design.</p> <p>Specific glazing Impact requirements are not given.</p> <p>The TGV power car is equipped with a prow which serves as both a deflection shield and an energy absorber.</p>
Prevent the initiation of vehicle override in front and rear axial and side guideway impacts between rail vehicles	Buffer and coupler assemblies and adjacent underframe members; truck-to-body attachment assembly	Truck must remain attached to car body under a prescribed static shear load which is a function of car and truck mass.	Longitudinal (shear)	Calculations	UIC 515	<p>Some means should be provided to facilitate the direct transfer of impact loads to the longitudinal underframe rails and limit the vertical vehicle motion in the early phase of the collision. The UIC does not indicate any minimum vertical load resistance requirements on the buffers and screw-tensioned coupler assembly utilized on typical passenger coaches. U.S.-style couplers capable of resisting a vertical shear load are employed with many coaches currently in operation in Europe.</p> <p>The coaches in the interior of some European trainsets share a truck, forming an articulated and permanently-coupled unit.</p>
		Buffer must (a) develop prescribed compressive resistances between certain static force levels at various stroke increments, and (b) absorb at least 60% of the total stored energy imparted to the component in a drop test. Limits on permissible stroke and maximum force are defined.	Longitudinal (compression)	Calculations	UIC 528 O	

¹Relative to vehicle longitudinal axis

Table 5-2 (Continued)
Crashworthiness Standards for European Intercity Passenger Coach and Power Car Structure

Performance Objective and Applicable Accident Modes	Relevant Structural Elements and Assemblies	Current Structural Design Requirements				Unspecified Critical Structural Performance Issues/Remarks
		Subsystem Response	Load Direction ¹	Design Verification	Regulation or Standard	
Maintain at least a minimum occupant compartment survival volume and ensure occupant containment and post-crash egress for all possible impact conditions	Underframe sill, cross-members and shear plates; collision posts; superstructure frame members (including corner posts) and skin; reinforcement members	<p>The coach body and underframe must withstand minimum static forces at a number of different elevations without causing permanent deformation as noted below:</p> <p>450,000 pounds (2000 kN) at buffer level</p> <p>90,000 pounds (400 kN) 14 inches (350 mm) above buffer level</p> <p>67,000 pounds (300 kN) at center rail level (just below windows)</p> <p>67,000 pounds (300 kN) at cant rail level (side-to-roof joint)</p> <p>112,000 pounds (500 kN) diagonally at buffer level</p>	<p>longitudinal (compression)</p> <p>Diagonal (compression)</p>	Static test	UIC 566 OR	<p>The UIC code attempts to address many aspects of crashworthy occupant compartment design but provides only qualitative guidelines for override resistance in axial collisions.</p> <p>The structure at the collision interface must withstand the impact without massive local failure. i.e., preserve some minimum acceptable portion of the original compartment volume. This entails that the connections between individual elements remain intact, allowing the impact loading to be transferred to other parts of the vehicle. This will permit each element to develop its full energy absorbing potential and allow the total structure to collapse in an orderly, sequential manner. Doors should remain attached to the surrounding shell and be capable of being easily opened or removed after the accident. An anti-lacerative glazing material in a high-retention capacity window frame should be employed.</p>

¹Relative to vehicle longitudinal axis

Table 5-2 (Continued)
Crashworthiness Standards for European Intercity Passenger Coach and Power Car Structure

Performance Objective and Applicable Accident Modes	Relevant Structural Elements and Assemblies	Current Structural Design Requirements				Unspecified Critical Structural Performance Issues/Remarks	
		Subsystem Response	Load Direction	Design Verification	Regulation or Standard		
Maintain at least a minimum occupant compartment survival volume and ensure occupant containment and post-crash egress for all possible impact conditions	Compartment interior; door and window assemblies	End walls strengthened by anti-collision pillars must be joined to the head stock (buffer beam), ends of the cant rails and roof in such a way so that this assembly can absorb a large amount of kinetic energy and still resist override shear forces		Calculations	UIC 566 OR	Specific strength and energy dissipation requirements are not given.	
		A high-crush strength cab must be provided In the power car for the train crew		Calculations	UIC 617-5		Specific strength and energy dissipation requirements are not given.
		Automatic doors must have an emergency means of being opened manually from both inside and outside the car		Observation	UIC 560 OR		
		Power car and coaches must use glazing which exhibits unspecified penetration and anti-lacerative requirements		Dynamic test	UIC 617-4		
		Power car and coaches must provide a minimum number of emergency escape windows		Observation	UIC 617-4 and 564-1		

Table 5-2 (Continued)
Crashworthiness Standards for European Intercity Passenger Coach and Power Car Structure

Performance Objective and Applicable Accident Modes	Relevant Structural Elements and Assemblies	Current Structural Design Requirements				Unspecified Critical Structural Performance Issues/Remarks
		Subsystem Response	Load Direction	Design Verification	Regulation or Standard	
Limit occupant compartment acceleration characteristics to acceptable human tolerance levels	Entire vehicle	None specified				Whole-vehicle acceleration response to impact is a function of its mass, stiffness and collapse characteristics as well as crash conditions such as the specific vehicle region experiencing initial contact, impact velocity and striking (or struck) vehicle or object. A relatively 'soft' structure will limit the acceleration imparted to the compartment but will compromise occupant survival space. In view of the massive kinetic energy involved in some impact scenarios, some trade-off must be made between maximum permissible compartment acceleration level and minimum survival volume.
Prevent penetration of occupant compartment glazing and shell resulting from projectile impact	Glazing and superstructure surrounding occupied volumes	Forward-facing power car glazing must withstand penetration by sharp objects; broken glass must not have sharp-edged fragments. Safety glass used for all other glass in power car and coach		Dynamic test	UIC 617-4, 617-7 and 651	Penetration of power car and coach superstructure, power car side-facing windows and all glass in coach not considered. Specific glazing impact requirements are not given.

should be noted, however, that the UIC code does at least address the large-deformation/energy absorption issue in compartment design in a qualitative manner by requiring that the end wall/side/roof construction be capable of absorbing "the greater part of the energy produced if a collision occurs."

Comparison of the North American and European passenger car structural body strength requirements listed in Tables 5-1 and 5-2 shows that the UIC longitudinal strength requirements are considerably lower than their North American counterparts for loading at and just above the buffer level. There are also other differences between the two practices listed in these tables. Most notably, because buffers and screw-tensioned chain couplers which cannot sustain vertical loads are commonly used in Europe, the UIC code does not specify any minimum vertical (i.e., anti-override) load at the coupler. (However, U.S.-style or transit type couplers are used on many equipment types; these connections and the articulated consists that make up some foreign trains are capable of sustaining substantial vertical loads between vehicles.) In addition, the UIC specifies compressive force requirements at various heights on the superstructure and a diagonal loading requirement at the buffer level.

It should be noted that the magnitude of structural strength requirements specified by a rail vehicle design standard has a direct impact on overall train weight. Train weight, in turn, affects high-speed train performance, project cost, and viability.

It is apparent that the North American and European regulatory codes, standards, and industry practice governing the construction of the rail vehicle exterior structure are based on years of wheel-on-rail railroad operating and design experience and do not reflect general impact-related performance objectives. These objectives must necessarily address kinetic energy absorption, massive structural collapse and considerations of the environment of an occupant compartment undergoing acceleration. While the current approach leaves much to be desired, it does at least permit nondestructive testing of the vehicle while giving some (albeit incomplete) indication of its crashworthiness potential.

Tables 5-1 and 5-2 indicate that both North American and European intercity passenger coach design regulations and standards specify that certain structural performance requirements be verified by means of either experiment or "calculations." For the case of rail vehicles governed by current North American standards, these techniques comprise classical static structural analysis methods. It is presumed that their European counterparts are of a similar nature.

A literature review was performed in an attempt to obtain detailed analyses of the structural features of present-day passenger coaches. The only such information available was for a circa 1970 self-propelled, electric, double-deck MU car known as the Highliner. Figure 5-1 depicts the structural configuration of the cab end of this vehicle. The underframe is constructed of built-up sections of high strength low alloy steel welded together; the superstructure consists of a frame skeleton covered with a skin made from the same material.

This vehicle was the subject of a detailed structural analysis following a four-car Highliner consist rear-end collision in 1972 with another train comprising cars of an older type which resulted in 45 deaths and over 200 injuries to Highliner train occupants. In this 73 km/h (45

S-13

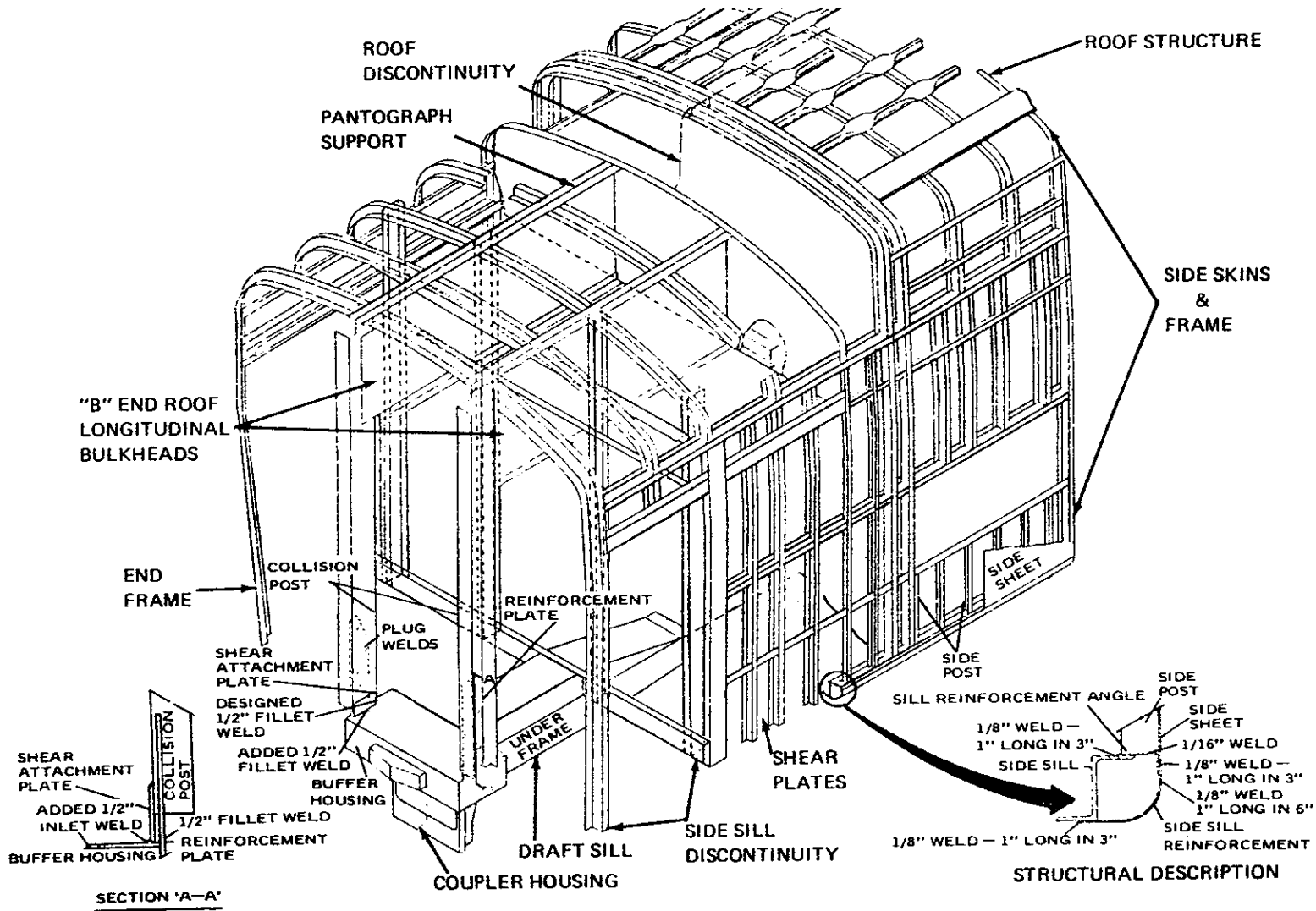

Figure 5-1 Highliner Cab End Structure

mph) impact, the lead vehicle of the other train overrode the coupler and buff beam of the impacted Highliner end vehicle, ripped through the collision post and end frame, and proceeded halfway through the car, destroying everything in its path. It should be noted that the couplers of the lead cars in the two trains were not compatible nor able to couple and the old type car was not required to have a truck retention capability. Consequently, the underframe of the climbing car acted like a battering ram and was the primary cause of the casualties.

Figure 5-1 illustrates several structural design features which, according to a comprehensive structural crashworthiness assessment performed by Widmayer [5-1], rendered the Highliner superstructure particularly vulnerable to axial impulsive loading. The first such feature is the side sill discontinuity, where a set of steps for access to the ground is located. Any load that is introduced to the end frame cannot be transferred to the side sill directly but must first go to the draft sill, the shear plates and then to the side sill. The shear plate attachment to the side sill limits the amount of load that can be transferred into it. Another design feature worthy of mentioning is the roof discontinuity. Loads introduced into the end frame or the longitudinal bulkheads must be transferred by shear forces to the roof sills. In addition, the design of the collision post attachment to the longitudinal bulkhead requires that load be transferred by the inherently weak roof skins to the roof sills.

Figure 5-2 depicts Highliner overall static axial force-deflection characteristics generated from buff test data. Three different response modes are illustrated; in each case the structural collapse follows a minimum energy path through the elements in the car and continues as the stronger elements fail.¹ It is evident that the full crush resistance and energy absorption potential of the vehicle (Figure 5-2a) in the axial collapse mode is reduced markedly when shear plate failure (Figure 5-2b) or override (Figure 5-2c) occur.³ This deficiency was manifested in the drastic loss of survival volume in the occupant compartment in the aforementioned accident.

Widmayer's analysis also indicated that the Highliner side walls and roof contribute very little to the overall high-speed impact crashworthiness of the car. If an object (e.g., another rail car or heavy mass) would impact the car above the underframe, it could penetrate the car, virtually destroying the side walls and roof. These parts of the superstructure did, however, appear to provide adequate protection for the vehicle occupants during a rollover sequence because vertical loads on the roof or horizontal loads on the sidewalls are distributed to the major frames and posts.

It should be noted that the double-deck Highliner structural configuration is not typical of the predominately single-level intercity passenger coaches in use today in both North America and foreign countries. The crashworthiness assessment described in [5-1] is an exemplification of the

²In this static analysis, it is assumed that all the vehicle mass is concentrated at the vehicle center of gravity and that it reacts the loads as required. In a real-world axial collision, the externally applied loads are reacted by the continuously distributed mass, resulting in a continually changing load distribution throughout the vehicle.

³The static energy absorption potential of the vehicle for such collinear impact configurations is equal to the area under the axial force-deflection curve.

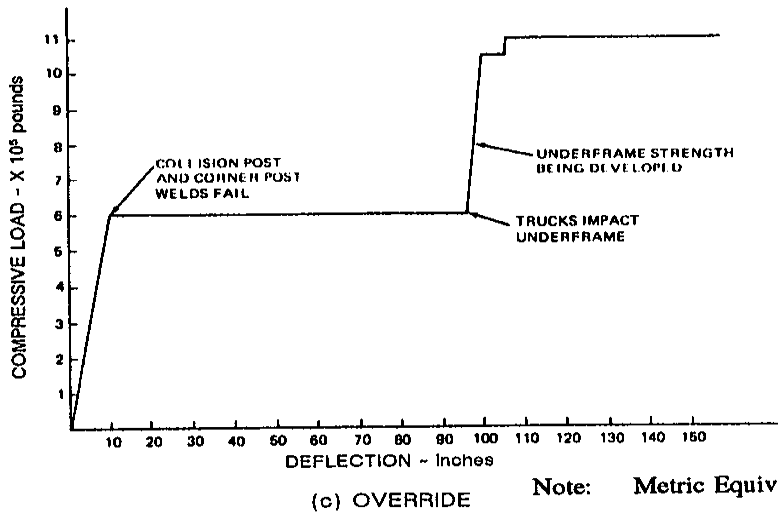
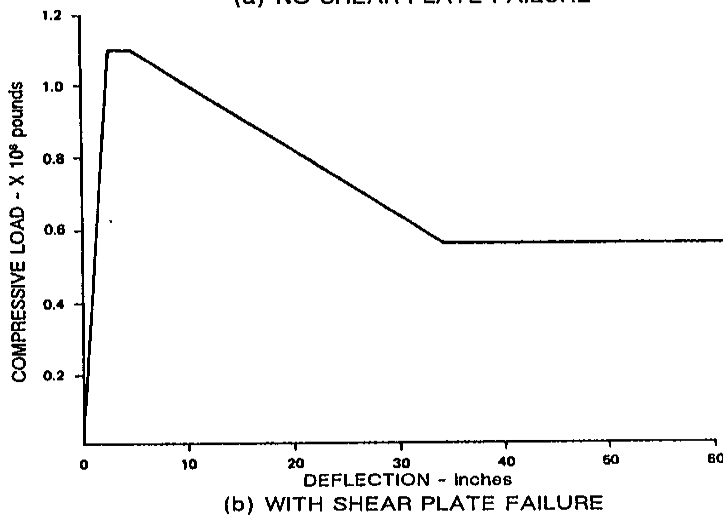
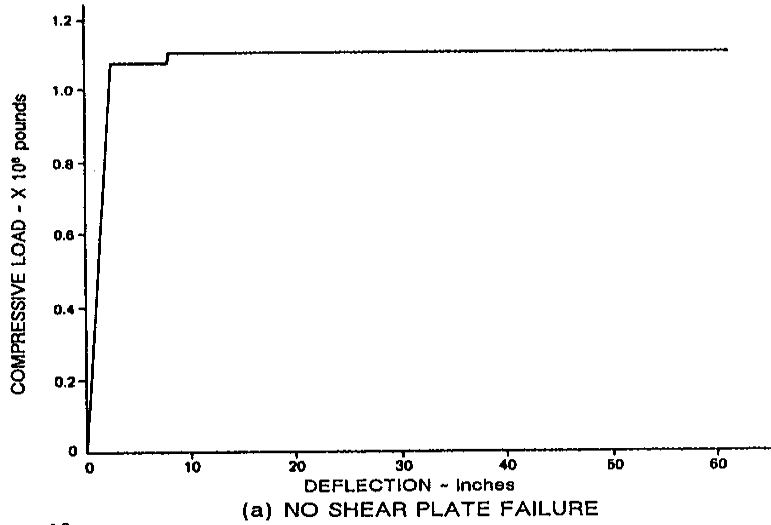

Figure 5-2 Highliner Force-Deflection Curves for Three Structural Response Conditions

kinds of useful information that can be obtained from rail vehicle construction drawings, static crush data, and structural analyses.

Reference [5-2] provides brief descriptions of three typical circa 1970 European passenger coach superstructures fabricated from steel. The first was a relatively heavy (body shell weight of 7484 kg (16,500 lb) traditional, stressed skin-design steel car with thick skin, a rolled-member side sill and a roof composed of corrugated members. It was noted that accident reports showed that the superstructures of such cars had a tendency to experience considerable longitudinal buckling during a collision with another rail vehicle.

The second type of passenger coach superstructure was a relatively light 5988 kg (13,200 lb) semi-monocoque design similar to that used in transport aircraft. Such body shells, shown in Figure 5-3a, have a thin skin which is partially effective in carrying compressive loading. This resistance is provided by longitudinal and transverse stiffeners attached to each other and to the skin by spot welding and riveting. It was noted that many of the spot welds and rivets securing the stiffeners to the skin unbuttoned during an accident, causing the body shell to open up in several locations.

The third type of coach body shell construction was a full monocoque structure which can effectively carry compressive load. Figure 5-3b shows a longitudinal extrusion design in which the longitudinal stiffeners are an integral part of the superstructure panels. Body shells made according to this design weighed about 6623 kg (14,600 lb), just somewhat heavier than the aircraft-type superstructure. The longitudinal extrusion-type design shell should also provide better longitudinal buckling resistance than its traditional, stressed skin-design counterpart. Although [5-2] alluded to plans to perform two full-scale crash tests in France in 1979 to evaluate this hypothesis, no documentation of such tests has been found.

A number of different high-speed passenger trains are currently in operation in Europe and Japan. Table 5-3 presents a representative listing of such trains, including a brief description of the material used in vehicle construction, vehicle accident survivability features, and type of intervehicle connection employed. Additional characteristics of these trains are given in [5-3].

It is of interest to note that the TGV vehicle superstructure has a welded-construction, high strength low alloy steel girder framework covered with semi-stainless steel. As such, it is considerably lighter than the circa 1970 steel body type construction described earlier. In addition, both TGV power car units feature a nose cone filled with aluminum honeycomb designed to absorb the kinetic energy of low-speed axial collisions with large objects (e.g., a bumper post or another vehicle) and high-speed impacts with smaller objects (e.g., a cow or a deer).

Table 5-3 also indicates that several of these train sets feature passenger coach superstructures constructed with welded aluminum extrusions. Because aluminum has a weight density approximately one-third that of steel, these shells are considerably lighter than their steel extrusion counterparts described earlier. Figure 5-4 presents a drawing and a photograph of a typical cross section of an aluminum extrusion car used in the Talgo HSGGT system.

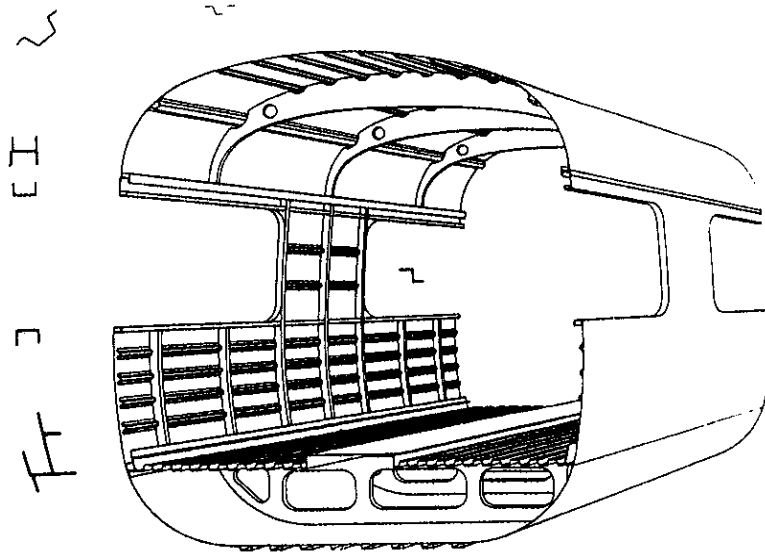

(a) AIRCRAFT-TYPE

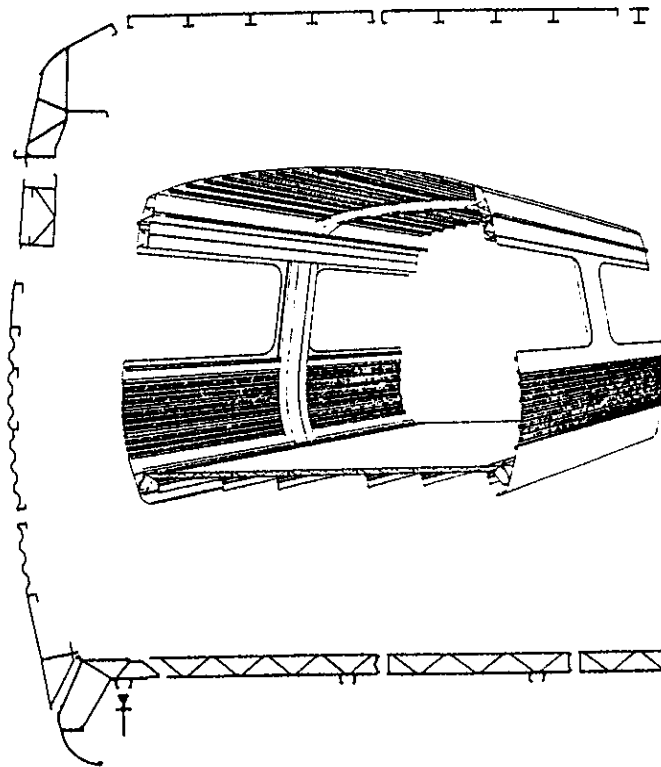

(b) LONGITUDINAL EXTRUSION

Figure 5-3 Cross Sections of Two Circa 1970 European Intercity Passenger Coach Body Types

**Table 5-3
Accident Survivability Features of Selected Foreign High-Speed Trains Currently in Operation**

HSGGT System	Consist	Materials		Iter-vehicle Connection	Other Features
		Power Car	Passenger Car		
Transrapid Maglev German	Vehicle made up of several separate vehicle units	Not applicable	Welded aluminum and composites	Believed to be ball joint type, allowing limited rotational freedom in all planes	Not designed to "railway" collision standards (UIC Code 566, etc.)
TGV France	Power car + 8-10 pass. cars + power car Two train sets may be coupled	Welded carbon steel	Welded carbon steel Aluminum (bilevel version)	Articulated consist: universal joint and other connections, allowing limited rotational movements in all planes Special design center coupler between train-sets	Crushable, energy absorbing nose structure at trains ends. Crushable ends on intermediate cars in future models.
ICE Germany	Power car + 10-14 pass. cars + power car	Welded carbon steel	Welded aluminum extrusions	Transit-style center coupler	None
Shinkansen Japan	Multiple-unit train. Most cars powered, all occupied	Not applicable	Welded carbon steel	Center coupler*	Do not follow UIC Code 566. However, believed to be at least as strong as European trains
IC 225 UK	Power car + 10 pass. cars + cab/baggage car	Welded carbon steel	Welded carbon steel	Center coupler*	Cab/baggage car, minimum weight 48 tonnes. "Cow-catcher" used
ETR 450 Italy	Multiple unit train. Most cars powered, all occupied	Not applicable	Welded aluminum extrusions	Center coupler*	Active tilt system
Talgo Spain	Passenger car consist only. No locomotive or power car	Not applicable	Welded aluminum extrusions	Articulated consist: ball joint allowing limited rotational movement in all planes	Passive tilt system
X2000 Sweden	Power car + 4 pass. car + cab/pass. car	Welded stainless steel	Welded stainless steel	Rigid bar center coupler with draft gear	Active tilt system

*Details not available. Current practice with high speed wheel-on-rail trains transit-style or bolted rigid bar center couplers incorporating air and electrical connections.

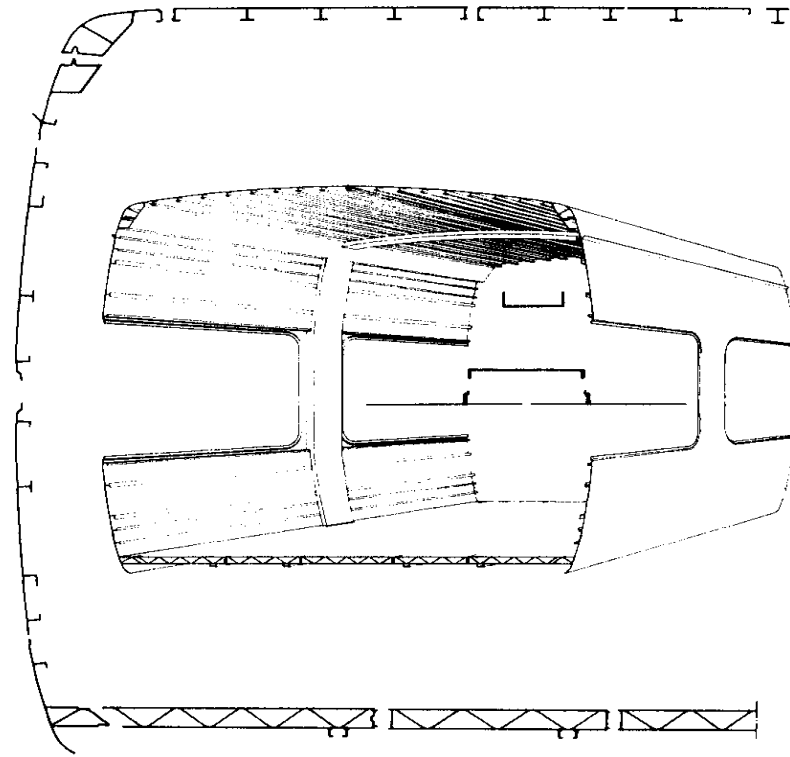

Figure 5-4 Typical Talgo HSGGT Passenger Coach Superstructure

Table 5-3 also notes that many foreign HSGGT systems employ intervehicle connections which help limit the amount of rigid body motion between vehicles in a consist. Moreover, the interior coaches in some of these train sets share a truck, forming an articulated and permanently-coupled unit. Such design features provide for greater consist stability and help prevent vehicle rigid body buckling during an accident.

Sweden's latest HSGGT system, the X2000, is also described in [5-4]. The X2000 power car was designed to satisfy **dynamic** test strength criteria beyond the static loading requirements specified in the current UIC code (see Table 5-2). Both operator cabs of the trainset must withstand an impact of 200 km/h (124 mph) from a 2m (79 in) wide cylinder weighing 5000 kg (11,000 lb) and a 4m (157 in) wide cylinder weighing 10,000 kg (22,000 lb) targeted at a point on the cab 1.8m (71 in) above the top of the rail on the track centerline. This reference also notes that a crash wall located at the rear of the power cab is provided as a refuge for the X2000 train crew.

Table 5-3 also lists a magnetically levitated train, the German prototype Transrapid 07 (TR-07) described in [5-5]. Figures 5-5 and 5-6 show the train itself and its suspension systems, respectively. The lower frame structure configuration wraps around the elevated guideway and prevents vehicle rollover during an accident. Figure 5-7 depicts a typical cross section of a passenger coach large-extrusion aluminum superstructure used in this train set. The panels composing this full monocoque design body are bolted together. The TR-07 train also uses restricted-motion connections between individual vehicles in the consist.

5.1.2 Vehicle Structures in Other Transportation Modes

Vehicles used in other transportation modes were briefly surveyed to ascertain what concepts are employed to achieve compliance with the previously discussed crashworthiness-related structural performance objectives and to determine what methods are used to assess such compliance. Four transportation modes were examined: (1) North American mass transit vehicles; (2) automobiles, multipurpose passenger vehicles, light trucks, and small buses; (3) large buses; and (4) transport category commercial airplanes. Noteworthy design features and current regulatory codes governing the design or performance of each type of vehicle are briefly reviewed in the remainder of this section. Table 5-4 presents a summary of current structural crash safety-related regulations and standards for these vehicles relative to the previously discussed HSGGT vehicle structural performance objectives.

5.1.2.1 North American Mass Transit Vehicles

The structural design features of circa 1975 North American mass transit vehicles are similar to that of their intercity power car and passenger coach counterparts built during the same time period. There is a notable conceptual difference, however, in side sill design. Because intercity passenger coaches have steps leading down to a low-level station platform, they have discontinuous side sills. Intercity cars therefore are designed with a strong center sill to compensate for this weakness. Because the floor level of mass transit cars is level with their

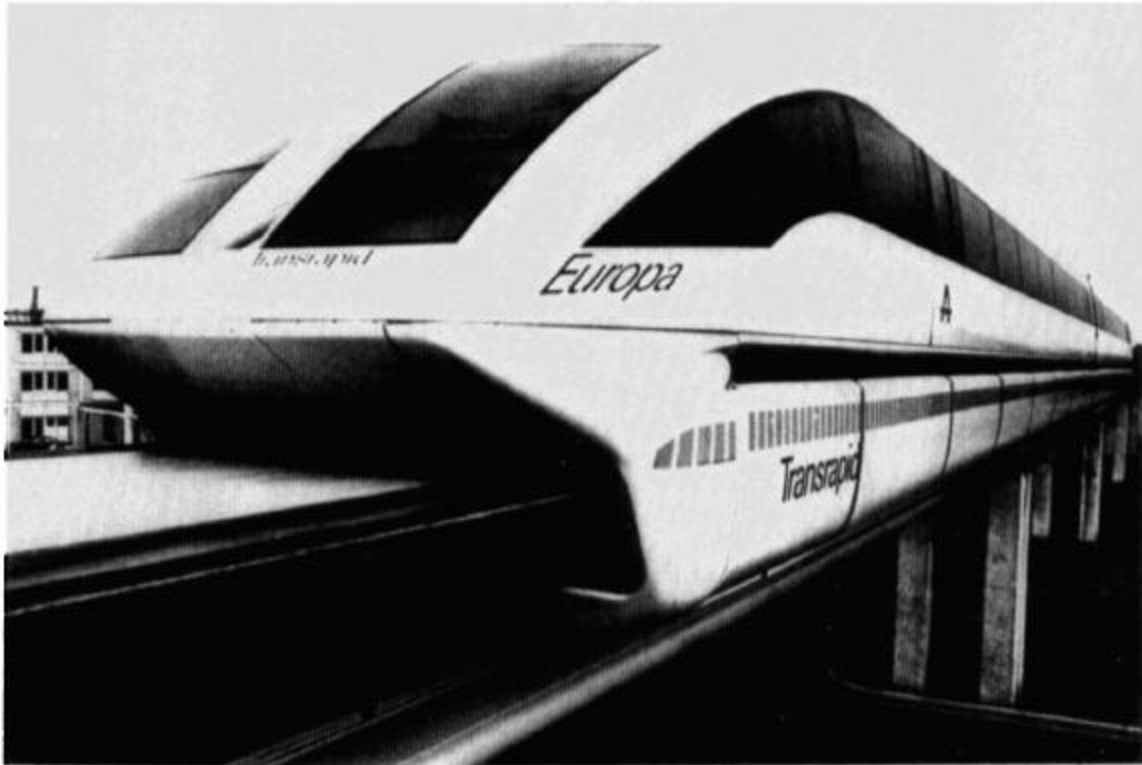

Figure 5-5 Transrapid TR-07 Maglev Train

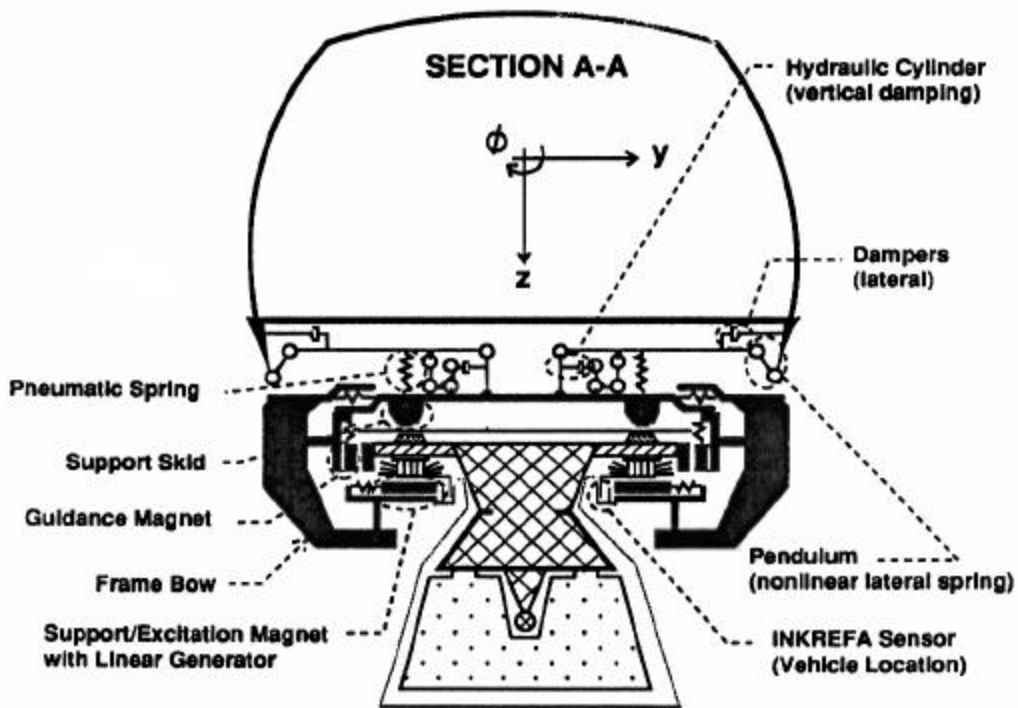

Figure 5-6 Transrapid TR-07 Suspension Systems

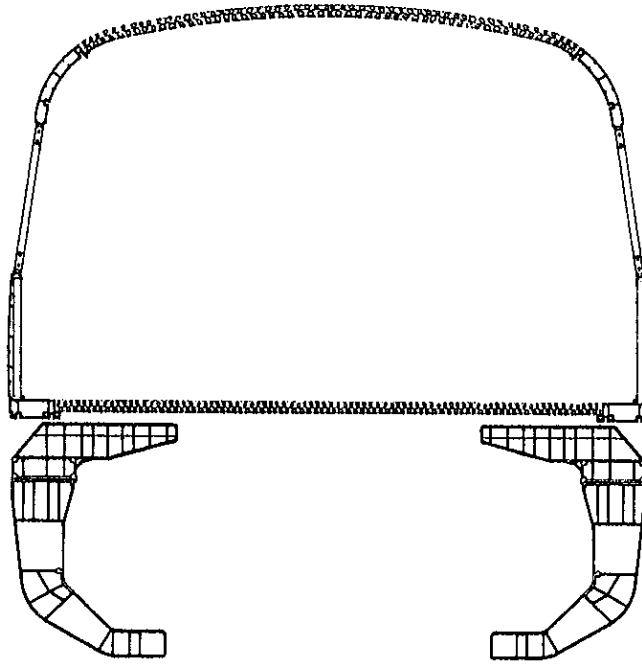

Figure 5-7 Cross Section of a Transrapid TR-07 Vehicle Body and Lower Frame Structure

station platform, steps are not needed on these vehicles, enabling them to have continuous side sills.

Mass transit vehicles also use an anti-climber device to help prevent the onset of override in intervehicular impacts. These devices, which constitute an extension to the vehicle underframe, are designed to engage after the coupler assembly is pushed in during the early phase of a collision.

Reference [5-2] points out that rail vehicles having an inclined bulkhead (e.g., the BART mass transit power car) concentrate the initial crash loading generated in longitudinal intervehicular collisions on a very small area of the vehicle end structure. This causes the inclined collision (corner) posts to buckle very early in the impact, reducing the effective collision strength and energy dissipation potential of the surrounding shell structure.

As indicated in Table 5-4, no single structural crash safety standard is currently applicable to all mass transit cars. Individual transit authorities produce their own structural specifications as part of design specifications for new cars. When such standards are employed, they tend to conform in part and/or to various degrees to the static force requirements outlined in the previously

**Table 5-4
Crashworthiness Standards for Vehicle Structure Utilized in Other Transportation Modes**

Performance Objective and Applicable Accidents	Relevant Structural Elements and Assemblies	Current Structural Design Requirements			Unspecified Critical Structural Performance Issues/Remarks
		Subsystem Evaluated (If Evaluation is Performed)	Design Verification	Regulation or Standard ¹	
Prevent the initiation of vehicle override in frontal and rear collisions between similar weight class vehicles	North American mass transit	Coupler, anticlimber and adjacent underframe members: truck-to-body attachment assembly	None or calculations	None or transit system-specific	Strength evaluations, if performed, conform to variations of the minimum static force levels stipulated by AAR-S-034-69 for trains having a total empty weight of less than 600,000 pounds.
	Automobile, multipurpose passenger vehicle, light truck and small bus	None directed at the override problems specifically. However, the cited bumper standard indirectly addresses passenger car bumper height	Dynamic tests	49 CFR: 581	Automobiles (only) must comply with low-speed impact damagability requirements. The vehicle bumper (and hence the longitudinal frame rails) must be located within a prescribed height zone above ground in order to satisfy the test requirements.
	Large bus	None			
	Transport category commercial airplanes	Not applicable			
Maintain at least a minimum occupant compartment survival volume and ensure occupant containment and post-crash egress for all possible impact conditions	North American mass transit	Buff strength of underframe; shear strength of collision posts	None, static test or calculations	None or transit system-specific	Strength evaluations, if performed, conform to variations of the minimum static force levels stipulated by AAR-S-034-69 for trains having a total empty weight of less than 600,000 pounds.
	Automobile, multipurpose passenger vehicle light truck and small bus	Glazing material characteristics; windshield, door and window integrity; roof and side door strength; body panel joint strength	Full-scale crash, dynamic and static tests	FMVSS 205, 206, 212, 214, 216, 217, 219, 220 and 221 (not applicable to all types of vehicles)	<p>FMVSS 208, the occupant protection standard, consists of a 30 mph frontal impact into a flat, rigid barrier with two instrumented, fully restrained, 50th percentile dummies placed in the driver and right-front seating positions (bus: driver only). It is not a vehicle structure-related performance standard, per se, and therefore is not included in this listing. However, excessive compartment collapse can affect the magnitude of the occupant injury parameters measured during the test, e.g., high HIC as a result of head/dash contact.</p> <p>FMVSS 205, 212, 217 and 219 address glazing material requirements, windshield, window and door integrity (including bus emergency exits and windshield zone intrusion).</p> <p>Side door strength is defined for automobiles only in FMVSS 214. Roof crush resistance requirements are defined in FMVSS 216 and 220 for automobiles and school buses, respectively.</p> <p>School bus body panel joint strength requirements are stipulated in FMVSS 221.</p>

No single standard is applicable to all transit systems. Individual transit authorities produce their own structural specifications as part of design specifications for new cars. FMVSSs: (Federal Motor Vehicle Safety Standards) are defined in Title 49, Code of Federal Regulations Part 571.

Table 5-4 (Continued)
Crashworthiness Standards for Vehicle Structure Utilized in Other Transportation Modes

Performance Objective and Applicable Accident Modes	Relevant Structural Elements and Assemblies	Current Structural Design Requirements			Unspecified Critical Structural Performance Issues/Remarks
		Subsystem Evaluated (If Evaluation is Performed)	Design Verification	Regulation or Standard ¹	
Maintain at least a minimum occupant compartment survival volume and ensure occupant containment and post-crash egress for all possible impact conditions	Large bus	Glazing material characteristics; window integrity; roof strength; body panel joint strength	Static and dynamic tests	FMVSS 205, 217, 220 and 221	FMVSS 220 and 221 are applicable to school buses only.
	Transport category commercial airplanes	Structural strength specified in terms of limit and ultimate loads; deformation must not compromise safe operation Flight crew and passenger emergency exits; emergency lighting	Static and dynamic tests or calculations Measurement and observation	14 CFR: FAR 25.301-307 14 CFR: FAR 25.805, 807, 809, 811, 812 and 813	Structure must comply with fatigue evaluation and damage-tolerance requirements (14 CFR: FAR 25.571)
Limit occupant compartment acceleration characteristics to acceptable human tolerance levels	North American mass transit	None			As is the case with their North American and European Intercity vehicle counterparts, mass transit vehicles also fall to address this issue.
	Automobile, multipurpose passenger vehicle, light truck and small bus	None			No specific guidelines are stipulated for a tolerable average occupant <i>compartment</i> acceleration response measured during the crash test. However, certain crash pulse characteristics as manifested by waveform shape, local peak magnitudes and duration are not desirable; such responses often impose too severe burden on the occupant restraint system and can lead to vehicle noncompliance with FMVSS 208 injury criteria.
	Large bus	None			
	Transport category commercial airplanes	"Structure" in an emergency landing condition	Calculations	14 CFR: FAR 25.561	This regulation does not cover a crash (i.e., non-landing) situation.

¹FMVSSs: (Federal Motor Vehicle Safety Standards) are defined in Title 49, Code of Federal Regulations Part 571.
FAR: Federal Aviation Agency Regulation.

Table 5-4 (Continued)
Crashworthiness Standards for Vehicle Structure Utilized in Other Transportation Modes

Performance Objective and Applicable Accident Modes	Relevant Structural Elements and Assemblies	Current Structural Design Requirements			Unspecified Critical Structural Performance Issues/Remarks
		Subsystem Evaluated (If Evaluation is Performed)	Design Verification	Regulation or Standard ¹	
Prevent penetration of occupant compartment glazing and shell resulting from projectile impact	North American mass transit	None			
	Automobile, multipurpose passenger vehicle, light truck and small bus	None			FMVSS glazing requirements do not address high-speed impacts with small objects such as bullets, birds or rocks.
	Large bus	None			FMVSS glazing requirements do not address high-speed impacts with small objects such as bullets, birds or rocks.
	Transport category commercial airplanes	Windshields in cockpit and supporting structures	Dynamic test	14 CFR: FAR 25.775	Glazing and supporting structure must withstand, without penetration, the impact of a four-pound bird with the airplane moving at a prescribed cruising speed. Penetration resistance of other windows in cockpit and passenger cabin are not addressed.

FAR: Federal Aviation Agency Regulation.

discussed FRA regulations and AAR standards. Emphasis is placed on design characteristics affecting longitudinal strength in frontal collisions. Strength levels of particular components and attachments are specified, but these strength levels need not be met throughout the structure. The only exception to this is the buff load requirement. Some standards require only a longitudinal strength test, while others require minimum levels of collision post strength, anti-climbing strength and truck attachment strength in addition to a longitudinal strength test.

5.1.2.2 Automobiles, Multipurpose Passenger Vehicles, Light Trucks, Large and Small Buses

Typical road motor vehicle accidents include rollover and front, rear, and side impacts with other road vehicles or roadside objects at a wide variety of angles and locations. In any of these cases the crash loads can be distributed or concentrated and may be applied symmetrically or asymmetrically relative to the vehicle structure. The structure of these vehicles must satisfy the same general crash energy management functions as that of their rail counterparts. Two different types of construction are employed to accomplish these objectives: body-over-frame structure and unibody structure.

The structure of most American-made full-size automobiles, multipurpose passenger vehicles, light-duty trucks and buses comprises three separate modules as shown (for the case of an automobile) in Figure 5-8a: body shell, frame, and front-end shell. The body shell and front-end shell panels are stamped from thin sheet metal of gauge thickness on the order of 0.9mm (0.035 in). During assembly, the separate panels are welded together and strengthened with the addition of stiffeners at strategic locations. Doors, windows, hood, trunk lid, etc. are added to complete the shell assembly. The body shell contains the occupant compartment, which is (with the exception of buses) a small fraction of the volume enclosed by intercity rail and mass transit vehicle compartments.

The chassis frame, shown in Figure 5-8b, serves as a carriage to which the engine, transmission, powertrain, suspension, and accessories are firmly attached. After these items are mounted on the frame, the assembly is mated with the body. The frame is called upon to crush and absorb a large portion of the energy of impact in certain accident modes.

The front-end sheet metal, which is mainly a protective cover for the vehicle powerplant and accessories, serves two important structural functions. First, it braces the front part of the frame to the body, thus enhancing the overall vehicle rigidity. Second, it absorbs a portion of the total kinetic energy in a frontal impact. This shell is assembled from stamped metal parts in a manner similar to that of the body shell. It is attached to both the body and frame structure.

The above-noted three structural modules are bolted together to form the overall vehicle structure, with coupling between the body and the frame accomplished through rubber grommets called body mounts. These mounts also serve to isolate higher frequency vibration from the body and provide most of the damping in the overall vehicle structure.

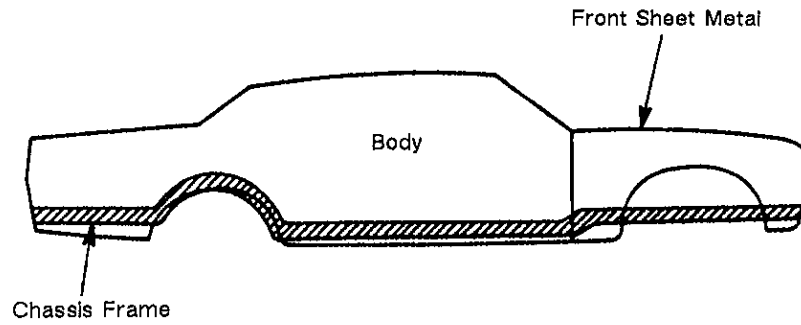

(a) SUBSTRUCTURES

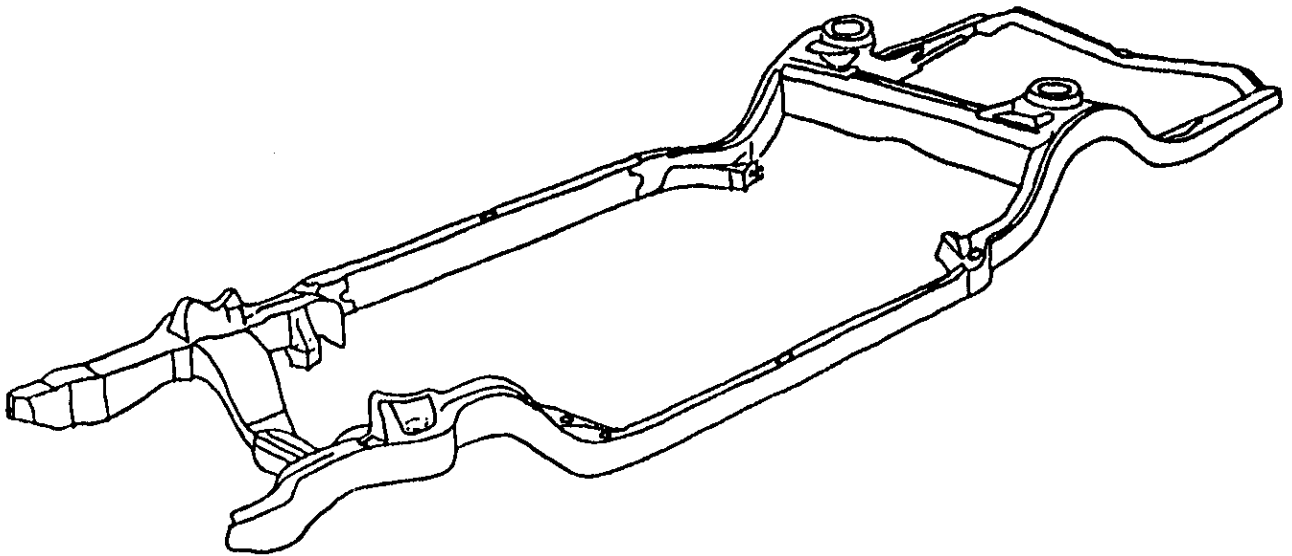

(b) CHASSIS FRAME

Figure 5-8 Typical Body-Over-Frame Automobile Structure

Most smaller automobiles (e.g., compact and subcompact sizes) built in the U.S. and overseas are constructed as a unibody module depicted in Figure 5-9. In these vehicles, the body, frame, and front sheet metal (except the outer front fenders) are constructed as a single structural unit welded together. Beam and column-like members that appear in the body-over-frame design are duplicated as an integral part of the unibody structure to provide the required structural stiffness and strength. This type of design is consistent with today's ever-increasing need to reduce motor vehicle weight and fuel consumption.

Motor vehicles universally incorporate stiff interfaces, consisting of substructures which are relatively resistant to deformation, into the body design. Such elements or systems, such as bumpers and door beams, help to prevent local penetration of an impacting object and spread the vehicle deformation over a broader region of the total structure. This enhances absorption of the collision energy with less critical damage to individual structural elements.

In 1965, the U.S. automobile industry granted \$10 million to the University of Michigan to establish the Highway Safety Research Institute. The following year brought the establishment of the Department of Transportation, the enactment of the Highway Safety Act and the National Traffic and Motor Vehicle Safety Act. This legislation provided for the enactment of Federal Motor Vehicle Safety Standards (FMVSS), which include regulations for accident prevention (the 100 series), injury protection (the 200 series), post-accident protection (the 300 series), consumer information, and others intended to help increase vehicle safety. All motor vehicles must demonstrate compliance with applicable FMVSS's in order to be sold and allowed to operate on U.S. roadways.

The 100-series standards provide specifications designed to prevent accidents. They focus primarily on vehicle components such as control systems, transmission, windshield, brake system, lamp and illumination devices, tires, etc. The 200-series and 300-series standards, which address occupant injury and post-accident protection, respectively, place a direct demand on the vehicle structure. The primary purpose of these requirements is to afford impact protection for occupants during and after a collision by:

- o reducing the likelihood of injury (FMVSS 201-205, 208, 210, 212, 214, 216, 219, 220, 221 and 222)
- o minimizing the possibility of occupants being ejected from the vehicle (FMVSS 205, 206, and 212)
- o ensuring sufficient strength of safety-related components (FMVSS 207, 209 and 210)
- o minimizing fire hazard (FMVSS 301 and 302)

It should be noted that the above standards pertain to both the exterior structure and occupant compartment interior components and systems. FMVSS 302, which specifies burn resistance requirements for compartment interior materials, is not addressed in this report.

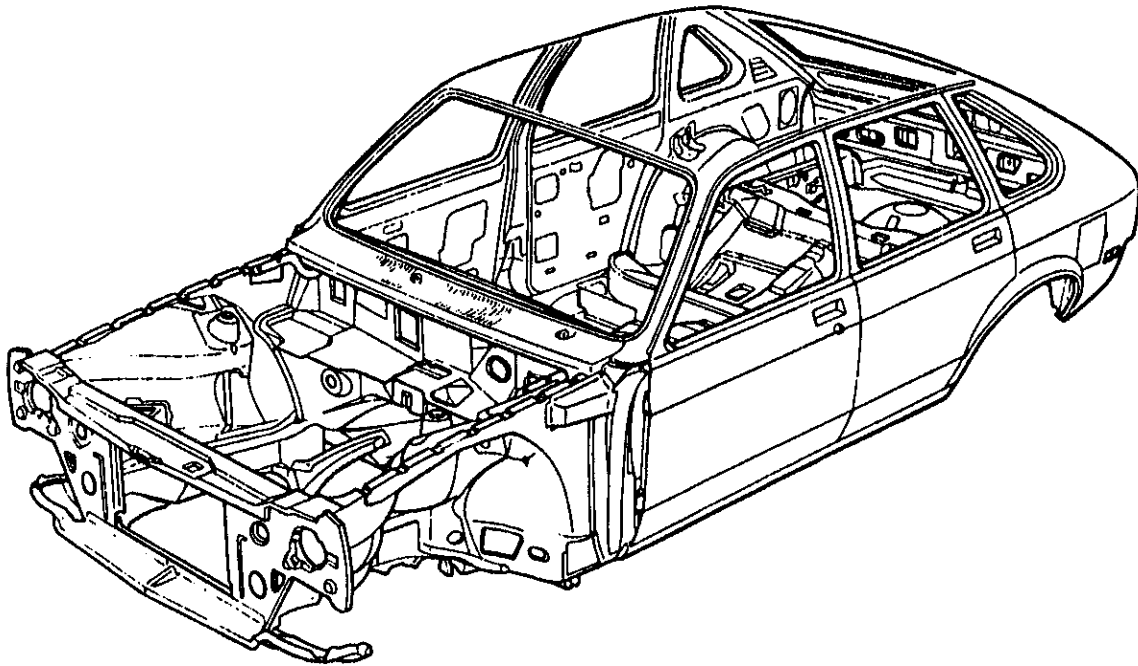

Figure 5-9 Typical Unibody Automobile Structure

The 200- and 300-series standards contain performance criteria which must be met by the designated structural components, systems, or the entire vehicle in specific evaluation tests. The loading conditions in all verification tests are fixed and a design is acceptable only if the corresponding measured responses comply with the specifications contained in the standard.

Motor vehicle exterior structure is covered by four sets of standards which can be grouped as follows: the overall vehicle structure, door components, glazing, and bumper system.(4) It should be noted that while such standards help ensure occupant protection in the event of a crash-related accident, motor vehicle compliance with direct measures of occupant survivability **per se** (i.e., via the use of instrumented dummies) resulting from a representative crash exposure is evaluated

⁴Exterior glazing is classified as "structure" under the broad interpretation of the term adopted at the beginning of this chapter.

in a separate, nonstructural performance standard, FMVSS 208. The test procedure stipulated by this standard is discussed in Section 5.3.

The ensuing paragraphs present an overview of the nature of the structure-related specifications and evaluation procedures contained in each of these divisions for automobiles, which must satisfy all of the listed standards. Most of these standards also apply to multipurpose passenger vehicles, light trucks, and small buses.

- o *Overall Vehicle Structure.* Federal Motor Vehicle Safety Standards which address overall vehicle structure specify structural requirements for the protection of vehicle occupants as a result of the primary collision and post-crash hazards stemming from fuel spillage. A listing of the nature of the requirements specified in these standards and the procedures employed to verify compliance with the specifications contained therein is presented in Table 5-5. Figures 5-10 and 5-11 illustrate the test setups employed for the FMVSS 214 side door strength and FMVSS 216 roof crush evaluations, respectively.

The static crush test procedures contained in FMVSS 214 reflects a first-approximation attempt to address side impact mode occupant compartment integrity requirements. It neglects the fact that both the striking and struck vehicles share the total kinetic energy that must be absorbed during the collision and fails to address the critical nature of the limited amount of crush space available in the side structure of motor vehicles. Beginning in 1993, the NHTSA plans to implement a full-scale crash test evaluation procedure for this impact condition. A new dummy with improved (relative to the Hybrid II and Hybrid III dummy designs) side impact biofidelity will be used in these future tests.

Similarly, the static crush test procedure delineated in the FMVSS 216 attempts, in a correspondingly approximate manner, to assess the structural resistance of the automobile roof to maintain at least a prescribed minimum occupant compartment survival space when in rollover crash mode.

- o *Door Components.* FMVSS 206 specifies the use of locking systems and prescribes static load requirements for door latches and door hinge systems to minimize the probability of occupants being ejected from the vehicle as a result of forces encountered in vehicle impact.
- o *Glazing.* FMVSS 205 addresses both the functional and crash safety aspects of glazing materials used in motor vehicles. As such, it specifies requirements to ensure a necessary degree of transparency in windows for driver visibility as well as to reduce the likelihood of occupants penetrating the windshield or other windows and/or suffering lacerations as a result of occupant/glazing contact during a crash. Compliance with the crash safety objectives of this standard is determined by means of dynamic component testing.
- o *Bumper System.* The purpose of Title 49, CFR: Part 581 is to prevent low-speed impacts from impairing the safe operation of a variety of frontal and rear vehicle functional systems and to reduce the possibility of override in intervehicular impacts. It specifies vehicle damage limitations for both full-scale, low-speed flat frontal and rear barrier impacts as well as for a series of low-speed bumper impacts by a pendulum test device.

**Table 5-5
FMVSS OVERALL AUTOMOBILE STRUCTURE PERFORMANCE REQUIREMENTS
AND EVALUATION PROCEDURES**

FMVSS No.	Requirements	Evaluation Procedure
204	Limits horizontal rearward dynamic displacement of the steering column	30 mph flat frontal barrier crash test
212	Specifies minimum windshield retention requirements	30 mph flat frontal barrier crash test
214	Stipulates requirements for crush resistance levels in side doors of automobiles to minimize the safety hazard caused by intrusion into the occupant compartment in a side impact accident	Side structure static crush test
216	Sets minimum strength requirements for automobile roofs to reduce the likelihood of roof collapse in a rollover accident.	Roof structure static crush test
219	Specifies limits for the displacement of exterior vehicle components into the windshield area	30 mph flat frontal barrier crash test
301	Specifies requirements for the integrity and security of the entire fuel system	Any one of the following crash tests (30 mph flat frontal barrier, 30 mph rear or 20 mph lateral impact by a rigid moving barrier device with a flat, vertical rectangular impacting surface) followed by a static rollover test

Note: Metric Equivalent

20 mph = 32 km/h
30 mph = 48 km/h

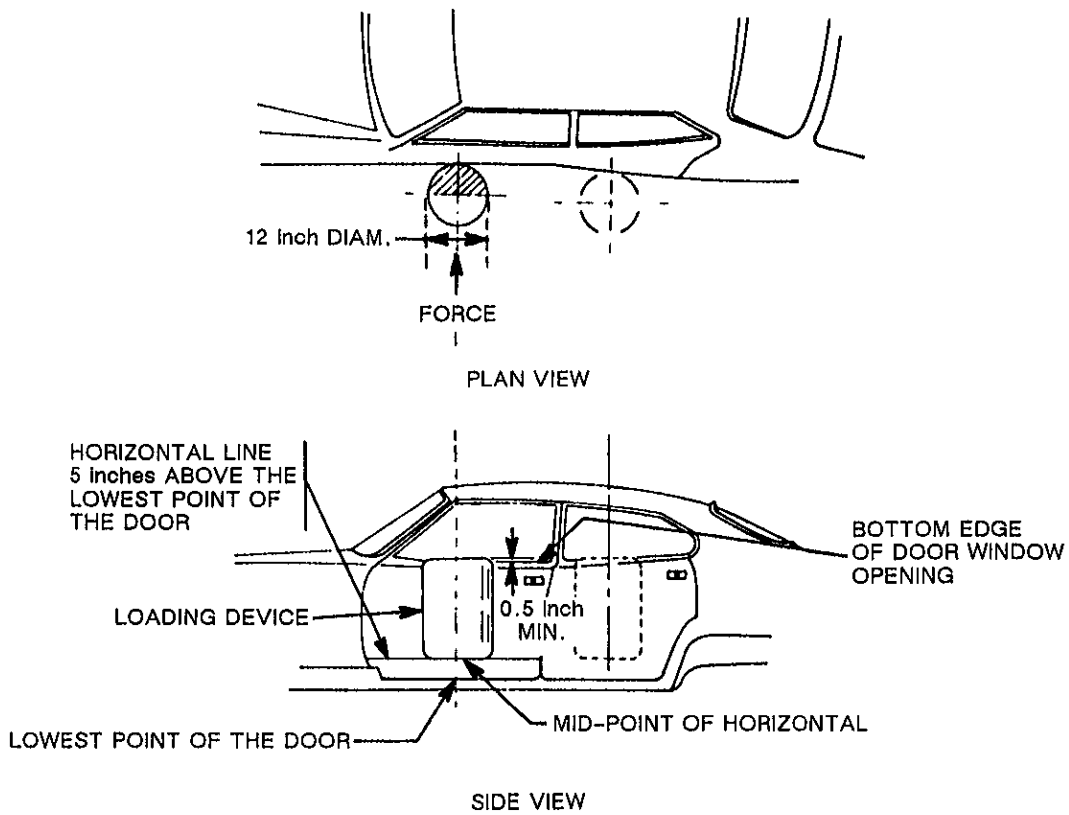

Figure 5-10 FMVSS Side Door Static Strength Test Setup

Note: Metric Conversion 1 inch = 25.4mm

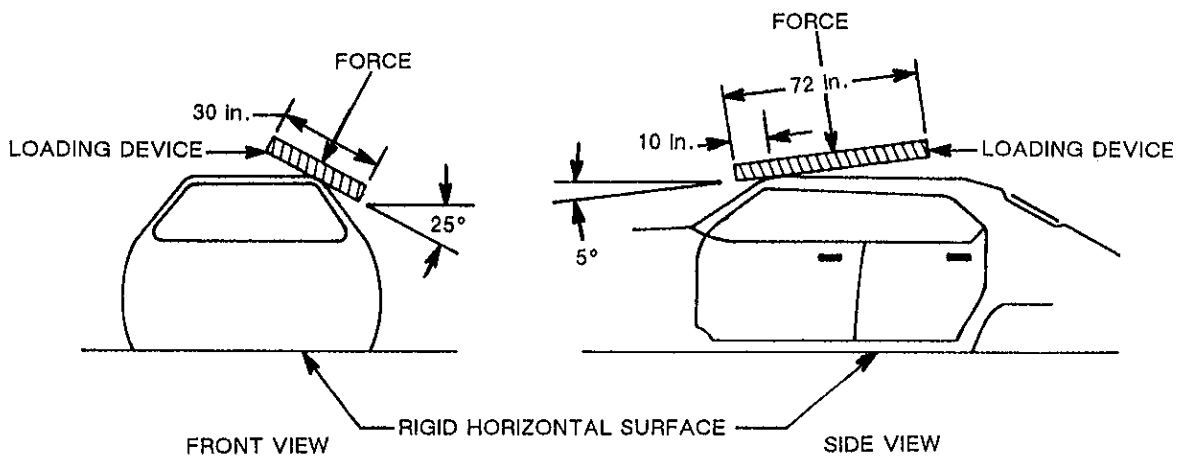

Figure 5-11 FMVSS 216 Roof Static Crush Test Setup

Note: Metric Conversion 1 inch = 25.4mm

Figure 5-12 presents an illustrated listing of Canadian motor vehicle safety standards for automobiles. As expected, they are very similar to the U.S. FMVSSs. (It should be noted that some of the standards listed in this figure are outdated; current Canadian standards more closely match those now in effect in the U.S.). A similar illustrated listing (also obsolete) for Canadian school buses is presented in Figure 5-13.

It should be noted that the specifications which govern automobile compliance with the overall vehicle structure crash safety-related FMVSSs address the need to dissipate large amounts of kinetic energy arising from vehicle impact. Moreover, the corresponding procedures prescribed therein to assess this compliance all use experimental techniques; such evaluations do **not** rely on analytical techniques.

5.1.2.3 Transport Category Commercial Airplanes

A very small percentage of flight accidents involving transport category commercial airplanes are survivable for a number of reasons: (1) the enormous kinetic energy levels usually present at the moment of aircraft impact, (2) practical weight-related constraints that preclude designing the aircraft structure to maintain its structural integrity and absorb such large amounts of impact energy for a multitude of possible impact configurations, and (3) the ever-present potential for fuel-related explosions and fires.

The U.S. Government has prescribed airworthiness standards for transport category airplanes under Title 14, Part 25 of the Code of Federal Regulations. Federal Aviation Administration Regulations (FAR) mandate that the structure of these craft satisfy certain operational design criteria relative to fatigue, damage-tolerance, and glazing requirements. Occupant compartment integrity requirements address two situations: (1) windshield resistance to impact by a four-pound bird with the airplane moving at a prescribed cruising speed (FAR 25.775), and (2) overall structural integrity relative to prescribed minimum acceleration levels to ensure occupant survival in a minor, survivable crash landing (FAR 25.561). Such accidents usually occur near an airport at flight path speeds below 150 knots (173 mph) and vertical descent rates of less than 20 feet per second [5.6]. These conditions are normally associated with landing and take-off operations such as landing short, hard landings, overruns, and skidding off the runway. Other non-landing-type impacts are not addressed in the FARs.

The Federal Aviation Administration recognizes that a well-designed seat can provide occupant protection in certain transport aircraft accidents if adequate compartment integrity and survival space is maintained, occupants are restrained and the average acceleration profile sustained by the compartment does not exceed human tolerance levels. Seat performance requirements for these vehicles are described in Section 5.2.2.2.

As noted in Table 5-4, selected regulations permit unspecified analytical techniques to be used as an alternative to static or dynamic testing of aircraft structure. This option is, however, subject to a caveat which states: "structural analysis may be used only if the structure conforms to that for which experience has shown this method to be reliable (FAR 25.307)." Another regulation (FAR 25.571) requires that fatigue and damage-tolerance evaluation of specified portions of the aircraft structure be performed by an "analysis, supported by test evidence."

5.2 VEHICLE INTERIOR FEATURES

It should be apparent that occupant survivability in transport vehicle accidents is a function of a finely tuned blend of the impact attenuating performance exhibited by both the vehicle structure and the occupant compartment interior. Assuming that the vehicle structure does its job, the compartment interior must be designed to minimize the consequences of often unavoidable (especially for vehicles not equipped with occupant restraint systems) secondary collisions of vehicle occupants within the confines of this protective shell. This section will highlight compartment interior design features of the transport vehicles surveyed in this report and note existing design and performance requirements mandated by current rules, regulations, standards, or accepted industry practice. Critical performance issues not addressed by these guidelines will also be cited.

5.2.1 Mass Transit Vehicle and Intercity Passenger Coach Interior Features

In many respects, the interior configuration and design of North American mass transit vehicle and intercity passenger coaches are very similar. Accordingly, their features will be reviewed simultaneously in the initial portion of this subsection. For the most part, the interior design rationale emphasizes passenger comfort and functional considerations, rather than crash safety performance. Minimal or no surface padding is used to cover potential occupant contact areas and no occupant restraints are provided. Moreover, the large compartments of these vehicles render their occupants, who are free to assume a multitude of configurations within this space, especially vulnerable to life-threatening secondary collisions (see general discussion in Section 2.2.2). The problem is particularly acute for mass transit cars, which accommodate a large number of standing occupants whose only means of support during an accident is a stanchion or a handhold.

Previous studies (e.g., [5-7 and 5-8] have identified many of the more notable mass transit and intercity passenger car interior design hazards and presented suggested countermeasures to mitigate the level of crash-related injury. However, only limited action has been taken by the railroad industry to implement these recommendations.

The interior of current North American mass transit vehicles basically reflect circa 1970 state-of-the-art design features found in the New York City R-44 subway system, the Bay Area Rapid Transit (BART) district, and the Massachusetts Bay Transportation Authority Silverbird cars. Seats in these vehicles are constructed with a framework of metal and/or fiberglass and are either left unpadded or covered with vinyl-enclosed foam padding. They are arranged to provide forward-, aft- or center aisle-facing seating for the vehicle occupants. Mass transit cars contain numerous stanchions and/or handholds attached to the roof or seats to accommodate standing occupants.

The motion of mass transit and intercity passenger car occupants in a train accident is a function of the type of car they are in and the location of the car within the consist, their position in that car and their orientation and alertness. As discussed in Section 2.2.2, the initial conditions of occupant/interior secondary collision, the contour and force-deflection characteristics of the compartment interior surface, and the body regions that are impacted govern the severity of those contacts that occur. The compartment interior of these vehicles contain many features with hard

Canada Motor Vehicle Safety Standards

Numbers in parentheses are the reference numbers for each of the Safety Standards.

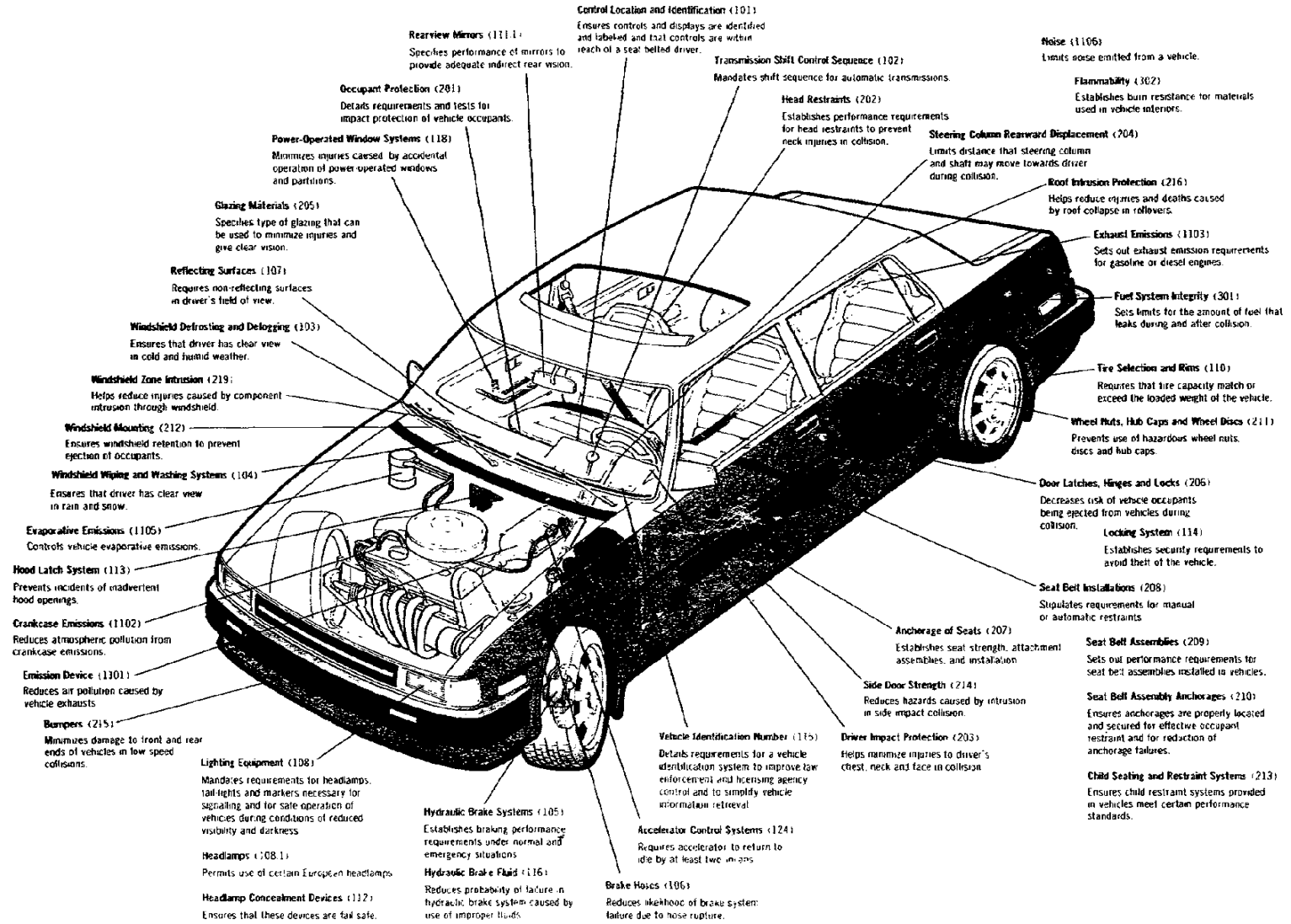

Figure 5-12 Transport Canada Motor Vehicle Safety Standards for Automobiles (Illustration courtesy of Transport Canada)

Canada Motor Vehicle Safety Standards

Numbers in parentheses are the reference numbers for each of the Safety Standards.

5-37

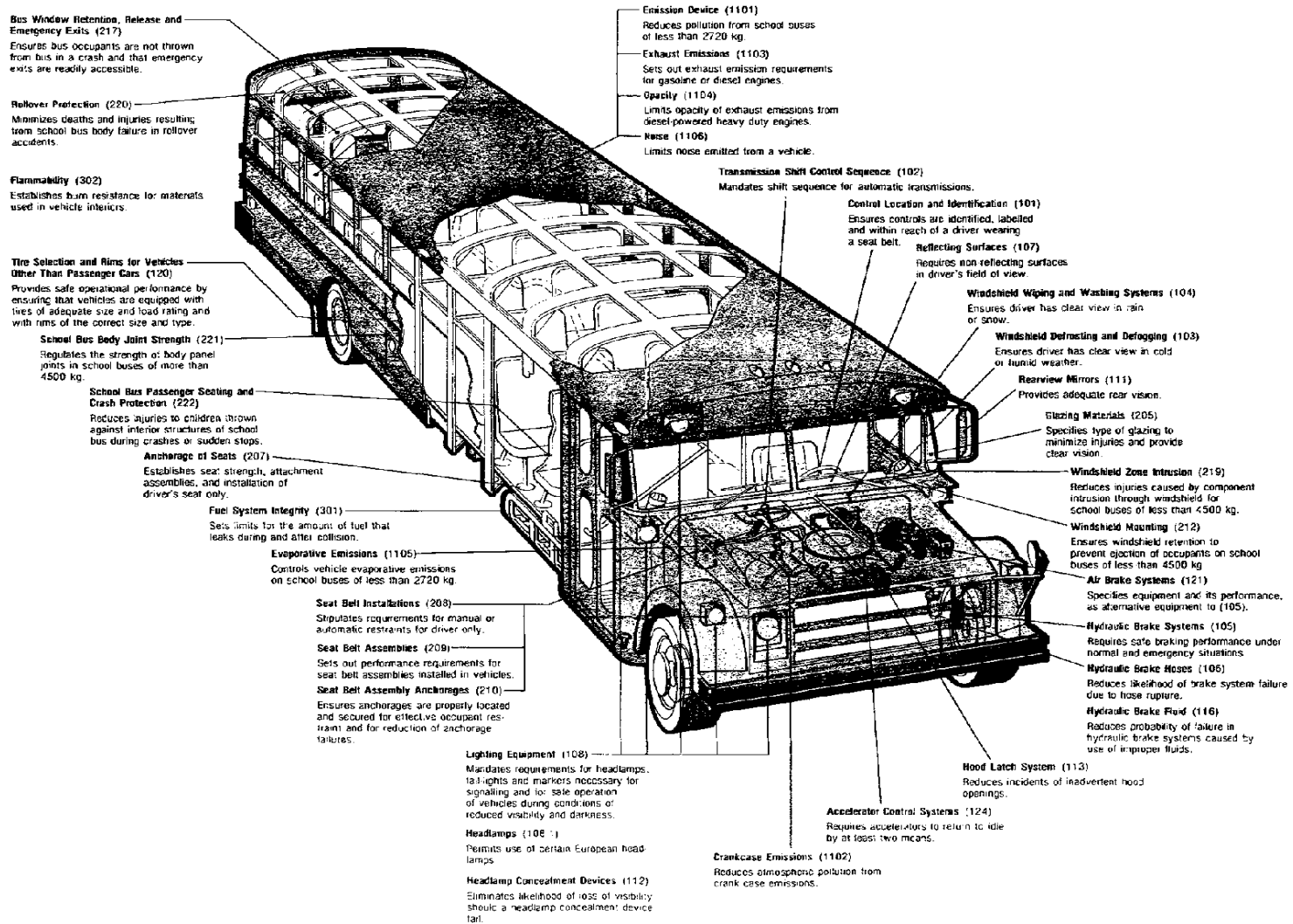

Figure 5-13 Transport Canada Motor Vehicle Safety Standards for School Buses (Illustration courtesy of Transport Canada)

(i.e., low energy absorbing) surfaces which can produce severe occupant injuries during these collisions. These features and their potentially hazardous design shortcomings are described below for typical intercity passenger cars operated by Amtrak. Some limited information is also given for the interiors of passenger coaches used in three European HSGGT consists.

- o *Seats.* Current Amtrak passenger coaches offer a variety of seating options depending on travel class and type of route traveled (i.e., short- or long-distance). For example, on short-distance routes, conventional coach cars provide a pair of well-cushioned, reclining seats on each side of the center aisle. Open baggage racks are located above the seats on both sides of the car. Seats on Amfleet and Turbo coach cars also feature aircraft-style, fold-down trays which fold out from the back of each seat. On long-distance routes, Amfleet II coaches have seats designed for overnight travel. As such, they feature fold-down trays, foot rests, and leg rests which fold out from beneath each seat. Figures 5-14a and 5-14b depict Amtrak passenger coach seating for short-distance and overnight trains, respectively. Heritage coaches, also designed for overnight travel, contain seats equipped with padded head rests and leg rests.

The majority of seats in passenger coaches face forward, probably because this orientation is preferred by the passengers. Seats can often be rotated through 180 degrees when the vehicle changes direction. Some vehicles, however, contain selected seat configurations which face each other. This arrangement constitutes a particularly dangerous situation in a train-to-train collision because of the high possibility of occupant-to-occupant collision. One of the occupants would be retained by the seat and subsequently struck by the translating, unrestrained facing occupant. Both occupants would probably incur more serious injuries than for the case in which they were both facing in the same direction.

Seats that are designed to face the center aisle pose a similar problem in an accident. An unrestrained occupant would be propelled out of his seat in most accident configurations, resulting in contact with an interior surface or another occupant at a high relative velocity.

Figure 5-15 shows the interior configuration of an Amtrak lounge car with seats oriented in this manner. Numerous occupant trajectories and subsequent hard contacts are possible during an accident for this interior arrangement.

Standing occupants in a relatively open area of a passenger car are particularly vulnerable to injury during a train accident. A number of interior components can be impacted, e.g., tables, seats, doors, walls and baggage racks. Contact with other standing or seated occupants is also possible.

National Transportation Safety Board (NTSB) railroad accident reports have indicated that the seats used in current North American intercity passenger vehicles contain a number of crash safety-related design deficiencies. (Reference [5-9] presents vivid documentation of such deficiencies in the recent, disastrous collision of an Amtrak passenger train with a three-locomotive Conrail consist at about 170 km/h [105 mph] which resulted in a total of 16 dead and 174 injured for the two trains. All of the fatalities and 172 of the injured were on board the Amtrak train.) They have a tendency to undergo undesired rotation or become detached from their floor mounting points during an accident, exposing their occupants to additional



(a)



(b)

injury risk or entrapment. It is possible that such displaced seats could even block the aisle, hindering occupant egress from the car and/or rescue efforts. In addition, seat cushions are particularly prone to separate from the supporting framework during an accident, exposing occupants to potential contact with hard and/or sharp surfaces.

The seats of existing passenger coaches also constitute a potential safety hazard during an accident in which floor/seat and seat framework/cushion integrity is maintained. For example, in a forward collision, a seated, forward-facing, unrestrained passenger would be propelled into the seat back in front of him. Such contact with seat backs not properly designed to cushion the impact and allow the occupant to ride down the collision could cause serious injury. The lower legs of the unrestrained occupant could also become entrapped beneath the



Figure 5-15 Amtrak Lounge Car Interior

frame of the seat opposite him during certain accident configurations, causing serious lower extremity injuries and compromising efforts to evacuate the vehicle after the crash.

- o *Lounge and Food Service Cars.* Amtrak has a number of different food service and table-equipped cars on various routes throughout the U.S. A typical lounge car interior, shown in Figure 5-15, is equipped with tables and seats arranged to provide face-to-face (fore-aft), sidewall- and aisle-facing seating configurations. Standing occupants are prevalent in these, as well as in other food service cars operated by Amtrak. Figures 5-16a and 5-16b depict the interior layout of their cafe and buffet-style dining cars, respectively. These cars contain a variety of counters used for food preparation and display and standup-eating.



(a)



(b)

Figure 5-16 Amtrak Café and Buffet-Style Dining Car Interiors

The latter car also contains tables for sit-down eating. Figure 5-17 shows a typical Amtrak dining car interior. Such cars offer sit-down meal service akin to an actual restaurant.

All lounge and food service cars present an environment highly conducive to serious injury in the event of a train accident. This assessment is based on the relatively wide open spaces between tables and seats, coupled with the aforementioned variety of seating configurations



Figure 5-17 Amtrak Dining Car Interior

and the greater probability (compared to the coach compartment) of standing or walking occupants. As noted in [5-9], the presence of unsecured food preparation appliances (e.g., a microwave oven) and utensils as well as miscellaneous loose items on counters and tables aggravates an already potentially dangerous scenario.

- o *Sleeping Accommodation Cars.* Amtrak operates overnight trains which include sleeping cars and slumbercoaches. Both of these cars, which carry normal seating in closed compartments during the day, convert to sleeping accommodations at night. Two types of sleeping accommodations are offered in the sleeping cars: roomettes and bedrooms. The slumbercoaches offer seating and beds for either one or two occupants.

A typical Amtrak roomette is designed for one adult. By day, it features an easy chair and by night, a bed that folds out of the wall. Lavatory facilities are provided within the compartment. (To use the toilet at night, the bed must be raised.)

An Amtrak bedroom, shown in its day and night configurations in Figure 5-18a, is designed for two adults, or one adult and two children. One type of bedroom contains two chairs while another contains a sofa. Sleeping facilities in both models consist of one lower and one upper single bed, both of which also fold out of the wall; the upper berth is accessed by use of a



HERITAGE BEDROOM/DAY



HERITAGE DOUBLE SLUMBERCOACH/DAY



HERITAGE SINGLE SLUMBERCOACH/DAY



HERITAGE BEDROOM/NIGHT



HERITAGE DOUBLE SLUMBERCOACH/NIGHT



HERITAGE SINGLE SLUMBERCOACH/NIGHT

(a)

(b)

(c)

Figure 5-18 Typical Amtrak Passenger Car Sleeping Accommodations

ladder. Each bedroom is equipped with its own private lavatory facilities. The use of a sliding partition enables two bedrooms to be combined into a suite for families or groups of four adults.

Amtrak double slumbercoach compartments are approximately the same size as a roomette, but considerably smaller than a bedroom. They are equipped with two seats as well as fold-out lower and upper berth sleeping accommodations for two adults. A smaller, single slumbercoach compartment, with one seat and one bed, is also available. Both slumbercoach accommodations also have their own private lavatory facilities, which are accessible when the lower berth is lowered. Figures 5-18b and 5-18c depict these two types of overnight accommodations in their day and night configurations.

Because all of the overnight type of cars basically zone off the large volume inside them into smaller areas, they provide significantly improved occupant containment relative to the other types of passenger cars in a train. However, this advantage is offset by the nearby presence of potential hard contact surfaces such as the toilet and sink fixtures as well as unsecured personal baggage in the same room. In addition, a person lying in an upper berth could suffer serious injuries if he/she were ejected from the bed during an accident.

- o *Barriers.* Barriers or internal walls located in the occupant compartment of passenger cars are generally composed of a structural frame covered with light gauge sheet metal. These partitions are not currently designed to comply with any deflection or energy absorption criteria and consequently could cause serious occupant harm if contacted during a secondary collision. Figure 5-15 depicts typical interior walls in an Amtrak lounge car.
- o *Baggage Storage.* Baggage racks found in passenger coaches are basically **open shelves** cantilevered off the sidewall which run the full length of the car, just above the seated passengers. Reference [5-9] notes that unsecured items placed on these racks can be launched during an accident, causing serious injury to impacted coach occupants. Fallen baggage rack contents can also pile up near an exit, impeding occupant egress from the vehicle.
- o *European Intercity Passenger Coach Interior Features.* A limited amount of information was obtained regarding the interior systems of European intercity passenger train vehicles. The French TGV Atlantique HSGGT system offers a variety of interior configurations which appeal to passenger comfort and convenience. For example, typical Atlantique coaches offer at least three varieties of seating layouts: first class "club" seating (Figure 5-19a), first class ordinary seating (Figure 5-19b) and a first class end vehicle cabin for group accommodation (Figure 5-19c). Figure 5-20 depicts a second class cabin with a children's play area.

As is the case with their North American counterparts, the TGV passenger cars provide some face-to-face seating configurations, exposing their occupants to the hazards discussed earlier. Moreover, compartment walls, roof and barriers are not designed to absorb occupant kinetic energy in secondary collisions. It is not known if the seats can withstand impact loading without the cushions separating from the underlying structure.



(a)



(b)

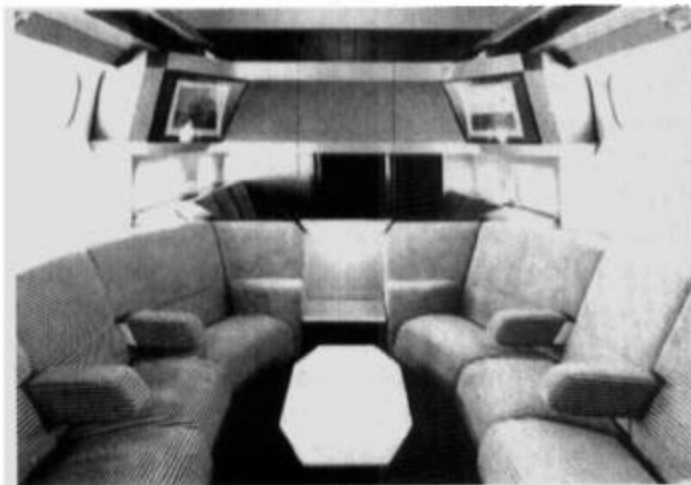

(c)

Figure 5-19 Typical TGV Atlantique Train Passenger Car Interior Configurations

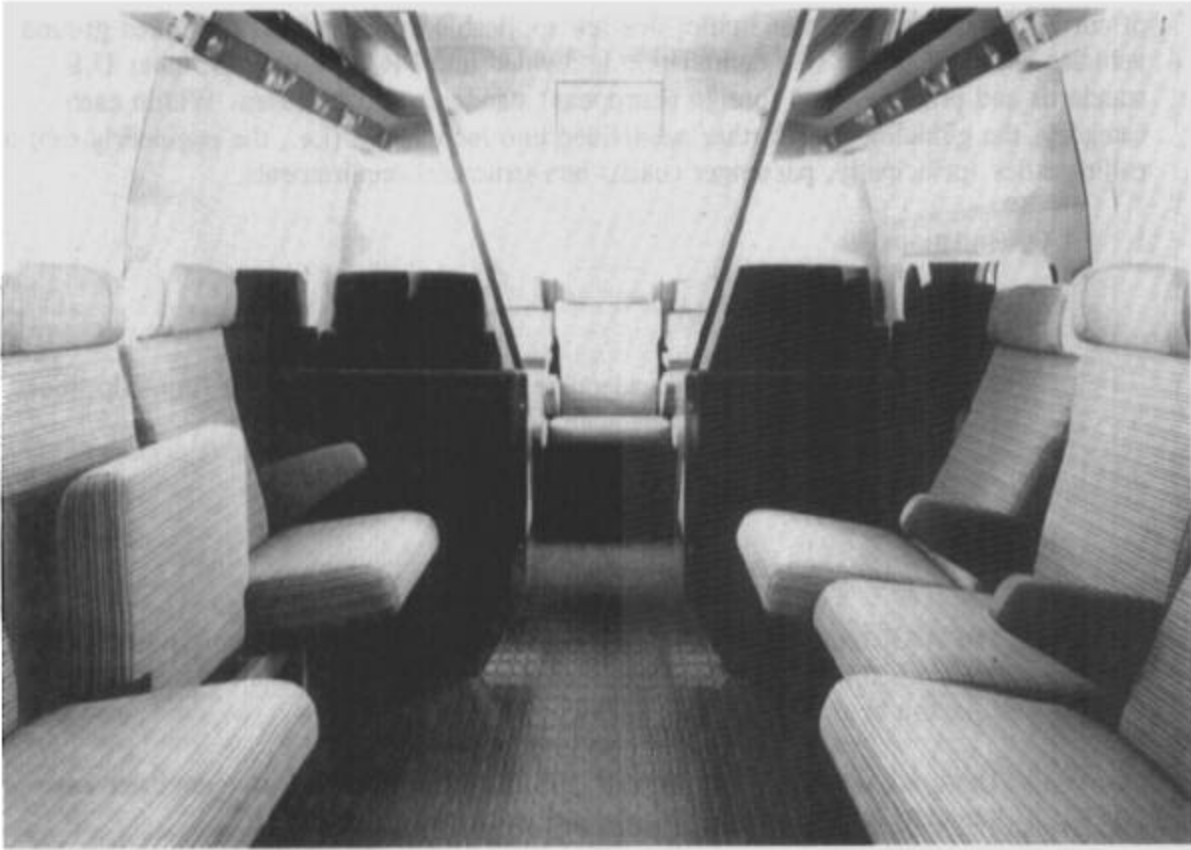

Figure 5-20 TGV Atlantique Train Passenger Car Second Class Cabin with Children's Play Area

The passenger coaches of the German Intercity Experimental (ICE) HSGGT system offer similar varied seating accommodations. These cars are equipped with some of the interior safety features currently lacking in North American passenger train consists. Aircraft-style, **closed** overhead baggage bins are used and the walls and roof of these vehicles are padded with a nonflammable foam and injection plastic material. However, face-to-face seating is also employed in some interior layouts and table edges appear to be unpadded.

Finally, it should be noted that baggage racks in passenger coaches of the Swedish X2000 HSGGT system are designed with a lip approximately 75mm (3 in) high. This feature reflects an obvious attempt to address the above-noted baggage retention issue.

- o Current Rail Vehicle Interior Regulations, Standards and Rail Industry Practices. A summary of current guidelines and past studies that are applicable to the interior of guided ground vehicles is listed below. This compilation is divided into FRA regulations, other U.S. standards and practices, and foreign (European) standards and practices. Within each category, the guidelines are further subdivided into locomotive (i.e., the engineer's cab) and rolling stock (principally, passenger coach) non-structural requirements.

1. FRA Regulations

- o Locomotive (Engineer's Cab)

- Paragraph 229.119 requires adequate door and seat fastenings, non-slip floors, good general tidiness and adequate heating and ventilation.

2. Other U.S. Standards and Practices

- o Locomotive (Engineer's Cab)

- The AAR requires all cab interior fittings and surfaces to be provided with rounded corners and be otherwise designed to minimize the risks of injury should a person be thrown against them.
 - There are detailed AAR strength requirements for locomotive engineer seats and the attachment of the seat to the locomotive structure.
 - There is growing interest in the "comfort cab" in the U.S. freight railroad industry. This design provides an ergonomically designed control console, as well as improved temperature control, and noise and vibration insulation. These and other features are intended to provide a much improved working environment for the engineers, leading to a reduced risk of engineer error-caused accidents.
 - An extensive government/industry research program has studied cab crashworthiness. The results of this work are now being implemented in cab design, including the comfort cab and enhanced strength of the cab structure to reduce the amount of gross crushing in an accident.

- o Requirements for Rolling Stock Fittings and Equipment

The AAR Manual of Standards and Recommended Practice, Section A, Part III, specifies the following:

- _ Sliding doors only shall be used. In spite of this, outwardly opening exterior doors are acceptable to most operators. **Inwardly** opening doors are definitely not acceptable, because they can prevent escape in an emergency.
- _ A wrecking tool cabinet must be provided, with an axe and a sledgehammer.
- _ A conductor's brake valve, which can be used to initiate braking in an emergency, should be provided in each car.
- _ In addition, Amtrak requires that the attachments of car interior fittings to the structure, including seating, partitions, baggage racks, etc. be designed to withstand the following accelerations:

Longitudinal:	6 g's
Vertical:	3 g's
Lateral:	3 g's

3. Foreign Standards and Practices

o Locomotive (Engineer's Cab)

UIC Code 617-5 OR presents detailed requirements for engineer's cabs. The principal provisions are:

- Sharp edges, etc., must be avoided to minimize injuries should the cab occupants be thrown against cab internal fittings and surfaces.
- All heavy locomotive components inside the body must be secured to the body structure so that they can sustain longitudinal accelerations of 3 g's.
- Proper protection must be provided against accidental contact with high-voltage electrical equipment, hot surfaces, etc.
- An unimpeded emergency passage must be provided to the opposite end of the vehicle.
- Console-type controls and consideration of human factors in the design of controls and instruments is standard practice.

o Requirements for Rolling Stock Fittings and Equipment

UIC Code 566 OR requires the following:

- _ Car component attachments must withstand the following accelerations:

Longitudinal	5 g's
Vertical:	3 g's
Lateral:	1 g

- A "proof" safety factor (against deformation) of 1.5 should be used in design. It should be increased to 2.0 for components accessible to passengers as a precaution against damage by vandals.
- Overhead baggage racks must withstand a loading of 2000 N/m (137 lb/ft) plus 850 N (191 lb) concentrated at any point on the front edge.

UIC Code 560 OR contains many requirements concerning doors, handrails, stops, etc. Some of the most significant are:

- Exterior doors are automatically closed and locked at speeds exceeding 5 km/h (3.1 mph).
- Doors must have a pressure-sensitive edge and be programmed to open for a short period (10 seconds) when obstructed in order to prevent accidental entrapment.
- Automatic doors must have an emergency means for opening them manually from both inside and outside the car.
- Use of automatically operated sliding-plug doors is becoming universal on European rail systems.

It should be noted that draft Canadian passenger rail car regulations require closed, aircraft-style overhead baggage bins, and that heavy baggage be segregated from seating areas and stored in racks provided with longitudinal and lateral restraints meeting the following acceleration requirements:

Longitudinal:	5 g's
Lateral and vertical:	3 g's

Seat-to-vehicle attachments must meet the same acceleration requirements when occupied by 83.5 kg (185 lb) passengers.

It is of interest to note that current North American and European rail vehicle regulations, standards and industry practices fail to address most of the issues involved in protecting occupants in passenger cars from the effects of secondary collisions within the compartment.

5.2.2 Vehicle Interiors in Other Transportation Modes

It should be noted that commercial transport category airplanes accommodate only seated passengers, eliminating the aforementioned problems associated with standing passengers. Seats are high-backed and well padded, and face in the same (forward) direction. In addition, all carry-on luggage must be stowed beneath the seat or in an enclosed area at the front of the airplane. Other lighter-weight items are placed in enclosed overhead luggage compartments. A lap belt is provided for use during takeoffs and landings and in turbulent air conditions.

The interior configuration of an automobile, multipurpose passenger vehicle and light truck is radically different from that of mass transit or intercity passenger coach vehicles. Occupants of these road vehicles must remain seated in a small compartment and are provided with belt (and possibly airbag) restraint systems. Moreover, the surrounding compartment surfaces have been designed to be "friendly" (i.e., exhibit a smooth contour and have a high energy absorption capacity) in an effort to minimize occupant injury in the event of occupant/interior contact during an accident. Conversely, most buses display many of the interior characteristics found in mass transit vehicles and intercity passenger coaches, most notably, a large compartment, the absence of restraints, aisle-facing seats and the potential for standing/walking occupants. Seat integrity requirements, however, are mandated for all buses by a Federal Motor Vehicle Safety Standard (FMVSS). In addition, school buses must comply with other protection requirements for the occupants of compartment interiors stipulated by another FMVSS.

Selected motor vehicles and commercial transport category airplanes were briefly examined in an effort to determine what types of measures are taken to achieve compliance with previously discussed compartment interior crash safety performance objectives and to ascertain the methods used to assess such compliance. Noteworthy design features and current regulatory codes governing the performance of compartment interior systems in each type of vehicle will be briefly reviewed in the remainder of this section.

5.2.2.1 Automobiles, Multipurpose Passenger Vehicles, Light Trucks, Large and Small Buses

The interior design of automobiles, multipurpose passenger vehicles, light trucks and large and small buses must meet performance requirements mandated by Federal Motor Vehicle Safety Standards. Automobiles, multipurpose passenger vehicles, and light trucks must demonstrate compliance with all of the compartment interior performance requirements contained in these FMVSSs, while their applicability to buses is based on vehicle weight. These standards, along with the procedures employed to verify compliance with the specifications contained therein, are listed in Table 5-6. It is of interest to note that the procedures employed to evaluate this compliance are all experimental; *no* analytical techniques are used.

One safety standard formulated specifically for school buses, FMVSS 222, is concerned with reducing the number of deaths and the severity of injuries that result from the impact of unrestrained occupants against surfaces within the bus during crashes and sudden driving maneuvers. It stipulates that all passenger seats be forward facing and that they comply with a variety of specifications. Seat back height and surface area requirements are defined and maximum limits for seat back deflection in the fore and aft directions are prescribed under static loading. In addition, seat back force-deflection response must fall within an acceptable envelope when loaded statically in the forward and rearward directions. The standard also stipulates that seat cushions should not separate from their supporting structure under a prescribed static loading.

**Table 5-6
FMVSS Small-Volume Compartment Motor Vehicle Interior Performance
Requirements and Evaluation Procedures**

FMVSS No.	Requirements	Evaluation Procedure	Applicability of Standard to Large-Compartment Motor Vehicles
201	Specifies compartment interior door closure requirements and cushioning characteristics for compartment interior surfaces frequently contacted by occupants during a crash	30 mph flat frontal barrier crash test and static and dynamic component tests	Applicable only to the area surrounding the driver of buses weighing 10,000 lbs or less
202	Specifies requirements for head restraints to reduce the frequency and severity of neck injuries in rear-end and other collisions	Static component test	Applicable only to the seats of buses weighing 10,000 lbs or less
203	Prescribes requirements for collapsible steering systems in an effort to reduce driver chest, neck and facial injuries in frontal impacts	Dynamic component test	
207	Establishes requirements for seats, their attachment assemblies and their installation in order to minimize the possibility of failure as a result of forces acting on the seat during a collision	Static component tests	
209	Specifies requirements for all components comprising seat belt systems, including webbing, buckles and all other hardware	Static component tests	Seat belt installation is mandated only for the driver seating position of buses weighing 10,000 lbs or less
210	Prescribes requirements for seat belt assembly anchorages to ensure effective occupant restraint and reduce the likelihood of failure in collisions	Static component tests	Seat belt installation is mandated only for the driver seating position of buses weighing 10,000 lbs or less

Note: Metric Equivalent

10,000 lb = 4536 kg

A restraining barrier must be provided in front of every seat which does not have the rear surface of another passenger seat directly in front of it within a specified zone. Barrier position, surface area, maximum allowable deflection, and force-deflection characteristics must comply with specifications. The latter two responses are again measured via static testing.

Head and leg protection zones are also defined for each bus passenger seating position. Test results generated in a dynamic component test using an instrumented head body form must comply with specified HIC as well as energy absorption and force level/distribution requirements. A similar test using an instrumented knee form must also demonstrate compliance with force level and distribution specifications.

FMVSS 222 constitutes an example of how the non-belt occupant retention concept mentioned in Section 2.2.2 can be implemented in a large compartment. Unfortunately, as noted in that section, it provides adequate occupant protection only for collinear-type collisions. The absence of suitable lateral and vertical occupant restraint renders such measures virtually useless against other accident configurations such as side impact or rollover.

5.2.2.2 Transport Category Commercial Airplanes

In certain survivable crash landing scenarios, the aircraft structure beneath the occupant compartment can undergo substantial permanent deformation and thus dissipate some portion of the impact kinetic energy. If the above conditions are met, occupant egress is of utmost importance once the airplane skids to a stop. The seats must be designed to remain attached to the compartment floor; they should not translate, rotate, or collapse to the extent that they trap their occupants or block the aisle.

The FAA requires all commercial transport category (as well as all other) aircraft to be equipped with seats that can withstand prescribed dynamic loads even with distorted floor attachment geometry. According to FAR 25.785, "Each seat, berth, safety belt, harness and adjacent part of the airplane at each station designated as occupiable during takeoff and landing must be designed so that a person making proper use of these facilities will not suffer serious injury in an emergency landing as a result of inertia forces specified in FAR 25.561 and 25.562." Under the latter regulation, each seat design is evaluated by means of sled testing, which simulates the compartment acceleration environment for prescribed emergency landing conditions. Instrumented Hybrid II 50th percentile male dummies are used in these tests.

FAR 25.787 and 25.789 specify requirements for stowage compartments (including **enclosed** overhead compartments) and for the retention of fixtures that are part of the airplane design in the passenger and crew compartments and the galleys. Specific procedures to evaluate such compliance are not given in these regulations.

5.3 OCCUPANT SURVIVABILITY STANDARDS AND REGULATIONS

The predominant option employed for the evaluation of the motor vehicle occupant survivability requirements stipulated by FMVSS 208 consists of a nominal 48 km/h (30 mph), 90-degree frontal impact of the vehicle against a flat, rigid barrier.⁽⁵⁾ Rigorous test conditions must be met, including compliance with tight tolerances for vehicle impact speed and angle. This impact is equivalent to (with respect to vehicle damage and energy absorption) a 96 km/h (60 mph) head-on frontal collision with an identical, stationary vehicle or a collision between two identical vehicles moving toward each other at 48 km/h (30 mph).⁽⁶⁾ The 48 km/h (30 mph) barrier impact speed is felt to constitute a particularly severe crash condition representative of serious injury-producing vehicle impacts which occur in an urban setting.

Table 3-4 of Chapter 3 summarized the content of FMVSS 208. These requirements are applicable to the two outboard-position front seat occupants (i.e., the driver and the right-front passenger) of automobiles, multipurpose passenger vehicles, and light trucks, and to the driver only of small buses. The standard does not apply to any occupants of large buses. As alluded to in Table 3-4, the vehicle manufacturer has the option of using either (or a combination of) Hybrid II or Hybrid III instrumented 50th percentile male dummies in this full-scale crash test evaluation.⁽⁷⁾

It is of interest to note that as of this date, a single, full scale crash test still serves as the only direct dynamic measure of motor vehicle occupant survivability (through comparison of dummy-registered values of occupant injury indicators relative to thresholds stipulated by FMVSS 208) despite the fact that side impacts and rollovers also constitute a large source of casualties for occupants of these types of vehicles. (As discussed in Section 5.1, other FMVSSs examine the structural crashworthiness *per se* of a motor vehicle.) Moreover, it is recognized that most severe frontal motor vehicle accidents produce concentrated loadings on the vehicle front structure, in direct contrast to the distributed loading imparted in an FMVSS 208 flat barrier collision. (As noted in Section 2.2.1, concentrated impact loads can produce substantial localized occupant compartment crush, severely compromising the safety of its occupants.) Thus the frontal flat barrier crash test signature and corresponding vehicle collapse mechanism is really not representative of their real counterparts from the full range of motor vehicle accidents.

These limitations are offset by the fact that the flat barrier impact constitutes a highly repeatable, relatively simple test condition that can be readily performed by vehicle manufacturers and independent vehicle safety research organizations. As such, it constitutes a practical attempt to quantitatively assess the crashworthiness of such vehicles for at least one statistically significant direction of impact. Other test conditions such as noncollinear car-to-car impacts are subject to greater variation with respect to initial impact conditions. Still others, most notably, rollover, are

⁵The barrier is essentially a rigid wall complying with construction specifications delineated by SAE International (the former Society of Automotive Engineers, Inc.).

⁶This equivalence is valid only for the case of no vehicle override during the collision.

⁷The kinematics and injury indicator measurements exhibited by the two dummies differ somewhat. In some cases one dummy type will demonstrate compliance with all the requirements of the standard while the other type will not.

inherently *nonrepeatable*, with no one test protocol yet deemed totally acceptable. Moreover, the flat barrier crash test is consistent with accepted, available human injury criteria which, as noted in Chapter 3, have been developed primarily for the fore-aft direction of impact.

While certain other frontal impacts such a rigid pole and an angled barrier test are still feasible within the constraints imposed by the limited nature of accepted occupant injury criteria, questions can also be posed regarding the validity of these test conditions relative to their real-world counterparts. Thus the expense of performing such additional crash tests cannot be justified when it is realized that these test conditions themselves represent a highly idealized approximation (as does the FMVSS 208 barrier test) to an actual vehicle frontal crash exposure on a roadway.

It should also be noted that the NHTSA in 1979 initiated the New Car Assessment Program (NCAP) to evaluate a selected number of current-production motor vehicles. The evaluation employs the full-scale frontal barrier crash test procedure stipulated in FMVSSs 208, 212, 219, and 301. NCAP however, are conducted at 56 km/h (35 mph), 8 km/h (5 mph) higher and 36 percent more severe than the 48 km/h (30 mph) impact velocity employed in compliance tests that all new cars are required to meet.⁸

NCAP tests are being performed to establish a database that can be used to develop crashworthiness ratings criteria. These criteria would be employed in a manner similar to the EPA fuel economy values presently being made available to the public. Until such criteria are adopted, the program serves to provide consumers with relative measures of safety performance. While better scores (e.g., lower injury indicator values) imply that vehicles are safer, NHTSA's attitude is that those with poorer scores are less safe, not unsafe.

The occupants of transport category commercial airplanes must also demonstrate compliance with federally mandated occupant injury criteria contained in 14 CFR: Part 25. Certain requirements pertain to both crewmembers and passengers alike, while others are applicable to crewmembers alone. These requirements, listed in Table 3-3 of Chapter 3, are evaluated by means of sled testing using Hybrid II dummies.

It should also be noted that FMVSS 213 mandates occupant injury criteria specifications which must be met by motor vehicle and aircraft occupants using child restraint systems (see Table 3-3 in Chapter 3). Compliance with this standard is evaluated by means of sled testing.

As noted in Chapter 3, there are no standards or regulations which mandate injury criteria specifications for the occupants of any type of vehicle belonging to North American or foreign mass transit or intercity passenger train consists.

⁸The fact that the impact severity level is significantly higher than the 8 km/h (5 mph) increase in impact velocity is a consequence of the increased kinetic energy that must be absorbed by the vehicle structure in the NCAP test. This can be seen by forming the ratio of the two energy levels involved. For equal-mass vehicles, this ratio yields, upon cancellation of identical terms: $(35)^2 / (30)^2 = 1.36$

6. RECOMMENDATIONS AND GUIDELINES FOR IMPROVED HSGGT VEHICLE CRASHWORTHINESS DESIGN AND EVALUATION

The preceding chapter of this report described the current status of transport vehicle crashworthiness design and evaluation for selected transportation modes. It was determined that existing intercity passenger rail vehicle crash safety regulations and standards, and industry practice failed to adequately address basic physical issues which influence occupant accident survivability performance in all transportation modes. The knowledge gained from this survey will be applied in this section to outline the framework for a meaningful, systematic and cost-effective plan that could be employed to evaluate the crashworthiness of HSGGT vehicles.

The plan would specify, where possible, structural, interior and biomechanical performance requirements, with vehicle compliance ascertained using a combination of experimental and analytical techniques. Consistent with economic and practical considerations and the current state-of-the-art of vehicle crashworthiness technology, these requirements would be evaluated at three different levels: whole-body vehicle, occupant injury potential, and vehicle system. Sections 6.1, 6.2 and 6.3 outline each of these approaches, respectively.

It should be noted that the plan presented herein merely outlines the various methodologies that could be followed and the general nature of the corresponding criteria that would be employed to evaluate HSGGT vehicle crash safety performance. As such, it constitutes a vital first step in the future development of a set for formal HSGGT vehicle accident survivability specifications. Vehicle compliance would be measured relative to those specifications.

The formulation of HSGGT vehicle crash safety specifications will be complicated by the absence of a suitable experimental database for existing intercity passenger rail and maglev vehicles. Consequently, evaluation methodology development and checkout would be performed using vehicle design and performance data generated in a separate, parallel, guided ground vehicle crashworthiness research and development program. The information obtained from such an effort, discussed in Section 6.4, would enable the formulation of an initial set of preliminary standards. These specifications would be subject to continuous review and subsequent revision using inputs from future research and service experience. Section 6.4 also provides various recommendations that should be examined in order to improve the crash injury mitigation design of HSGGT vehicle compartment interiors.

6.1 WHOLE-BODY VEHICLE EVALUATION

Passenger train whole-body vehicle response to a crash includes consideration of both vehicle kinematic behavior as part of the consist and its subsequent structural collapse and acceleration-time signature as a result of impulsive loading sustained from one or more large-obstacle collisions. The objective of whole-body HSGGT vehicle evaluation is to ascertain the kinetic energy absorption potential of the vehicle as a function of its overall occupant compartment crush and acceleration responses. The magnitude of this energy would be compared with specification energy levels to determine vehicle compliance with the whole-vehicle kinetic energy absorption standard for low-, medium- and high-speed impact conditions. As noted in Section 2.2.1, tradeoffs are possible between each of these parameters by altering the structural design of the

vehicle. However, such compromises must lie within an envelope bounded by compartment structural integrity and acceleration environment considerations and their consequences on occupant survivability.

Of the various performance evaluation approach options discussed in Chapter 4, only two -- full-scale crash testing and analysis -- are directly applicable to the simulation of the HSGGT vehicle crash pulse and crush profile. However, as discussed in Sections 4.1.1 and 5.3, negative economic considerations and test protocol limitations necessarily restrict the type and number of full-scale crash tests that can be performed with any transport vehicle. This problem is compounded for the case of a train, where a number of multilinked vehicles are usually involved in a given accident scenario.

Even if limited to a single representative impact condition akin to the current FMVSS 208, 48 km/h (30 mph) flat frontal barrier crash test for motor vehicles, it is highly unlikely that HSGGT whole-body vehicle response would ever be evaluated by means of full-scale crash testing. Such an approach is economically viable for the motor vehicle industry, which produces millions of units per year. It cannot be economically justified for the railway industry, which produces a small fraction of this number of vehicles per year. However, as discussed in Section 6.4, a limited number of full-scale crash tests could be performed as part of a recommended HSGGT vehicle research and development program.

With full-scale crash testing eliminated from consideration, mathematical modeling remains the only practical means of evaluating HSGGT whole-body vehicle response to impact. Several questions must be addressed regarding such simulations:

1. What vehicle crash configuration do we wish to model?
2. What level of modeling detail is sufficient to provide enough information in order to evaluate the crashworthiness performance of the vehicle?
3. What analyses currently available can provide the information we are seeking?
4. Assuming that a viable analysis exists and that we have performed a mathematical simulation of a particular crash event, how do we validate the predictions it generates?

The first and last questions are related. The number of accident scenarios that can be modeled by even the most sophisticated analysis available will necessarily be limited by the availability of corresponding full-scale crash test data which *must* be examined to provide necessary corroborating experimental data to validate the computer-generated predictions. Thus, the crash configuration selected for HSGGT vehicle modeling should be drawn only from those accident scenarios that can be simulated via full-scale validation crash testing conducted in parallel R&D efforts. It is recommended that this selection follow reasoning similar to that employed by the NHTSA and its formulation of a representative full-scale crash test procedure to evaluate occupant survivability in motor vehicle accidents (i.e., FMVSS 208).

Initially, one accident configuration which constitutes a statistically significant collision threat to train occupants (i.e., an accident scenario that displays a high frequency of occurrence and produces serious casualties) could be selected for simulation. Two likely candidate configurations are the head-end and rear-end collisions described in Section 2.1. One or more scenarios could be added later should the updated HSGGT accident database indicate such a need.

For the selected collision configuration, computer simulations should be selected that are capable of providing at least the basic information needed for HSGGT whole-body vehicle crashworthiness performance evaluation:

- o Vehicle kinematics in a typical consist: i.e., will the consist experience straight-line acceleration or deceleration, override, jackknife, or rollover (see Section 2.1)? This information will define the initial impact conditions for the analysis of the crash dynamics experienced by each vehicle during its primary collision phase.
- o The vehicle compartment acceleration-time history at one or more locations. This information would be (1) employed as input to occupant dynamic analyses used in secondary collision modeling to estimate occupant response and potential harm caused by the accident, and (2) used in conjunction with dynamic crush predictions (see below) to estimate the kinetic energy absorption of the vehicle.
- o A mapping of the vehicle structure collapse configuration, including maximum dynamic crush sustained by the vehicle compartment. This information would provide an assessment of the status of critical compartment survival space during the collision as well as an indication of how well the vehicle structure absorbs the kinetic energy of impact.

Section 4.2.1 indicated that various computer codes exist which can provide different levels of detail for the desired responses. Of the codes surveyed therein, preliminary indications are that IITRAIN, ADAMS and the Frazer-Nash Consultancy (FNC) version of DYNA3D in its rigid body mode offer the potential for modeling train kinematics in an axial train-to-train collision. At this time, it appears that primary collision modeling can be pursued either at a very gross, approximate level using any one of the many lumped-mass analyses available, or at a much more detailed level using a finite element analysis such as FNC's DYNA3D in its large-deformation, inelastic material behavior mode.

As noted in Section 4.2, the usefulness of the predictions generated by any of these analyses, regardless of their degree of sophistication, is limited by the availability and reliability of essential input data. Moreover, **only those computer codes that have been properly validated should be used for evaluation purposes.** Otherwise, the results of the evaluation would be suspect and definitive compliance (or noncompliance) with a specification legitimately subject to question. As noted earlier, computer code validation would be performed as part of the proposed R&D effort discussed in Section 6.4.

6.2 OCCUPANT INJURY POTENTIAL EVALUATION

Passenger train occupant response to a crash is (assuming the preservation of minimum occupant compartment survival space) dependent on the crash configuration itself and the consequent nature and severity of secondary collisions which occur between the occupant and compartment interior surfaces and/or other occupants in the compartment. The objective of HSGGT vehicle occupant crash safety evaluation is to ascertain the likelihood of occupant injury arising from such collisions for the whole-body vehicle crash configuration(s) selected for evaluation. Two approaches are recommended: sled testing and mathematical modeling.

In both approaches, HSGGT vehicle compliance with this part of the evaluation plan would require that pertinent recorded and/or calculated injury indicator parameters not exceed accepted thresholds deemed to be life-threatening. Initially, the injury criteria embodied in an existing vehicle occupant survivability standard such as FMVSS 208 could be employed for this purpose. Other accepted measures of occupant injury could be added to this basic foundation as more information becomes available from associated R&D work.

Later versions of the plan should also consider the safety of small children in train accidents. This consideration could be introduced into the plan by adding child restraint performance requirements similar to those contained in FMVSS 213. HSGGT vehicle occupant survivability performance requirements for different size occupants (e.g., 5th percentile female and 95th percentile male) could also be included should such injury criteria be developed and accepted.

Ideally, HSGGT vehicle occupant injury potential should be evaluated by means of full-scale crash testing as per FMVSS 208. As noted previously, however, this approach is prohibitively costly when applied to trains and hence is not a viable option in the plan. An alternative dynamic experimental approach, sled testing, constitutes a worthy compromise. This technique, outlined in Section 4.1.2, would be performed using one or more body bucks constructed from representative sections of HSGGT vehicle superstructures. Actual seats, furniture, barriers, baggage racks, and interior sidewall and roof surfaces would be installed in each buck. Dummies would be positioned in each buck to simulate standard occupant configurations in a passenger coach and other cars, e.g., unidirectional seating, face-to-face seating, standing, etc.

Performance of such tests requires (for a typical HYGE sled) the use of metering pins machined to provide a preprogrammed approximation to selected portions of the appropriate occupant compartment crash pulse for the crash configuration simulated. As noted in Section 6.1, the crash pulse would be obtained from output provided by the primary collision analysis used in whole-body vehicle evaluation. The validity of the occupant injury data obtained from sled test evaluation is obviously highly dependent on the accuracy of the crash pulse employed. Preliminary research to develop the sled test technique for HSGGT vehicle application would be carried out as part of the proposed HSGGT R&D program (see section 6.4).

Computer simulation can also be employed to evaluate the potential for injury to occupants of an HSGGT vehicle in the selected crash configuration(s). Occupant compartment crash pulse input provided by whole-body vehicle evaluation modeling again constitutes a critical input in this

approach. Of the various occupant dynamics analyses reviewed in Section 4.2.2, both ATB and MADYMO appear to have the capability to model at least some of the many different possible occupant configurations noted. These codes, which have been validated for application to typical motor vehicle accidents, have not yet been applied to a wide range of potential contacts and interactions possible between several occupants and the compartment interior in any given train crash. In addition, their use in such simulations would require additional input data, e.g., algorithms to represent muscular control of a standing occupant. Such data would have to be developed as part of the aforementioned R&D effort.

The Frazer-Nash Consultancy's DYNAMAN, also surveyed in Section 4.2.2, appears to have the potential to provide at least qualitative predictions of multi-occupant response to an HSGGT vehicle compartment acceleration environment. Unfortunately, it has not yet been quantitatively validated. With realistic input data and appropriate validation, DYNAMAN could be especially useful for simulation of HSGGT vehicle occupant kinematics and evaluation of injury potential.

6.3 VEHICLE SUBSYSTEM EVALUATION

This part of the plan would ascertain the performance of selected crash safety-related HSGGT vehicle systems. Component testing using the various experimental techniques outlined in Section 4.1.3 would be employed to measure system compliance relative to prescribed specifications. In this respect, subsystem-level evaluation would be akin to those vehicle structure- and compartment interior-related Federal Motor Vehicle Safety Standards which supplement FMVSS 208.

As envisioned herein, vehicle subsystem evaluation would be employed to determine HSGGT vehicle compliance with specifications designed to measure performance in the following categories:

- o local resistance of the vehicle's shell to penetration
- o static strength and energy absorption characteristics of compartment interior components and surfaces
- o static strength of specific structural regions

The possible nature of such evaluation for each of these categories is outlined below.

- o *Local Vehicle Shell Penetration Resistance.* The proposed assessment of local vehicle shell penetration resistance would reflect a measure of the resistance to puncture of the vehicle superstructure (skin and glazing) over a very small area. Penetration results from projectile impact, e.g., a bullet or rock striking a window. Federal Aviation Administration aircraft glazing requirements (FAR 25.775) constitutes an example of an existing regulation which addresses this issue. Shell compliance with a comparable HSGGT vehicle regulation could be readily evaluated by means of dynamic component testing. For example, a gas-powered linear impactor device could be used to propel a rock at a prescribed impact velocity against a vehicle window in a section of the shell, or a bullet from an actual rifle or handgun could be fired at the shell.

- o *Compartment Interior Energy Absorption and Static Strength Requirements.* HSGGT vehicle compartment surfaces should satisfy prescribed smooth-contour and energy dissipation characteristics keyed to various levels of relative occupant/compartment impact velocity. It is recommended that performance envelopes be formulated for typical potentially harmful contacts between specific body regions and interior surfaces, e.g., head/sidewall, head/seat back and abdomen/table edge. Performance evaluation may involve many different impact configurations consistent with injury descriptions documented in train accident reports, as well as data obtained from full-scale crash or sled tests, and injury and kinematic predictions provided by occupant/interior impact analyses conducted in the proposed R&D program. Compliance evaluation of compartment interior system performance relative to the stipulated criteria would be carried out using one or more of the dynamic test techniques described in Section 4.1.3.

As noted in Section 5.2.2, Federal Motor Vehicle Safety Standards currently require static strength testing of various compartment interior components and assemblies such as head restraints, seats, seat belts, and restraint anchorages. (All such hardware is also subjected to an unofficial dynamic test performance evaluation as part of the 48 km/h (30 mph) full-scale frontal barrier crash test specified by FMVSS 208.) Static strength testing would also be required for equivalent HSGGT vehicle compartment interior subsystems as well as for the doors of enclosed baggage bins. Door securement could also be evaluated in a dynamic environment via sled testing.

A general-purpose static crush and tensile test frame would be used to check static strength requirements for certain compartment interior components and assemblies. These test devices are currently employed to perform compliance tests for FMVSS's such as 202, 207, 210, 214, 216, and 220. Existing frames are designed to allow testing of a wide variety of motor vehicle sizes and configurations. They could be equipped with special fixtures (or be designed expressly) to accommodate a section of HSGGT vehicle shell and floorpan on which seats, tables, counters, baggage racks, and restraint system anchorages could be mounted.

- o *Static Strength Requirements for Specific Structural Regions.* The proposed evaluation plan would also specify static strength requirements similar to those contained in current FRA regulations/AAR standards (e.g., buff and coupler strengths). Such standards are necessary to ensure compatibility between connecting vehicles manufactured by different suppliers. It is anticipated that, as a minimum, the present strength criteria would be upgraded to reflect the demands of high-intensity impact loading.

Static structural strength requirements would probably be evaluated in much the same manner as current practice. That is, a combination of a compressive test and supporting structural analysis would be employed. Some change in test methodology may be implemented in the evaluation plan because of possible overlaps and/or conflicts with the proposed crashworthiness standards. Again, these factors would be examined in a separate R&D program.

Table 6-1 outlines the specific types of tests envisioned for use in each of the vehicle system evaluation categories discussed in this subsection. For the sake of completeness, sled test evaluation to determine occupant compliance with prescribed injury criteria (discussed in Section 6.2) is also included in this matrix.

Table 6-1
Experimental Approach Envisioned for Proposed HSGGT Vehicle
Crashworthiness Evaluation Plan

Type of Test	Crashworthiness Evaluation Criteria			
	Occupant Injury Potential	Local Shell Penetration	Interior Energy Absorption	Static Structural Strength
Sled	X			
Dynamic Component	X	X	X	
Static Compression and Tensile	X*		X*	X

*Data generated used as Input in mathematical modeling efforts

6.4 PROPOSED HSGGT VEHICLE CRASHWORTHINESS RESEARCH AND DEVELOPMENT ACTIVITIES

It was noted in the preceding discussions that many of the requirements that would be embodied in future HSGGT vehicle crash safety specifications have yet to be defined. For example, one or more vehicle crash pulses would be needed for use in sled test evaluation of occupant injury risk for some as yet unspecified number of representative accident scenarios. Currently, there is virtually no experimental data extant which provide a quantitative measure of rail vehicle collision response (e.g., electronically recorded acceleration-time histories and force-deflection characteristics, high-speed films of vehicle kinematics, etc.) in moderate- and high-speed collisions. Crash pulse definition would require, as a minimum, knowledge of the approximate pulse duration, average peak acceleration level, and velocity change over the pulse length. Some idea of the general pulse shape would also be desirable.

As noted in Section 4.2.1, various relatively simple vehicle structural dynamics analyses are available that can provide gross crash pulse and crush predictions for certain impact configurations. The accuracy of such first-approximation simulations are highly dependent upon many factors, including the reliability of the source of the structural force-deflection inputs used in the analysis (e.g., static crush data, another analysis or merely an educated guess). While crash pulses obtained in this manner can be employed in sled tests to assess the potential for

injury to occupants, the results obtained should be viewed with caution until definitive experimental data becomes available.

The similar lack of an experimentally generated database describing rail vehicle structure force-deflection response as a function of impact loading also precludes setting requirements for HSGGT vehicle kinetic energy absorption. Definition of such criteria using dynamic crush predictions generated by the sophisticated finite element computer analyses described in Section 4.2.1 is not recommended because these codes have not yet been validated for such applications.

In summary, the formulation of meaningful and complete HSGGT vehicle accident survivability specifications will probably require inputs from a comprehensive research and development program. Such a program would investigate the suitability of all computer analyses contemplated for use in the compliance evaluation plan and/or in the development of performance envelopes called out by the preliminary specifications.

Computer-generated predictions (e.g., vehicle crash pulses and global compartment intrusion) would be compared with data from a corresponding limited series of full-scale crash tests to determine if the analytical results match what happens in the real world. Once the computer codes are deemed acceptable for certain impact configurations and velocity envelopes, they would be exercised by varying the parameters to generate the data necessary for the preparation of engineering standards for the various evaluation criteria. This initial set of preliminary standards would then be evaluated in appropriate full-scale crash, sled, static crush, and dynamic component tests. Test results would provide guidance for the direction of possible changes in these tentative specifications.

Each test conducted for a specific validation objective would have a certain "spin-off" potential. For example, a full-scale crash test of a suitably instrumented vehicle would provide not only crash pulse and deformation data but valuable occupant kinematics and secondary contact configuration information (obtained from on-board high-speed movie camera film data) as well. Such dummy-related responses would be useful for validation of occupant/interior impact analyses employed to help develop specifications which address compartment interior safety.

Upon satisfactory code validation, additional vehicle crash and occupant/interior impact modeling would be conducted to obtain data for accident scenarios that may not be readily amenable to experimental determination (e.g., impacts requiring the generation of massive kinetic energy levels or a rollover). To accomplish this objective, it is recommended that various codes be selected to model appropriate portions of a given crash scenario.⁽¹⁾ With this approach, a particular accident scenario would be selected and divided into a series of chronological events, each of which could be modeled by a program specifically designed to simulate that type of action. The net result of exercising each of these analyses over their respective applicable real-time domains would be a rail vehicle occupant compartment acceleration mapping that would be then input into an appropriate occupant dynamics code. The latter analysis would generate

¹It is assumed here that a *validated*, simple, economical, straightforward, and comprehensive dynamic analysis that can model the complete spectrum of events of rail vehicle dynamics and structural collapse that can occur in a train accident is not available for use in the proposed R&D program.

predictions of occupant kinematics, body segment contacts with the compartment interior, and injury potential.

This so-called "stringing" of vehicle dynamics and impact structural analyses is, of course, contingent upon the existence of analyses capable of modeling, to some acceptable degree, the trajectory and collapse mechanisms exhibited by a HSGGT vehicle in any given crash mode. Exercising these analyses would also require experimentally determined and/or calculated vehicle input data such as its geometry and inertial and force-deflection properties. Such inputs would also be obtained from the proposed research and development program.

It is also envisioned that analyses and techniques for reconstructing physical accidents could be performed as part of the R&D effort for the investigation of selected real train crashes by the NTSB. The quantitative and qualitative information gleaned from these activities could provide valuable insight for understanding the complex behavior of train crashes and help in the setup of experimental protocols and mathematical models that more closely approximate real-world accidents. A skilled physical accident reconstructionist may also be able to provide estimates of certain quantitative crash-related information such as vehicle impact velocity and the duration of contact for a given event in a multiple-event accident.

The proposed R&D program could also examine other areas of interest. One of these might be vehicle structure corrosion. Such a study could determine if corrosion degrades vehicle crashworthiness to the point where periodic vehicle inspection and possible repair may be necessary to comply with safety specifications. Another area of interest could be trade-off studies between vehicle weight (e.g., the use of an aluminum or a steel shell) and vehicle crash response characteristics. The development and incorporation in the vehicle structure of lightweight devices having a high specific energy absorption capacity constitutes another research area worthy of investigation.

The most potentially rewarding crash safety study that should be pursued in the proposed R&D program is in the design of vehicle interiors to mitigate injuries arising from crashes. Section 5.2 described a number of deficiencies in the design of intercity passenger rail vehicle compartments that constitute serious safety hazards to occupants during an accident. Clearly, these problems must be addressed and appropriate design solutions implemented if HSGGT vehicles are to take full advantage of the improved structural crashworthiness response characteristics that would result from compliance with performance-based specifications.

Based on the discussion of Section 2.2 and the findings of Section 5.2, it is concluded that the absence of adequate restraint, which permits occupants to attain a high velocity relative to the compartment, is a serious handicap to providing effective protection against secondary impacts with the interior surfaces of guided ground vehicle compartments. In this regard, it should be noted that even though the time-average magnitude of a rail vehicle crash pulse is characteristically very low, its long duration can permit an unrestrained occupant to acquire a high relative compartment interior impact speed. Such contact increases the likelihood of serious occupant injury during a train accident. For the case of *seated* occupants, this problem can be alleviated in two different ways: (1) the addition of a belt restraint system anchored to the vehicle interior at existing seat locations, and (2) the incorporation of built-in protective measures in various compartment interior systems.

As a minimum, option 1 would require that seated occupants be restrained by lap belts similar to those employed in transport category commercial airplanes or motor vehicles. Without a torso belt (as currently required by FMVSS 208) the torso of the seated occupant could undergo considerable rotation, resulting in possible upper body contact(s) with the surroundings. However, the occupant would remain in the seat (assuming it remained attached to the compartment mounting surface) during an accident. The latter action would limit his/her velocity relative to the compartment and avoid many (but not all) of the potential injury-producing contacts discussed in Section 2.2.2. The severity of such contacts would be greatly diminished if the seats and compartment surfaces were designed to meet specific occupant protection criteria (discussed below).

As alluded to above, 3-point belt restraint systems (which feature both lap and torso belt segments) provide greater upper body protection in an accident than a lap belt system alone. However, the absence of a convenient interior wall anchor point for the D-ring at the upper torso belt location would appear to preclude the installation of this system for the aisle seats in most HSGGT coaches.

The use of a lap belt may engender strong resistance from passengers who wish to remain free of any motion-constraining devices around their body. It should be noted, however, that as more states enact (and enforce) mandatory automotive safety belt use laws in the near future, such opposition would probably decrease to a minimal level.² Motor vehicle accident data have provided incontrovertible evidence that the proper use of restraint systems by their occupants saves lives and lessens the severity of injuries sustained in roadway accidents. This option should be given serious consideration in future research efforts.

The second option relies on the use of static passive restraints³ to restrict occupant motion in the compartment during a train collision. As noted in Section 5.2.2, such systems are mandated for use in school buses by FMVSS 222. Thus, for example (see discussion in Section 2.2.2), a seated occupant would ride down a frontal axial impact after making contact with a cushioned seat back designed to collapse at a predetermined force level. Unfortunately, this system would not prevent the occupant from tumbling out of a seat of an existing-design in some other accident mode such as a side impact or rollover. (The addition of a simple lap belt *would* prevent this from happening.) The use of modified seats with "wings" such as those used on current child restraint seats could have some potential for limiting lateral occupant motion in non-axial collisions. However, they still would not possess the occupant retention capability of a seat belt for rollover protection.

Another impact mode-limited, static passive-type restraint approach would be to rotate all seats 180 degrees so that passengers ride backwards. The seat back would then provide full upper torso and head support in a frontal collision mode (*only*). This concept could provide adequate

²Reference [6-1] notes that according to national surveys, automotive safety belt use stands at approximately 59 percent. Currently, 42 states and the District of Columbia have enacted safety belt use laws.

³The term "static passive" is used to distinguish between the approach described herein and automatic occupant protection systems such as air bags and passive belts used in automobiles and light trucks.

occupant protection only in coaches, where the seats would all be arranged to face the same direction (as per FMVSS 222). The degree of protection afforded would be highly dependent upon the structural integrity and energy absorption capacity of the seat and the integrity of its anchorage to the coach floor. While seemingly attractive from the point of simplicity, this approach would most likely not receive serious consideration by the rail industry because most coach passengers dislike the idea of riding backwards. Moreover, it would not provide occupant protection for rear-end collisions.

The incorporation of well-padded partitions between groups of seats represents another type of static passive restraint concept that could be employed in passenger coaches. Such walls, which would break up the large volume of open compartment space into smaller zones, would be especially effective in vehicles such as food service and lounge cars. (Restricting occupant motion during an accident decreases the magnitude of his velocity relative to the compartment and lessens the severity of secondary contacts.) Performance requirements for such restraining barriers are covered by FMVSS 222 for school bus applications.

A similar concept could be applied to a dining car by enclosing each table by an appropriately contoured and padded booth with lateral motion-restricting wings. To be even more effective, the edge of the table could also be padded to lessen occupant/table contact pressure in an accident situation. The inclusion of a seat belt would ensure that the occupants from one side of the table would not be ejected from their seats and possibly collide with their counterparts on the other side of the table during a train accident.

As noted in Section 5.2.1, current intercity rail passenger seats have exhibited extremely poor crash safety performance under crash-induced loading conditions. A seat must remain attached to the compartment floorpan during all accident scenarios to enable the occupant to use whatever motion/velocity arresting device is in place to ride down the crash. Such retention is routinely achieved in full-scale automotive compliance tests under FMVSS 208 as well as in sled tests of all aircraft types under FAR 25.785. Alternative designs and/or designs for a strengthened version of the existing attachment would certainly provide the desired improved seat attachment integrity for guided ground vehicle applications.

Cushion detachment from the seat framework, which can lead to occupant contact with hard and/or sharp surfaces during train accidents, should also be amenable to a relatively simple design fix. The same cushion retention techniques successfully employed in school buses and governed under FMVSS 222 should be directly transferable to guided ground vehicles.

The characteristic unfriendliness of current rail vehicle compartment interiors could be improved markedly by adopting smooth-contour, injury-mitigating surface cushioning measures similar to those employed in road vehicles subject to Federal safety regulations. These interiors have energy absorbing padding material of various densities covering support surfaces designed to collapse at predetermined force levels compatible with human tolerance thresholds. It may also be feasible to use a sandwich type of panel comprising aluminum honeycomb covered with such padding. This concept was successfully employed in the door trim panels used in the *Research Safety Vehicle* program sponsored by the NHTSA [6-2]. As noted previously, the provision of such energy absorbing interior surfaces for HSGGT vehicle sidewalls, roof, and partitions as well

as table and counter edges fulfills a fundamental requirement in the design of a more crashworthy interior for both of the two generic occupant retention approaches proposed in this report.

As noted in Section 5.2.1, people walking or standing at the time of an accident are especially vulnerable to injury because they would not have access to the protection afforded by a crashworthy seat (and possibly a restraint system). Adequate protection of such occupants (i.e., the provision of protection comparable to that provided their seated counterparts) constitutes an extremely challenging problem that may prove to be intractable. However, the presence of specially designed energy absorbing, smooth-contoured interior surfaces would certainly alleviate the severity of many of the inevitable occupant/surface contacts that would occur.

Another compartment interior problem that appears to be amenable to simple corrective action is that of baggage and equipment retention. Removal of obsolete, open, overhead baggage racks and replacement with *enclosed* overhead stowage compartments similar to those used in transport category commercial aircraft would eliminate the hazard of occupants being struck and knocked down by loose baggage. This change would also eliminate potentially hazardous aisle/exit blockage by fallen baggage. Similar problems stemming from unsecured food service equipment such as microwave and convention ovens could be eliminated by simply bolting down such items to their supports.

Passenger cars with sleeping accommodations are also candidates for much-needed interior crash safety redesign. For example, a well-padded enclosure for personal baggage kept in these compartments and a movable, energy-absorbing barrier to prevent occupant contact with the inherently hard surfaces of in-compartment lavatory facilities would prove beneficial in a train accident. Also, some means of restraining sleeping occupants (especially in an upper berth) during an accident should be provided. Perhaps a cushioned retention structure could be incorporated into the design of HSGGT vehicle fold-out beds to alleviate this problem.

Table 6-2 presents a preliminary matrix of possible HSGGT vehicle research and development activities keyed to the test, modeling, and analysis efforts discussed in this report.

Table 6-2
Proposed HSGGT Vehicle Research and Development Activities to
Establish Crashworthiness Evaluation Specifications

Research Objective	Approach Employed to Achieve Research Objective						
	Full-Scale Crash Testing	Sled Testing	Dynamic Component Testing	Static Crush Testing	Vehicle Crash Modeling	Occupant/Interior Impact Modeling	Accident Reconstruction and Data Analyses
Vehicle Crash Response	X			X*	X		X
Crash Pulse Development	X				X*	X	X
Structure Force-Deflection, Penetration and Collapse Characteristics	X		X	X	X		X
Compartment Interior Energy Absorption Characteristics		X	X	X		X	
Occupant Injury Potential and Kinematic Response	X	X	X			X	X

* Data generated used as input in mathematical modeling efforts

7. REFERENCES

- 3-1 Patrick, L.M., Bohlin, N. and Andersson, A., "Three-Point Harness Accident and Laboratory Data Comparison," *Proceedings of the Eighteenth Stapp Car Crash Conference*, Paper 741181, Society of Automotive Engineers, Warrendale, PA, 1974.
- 3-2 Yamada, H., *Strength of Biological Materials*, Williams and Wilkins, Baltimore, 1970.
- 3-3 Pike, J.A., *Automotive Safety: Anatomy, Injury, Testing & Regulation*, Society of Automotive Engineers, Warrendale, PA, 1990.
- 3-4 *Human Tolerance to Impact Conditions as Related to Motor Vehicle Design*, Information Report SAE J885 JUL86, Society of Automotive Engineers, Warrendale, PA, 1986.
- 3-5 Damask, A.C., *Medical Physics, Vol. 1: Physiological Physics and External Probes*, Academic, New York, 1978.
- 3-6 Melvin, J.W. and Weber, K., *Review of Biomechanical Impact Response and Injury in the Automotive Environment*, U.S. Department of Transportation, National Highway Traffic Safety Administration, Report No. UMTRI-85-3, 1985.
- 3-7 McElhanev, J.H., Stalnaker, R.L. and Roberts, V.L., "Biomechanical Aspects of Head Injury," *Human Impact Response Measurement and Simulation*, (King, W.F. and Mertz, H.J., ed.), Plenum Press, New York, 1973.
- 3-8 Ommaya, A.K., *Head Injury Mechanisms*, U.S. Department of Transportation, Report No., DOT-HS-800-959, 1973.
- 3-9 Melvin, J.W. and Evans, F.G., "A Strain Energy Approach to the Mechanics of Skull Fractures," *Proceedings of the Fifteenth Stapp Car Crash Conference*, Paper 710871, Society of Automotive Engineers, Warrendale, PA, 1971.
- 3-10 Patrick, L.M. and Mertz, H.J., "Cadaver Knee, Chest and Head Impact Loads," *Proceedings of the Eleventh Stapp Car Crash Conference*, Paper 670913, Society of Automotive Engineers, Warrendale, PA, 1967.
- 3-11 Nahum, A.M., Gatts, J.D., Gadd, C.W., and Danforth, J., "Impact Tolerance of the Skull and Face," *Proceedings of the Twelfth Stapp Car Crash Conference*, Paper 680785, Society of Automotive Engineers, Warrendale, PA, 1968.
- 3-12 Hodgson, V.R., Brinn, J., Thomas, L.M., and Greenberg, S.W., "Fracture Behavior of the Skull Frontal Bone Against Cylindrical Surfaces," *Proceedings of the Fourteenth Stapp Car Crash Conference*, Paper 700909, Society of Automotive Engineers, Warrendale, PA, 1970.

- 3-13 Versace, J., "A Review of the Severity Index," *Proceedings of the Fifteenth Stapp Car Crash Conference*, Paper 710881, Society of Automotive Engineers, Warrendale, PA, 1971.
- 3-14 Hodgson, V.R. and Thomas, L.M., "Effect of Long-Duration Impact on Head," *Proceedings of the Sixteenth Stapp Car Crash Conference*, Paper 720956, Society of Automotive Engineers, Warrendale, PA, 1972.
- 3-15 Stahnaker, R.L., Roberts, V.L. and McElhaney, J.J., "Side Impact Tolerance of Blunt Trauma," *Proceedings of the Seventeenth Stapp Car Crash Conference*, Paper 730979, Society of Automotive Engineers, Warrendale, PA 1973.
- 3-16 Schneider, D.C. and Nahum, A.M., "Impact Studies of Facial Bones and Skull," *Proceedings of the Sixteenth Stapp Car Crash Conference*, Paper 720965, Society of Automotive Engineers, Warrendale, PA 1972.
- 3-17 Hodgson, V.R., "Tolerance of the Facial Bones to Impact," *American Journal of Anatomy*, Vol. 120, No. 1, 1967.
- 3-18 Patrick, L.M., Lange, W.A. and Hodgson, V.R., "Facial Injuries -- Causes and Prevention," *Proceedings of the Seventh Stapp Car Crash Conference*, Charles C. Thomas, Publisher, Springfield, IL, 1965, pp. 541-568.
- 3-19 *Evaluation of Laminated Windshield Laceration Potential*, Information Report SAE J1208, Society of Automotive Engineers, Warrendale, PA, 1979.
- 3-20 Mertz, H.J. and Patrick, L.M., "Investigation of the Kinematics and Kinetics of Whiplash," *Proceedings of the Eleventh Stapp Car Crash Conference*, Paper 670919, Society of Automotive Engineers, Warrendale, PA, 1967.
- 3-21 Mertz, H.J. and Patrick, L.M., "Strength and Response of the Human Neck," *Fifteenth Stapp Car Crash Conference*, Paper 710855, Society of Automotive Engineers, Warrendale, PA, 1971.
- 3-22 Kroell, C.H., Schneider, D.C. and Nahum, A.M., "Impact Tolerance and Response of the Human Thorax II," *Proceedings of the Eighteenth Stapp Car Crash Conference*, Paper 741187, Society of Automotive Engineers, Warrendale, PA, 1974.
- 3-23 *Aircraft Crash Survival Design Guide, Volume II - Aircraft Crash Environment and Human Tolerance*, Simula Inc., Report No. USARTL-TR-79-22B, January 1980.
- 3-24 *Biomechanics and its Application to Automotive Design*, Publication P-49, Society of Automotive Engineers, Warrendale, PA, 1973.
- 3-25 Kramer, M., Burow, K. and Heger, A., "Fracture Mechanism of Lower Legs Under Impact Load," *Proceedings of the Seventeenth Stapp Car Crash Conference*, Paper 730966, Society of Automotive Engineers, Warrendale, PA, 1973.

- 4-1 Segal, D.J., *An Assessment of the Crashworthiness of Existing Urban Rail Vehicles, Volume 111: Train-Collision Model, User's Manual*, Calspan Corporation, Report No. UMTA-MA-06-0025-75-16. III, November 1975.
- 4-2 Reilly, M.J., Shefrin, J. and Patrick, L.M., *Rail Safety/Equipment Crashworthiness Design Guide*, Boeing Vertol Company, Report No. DOT-TSC-821-2, September 1975.
- 4-3 Widmayer, E., *A Structural Survey of Classes of Vehicles for Crashworthiness*, Boeing Vertol Company, Report No. FRA/ORD-79-13, September 1979.
- 4-4 Raidt, J.B., Manos, W.P. and Johnstone, B., "Vertical Motions During Railcar Impacts," Pullman-Standard, ASME Rail Transportation Division Paper No. 75-WA/RT-10, 1975.
- 4-5 "Advances in Crash Simulation Technology," *Automotive Engineering*, Vol. 99, No. 2, February 1991, pp. 20-23.
- 4-6 *An Integrated Approach to Rail Vehicle Crashworthiness*, Frazer-Nash Consultancy Limited, Surrey, England, 1991.
- 4-7 Jones, N. and Wierzbicki, T., ed., *Structural Crashworthiness*, Butterworth & Co. (Publishers) Ltd., London, 1983.
- 4-8 Hahn, E.E., *Increased Rail Transit Vehicle Crashworthiness in Head-on Collisions, Part 1: Initial Impact*, IIT Research Institute, Report No. DOT-TSC-1052-1, June 1978.
- 4-9 Hahn, E.E., Walgrave, S.C. and Liber, T., *Increased Rail Transit Vehicle Crashworthiness in Head-On Collisions, Volume II: Primary Collision*, IIT Research Institute, Report No. UMTA-MA-06-0025-80-2, June 1980.
- 4-10 Madigan, R.J. and Chen, M.M., ed., *Proceedings of the Urban Rail Vehicle Crashworthiness Workshop--April 1978*, Pacific Consultants, Report No. UMTA-MA-06-0025-79-9, October 1979.
- 4-11 *PLASH: Program for Limit Analysis of Space Frames*, Atkins Research and Development, Surrey, England, March 5, 1980.
- 4-12 Tong, P. and Rossetos, N.N., *Modular Approach to Structural Simulation for Vehicle Crashworthiness Prediction*, U.S. Department of Transportation, Transportation Systems Center, Report No. DOT-TSC-NHTSA-74-7, 1975.
- 4-13 Obergefell, L.A., Gardner, T.R., Kaleps, I. and Fleck, J.T., *Articulated Total Body Model Enhancements, Volume 2: User's Guide*, Harry G. Armstrong Aerospace Medical Laboratory, Wright-Patterson AFB, OH, Report No. AAMRL-TR-88-043, January 1988.

- 4-14 Leetch, B.D. and Bowman, W.L., *Articulated Total Body (ATB) VIEW Package Software Report, Volumes I and 2*, Harry G. Armstrong Aerospace Medical Research Laboratory, Wright-Patterson AFB, OH, Report No. AFAMRL-TR-81-111, October 1981.
- 4-15 Nieboer, J.J., Wismans, J. and Fraterman, E., "Status of the MATYMO 2D Airbag Model," *Proceedings of the Thirty-Second Stapp Car Crash Conference*, Paper 881729, SAE International, Warrendale, PA, 1988.
- 4-16 Lupker, H.A., DeCoo, P.J.A., Nieboer, J.J. and Wismans, J., "Advances in MADYMO Crash Simulations," *Side Impact Occupant Protection Technologies*, Paper 910879, Publication SP-851, SAE International, Warrendale, PA, 1991.
- 4-17 "Weak at the Knees in Crash?," *Modern Railways*, October 1991, pp. 514-516.
- 4-18 Bush, I.S., Frazer-Nash Consultancy Limited, personal communication with author regarding the validation and simulation capacity of the FNC DYNAMAN code, May 1992.
- 5-1 Widmayer, E., *A Structural Survey of Classes of Vehicles for Crashworthiness*, Boeing Vertol Company, Report No. FRA/ORD-79-13, September 1979.
- 5-2 Madigan, R.J., and Chen, M.M., ed., *Proceedings of the Urban Rail Vehicle Crashworthiness Workshop--April 1978*, Pacific Consultants, Report No. UMTA-MA-06-0025-79-9, October 1979.
- 5-3 Bing, A.J., *An Assessment of High-Speed Rail Safety Issues and Research Needs*, Arthur D. Little, Inc., Report No. DOT/FRA/ORD-90/04, May 1990.
- 5-4 *Safety Relevant Observations on the X2000 Tilting Train*, U.S. Department of Transportation, Federal Railroad Administration, March 1991.
- 5-5 Dorer, R.M. and Hathaway, W.T., *Safety of High Speed Magnetic Levitation Transportation Systems: Preliminary Safety Review of the Transrapid Maglev System*, U.S. Department of Transportation, John A. Volpe National Transportation Systems Center, Report No. DOT/FRA/ORD-90/09, November 1990.
- 5-6 Jones, N. and Wierzbicki, T., ed., *Structural Crashworthiness*, Butterworth & Co. (Publishers), Ltd., London, 1983.
- 5-7 Reilly, M.J., Shefrin, J. and Patrick, L.M., *Rail Safety/Equipment Crashworthiness Design Guide*, Boeing Vertol Company, Report No. DOT-TSC-821-2, September 1975.
- 5-8 Mattison, P.D., Palmer, D.W. and Nayak, P.R., *A Report on Investigation into Rail Passenger Safety*, Arthur D. Little, Inc., Report No. FRA/ORD-80/65, October 1980.

- 5-9 *Railroad Accident Report: Rear-end Collision of Amtrak Passenger Train 94, The Colonial and Consolidated Rail Corporation Freight Train ENS-121, on the Northeast Corridor, Chase, Maryland, January 4, 1987*, National Transportation Safety Board, Report No. NTSB/RAR-88/01, January 25, 1988.
- 6-1 "DOT Secretary Card Praises Buckle Up America Week," *Highway & Vehicle/Safety Report*, Vol. 18, No. 19, June 1, 1992, p.5.
- 6-2 Fabian, G.J. ed., *Calspan/Chrysler Research Safety Vehicle, Phase III, Final Design Report, Volume 1*, Calspan Corporation, Report No. ZN-6069-V-23, December 1979.

