



**CSX 985
(ES44AC – GE)
Locomotive Noise Test Battery
Report**

CONTRACT NUMBER

FR-TEC-0003-11-01-00

This work was funded in whole or in part by the Federal Railroad Administration, US Department of Transportation under U.S. Government Grant FR-TEC-0003-11-01-00, and is therefore subject to the following license: The Government is granted for itself and others acting on its behalf a paid-up, nonexclusive, irrevocable worldwide license in this work to reproduce, prepare derivative works, distribute copies to the public, and perform publicly and display publicly, by or behalf of the Government. All other rights are reserved by the copyright owner.

By downloading, using, or referring to this document or any of the information contained herein you acknowledge and agree:

Ownership

This document and the information contained herein are the property of Meteorcomm LLC ("MCC"). Except for the limited rights granted under the above license, you obtain no rights in or to the document, its contents, or any related intellectual property all of which are the property of MCC.

Limited Use and Non Disclosure

This document is protected by copyright, trade secret, and other applicable laws.

Disclaimer of Warranty

This document and all information contained within this document or otherwise provided by MCC, and all intellectual property rights within, are provided on an "as is" basis. MCC makes no warranties of any kind and expressly disclaims all warranties, whether express, implied or statutory, including, but not limited to warranties of merchantability, fitness for a particular purpose, title, non-infringement, accuracy, completeness, interference with quiet enjoyment, system integration, or warranties arising from course of dealing, usage, or trade practice.

Assumption of Risk

You are responsible for conducting your own independent assessment of the information contained in this document (including without limitation schematic symbols, footprints and layer definitions) and for confirming its accuracy. You may not rely on the information contained herein and agree to validate all such information using your own technical experts. Accordingly, you agree to assume sole responsibility for your review, use of, or reliance on the information contained in this document. MCC assumes no responsibility for, and you unconditionally and irrevocably release and discharge MCC and its affiliates and their respective officers, directors, and employees ("MCC Parties") from any and all loss, claim, damage or other liability associated with or arising from your use of any of the information contained in this document.

Limitation of Liability & Disclaimer

This document is disseminated under the sponsorship of the Department of Transportation in the interest of information exchange. The United States Government assumes no liability for its contents or use thereof.

In no event shall MCC or the MCC parties be liable for any indirect, incidental, exemplary, special, punitive, or treble or consequential damages or losses, whether such liability is based on contract, warranty, tort (including negligence), product liability, or otherwise, regardless as to whether they have notice as to any such claims.

Any opinions, findings, conclusions, or recommendations expressed in this publication are those of the author(s) and do not necessarily reflect the view of the Federal Railroad Administration and/or U.S. DOT.

Trade or manufacturers' names any appear herein solely because they are considered essential to the objective of this report.

Hazardous Uses

None of the information contained in this document may be used in connection with the design, manufacture or use of any equipment or software intended for use in any fail safe applications or any other application where a failure may result in loss of human life or personal injury, property damage, or have a financial impact or in connection with any nuclear facility or activity or shipment or handling of any hazardous, ultra hazardous or similar materials ("Hazardous Uses"). MCC disclaims all liability of every kind for any Hazardous Uses, and you release MCC and the MCC Parties from and shall indemnify MCC and the MCC Parties against any such liability, including, but not limited to, any such liability arising from MCC's negligence.

Copyright and Trademark

Meteorcomm® and ITCnet® are registered trademarks of Meteorcomm LLC, and may not be used without express written permission of Meteorcomm LLC.

Trade or manufactures name may appear herein solely because they are considered essential to the objective of this report. The United States Government does not endorse products or manufacturers.

Document Number: 00002455-A

Table of Contents

Project Detail:	1
VSWR Test.....	8
TABLE A VSWR Plots.....	8
Insertion Loss	12
TABLE B Insertion Loss Plots	12
Antenna Isolation Test	15
TABLE C Antenna Isolation Plots	16
TABLE D Antenna Isolation Chart.....	28
Receive Intermodulation Test.....	44
Transmit Intermodulation Test.....	52
EMI Testing	56
BER Testing.....	74
TABLE E BER Test Results	78
Summary:	79

Project Detail:

Contract Number	FR-TEC-0003-11-01-00
Dates of Survey	March 12 th to 16 th , 2012
Locations	CSX Locomotive Facility Cumberland, MD 39.628519 N LAT, -78.764285 W LON, elev. 650 feet
Test Engineers	Derek Edmondson, James Midyette

The testing location for this locomotive was in Cumberland, MD at the CSX rail yard. The locomotive was located on a siding near the maintenance building and was stationary throughout the testing period.



CSX Cumberland, MD Yard
Figure 1



CSX Cumberland, MD Yard
Figure 2



Locomotive under test CSX 985
Figure 3



CSX 985 Roof Layout

Figure 4

The locomotive was outfitted with a STI-CO PTC antenna array part number HDLP-MB-PLL25-TFM which included PTC 220, CEL A, CEL B GPS and WIFI antennas, a GE antenna array, Cellular antenna, and a MATRIX MBS2 cellular satellite GPS system.



STI-CO HDLP-MB-PLL25-TFM

Antenna Array

Figure 5



GE Antenna Array System

Figure 6



Cellular Antenna

Figure 7



Matrix MBS2 System

Figure 8

The radio systems included AAR Voice, a Quantum UHF HOT/EOT system as well as the CTI REX MDU system. The PTC radio system was not installed. A STI-CO VHF filter FILT-NB-160-MIL-U was installed standard near the VHF radio.



AAR Voice Radio
Figure 9



Distributed Power Radio
Figure 10



Coleman REX MDU
Figure 11



Wabtec HOT /EOT Radio



Plate Corrosion
Broken Antennas
Figure 12

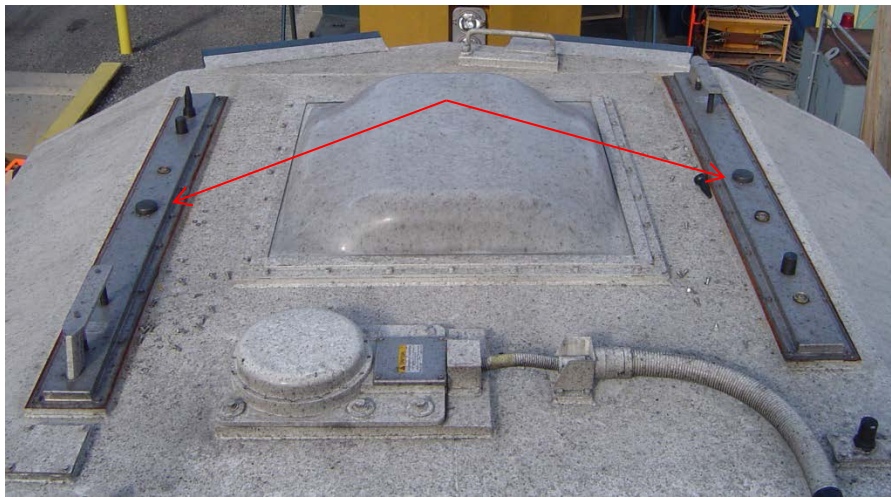

Offset GPS
Figure 13a

Some issues notes at the time of testing were several of the 7-800 antennas were broken off of the STI-CO antenna array (Figure 12). The antennas were replaced and tested for proper operation. We also noted corrosion forming on the mounting plate under the antenna array. This area should be painted to prevent loss of electrical contact.

The normal suggested placement of the antenna bars would have the GPS sensors placed directly across from each other on the cab roof. These antenna arrays were offset by approximately five inches (Figure 13a). This variation is not expected to impact testing.

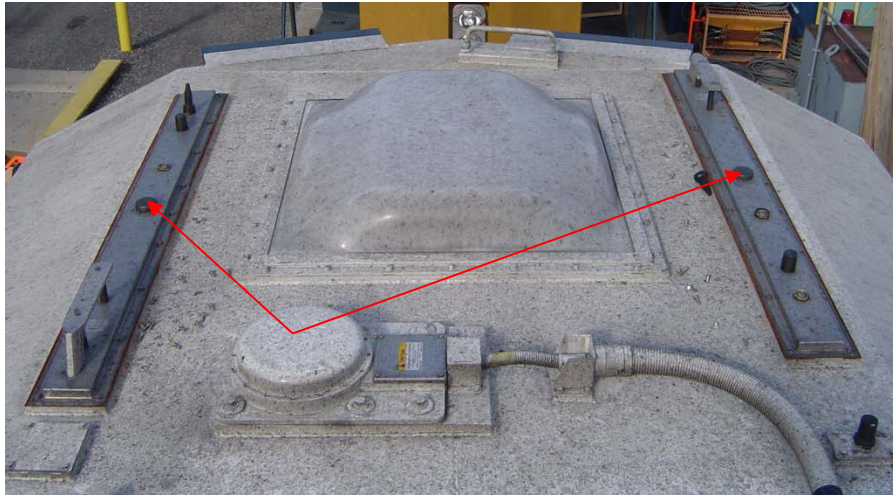

MBS2 TX Proximity to GPS RX
Figure 13b

This Locomotive is equipped with a Matrix MBS2 combination Cellular and Satellite Terminal. During testing, it was not possible to initiate a transmission with the MBS-2 to test any possible interaction with PTC equipment.

Post-testing research has revealed that the Satellite portion operates in the L-Band (TX 1626.5 MHz to 1660.5 MHz) at significant power levels (+37.5 dBm to +46.5 dBm). The PTC GPS also operates in the L-Band (1575.42 MHz), and the adjacent GPS receiver antennas will be acquiring GPS signals at \sim -130dBm, while the MBS-2 will, at times, be transmitting at up to \sim +46 dBm \sim 80 MHz up-band from the GPS operating frequency. Note that the PTC GPS Antennas are equipped with integral 40 dB LNAs. This configuration results in an RF power delta of 176 dB less than 80 MHz. While the MBS-2 is equipped with its own GPS, it is likely that such a unit would be protected by integrated filtering within the MBS-2 assembly. The PTC GPS Antennas and 40 dB LNAs enjoy no such protection. Further testing for interference and possible damage is recommended.

VSWR Test

This test is designed to collect VSWR data in several formats for use in locomotive noise and intermodulation reporting. The test involved collecting voltage standing wave ratio and return loss data in the following formats; VSWR, S1P scatter parameters, comma separated values, and a portable network graphics. It is important to know if the antenna system is properly matched to the transceiver equipment as this can be a source of intermodulation and/or standing waves in the RF system. The first set of data was collected at the RF port located closest to each antenna element in the locomotive radio frequency system to give an accurate picture of antenna matching. A second set of data recorded the VSWR at the end of the transmission line cable that connects to the radio transceiver antenna connector, including any installed filtering to show what the full system response is that is presented to the transceiver. This measurement includes all system losses.

This test helps us to characterize the band pass parameters of the antenna. The information is useful in determining how much the antenna element contributes to filtering out of band energy as well as whether or not the antenna is functioning correctly. The results from the VSWR testing indicated all antennas and associated components were functioning properly. The full data from this testing has been presented in Appendix A. Typical data recorded from the locomotive is presented in Table A below.

TABLE A VSWR Plots

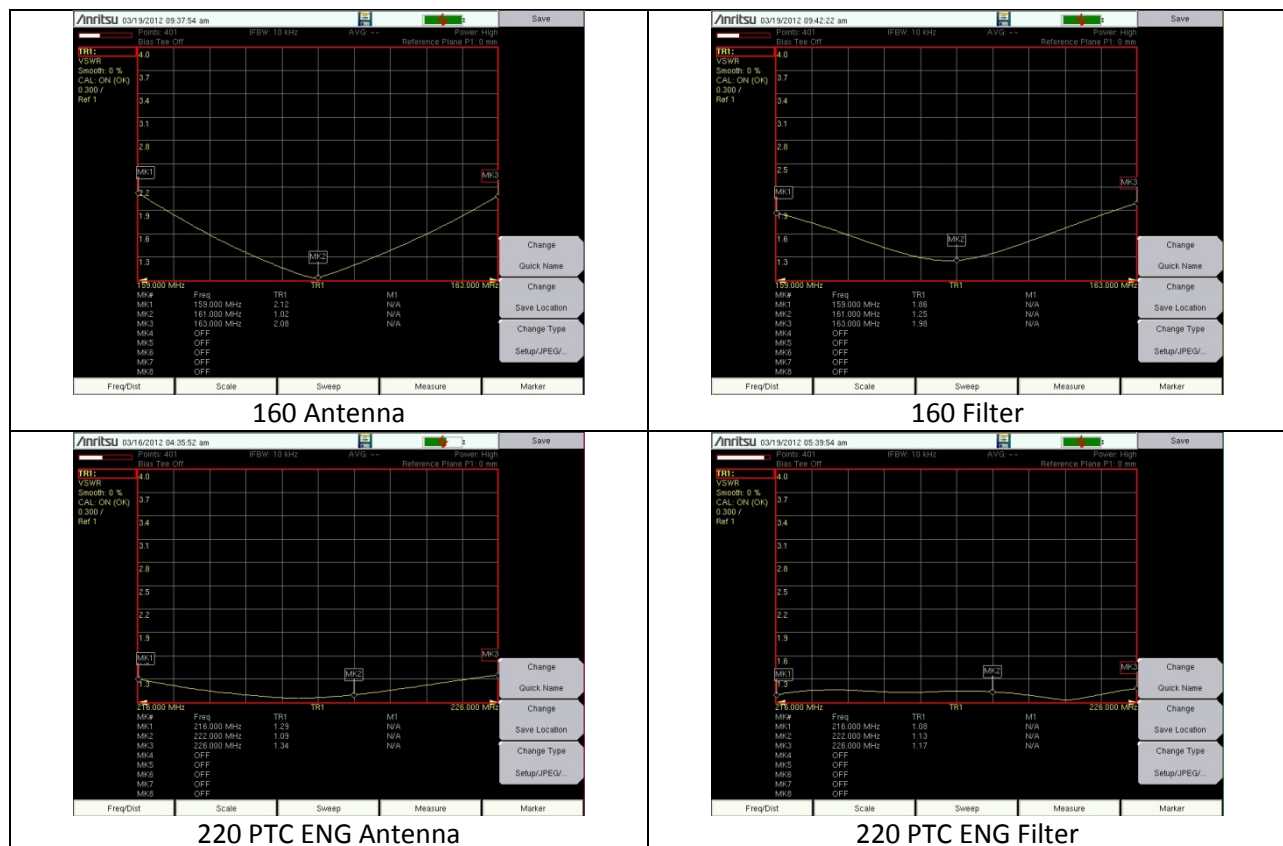

TABLE A VSWR Plots

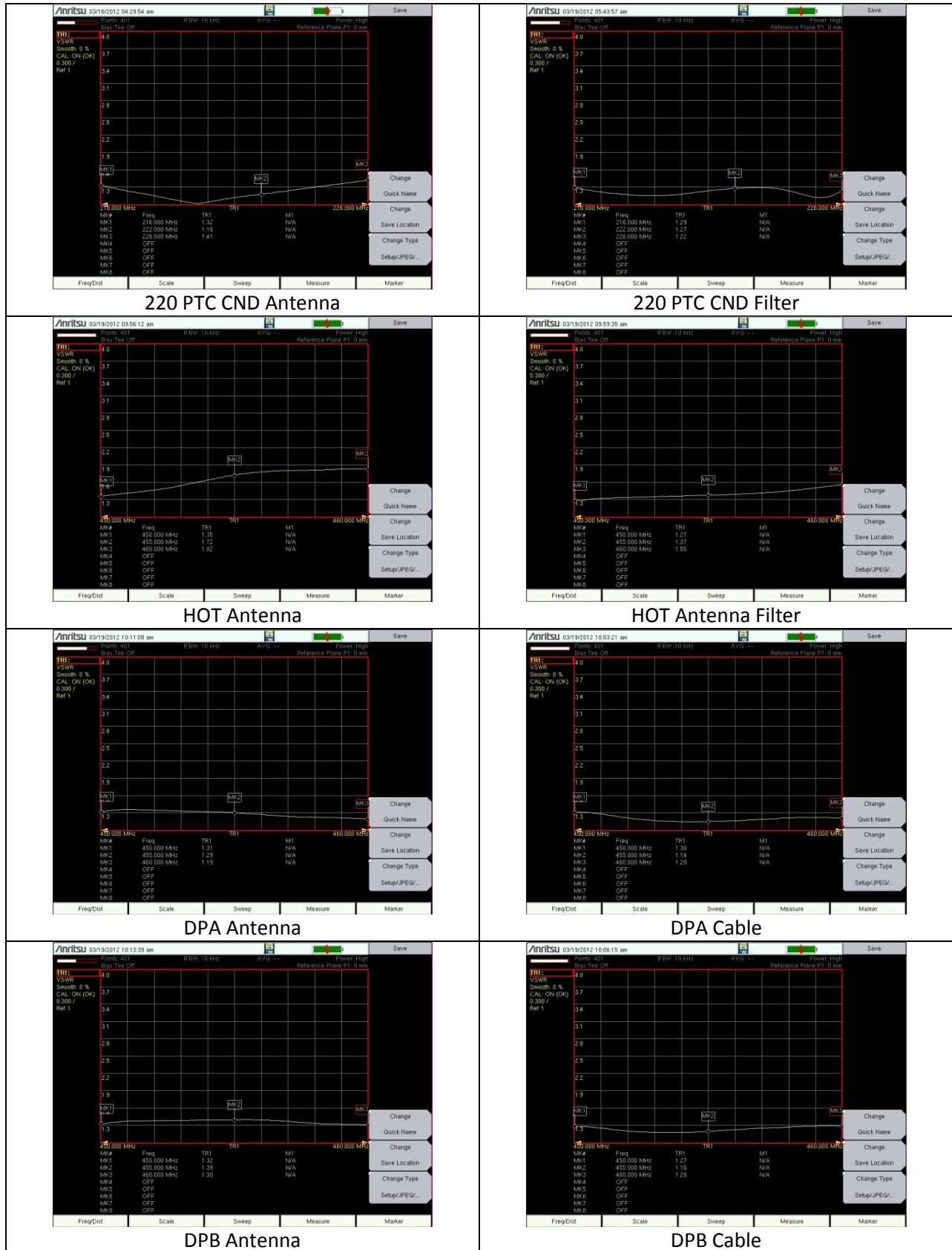

TABLE A VSWR Plots

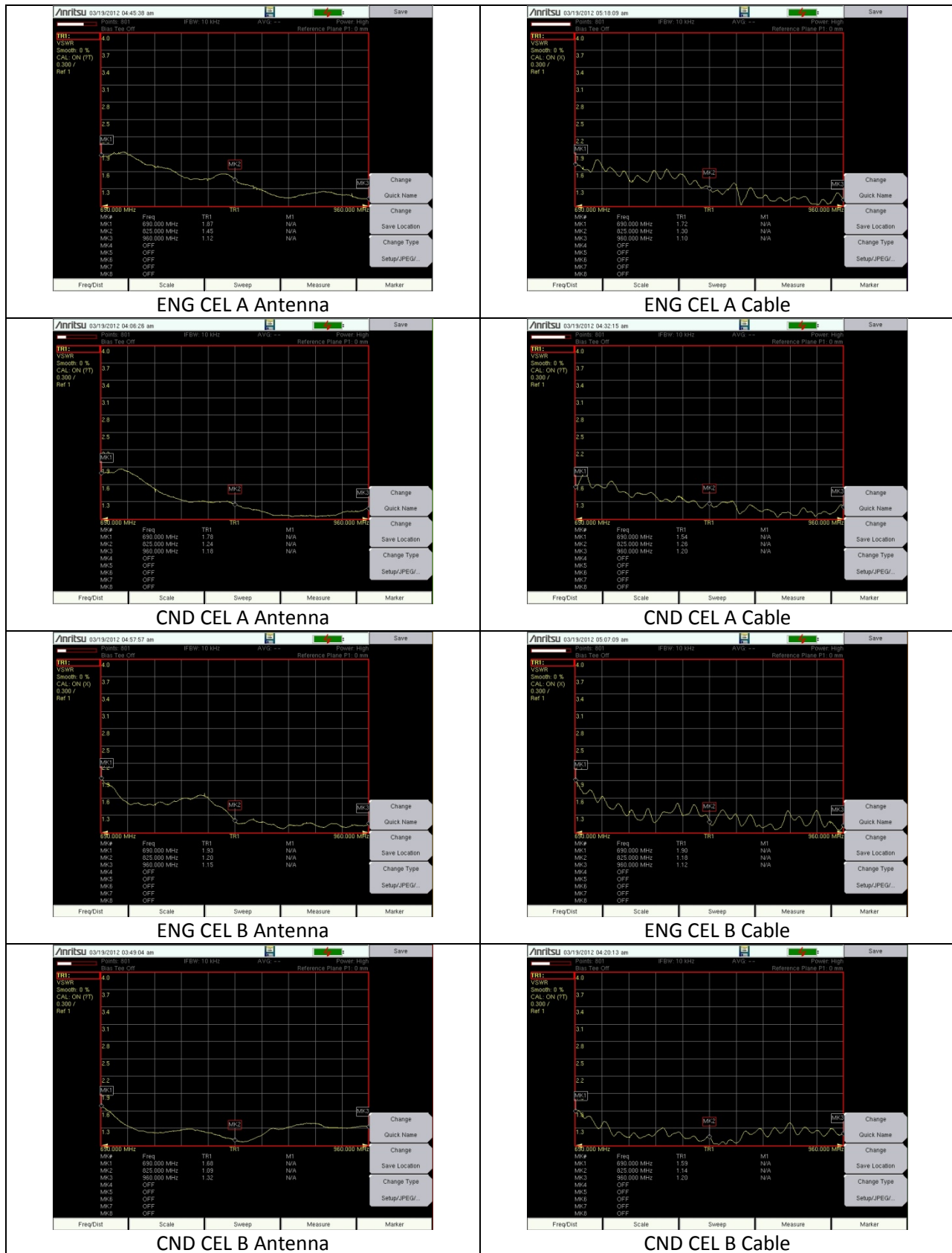
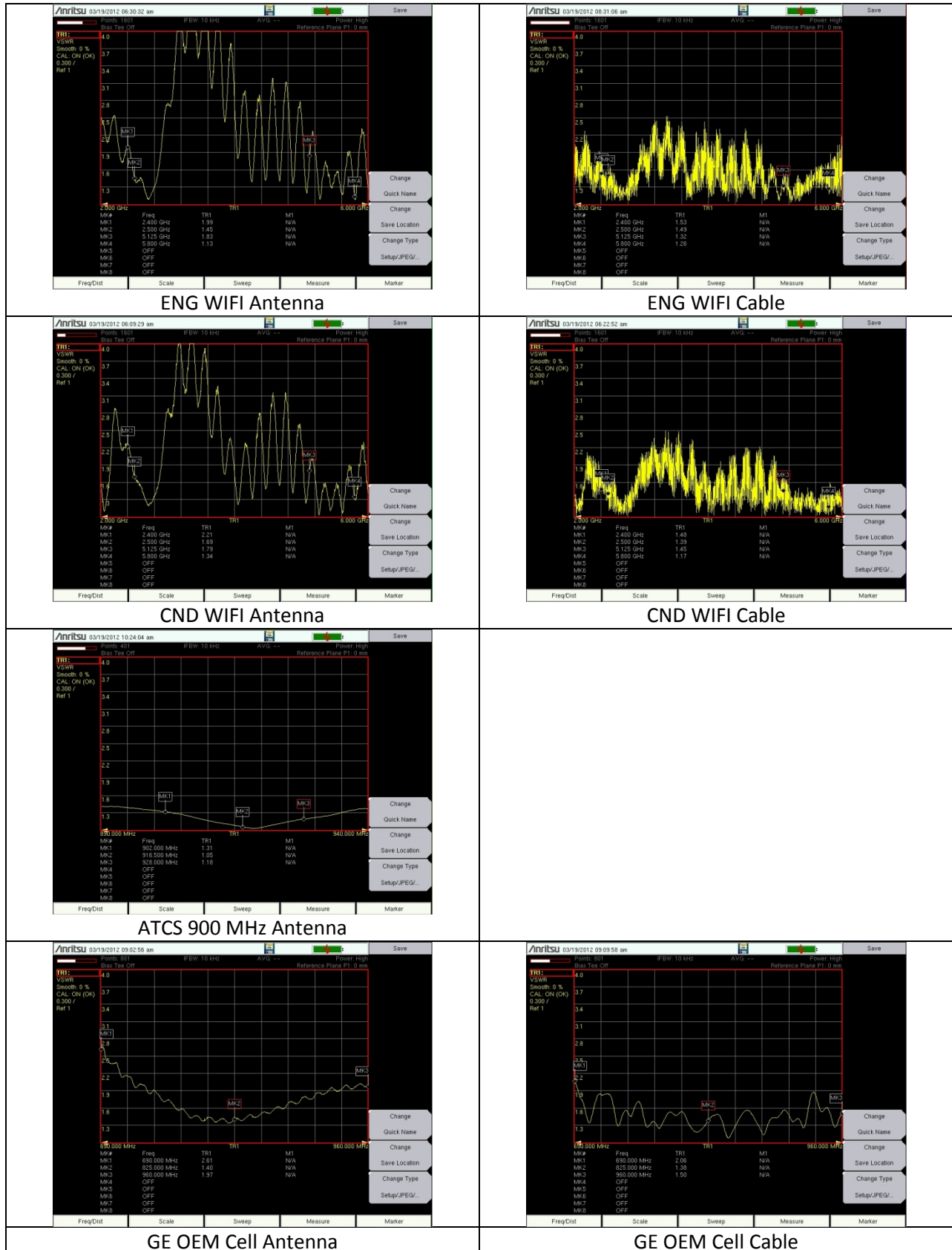

TABLE A VSWR Plots



Insertion Loss

This test is designed to collect insertion loss data in several formats for use in locomotive noise and intermodulation reporting. The test involved collecting insertion loss data in the following formats; insertion loss in dB, S1P scatter parameters, comma separated values, and a portable network graphics. It is important to know how much loss is experienced in the system in order to determine the impact on transmitted power and intermodulation effects. The test was performed on the transmission lines by measuring the loss from the antenna connection port to the equipment port. The test is frequency specific and each cable was measured based on the appropriate frequency range.

This test is useful for evaluating cable integrity and detects any extraordinary losses that are present in the system. At the completion of this testing it was found that all on-board elements were in compliance as compared to planned values. A full report has been included in Appendix B.

TABLE B Insertion Loss Plots

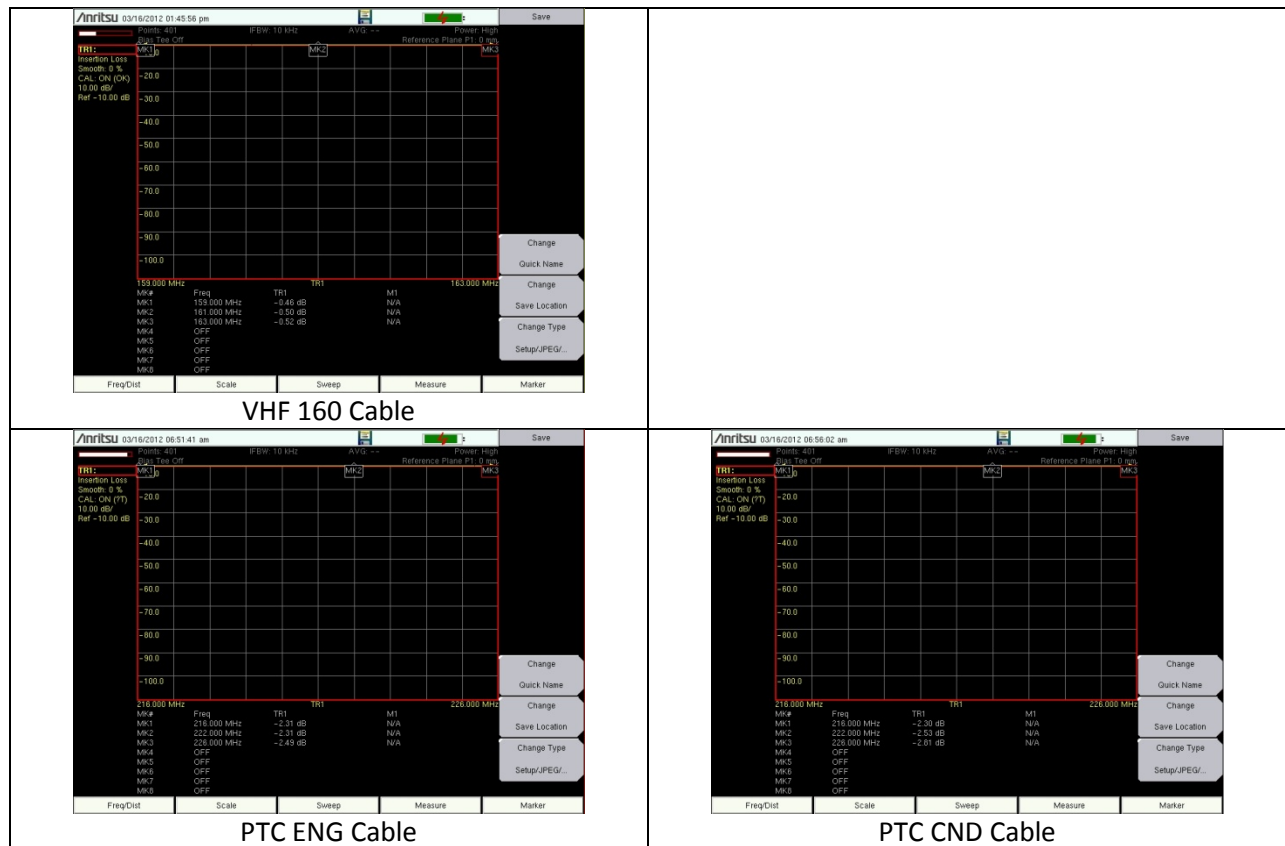

TABLE B Insertion Loss Plots

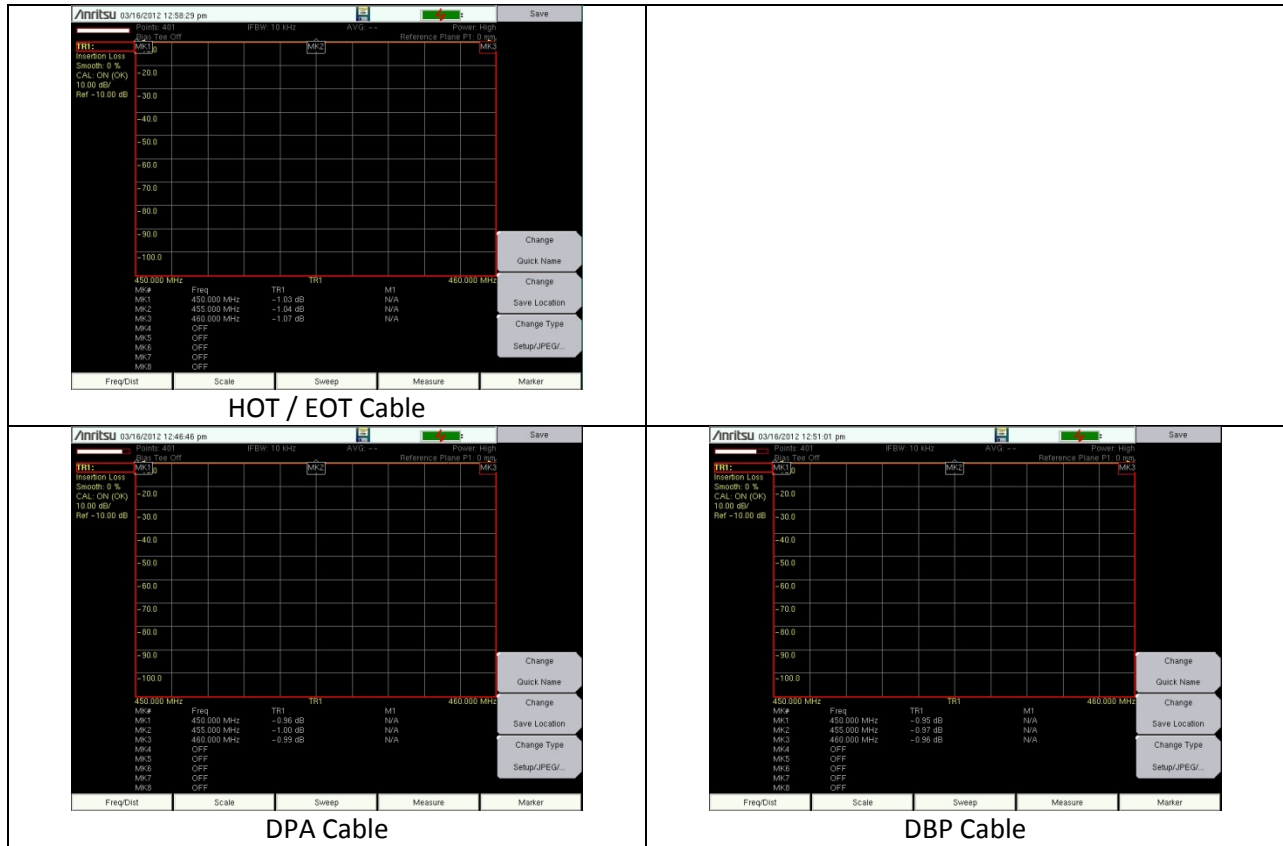
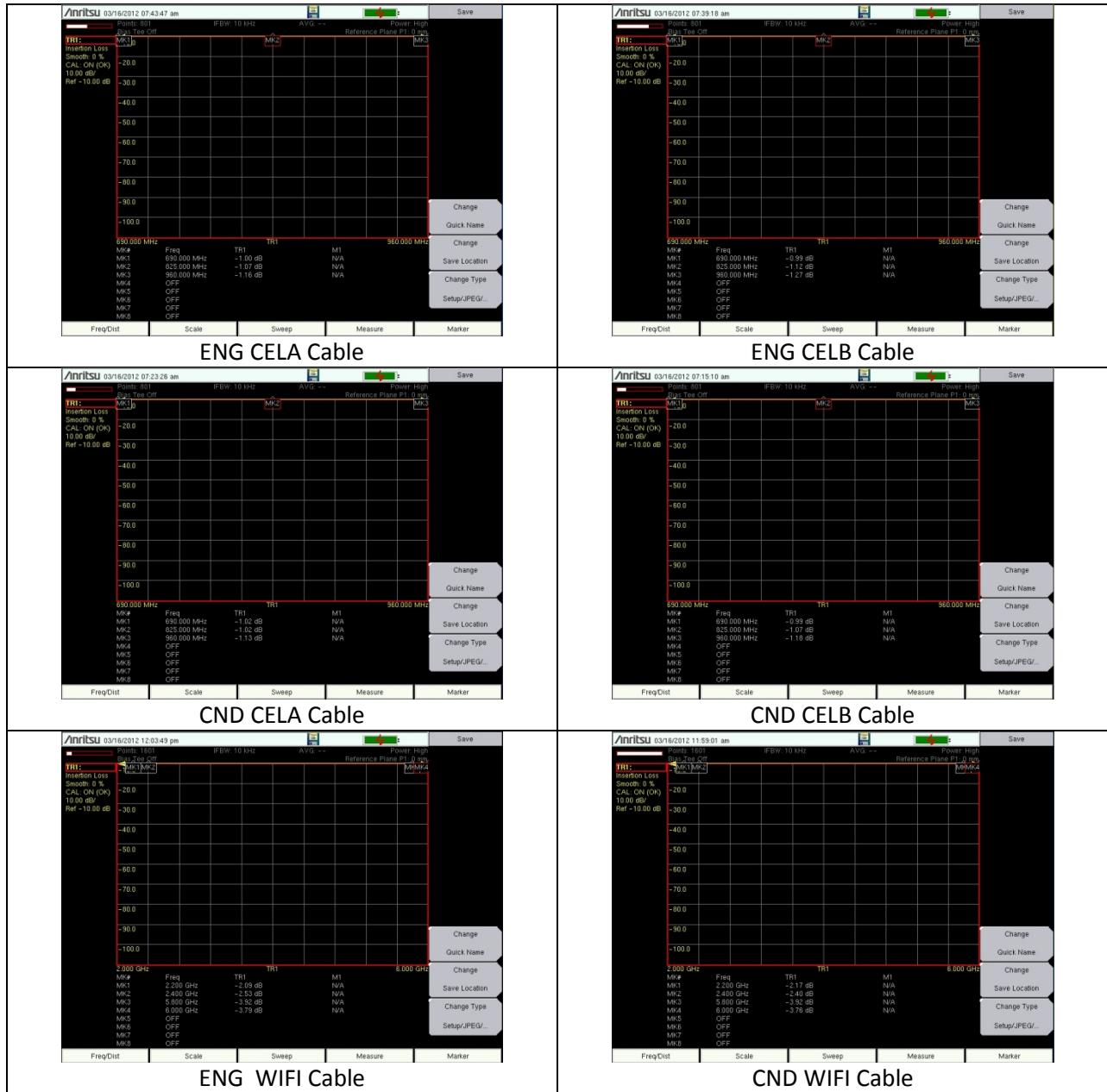

TABLE B Insertion Loss Plots



Antenna Isolation Test

This test is designed to collect information on the amount of free space isolation between each antenna and each other antenna. This value in decibels and is used to calculate the amount of power from each radio impacting each other radio receiver front end during transmission. High signal levels impacting the receiver front end of a radio in receive mode may cause harmful intermodulation products in proportion to the power received from the transmitting radio. The antenna isolation data is also used to determine the need for filtering in the system.

The test was performed by measuring the loss from the transmitting radio antenna to each other antenna, and the data was recorded in decibel format. The information gathered from this test correlates to the amount of intermodulation that is present in the roof environment, and possible prevention methods.

The test is executed without filters, and then executed with any filters under consideration by the Railroad.

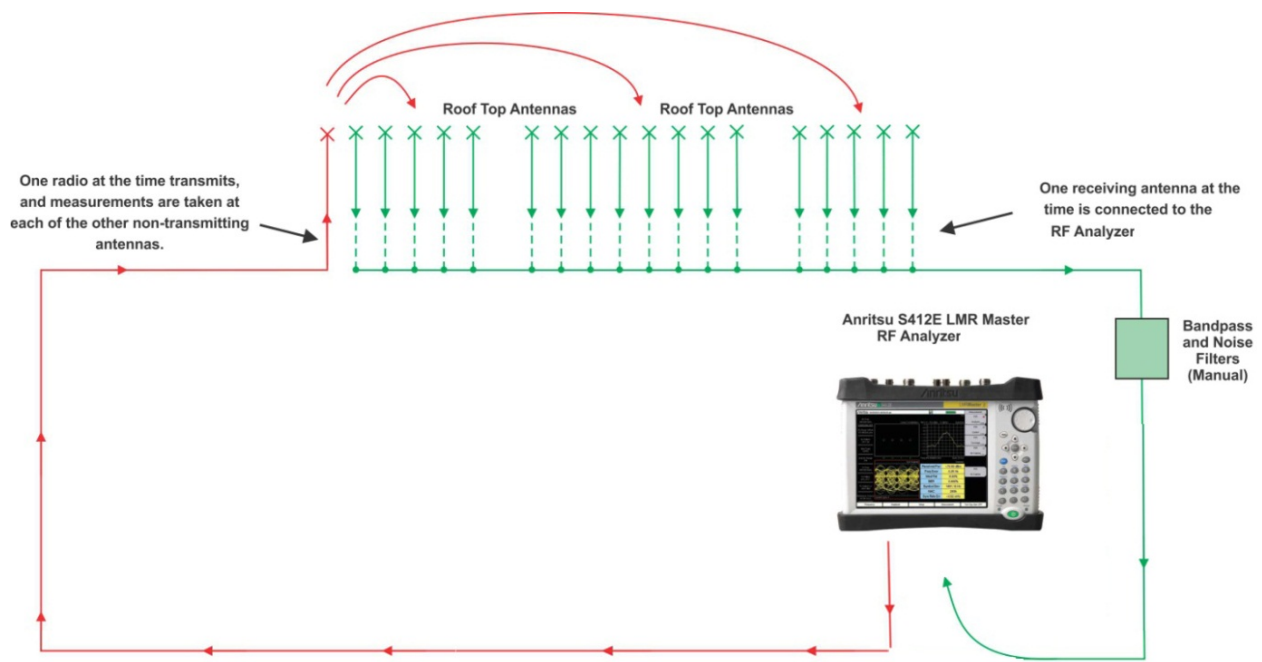

Antenna Isolation Testing Configuration
Figure 14

TABLE C Antenna Isolation Plots

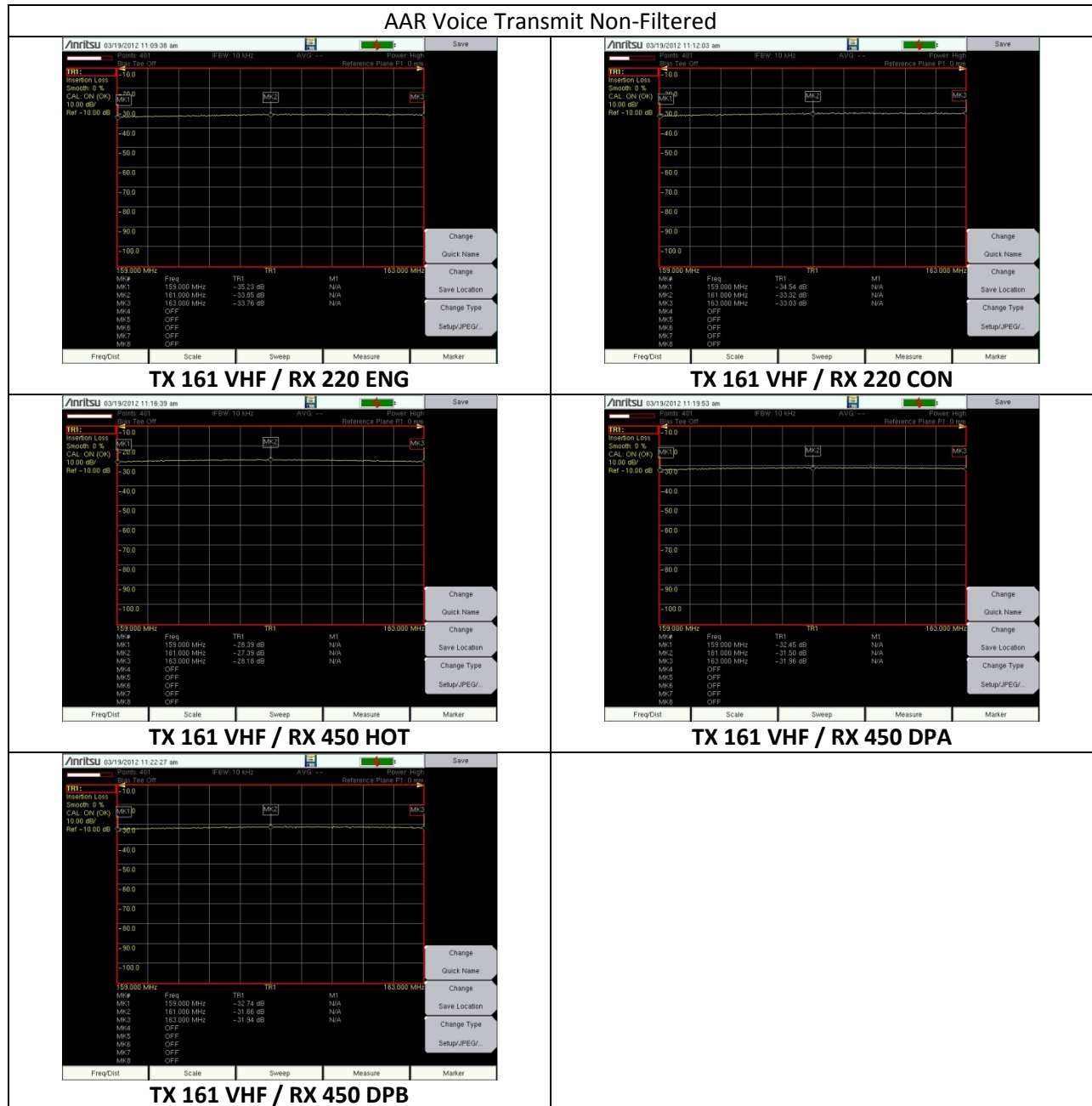

TABLE C Antenna Isolation Plots

AAR Voice Transmit Filtered

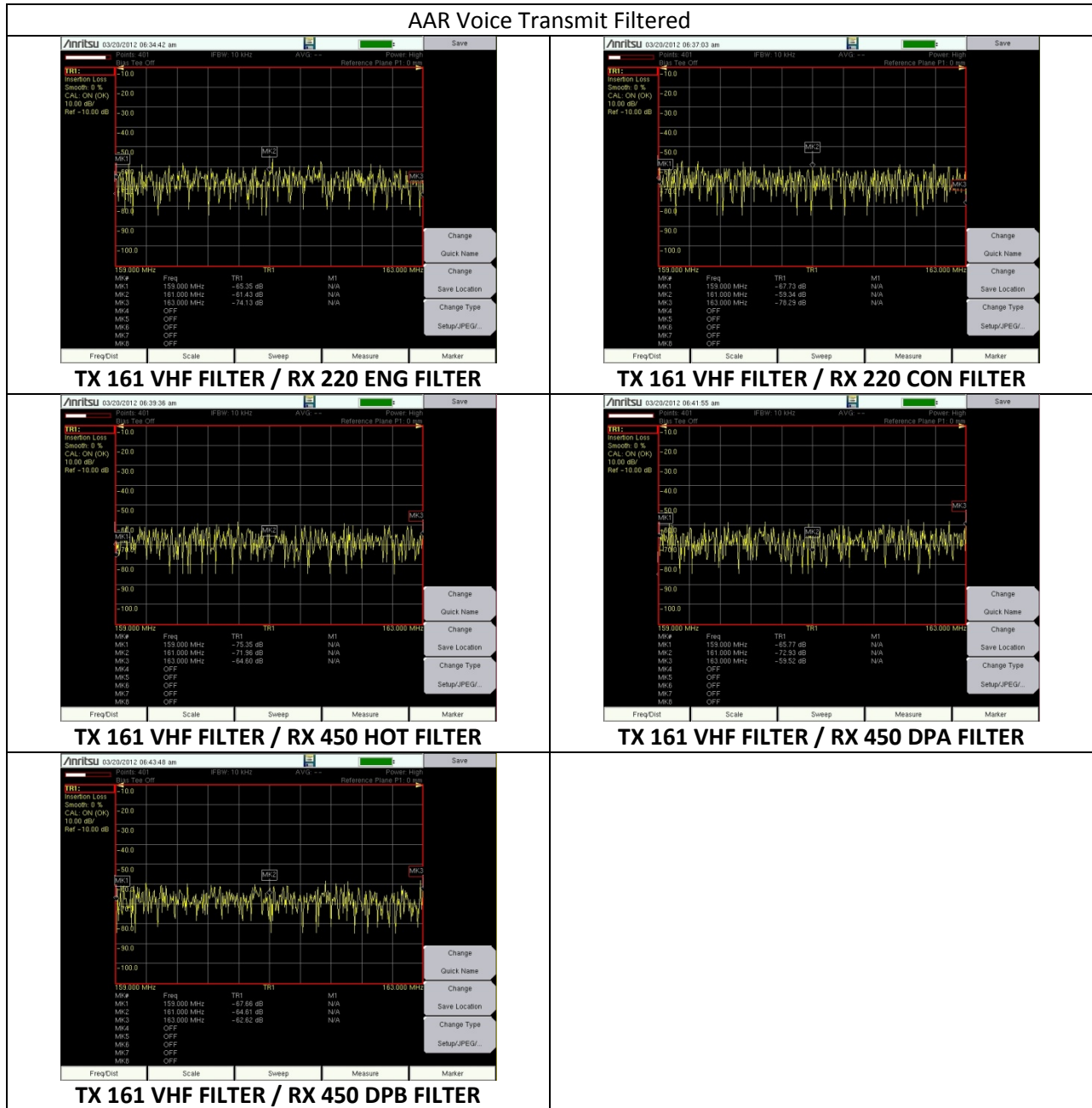

TABLE C Antenna Isolation Plots

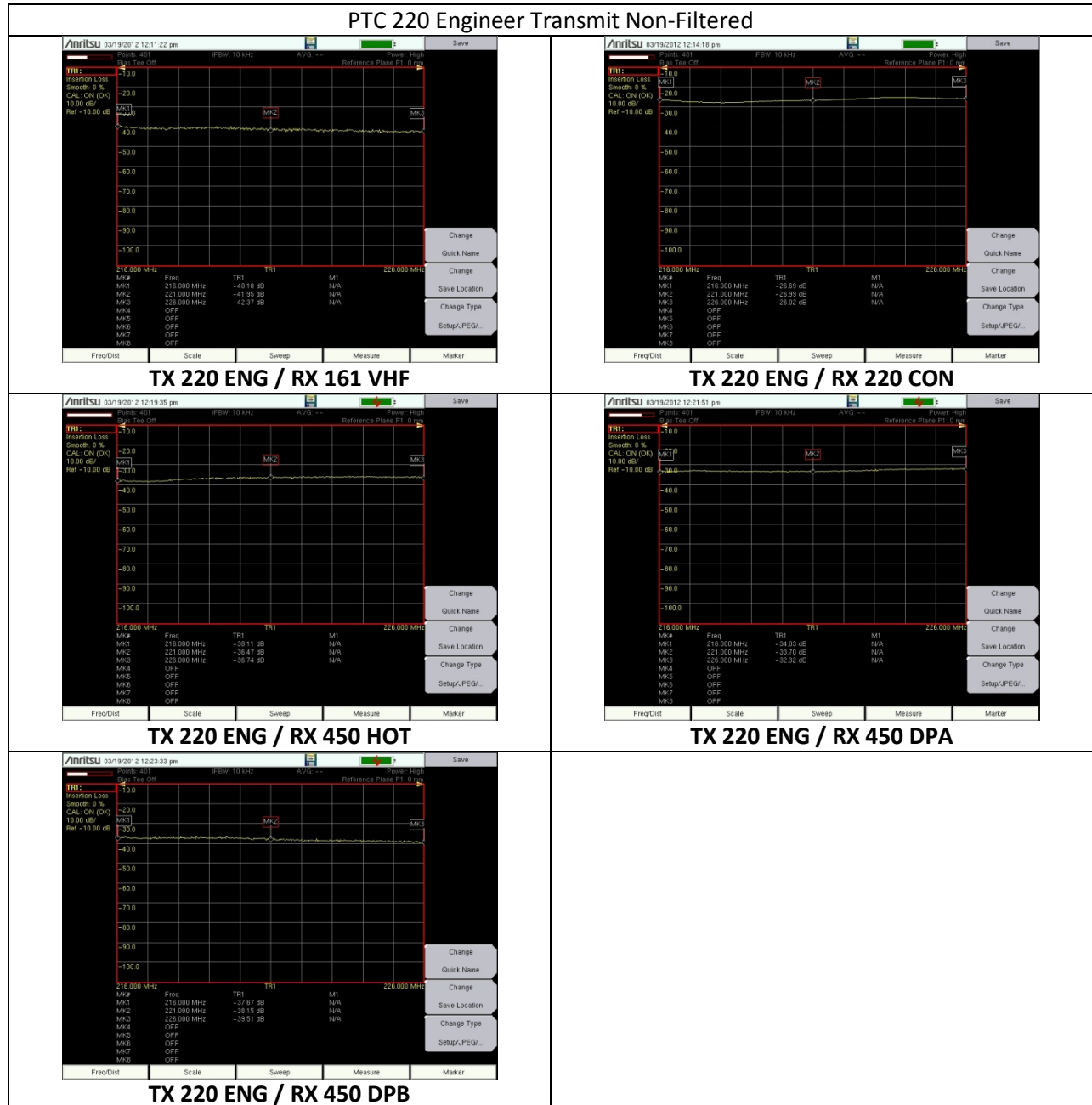

TABLE C Antenna Isolation Plots

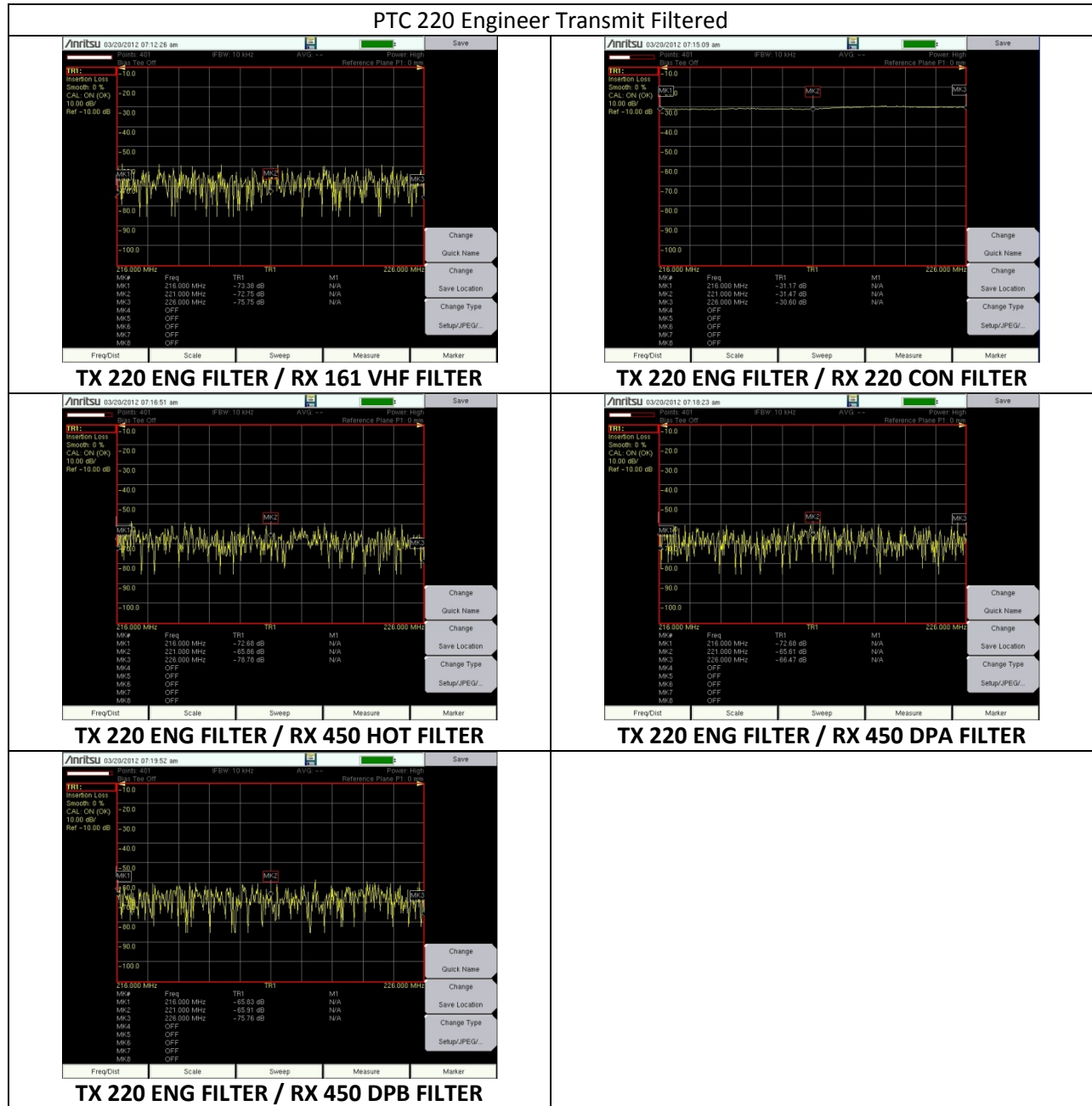

TABLE C Antenna Isolation Plots

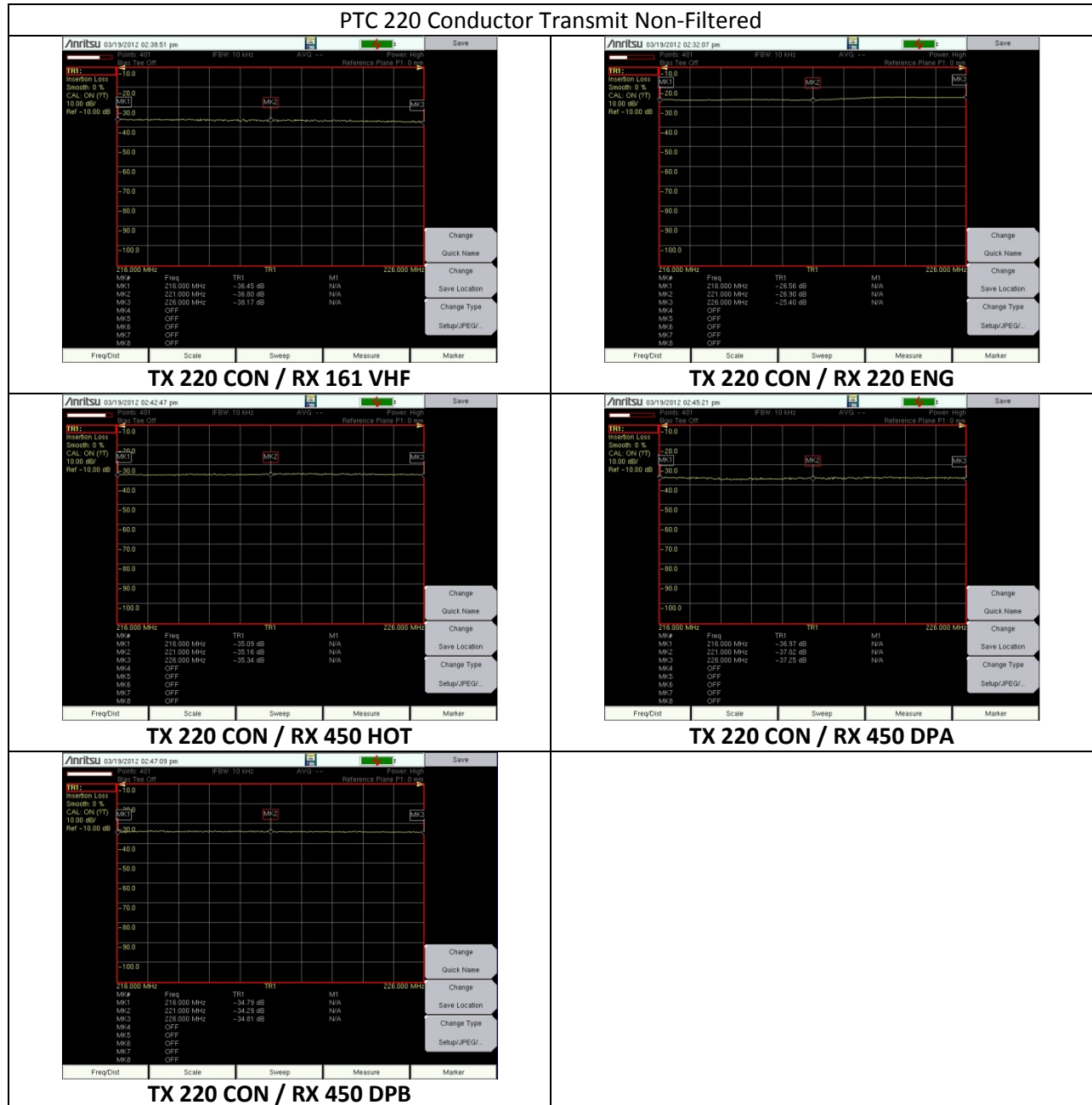

TABLE C Antenna Isolation Plots

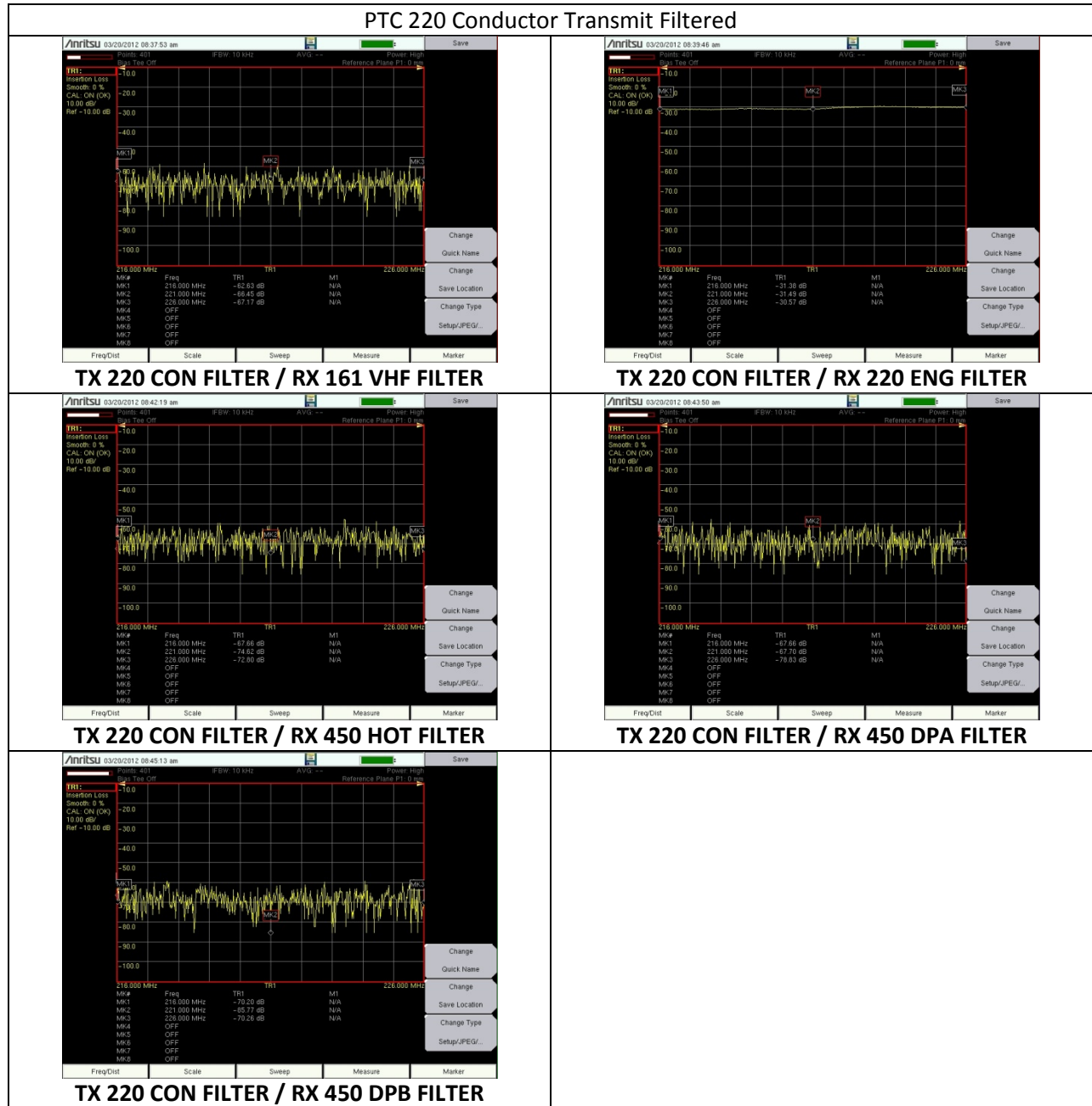

TABLE C Antenna Isolation Plots

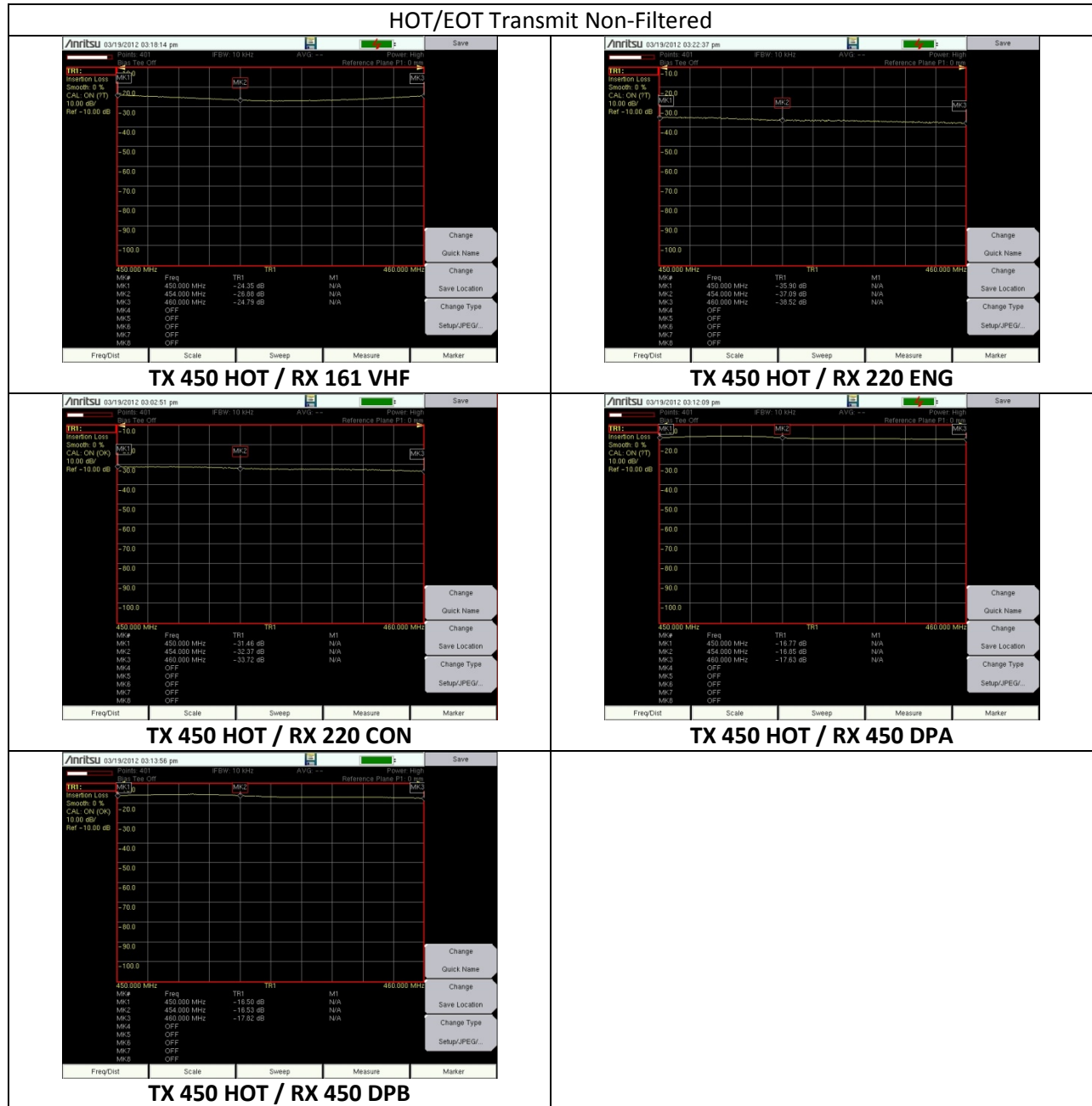

TABLE C Antenna Isolation Plots

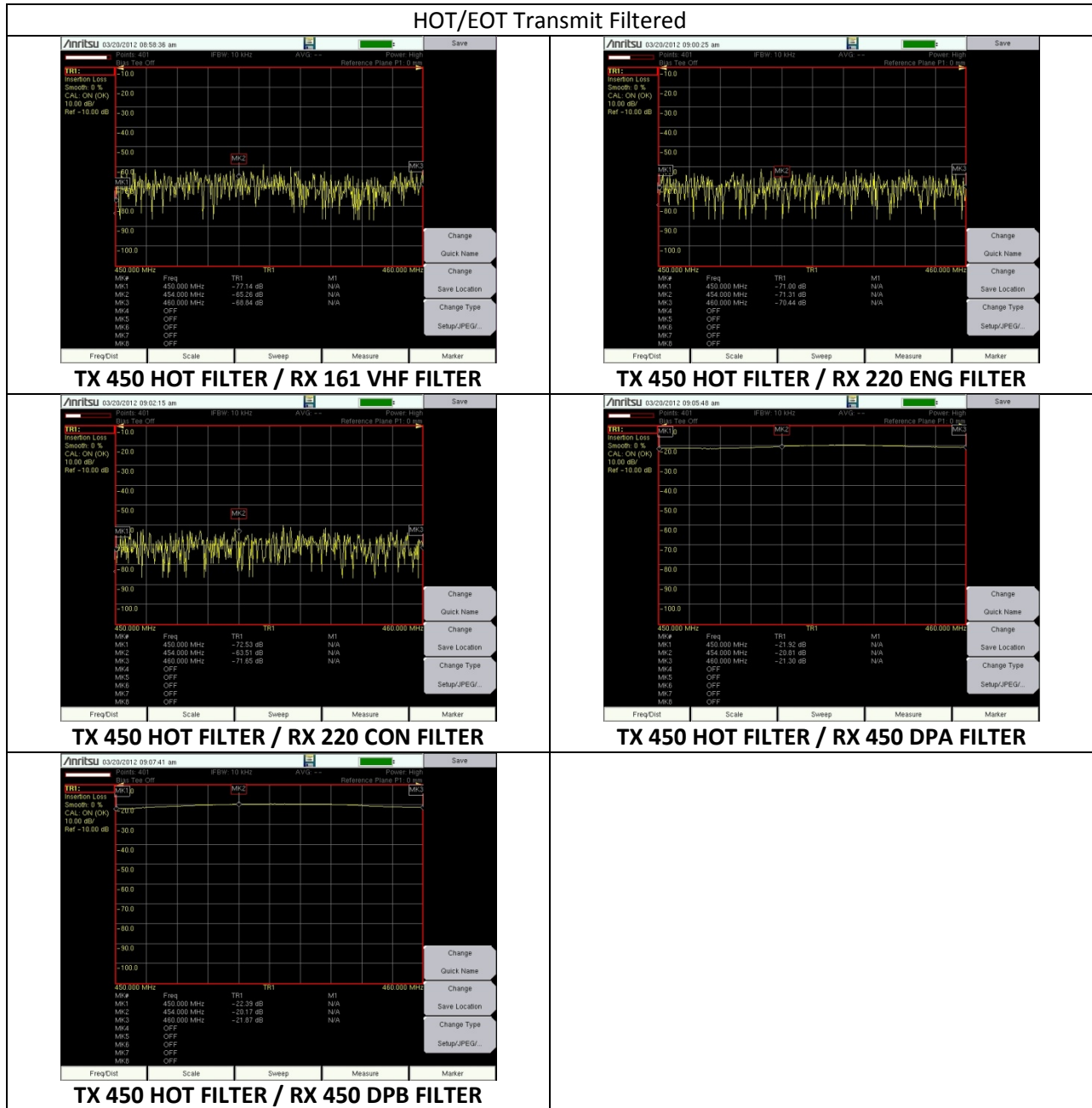

TABLE C Antenna Isolation Plots

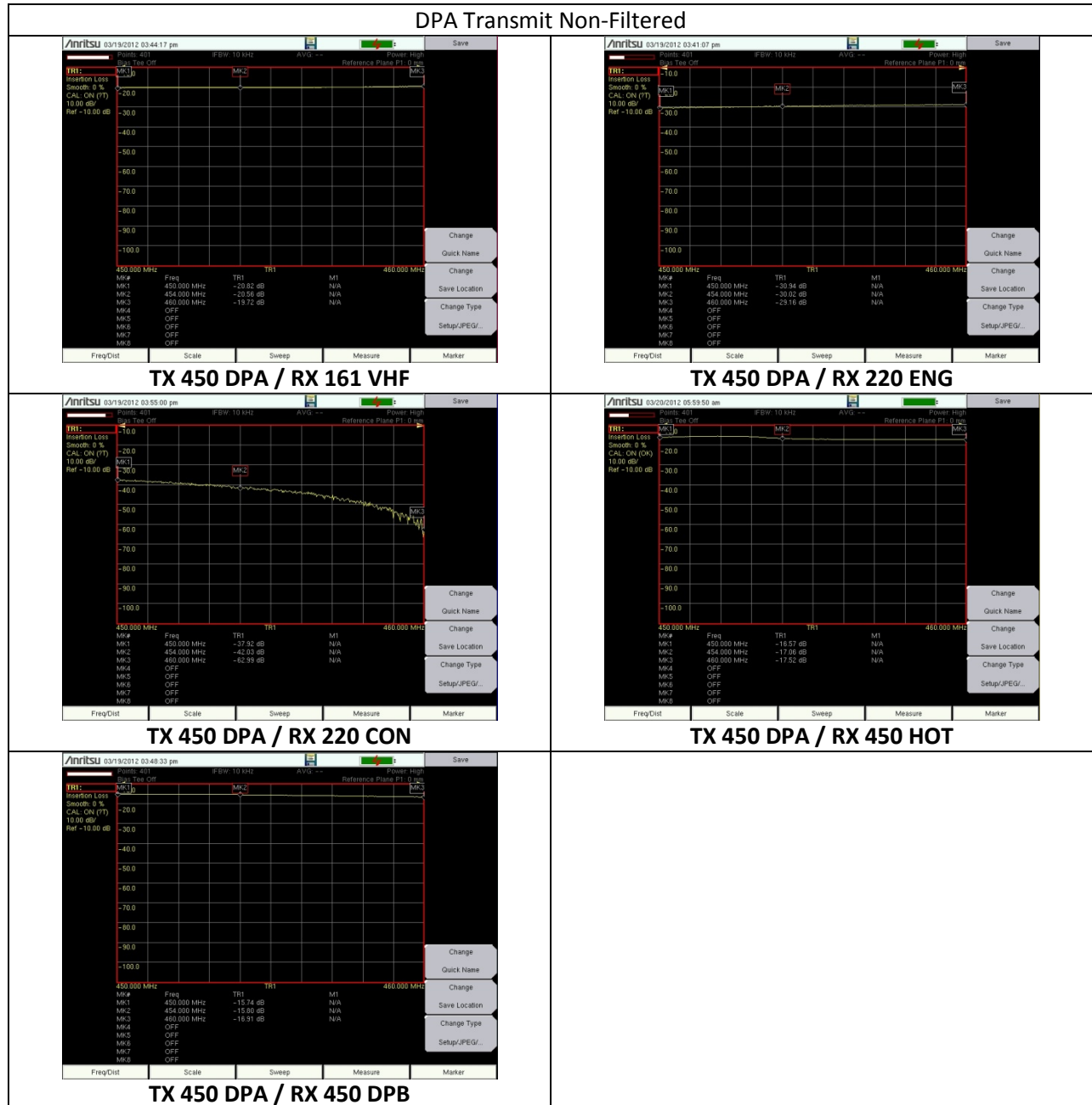

TABLE C Antenna Isolation Plots

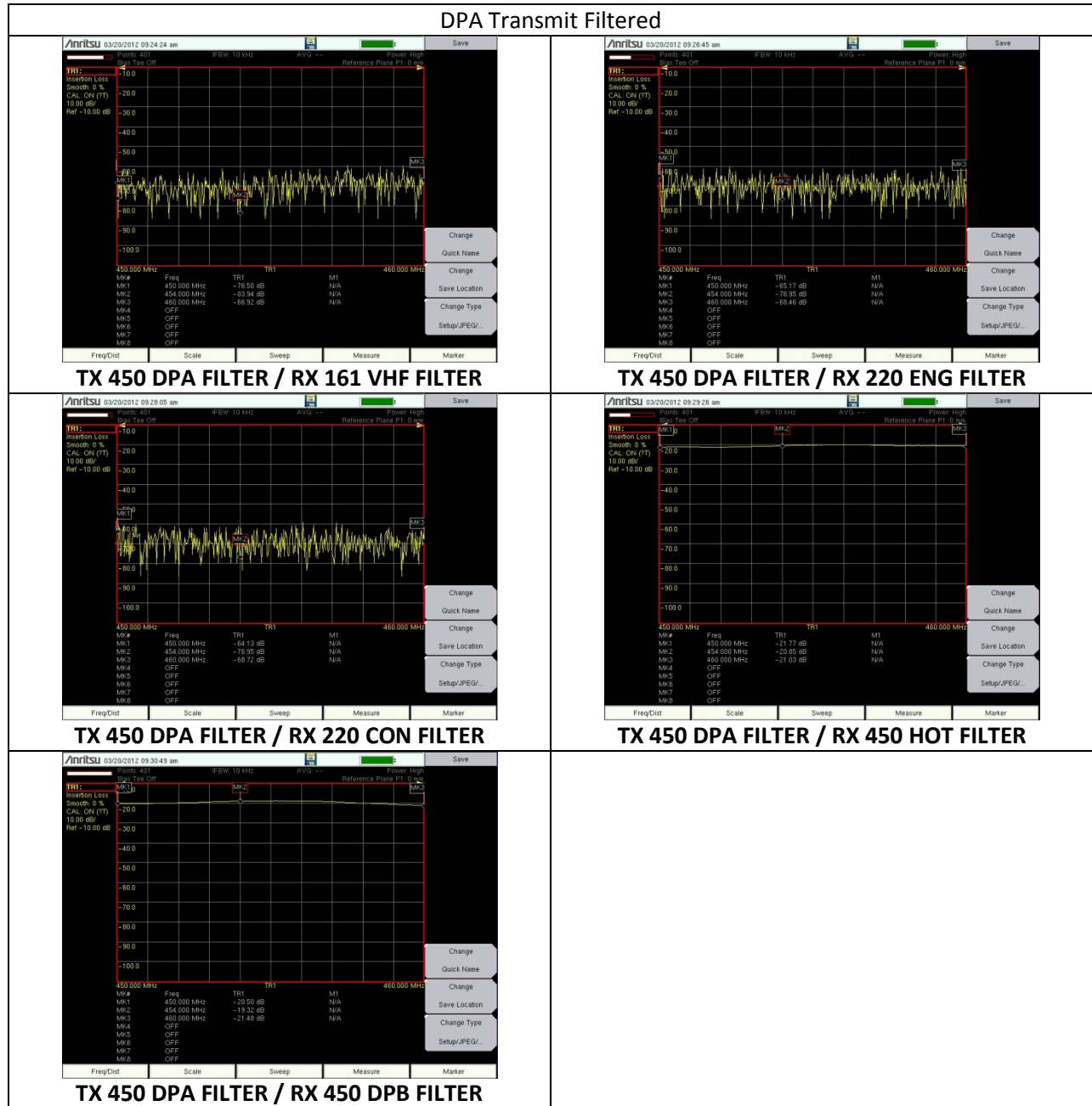

TABLE C Antenna Isolation Plots

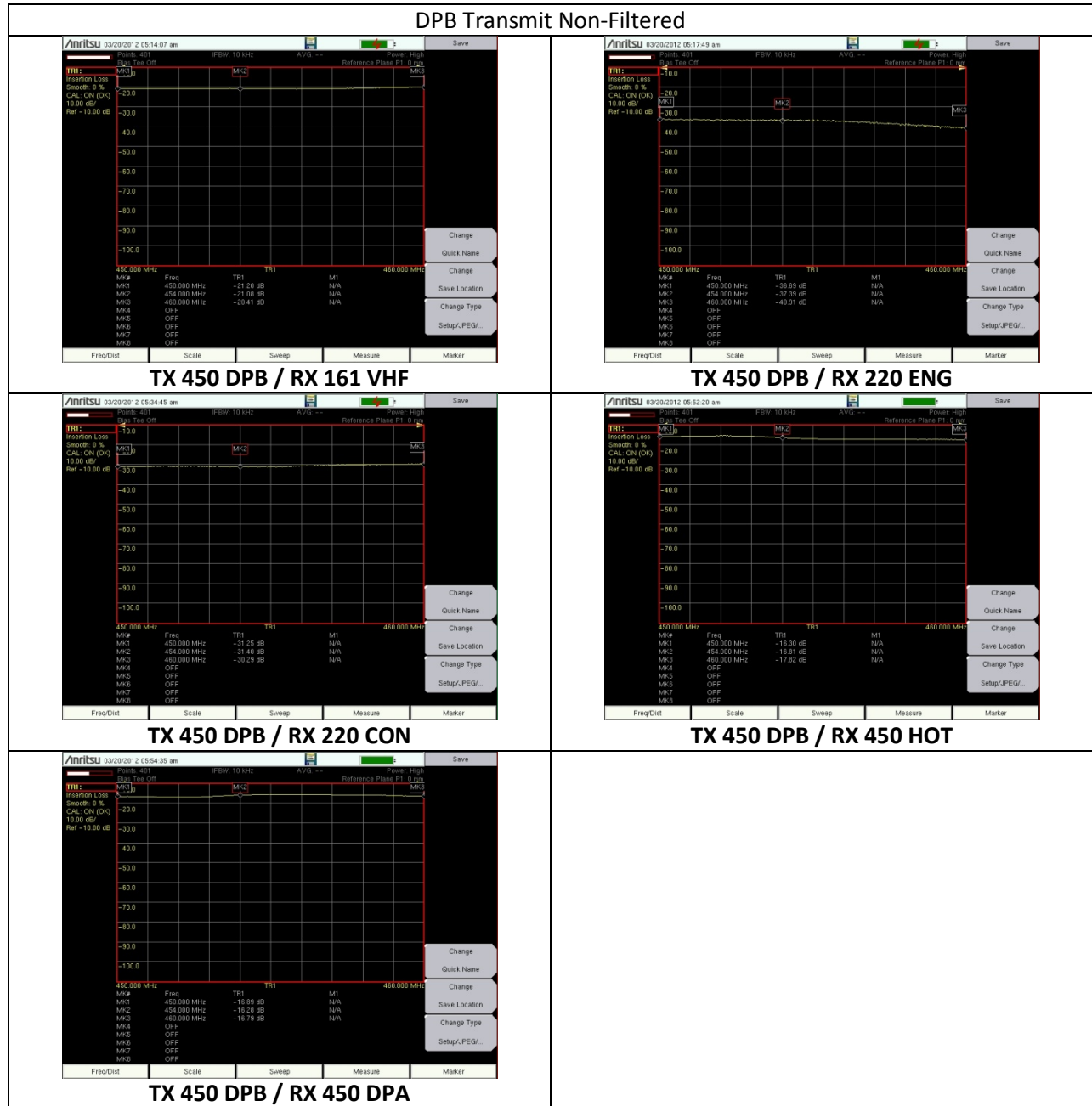

TABLE C Antenna Isolation Plots

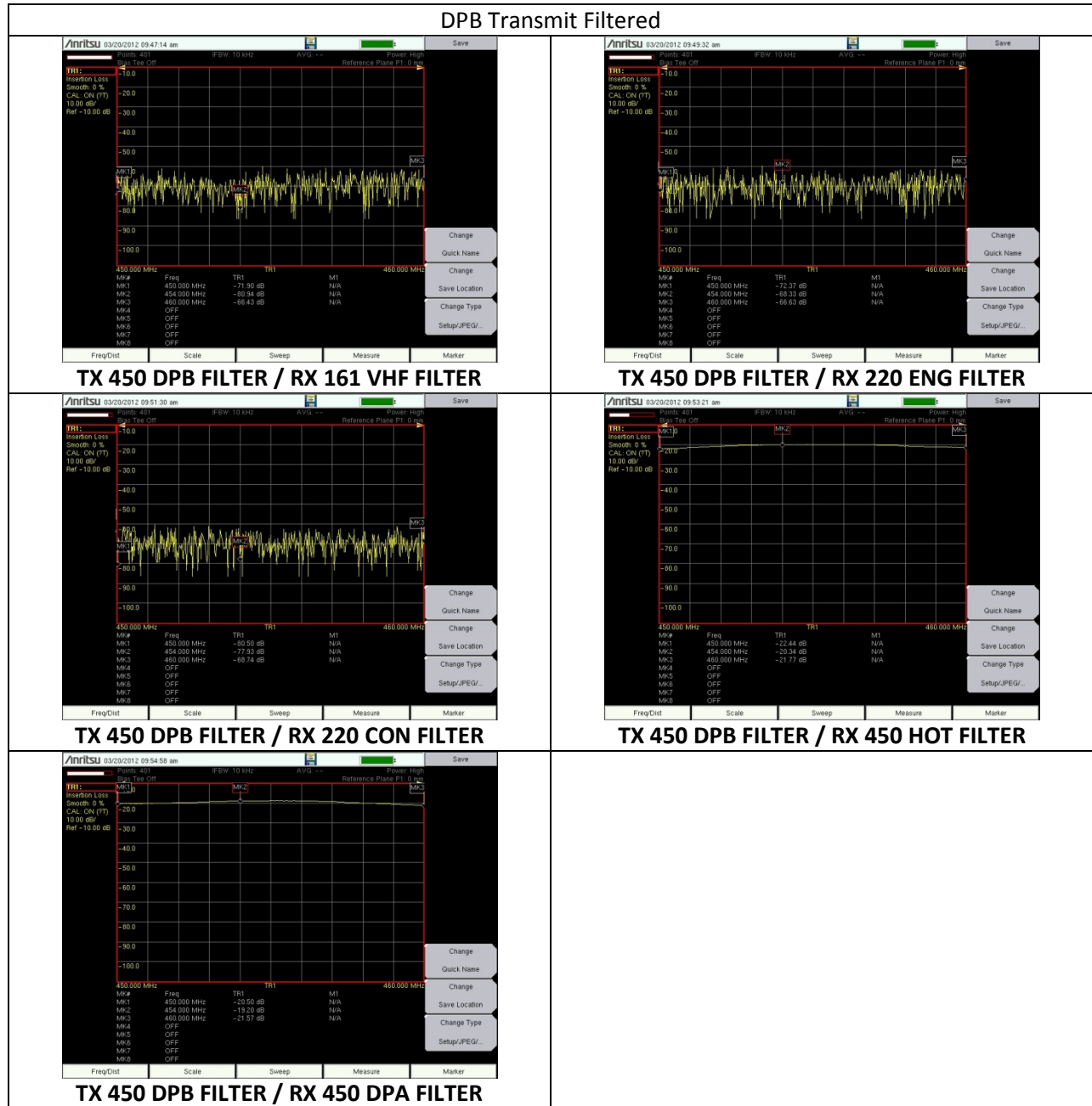

TABLE D Antenna Isolation Chart

Receive Band	VHF 161	220 ENG	220 CON	EOT 450	DPA 450	DPB 450	GE OEM CEL	ENG CEL 1 BLU	ENG CEL 2 GRY	ENG WIFI 2 GRN	CON CEL 2 GRN	CON CEL 1 ORG	CON WIFI 1 BLK
Transmit Band	(dBm)	(dBm)	(dBm)	(dBm)	(dBm)	(dBm)	(dBm)	(dBm)	(dBm)	(dBm)	(dBm)	(dBm)	(dBm)
VHF 161	TB	-34	-33	-27.5	-31.5	-31.5	-44	-37	-38	NF	-38	-35.5	NF
220 ENG	-41.5	TB	-27	-37	-33.5	-38	-41	-32	-33.5	NF	-41.5	-41	NF
220 CON	-37	-27	TB	-35	-37	-34.5	-45	-44	-40	NF	-33.5	-31	NF
EOT 450	-27	-37	-32.50	TB	-17	-16.5	-33	-24.5	-26	-47	-28	-29.5	-50
DPA 450	-20.5	-30	-42	-17	TB	-16	-34.5	-25	-26	-47	-27	-28.5	-49
DPB 450	-21	-37	-31	-17	-16	TB	-44	-33.5	-35	-55	-22	-26	-44
Receive Band	VHF 161 Filter	220 ENG Filter	220 CON Filter	EOT 450 Filter	DPA 450 Filter	DPB 450 Filter	GE OEM CEL	ENG CEL 1 BLU	ENG CEL 2 GRY	ENG WIFI 2 GRN	CON CEL 2 GRN	CON CEL 1 ORG	CON WIFI 1 BLK
Transmit Band	(dBm)	(dBm)	(dBm)	(dBm)	(dBm)	(dBm)	(dBm)	(dBm)	(dBm)	(dBm)	(dBm)	(dBm)	(dBm)
VHF 161 Filter	TB	NF	NF	NF	NF	NF	-46	-39	-40	-55	-39.5	-38.5	NF
220 ENG Filter	NF	TB	-31.5	NF	NF	NF	-44	-34.5	-36	NF	-44	-44.5	NF
220 CON Filter	NF	-31.5	TB	NF	NF	NF	-51	-45	-43	NF	-36.5	-34	NF
EOT 450 (Opt Filter)	NF	NF	NF	TB	-21	-20	-36	-28	-28.5	-51	-31	-29.5	NF
DPA 450 (Opt Filter)	NF	NF	NF	-21	TB	-19.5	-38	-25.5	-27.5	-51	-30	-34	-53
DPB 450 (Opt Filter)	NF	NF	NF	-20	-19.5	TB	-47	-35.5	-35	-58	-24	-28.5	-48

Antenna Isolation Table

The data recorded from the locomotive included both non-filtered and filtered information if the locomotive was equipped, or if future versions were to be equipped with band specific filters.

In the set of figures below, the data from the chart is represented graphically. The heads of the arrows indicate the receiver, while the tails indicate the transmitter. The "A" drawing depicts the isolation data with no filtering and indicates the relationship between antenna spacing and free space path loss with the single element as the transmission source. The "B" figures depict how the addition of the filters provides the increased isolation necessary for use on such a small ground plane area. The "C" diagrams indicate what energy is seen by the primary element from different frequency bands non-filtered, and again the "D" diagrams show the effects of filtering.

Note that measurements designated "<-60 dB" are actually below the noise floor of the instrument.

In addition to spatial separation, there are other factors to be considered such as the antenna element type, frequency response of the element, and filter performance which will contribute to out of band rejection characteristics, and these have been accounted for in the measurements discussed in this section. In the cases where there are diversity or redundant antennas spaced across the locomotive, there is reasonable symmetry in the isolation numbers which tracks with the layout of the antenna elements. The data shows the improvements in isolation that can be achieved by adding filtering to the antenna system. The results here correlate with the intermodulation data discussed later.

CSX 985 (ES44AC - GE) Locomotive Noise Test Report

Receive Band	VHF 161	220 ENG	220 CON	HOT 450	Dist. PWR A	Dist. PWR B	ATCS 900	YARD 900	ENG CEL A BLUE	ENG CEL B GRAY	ENG WFI ORG	CON CEL A BLUE	CON CEL B GRAY	CON WFI ORG
Transmit Band	(dBm)	(dBm)	(dBm)	(dBm)	(dBm)	(dBm)	(dBm)	(dBm)	(dBm)	(dBm)	(dBm)	(dBm)	(dBm)	(dBm)
220 ENG	-29.7	TB	-24.3	-31.3	-35.6	-38.4	-29.7	-29.8	-37.1	-39.5	NF	-37.0	-33.6	NF
220 CON	-39.0	-24.4	TB	-35.3	-31.1	-30.8	-48.0	-41.2	-45.0	-50.0	NF	-31.3	-32.9	NF
HOT 450	-23.0	-32.1	-38.1	TB	-19.9	-20.1	-28.9	-29.2	-25.3	-34.2	-24.4	-23.5	-31.1	-40.1
Dist. Power A	-22.2	-31.1	-41.6	-19.9	TB	-19.0	-24.8	-34.2	-23.2	-21.8	-41.5	-31.0	-31.7	-54.8
Dist. Power B	-23.7	-39.8	-29.2	-20.1	-18.9	TB	-24.7	-24.9	-34.7	-34.1	-53.0	-23.9	-27.8	-44.3
ATCS 900	-34.0	-32.1	-32.5	-30.0	-34.0	-32.5	TB	-17.9	-18.0	-30.0	-31.0	-28.8	-28.9	-32.0
YARD 900	-34.6	-32.0	-31.0	-31.1	-35.0	-31.7	-17.4	TB	-28.3	-29.4	-31.3	-26.6	-26.6	-31.0

Receive Band	VHF 161 Filter	220 ENG Filter	220 CON Filter	HOT 450 Filter	Dist. PWR A Filter	Dist. PWR B Filter	ATCS 900	YARD 900	ENG CEL A BLUE	ENG CEL B GRAY	ENG WFI ORG	CON CEL A BLUE	CON CEL B GRAY	CON WFI ORG
Transmit Band	(dBm)	(dBm)	(dBm)	(dBm)	(dBm)	(dBm)	(dBm)	(dBm)	(dBm)	(dBm)	(dBm)	(dBm)	(dBm)	(dBm)
VHF 161 Filter	TB	NF	NF	NF	NF	NF	-	-31.2	-39.0	-40.5	NF	-39.0	-40.2	NF
220 ENG Filter	NF	TB	-29.1	NF	NF	NF	-	-49.0	-35.7	-38.7	NF	-43.1	-45.5	NF
220 CON Filter	NF	-29.1	TB	NF	NF	NF	-	-44.6	-47.8	-55.0	NF	-34.7	-36.1	NF
HOT 450 Filter	NF	NF	NF	TB	-24.1	-23.6	-	-32.4	-32.5	-36.5	-52.6	-27.8	-35.5	-53.3
Dist. Power A Filter	NF	NF	NF	-24.1	TB	-23.5	-	-40.9	-36.2	-26.3	-44.1	-35.7	-42.0	-60.2
Dist. Power B Filter	NF	NF	NF	-23.7	-23.5	TB	-	-28.0	-35.0	-36.2	-53.7	-27.6	-36.1	-47.5

Transmit Energy is Single Frequency Band
Non-filtered

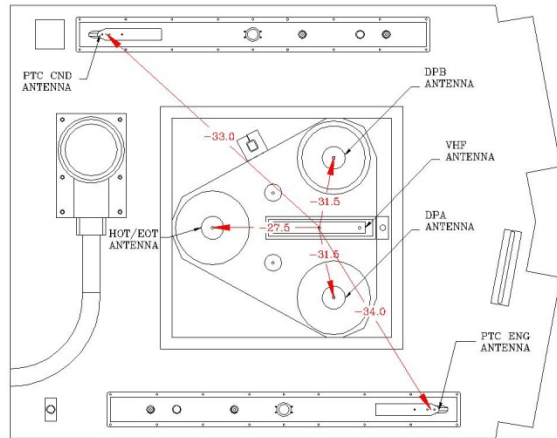

Transmit from single source
Un-filtered

Receive Band	VHF 161	220 ENG	220 CON	HOT 450	Dist. PWR A	Dist. PWR B	ATCS 900	YARD 900	ENG CEL A BLUE	ENG CEL B GRAY	ENG WFI ORG	CON CEL A BLUE	CON CEL B GRAY	CON WFI ORG
Transmit Band	(dBm)	(dBm)	(dBm)	(dBm)	(dBm)	(dBm)	(dBm)	(dBm)	(dBm)	(dBm)	(dBm)	(dBm)	(dBm)	(dBm)
VHF 161	TB	-33.0	-35.0	-26.0	-31.8	-31.5	-29.7	-29.8	-37.1	-39.6	NF	-37.0	-33.6	NF
220 ENG	-39.7	TB	-24.3	-35.1	-35.6	-36.4	-47.5	-46.3	-32.0	-36.0	NF	-45.7	-41.7	NF
220 CON	-39.0	-24.4	TB	-35.3	-31.1	-30.8	-48.0	-41.2	-45.0	-50.0	NF	-31.3	-32.9	NF
HOT 450	-23.0	-32.1	-38.1	TB	-19.9	-20.1	-28.9	-29.2	-25.3	-34.2	-24.4	-23.5	-31.1	-40.1
Dist. Power A	-22.2	-31.1	-41.6	-19.9	TB	-19.0	-24.8	-34.2	-23.2	-21.8	-41.5	-31.0	-31.7	-54.8
Dist. Power B	-23.7	-39.8	-29.2	-20.1	-18.9	TB	-24.7	-24.9	-34.7	-34.1	-53.0	-23.9	-27.8	-44.3
ATCS 900	-34.0	-32.1	-32.5	-30.0	-34.0	-32.5	TB	-17.9	-18.0	-30.0	-31.0	-28.8	-28.9	-32.0
YARD 900	-34.6	-32.9	-31.0	-31.1	-35.0	-31.7	-17.4	TB	-28.3	-29.4	-31.3	-26.6	-26.6	-31.0

Receive Band	VHF 161 Filter	220 ENG Filter	220 CON Filter	HOT 450 Filter	Dist. PWR A Filter	Dist. PWR B Filter	ATCS 900	YARD 900	ENG CEL A BLUE	ENG CEL B GRAY	ENG WFI ORG	CON CEL A BLUE	CON CEL B GRAY	CON WFI ORG
Transmit Band	(dBm)	(dBm)	(dBm)	(dBm)	(dBm)	(dBm)	(dBm)	(dBm)	(dBm)	(dBm)	(dBm)	(dBm)	(dBm)	(dBm)
VHF 161 Filter	TB	-33.0	-35.0	-26.0	-31.8	-31.5	-29.7	-29.8	-37.1	-39.6	NF	-37.0	-33.6	NF
220 ENG Filter	NF	-29.1	TB	NF	NF	NF	-	-49.0	-35.7	-38.7	NF	-43.1	-45.5	NF
220 CON Filter	NF	-29.1	TB	NF	NF	NF	-	-44.6	-47.8	-55.0	NF	-34.7	-36.1	NF
HOT 450 Filter	NF	NF	NF	TB	-24.1	-23.6	-	-32.4	-32.5	-36.5	-52.6	-27.8	-35.5	-53.3
Dist. Power A Filter	NF	NF	NF	-24.1	TB	-23.5	-	-40.9	-36.2	-26.3	-44.1	-35.7	-42.0	-60.2
Dist. Power B Filter	NF	NF	NF	-23.7	-23.5	TB	-	-28.0	-35.0	-36.2	-53.7	-27.6	-36.1	-47.5

Transmit Energy is Single Frequency Band
Filtered

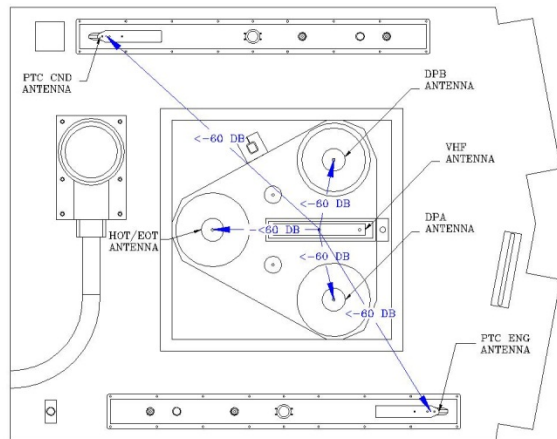

Transmit from single source
Filtered

Receive Band	VHF 161	220 ENG	220 CON	HOT 450	Dist. PWR A	Dist. PWR B	ATCS 900	YARD 900	ENG CEL A BLUE	ENG CEL B GRAY	ENG WIFI ORG	CON CEL A BLUE	CON CEL B GRAY	CON WIFI ORG
Transmit Band	(dBm)	(dBm)	(dBm)	(dBm)	(dBm)	(dBm)	(dBm)	(dBm)	(dBm)	(dBm)	(dBm)	(dBm)	(dBm)	(dBm)
VHF 161	TB	-33.0	-35.0	-28.0	-31.8	-31.5	-29.2	-29.8	-37.1	-39.6	NF	-37.0	-38.6	NF
220 ENG	TB	-37.7	-24.3	-35.1	-35.6	-36.4	-47.5	-46.3	-32.0	-36.0	NF	-45.7	-41.7	NF
220 CON	TB	-24.4	TB	-35.3	-31.1	-30.8	48.0	41.2	-45.0	-50.0	NF	-31.3	-32.9	NF
HOT 450	-23.0	-32.1	-38.1	TB	-19.9	-20.1	-28.9	-29.2	-25.5	-34.2	-52.4	-25.5	-31.1	-49.1
Dist. Power A	-22.2	-31.1	-41.6	-39.9	TB	-19.0	-24.8	-34.2	-23.2	-21.8	-11.5	-33.0	-35.7	-54.8
Dist. Power B	-23.7	-32.8	-29.2	-20.1	-18.0	TB	24.7	24.9	-34.7	-34.1	-33.0	-23.9	-29.8	-44.3
ATCS 900	-34.0	-32.1	-32.5	-30.0	-34.0	-32.5	TB	-17.6	-28.0	-30.0	-31.0	-26.8	-26.0	-32.0
YARD 900	-34.6	-32.9	-31.0	-31.1	-35.0	-31.7	-17.4	TB	-28.3	-29.4	-31.3	-26.6	-26.6	-31.0

Receive Band	VHF 161	220 ENG	220 CON	HOT 450	Dist. PWR A	Dist. PWR B	ATCS 900	YARD 900	ENG CEL A BLUE	ENG CEL B GRAY	ENG WIFI ORG	CON CEL A BLUE	CON CEL B GRAY	CON WIFI ORG
Transmit Band	(dBm)	(dBm)	(dBm)	(dBm)	(dBm)	(dBm)	(dBm)	(dBm)	(dBm)	(dBm)	(dBm)	(dBm)	(dBm)	(dBm)
VHF 161 F Filter	TB	NF	NF	NF	NF	NF	-	-31.2	-39.0	-40.5	NF	-39.0	-40.2	NF
220 ENG F Filter	NF	TB	-29.1	NF	NF	NF	-	-49.0	-55.7	-58.7	NF	-48.1	-45.5	NF
220 CON F Filter	NF	-29.1	TB	NF	NF	NF	-	-44.6	-47.1	-55.0	NF	-34.7	-36.1	NF
HOT 450 F Filter	NF	NF	NF	TB	-24.3	-23.6	-	-32.4	-32.5	-36.5	-52.6	-27.8	-36.5	-53.3
Dist. Power A F Filter	NF	NF	NF	-24.1	TB	-23.5	-	-40.9	-26.2	-26.3	-44.1	-35.7	-42.0	-60.2
Dist. Power B F Filter	NF	NF	NF	-23.7	-23.5	TB	-	-28.0	-35.0	-36.2	-53.7	-27.6	-36.1	-47.5

Receive Energy is Multiple Frequency Bands
Non-filtered

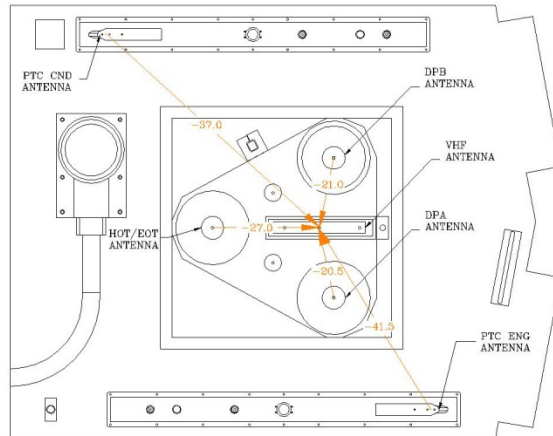

Receive from multiple sources
Unfiltered

Receive Band	VHF 161	220 ENG	220 CON	HOT 450	Dist. PWR A	Dist. PWR B	ATCS 900	YARD 900	ENG CEL A BLUE	ENG CEL B GRAY	ENG WIFI ORG	CON CEL A BLUE	CON CEL B GRAY	CON WIFI ORG
Transmit Band	(dBm)	(dBm)	(dBm)	(dBm)	(dBm)	(dBm)	(dBm)	(dBm)	(dBm)	(dBm)	(dBm)	(dBm)	(dBm)	(dBm)
VHF 161	TB	-33.0	-35.0	-28.0	-31.8	-31.5	-29.2	-29.8	-37.1	-39.6	NF	-37.0	-38.6	NF
220 ENG	TB	-37.7	-24.3	-35.1	-35.6	-36.4	-47.5	-46.3	-32.0	-36.0	NF	-45.7	-41.7	NF
220 CON	TB	-24.4	TB	-35.3	-31.1	-30.8	48.0	41.2	-45.0	-50.0	NF	-31.3	-32.9	NF
HOT 450	-23.0	-32.1	-38.1	TB	-19.9	-20.1	-28.9	-29.2	-25.5	-34.2	-52.4	-25.5	-31.1	-49.1
Dist. Power A	-22.2	-31.1	-41.6	-39.9	TB	-19.0	-24.8	-34.2	-23.2	-21.8	-11.5	-33.0	-35.7	-54.8
Dist. Power B	-23.7	-32.8	-29.2	-20.1	-18.0	TB	24.7	24.9	-34.7	-34.1	-33.0	-23.9	-29.8	-44.3
ATCS 900	-34.0	-32.1	-32.5	-30.0	-34.0	-32.5	TB	-17.6	-28.0	-30.0	-31.0	-26.8	-26.0	-32.0
YARD 900	-34.6	-32.9	-31.0	-31.1	-35.0	-31.7	-17.4	TB	-28.3	-29.4	-31.3	-26.6	-26.6	-31.0

Receive Band	VHF 161	220 ENG	220 CON	HOT 450	Dist. PWR A	Dist. PWR B	ATCS 900	YARD 900	ENG CEL A BLUE	ENG CEL B GRAY	ENG WIFI ORG	CON CEL A BLUE	CON CEL B GRAY	CON WIFI ORG
Transmit Band	(dBm)	(dBm)	(dBm)	(dBm)	(dBm)	(dBm)	(dBm)	(dBm)	(dBm)	(dBm)	(dBm)	(dBm)	(dBm)	(dBm)
VHF 161 F Filter	TB	NF	NF	NF	NF	NF	-	-31.2	-39.0	-40.5	NF	-39.0	-40.2	NF
220 ENG F Filter	NF	TB	-29.1	NF	NF	NF	-	-49.0	-55.7	-58.7	NF	-48.1	-45.5	NF
220 CON F Filter	NF	-29.1	TB	NF	NF	NF	-	-44.6	-47.1	-55.0	NF	-34.7	-36.1	NF
HOT 450 F Filter	NF	NF	NF	TB	-24.1	-23.6	-	-32.4	-32.5	-36.5	-52.6	-27.8	-36.5	-53.3
Dist. Power A F Filter	NF	NF	NF	-24.1	TB	-23.5	-	-40.9	-26.2	-26.3	-44.1	-35.7	-42.0	-60.2
Dist. Power B F Filter	NF	NF	NF	-23.7	-23.5	TB	-	-28.0	-35.0	-36.2	-53.7	-27.6	-36.1	-47.5

Receive Energy is Multiple Frequency Bands
Filtered

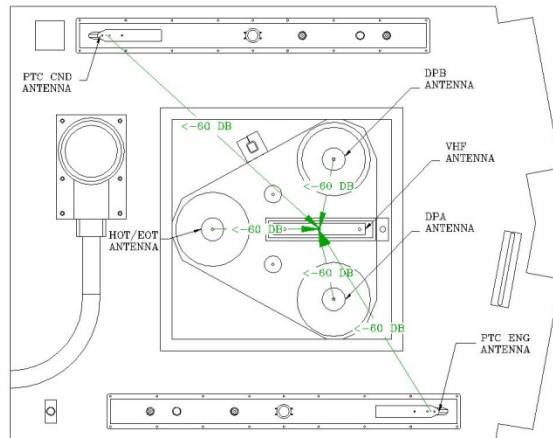

Receive from multiple sources
Filtered

CSX 985 Antenna Isolation VHF XMIT Mapping

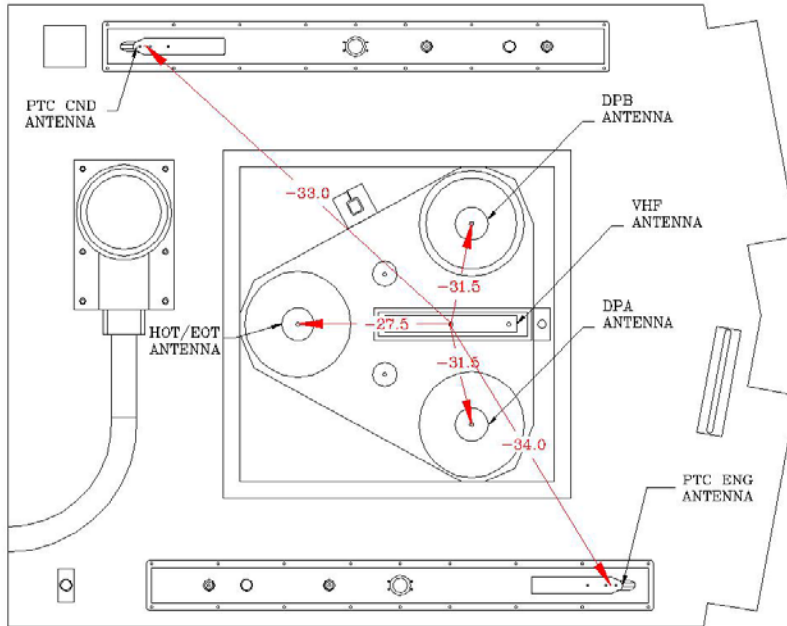

Figure 15 A
Non-Filtered

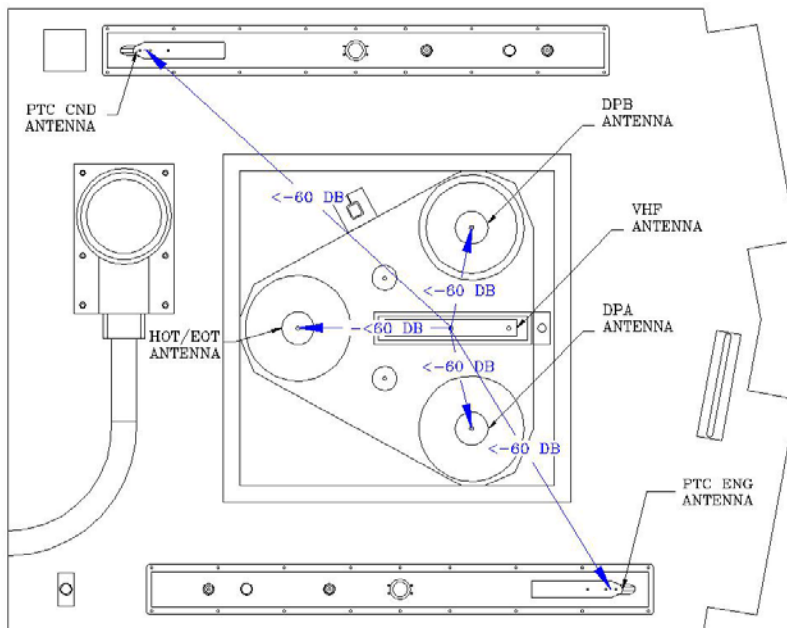

Figure 15 B
Filtered

CSX 985 Antenna Isolation
VHF RCV Mapping

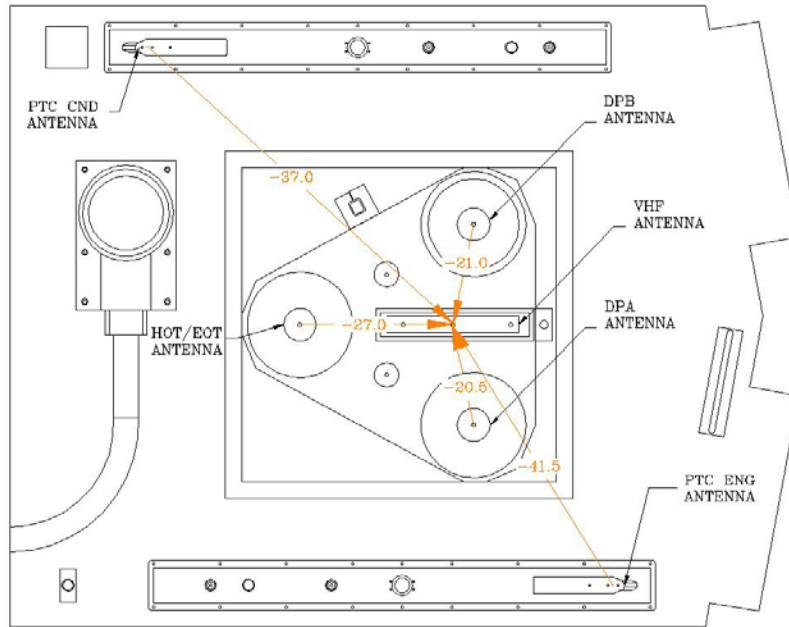

Figure 15 C
Non-Filtered

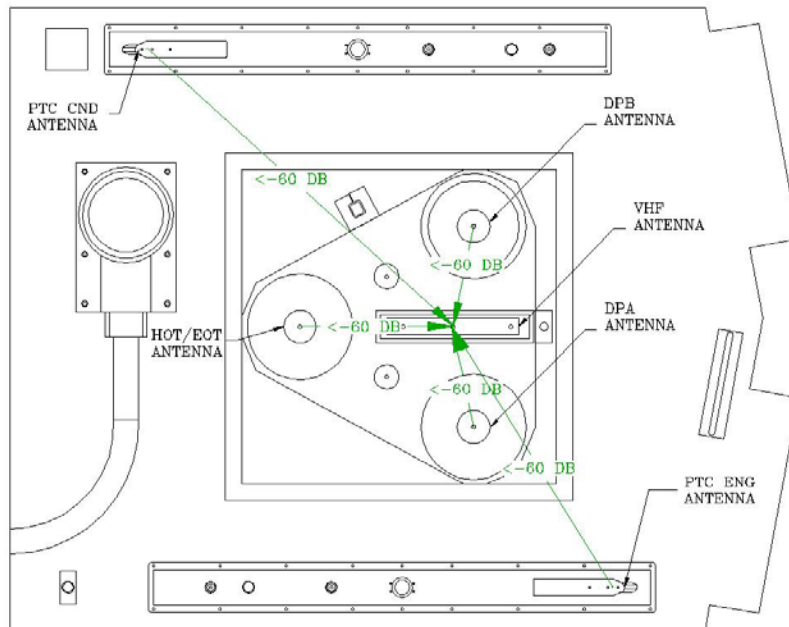

Figure 15 D
Filtered

CSX 985 Antenna Isolation
PTC ENG XMIT Mapping

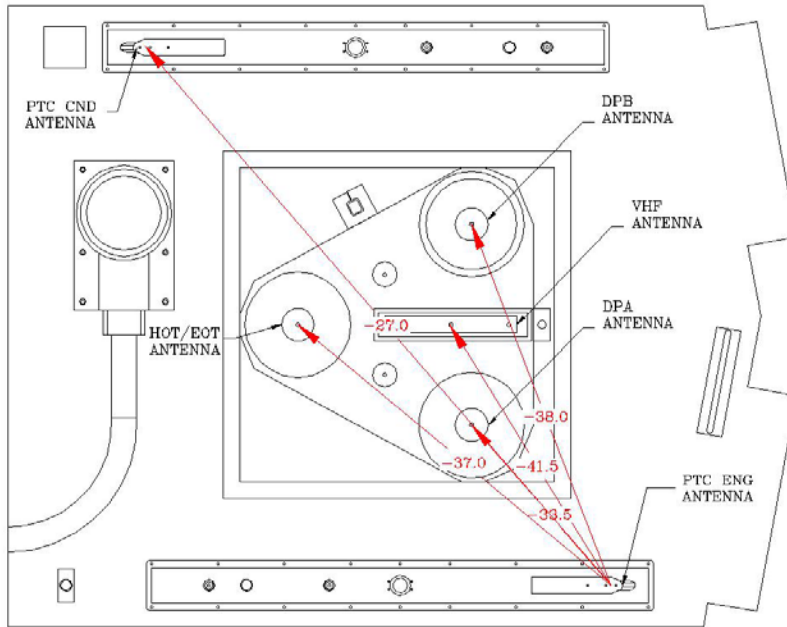

Figure 16 A
Non-Filtered

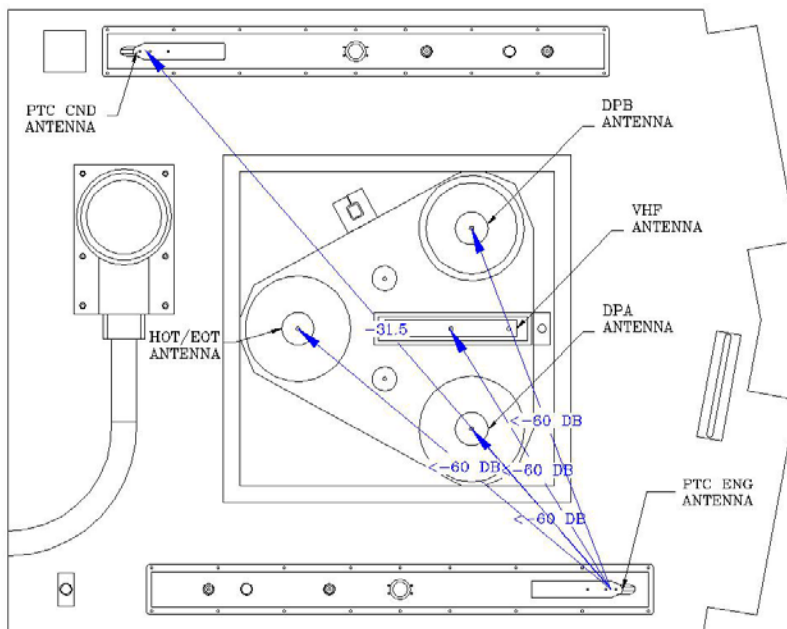

Figure 16 B
Filtered

CSX 985 Antenna Isolation
PTC ENG RCV Mapping

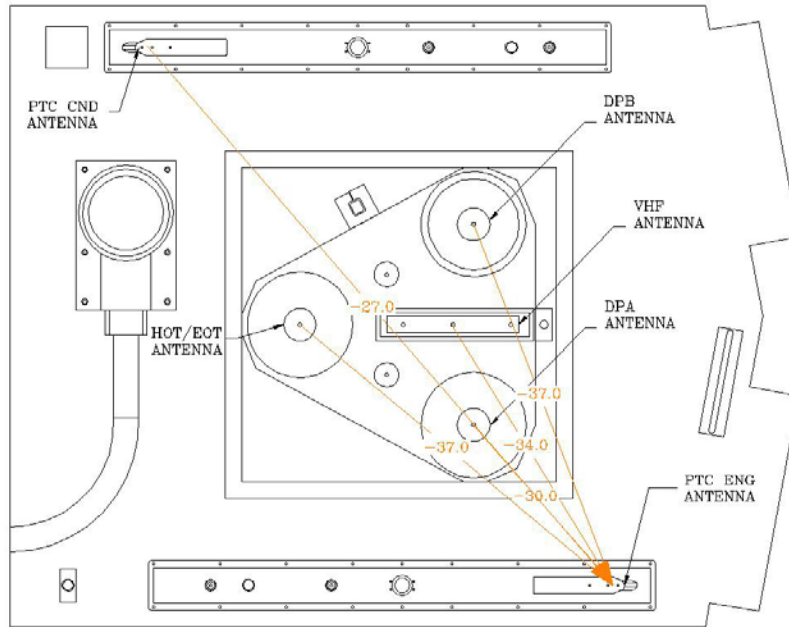

Figure 16 C
Non-Filtered

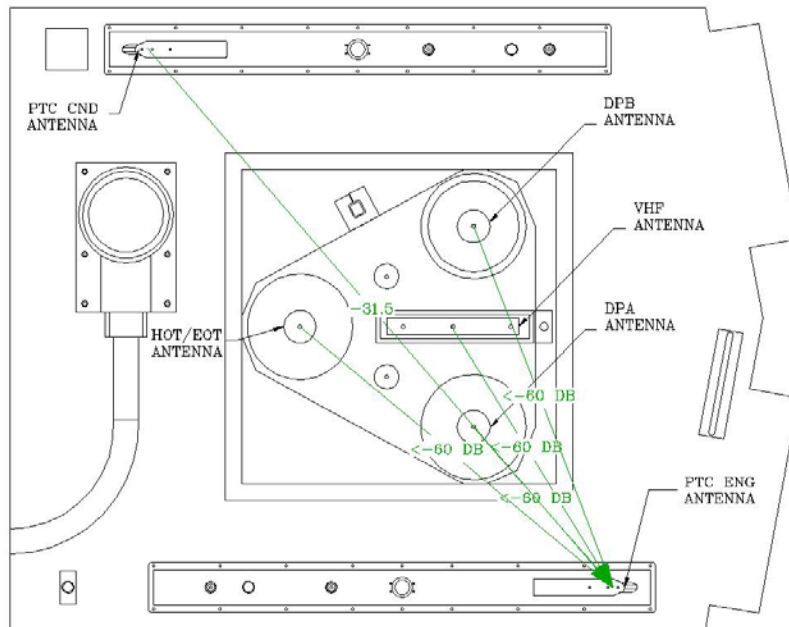

Figure 16 D
Filtered

CSX 985 Antenna Isolation
PTC CND XMIT Mapping

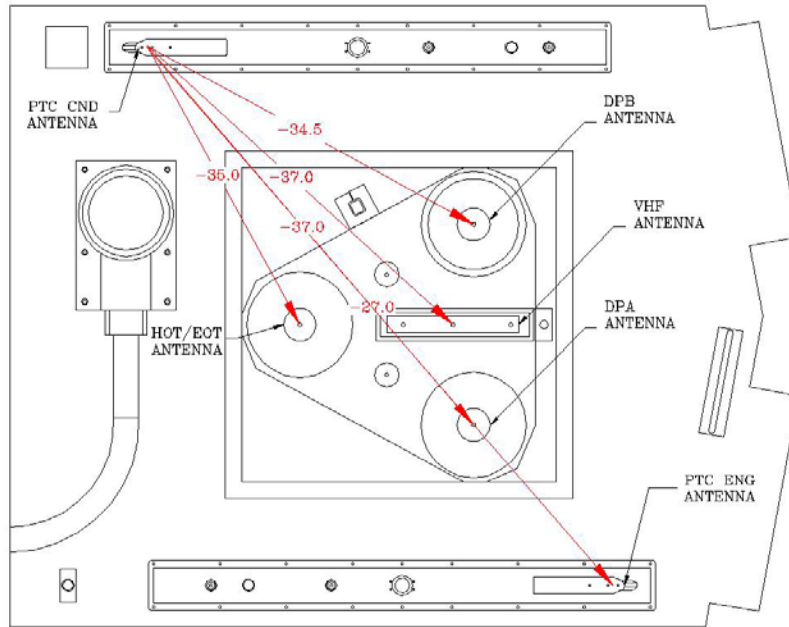

Figure 17 A
Non-Filtered

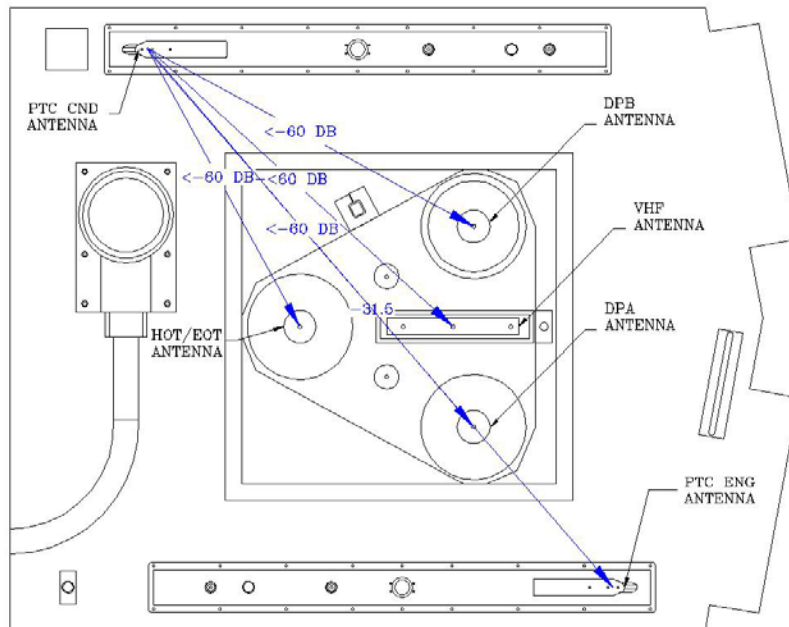

Figure 17 B
Filtered

CSX 985 Antenna Isolation
PTC CND RCV Mapping

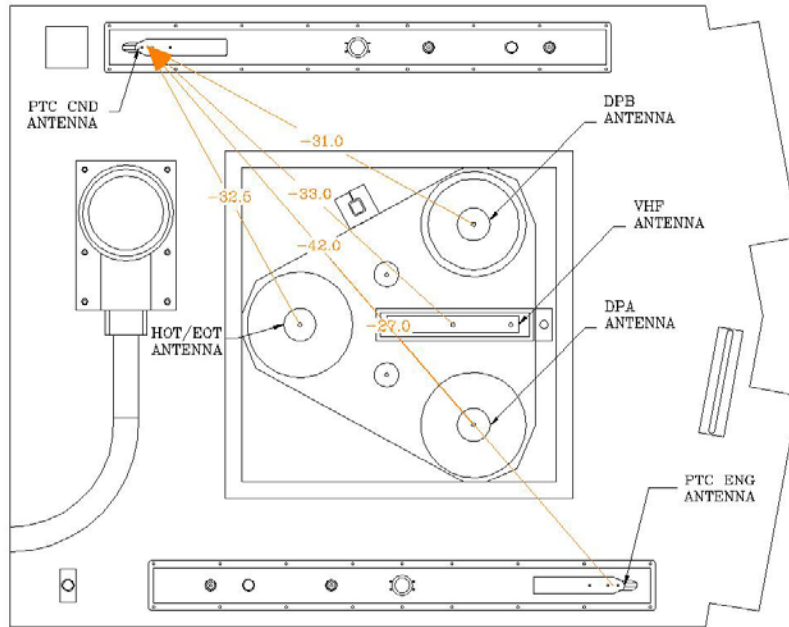

Figure 17 C
Non-Filtered

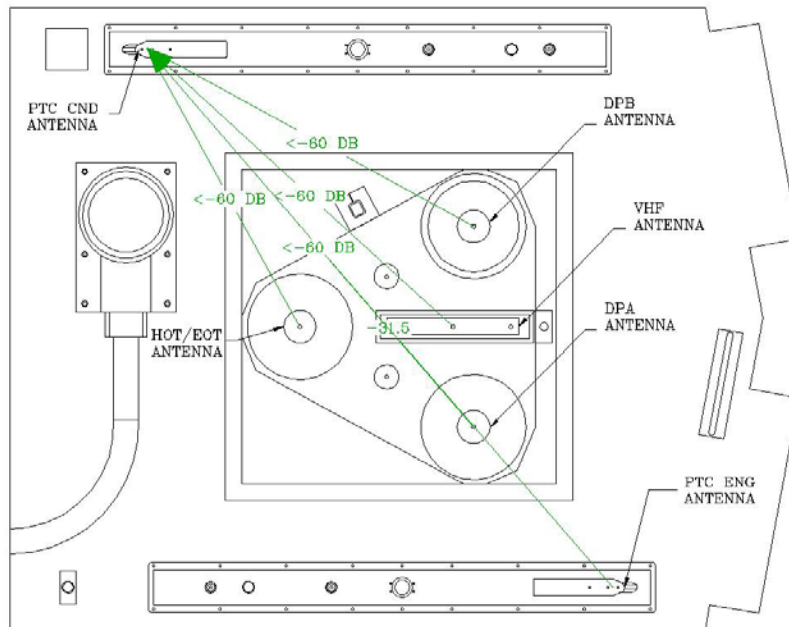

Figure 17 D
Filtered

CSX 985 Antenna Isolation
HOT/EOT XMIT Mapping

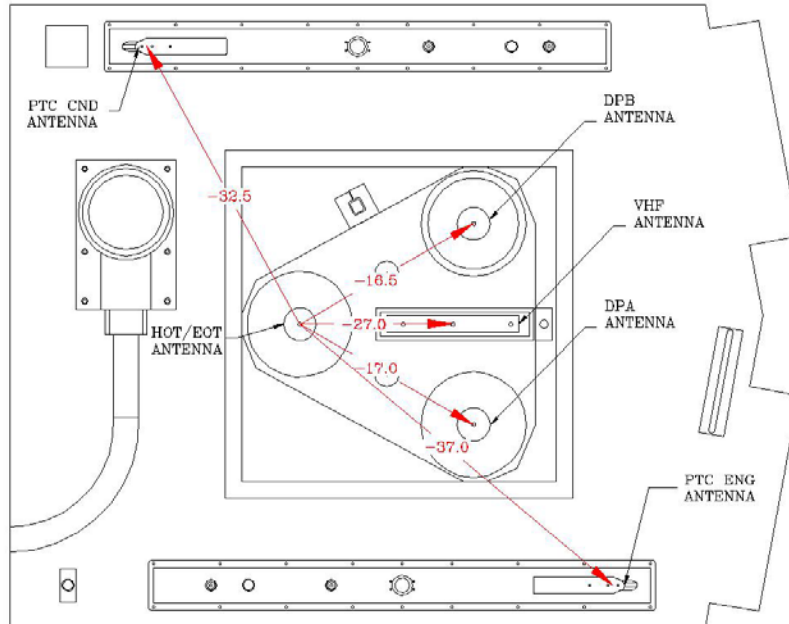

Figure 18 A
Non-Filtered

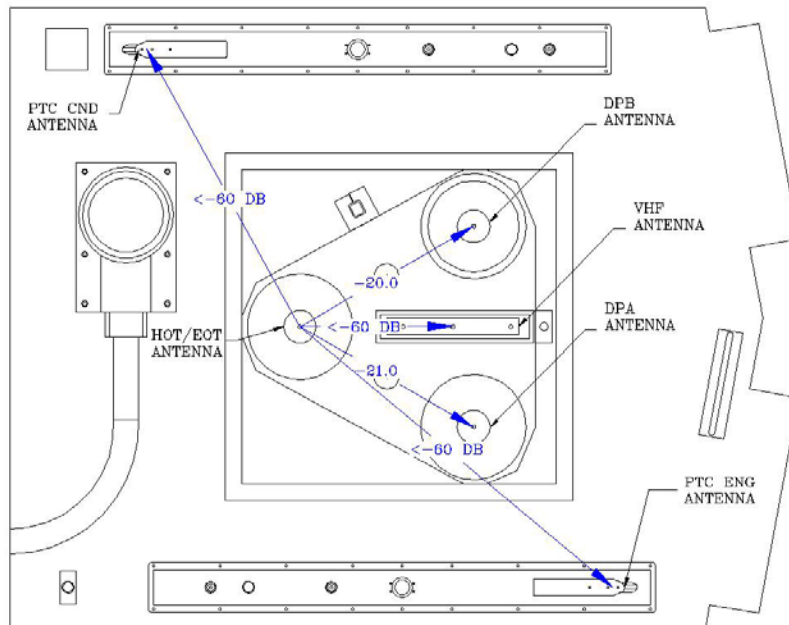

Figure 18 B
Filtered

CSX 985 Antenna Isolation
HOT/EOT RCV Mapping

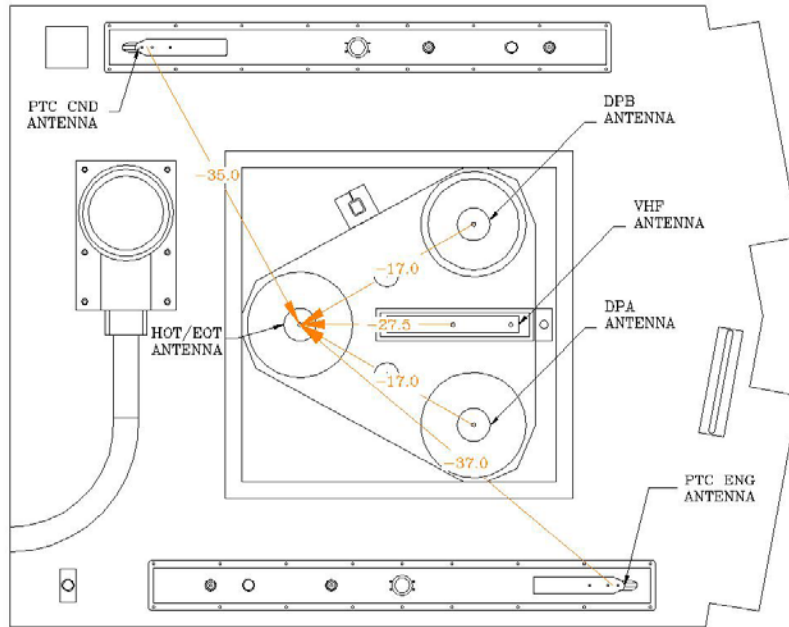

Figure 18 C
Non-Filtered

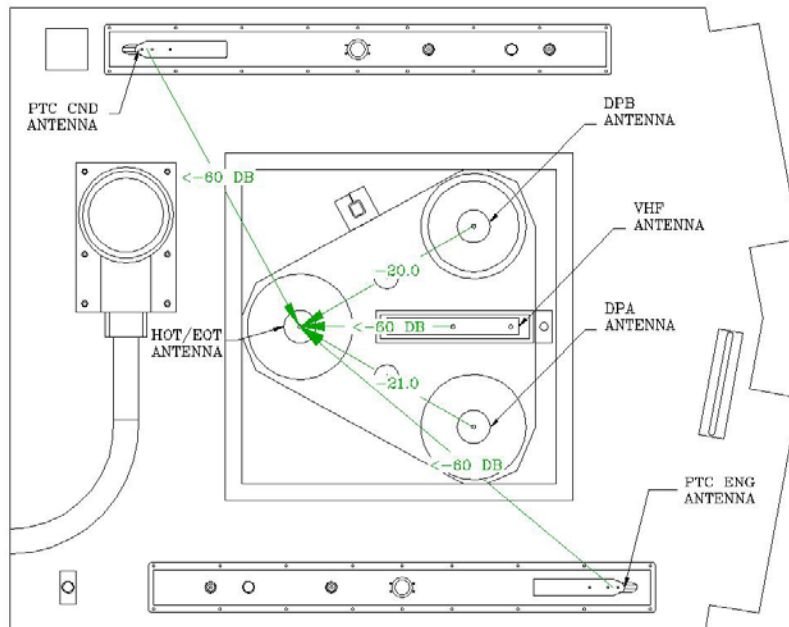

Figure 18 D
Filtered

CSX 985 Antenna Isolation
DPA XMIT Mapping

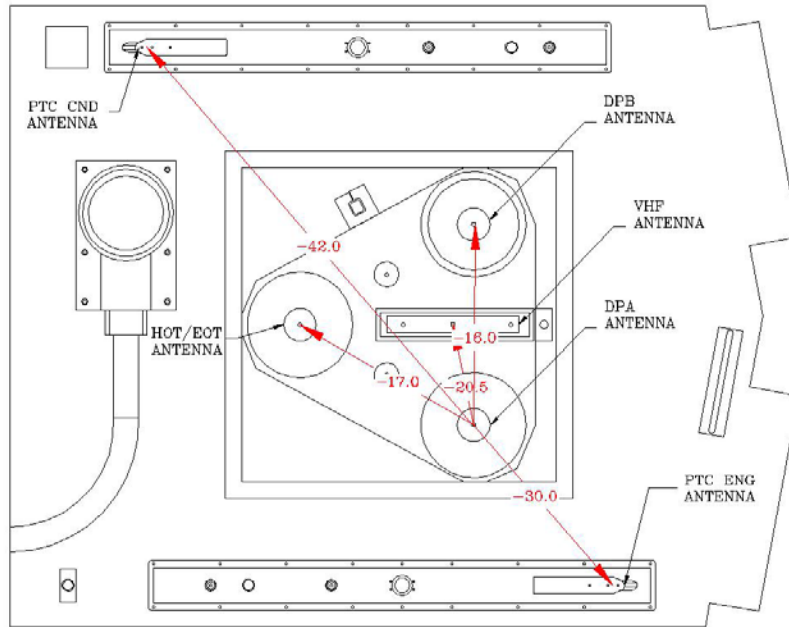

Figure 19 A
Non-Filtered

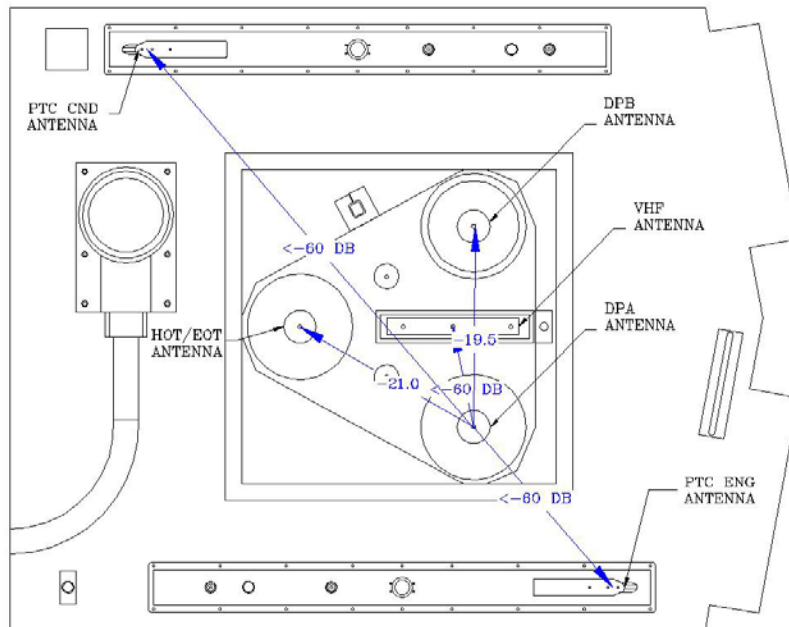

Figure 19 B
Filtered

CSX 985 Antenna Isolation
DPA RCV Mapping

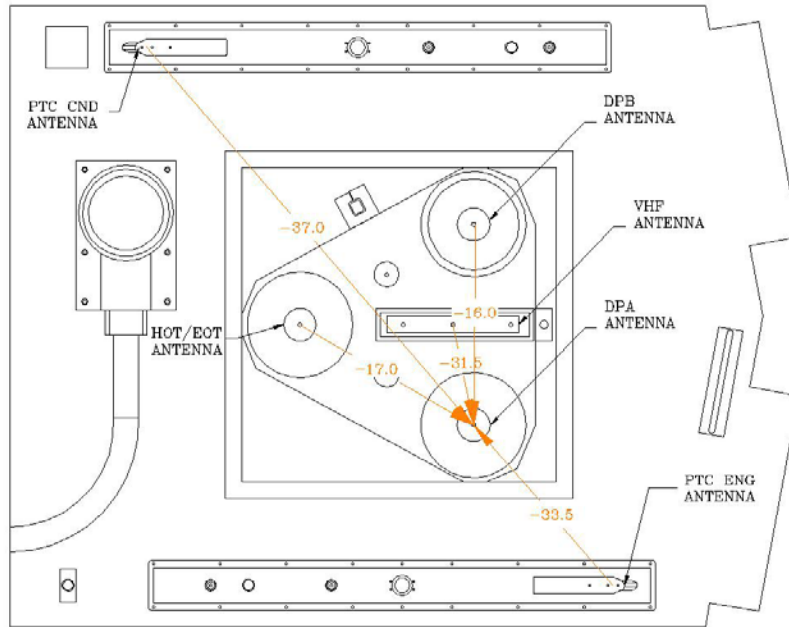

Figure 19 C
Non-Filtered

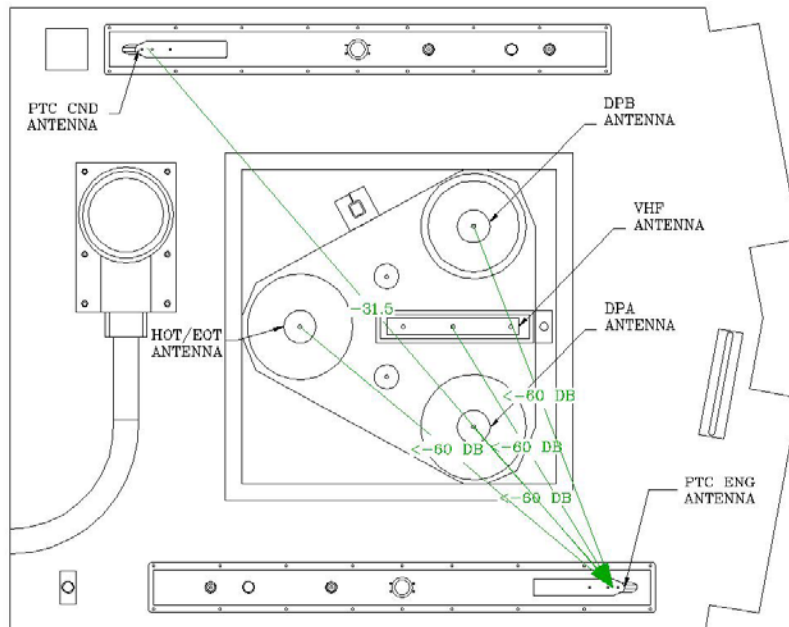

Figure 19 D
Filtered

CSX 985 Antenna Isolation DPB XMIT Mapping

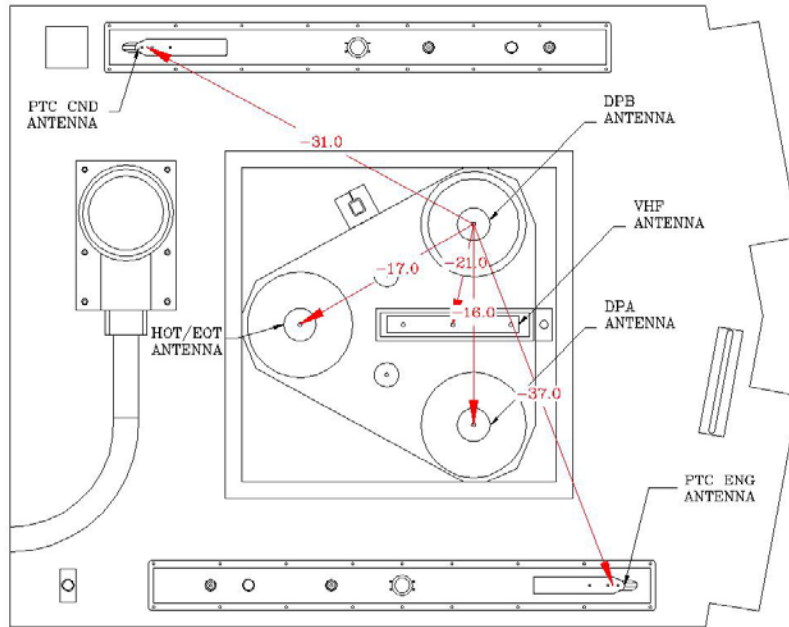

Figure 20 A
Non-Filtered

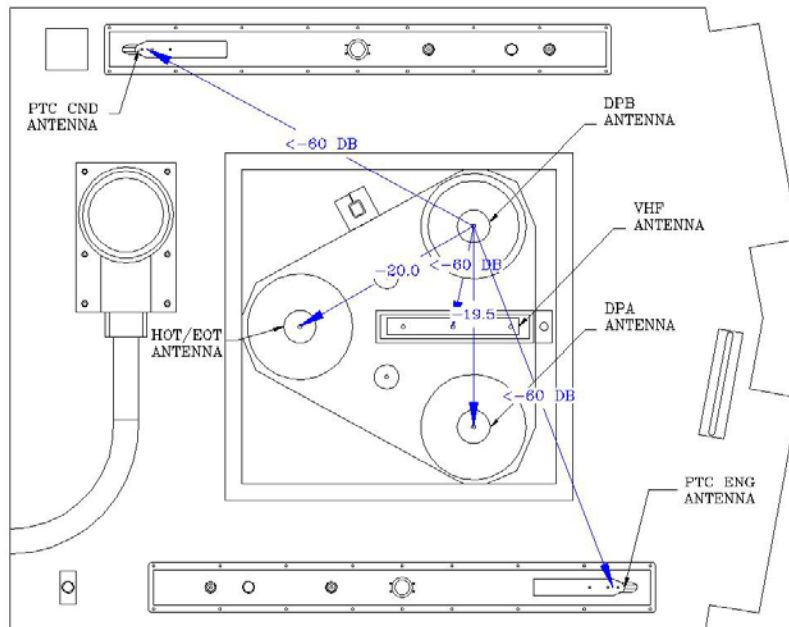

Figure 20 B
Filtered

CSX 985 Antenna Isolation
DPB RCV Mapping

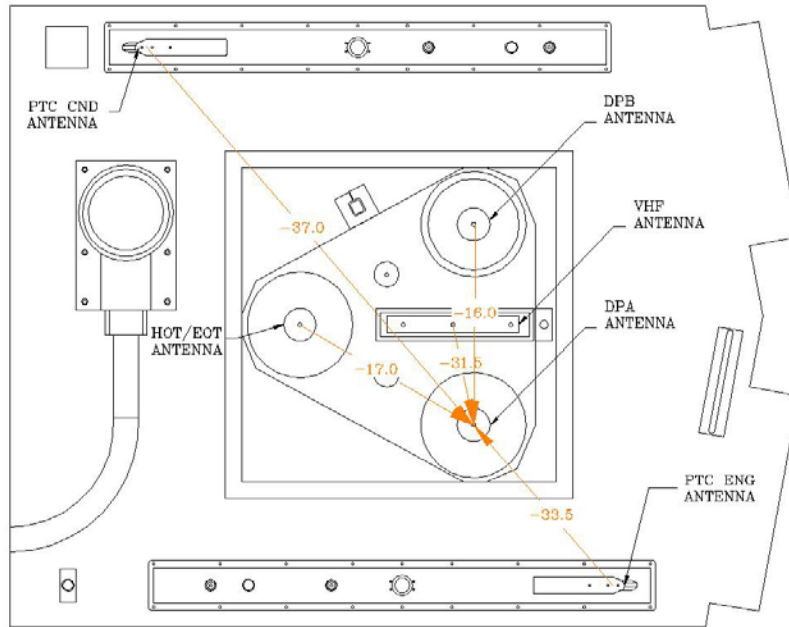

Figure 20 C
Non-Filtered

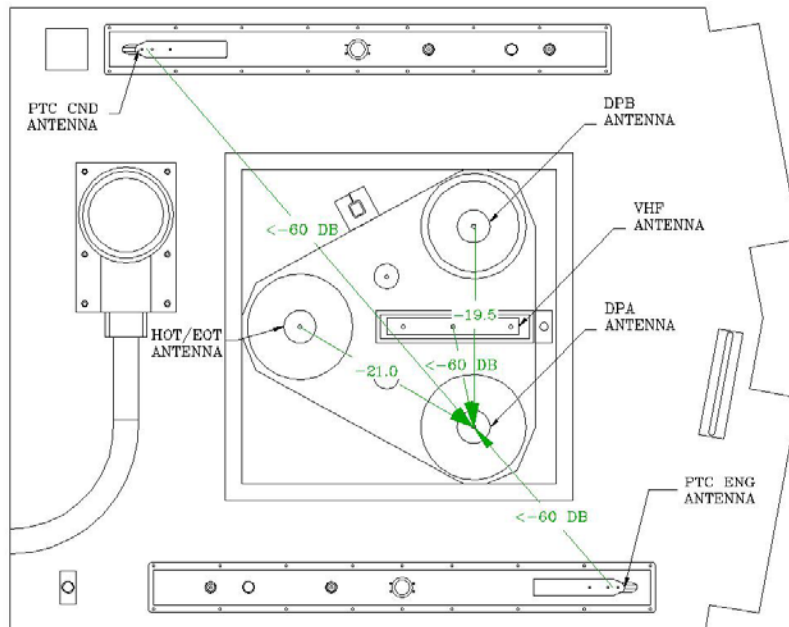

Figure 20 D
Filtered

Receive Intermodulation Test

This test provides information on intermodulation products generated at the front end of each radio receiver when it is impacted by high power signals from the transmitting radio.

Each of the on board radios transmits at nominal power, and using a dual directional coupler. The radio under test is measured for the amount of intermodulation products generated at the front end of the radio receiver and re-radiated back through the same antenna. Note that the radio under test is not transmitting.

A Dual Directional Coupler rated for a maximum power of 500 Watts was used to separately measure signals coming from the antenna to the radio receiver front end, and from the receiver front end to the antenna and subsequently transmitted as intermodulation products.

This Dual Directional Coupler has six ports, one for Antenna, one for Radio, two for 50 ohms loads, one to measure signals coming from the antenna to the radio transceiver, and one port to measure signals from the radio transceiver to the antenna.

In the IMD Test Apparatus diagram, the initial radio under test shown is the AAR Voice Radio, operating at ~ 160 MHz. Its Receiver is coupled directly to its existing transmission path, including Antenna (and Filter, if equipped or planned). The RF Sensor is coupled 20 dB down to the Receiver in the Radio under Test. The other radios of interest on the Locomotive (DPA, DPB, and HOT/EOT) are then keyed and RF energy from those radios passes through their appropriate transmission paths, including coax cable, antennas (and filters, if equipped or planned). The RF energy then propagates into the Antenna of the Radio under Test, and then into the Receiver under test. Any IMD products in the 220 MHz spectrum generated in the Receiver that would be propagated via the Antenna system are detected by use of the RF Sensor.

A permutation of the IMD Test Apparatus is configured for each of the other radios of interest (DPA, DPB, and HOT/EOT), so that each of them is connected as a Radio under Test, and the process is repeated.

Note that the spur at 224.000 MHz appears to be an artifact of the RF Sensor, and should be ignored.

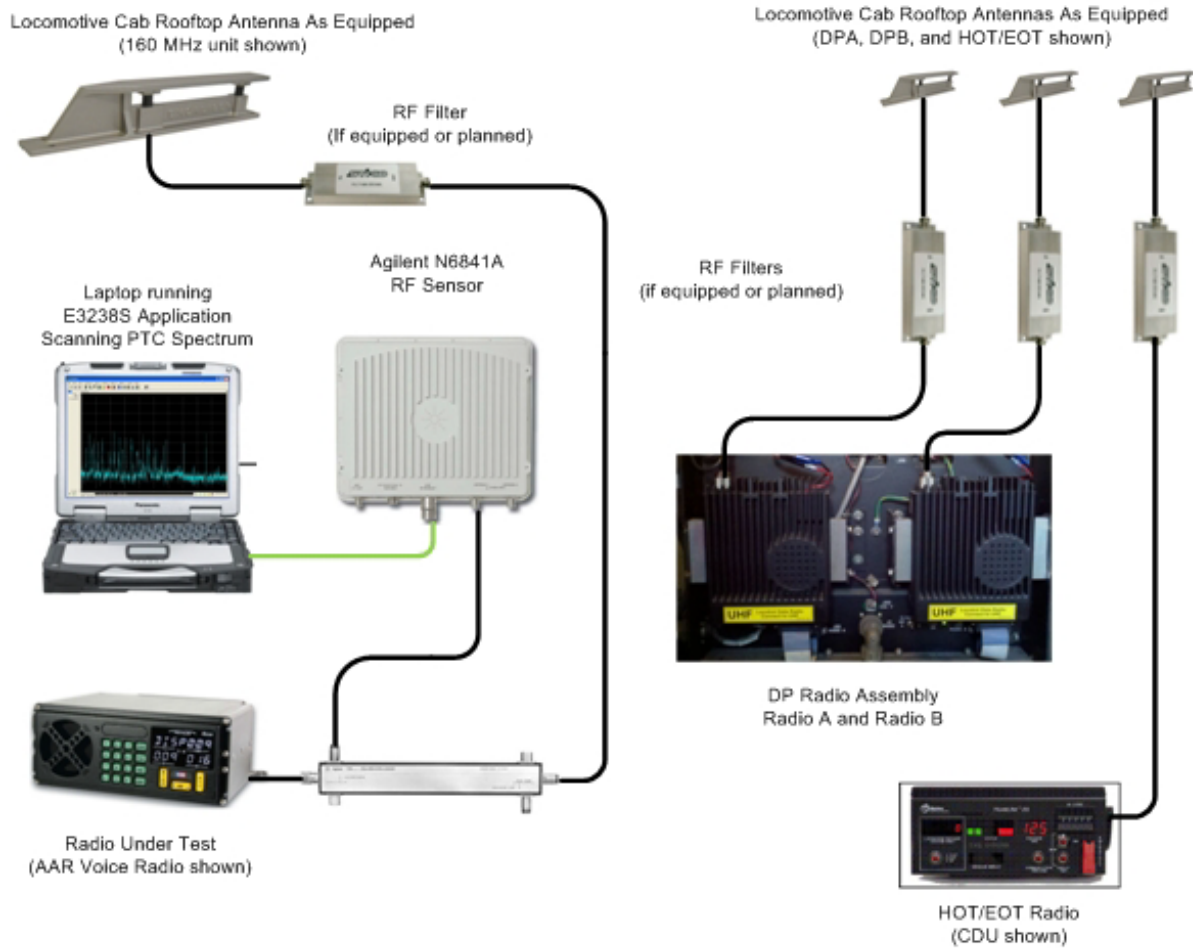

Receive Intermodulation Testing Configuration
Figure 21

VHF RECEIVE

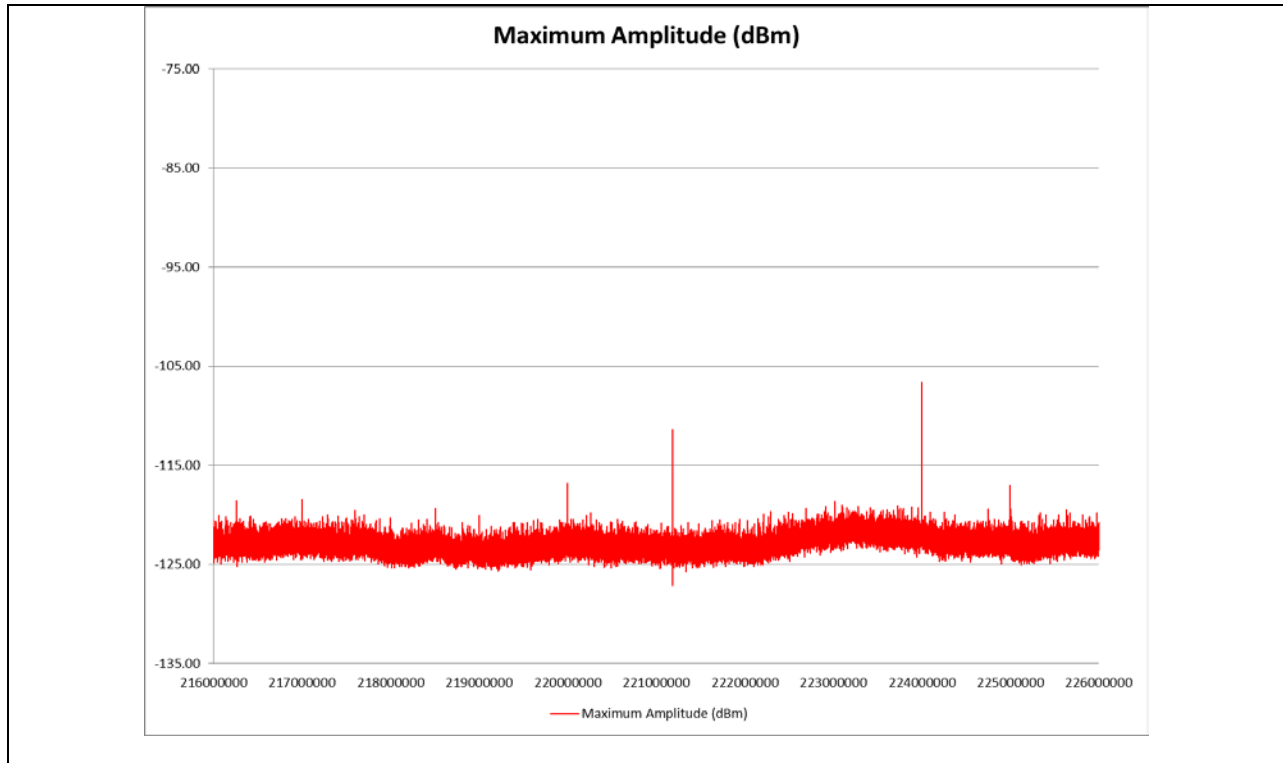

VHF RX Baseline

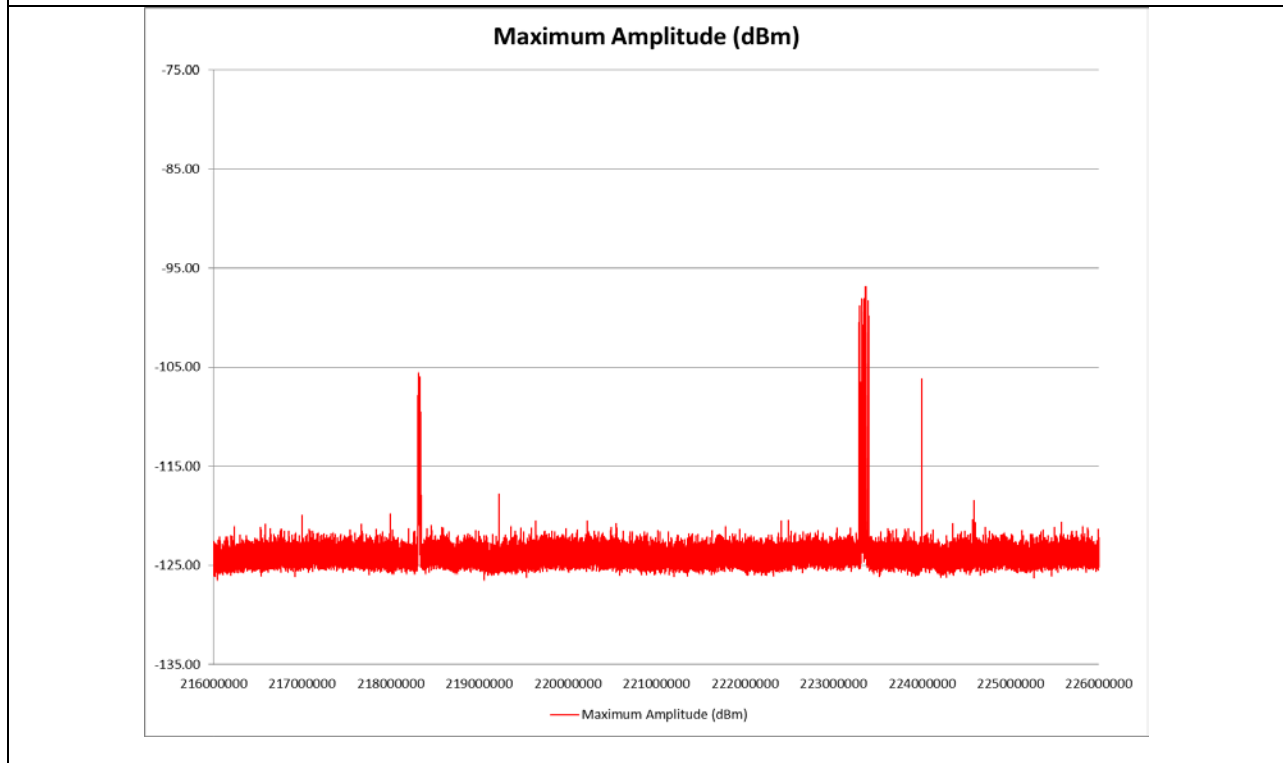

VHF RX with DPA-EOT TX

DPA RECEIVE

When Testing DPA RX Intermod, an interesting relationship occurred with the HOT/EOT Radio and the Distributed Power Radio receivers. Significant broadband Intermodulation Products were generated. The exact mechanism has not been determined, but the source appears to be in the HOT/EOT Radio. This Locomotive was equipped with a Trainlink II HOT/EOT Radio. During Testing, a Quantum HOT/EOT Radio was acquired for comparison, as these radios are known to incorporate different designs, yet are often used interchangeably. Both exhibited Intermodulation Products, but the character of such products was significantly different between the two radio designs. In both cases, filtering resolved the problem.

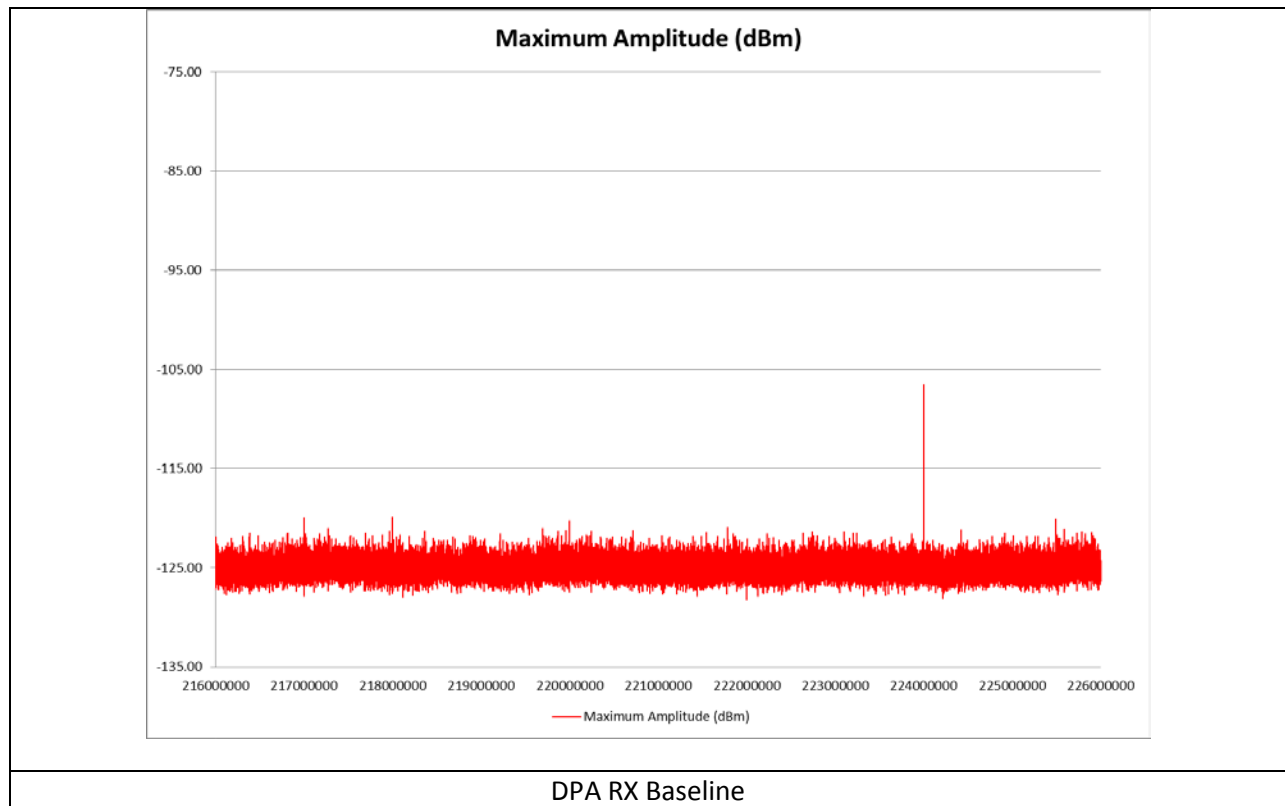

DPA RECEIVE

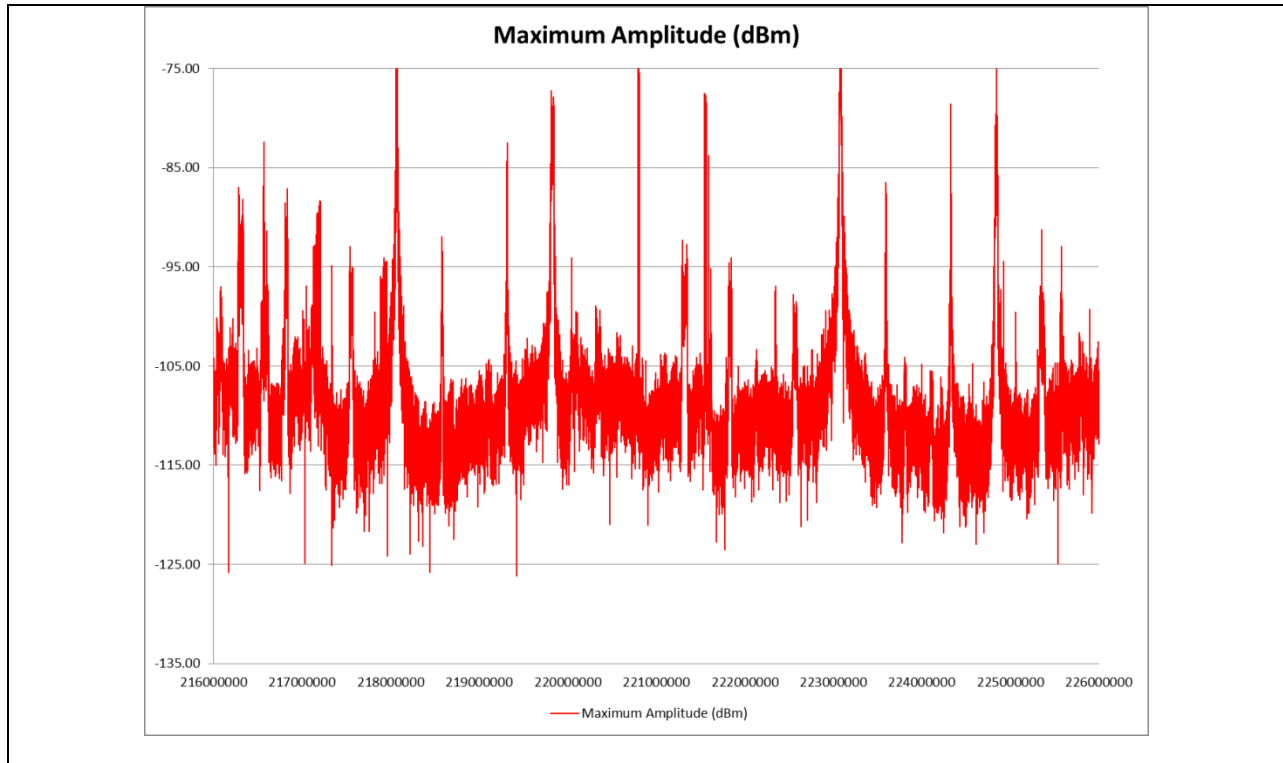

DPA RX with VHF-DPB-EOT Trainlink II TX Non-Filtered

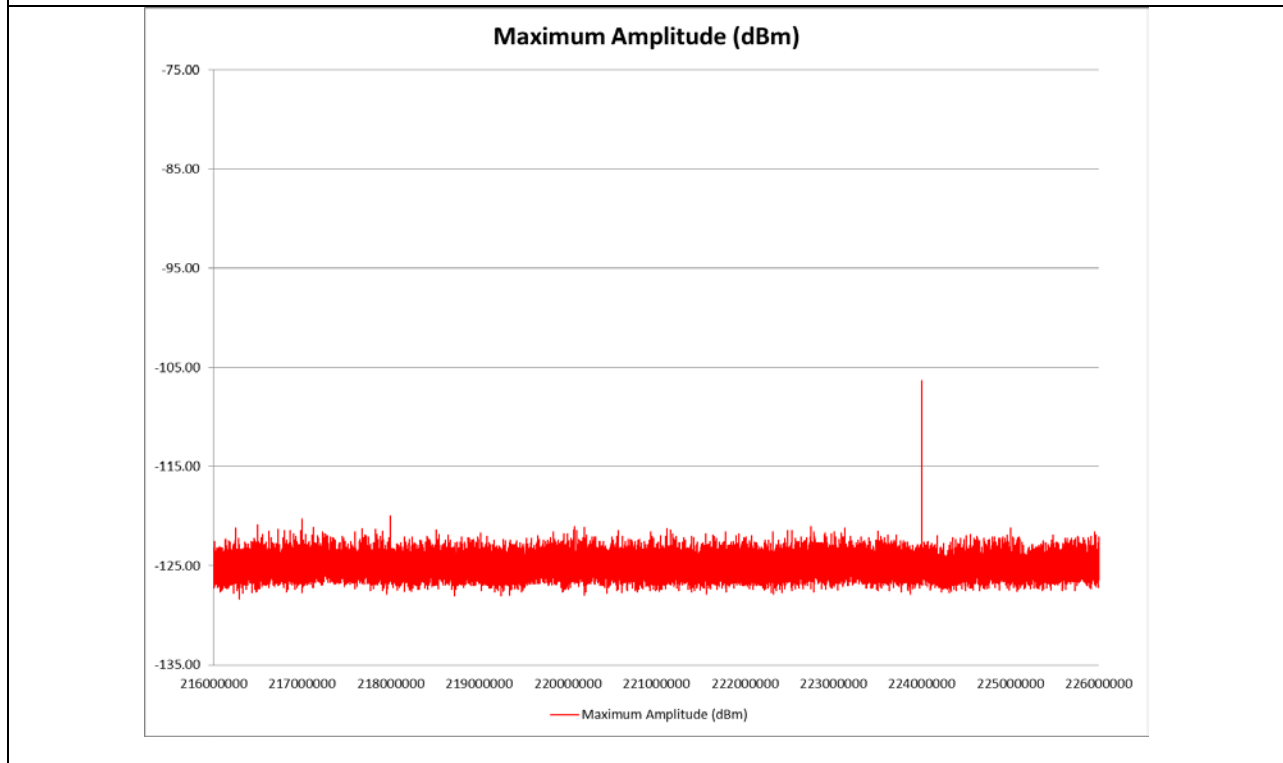

DPA RX with VHF-DPB-EOT Trainlink II TX Filtered

DPA RECEIVE

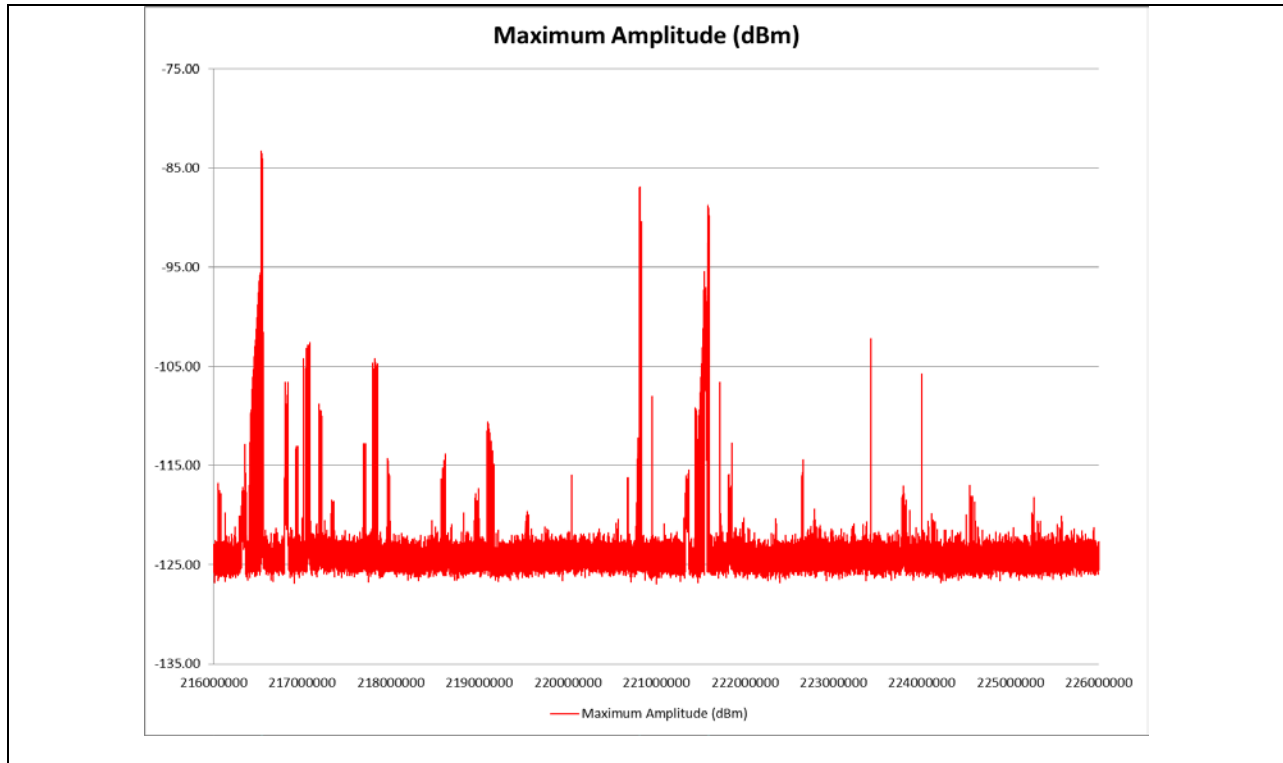

DPA RX with VHF-DPB-EOT Quantum TX Non-Filtered

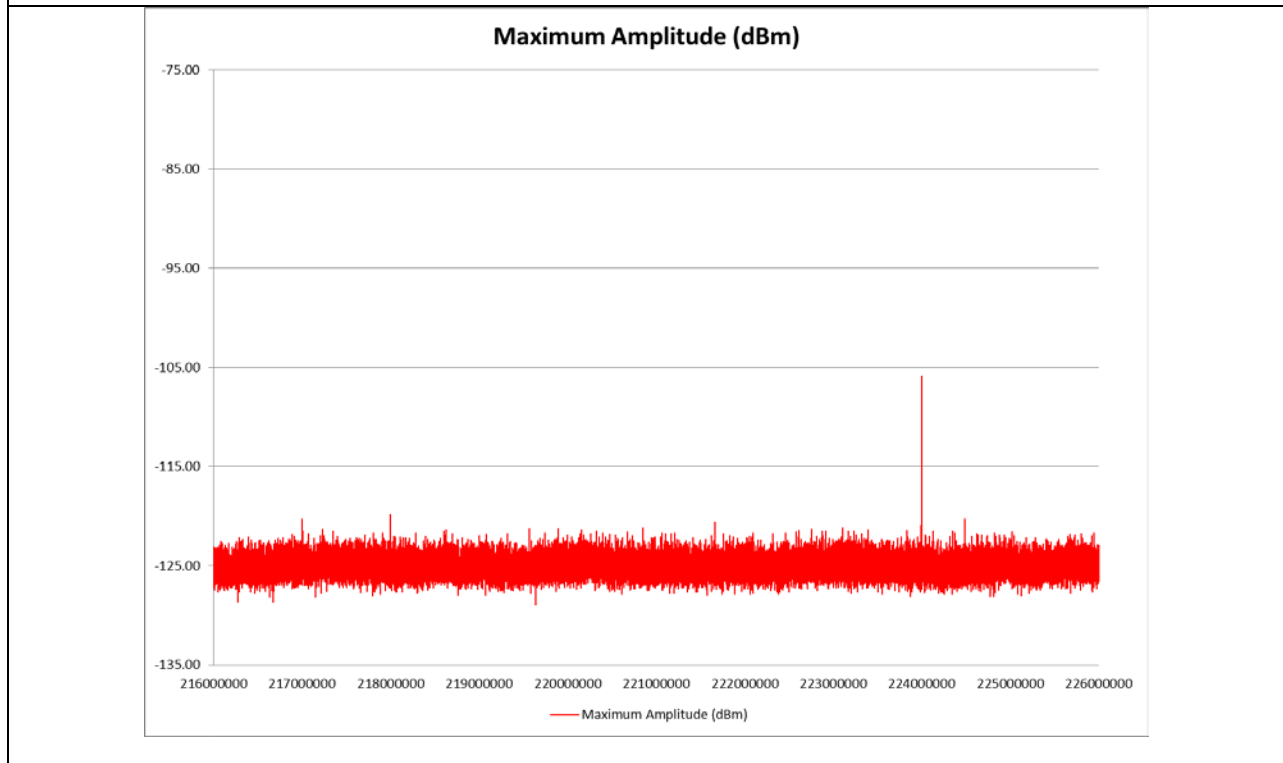

DPA RX with VHF-DPB-EOT Quantum Filtered

EOT/HOT RECEIVE

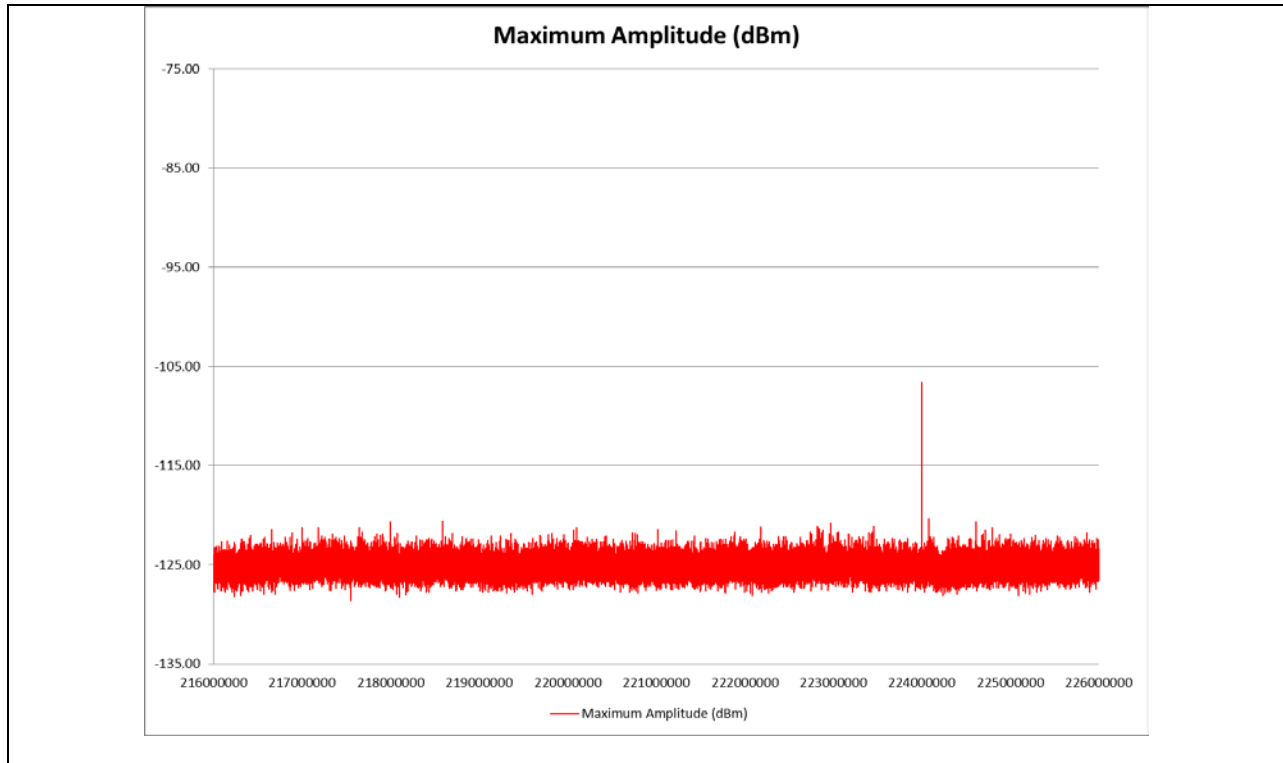

EOT/HOT Baseline with 30 decibel attenuator in-line

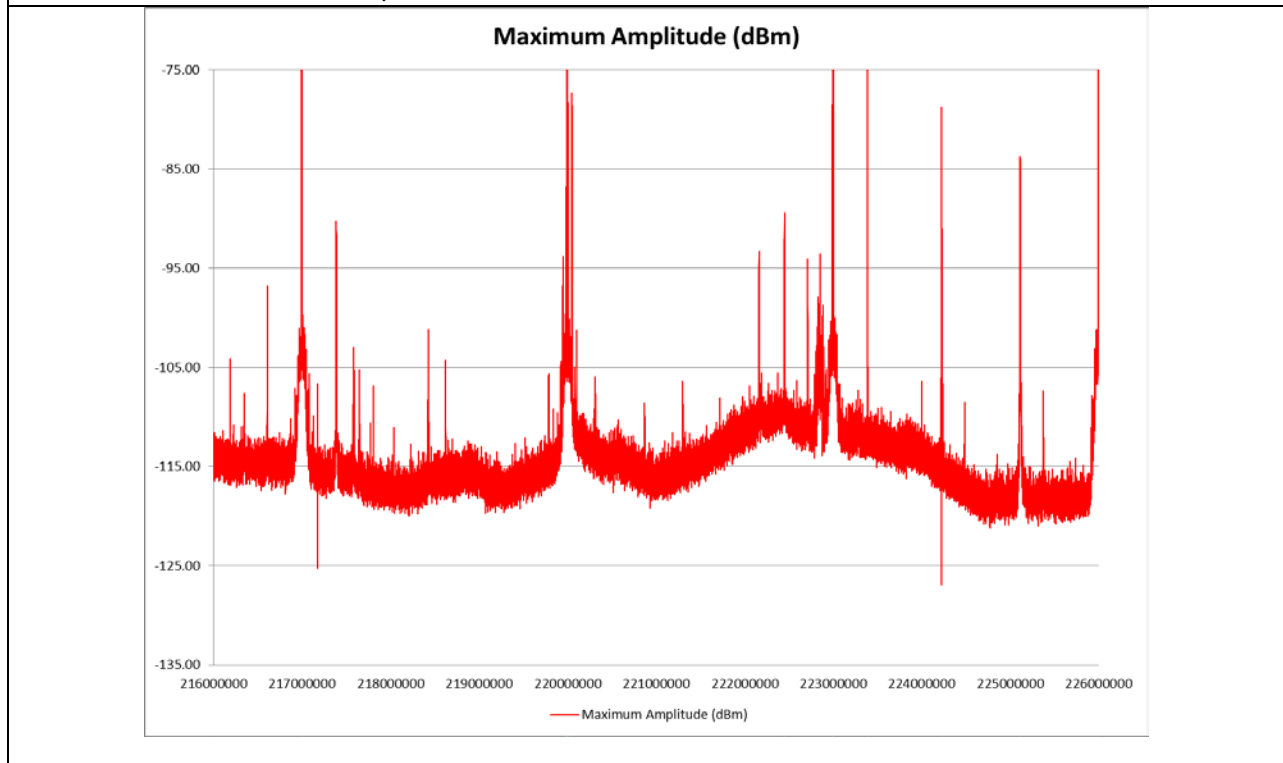

EOT RX with VHF and DPB TX non-filtered

EOT/HOT RECEIVE

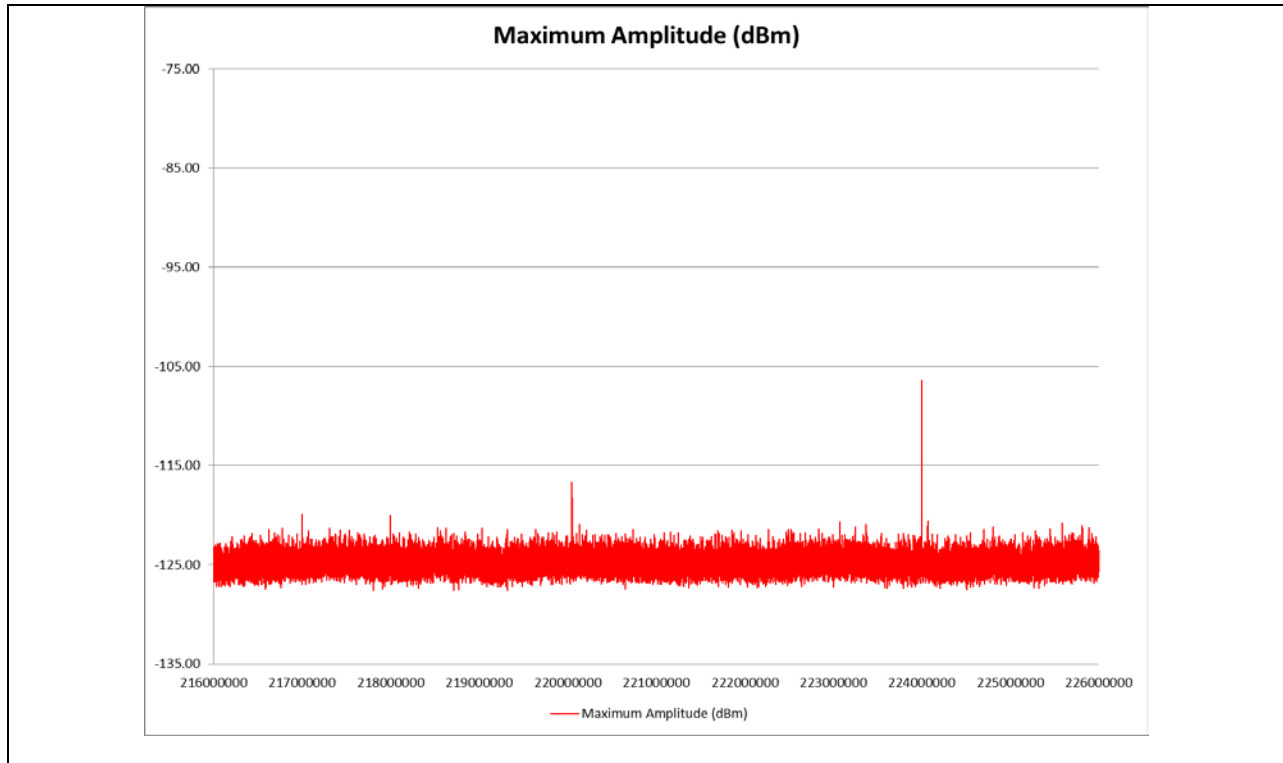

EOT RX with VHF and DPA TX filtered

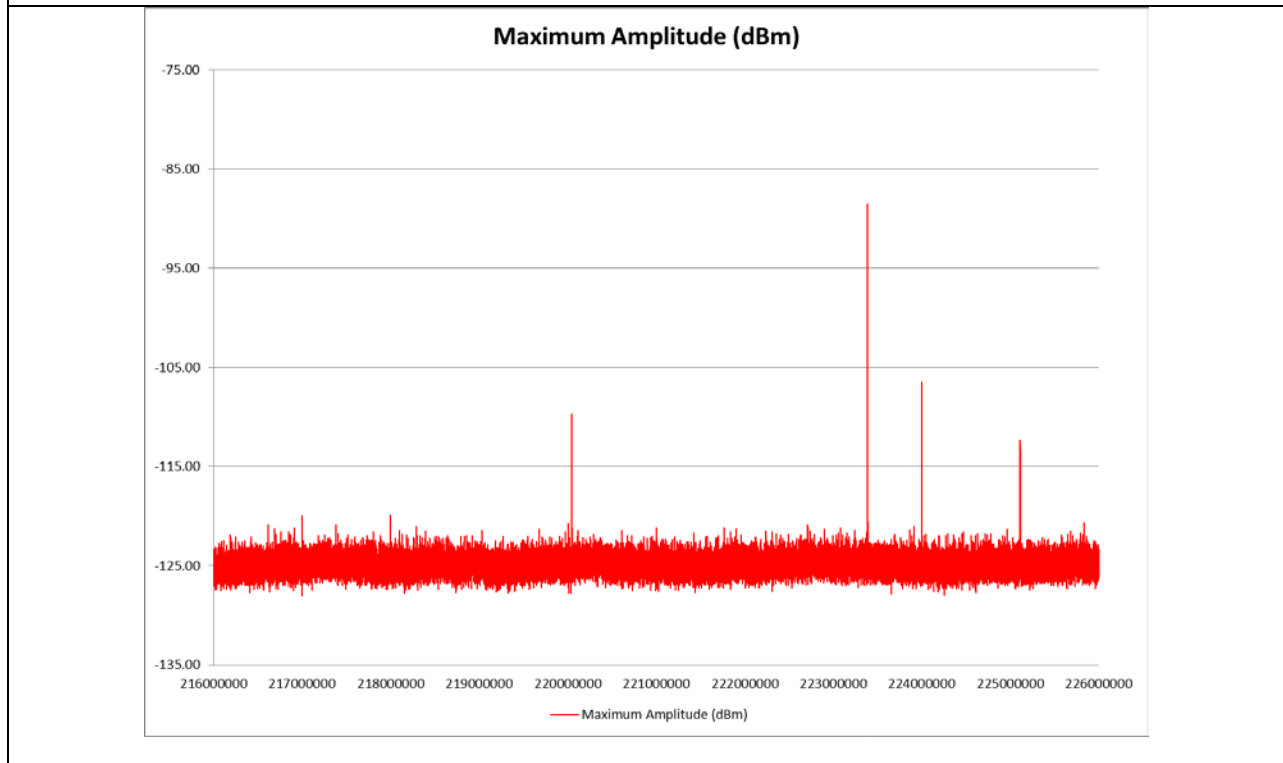

EOT RX with VHF and DPB TX filtered

Transmit Intermodulation Test

This test provides information on intermodulation products produced by multiple radio transmissions at the same time. Several radios on a locomotive, such as Voice 161 MHz, PTC 220 MHz, DP A UHF or DP B UHF, HOT UHF and SPEC 200 900 MHz, may transmit simultaneously. These simultaneous transmissions may occur on two, three, or more radios at the same time.

Two, three, four or more on-board radios combined in different groups transmit simultaneously. Each of the radios transmits at nominal power, and using a dual directional coupler, each other non-transmitting radio is measured for the magnitude of signals received from the transmitting radios entering through the antenna, and for the amount of intermodulation products generated at the front end of the radio receiver and re-transmitted through the same antenna.

A Dual Directional Coupler rated for a maximum power of 500 Watts is used to separately measure signals radiated by the antenna to the radio receiver front end, and then from the receiver front end to the antenna, and subsequently re-transmitted as intermodulation products.

This Dual Directional Coupler has six ports, one for Antenna, one for Radio, two for 50 ohms loads, one to measure signals coming from the antenna to the radio transceiver, and one port to measure signals from the radio transceiver to the antenna.

In the IMD Test Apparatus diagram, the initial radio under test shown is the AAR Voice Radio, operating at ~ 160 MHz. Its Transmitter is coupled directly to its existing transmission path, including Antenna (and Filter, if equipped or planned). The RF Sensor is coupled 20 dB down (or more, as needed to protect the RF Sensor) to the Transmitter in the Radio under Test. The other radios of interest on the Locomotive (DPA, DPB, and HOT/EOT) are then keyed and RF energy from those radios pass through their respective existing transmission paths, including Antennas (and Filters, if equipped or planned). The RF energy then propagates into the Antenna of the Radio under Test, and then into the Transmitter under test. Any IMD products in the 220 MHz spectrum generated in the Transmitter that would be propagated via the Antenna system are measured by the RF Sensor.

A permutation of the IMD Test Apparatus is configured for each of the other radios of interest (DPA, DPB, and HOT/EOT), so that each of them is connected as a Radio under Test, and the process is repeated.

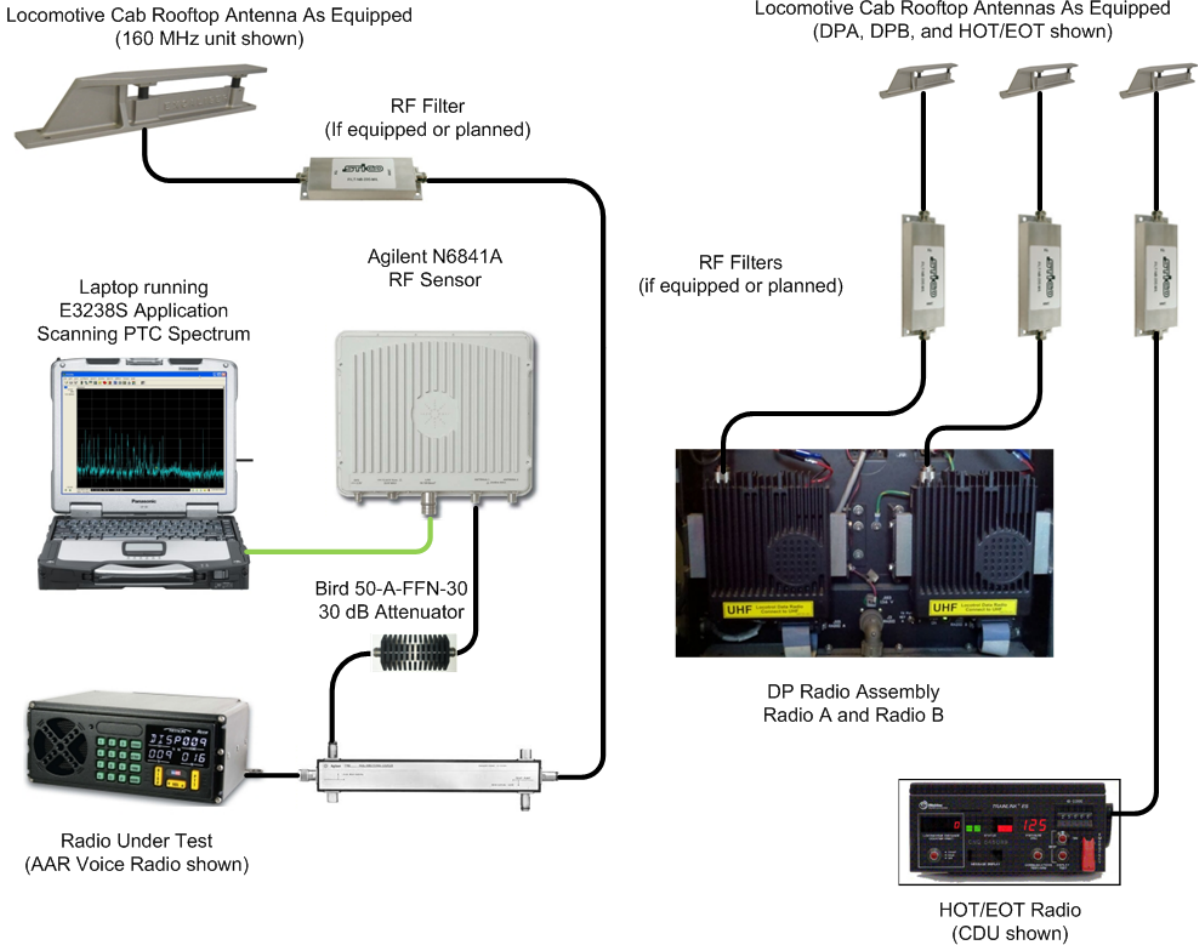

Transmit Intermodulation Testing Configuration
Figure 22

Transmit Intermodulation

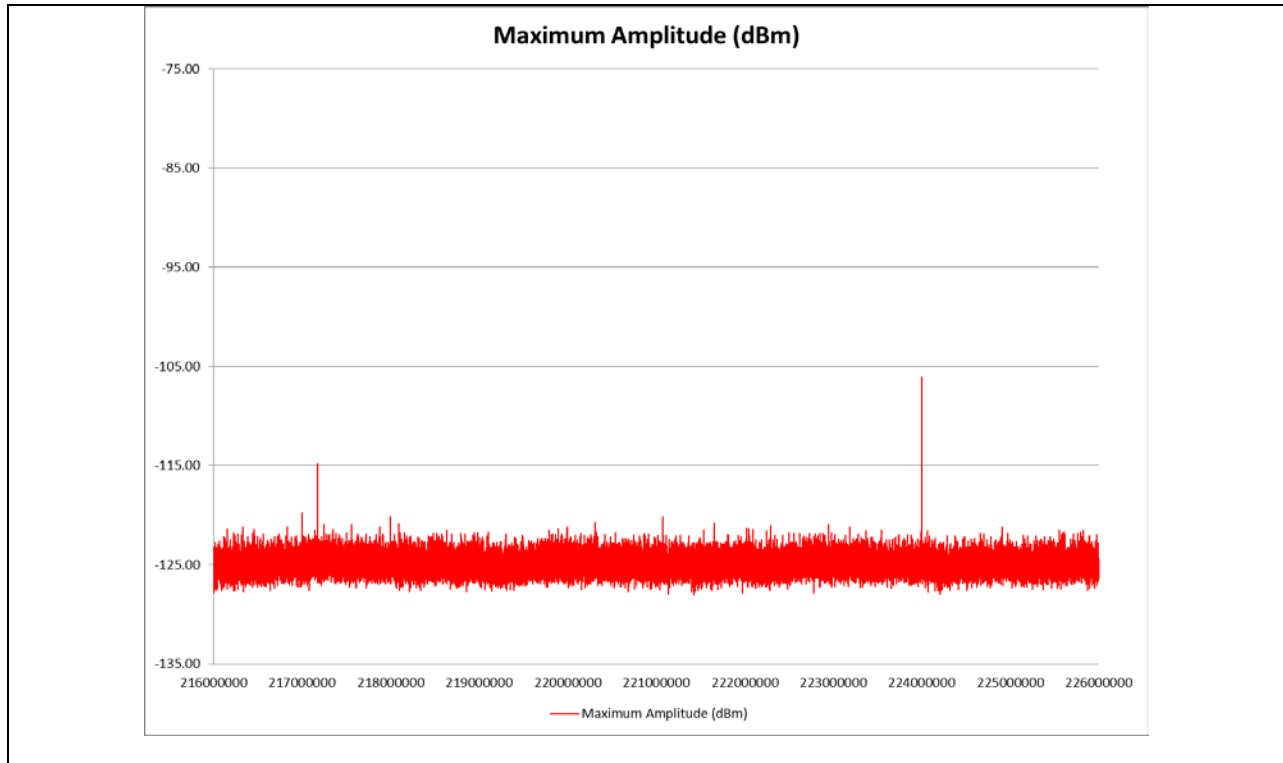

VHF XMIT with DPA DPB and HOT/EOT

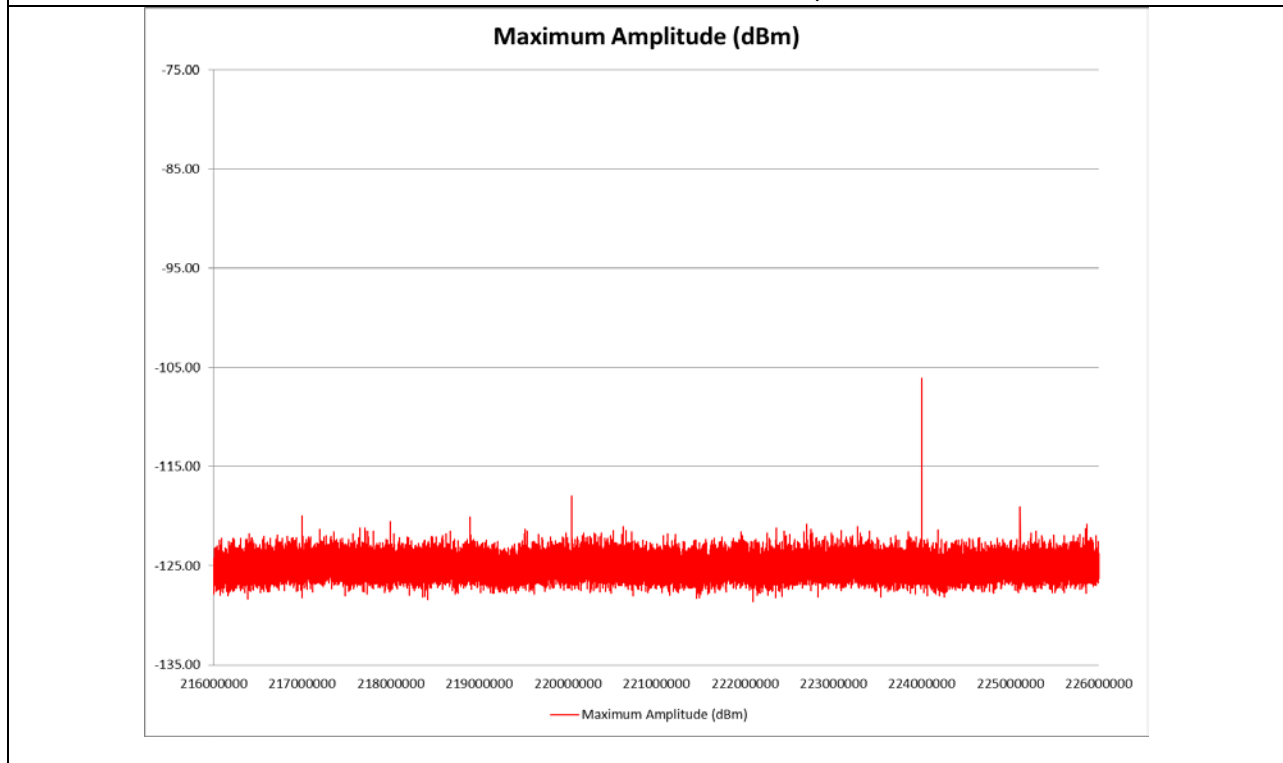

HOT/EOT XMIT with VHF DPA AND DPB

Transmit Intermodulation

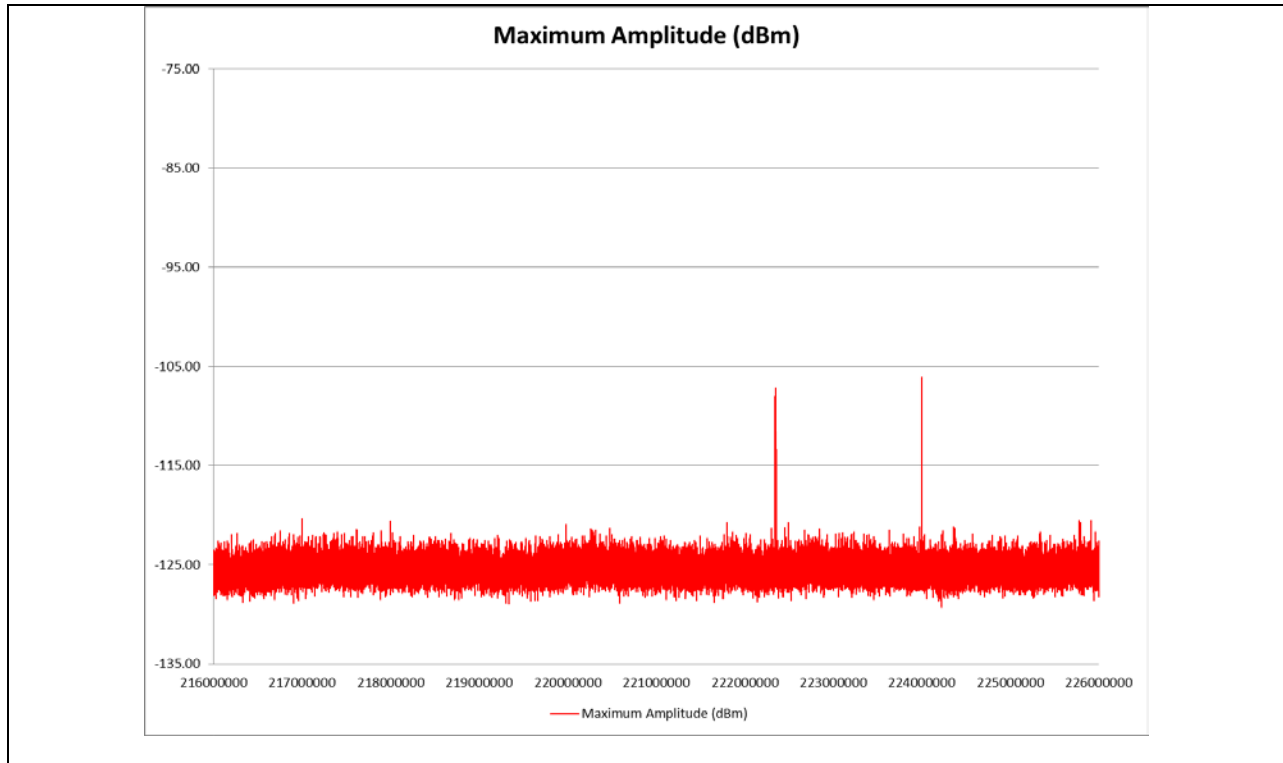

DPA XMIT with VHF DPB and HOT/EOT

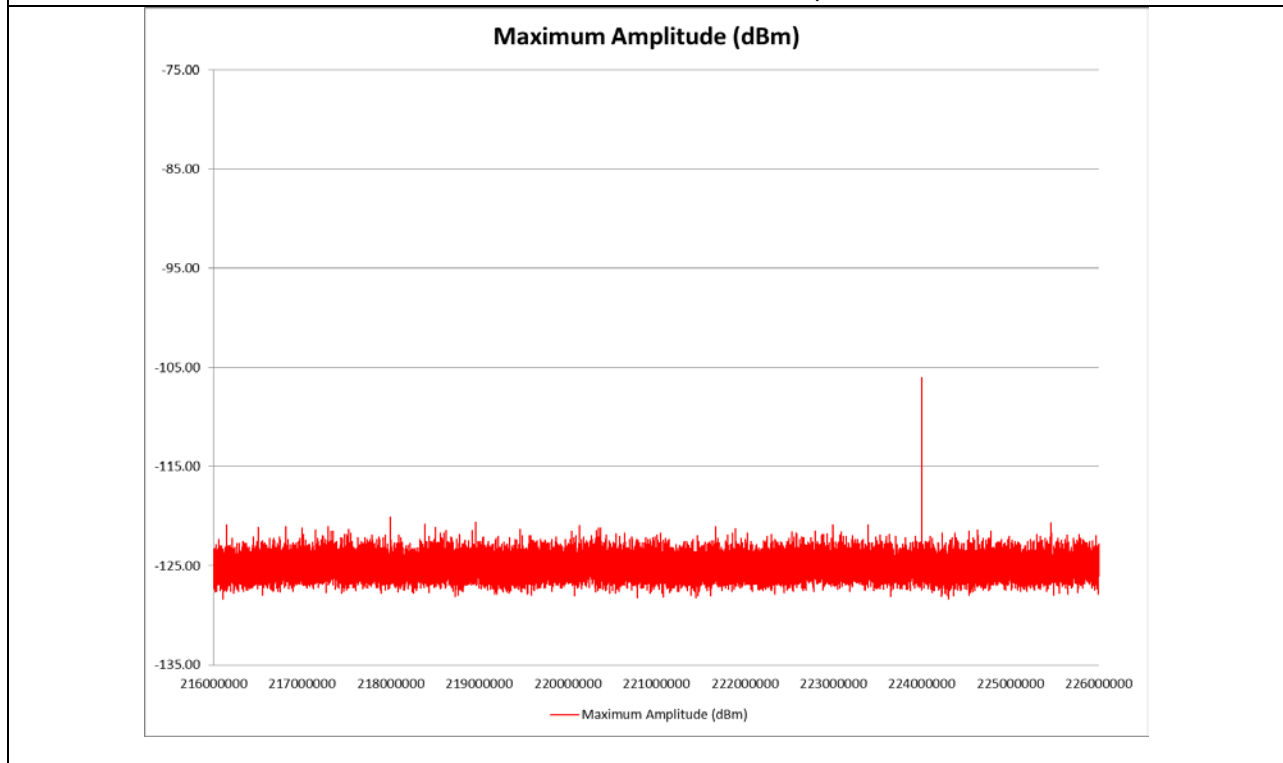

DPB XMIT with VHF DPA and HOT/EOT

Transmit Intermodulation—Additional RFI

When transmitting on the AAR VHF Voice Radio, Significant RF Energy was measured in the 220 MHz Band. Testing on AAR Channel 13 (160.305MHz) produced a signal at ~221.11 MHz, 150 kHz to 200 kHz wide, at ~-50 dBm. Other signals were also present in the 220 MHz band varying in Amplitude from ~-105 dBm to ~-95 dBm. The Signals were Analog, and therefore could be demodulated, and were found to be carrying Broadcast Programming Audio. A scan of the FM Broadcast Band revealed signals with matching traffic. Traffic intercepted at ~221.11 MHz at ~-50 dBm matched, in real time, traffic intercepted at 99.5 MHz at ~-35 dBm. The Intermodulation Product relationship to the frequencies intercepted is $2A-B=C$, where A is 160.305 MHz, B is 99.5 MHz and $C=221.11$ MHz. The plate on the left, below, captured the FM Broadcast Band from 88.1 MHz to 107.9 MHz. The plate on the right, below, captured the 220 MHz Band from 216 MHz to 226 MHz while using the AAR VHF Voice Radio to transmit on AAR Channel 13 (160.305 MHz).

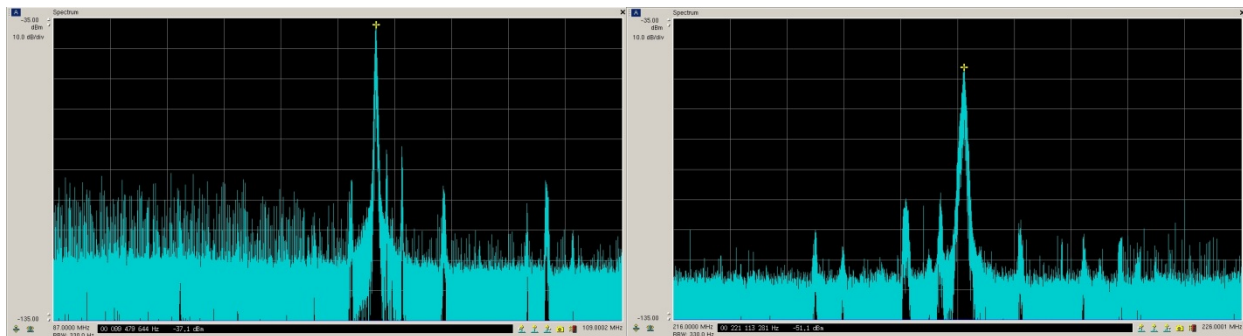

It is likely that the Intermodulation Products are being generated in the Power Amplifier stage of the AAR VHF Voice Radio. Most Land Mobile Radios employ a Low Pass Filter for FCC Compliance (to filter the 2nd and 3rd harmonics normally present in the Power Amplifier stage of any radio transmitter). A Band Pass Filter, with sharp cutoffs, would be a better choice than a Low Pass Filter, from a technical perspective, but economic concerns are involved in the decision to use a Low Pass Filter with a gradual cutoff (in order to control costs). Because of this, there is nothing in the radio's design to inhibit the FM Broadcast signals from entering the radio via the antenna port. Congruently, the lack of a steep cutoff in the Low Pass Filter allows 220 MHz products generated in the Power Amplifier stage to exit the radio via the antenna port, and are thus reradiated at a significant level.

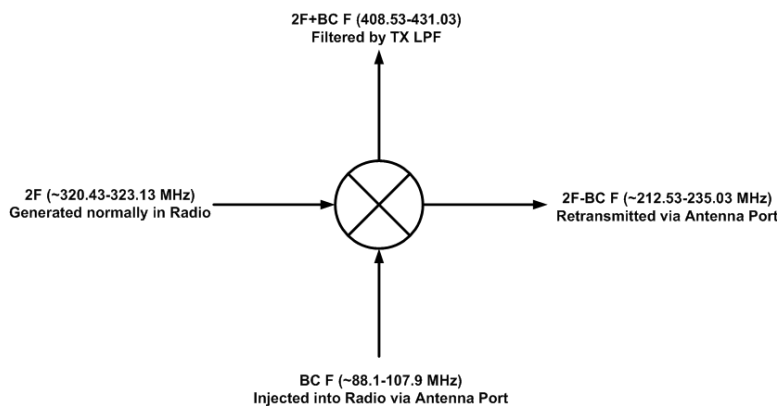

Typically, conversion loss is 10 dB to 15 dB, and antenna inefficiencies at 220 MHz probably account for 3 dB to 6 dB more of loss. Thus, 99.5 MHz at -35 dBm in produces ~221.11 MHz at -50 dBm out.

Further investigation of FM Broadcast contribution revealed that, according to FCC records, WVMD (99.5 MHz) is licensed to the West Virginia Radio Corporation of the Alleghenies and is authorized to operate an FM Booster, at a power of 1200 Watts ERP using a non-directional circularly polarized antenna system. While relatively low powered by Broadcast standards, the facility is within 1050 feet of the Test location for CSX 985 at the CSX Cumberland Yard, as shown below.



If the FM Broadcast signal is strong enough, other entry points into the radio should be considered. Such entry points may be through induction along the DC Power leads, the Microphone/Handset leads, the Control leads, or even the cases of the Control Head and the RF Deck. Mitigation may include Ferrite Toroids, RF Chokes, or Bypass Capacitors, or some combination, such as a Pi Network. Finger Stock or Braid may be needed to treat the RF Deck or Control Head cases for RF integrity. Similar consideration for Base Stations, Control Stations and Mobiles (Hyrrail Radios) is recommended, especially in locations where high-level FM Broadcast signals are present. Portables (hand-held radios) are also capable of significant contribution, especially if operated near the PTC 220 MHz Locomotive Antennas. However, treating Portables is not usually feasible due to physical limitations and operational realities. Further testing is recommended to capture the entire scope of what is happening.

EMI Testing

The purpose of this test is to characterize the EMI produced by the unintentional radiators present in the electromechanical equipment and any electronic support equipment ancillary to the power plant operation. The testing results showed some increases in the noise floor level while operating through the start-up and shut-down phases. A very minor difference between the conductor and engineer side noise floor (only about 1-2 DB) was indicated during testing. This may be attributed to the physical location of the antenna feed point relative to some on-board power sources, the pattern characteristic differences between the two antennas related to Antenna orientation, or the routing of the two different cable bundles.

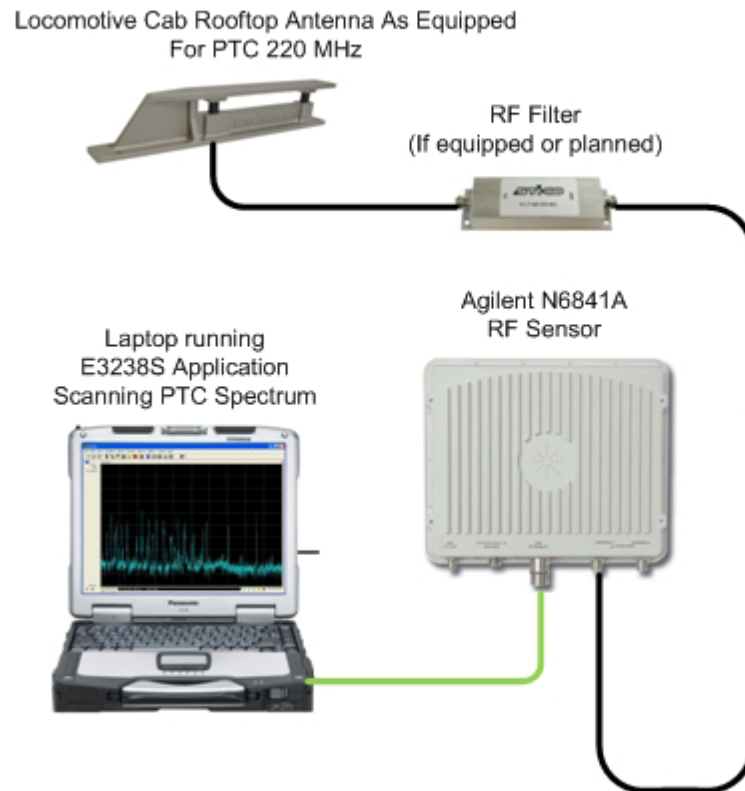

EMI Testing Configuration
Figure 23

	A	B	C	D	E	F	G	H	I	J	K	L	M	N	O
1	Frequency	Bandwidth	Number Sweeps	Intercepts	Detections	Minimum Amplitude (dBm)	Average Amplitude (dBm)	Maximum Amplitude (dBm)	Minimum Bandwidth	Average Bandwidth	Maximum Bandwidth	Minimum Duration	Average Duration	Maximum Duration	Percent Occupancy
2	216000214	214	1314	85	10.00	-131.57	-125.99	-120.80	213.62	213.62	213.62	0.05	0.01	0.06	6.5%
3	216000427	214	1341	254	29.00	-131.92	-126.97	-120.89	213.62	213.62	213.62	0.05	0.01	0.27	18.9%
4	216000641	214	1334	330	60.00	-131.98	-126.83	-121.90	213.62	213.62	213.62	0.05	0.01	0.30	24.7%
5	216000855	214	1339	288	48.00	-131.80	-127.21	-121.00	213.62	213.62	213.62	0.05	0.01	0.20	21.5%
6	216001068	214	1341	190	23.00	-131.98	-126.77	-121.79	213.62	213.62	213.62	0.05	0.01	0.23	14.2%
7	216001282	214	1342	545	131.00	-131.94	-124.90	-119.33	213.62	214.01	427.25	0.05	0.02	0.38	40.6%
8	216001495	214	1340	420	92.00	-131.87	-125.24	-119.77	213.62	214.13	427.25	0.05	0.02	0.20	31.3%
9	216001709	214	1334	174	16.00	-131.86	-126.68	-120.89	213.62	214.85	427.25	0.05	0.00	0.11	13.0%
10	216001923	214	1342	361	71.00	-131.98	-126.29	-120.77	213.62	213.62	213.62	0.05	0.02	1.45	26.9%
11	216002136	214	1336	406	82.00	-131.95	-125.97	-119.31	213.62	213.62	213.62	0.05	0.01	0.25	30.4%
12	216002350	214	1342	252	39.00	-131.94	-126.71	-121.37	213.62	213.62	213.62	0.05	0.01	0.11	18.8%
13	216002564	214	1329	262	41.00	-131.98	-127.02	-122.01	213.62	213.62	213.62	0.05	0.01	0.16	19.7%
14	216002777	214	1341	329	59.00	-131.98	-125.90	-119.16	213.62	214.27	427.25	0.05	0.01	0.16	24.5%
15	216002991	214	1338	463	102.00	-131.92	-125.54	-119.63	213.62	213.62	213.62	0.05	0.02	0.27	34.6%
16	216003204	214	1340	307	59.00	-131.84	-125.81	-120.77	213.62	213.62	213.62	0.05	0.01	0.16	22.9%
17	216003418	214	1342	305	48.00	-131.71	-126.40	-119.80	213.62	214.32	427.25	0.05	0.01	0.16	22.7%
18	216003632	214	1341	301	53.00	-131.80	-126.54	-120.70	213.62	213.62	213.62	0.05	0.01	0.20	22.4%
19	216003845	214	1337	289	56.00	-131.98	-127.10	-120.43	213.62	214.36	427.25	0.05	0.01	0.22	21.6%
20	216004059	214	1336	308	58.00	-131.97	-127.08	-122.06	213.62	213.62	213.62	0.05	0.01	0.27	23.1%
21	216004273	214	1338	298	53.00	-131.98	-126.85	-120.96	213.62	214.34	427.25	0.05	0.01	0.20	22.3%
22	216004486	214	1339	332	65.00	-131.80	-127.04	-121.12	213.62	213.62	213.62	0.05	0.01	0.33	24.8%
23	216004700	214	1341	381	75.00	-131.98	-126.40	-121.15	213.62	213.62	213.62	0.05	0.02	0.23	28.4%
24	216004913	214	1335	277	44.00	-131.97	-127.08	-120.32	213.62	213.62	213.62	0.05	0.01	0.11	20.7%
25	216005127	214	1337	296	49.00	-131.98	-127.02	-121.40	213.62	213.62	213.62	0.05	0.01	0.22	22.1%
26	216005341	214	1341	327	65.00	-131.97	-127.02	-119.80	213.62	213.62	213.62	0.05	0.01	0.16	24.4%
27	216005554	214	1342	293	52.00	-131.98	-126.89	-121.16	213.62	213.62	213.62	0.05	0.01	0.20	21.8%
28	216005768	214	1335	311	56.00	-131.87	-127.15	-121.00	213.62	214.31	427.25	0.05	0.01	0.11	23.3%
29	216005981	214	1338	293	54.00	-131.98	-126.86	-120.96	213.62	214.35	427.25	0.05	0.01	0.13	21.9%
30	216006195	214	1342	312	59.00	-131.97	-126.99	-120.94	213.62	213.62	213.62	0.05	0.02	1.45	23.2%
31	216006409	214	1338	302	55.00	-131.98	-127.35	-122.10	213.62	214.33	427.25	0.05	0.01	0.16	22.6%
32	216006622	214	1342	322	60.00	-131.98	-127.00	-121.25	213.62	214.29	427.25	0.05	0.01	0.25	24.0%
33	216006836	214	1339	296	49.00	-131.92	-127.08	-122.56	213.62	213.62	213.62	0.05	0.01	0.25	22.1%
34	216007050	214	1341	325	63.00	-131.97	-127.04	-121.10	213.62	214.94	427.25	0.05	0.01	0.23	24.2%
35	216007263	214	1336	313	64.00	-131.98	-127.22	-121.77	213.62	213.62	213.62	0.05	0.01	0.31	23.4%

Energy File Data Format
Figure 24

This is a sample of the data captured on each locomotive, each excel file is approximately 10 MB, comprised 46000 frequency information points and the associated amplitude, duration, bandwidth and percent occupancy information. Without a Locomotive-scaled Faraday Cage and Anechoic Chamber, it is not possible to fully isolate the locomotive from its environment. However, by perusing the following charts, with less focus on the discrete signals present (spikes), and more focus on the overall changes between Locomotive operational states, it is possible to characterize the noise. The Energy Files are provided in the Appendix to permit further manipulation of the data, if desired.

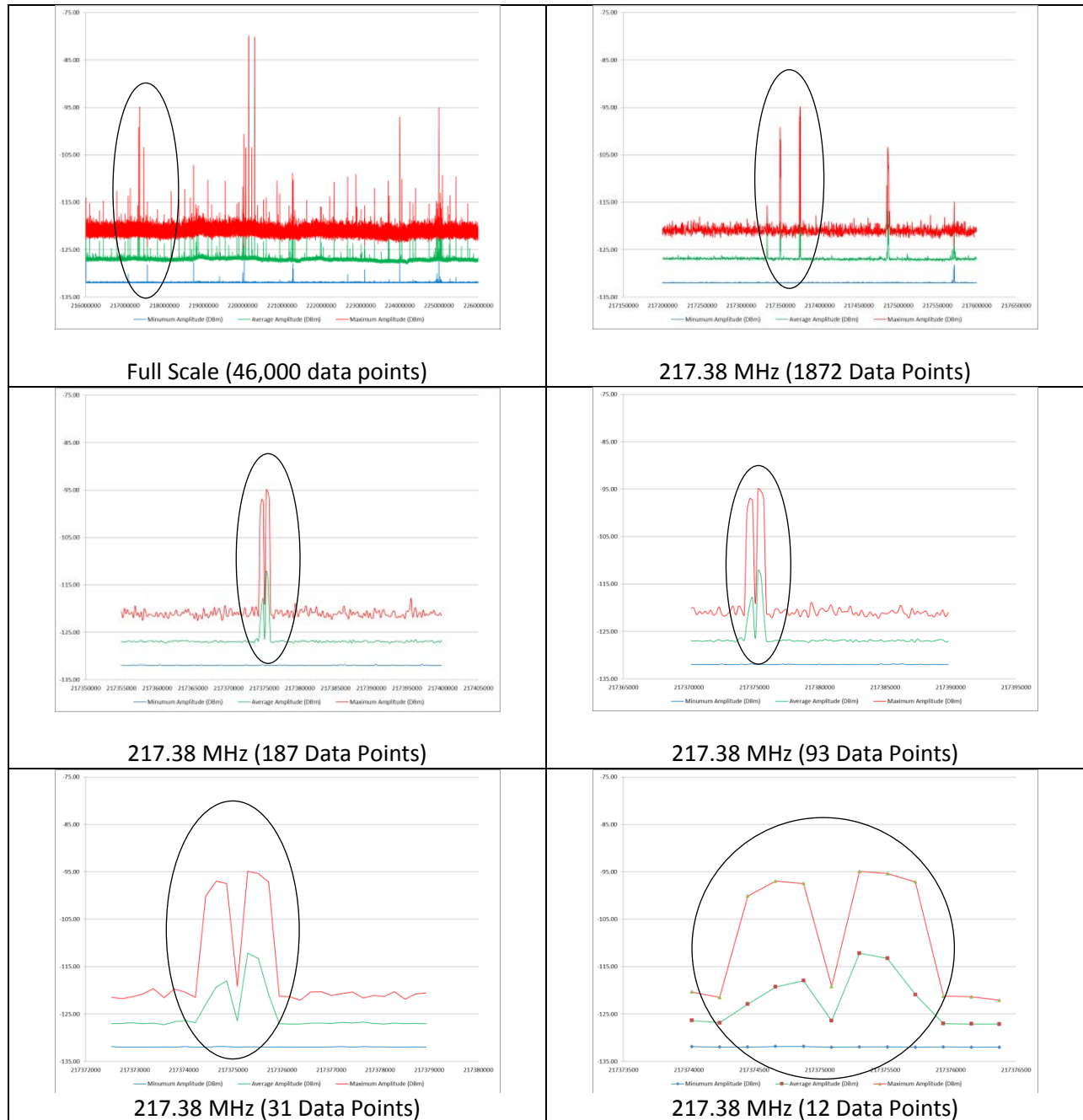
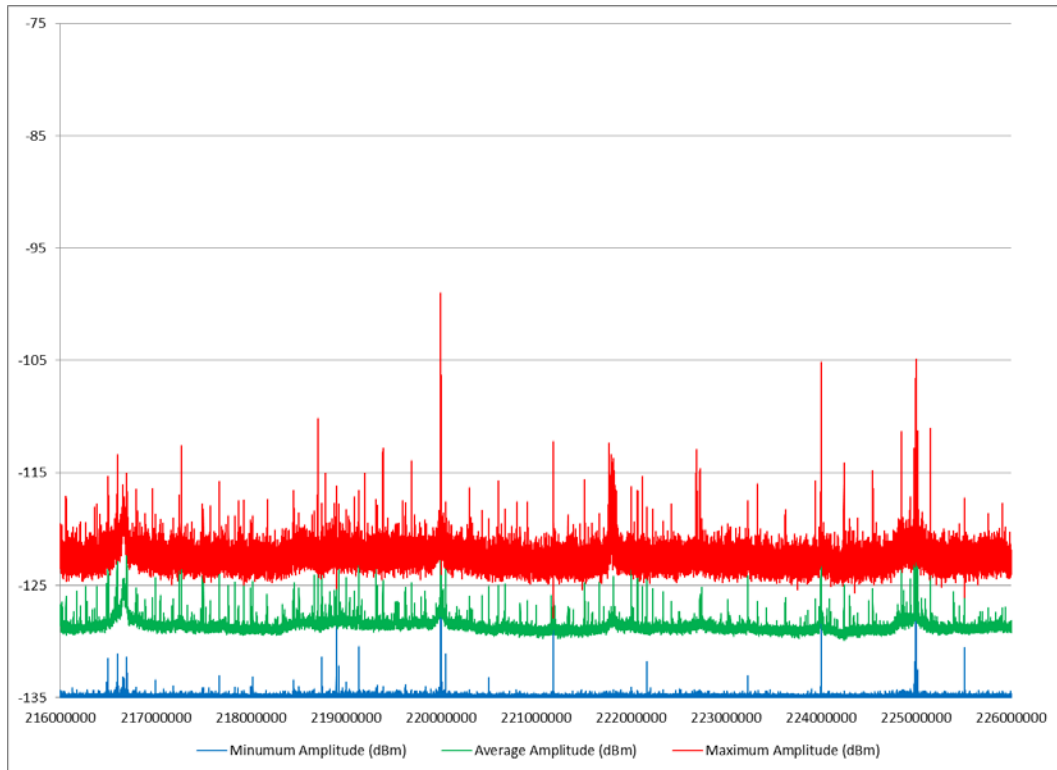
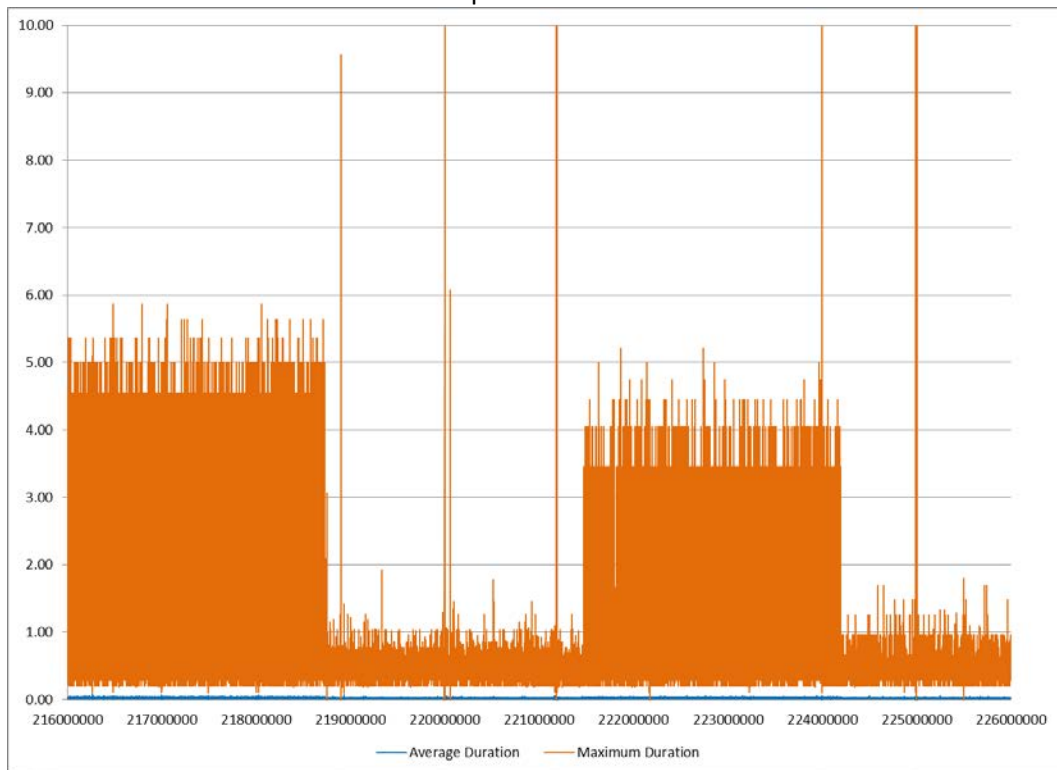

Figure 25

The following charts represent XY scatter chart with lines in EXCEL. Because of the amount of information shown in each chart the data might appear to be a spectrograph exported from a spectrum analyzer, rather than a record of the signal amplitude levels or duration information extracted and plotted from the energy history files that it actually represents. In Figure 25, six different resolutions of the information have been created to show the individual data points and how they are interconnected. It is important to note, for both Amplitude and Duration, that there is a significant difference between Maximum and Average magnitudes for any given Frequency measured.



Amplitude Profile



Duration Profile

CSX 985 Engine Off State

Figure 26

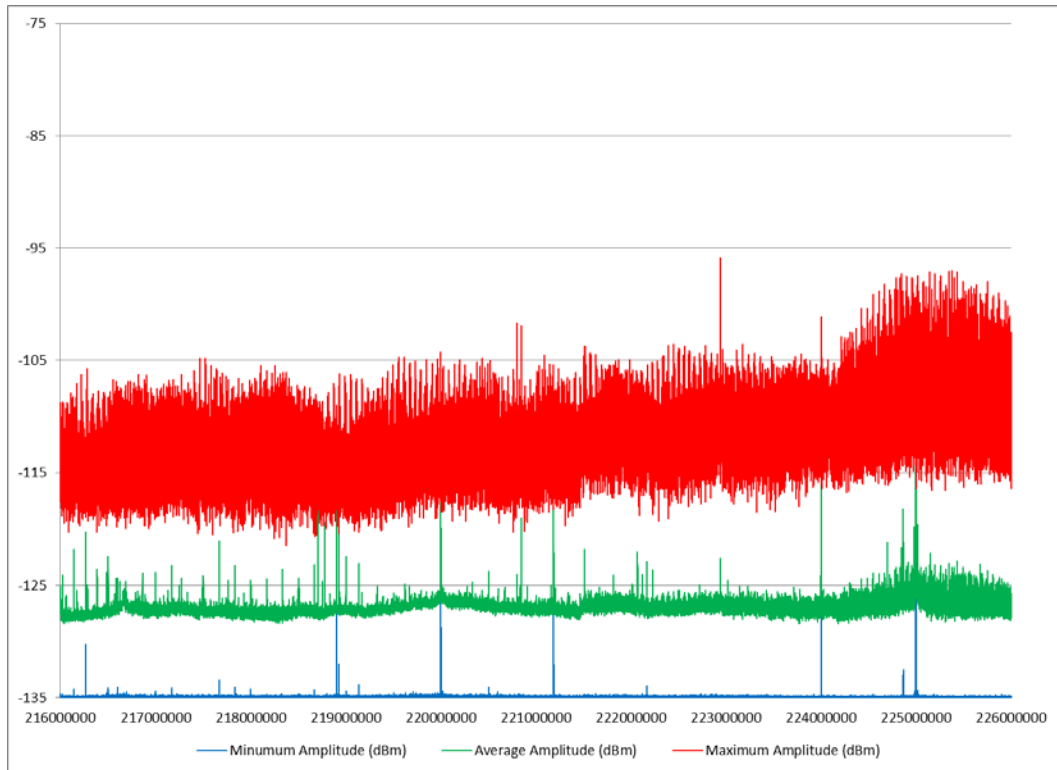

Amplitude Profile

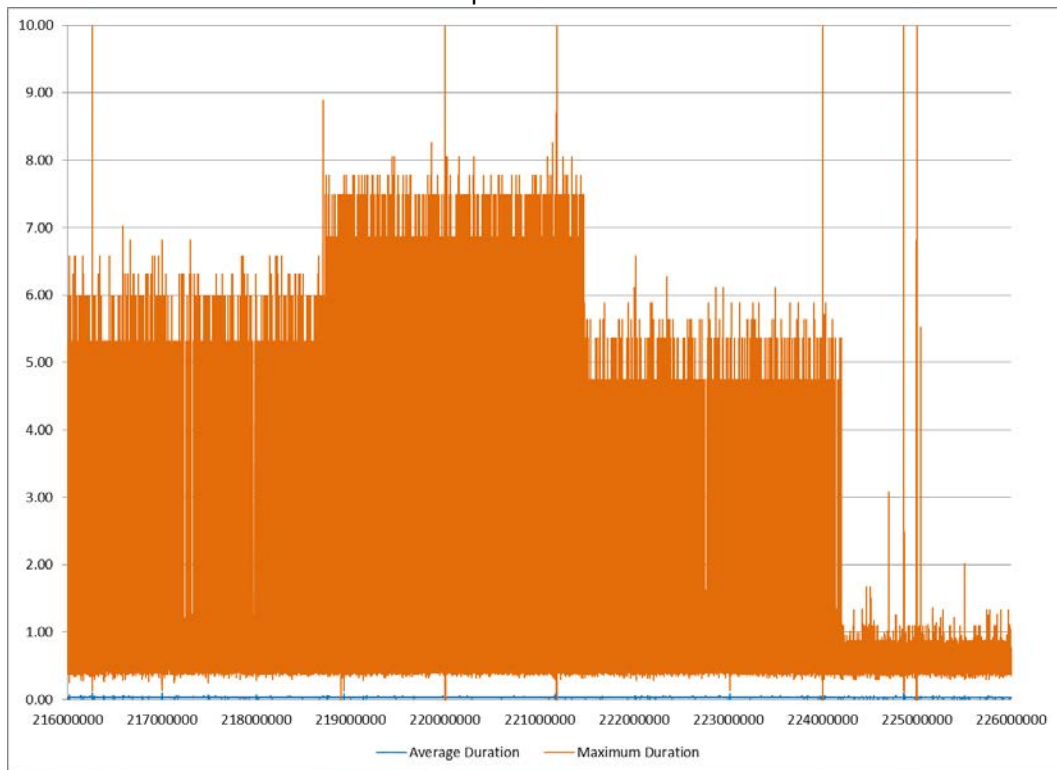

Duration Profile

CSX 985 Startup Sequence with Bell
Figure 27

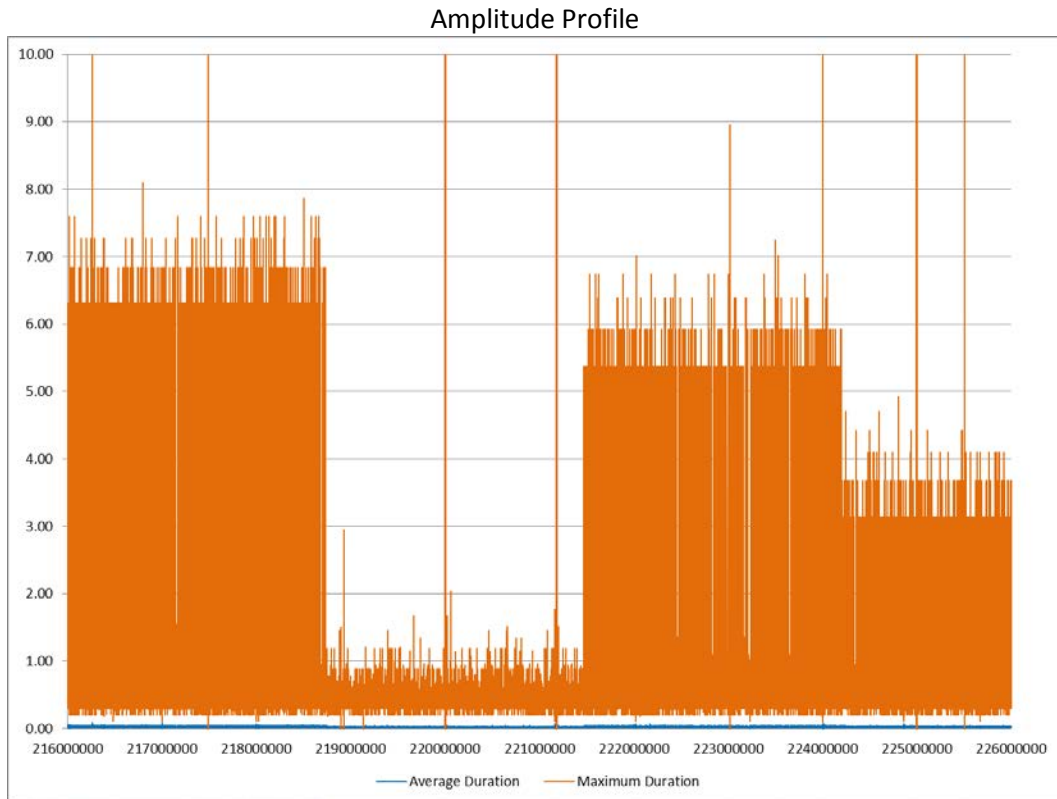
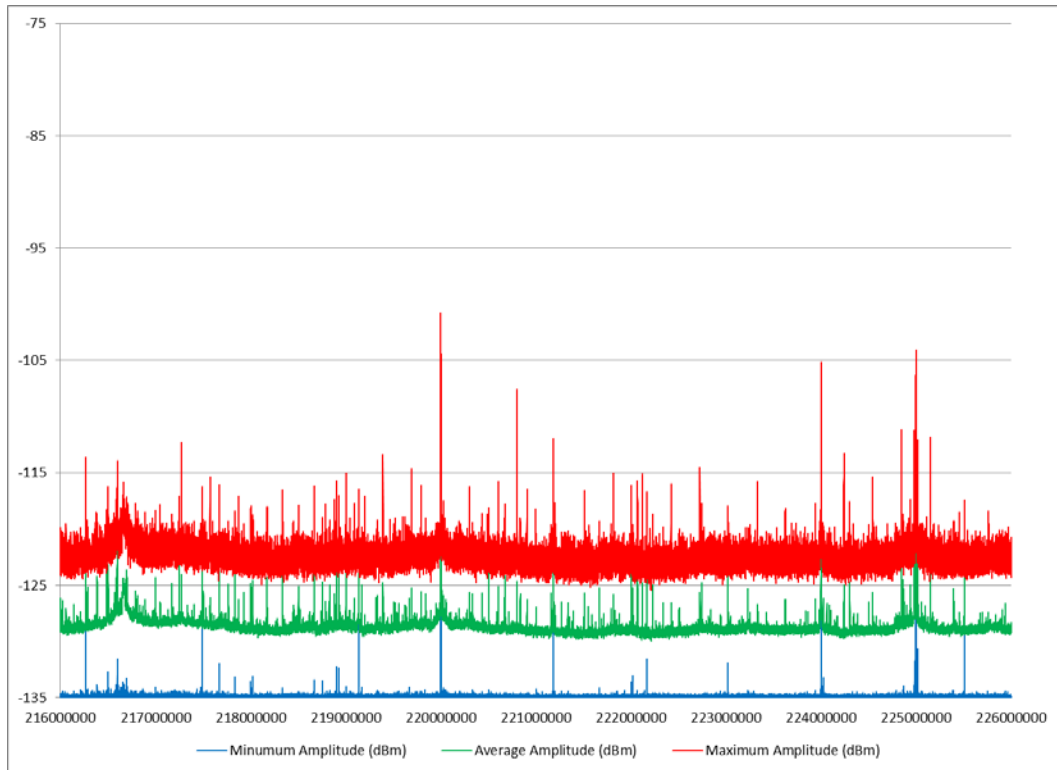

Duration Profile
CSX 985 Engine Idle
Figure 28

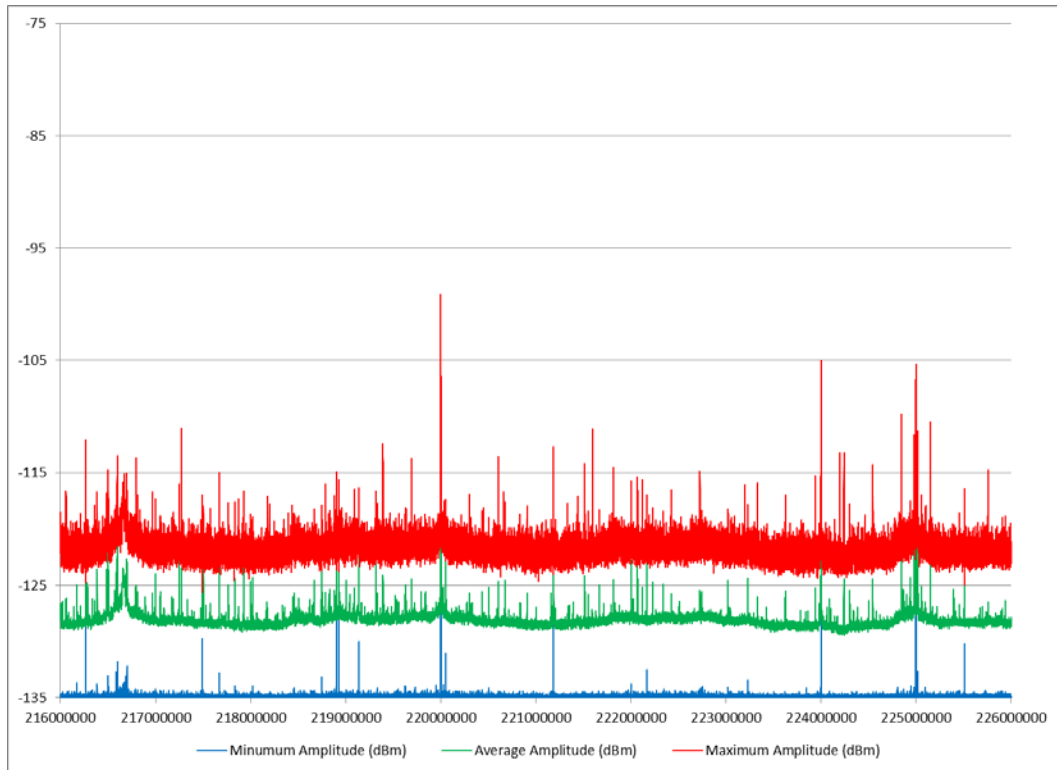

Amplitude Profile

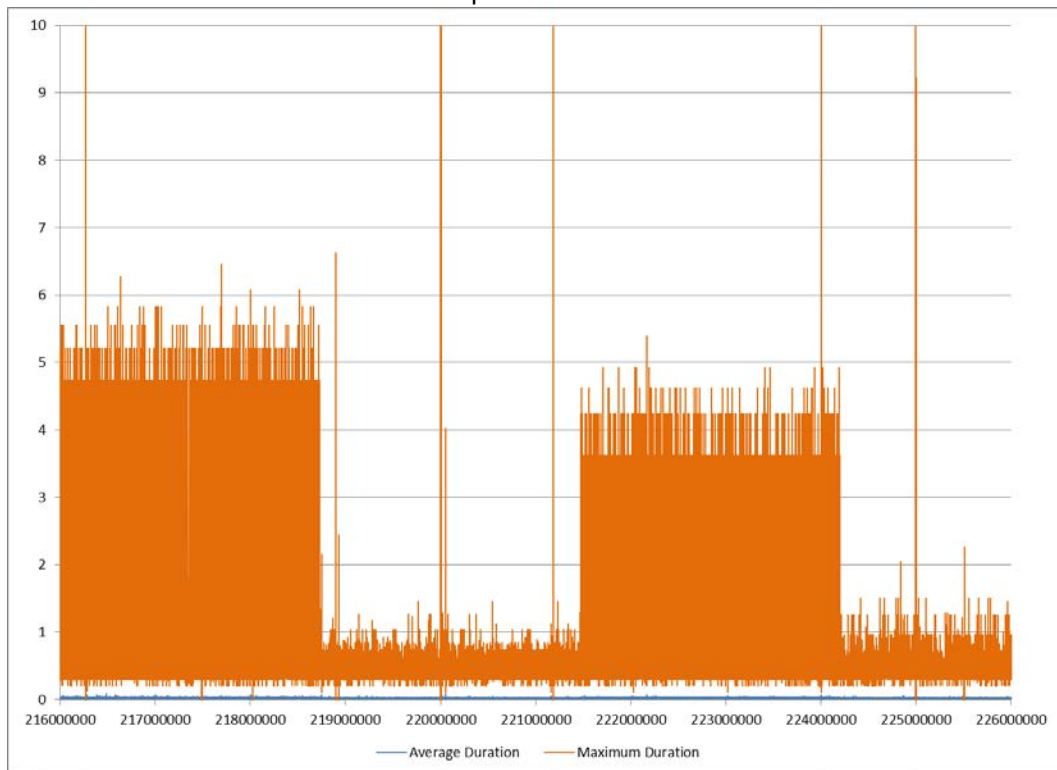

Duration Profile

CSX 985 Notch 1

Figure 29

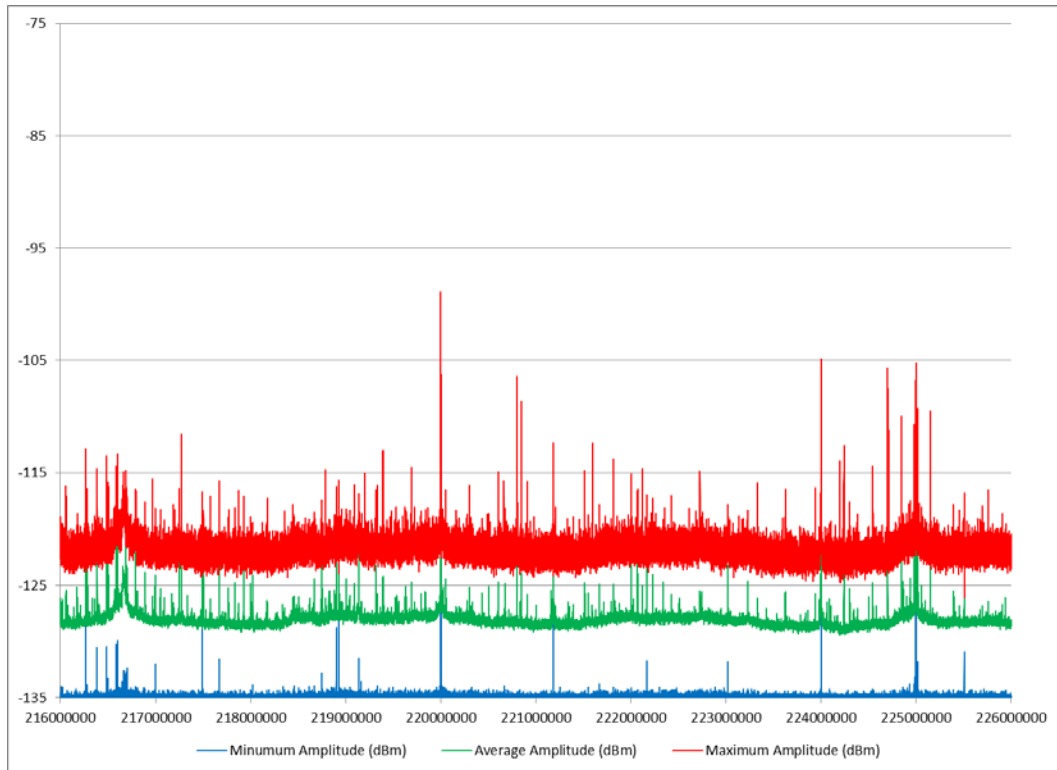

Amplitude Profile

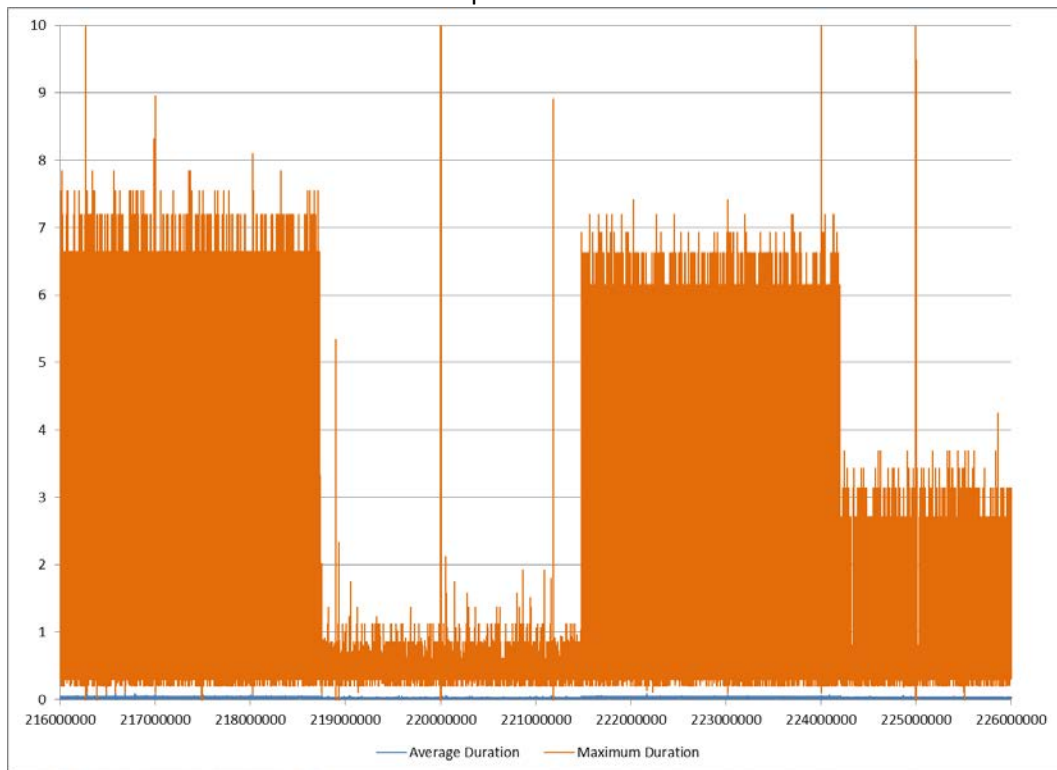

Duration Profile

CSX 985 Notch 2

Figure 30

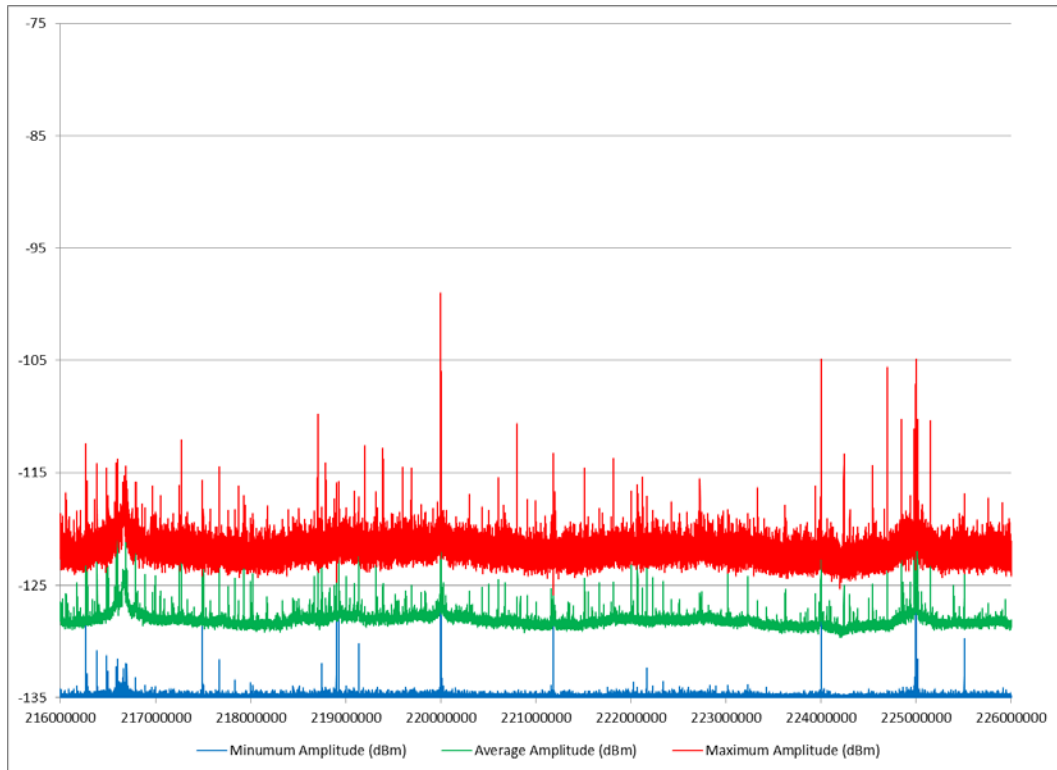

Amplitude Profile

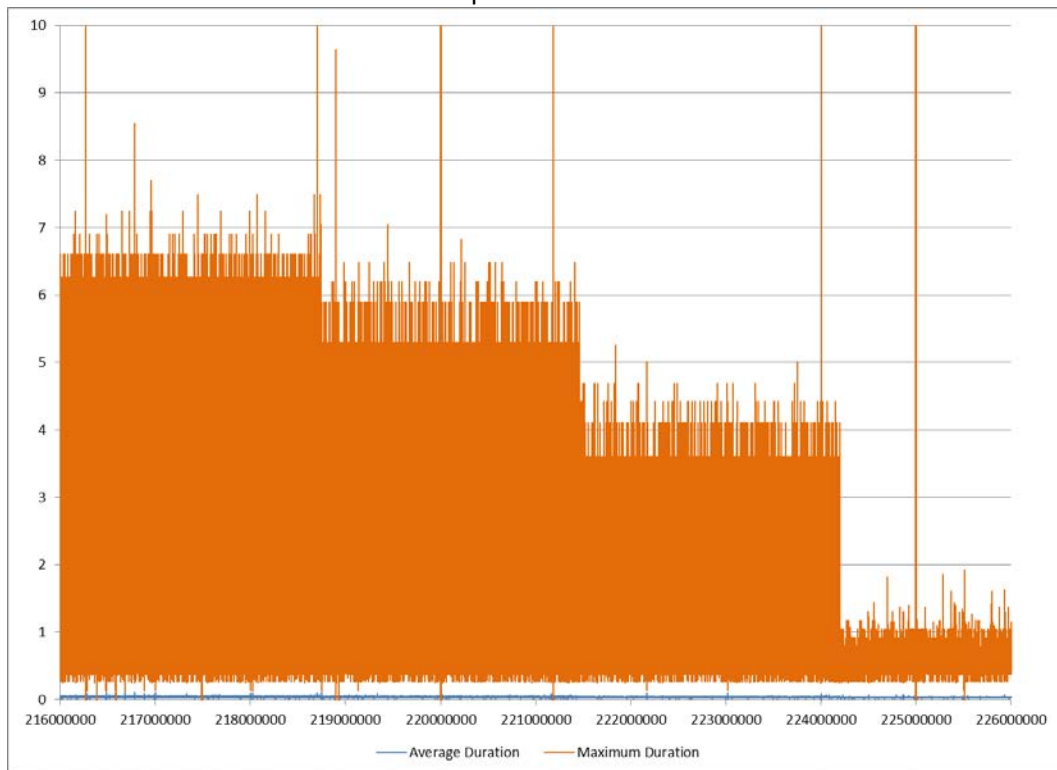

Duration Profile

CSX 985 Notch 3

Figure 31

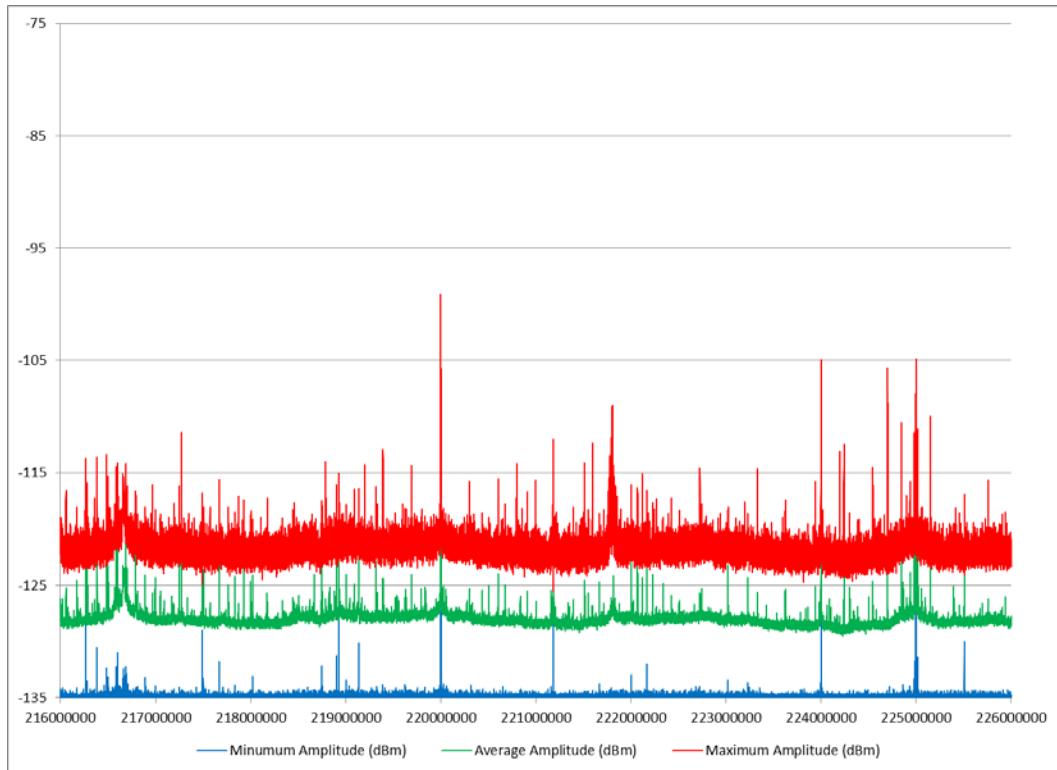

Amplitude Profile

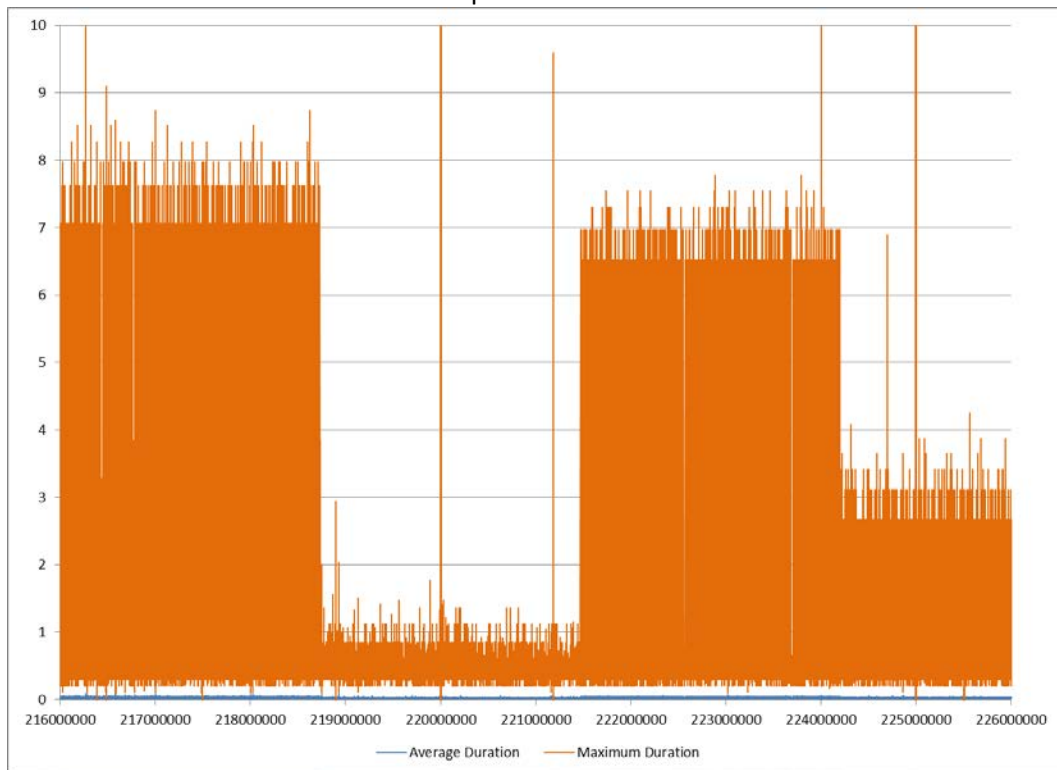

Duration Profile
CSX 985 Notch 4
Figure 32

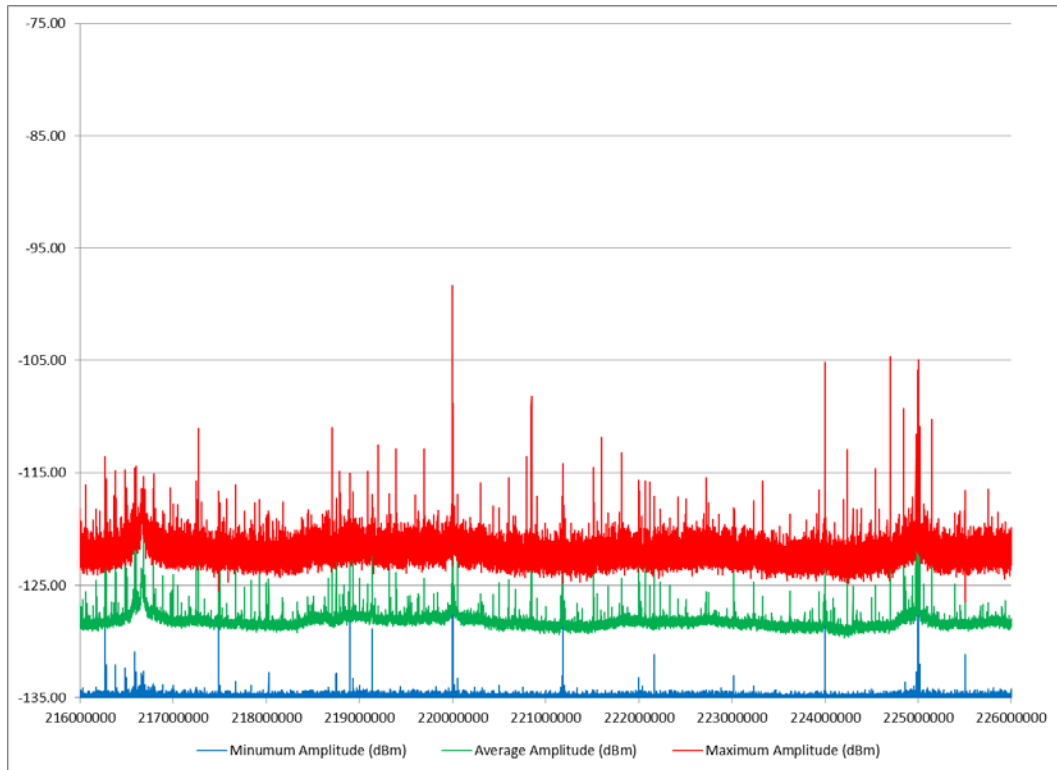

Amplitude Profile

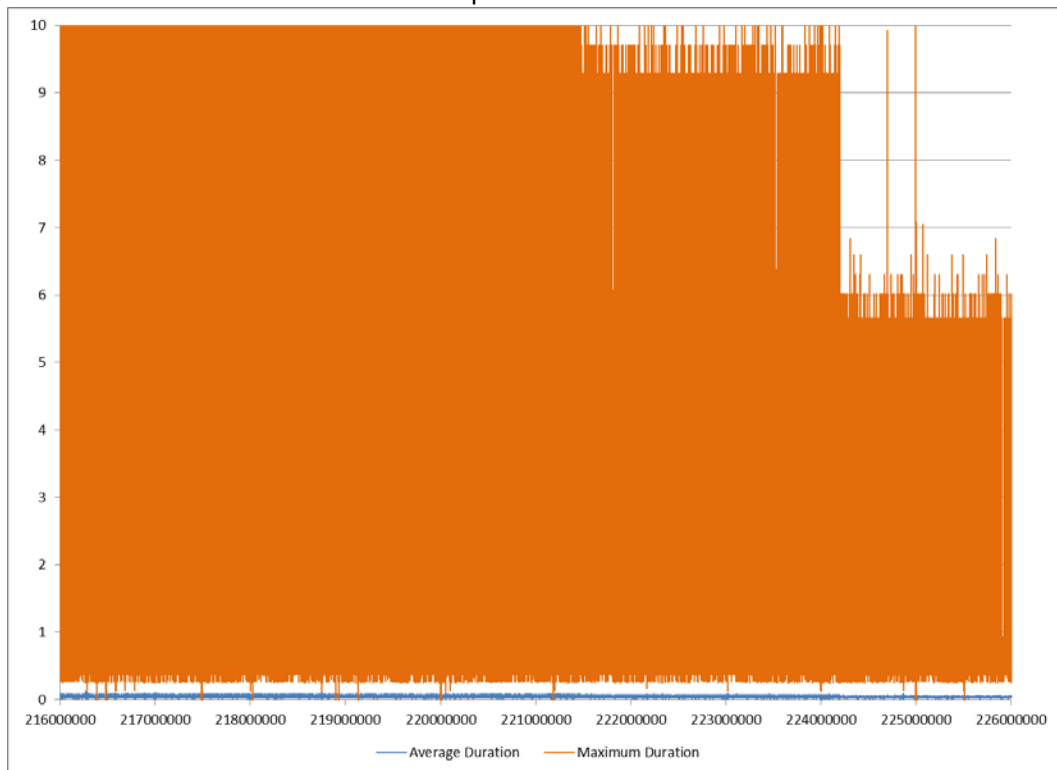

Duration Profile

CSX 985 Notch 5

Figure 33

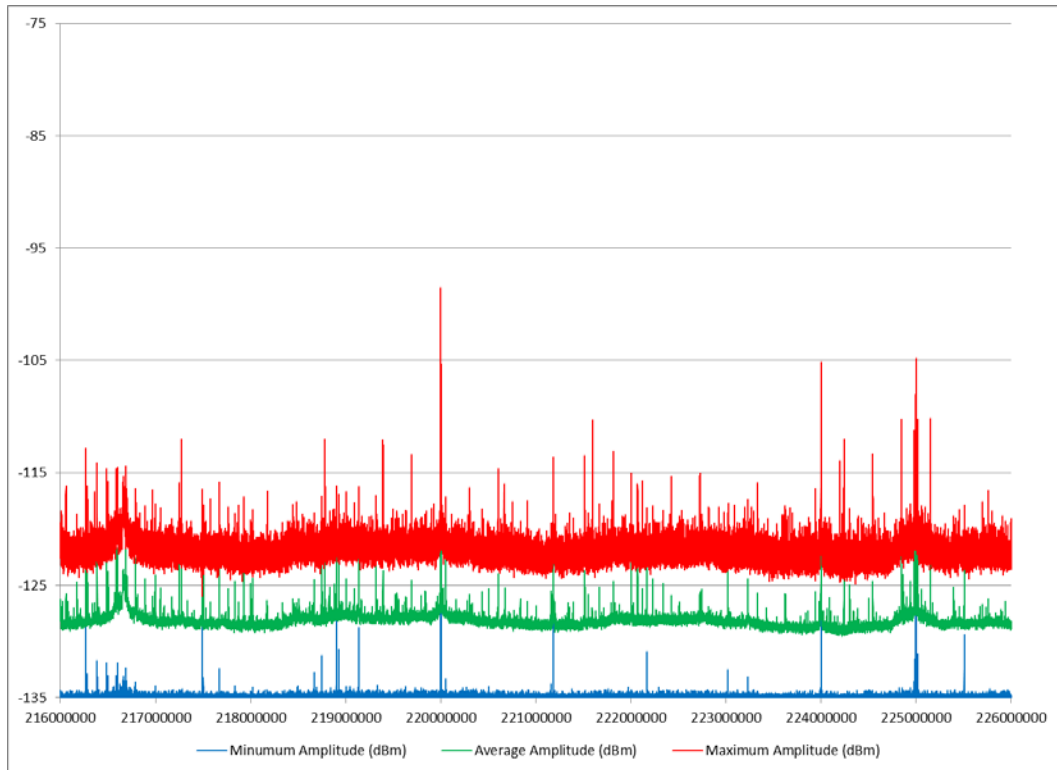

Amplitude Profile

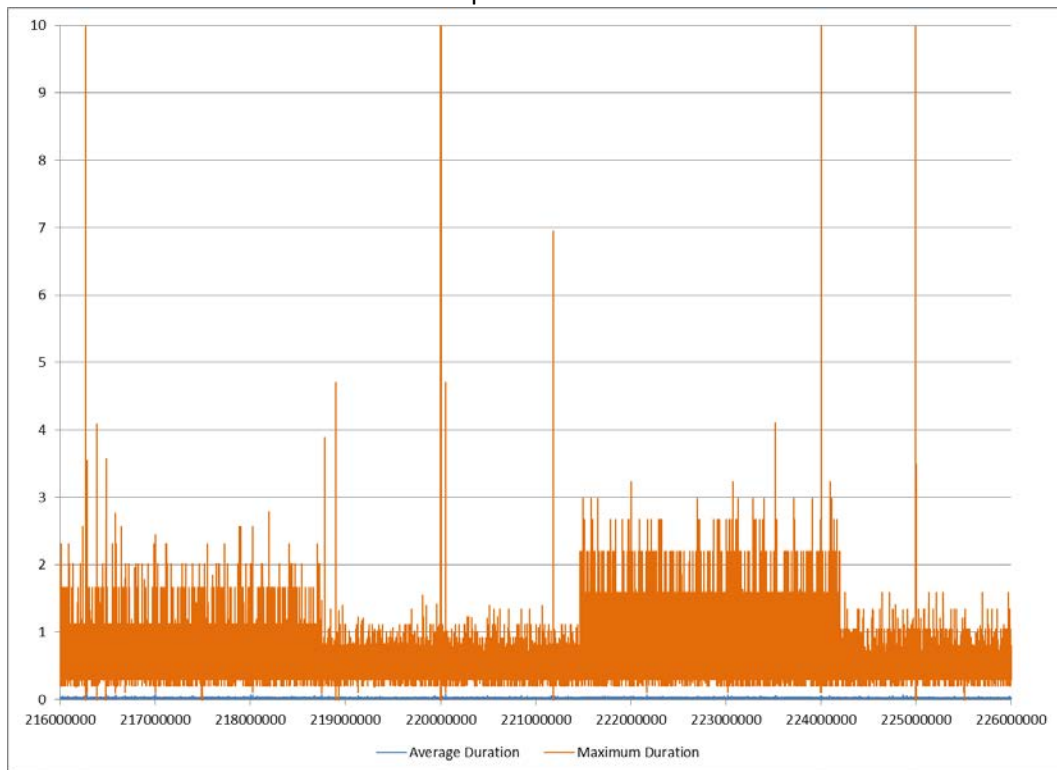

Duration Profile

CSX 985 Notch 6

Figure 34

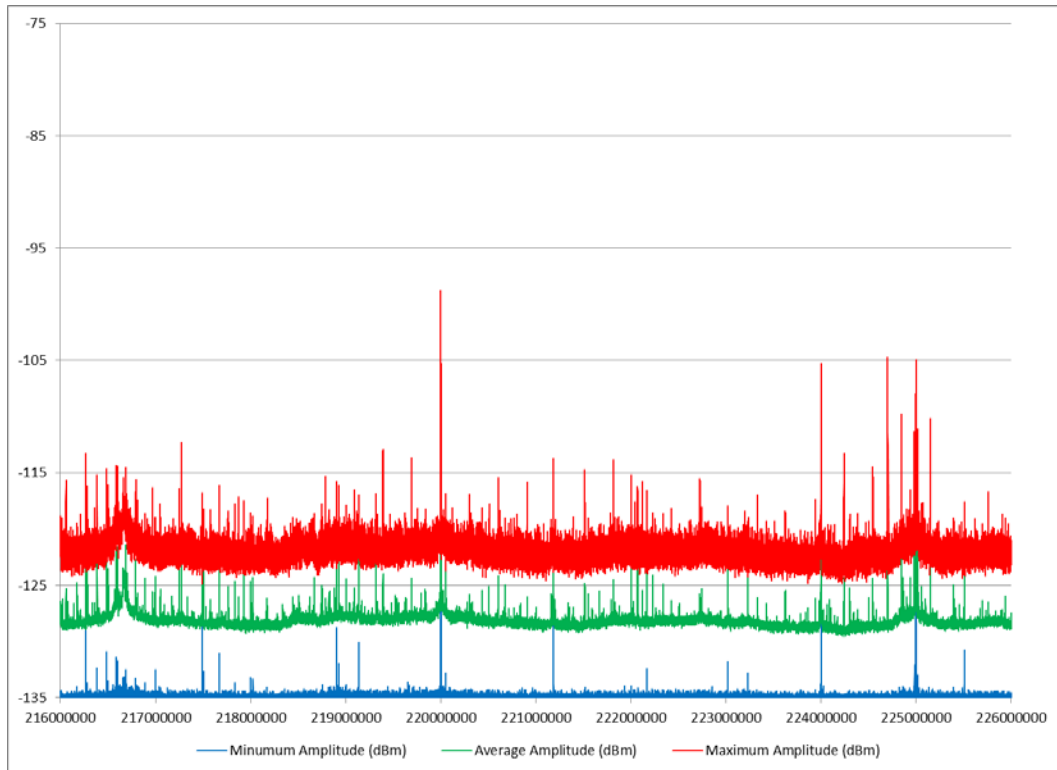

Amplitude Profile

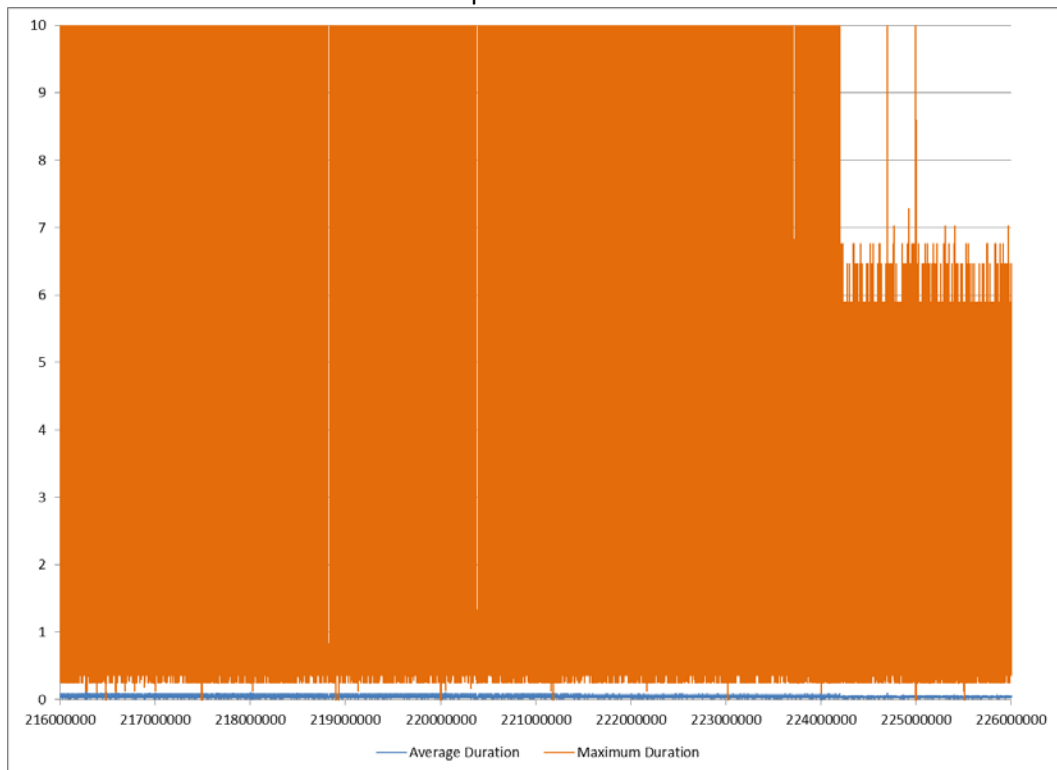

Duration Profile
CSX 985 Notch 7
Figure 35

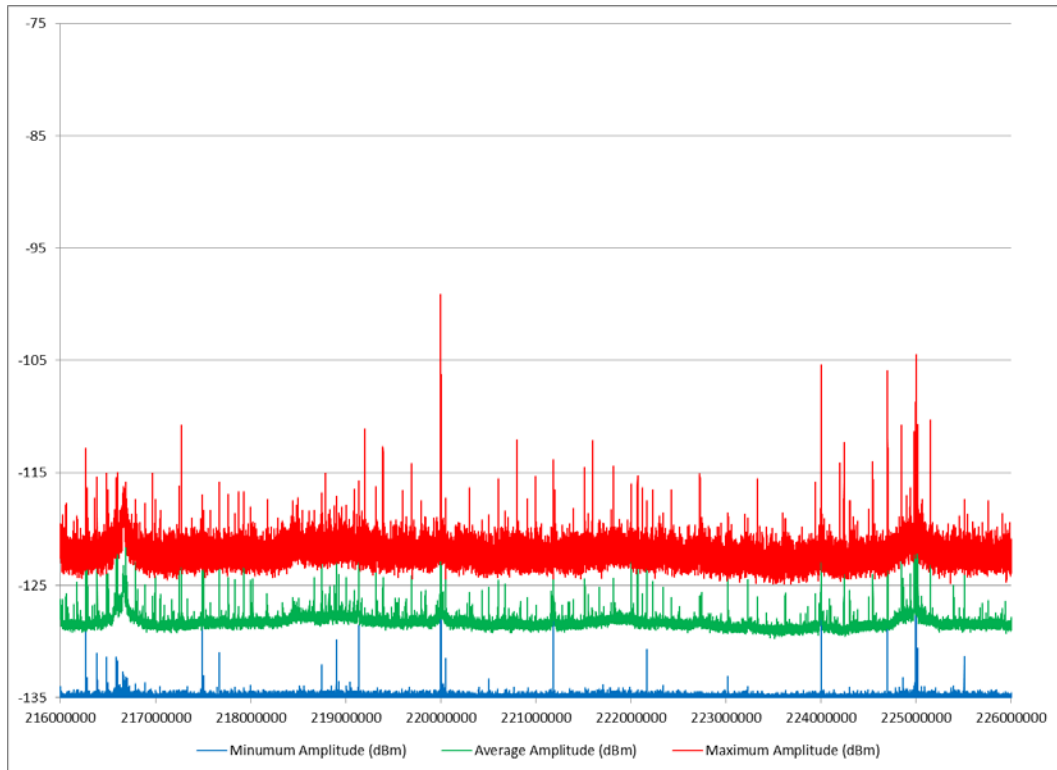

Amplitude Profile

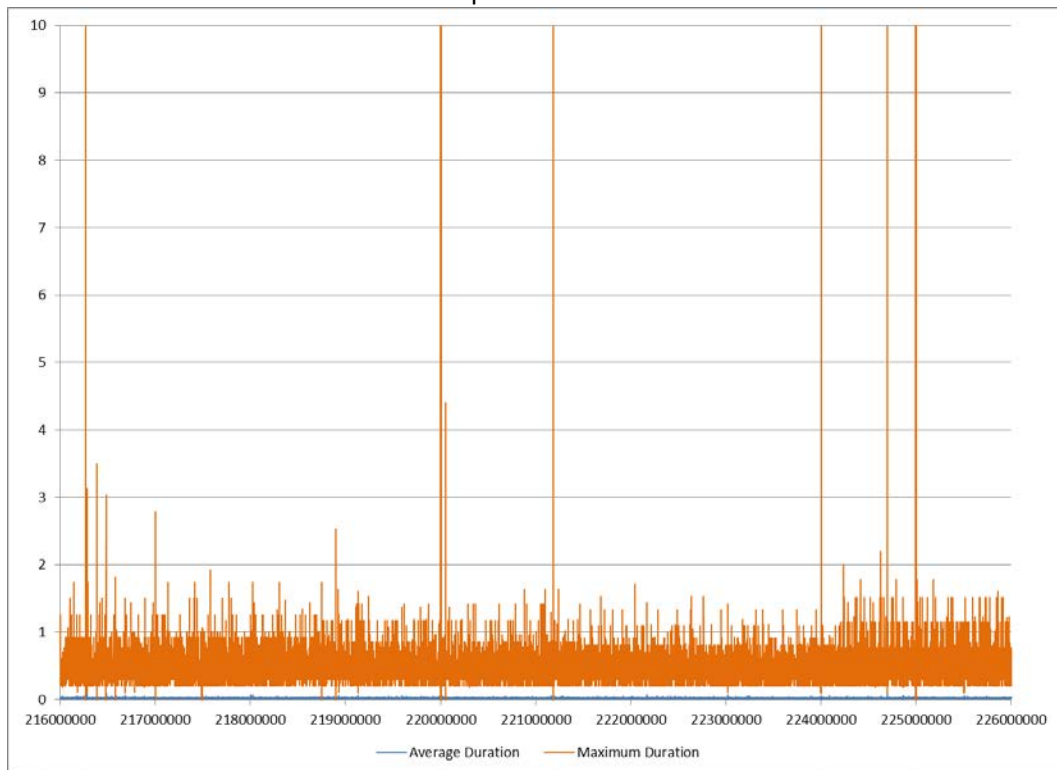

Duration Profile
CSX 985 Notch 8
Figure 36

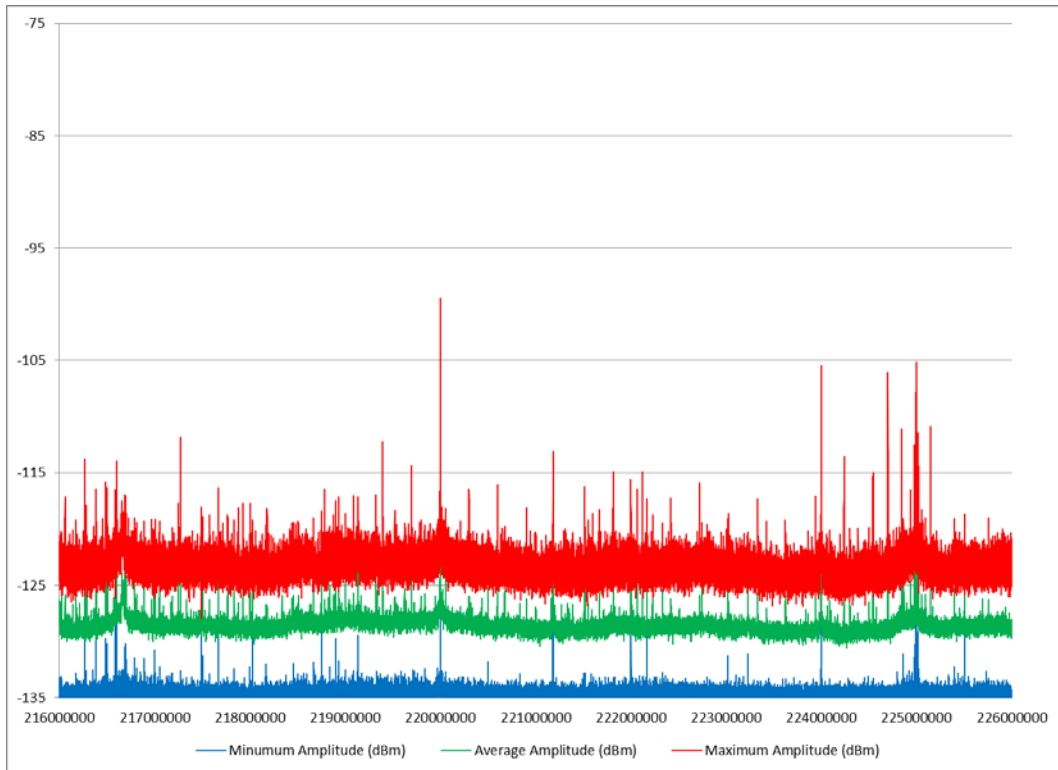

Amplitude Profile

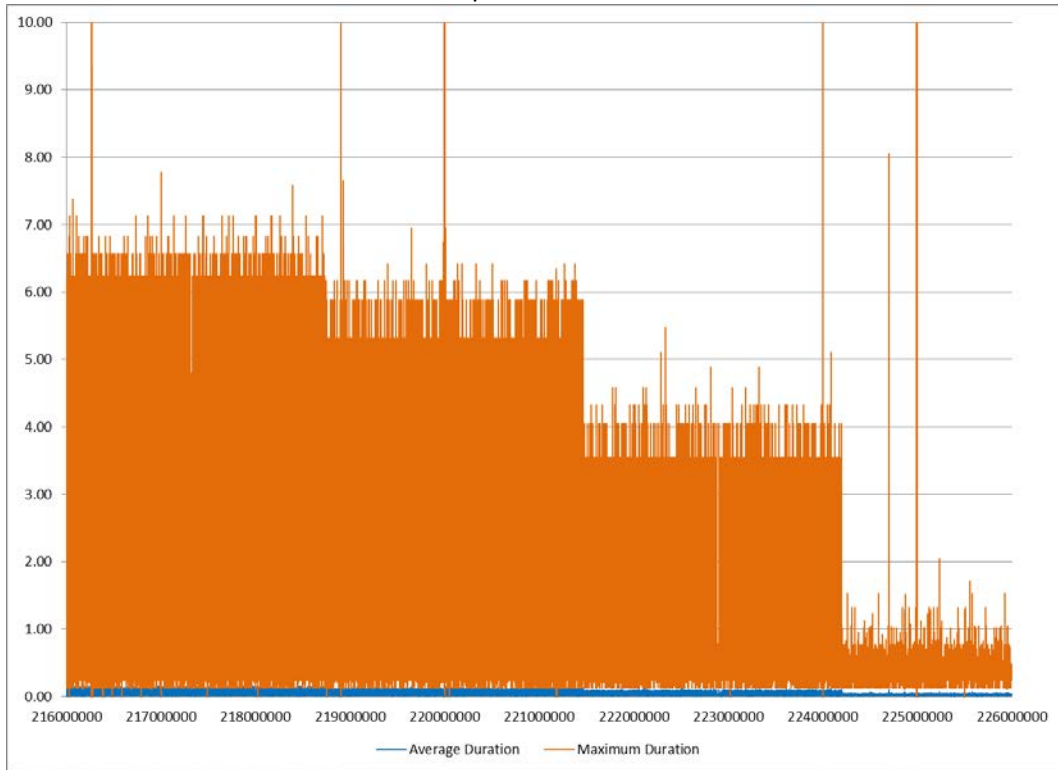

Duration Profile

CSX 985 Shutdown Sequence
Figure 37

EMI Testing—Additional EMI Source

This Locomotive has exhibited a phenomenon observed on other Locomotives in previous tests that until now, was not possible to measure separately from the rest of the Electromechanical Emissions. This Locomotive was equipped with two 60 volt DC electro-mechanical bells (Model 1209P20, manufactured by W.L. Jenkins Company).



One bell was used as a signaling bell between train crews, and was located in the Crew Space of the Cab. The other bell was used as an Automatic Startup Sequence Warning Bell, and was located in the High Voltage Space of the Power Plant. The first bell, when activated manually, exhibits no detectable EMI in the 220 MHz spectrum. The second bell, when ringing prior to autostart, generates significant EMI in the 220 MHz band. Given this observation, it may not be the bell, itself, generating the EMI. It may be some other factor, such as the bell's proximity to other EMI sources, or perhaps some other equipment that operates while the bell is ringing. Further testing with the Locomotive OEM is emphatically recommended.

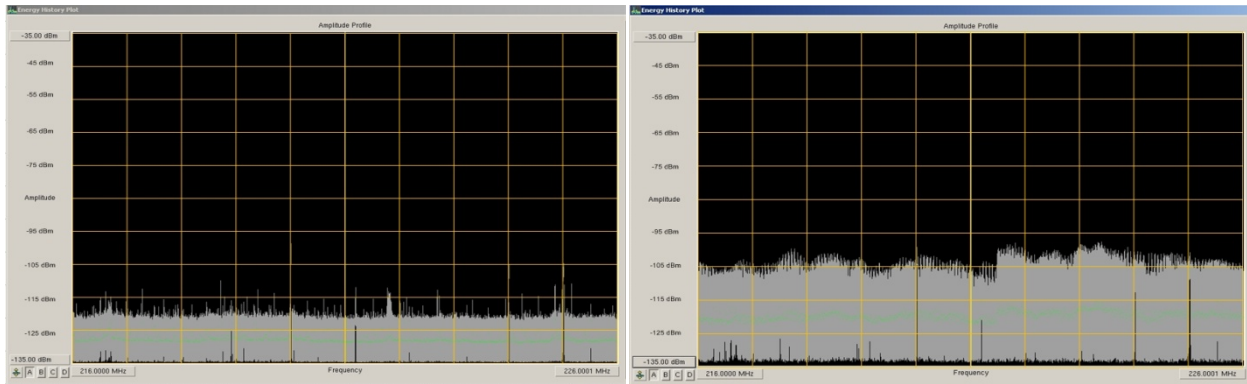

The plate on the left demonstrates the ambient EMI, with the Engine Off, while the plate on the right demonstrates the EMI that is present when the Autostart Warning Bell is ringing, prior to power plant startup. Graticules shown measure 1 MHz by 10 dB.

EMI Testing—Additional EMI Source

This Locomotive exhibited multiple, low amplitude, discrete signals discovered within a 12.5 kHz segment of the PTC 220 MHz Spectrum.

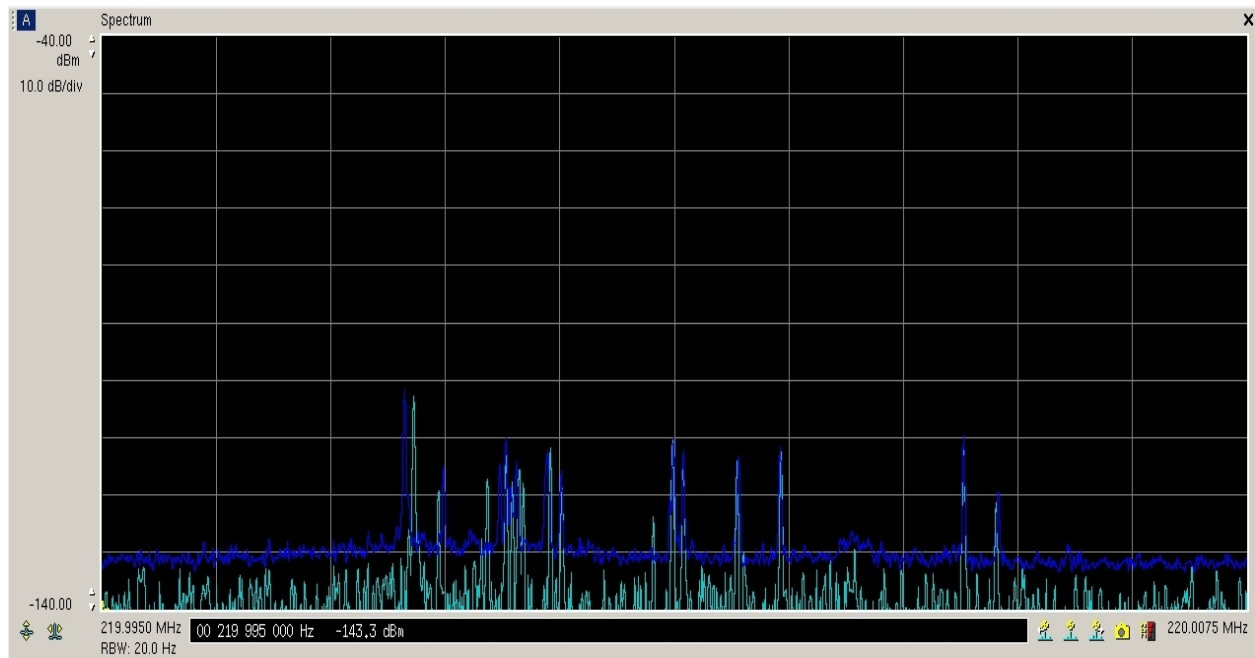

These signals are generated by various equipment power supplies, such as Cab Signal, shown as the highest Amplitude on the left. All of the others were present until the BCCB Circuit breaker was opened. They appear to vary slightly in Frequency over time, perhaps due to load or thermal variances. Additionally, other signals of similar character were detected off the air, presumably from other locomotives in the yard. Some of these other signals were clustered on other frequencies, some as far as about 1 MHz up-band. This observation suggests that these spurious emissions may be tunable, and if so, perhaps they can be tuned out of the spectrum of interest. Testing with the Locomotive OEM is recommended.

BER Testing

The purpose of this test is to determine the impact on receiving PTC transmissions in the locomotive noise environment, with the focus on capturing the minimum signal level needed for radio network planning. To accomplish this, a PTC Locomotive Radio (F3) was connected through a Directional Coupler to a Signal Generator equipped with an attenuator pad, and to the worse-case locomotive PTC Antenna. See Figure 38 below.

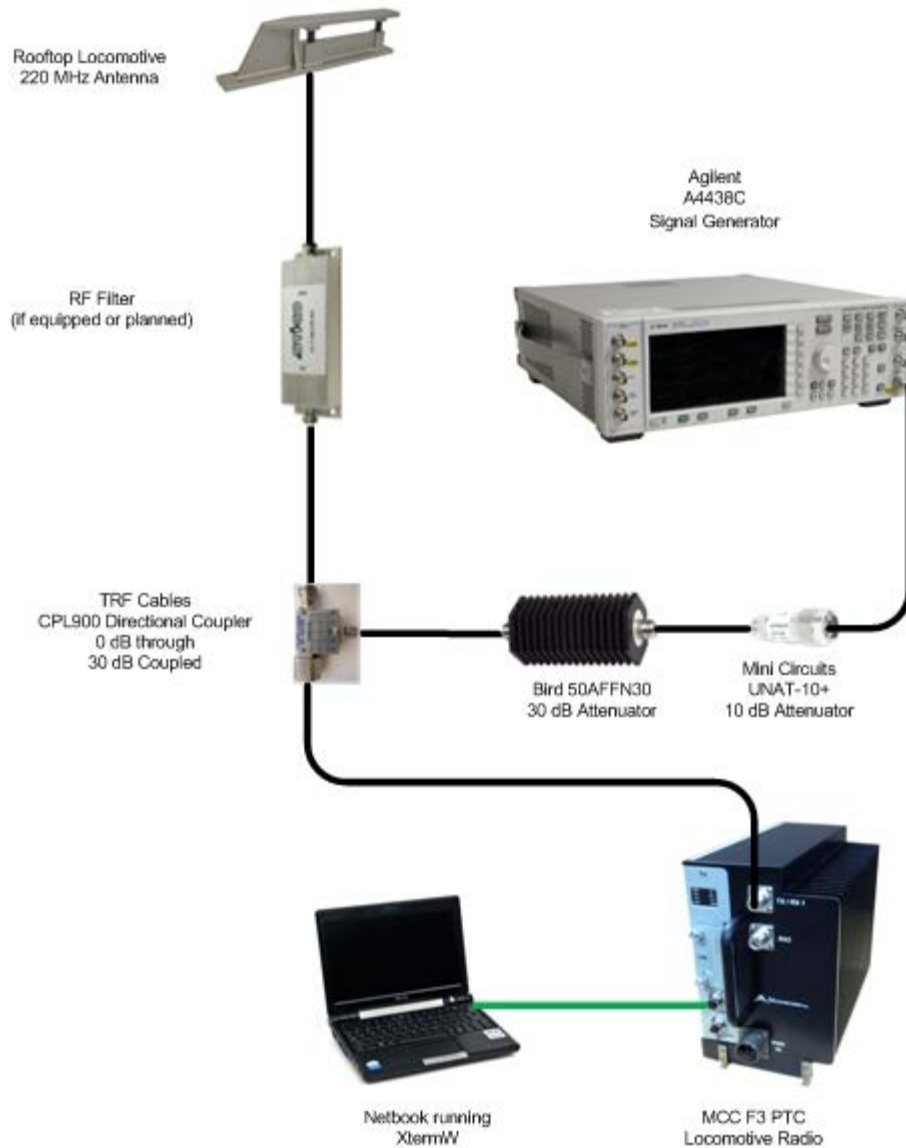

BER Testing Configuration
Figure 38

The PTC Radio's design is based on a Receiver noise floor of -123 dBm, and a C/N ratio (for sustaining a BER of E-4) of 11 dB, and a C/I (for sustaining a BER of E-4) of 14 dB.

To establish a baseline, the PTC Antenna was disconnected from the Directional Coupler port, and the port was terminated. This effectively isolated the radio from the noise environment. The Signal Generator was configured to send a Test Pattern, and the signal level was set so that a BER of E-4 was sustainable. In this configuration, the PTC Radio was able to report a BER of E-4 at -113 dBm. Note that this radio, under these test conditions, was performing slightly better than spec with a C/N of 10 dB.

The PTC Antenna was then reconnected, and the test was repeated for each of ten Locomotive Operational States (Engine Off, Idle, and Notches 1 through 8). The limitations of the test do not permit reliable BER measurements for brief conditions such as Startup Sequence and Shutdown Sequence, so these two locomotive operational states were not tested.

The worse-case level observed for a reliable BER of E-4 was -103 dBm.

The following table shows the observed minimum signal levels required to sustain a BER of E-4 for the Baseline, and for the ten Locomotive Operational States.

TABLE E BER Test Results

Locomotive State	BER E-4 Level
Radio Isolated	-113
Off	-105
Idle	-104
Notch 1	-104
Notch 2	-103
Notch 3	-103
Notch 4	-103
Notch 5	-103
Notch 6	-103
Notch 7	-103
Notch 8	-103

Summary:

SWR Testing:

The VSWR performance for most of the antenna elements was as expected. Adding the cable to the system provides for more insertion loss, which effectively improved the SWR as depicted in the plots on pages 9 thru 12. VSWR performance also appears acceptable when the antennas were used in conjunction with the filter, indicating that the systems in their entirety were functioning properly.

Insertion Loss Testing:

Save for the WIFI systems, the insertion loss data indicates that a nominal level (around 1-1.5 dB) is introduced into each system by the cable. The level of insertion loss measured is compatible with the expected performance of the coaxial cable. As depicted in the WIFI plots, a considerable level of insertion loss was introduced to the system by the coaxial cable.

Antenna Isolation testing:

Ideally, with the goal of a noise and an IMP free system, the isolation between the elements would be as great as possible. A substantially greater amount of isolation between the off-band elements was noted when the filters were in place, providing a strong case for the use of filters. Without the filters in place, the level of isolation detected was as expected considering the distance between the elements, the resonance of the elements, and various obstructions and pattern distorters (reflectors) present on the locomotive roof. Filtering of all significant contributor radios is emphatically recommended. Significant contributor radios include AAR VHF Voice, Distributed Power UHF A, Distributed Power UHF B, HOT, and both branches of the PTC 220 Radio. Additional Testing with the OEM of the MBS-2 (Matrix) is recommended to test interference to, and survivability of, the PTC GPS Antennas and integrated LNAs.

Receive Intermodulation Testing:

There are clearly some limitations in both designs of the HOT/EOT Radios. While the actual mechanism is not clear, both of the radio designs permit significant Intermodulation products to be reradiated in the 220 MHz band. The problem is corrected with appropriate filtering. In fact, filtering of all significant contributor radios is emphatically recommended.

Transmit Intermodulation Testing:

Significant Intermodulation Products were generated by off-platform FM Broadcast signals mixing in the Power Amplifier stage of the AAR VHF Voice Radio. Mitigation will require deep FM Broadcast Rejection (notch filtering), probably on the order of 70 dB. More aggressive and controlled testing is recommended. Filtering of all significant contributor radios is emphatically recommended.

EMI testing:

Electromechanically generated power plant noise during the twelve Locomotive Operational States (Engine Off, Startup Sequence, Idle, Notches 1 through 8, and Shutdown Sequence) were less disruptive than expected, except for the Startup Sequence and the Shutdown Sequence. Additional EMI sources requiring mitigation, such as the Autostart Warning Bell, and the onboard switching power supplies for Cab Signal, have been discovered and should be tested with the Locomotive OEM for mitigation efforts.

BER Testing:

Since the EMI Noise is an on-platform phenomenon, any EMI produced travels with the PTC Radio Receivers. The testing, to date, has established a worse case noise number of 10 dB, and this should be accounted for in the PTC Locomotive Radio Receive Path Link Budget.