

Technical Monograph: Transportation Planning for the Richmond–Charlotte Railroad Corridor

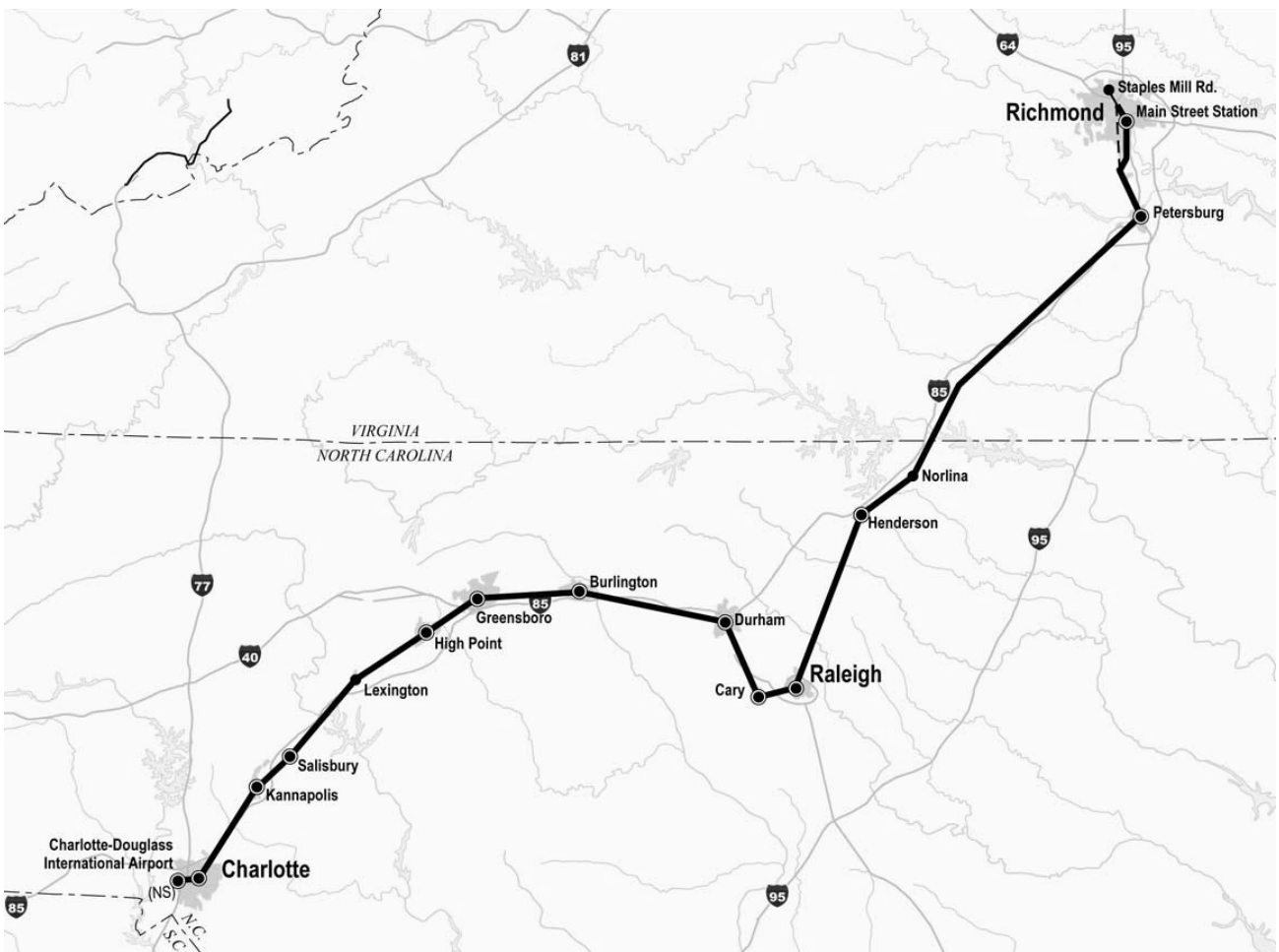

Federal Railroad Administration
United States Department of Transportation
January 2004

Disclaimer: This document is disseminated under the sponsorship of the Department of Transportation solely in the interest of information exchange. The United States Government assumes no liability for the contents or use thereof, nor does it express any opinion whatsoever on the merit or desirability of the project(s) described herein. The United States Government does not endorse products or manufacturers. Any trade or manufacturers' names appear herein solely because they are considered essential to the object of this report.

Note: In an effort to better inform the public, this document contains references to a number of Internet web sites. Web site locations change rapidly and, while every effort has been made to verify the accuracy of these references as of the date of publication, the references may prove to be invalid in the future. Should an FRA document prove difficult to find, readers should access the FRA web site (www.fra.dot.gov) and search by the document's title or subject.

1. Report No. FRA/RDV-04/02	2. Government Accession No.	3. Recipient's Catalog No.	
4. Title and Subtitle Technical Monograph: Transportation Planning for the Richmond–Charlotte Railroad Corridor—Volume II		5. Report Date January 2004	
7. Authors: For the engineering contractor: Michael C. Holowaty, Project Manager For the sponsoring agency: Richard U. Cogswell and Neil E. Moyer		6. Performing Organization Code	
9. Performing Organization Name and Address Engineering Contractor: Parsons Transportation Group Sponsoring Agency (see below)		8. Performing Organization Report No.	
12. Sponsoring Agency Name and Address U.S. Department of Transportation Federal Railroad Administration Office of Railroad Development 1120 Vermont Avenue N.W., Mail Stop 20 Washington, DC 20590		10. Work Unit No. (TRAIS)	
		11. Contract or Grant No. DTFR53-98-D-00004	
		13. Type of Report or Period Covered Technical monograph on transportation planning	
		14. Sponsoring Agency Code See (1) Report No.	
15. Supplemental Notes			
16. Abstract Should the States of North Carolina and Virginia desire to upgrade the railroad corridor between Richmond and Charlotte for improved passenger service that meets a specific travel time goal, a number of infrastructure improvements would be needed. This monograph enumerates, describes, and costs a set of improvements that could, in combination, support a trip time goal of 4 hours, 25 minutes between Richmond and Charlotte. The operational implications of such a service are discussed. As the corridor contains a variety of operating conditions, this monograph may be of technical assistance to other States that are contemplating similar rail passenger service projects.			
17. Key Words Railroad corridors, transportation planning, rail passenger service, high-speed rail, Southeast Corridor		18. Distribution Statement This document is freely available through the FRA's web site, www.fra.dot.gov . A limited printing will be available from the Sponsoring Agency at the address shown.	
19. Security Classification (of the report) Unclassified	20. Security Classification (of this page) Unclassified	21. No of Pages Vol. I: 165 Vol. II: 251	22. Price See (18) Distribution Statement

Contents of Volume I

Executive Summary

Main Report

Chapter 1: INTRODUCTION

Chapter 2: THE CORRIDOR TODAY

Chapter 3: SERVICE GOALS

Chapter 4: METHODOLOGY AND ANALYSIS OF OPERATIONS

Chapter 5: CORRIDOR-WIDE INVESTMENTS AND DESIGN STANDARDS

Chapter 6: SITE-SPECIFIC IMPROVEMENTS

Chapter 7: COST ESTIMATES AND CONCLUSIONS

Glossary

Supplement: Background Material

Contents of Volume II

Appendixes

Appendix A: Curve Analysis Richmond–Charlotte

Appendix B: Train Performance Calculator Analysis To Support Project Goals

Appendix C: Operations Analysis To Support Project Goals

Appendix D: Track Charts

Appendix E: Ownership and Operating Rights

Appendix F: Projected 2020 Schedules for Intercity Passenger, Freight, and Commuter Trains

Appendix G: Descriptions of Individual Projects

**Technical Monograph:
Transportation Planning
for the Richmond–Charlotte Railroad Corridor**

January 2004

**Appendix A
Curve Analysis Richmond–Charlotte**

**Federal Railroad Administration
United States Department of Transportation**

Appendix A

CURVE ANALYSIS RICHMOND–CHARLOTTE: SPEED ANALYSIS OF CURVES AND CIVIL IMPACTS

Introduction

Recent simulations and analyses of future intercity, commuter, and freight operating requirements have concluded that significant track changes are required to achieve trip time goals, improve the reliability of intercity and commuter operations, increase capacity, and provide improved operating flexibility. Reconfiguring major terminals and interlockings, removing existing crossovers and turnouts, and installing new (mostly higher speed) turnouts and crossovers to implement desired alignment and configuration changes would satisfy these needs. Revised interlocking layouts also would be required to optimize train operations entering and leaving the additional tracks, and passing sidings that also have been recommended. The number of interlockings that would be modified and the new interlockings that are recommended are significant. Details of recommended programs are contained in the body of the report. The proposed track configurations are illustrated in Appendix D. The interlocking changes that have been recommended are summarized in the body of the report.

Track curvature imposes the most severe constraint on trip time. Consequently, realigning or changing the physical characteristics of existing curves is a primary means of reducing trip times included in this program. Several types of fixed-plant improvements can minimize the constraints to speed associated with curves:

- Increasing superelevation to the maximum allowable for a particular track alignment;
- Changing horizontal and vertical alignment, either within the existing right-of-way, or by acquiring land outside the existing right-of-way;
- Increasing the amount of unbalanced superelevation used to calculate speeds through curves to minimize track shifts; and
- Modifying spirals (the length of track that provides a smooth transition from level, tangent track to curved, superelevated track) by eliminating superelevation runoff onto the adjacent tangent sections.

The rationale for the realignments recommended in this program is summarized in this appendix.

Objective

The results of a speed analysis of curves, and the civil impacts associated with realigning them between Richmond and Charlotte¹ are described in this report. The results of those analyses are summarized in the following subsection.

The goal of the Plan is to reduce the trip time between Richmond and Charlotte to 4 hours 20 minutes. There are several changes to the methods of operation, to the facilities, and to the equipment that can contribute to the overall goal.

One of these changes is to increase the speed of the trains. Increasing the speed may require one or all of the following:

- More powerful or additional locomotives;
- Coaches that can provide comfort at greater unbalanced speeds - tilt vehicles would be needed for operation at unbalanced superelevation greater than 5 inches;
- Tracks and track beds that can withstand the energies transferred at higher speed (including greater imbalance); and
- Alignments that can accommodate the greater speeds without exceeding acceptable limits for:
 - Actual superelevation,
 - Unbalanced superelevation,
 - Lateral acceleration to the passenger
 - Spiral lengths limited by:
 - . Rate of change of change of actual superelevation or twist,
 - . Rate of change of change of lateral acceleration to the passenger or jerk.

The objective of this analysis was to propose realignments to the existing curves so that proposed speeds can be reached and to identify civil impacts caused by the proposed realignments. The results of the analysis were used to develop a project estimate for realigning curves. The methodology employed to perform the analysis and the results of the analysis are presented in this subsection.

Criteria And Scope

Criteria

The criteria utilized in the performance of this analysis were as follows.

- Maximum actual superelevation should not exceed 6 inches.

¹ The Parsons Transportation Group under contract to the FRA performed the curve analysis.

- Actual superelevation was chosen in increments commensurate with the runoff rates specified by CSX for the segments between Main St. Station and Raleigh and NS for the segments between Raleigh and Charlotte, respectively, and speed.
- Maximum unbalanced superelevation should not exceed 5 inches, which assumes use of non-tilting equipment.
- Maximum lateral acceleration parallel to the floorboards should not exceed 0.15 g.
- For conventional coach equipment at 6 inches of unbalanced superelevation the roll angle should be 2.87 degrees, or less, and lateral acceleration parallel to floorboards should no exceed 0.15 g.
- All actual superelevation should be introduced and removed over the entire length of the spiral; actual superelevation should not be introduced and removed on the adjacent tangents.
- Maximum jerk rate through the spiral should not exceed 0.04 g per sec.
- Track twist rates for alignments at proposed speeds specified by CSXT and NS:

CSX – Richmond to Raleigh

- Speeds from 0 to 50 miles per hour, 1/2-inch per 31 feet or 0.01612903 per foot;
- Speeds from 51 to 70 miles per hour, 1/2-inch per 39 feet or 0.01282051 inch per foot; and
- Speeds greater than 71 miles per hour, 1/2-inch per 50 feet or 0.01 inch per foot.

NS/NCRR – Raleigh to Greensboro to Charlotte

- Speeds from 0 to 60-mph, ½-inch per 31-feet or 0.01612903 inch per foot
- Speeds greater than 61-mph, 3/8-inch per 31-feet or 0.01209677 inch per foot

Scope

The curves to be considered in the analysis were those located between Main Street Station and Charlotte. Studies recently performed for NCDOT proposed maximum speeds for individual curves. These speeds were used as initial speed goals, but were modified as necessary to reflect the iterative analysis process subsequently defined. Maximum speed varied by segment of the corridor:

- Main Street Station to Centralia - 79 mph; and
- Centralia to Charlotte 110 mph.

Presently maximum speed for passenger trains in the corridor is 70 mph (except Centralia to Petersburg which has a 79 mph MAS). Maximum authorized speeds vary by location and are specified in the CSX and NS Employees Timetables. The analysis was based on data taken from a variety of track chart sources between Main Street Station and Raleigh and data obtained from a recent FRA Track Geometry Car Run between Raleigh and Charlotte.

One product of the analysis was the conclusion that, with a limited number of exceptions, each curve on the corridor had to be modified to some degree. For each curve the highest speeds that can be reached without realignment or adjustment to the actual superelevation on each of the existing curves, while satisfying safety and comfort criteria, were initially calculated. An iterative process was then followed to identify the maximum speed attainable (in five mph increments) on each curve. An analysis was then performed to determine changes to superelevation, spiral length, and when necessary degree of curvature for individual curves or groups of curves.

The analysis indicates that the speed improvements can be attained in a limited number of instances by merely surfacing and aligning the track as part of a normal maintenance cycle.

The study identified specific curves that should have their degree of curvature modified to enable speeds to be increased. Curves to be modified ultimately should be selected on the basis of their cost effectiveness - the cost per minute saved as the result of the modification. The analysis would require that Train Performance Calculation (TPC) runs be made to determine the timesavings as the result of each curve modification. The cost of each modification also would have to be estimated, and by dividing the cost by the time for all curve modifications a cost effective listing could be developed, which would assist the planner in evaluating which improvements should be funded.

A second product was the calculation of the highest speeds that can be reached with realignment to improve spiral lengths and with adjustment to the actual superelevation, while satisfying safety and comfort criteria. The result of the analysis was a list of proposed realignments to reach the proposed speeds. In addition to safety and comfort criteria the proposed realignments would comply with standard CSX and NS field maintenance practices. Curves requiring shifts of about 6 inches are shown in Table A-1²³. Curves requiring shifts between 6 inches and 3 feet are shown in Table A-2. Curves requiring shifts in between three- and 10 feet are shown in Table A-3. Curves requiring shifts in excess of ten feet are listed in Table A-4. The curves requiring the largest shifts are located on the S Line between Centralia and Norlina, and would be realigned as part of the service restoration, and on the H Line between Fetner and Greensboro. These realignment/relocations may require further study to verify their practicality and feasibility.

The preliminary analysis performed indicated that several undergrade and overhead bridges, and grade crossings would be impacted by the realignments and would have to be modified or rebuilt. Actual bridge impacts would need to be confirmed on a bridge-by-bridge basis. Where undergrade bridges are not located within the body of the curve and the shifts are less than 6 inches, the realignments can be performed with regular maintenance procedures, and would not result in significant additional civil costs. Curves that have turnouts to industrial spurs within their length have been preliminarily identified, but the list would need to be finalized, since turnouts would limit the actual superelevation and the speed in the curve. In these cases the realignment would be more significant resulting in increased costs.

² Curves whose throw would be less than 0.1 feet are not listed.

³ Compound curves are not listed in the table; the analyzer methodology, subsequently discussed does not address compound curves. The compound curves, for the most part, are addressed in the manual analysis subsection.

The analysis technique (a spreadsheet) made it easier to answer "what-if?" questions, such as, how much would the proposed speed be reduced if speed and consequently the realignment shift was reduced so as not to impact bridge B? Or, how much additional shift would be required to increase the proposed speed on curve A?

The analysis technique resulted in an estimate that is considered accurate to plus and minus 0.1-foot for simple spiraled curves, provided that the radius (degree of curvature) was not changed or the spirals were not changed by a significantly unequal amount. For compound curves the iterative analysis technique is not reliable. For these more challenging realignments manual analyses were performed to determine the shifts. These analyses are discussed in a subsequent section of this Appendix.

Table A-1										
SHIFTS BETWEEN 0 AND 0.5 FEET										
S-LINE										
Cve No	Curve Degree	Radius Feet	North Spiral	South Spiral	Avg Ea Exist	Proposed Speed	Avg Ea Prop	Delta Ea	Optimal Ls	Expected Max Shift
10.10	1.75	3,274	117	117	1.5	75	1.5	-	190	0.28
10.20	3.50	1,637	93	93	1.5	55	1.5	-	153	0.37
14.00	0.75	7,640	150	150	1.5	110	1.5	-	251	0.22
23.00	2.00	2,865	429	429	5.5	90	4.5	(1.0)	450	0.27
44.10	1.00	5,730	200	200	1.5	100	2.0	0.5	235	0.11
49.00	1.00	5,730	200	200	1.0	100	2.0	1.0	235	0.11
90.00	1.50	3,820	213	213	5.0	85	1.0	(4.0)	263	0.26
91.00	1.50	3,820	213	213	5.0	85	1.0	(4.0)	263	0.26
113.00	1.00	5,730	62	62	1.0	90	1.0	-	197	0.26
125.20	0.50	11,459	93	93	1.5	110	0.5	(1.0)	193	0.10
125.30	0.50	11,459	93	93	1.5	110	0.5	(1.0)	193	0.10
135.00	1.12	5,131	300	300	3.0	110	3.0	-	333	0.17
141.00	1.50	3,820	273	273	3.5	100	3.5	-	350	0.25
150.10	0.75	7,640	200	200	2.0	110	0.5	(1.5)	302	0.28
151.00	0.83	6,876	200	200	2.0	110	0.5	(1.5)	339	0.45
154.10	2.00	2,865	124	124	2.0	70	2.0	-	160	0.15
155.10	0.62	9,291	31	31	-	110	0.5	0.5	244	0.26
H Line										
none										
Piedmont Line										
297.00	2.00	2,865	368	354	3.5	90	4.5	1.0	372	0.19
314.10	2.00	2,865	310	266	4.5	85	3.3	(1.3)	274	0.31
328.00	1.70	3,370	221	310	2.5	90	2.8	0.3	291	0.47
343.00	2.00	2,865	350	354	3.5	90	4.5	1.0	372	0.25
366.00	2.00	2,865	368	381	4.5	90	4.5	-	372	0.10
367.10	2.00	2,865	412	407	4.5	90	4.5	-	407	0.06

Table A-2										
SHIFTS BETWEEN 0.5 and 3 FEET										
Cve No	Curve Degree	Radius Feet	North Spiral	South Spiral	Avg Ea Exist	Proposed Speed	Avg Ea Prop	Delta Ea	Optimal Ls	Expected Max Shift
S-LINE										
2.10	2.00	2,865	117	117	1.5	79	2.0	0.5	250	0.71
6.10	2.00	2,865	117	117	1.5	79	2.0	0.5	250	0.71
6.20	2.00	2,865	117	117	1.5	79	2.0	0.5	250	0.71
7.10	2.00	2,865	117	117	1.5	79	2.0	0.5	250	0.71
7.20	2.00	2,865	117	117	1.5	79	2.0	0.5	250	0.71
8.10	2.00	2,865	117	117	1.5	79	2.0	0.5	250	0.71
10.00	2.00	2,865	117	117	1.5	79	2.0	0.5	250	0.71
10.20	3.50	1,637	93	93	1.5	60	2.0	0.5	192	0.72
15.00	1.00	5,730	200	200	2.0	110	2.0	-	334	0.52
19.00	1.75	3,274	500	500	5.0	100	5.5	0.5	550	0.67
32.00	1.00	5,730	200	200	1.5	110	2.0	0.5	334	0.52
32.10	1.50	3,820	400	400	4.0	110	6.0	2.0	600	2.18
34.00	1.50	3,820	400	400	3.5	110	6.0	2.5	600	2.18
36.00	1.50	3,820	400	400	4.0	110	6.0	2.0	600	2.18
40.00	1.00	5,730	200	200	1.5	110	2.0	0.5	334	0.52
42.00	1.08	5,289	200	200	2.0	110	2.5	0.5	345	0.62
44.00	1.75	3,274	500	500	5.0	100	5.5	0.5	550	0.67
59.00	2.00	2,865	390	390	4.5	90	4.5	-	450	0.73
76.00	1.00	5,730	200	200	1.0	110	2.0	1.0	334	0.52
78.00	1.00	5,730	117	117	0.5	110	1.5	1.0	360	0.84
78.10	1.50	3,820	93	-	0.5	105	5.0	4.5	500	2.73
80.10	2.00	2,865	234	234	3.0	90	4.5	1.5	450	2.15
81.00	1.50	3,820	156	156	1.5	90	2.0	0.5	275	0.56
89.00	1.50	3,820	351	351	4.5	85	4.5	-	450	0.86
93.00	1.00	5,730	200	200	1.0	110	1.5	0.5	360	0.65
96.00	1.00	5,730	150	150	0.5	110	1.5	1.0	360	0.78
102.00	1.50	3,820	550	550	5.5	110	6.0	0.5	600	0.77
108.10	2.10	2,728	600	600	6.0	90	5.0	(1.0)	600	2.66
110.00	2.13	2,686	351	351	4.5	90	5.5	1.0	550	2.78
111.00	2.00	2,865	273	273	3.5	90	4.5	1.0	450	1.86
123.00	1.50	3,820	450	450	4.5	110	6.0	1.5	600	1.72
126.20	2.13	2,686	400	400	4.0	90	5.5	1.5	550	2.21
131.00	2.00	2,865	273	273	3.5	90	4.5	1.0	450	1.86
132.00	2.00	2,865	273	273	3.5	90	4.5	1.0	450	1.86
134.00	1.12	5,131	250	250	2.5	110	2.5	-	359	0.54
137.00	2.25	2,547	429	429	5.5	90	6.0	0.5	600	2.88
138.00	1.08	5,289	195	195	2.5	110	2.5	-	345	0.64
139.00	1.08	5,289	195	195	2.5	110	2.5	-	345	0.64
139.10	1.50	3,820	312	312	4.0	110	5.0	1.0	500	1.66
140.10	3.12	1,838	155	155	2.5	70	4.0	1.5	312	1.66
143.00	1.50	3,820	429	429	5.5	105	5.0	(0.5)	500	1.29
144.00	1.53	3,745			3.5	110	6.0	2.5	600	2.92
145.00	1.53	3,745			6.0	110	6.0	-	600	0.91
146.20	1.80	3,183	468	468	6.0	90	3.5	(2.5)	468	2.31
146.30	1.80	3,183	468	468	6.0	90	3.5	(2.5)	468	2.31
148.00	2.13	2,686	390	390	5.0	90	5.5	0.5	550	2.33
148.10	2.13	2,686	390	390	5.0	90	5.5	0.5	550	2.33
149.00	1.12	5,131	250	250	2.5	110	2.5	-	359	0.54
150.00	1.50	3,820	350	350	3.5	110	6.0	2.5	600	2.59
151.10	1.75	3,274	400	400	4.0	100	5.5	1.5	550	1.81
153.00	2.50	2,292	429	429	5.5	80	5.5	-	550	2.15
155.00	2.12	2,707	31	31	0.5	70	0.5	-	222	0.74

Table A-2 (continued)										
SHIFTS BETWEEN 0.5 and 3 FEET										
Cve No	Curve Degree	Radius Feet	North Spiral	South Spiral	Avg Ea Exist	Proposed Speed	Avg Ea Prop	Delta Ea	Optimal Ls	Expected Max Shift
H Line										
24.00	3.00	1,910	310	492	3.5	75	5.0	1.5	413	1.73
25.00	3.00	1,910	492	252	3.5	75	5.0	1.5	413	2.58
25.10	3.00	1,910	292	190	3.5	75	5.0	1.5	413	2.94
26.10	3.00	1,910	275	232	3.5	75	5.0	1.5	413	2.60
42.10	3.00	1,910	288	248	3.5	75	5.0	1.5	413	2.56
43.10	3.00	1,910	248	310	3.5	75	5.0	1.5	413	2.58
48.10	2.00	2,865	257	261	2.0	95	6.0	4.0	496	2.80
62.00	2.00	2,865	279	283	1.0	90	4.5	3.5	372	0.89
63.00	2.00	2,865	261	288	2.0	90	4.5	2.5	372	1.06
63.10	2.00	2,865	270	164	2.0	90	4.5	2.5	372	1.64
63.20	2.00	2,865	270	261	2.0	90	4.5	2.5	372	1.05
65.00	2.00	2,865	239	283	2.0	90	4.5	2.5	372	1.21
66.00	2.00	2,865	217	230	2.0	90	4.5	2.5	372	1.36
67.00	2.00	2,865	230	324	2.0	90	4.5	2.5	372	1.28
68.00	2.00	2,865	323	270	2.0	90	4.5	2.5	372	0.96
73.00	2.00	2,865	443	332	4.0	90	4.5	0.5	372	0.84
75.00	2.00	2,865	297	381	4.0	90	4.5	0.5	372	0.78
Piedmont Main Line										
296.00	2.00	2,502	314	328	5.0	90	6.0	1.0	496	2.96
289.00	2.00	2,865	350	416	3.5	90	4.5	1.0	372	0.50
293.00	2.00	2,865	314	328	3.5	90	4.5	1.0	372	0.59
293.10	2.00	2,865	372	319	3.5	90	4.5	1.0	372	0.54
294.00	2.00	2,865	252	252	2.5	90	4.5	2.0	372	1.13
295.00	2.00	2,865	248	345	2.5	90	4.5	2.0	372	1.13
311.00	2.00	2,865	252	372	4.5	90	4.5	-	372	1.09
313.10	2.00	2,865	301	407	4.5	90	4.5	-	372	0.69
322.00	2.00	2,865	332	182	2.5	90	4.5	2.0	372	1.53
342.00	2.00	2,865	332	275	3.5	90	4.5	1.0	372	0.91
343.10	2.00	2,865	261	283	3.5	90	4.5	1.0	372	1.02
345.00	2.00	2,865	328	297	3.5	90	4.5	1.0	372	0.73
347.00	2.00	2,865	416	345	3.5	90	4.5	1.0	372	0.50
354.00	2.00	2,865	266	297	3.5	90	4.5	1.0	372	0.98
358.10	2.80	2,046	235	257	4.5	75	4.5	-	372	1.69
360.00	2.00	2,865	319	416	4.5	90	4.5	-	372	0.53
360.10	2.00	2,865	252	345	4.5	90	4.5	-	372	1.09
361.00	2.00	2,865	297	328	4.5	90	4.5	-	372	0.73
363.00	2.00	2,865	363	416	4.5	90	4.5	-	372	0.50

Table A-3										
SHIFTS BETWEEN 3 AND 10 FEET										
Cve No	Curve Degree	Radius Feet	North Spiral	South Spiral	Avg Ea Exist	Proposed Speed	Avg Ea Prop	Delta Ea	Optimal Ls	Expected Max Shift
S-LINE										
12.00	3.00	1,910	468	468	6.0	75	6.0	-	600	3.07
129.10	2.00	2,865	500	-	5.0	75	5.0	-	500	3.64
156.00	6.00	955	93	93	-	55	6.0	6.0	468	9.16
156.10	6.00	955	93	93	-	55	6.0	6.0	468	9.16
157.00	10.00	573	62	62	-	40	4.5	4.5	279	5.37
H Line										
26.00	3.30	1,736	190	190	3.5	75	6.0	2.5	496	7.39
36.10	1.85	3,097	199	213	2.0	100	6.0	4.0	496	7.25
39.10	4.00	1,432	283	354	3.5	65	5.0	1.5	413	3.05
44.00	1.85	3,097	226	133	2.0	100	6.0	4.0	496	3.81
54.00	2.90	1,976	257	266	3.5	80	6.0	2.5	496	4.69
56.00	1.53	3,745	213	190	2.0	110	6.0	4.0	496	6.59
Piedmont Main Line										
None										

Table A-4										
SHIFTS GREATER 10 FEET										
Cve No	Curve Degree	Radius Feet	North Spiral	South Spiral	Avg Ea Exist	Proposed Speed	Avg Ea Prop	Delta Ea	Optimal Ls	Expected Max Shift
S-LINE										
None										
H-LINE SHIFTS GREATER 10 FEET										
42.00	3.50	1,736	211	261	3.5	75	6.0	2.5	496	16.82
47.00	1.85	3,097	288	279	3.5	100	6.0	2.5	496	22.90
48.00	2.05	2,795	314	230	3.5	95	6.0	2.5	496	175.96
64.00	2.29	2,502	301	328	3.5	90	6.0	2.5	496	75.03
PIEDMONT SHIFTS GREATER 10 FEET										
None										

Methodology

Soft Realignments

There are two types of alignment changes: soft and hard. Soft alignment changes are changes in unbalanced superelevation, lateral acceleration to the passenger, and jerk that do not require physical changes. Therefore, there would be no cost associated with obtaining desired the speeds. These realignments would assume that the existing track twist (rate of introduction of superelevation) is acceptable. However, the present analysis did not identify any soft realignments between Richmond and Charlotte.

Hard Realignments

Hard alignment changes are changes to actual superelevation, degree of curvature, and/or spiral lengths. Hard changes result in a physical change to the track, and when certain thresholds are reached, hard changes would impact adjacent or supporting facilities, such as, overhead bridges, undergrade bridges, signal towers, station platforms, etc.

Actual Superelevation on Tangent, Maximum Twist, etc.

To meet comfort standards it was not considered acceptable to extend actual superelevation or track twist on to the tangents. Introduction and removal of actual superelevation should be linear, and should occur over the length of the spiral. As curve improvements are implemented occurrences of superelevation on tangents should be eliminated.

Shifts and Impacts

Right of way is generally not considered a factor unless the shift is very large and in those cases right of way would have been considered separately. Only a few of the shifts identified in this study were considered sufficient to require right-of-way acquisition; a cost for real estate acquisition has been included in those rare instances. In general, the impacts of track shifts on overhead or undergrade bridges, and grade crossings are of greatest concern.

Although each bridge located on the body of a curve ultimately would have to be individually evaluated to determine the impact of the assumed track shift, for these analyses it was generally assumed that if a specific shift exceeded the followings limits, the bridge would be impacted:

- Open deck bridges with no additional improvement work proposed--any shift or change in superelevation;
- Open deck bridges with through girders, or through deck girders scheduled for tie replacement--6 inches;
- Open deck bridges with deck girders scheduled for tie replacement--1-foot;
- Open deck bridges scheduled for conversion to ballasted deck--2 feet;
- Ballasted bridges--2 feet; and
- Overhead bridges--3 feet.

Bridges requiring replacement should be designed to accommodate the proposed alignment changes.

It also has been assumed that realignments that require shifts of 6 inches, and less, would be accomplished through regular maintenance practices and procedures. If the shift exceeds 6 inches, the track shifting cannot be done as part of maintenance and would require an independently scheduled effort.

Analysis Guidelines, Assumptions and Techniques

The analysis process utilized to analyze speeds and curves, and evaluate impacts on structures is subsequently described. The following are the guidelines, assumptions, and techniques for doing the analysis.

Degree of Curvature, Radius

The radius and degree of curvature were changed on a selective basis to ensure that reliable intercity passenger trip times between Richmond and Charlotte would be obtained.

Actual Superelevation

Superelevation on curves to be modified was assumed to be implemented in increments in accordance with the way superelevation is introduced in the spiral by railroad maintenance personnel.

Unbalanced Superelevation

Unbalanced superelevation was computed from the following equation.

$$E_u = 0.0007 * D_c * V^2 - E_a$$

Where E_u is unbalanced superelevation in inches

E_a is actual superelevation in inches

D_c is degree of curvature in decimal degrees

V is speed in miles per hour.

In accordance with previous agreed assumptions, unbalanced superelevation was limited to a maximum of 5 inches.

Lateral Acceleration Parallel to the Vehicle's Floor boards

When unbalanced superelevation occurs, passengers are subjected to a steady state lateral acceleration. This acceleration is the component of centripetal acceleration that is parallel to the floorboards of the vehicle. The calculation for this component takes into account the floorboard rotation due to actual superelevation and the roll of the car body as its suspension responds to the centripetal lateral acceleration. The lateral acceleration is computed from the following equation.

$$A_L = \{[(E_a + E_u) / G * \text{COS} (\text{THETA} - \text{PHI} * E_u / 6)] - \text{SIN} (\text{THETA} - \text{PHI} * E_u / 6)\} * g$$

Where, A_L is lateral acceleration parallel to floorboards in g

THETA is the angle due to the actual superelevation = $\text{ARCSIN} (E_a / G)$

G = distance between rail head centers = 60 inches

PHI is the vehicle roll angle per 6 inches of unbalanced superelevation = 2.87 degrees per 6 inches of E_u .

The PHI value of 2.87 was derived from conventional coach data provided on page 21 of the report for the FRA entitled *Railroad Passenger Ride Safety*, revised April 1989. Conventional non-tilting equipment has to be considered since either tilting or non-tilting equipment ultimately may be used. The tests reported indicated that both the LRC Coach (tilt capability cut out) and the Amfleet Coach reached 0.15 g of steady state lateral acceleration at 6 inches of unbalanced superelevation. By substituting these values into the above equation a PHI value of 2.87 is found calculated all values of actual superelevation up to 6 inches.

For prior projects, review of previous research and consultation with the FRA lead to the recommendation that 0.15 g should be the lateral acceleration limit. This analyses performed assumed that 0.15 g to be the lateral acceleration limit. Vehicle test data indicates that 0.15 g would be reached at 6 inches of unbalanced superelevation; therefore as long as unbalanced superelevation is limited to 5 inches, the lateral acceleration limit of 0.15 g would not be exceeded.

The PHI value is based upon available data for conventional non-tilting equipment. It is unlikely that new, non-tilting equipment would have a larger PHI coefficient, however, it might have a smaller value. A smaller PHI value would result in smaller lateral accelerations (good for passenger comfort) and in shorter comfort spiral lengths that would be based on a maximum jerk rate (jerk rate and comfort spiral are discussed in the following subsection). Consequently, spirals established based on the PHI value of 2.87 would be longer than necessary if the new non-tilting equipment has a smaller PHI. Therefore, the construction impacts resulting from shifts determined by the PHI value established for this report would be conservative.

The Comfort Spiral, Jerk, and Jolt

The comfort spiral transitions the passenger through a change in lateral acceleration (unbalanced superelevation) at a comfortable rate. Assuming that a vehicle's speed is constant while traversing a spiral, unbalanced superelevation (lateral acceleration) changes linearly as the passenger travels along the spiral. This is because: degree of curvature changes linearly along a spiral; actual superelevation is introduced linearly along the spiral; and vehicle roll is linearly related to lateral acceleration. The change in lateral acceleration is referred to as jerk, with units of g per sec.

The jerk is computed by dividing the change in lateral acceleration (which is found by using the above equation and the change in unbalanced superelevation) by the time it takes for the passenger to travel over the spiral. The time is found by dividing the spiral length by the vehicle speed, with appropriate adjustments for units.

After a jerk rate has been established for a project, dividing the change in lateral acceleration by the jerk rate, and multiplying the quotient by the vehicle speed can compute the minimum comfort spiral length:

$$L_s = A_L / J * V = A_L / 0.04 * 88 / 60 * V = 36.67 * A_L * V$$

Where, L_s is minimum comfort spiral length in feet

J is maximum jerk rate in g per sec

A_L is found from the earlier equation as a function of unbalanced superelevation.

AREMA recommends 0.03 g per sec as a maximum jerk rate, when conditions permit. But where the cost of the realignment of existing tracks would be excessive the AREMA recommends that the jerk rate should not exceed 0.04 g per sec. For this analysis a jerk rate of 0.04 g per sec for non-tilt train equipment was assumed.

The *Railroad Passenger Ride Safety* report, cited above, lists the lateral acceleration and jerk limits for several railroads. Jerk limits range from 0.03 to 0.1 g per sec. It is generally true that when a railroad accepts a higher jerk rate, it accepts a lower lateral acceleration. This is consistent with the observation reported in the same report that people are able to tolerate larger jolts when they are in a lower steady state lateral acceleration environment.

A jolt is also a rate of change of lateral acceleration per second, but it is considered as an occurrence that occurs in 1 second. A jolt is usually a response to a track irregularity. When jolts exceed 0.25 g per sec it is usually a sign that, for that speed, the track needs adjustment. The jerk through a spiral usually occurs over several seconds and, therefore, is not considered a jolt.

Usually back and forth car body rolling occurs when a track irregularity is encountered. The magnitude of the jolt increases as the relative rolling motion of the car body increases. When the jolt is measured as a lateral acceleration parallel to the floorboards, the position of the accelerometer affects the magnitude of the reading. In a double deck car, for the same track irregularity, a passenger on the lower level near the roll center of the car body would feel a smaller jolt than a passenger on the upper level.

The *Railroad Passenger Ride Safety* report also indicates that the researchers did not find any evidence that jerk is a comfort concern. This suggests that the comfort spiral could be shortened until the jerk is 0.25 g per sec. The problem with this approach is that the track has to be maintained in perfect condition. Any track irregularity would result in a total change in lateral acceleration that exceeds 0.25 g per sec.

The French National Railways (SNCF) was found to have the highest limits, 0.15 g and 0.10 g per sec. Since comfort is a subjective feeling of the passenger, the SNCF may be recognizing that the French have a higher threshold to discomfort, or that they may be willing to tolerate a higher percentage of the passengers to be uncomfortable. Or, and perhaps more likely, SNCF has made a commitment to high quality track with tight maintenance tolerances for their high-speed lines. (The British and American comfort criteria were established at comfort limits where 50 percent of the passengers would be satisfied. The Japanese desire to have 90 percent of the passengers satisfied.)

Track Twist

If the track twist, the rate of introduction or removal of superelevation, is too large, safety is impaired. When computing the maximum allowable speed for the existing alignment, the analysis performed verified that the ratio of the existing spiral length to actual superelevation was equal to, or greater than, 62 for speeds below, and including, 90 miles per hour. For speeds above 90 miles per hour, the ratio would be equal to, or greater than, 83.

When the maximum allowable speed did not reach the proposed speed the spirals were lengthened and the actual superelevation adjusted, as necessary, to maximize the speed. A third alternative, decreasing the degree of curvature and adjusting spiral lengths and superelevation was not utilized in this study. Where these alignment changes were required the spiral lengths were changed to satisfy the appropriate actual superelevation runoff rate assumed for the corridor. The new spirals also were checked for jerk. The actual superelevation was adjusted until the jerk criteria were satisfied.

Track Shifts

For this analysis, shifts between the existing and the proposed alignments were computed at 3 points: near each of the curve spiral points and at the mid-point of the body of the curve. The shifts near the curve spiral points were estimated as the difference between the spiral offsets, the "p" distance, for the proposed and existing spirals. At the mid-point of the curve the difference in the external distances for the proposed and existing alignment were estimated to calculate the amount of shift required.

The estimated shifts were checked for an earlier NEC study by running several dummy cogos using typical alignment curve data, and calculating offsets. A range of intersection angles, radii, spiral lengths, and differential spiral lengths, when the existing spirals are unequal, were tested. For simple, spiral curves it was found that the estimated shifts were within 0.1 feet and that they were usually on the conservative side, i.e., 0.1-foot larger than actual. If the proposed alignment has a different intersection angle or a significantly different radius, the estimated shifts become less accurate.

Compound Curves

Compound curves (a combination of two or more curves connected by transition spirals) added another level of complexity to the analysis. A manual technique utilizing USGS maps was utilized to evaluate the limited number of compound curves in the corridor. The methodology is subsequently discussed.

Basis for Existing Curve Data

As with any analysis, the results of the curve analyses performed were only as good as the quality of the available existing data. The best source of data is good mapping or surveyed data points of the existing tracks. Description of an alignment by degree of curvature is incomplete; it is similar to describing a line by its slope. The description of a curve is not complete until the Y intercept is known. Stringline data and track geometry car data also are not ideal sources of data. The degree of curvature is never uniform, always varying. The result is that data elements assumed to describe the alignment might vary greatly from the actual configuration. The variation cannot be determined without mapping or surveyed data points.

The existing data sources used to develop information for the analyses performed were as follows:

- FRA track geometry car charts;
- Earlier work performed by various consultants for NCDOT; and
- Track charts.

The track charts were used for general orientation, but not to define spiral lengths for the curves between Raleigh and Charlotte for which track geometry data was available. The track charts were the only source available for the lines between Richmond and Raleigh, which presently do not have passenger service. The previous work effort was used for background information only; data on proposed curve speeds and previous recommendations were obtained from the reports developed by those studies.

Data relative to the existing superelevation, spiral lengths, curve lengths, and degree of curvature south of Raleigh were primarily developed from an analysis of a recent FRA Track Geometry Car Charts, which were the result of a round-trip run of the corridor.

Although there were possible inconsistencies in the track geometry car data, it was necessary to use them in most instances. The data was valuable for providing the spiral lengths, which were measured directly from the charts of the individual simple and compound curves.

The track geometry car chart data was reduced as follows. The track geometry produces strip charts with fluttering lines. A visual average was made for the degree of curvature and actual superelevation. If the data was not uniform, the curve was subdivided into a compound curve. The distance between uniform curvature data points was assumed to be spiral lengths. The distance between uniform actual superelevation data was not assumed to have any relationship to spiral length because actual superelevation may have been run off onto the tangents and into circular curves.

It was assumed that second, third tracks, and sidings also would be shifted, as necessary, when either would be the inside track on a curve, and thus need to be shifted to maintain adequate clearance to the shifted inner tracks. The costs for this effort were included in the project estimate, but it was assumed that the magnitude of shifts and, therefore, impacts on adjacent right-of-way structures would be driven by the changes required to the high-speed tracks.

For each curve, the existing data from each source was tabulated. The source data was compared, curve-by-curve, and data type by data type. Finally, one set of existing data for each curve was selected and compiled. The compiled data is the most conservative.

Speeds

The existing speeds were taken from the existing CSX and NS Employees Timetables. The proposed speeds were initially taken from the speeds proposed in earlier NCDOT studies. Proposed speeds have been established in multiples of 5 miles per hour.

When determining the maximum allowable speed within the criteria the speed is shown to the nearest downward five miles per hour.

The Alignment Analyzer Spreadsheet

To facilitate the analysis a spreadsheet was developed that allows for the existing speed, degree of curvature, spiral and curve lengths, and superelevation to be input. The input was utilized to perform a variety of calculations. The spreadsheet determined the maximum speed obtainable given the existing alignment and actual superelevation, by only making soft changes, i.e., only changes to speed, unbalanced superelevation, and jerk. For this initial analysis no change to curvature, spiral lengths, and actual superelevation were made. In general it was assumed that the proposed curvature would remain unchanged.

For those instances when superelevation and spiral length changes were analyzed, the spreadsheet was used to determine the shifts associated with changes in actual superelevation and spiral lengths that would satisfy railroad and comfort criteria, and attain the proposed speeds. For the proposed alignment only the proposed speed and actual superelevation had to be input. Unbalanced superelevation, optimal spiral lengths, and shifts were computed. "What if" questions about speeds were asked, and answered, by using different proposed speeds and superelevation for input. Limitations concerning the shift calculations were discussed earlier.

The impact of the proposed shifts on each bridge was evaluated. The criteria used to evaluate the effect of the proposed shifts on bridges included:

- Open deck bridges with no planned work-any shift or change in superelevation;

- Open deck bridges with through girders or through deck girders scheduled for tie replacement--6 inches;
- Open deck bridges with deck girders scheduled for tie replacement--1-foot;
- Open deck bridges scheduled for change to ballast--2 feet;
- Ballasted bridges--2 feet; and
- Overhead bridges--3 feet.

A list all of the curves that required alignment changes to achieve the proposed or optimal speed was developed. It included: proposed speeds, curves requiring 6 inches or less of shift, curves requiring between 6 inches and 3 feet of shift, and curves requiring more than 3 feet of shift.

ALIGNMENT ANALYSIS

Purpose

An Alignment Analyzer consisting of an integrated set of Excel spreadsheet macros was used to perform an analysis of superelevation and velocity alterations to each curve comprising an existing alignment. The Alignment Analyzer is an automated, iterative analysis that optimizes speed, curvature, spiral length, and superelevation for a given alignment. An Excel Workbook for each rail line, or segment of a rail line, utilizes the Excel spreadsheet macros to calculate critical curve data based on assumptions relative to:

- Curve design criteria;
- Unbalanced superelevation;
- Maximum Authorized Speed (MAS); and
- Criteria of the owner of the rail line.

Workbook Organization

Each workbook contains a "Source Data" sheet. All other sheets contained in each workbook are calculation sheets that derive data from the "Source Data." A "File Naming Convention," developed by PTG ensures the uniqueness of each sheet and workbook.

Switchboard

The analyzer macros enable the user to:

1. Select the Data Set to be used;
2. Select the Worksheet to be used, either new or existing;
3. Enter data to the "Source Data" sheet;
4. Establish individual sheets that enable alignment optimization calculations to be performed;
5. Update individual sheets;
6. Generate a curve throw report; and
7. Create a speed deck for use in the Train Performance Calculator.

The Switchboard is the only point of entry to the alignment analysis programs. The “Source Data” sheet is the only sheet that is altered by the user; analyzer specified forms are provided to ensure consistency and enable data validation.

Data Entry

The following data⁴ is entered for each curve onto the “Source Data” sheet into a column with the same name:

- Curve number.
 - A unique identifier for each row of data. For ascending mileposts, the second curve in a given mile is X.1, third is X.2, etc (e.g. 24, 24.1, 24.2). The compound spiral between the first and second curves would be X.05, between the second and third would be X.15.
- The number of the Track the data was derived from.
- A Y denotes compound Curves.
- A Y denotes a Reverse Curve.
- The direction, or hand of each curve, either Right or Left Hand Curve, L for Left, R for Right.
- Degree of Existing Curvature in the form (DD.ddd);
 - The radius is calculated as $5729.65 / \text{Degree of Curvature}$.
- The length of the existing north Or east Spiral (in feet);
 - All three lengths - North/East, South/West Spirals and Body of Curve or the Measured Length of Curve must be provided.
- The length of the body of the existing curve (feet).
- The length of the south or west spiral (feet)
 - If measured data for each curve is not available, the South/West Spiral optionally can be set equal to the North/East Spiral.
- The measured length of curve (feet).
 - Either calculated from the previous three values or measured.
- Existing actual superelevation (Inches).
- The measured distance to next curve (feet)
- The distance to next milepost (feet)

⁴ Data sources include track charts and/or track geometry car strip chart. Normally track chart data is subsequently supported by track geometry car data.

- The passenger train timetable speed, (mph).
- The freight train timetable speed (mph)
- Maximum allowable speed in that area, if such a restriction exists (mph),
 - If there is a speed restriction to a curve for any reason (alignment runs unprotected through an urban area, bridge cannot withstand high speed, etc.) it is entered in this column. Curve optimization is restricted to this value. If not provided, the optimization process would attempt to raise the operating speed through the curve to its theoretical limit/maximum corridor design speed.

Compound Curves⁵

Compound curves are uniquely numbered. There must be as many curve numbers as there are curves following the numbering scheme:

- X.1 for first curve degree
- X.15 for first intermediate spiral⁶
- X.2 for second Degree of Curvature
- X.25 for second intermediate spiral²
- Etc.

When a compound curves begins between one pair of mileposts (e.g. MP26, MP27) and completes between a different pair (MP 27, MP28) the curve numbering does not change to match the new milepost but rather continues with the prefix it started with (MP26). This is important for proper processing of the compound spirals.

When a compound curve is indicated an entry is automatically placed below the “form” entry. This entry, the compound spiral, has the following values:

- Track No. (Same value as curve above)
- Right or Left Hand Curve (Same value as curve above)
- North Or East Spiral (User prompted for value, feet)
- Distance to Next Curve (Curve above value minus the user entered value)
- Distance to Next Milepost (Curve above value minus the user entered value)
- Both the Degrees of Curvature and Radius are automatically entered as “N/A”.

The following fields for the compound curve are calculated as follows:

- Measure length of curve (see Figure 1)

⁵ See Appendix 3 for additional information on curve numbering.

⁶ Number automatically generated by the program.

- Existing actual superelevation (absolute difference of the previous and following curve Ea)

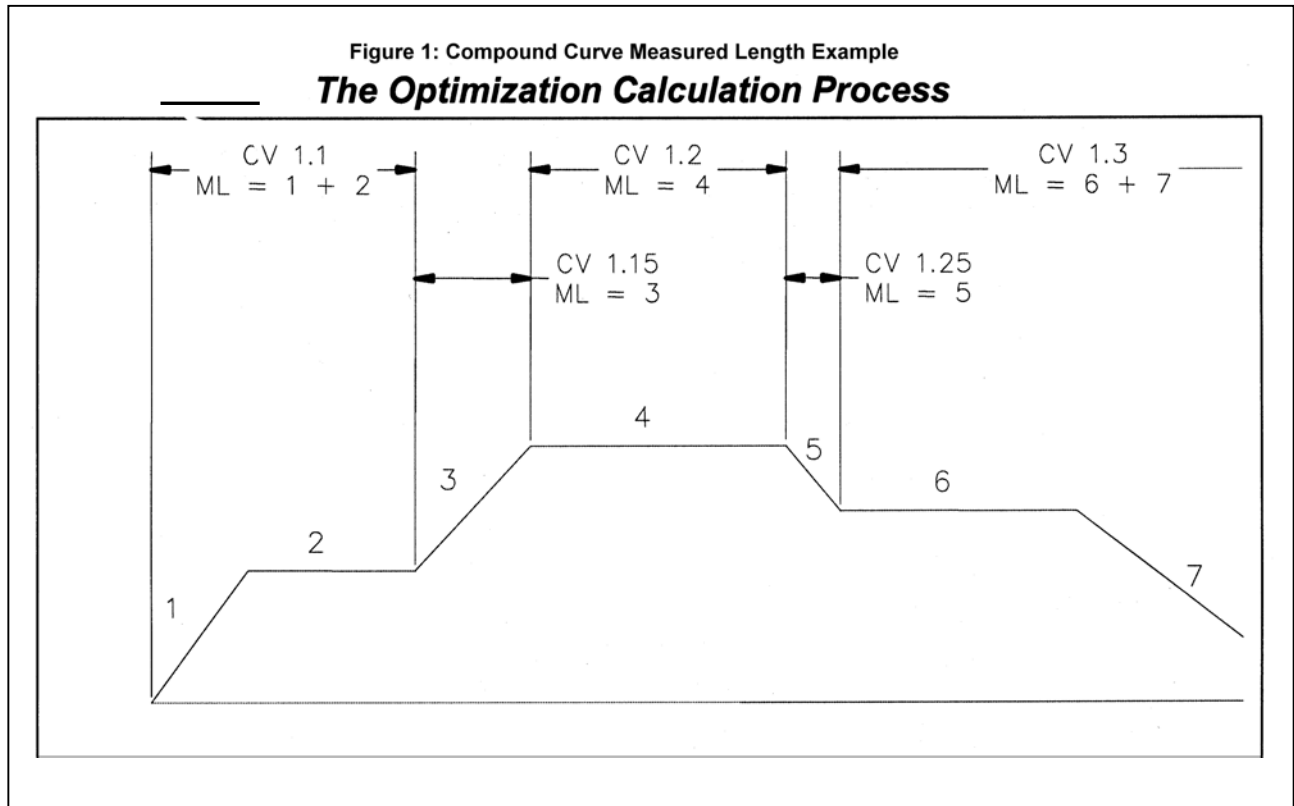

The sequence of the optimization process is as follows. After the source data has been created:

- The options for the analysis are established, and
- The analyses to be performed are defined and run.

The curve option input allows the user to set the following variables:

- Maximum track unbalanced superelevation (Eu) from 1.5 to 9.0 in steps of 0.5 inches.
- Maximum permissible track superelevation (Ea) from 1.5 to 9.0 in steps of 0.5 inches
- Maximum speed from 0 to 110 in steps of 5 mph, plus 79 mph
- Twist calculation formula, the criteria used by the owner/railroad to provide superelevation runoff in uniform increments.

The optimization process would perform specific calculations based either on Tilt or Non-Tilt trainsets. The determination of the calculation performed is derived from the superelevation selected.

Worksheet Naming Convention

The curve option inputs selected become the sheet name under the following part numbering scheme:

NNNTILT-XTWTX

Where:

- NNN is the maximum speed
- TILT is written either as TILT or NTLT
- The first X is the unbalanced super-elevation
- TWT is a three, letter acronym for the operator twist rate equation
- The second X is the maximum permissible track superelevation.

Calculation Alternatives

The user may select any of four series of optimization analyses:

1. Curve, speed, superelevation, and unbalance elevation.
2. Spiral length and comfort index resulting from the curves established by 1.
3. Freight unbalance through the curve established by 1 and 2.
4. Spiral length adjustment to comply and comfortably accommodate the goal speed. The distance the spiral is shifted to establish the spiral length in (2) above, while maintaining the existing curve radius, i.e., degree of curvature.

Each of calculations is discussed below (Formulae are presented both in mathematical terms and in the RC designation defined for row 2):

Proposed Speed and Actual Superelevation

The proposed speed and superelevation values for the curve are entered into specified columns.

For curves, the speed value is used for the start of optimization and is the minimum of:

- The Maximum Speed entered on the Curve Option Input Form; and
- The MAS for the rail line.

The proposed actual superelevation is initialized at the current superelevation. The analyzer performs a series of calculations based on the selected values of superelevation and speed value to determine whether:

- The calculated maximum speed for the curve exceeds the allowable speed,
- The calculated actual total unbalanced exceeds the allowable total unbalance, and
- The Jerk rate exceeds the maximum allowable value.

If the assumed speed and superelevation values exceeds the allowable values, a series of recalculations are performed until a compliant set of values is arrived at:

1. The superelevation is increase in 0.5" inch increments (or a value in compliance with rail owners criteria) until the maximum E_a is reached, at which point
2. The E_a is reset to the existing and the MAS reduced by 5-mph.

For compound spirals, the assumed speed value is the minimum of each of the curves comprising the compound curve and the superelevation is the average of the preceding and succeeding curves.

Curve, Speed, And Unbalanced Elevation

Maximum speed based on Degree of Curvature (D_c) and actual superelevation (E_a) is calculated using the following formula:

$$\sqrt{\frac{E_t}{0.0007 * D_c}}$$

Total superelevation (E_t , usually known as the equilibrium elevation E_e), is the sum of:

$$E_a + E_u.$$

Calculated total superelevation (E_t) based on proposed speed, is calculated using the following formula:

$$\frac{4.011 * \text{Proposed Max Speed}^2}{\text{Curve Radius}}$$

E_u based on proposed speed, also delta E_u , is calculated using the following formula:

$$E_t - E_a$$

Curve Shift Calculations

Three values of spiral length are calculated to determine the optimal spiral length for a given curve.

Minimal Existing Spiral

Spiral length⁷ (L_{s_1}) based on the existing values, is conservatively calculated using the shortest of the two existing spirals, which is calculated from the existing data using the following formula:

$$\text{Minimum (East Spiral, West Spiral)}$$

⁷ There are a variety of formulae to calculate curve length. They are defined in the AREMA manual and in textbooks. Most formulas were developed, over 60 years, as a result of research by AREA, predecessor to AREMA.

Spiral Length Based On Level Of Unbalanced Superelevation And The Proposed Speed

LS₂ calculated based on the Eu and proposed speed, is calculated using the following formula:

$$\frac{Eu * V * 88.9}{0.6217 * 304.7851}$$

Spiral Length Based On The Twist Rate, Or The Rate At Which Superelevation Is Introduced Through A Given Distance From The Tangent To The Body Of The Curve

LS₃ calculated based on the Twist Rate, is calculated using the following formula:

$$\text{Proposed Speed} * \text{Twist Rate}$$

A discussion of twist rates is included in Addendum 2.

Assumed Optimal Spiral Length

Assumed maximum LS_{max} is derived from the three previous calculations, according to the following formula:

$$\text{Maximum} (LS_1, LS_2, LS_3)$$

Additional Values Calculated

Alpha (α), the lateral rotation, used for non-tilt lateral acceleration calculation, is calculated using the following formula:

$$\arcsin\left(\frac{\text{Proposed Ea}}{60}\right) - \frac{Eu * 0.0500909}{6}$$

Lateral acceleration (g), for non-tilting equipment and all equipment at speeds less than 45-mph:

$$\left(\frac{\text{Proposed V} * 5280}{3600}\right)^2 * \frac{\text{Cos}(\alpha)}{32.16 * \text{Curve Radius}} - \text{Sin}(\alpha)$$

For tilting equipment when the speed is greater than 45 mph the following formulae are used to calculate the lateral acceleration

$$\text{If the } Eu < 4.2 \text{ then } 0 \text{ otherwise } \frac{0.1 * (Eu - 4.2)}{4.8}$$

Jerk Rate (J) at proposed speed with optimal LS, is calculated using the following formula:

$$\frac{1.467 * g * \text{Proposed Speed}}{LS_{\max}}$$

A test to determine whether the jerk rate exceeds the assumed maximum value is performed. The Jerk test flag, is calculated using the following formula:

$$\text{If } J > 0.04 \text{ then "Trouble"}$$

A test to determine whether the level of unbalanced superelevation exceeds the assumed maximum value is performed. The Eu test flag, is calculated using the following formula:

$$\text{If } Eu > \text{Track Max } Ea \text{ then "Trouble"}$$

Freight Unbalance Test

The curve defined by the curve calculation process has to represent a balanced approach, i.e., it has to safely and comfortably accommodate all services that would operate in the corridor, at the speed that they would operate on individual curves. The maximum unbalanced superelevation criteria for freight and conventional passenger equipment are not the same as those for tilting high-speed intercity passenger trains. They also may not be the same as those for non-tilting high-speed intercity passenger trains.

The curve analysis process has been setup to verify that comfort criteria are met for non-high speed rail trains. The curve analysis process also attempts to reduce future maintenance costs. A primary concern of freight rail operators is low-rail wear caused by excessive superelevation to accommodate high-speed rail operations.

The freight unbalance section of the worksheet represents an initial check of the potential for this increased maintenance cost. If the actual superelevation increases significantly, freight trains operating at a slower speed, potentially would be operating at an increased level of unbalanced superelevation, which would result in the center of gravity of a freight car shifting towards the lower rail, increasing the load on the lower rail. This increased load may result in increased maintenance costs, particularly if the amount of unbalanced superelevation becomes a negative value in significantly in excess of that calculated for freight trains operating over the existing railroad. The freight-unbalanced section of the sheet represents an initial review of the data.

Freight total superelevation existing (Ee), is calculated using the following formula:

$$\frac{4.011 * \text{Freight Speed}^2}{\text{Curve Radius}}$$

The level of freight superelevation unbalanced (Eu), is calculated using the following formula:

$$Ee - \text{Proposed } Ea$$

Spiral Length Adjustments

The amount, in feet, that the existing spiral would have to be shifted, generally inward, to increase, or decrease, so that the optimal spiral length would exist in the track prior to initiating the proposed service at the proposed MAS and speed for each individual curve is calculated using the following process

The existing deflection angle, in radians, for the Southern spiral (θ_s), is calculated using the following formula:

$$\frac{\text{South Spiral Length}}{2 * \text{Curve Radius}}$$

The existing curve delta (Δ_{curve} , in radians), is calculated using the following formula:

$$\frac{\text{Body of Curve Length}}{\text{Curve Radius}}$$

The existing deflection angle for the Northern spiral (θ_n), is calculated using the following formula:

$$\frac{\text{North Spiral Length}}{2 * \text{Curve Radius}}$$

The deflection angle I, in radians, is the sum of the three previous calculations, is calculated using the following formula:

$$\theta_s + \Delta_{\text{curve}} + \theta_n$$

The existing parallel distance from the tangent track to the point of curve for the Southern spiral (P_s), is approximated as:

$$\frac{\text{South Spiral Length}^2}{24 * \text{Curve Radius}}$$

The existing P for the Northern spiral (P_n), is approximated as:

$$\frac{\text{North Spiral Length}^2}{24 * \text{Curve Radius}}$$

The proposed deflection angle θ for both spirals (θ_p), is calculated using the following formula:

$$\frac{L_{S_{\text{MAX}}}}{2 * \text{Curve Radius}}$$

The proposed parallel distance from the tangent track to the point of curve (P) for both spirals (P_p), is calculated using the following formula:

$$\frac{\text{Proposed Spiral Length}^2}{24 * \text{Curve Radius}}$$

The amount that the southern spiral is shifted (Shift S) is calculated using the following formula:

$$P_p - P_s$$

The amount that the northern spiral is shifted (Shift N) is calculated using the following formula:

Therefore, the expected maximum Shift at the spiral ends, is the maximum of the two previous values, or:

$$\text{Maximum} \left(\left| \text{Shift S} \right|, \left| \text{Shift N} \right| \right)$$

Curve Optimization Process

Once all of the source data has been entered and the option values selected, a curve optimization algorithm is automatically initiated and processes each curve in the source data. As of this time, the algorithm does not accurately calculate the shift for compound curves; therefore a separate manual process is still used to evaluate compound curves and spirals.

The purpose of the optimization is to maximize the proposed speed through a curve and minimize the proposed amount of actual superelevation, subject to the limitation of:

- The maximum theoretical speed through the curve based on the degree of curvature and the proposed superelevation,
- The maximum allowable unbalanced superelevation, and
- The Jerk limit test.

During optimization, each successive reduction in proposed speed is rounded to the next lowest five miles an hour, including 79 mph. Additions to superelevation are made in steps of ½-inch, rounded to the nearest half or whole inch.

Optimized Speed – Goal Speed Comparison

A listing of the optimized speed versus the goal speed for each curve is generated and is used to perform various TPC runs to evaluate trip times between terminals/study endpoints. Those curves that have not attained the desired goal speed, primarily as the result of its degree of curvature are noted. Depending upon the results of the TPC analysis and the need for additional trip time reduction a further analysis may be undertaken. That analysis evaluates the amount that the body of the curve would have to be shifted to obtain a certain level of reduction in the degree of curvature.

For the Richmond to Charlotte Corridor this was necessary and the following process was used.

Analysis To Determine Amount That The Body Of A Curve Must Be Thrown To Reduce Curvature And Enable Goal Speeds To Be Attained

Once the “final” configuration of the corridor in terms of MAS, spiral length, and actual superelevation has been established and the TPC goal time assessed, the throw analysis is performed to determine the maximum amount that the curve would be thrown to enable a certain level of increased speed to be achieved.

The analysis includes the following steps:

1. A calculation sheet for the throw analysis is generated.

2. The Throw Report command from the Switchboard is selected.
3. The existing calculation format is expanded to include a throw analysis and then a new workbook is generated containing all of the data. Each non-compound curve, row, present in the original curve optimization analysis is included in the throw analysis. The throw analysis is performed. Each curve with a Degree of Curvature between 1 (1-degree curves are adequate for 110 mph and the level of adjustment to provide acceptable spiral lengths was calculate by the previous analysis) and 4.5 (it is assumed tighter curves are there for an unmovable reason, smaller curves would not substantially benefit) is analyzed to determine the amount it would have to be relocated inward (“thrown”) from its present degree of curvature to achieve a desired speed. Optimally, based on maximizing the amount of unbalanced superelevation as close to seven inches as practicable, the following degrees of curvature and speeds were used to perform this analysis:
 - a. 3.3 degrees (75 mph),
 - b. 2.97 degrees (79 mph)
 - c. 2.9 degrees (80 mph)
 - d. 2.6 degrees (85 mph)
 - e. 2.3 degrees (90 mph)
 - f. 2.1 degrees (95 mph)
 - g. 1.9 degrees (100 mph)
 - h. 1.7 degrees (105 mph), and
 - i. 1.5 degrees (110 mph).
4. The analysis is initiated with the first optimal degree below the existing curve, i.e., the first throw analyzed for a 3.0-degree curve would be 2.97 degrees. The existing curve is the first listing for each curve. Each thrown curve name is suffixed with the speed for identification purposes (e.g., X-75). All these calculations should be considered proposed based on the “optimized” speed and super elevation. Curves whose degree of curvature is less than one or greater than 4.5 degrees are not analyzed further.

Throw Calculation Process

The intersection angle, I , for the revised degree of curvature for each curve is assumed to remain the same, i.e., the tangents adjacent to the curve are not shifted. The value for the Curve Delta, is therefore calculated using the formula:

$$I - \theta_{\text{North}} - \theta_{\text{South}}$$

Where θ_{North} , θ_{South} are the calculate thetas based on the revised degree of curvature.

The proposed P value for both spirals (Pp), is then calculated using the following formula:

$$\left(\frac{\theta_{\text{Prop}}}{12} - \frac{\theta_{\text{Prop}}^3}{336} + \frac{\theta_{\text{Prop}}^5}{15,840} \right) * L_{S_{\text{Max}}}$$

The following calculations are then appended to the right side of the existing calculations:

Curve decimal degrees (DD.ddd), is calculated using the following formula:

$$\frac{I * 180}{\pi}$$

Distance from the point of tangent to point of curve (K) for the original curve is calculated using the following formula:

$$\left(\frac{1}{2} - \frac{\theta_{\text{South}}^2}{60} + \frac{\theta_{\text{South}}^4}{2160} - \frac{\theta_{\text{South}}^6}{131040} \right) * L_{\text{South}}$$

For each of the reduced degrees of curvature, the distance from the point of tangent to the point of curve is calculate using the following formula:

$$\left(\frac{1}{2} - \frac{\theta_{\text{South}}^2}{60} + \frac{\theta_{\text{South}}^4}{2160} - \frac{\theta_{\text{South}}^6}{131040} \right) * L_{\text{Max}}$$

The proposed distance from the point of intersection to the point of tangent (Ts) for each curve reduction option is calculated using the following formula:

$$(R + P_{\text{Prop}}) * \text{Tangent} \left(\frac{I}{2} \right) + K_{\text{Prop}}$$

The distance from the point of intersection to the curve along the curve radius (Es), is calculated using the following formula:

$$\sqrt{(T_{S_{\text{Prop}}} - K_{\text{Prop}})^2 + (R + P_{\text{Prop}})^2} - R$$

The maximum throw for the curve reductions is calculated using the following formula:

$$\text{Maximum}(\text{Spiral shift}, E_{\text{Current}} - E_{\text{Source}})$$

The new proposed arc length is calculated using the following formula:

$$R * \Delta_{\text{Curve}}$$

The new Arc length for the base curves is calculated using the following formula:

$$\frac{I * 100}{D} - L_{S_{\text{Max}}}$$

For the thrown curves the new arc length for each degree of curvature is calculated using the following formula:

$$\sum(2 * L_{\max}, L_{\text{arc}_{\text{prop}}})$$

If the values for the revised Curve Delta or Arc Length are negative, the cell is highlighted and the new arc length is shown as N/A.

Summary Throw Report

The results of the curve reduction and throw analysis are summarized in a Throw Summary Report, which contains the following data:

- Basic curve number
- Curve Degrees
- North Spiral
- Body of Curve
- South Spiral
- Measured Length of Curve
- Proposed Spiral Length (for Ea shift only)
- Proposed Ea (for Ea shift only)
- Expected Maximum Spiral Midpoint Shift (for Ea Shift)
- Columns for each speed increment, i.e., 75, 79, 80, 85, 90, etc. display the maximum amount of shift required to achieve each desired degree of curvature and speed. The summary process determines whether the throw at the spiral or the body of the curve is the largest throw required. The cell containing the shift value required to achieve the revised goal speed is highlighted. The amount of shift at the spiral is not highlighted. A single line border designates the revised goal speed.

Creating a Speed Deck

Once the Alignment Analyzer has completed its analysis and a set of goal speeds has been defined, a Speed Deck for subsequent input into a TPC analysis is automatically generated. The process does not automatically generate restrictions for reasons other than civil (curve-related) speeds; therefore, the Speed Deck must be edited to include them.

Smoothing

As explained in Appendix B, the TPC simulation indicates the speed achieved as the result of the affect of vertical and horizontal curvature, adjacent speed restrictions, scheduled stops, and other operating issues. The smoothing process enables the planner/engineer to avoid designing a curve to a speed that never would be achieved. For example, in the example below, Curve 367 on the Piedmont Main Line had an assumed goal speed of 110 mph, however, because of the 95 mph speed restriction of adjacent Curves 367A and 366 the goal train only achieves a maximum speed of 97 mph northbound and 88 mph southbound. The train attempts to accelerate to 110 mph after having cleared the 95 mph restriction but has to begin decelerating before attaining the goal speed. Therefore, the goal speed for Curve 367 has been reduced to 95 mph and the amount of relocation required reduced.

Smoothing is the process of determining the design speed for each curve. The process results in the development of a **Round Trip Analysis Smoothing Report**, which is the final step in the Analyzer methodology. The smoothing report is based on a round trip from Charlotte to Richmond to Charlotte with the same train on the assumed corridor configuration, including assumed stops, assumed curve speeds, and assumed speed limits. The report utilizes a round-trip TPC run to determine the maximum speed obtained by the high-speed intercity train on each curve. The maximum speed reached is not the same in each direction. Vertical and horizontal curvature, the proximity of speed-restricted curves, station stops, and other performance considerations affects a train's operation in each direction. The smoothing process avoids the unnecessary expense of constructing a curve to support a maximum speed that would not be achieved in daily operation. On the other hand, because of the potential variation in speed in each direction, the process ensures that the curve would be designed to support the maximum speed attainable through each curve. The smoothing report is automatically generated. This report has the following columns:

- Curve number;
- Assumed Speed Limit;
- Maximum speed achieved on curve in one direction, Charlotte to Richmond in the example shown;
- Maximum speed achieved on curve in the return direction
- Recommended Smoothed Speed, the speed that the curve should be designed to achieve.

Sample Smoothing Table

Curve	Speed Limit	CharlotteRichmond 110Mph 7In TILT 1P42C6 6Stops	RichmondCharlotte 110Mph 7In TILT 1P42C6 6Stops Reversed	Recommended Smoothed Speed (Bold indicates possible reductions)
	376	55	55	55
	374	100	74	100
	373	110	76	95
	372	110	81	95
	370	110	87	90
	369	110	100	100
367A		95	95	95
	367	110	97	100
	366	95	95	95
	365	110	99	100
	363	95	95	95
	362	110	102	105
	361	95	95	95
360A		95	95	95
	360	95	93	95
	359.1	95		95
	359	95	90	95
358A		95	87	95
	358	95	89	95
	357	110	92	100
356A		110	98	105
	356	110	101	105
	355	110	99	100
	354	95	95	95
	353	110	94	110
	352	110	91	110
	349	110	89	105
	347	95	89	95
	346	95	95	95
345A		95	94	95
	345	95	95	95

Manual Analysis Techniques

The alignment analyzer also performed a series of analyses to determine potential locations where problems might occur as the result of the recommended curve modifications. The primary difficulty identified was that there was not enough tangent available between a pair of adjacent curves to enable the curves to be shifted, a process which lengthens each curve, for the selected speed. The impact of reducing the speed was evaluated and as necessary a manual technique utilizing existing mapping or USGS mapping was undertaken to evaluate alternative methods of realigning the curves or in certain cases a group of curves.

The manual analysis technique also was used to evaluate numerous locations that were identified as potential trip time reduction locations.

The analyses performed are discussed in the following section.

Curve Analysis and Results

S Line –Richmond to Raleigh

The S Line had numerous three and four-degree curves, which unless modified would greatly reduce achievable speeds. The scheduled travel time of the Silver Meteor, the Seaboard Coast Line's premiere train between New York and Florida in 1958 had a travel time of 1-hour and 32 minutes between Richmond and Norlina. The proposed travel time for the Richmond to Charlotte high-speed trains is 1-hour and 15 minutes between Richmond and Norlina. This significant reduction in travel time would be achieved by increasing MAS to 110 mph and by implementing a few short line relocations to eliminate the most restrictive track locations.

Burgess to Norlina

Dinwiddie Relocation (MP S36.8 – MP S39)

A 2.2-mile realignment, requiring a large fill, would eliminate two four-degree curves (65 mph) and reduce a three-degree curve (75 mph) to one degree (110 mph). Speed on the relocated track would be increased from 65 mph to 110 mph. The relocated alignment would reduce transit time almost one-half minute and would be about 0.18 miles shorter.

MP S58.5 TO MP S60.1

Two curves (S58 and S59) in this 1.6-mile segment would be realigned to a 90 mph configuration to eliminate a restrictive 75 mph (three-degree curve) in the stretch between MP S45 and S81. The curve reduction is located within the limits of the proposed Alberta Siding. The revised alignment would reduce transit time almost 0.3 minutes.

MP S62.6 TO MP S66.3

A 3.3-mile relocation would eliminate or reduce the curvature of six (S62, S63, S63.1, S64, S65, S65.1) of the seven curves in the segment that are greater than two degrees. The realignment would cross two ridges separated by a deep ravine in between the ridges. The former S Line crossed the ravine and Great Creek on a 411 foot long DPG bridge about 50 feet high and cut through the ridges with shallow cuts. The ravine would be filled in. The relocated track would cross the ravine at the same location the angle of crossing would be altered, eliminating the possibility of reusing the Great Creek Bridge. Speed on the relocated track

would be increased to 90 mph. The revised alignment would reduce transit time almost 0.75 minutes.

MP S66.9 to MP S75.3

The 8.4-mile curve realignment and right-of-way relocation extends into and incorporates the 3.7-mile Skelton Siding. It is proposed that:

- The curvature of four curves (S68, S69, S69.1, S69.2) north of the Meherrin River Bridge be reduced;
- Three curves (S70, S70.1, S70.2) south of the Meherrin River Bridge (MP S70.2) be replaced with one 1.6-degree right hand curve good for 100 mph; and
- A 7,900-foot line south of MP S71 that would replace four four-degree curves (65 mph) with a pair of reverse⁸ 1.75-degree curves (100 mph). The relocation would be about 400 feet shorter than the original alignment; and
- A 2900-foot relocation replaces two curves (S74, S74.1) at the south end of the siding with a single 1.5-degree curve (with four inches superelevation restricted to 100 mph). The relocation would provide sufficient room to locate the turnout to the south end of the siding north of the Taylor Creek Bridge.

The revised alignment would reduce transit time almost 1.4 minutes.

MP S77 to MP S77.8 (Curves S77, S77.1 and S77.2)

A 4,600-foot realignment would replace three short three-degree reverse curves (75 mph) with one left-hand one-degree curve (110 mph) and eliminate a reduced speed zone in an otherwise high-speed stretch. The alignment avoids encroaching upon a cemetery adjacent to the right-of-way. The revised alignment would reduce transit time almost 0.5 minutes.

MP S86.1 to MP S87 (Curves S86, S86.1, S86.2)

A 4,200-foot relocation would replace three curves (a left-hand 4.5-degree curve (60 mph), a right-hand 4-degree curve (65 mph), and a left-hand 4-degree curve (65 mph) with one two-degree curve (90 mph, with five inches superelevation). The relocation enables Bracey siding to extend from MP S83 to S87.2. The revised alignment would reduce transit time almost 0.3 minutes.

MP S89.4 to MP S91.4 (Curves S89, S90, S90.1)

Curves S89 (2.5 degrees), S90 (3 degrees), S90.1 (3 degrees) south of the Roanoke River Bridge would be realigned to reduce curvature to 1.5 degrees (110 mph). The realignments between MP S89.4 and MP S91.4 would extend a stretch where trains can operate at a constant 110 mph three miles further north and create the longest continuous high-speed stretch (twenty-miles, Bracey (MP S88.0) and MP108.2) between Richmond and Raleigh. The revised alignment would reduce transit time almost 0.2 minutes.

⁸ In this case a 1.75-degree curve to the right would be followed by a 1.75-degree curve to the left.

MP S96.6 to MP S98.6

Reconfiguring the alignment though Norlina between MP S96.5 to MP S98.7 would require a 1.6-mile relocation resulting in a 7,000-foot long one-degree curve (110 mph) connecting the S Line and the Portsmouth Line. The relocation results in the elimination of Curves S96, S98 (the most restrictive at 5.08 degrees (60 mph), and S98.1. The north end of Norlina Siding would be located at the south end of the one-degree curve. The new alignment would require reconstruction of 3500 feet of the former line to Portsmouth and a grade separation. The revised alignment would reduce transit time almost 0.9 minutes.

This relocation would begin at a location south of the Norlina Siding would be within the longest (20-mile) continuous high-speed length between Richmond and Raleigh.

Norlina to Raleigh

The MAS on this 58-mile section previously was 79 mph for passenger trains and 50 mph for freight trains.

Manson Curve

Manson curve (S103) is a 3.25 left hand curve (75 mph) in an area that can and should be 110-mph territory. Curve S102, a two-degree eight minute right hand curve (90 mph), is the south end of the eleven mile stretch of 110 mph running, can easily be reduced to 1.5 degrees or less to achieve 110 mph. Connecting Curve S102 to Curve S104 with a line change, would eliminate Curve S103 and would extend the 110 mph segment five additional miles. The relocation would be approximately 1,000 feet shorter than the current route. A minimum of one-half minute in time would be saved. With this change the south end of the 110-mph running would be at MP S108.3 instead of MP S 102.6.

Curves South of Wake Forest

The distance between the ends of adjacent curves south of Wake Forest (MP S140) are insufficient, to enable the spirals of numerous curves to be lengthened to achieve greater speeds because. Two solutions to increase speeds were evaluated:

- The first modified individual curves to increase the speed from 60 mph, which CSX operated when passenger trains were still operating on the line, to 75 mph.
- The second treats curves as a group and further raises the speed to 110 or 100 mph.

The curves include:

- Curve 140, a 2-degree curve (95 mph with six inches of superelevation⁹) beginning at MP S140.6 that reverses into
- Curve 140.1, a 1600 foot long 3.12-degree curve (75 mph), which is less than 200 feet from the south end of Curve 140,
- Curve 141, in Forestville, is a right hand two-degree curve (95 mph) that reverses into
- Curve 142¹⁰, a two-degree left hand curve (approximately 100 feet between the two curves) that directly reverses into

⁹ The speed would be 90 mph with five inches of superelevation. The actual superelevation installed as the result of the upgrade program would depend upon negotiations with the railroads.

- Curve 142.1, a 3.25-degree right hand curve (75 mph) that reverses into
- Curve 142.2¹¹, a 2.25-degree left hand curve (90 mph) (approximately one hundred feet between the two curves) that reverses into Curve 143, a three-degree right hand curve (75 mph) (with less than one hundred feet between the two curves¹²).

Holding Avenue crossing (140.98) in Wake Forest is in Curve 140.1; six inches superelevation would result in a speed of 70 mph with very little realignment work within the town. Seventy mph is an increase from the 45 mph that CSX had when it was running passenger trains over this route. The profile of Holding Avenue through the crossing would have to be revised to enable the superelevation to be installed.

All five of the curves below would be revised to achieve 110 mph:

- Curve 141 would be extended northward and relocated to the inside of the curve approximately 39 feet to obtain a 1.5-degree curve
- It is assumed that Forestville Road would be eliminated and access provided by the proposed Rogers Road Extension to be constructed by a developer. At least one home would be removed by the relocation.
- Curves 142, 142.1, and 142.2 would be eliminated by the construction of a new tangent that extends to Curve 143.
- Curve 143 is also reduced to 1.5 degrees by moving it about 100 feet inward.
- Since this alignment crosses the current alignment in two places, the new line would have to be constructed at the same elevation at those two points to facilitate construction.
- Curve 143.1 is a 1,600 feet long three-degree curve (75 mph) on a 50-60 foot fill across a valley. The curve can be reduced to 1.5 degrees and the speed increased to 110 mph compared to the existing 60 mph by constructing a new fill.
- Curves 144 and 144.1 are both two-degree curves (95 mph) that can be realigned to 1.5 degrees to achieve 110 mph without major reconstruction. The alignment of Curve 144.1 would have to pass through the existing Route US 1 overpass.
- Curve 145 is a 2,300-foot long 3.08-degree curve (75 mph). A 110 mph solution does not appear likely, however by changing the tangent direction between Curves 144.1 and 145, Curve S145 can be realigned to a 1.8-degree with a 100 mph MAS.
- Curve 146.2 (1950 feet long) reverses into Curve 146.3 (1750 feet long) south of Neuse River, both are 3.25-degrees (75 mph), there is about 450 feet of tangent between the two curves.

¹⁰ Forestville Road is in Curve 142.

¹¹ A switch to an industry is located in the tangent between Curves 142.1 and 142.2

¹² A private crossing leading to a cemetery and some homes is located between these curves.

100 mph can be achieved by relocating the tangent between Curves S146.2 and S146.3. New curve 146.2 would be 2600 feet long and Curve 146.3 would be 2250 feet long. A tangent of 200 feet would separate the curves.

The total time saved by the 100 and 110 mph solutions between Forestville and Neuse highway crossing is about 2.6 minutes, a reduction in travel time to 3.4 minutes from 6 minutes:

Segment	Time (minutes) Through Segment		
	Constrained Existing -60 mph	75 mph Option	100-110 mph Option
MP 141.5-MP 143.5	2.0 minutes	1.6 minutes	1.1 minutes
MP 143.5-MP 145.0	1.5 minutes	1.2 minutes	0.82 minutes
MP 145.0-MP 147.5	2.5 minutes	2.0 minutes	1.5 minutes
Total	6.0 minutes	4.8 minutes	3.42
Time Savings	0.0 minutes	1.2 minutes	2.6 minutes

H Line

Fetner to Greensboro – Clusters of Curves

Curves H55 to H60.1

These curves are located in a six-mile stretch, extending to MP H62.5 (Curve H62) that can be upgraded to a 110-mph stretch.

Curve H60.1 is a one-degree curve, which would be made good for 110 mph by lengthening spirals. A left-hand industrial switch is located on the low side of the curve and would have to be relocated to enable the curve to be shifted inward.

Curve H60 is a two-degree curve (95 mph) that is proposed to reduce to 1.5-degrees to make it good for 110 mph. It is proposed to grade separate the crossing with Route 1654 to remove a crossing from a curve.

Curves H59 and H59.1 are three-degree curves (75 mph). It is proposed to reduce both of these curves and eliminate Curve H59.2 by a 6500-foot line change. New Curve H59 is reduced to a very short one-degree curve good for 110 mph. Curve H59.1 is reduced to a 1.5-degree curve also good for 110 and as stated before Curve H59.2 has been eliminated.

Curves H56, H57, and H58 are all short two-degree curves (90 mph). Presently their spirals range from 190 feet to 257 feet in length. All three curves can be made good for 90 mph by increasing their spiral lengths to 413 feet and providing five inches of superelevation.

All three curves could be realigned inward less than a foot to provide the desired spirals and superelevation. However, by moving the track inward another three feet each curve can be reduced to a 1.5-degree curve good for 100 mph. Since a new siding through Durham would be constructed in the limits of these curves it is proposed that the existing tracks not be realigned at all but rather the new construction would be a made new main track built with 1.5-degree curves good for 110 mph.

Curve H55.3 is a three-degree curve (75 mph) with very short 199 and 190-foot spirals, which restrict current spirals to 60 mph. Fayetteville Street crossing is in the west spiral of this curve and Ramseur Street is just east of the east end of this curve. The potential for closing Fayetteville Street should be evaluated. Dillard Street would be grade separated. It is proposed that this curve be reduced to 2.5 degrees with 500-foot spirals good for 85 mph. Right-of-way appears available to allow the inward movement of the approximate 32 feet necessary onto the roadbed of former CSX tracks that appear to have been removed. The new east spiral would extend through Ramseur Street crossing.

Curves H55, H55.1 and H55.2 are listed as a compound curve of two degrees, three degrees (75 mph), and two degrees respectively. Upon inspection the curves appear to be a two-degree curve with irregularities in the center. Dillard Street is in the east portion of the curve and to avoid having a highway crossing on a curve with six inches superelevation it should be closed. Traffic can use the Roxboro Street underpass, but preferably Dillard Street would be grade separated. This curve can be easily realigned to a uniform 2.1 degrees, so with 450-foot spirals the unbalanced elevation would be 5.1 inches at 85 mph. Curve H55.3 is a three-degree curve (75 mph) with very short spirals of 199 and 190 feet and is currently good for only 55 mph. Fayetteville Street is in the west spiral of this curve and it is recommended that this crossing also be closed.

With this last change, the territory between MP 55 and H62.5, over six miles, can be made good for continuous 110 mph running. The revised alignment would reduce transit time more than 0.6 minute.

Curve H49 to Curve H44

Curve H49, a long 2826-foot two-degree curve, has spirals of 230 and 120 feet. Five hundred (500) foot spirals are required to operate at 95 mph, with six inches of superelevation. It is unlikely these can be achieved because Curve H49 reverses into a long four-degree curve (65 mph) H50 with less than a 100-foot between the curves. Therefore, whatever is done to H49 must be accomplished within the limits of the existing curve. It is recommended that the curve be realigned by shifting the center of the curve outward about 40 feet to create a new 2.28-degree curve, which can be operated at 90 mph with 6.9 inches of unbalanced superelevation. If that large of a shift were not possible a curve realignment resulting in shorter spirals and lower speeds would be necessary¹³.

Curve H48.1 is two degrees. The existing spirals of 260 feet need to be lengthened to 500-foot to operate at 95 mph. The existing curve is 2,325 feet long and the curve with the lengthened spirals would be 2,565 feet long, a difference of 240 feet or 120 feet in each direction. That leaves a tangent length of slightly more than 100 feet between Curves H48.1 and H48. Curve H48.1 is located within the limits of the existing Funston Siding. A cut and throw

¹³ For example, with 413-foot spirals and five inches of superelevation the curvature would increase to only 2.2 degrees, which is good for 85 mph, and the outward movement of the curve is reduced to 30 feet.

would be made at the north end of the proposed siding so that the existing siding would become the main track and the existing main track would become the siding. Therefore, only the proposed new main track (including the existing siding) would be relocated onto the proposed alignment.

Curve H48, a four-degree curve (65 mph) 1647 feet long, follows two two-degree curves (H48.1 and H49). If Curve H48 could be reduced to two degrees, the three curves (H49, H48.1, H48) could be operated at a uniform 95 mph. Leaving Curve H48 as it is, would place a 65 mph restriction between an area of potential 100 mph running and a area of possible 95 mph running. Shifting the center of Curve H48 inward 200 feet would create the required curve. An inspection of USGS maps indicates no impediments that would prevent the track from being moved¹⁴. Assuming H48 can be relocated, the new curve would be 3,250 feet long (1,603 feet longer than the existing Curve H48) including two 500-foot spirals. The distance between spirals of Curves H48 and Curve H48.1 presently is 1,032 feet; therefore, the relocated curve would require that all but about 225 feet of that tangent be realigned. This relocation requires that both the main track and the siding be moved.

Curve H47 is a three-degree curve (75 mph). The goal for this curve would be to reduce it to 1.75 degrees to obtain 100 mph. The maximum movement inward for this curve would be less than 35 feet. The new curve would be about 1,775 total feet long with two 450-foot spirals. Curve 47 would be located within the limits of the extended Funston Siding. The current main track would become the siding and would remain in its present location. The new main track would be constructed on the recommended alignment parallel to the siding.

Curve H46.1 is an oddly shaped two-degree 983-foot curve with spirals of 332 and 93 feet. No reason for the 93-foot spiral is evident on a USGS map. The curve would be reduced to 1.75 degrees to achieve the goal of 100mph. A minimum of 450-foot spirals would be required, so the new curve length would be 1,250 feet.

Curve H46 is a left hand 2.8-degree curve (80 mph) that precedes **Curve H45**, a right hand three-degree curve (75 mph).

Curve H44.1, located less than one mile east of H44, is a long four-degree left hand curve (65 mph). Unless the curve is relocated, the curve and Curve H45 would be major impediments to high-speed operation. The existing spirals are far too short to run in the six inches of superelevation required to maximize the speed for this curve, which at most would be 65 mph. The best solution is an 11,000-foot relocation that would raise the speed to 100 mph or better throughout.

The relocation would begin near the NC10 underpass west of the current west end of Curve H44.1. It would cut directly across Stony Creek on a 50-foot fill. All curves on the relocated line are 1.4 degrees good for 110 mph and it is estimated that about 800 feet in distance would also be saved. A discussion of the probable transit time saved would be discussed later.

The south end of the Funston passing siding would be located within the limits of the relocation. Initially it was assumed that the west end of the siding would be west of Curve H44.1, which is also coincidentally the west end of the relocation. The siding assumption was made before the relocation was conceived. The existing track throughout the relocated area

¹⁴ The USGS maps do not show the property usage, so it is not known whether impediments to moving the track exist; further evaluation during final design would be required.

would remain in place as the siding and the relocated track would be the main track. Consequently, curves H46.1, H46, H45, and H44.1 would not be modified. The relocated track would pass over the branch to Chapel Hill and a highway intersection would pass over the relocated track.

Curve H44 is a short two-degree curve 638 feet long including spirals of 226 and 133 feet. Spirals of 250 feet are needed to make this curve good for 80 mph. The resulting curve would have a body of 207 feet and two 250-foot spirals. Increasing the speed to 100 mph would require 450-foot spirals and would require that curvature be reduced to 1.75 degrees. The resulting curve would be 525 feet long and have a body length of only 75 feet.

Between the east end of Curve H43.1 and the east end of Curve H49 the changes outlined make a 4.9-mile long segment that can be operated at a 100-110 mph. The distance saved would reduce transit time about 0.1 minutes. The increased speed on the remaining 4.75 miles would save an additional 1.1 minutes, so about 1.2 minute savings are estimated.

H36 to H38.2 (H36.4 – H38.9)

The next group of restrictive reverse curves is east of Efland. **Curve H38** is shown as a left hand three-degree curve (75 mph) that reverses into **Curve H38.1**, a right hand 3-degree curve. **Curve H38.2**, 3-degree left hand curve, is currently good for 70 mph. Curve H38 reverses into Curve H38.1; its 193-foot east spiral abuts the 192-foot west spiral of Curve H38.1 with no tangent between them. Furthermore, a major bridge over the US70-I84 connector dual highway is in the center of this curve. Thus, the center and both ends of this curve are fixed locations and speed can only be made greater than 60 mph by relocating both Curves H38 and H38.1.

Curve H38.1 referred to above reverses into 3-degree **Curve H38.2** (75 mph). Only 106 feet exists between the spirals of these curves but the 456-foot west spiral of Curve H38.1 adjacent to Curve H38.1 is longer than the 413 feet needed for 75 mph, the maximum achievable speed with 5 inches of superelevation. Curve H38.2 is good for 70 mph, with its present spirals and superelevation.

In lieu of a piecemeal solution of shifting individual curves around to obtain 75 mph, a 7,000-foot relocation is proposed that would reduce **Curves H37** and H38.2 to 1.75 degrees and eliminate Curves H38 and H38.1 altogether and would be good for 100 mph. This relocation would entail a new bridge over the highway. A less ambitious relocation thought to be able to save the current bridge, if it had been constructed so that it could accommodate curvature other than three-degrees, was considered; but photographs indicate the bridge is built to fit only a three-degree curve.

The relocation would facilitate other synergistic changes at Efland. The two-degree **Curve H36.1** can be reduced to 1.75 degrees to match the 100 mph running created by the relocation. That work would be accomplished with an inward movement of the curve at the midpoint about 10 feet.

A solution to **Curve H36**, a three-degree curve, could be somewhat of a problem. If nothing were done to this curve other than lengthening spirals, it would be a 75-mph slowdown bracketed by long stretches of 100 and 110 mph running on either side of it. At a minimum the goal should be to reduce the curvature to 2 degrees to obtain 95 mph. An inward throw of about 120 feet would achieve two degrees; it appears that only one and at most two buildings would be taken. The current main track would remain and would become the new passing siding that

would be needed at this location. The current main track would become the siding and a new relocated track would be constructed and become the main track.

The realignment of Curves H36 through H38.2, a distance of about 2.6 miles, would save northward passenger trains about 0.6 minutes. Southward trains would likely save less time because of the grade between Eno River and Efland.

Curves H 28.4 to H26 (MP H29.2 to H26.3)

The compound curves **H28.2, H28.3 and H28.4** can be made good for 95 mph by lengthening spirals. However, the recommended alternative is to realign the curves to make them a simple curve. The resulting 1.56-degree curve would be good for 105 mph.

Curves H28.1 and H28. Curve H28 is a four-degree (65 mph) curve located about 450-feet east of Curve H27.2. It is good for 60 mph, as it now exists. The maximum achievable speed with 5 inches of superelevation is 65 mph, which normally could be achieved by lengthening spirals, however, the east spiral of Curve H28 abuts the west spiral of Curve H28.1, and it is not feasible to lengthen the spirals to increase superelevation and speed.

Curve H27.1 has an existing spiral of only 182 feet (good for only 55 mph) at Back Creek Bridge, and a spiral of that length is definitely not long enough for 70 mph.

The Back Creek Bridge is about 106 feet long and is located between curves H27.1 and H27.2. **Curve H27.2** is a short curve of 758 feet with spirals of 390 feet adjacent to the bridge and 288 feet on the east end of the curve. The body of the curve is only 80 feet long. The east spiral of **Curve H27.1**, a three-degree curve ends at the open deck bridge over Back Creek. **Curve H27** is a three-degree curve (75 mph) with inadequate spirals to allow the maximum achievable speed with 5 inches of superelevation of 75 mph. The short east spiral of this curve abuts the west spiral of **Curve H27.1**. Therefore the ends of both spirals of Curve H27.1 are fixed locations and lengthening the spirals by extending them further onto tangents, as usually done, is impossible. With the existing superelevation and spiral lengths, a tilt train may traverse the Curve H70 at 70 mph.

Two optional relocations to increase speed were evaluated:

1. The first, a 4,000-foot relocation would eliminate Curve H28.1 and reduce the curvature of Curve H28. The relocation would connect Curve H27.2 and Curve H28.2 with tangent track and would raise the speed from 60 to 105-mph.
2. The second relocation, a 6,500-foot relocation would connect Curves H26.2 and H28.2. This relocation would eliminate restrictions on Curves H27, H27.1, H27.2, H28 and H28.1 and increase the speed to 105 mph instead of 60 and 70 mph, and save about 0.6 minutes transit time.

The second relocation is recommended.

Curve **H26.1** is located about 1,000 feet east of Curve 26. **Curve H26.1** is a three-degree curve (75 mph) that reverses into four-degree curve (65 mph) **H26.2** with no distance at all between the two spirals. The short spirals of Curve H26.1 eliminate a simple readjustment as a viable option to increase speed. Because of short spirals Curve H26.2 is good for 55 mph for tilt trains. Any solution must consider Curves H26.1 and H26.2 together rather than individually.

Inward movement of Curve H26.1 curve 34 feet would create a three-degree curve; alternatively an inward movement of 28 feet would create a 3.15-degree curve (still good for 75

mph). Moving the track inward that much may mean becoming too close to some homes adjacent to the rail line. However, by holding the main track near its current position behind the homes they should not be affected by the relocation. Also the track must pass under the existing State Route 1928 overhead bridge.

The inward movement of a 3.15-degree curve near the center of the existing curve would be small, but the right or east end of the curve would move outward towards the highway. It would be necessary to create a new dogleg to return to the original alignment. The west end of the new Curve H26.2 would fall on the original location but the angle of the tangent between Curves H26.2 and H26.1 would be rotated. Rotating the tangent reduced the intersection angles of both Curves H26.1 and H26.2 and provided sufficient room for adequate spirals for Curves H26.1 and H26.2. Both curves should then be good for 75 mph.

Curve H26 is a very short 579-foot four-degree curve (65 mph) with two 190-foot spirals. The USGS maps reveal no obvious reason why Curve H26 must remain a four-degree curve. The maximum achievable speed with 5 inches of superelevation for this curve is 65 mph but 75 mph can be attained with little effort. Shifting the curve less than five feet inward would create a three-degree curve, which with 413-foot spirals is good for 75 mph.

H20.1 to H 21.3 (H20.5 to H22.3)

In Burlington reverse Curves H20.2 and H21 and Curves H21.1 and H21.2 appear to be the result of cuts and throws when tracks were removed. Lengthening both reverse curves should be able to raise the allowable speed to 100 mph or greater. Constructing a new track parallel to the current main track and retiring the current main track could eliminate Curves H21.1 and H21.2.

H 6 to H5.1 (MPH6.3 to H5.6)

Curve H5.3 is shown as a right-hand 2.5-degree curve on the track chart that could be made good for 85 mph by adjusting the amount of superelevation and the length of the spirals. The north end of Curve H5.3 is only 44 feet from the south end of **Curve H6** - a right hand one-degree curve that easily can be operated at 110-mph MAS by adjusting superelevation and spiral length. The 123-foot Buffalo Creek Bridge is located between Curves H5.3 and H6. It is proposed that the bridge over Buffalo Creek be renewed with a new curved bridge to enable Curves H5.2 and H6 to be realigned into one continuous 1.58-degree curve good for 100 mph.

The distance from the south end of Curve H5.3 to the north end of Curve H6 is 1,965 feet.

Curve H5.1 is shown on the track chart as a 1.8-degree curve, but the curve data¹⁵ shows that H5.1 actually is a compound curve of 1.8 degrees on the west end and 2.1 degrees on the east end (Curve H5.2). The west spiral is 186 feet and the east spiral is 190 feet. A **target** speed for this curve should be 95 mph even though the 2.1-degree portion would not allow it, unless reduced to 2 degrees or less. The length of the curves including spirals is 2,191 feet. Combining the curves into a two-degree curve would lengthen the curve to 2,451 feet, or 300 feet longer than the original curve. Each end of the curve would be extended approximately 150 feet. The north end of Curve H5.3 is 230 feet from the current north end if Curve H5.2 so there is room for the proposed curve lengthening.

¹⁵ Developed from a recent FRA Track Geometry Car run.

H Line - Individual Curves

Curve H64

Curve H64 is a three-degree curve (75 mph) that would be a restricting curve in an otherwise 90 mph stretch of track. It is recommended that the curve be realigned to become a 2.15-degree curve, which can be made good for 90 mph.

Piedmont Line – NS Washington to Atlanta Main Line

Curve 296

Curve 296 would be realigned to reduce curvature from 2.5 degrees to 2-degree to eliminate an 85-mph restrictive curve in a 25-mile stretch of high-speed running.

Minor Modifications

The following track segments, defined by curves at each end of the segment, were evaluated, but it was determined that significant relocations to increase speed would not be justified. However, it is recommended that curves be adjusted by increasing the amount of superelevation and length of spirals to achieve recommended MAS.

H Line – Raleigh to Greensboro

Curves H72 – H65

Curve H72 and H70.1 are two-degree curves that with five inches of superelevation can be operated at 90 mph. **Curve H70**, a three-degree curve, would be restricted to 75 mph, while **Curve H72** would be restricted to 80 mph by the reconfiguration and realignment of Fetner Interlocking. Therefore, 80 mph is the more appropriate MAS for curves H70.1 and H72. Both curves presently are adequate for 80 mph.

Curves H69, H69.1 and H70 are all three-degree curves (75 mph) with spirals of 314 to 384 feet except for the east spiral of Curve H70, which has a spiral of 199 feet. Curve H69 reverses into Curve H69.1, Curve H69.1 reverses into Curve H70, and finally Curve H70 reverses into Curve H70.1. The distance between H70 and H70.1 is 190 feet. The recently constructed Morrisville Road (SR 3060) grade crossing is located in the body of Curve H69.1. These curves can be made good for 70 mph with four inches of superelevation and 331-foot spirals. Increasing spirals to 500 feet to get 75 mph is considered an infeasible option. All spirals, except the 199-foot one, can be easily lengthened to 331 feet with minimal throws of only a few inches. Morrisville Road would be grade separated.

Sharpening Curve H70 slightly to a 3.10 degree curve makes it possible to lengthen the 199-foot spiral to 331 feet without extending the curve into the 190-foot tangent between H70 and H70.1. The revised curve would be good for 70 mph with 6.6 inches of unbalanced superelevation.

Curves H67 and H68 are both two-degree curves, currently good for 80 mph. The curves can be operated at 90 mph by increasing the current spiral lengths from 230-324 feet to 413 feet with minimal shifting of the existing track (one to two feet maximum).

The distance between reverse **Curves H65 and Curve H66** is only 75 feet. Roadways parallel the track on either side and both curves presently are good for 80 mph. However, by

rotating the tangent between the curves slightly only minimal throws would be required to operate both curves at 90 mph

Curves H 63.2 to H60.2

Left hand two-degree **curve H63.1** reverses into right hand **Curve H63.2**, another two-degree curve. The 40-foot distance between the two curves does not provide adequate room to lengthen the spirals of either curve. The short 164-foot east spiral of Curve H63.1 would presently restrict speed through the curve to 60 mph. Recent photographs indicate that the west spiral of Curve H63.1 appears to end about 150 feet east of the I-40 Bridge, therefore, adequate room should exist to enable the west spiral of Curve H63.1 to be extended. The distance between the points of intersection of Curves H63.1 and H63.2 is about 1330 feet, as calculated from the curve data, but at least 1552 feet are needed to put in 413 spirals to achieve 90 mph. Clearly insufficient distance exists to add the longer spirals but the distance can be gained by rotating the tangent between Curves 63.1 and 63.2, which would reduce the intersection angle of both curves. Therefore Curves H63.1 and H63.2 would be upgraded to 90 mph, as both have been given 413-foot spirals for five inches of superelevation. The resulting unbalanced superelevation at 90 mph is 6.3 inches. New Curve H63.1 is 1097 feet long compared to the current 1001 feet and new Curve H63.2 is 1629 feet compared to the current 1579 feet. The distance between curves is 88 feet compared to the current 40 feet.

Associated work: Replace the open deck underpass for State Route 54 (Nelson Road) at the very east end of Curve H63.2 with a ballasted bridge to allow Curve H63.2 to be lengthened.

Curve H63 is a two-degree curve with spirals of 261 and 288 feet. It is proposed to lengthen the spirals to 413 feet to obtain 90 mph. The inward throw would be about two-thirds foot. By slightly increasing the degree of curve the center of the curve would not move.

Curve H62 is a two-degree curve with spirals of 279 and 283 feet. It is proposed to lengthen the spirals to 413 feet to obtain 90 mph, an inward throw of only 0.67 feet. By increasing the degree of curve to 2.04 degrees the center of the curve has no movement.

Curves H54.1 to Curves H48.1

Curve H54.1 is a two-degree curve with 275 and 204-foot spirals. An open deck bridge over Gregson Street is located at the end of the 207-foot east spiral of this curve, but the curve is good for 70 mph without change. Increasing this spiral length would make it necessary to replace Gregson Street Bridge with a ballasted deck. It is assumed that the bridge would be renewed in any event so the spiral lengths can be increased to 310 feet to make the curve good for 80 mph. However, the TPC Curve Smoothing Process indicated that the maximum achievable speed through the curve was 75 mph; therefore it is recommended that the speed be increased to 75 mph instead of 80.

Since the next **Curve H54** is three degrees, the best speed that can be achieved on that curve by lengthening spirals is 75 mph. Curve H54 (three degrees) is currently good for 65 mph. Speeds through Curve H54 can be increased to 70 mph by lengthening the spirals from about 260 feet to 310 feet and to 75 mph by lengthening the spirals to 413 feet. Since the two curves to the west are good for 80 mph and the curve to the north is also good for 80 mph, it is logical to make this curve good for 80 mph too. Reducing the curvature to 2.75 degrees would enable that speed to be achieved. The calculated intersection angle is 18.74 degrees, so crafting a 2.75-degree curve would move the center of the curve inward less than 2.4 feet, exclusive of spiral offsets. The current spirals have offset the existing curve 1.7 feet and a 500-foot spiral for

a 2.75-degree curve would have an offset of 5.0 feet or an additional inward move of 3.3 feet. Therefore moving the body of the curve inward of less than six feet would create a curve of 2.75 degrees with two 500 foot spirals. The body of the curve would be only 180 feet. **Associated Work:** Buchanan Boulevard is located in the east spiral of this curve. The potential for eliminating the crossing by providing alternative access through the use of underpasses located adjacent to the crossing

Curves H52.1 and H53 are two-degree curves now good for 70 mph without change. Curve H53 has a short spiral of 190 feet that ends at an open deck bridge over Erwin Street. Both curves would be upgraded to be good for 80 mph. **Associated work:** The bridge over **Erwin Street** would be replaced with a ballasted deck bridge to enable the spiral to be lengthened to 310 feet. **Swift Avenue** crossing is located in Curve H53, however there are underpasses less than 1,100 feet away on either side of the crossing; the potential for eliminating the crossing should be evaluated.

The next three curves, **H51, H51.1 and H52**, are all three degrees. Curves H51 and H52 can be made good for 70 mph with only minor tweaking of their spirals and with maximum throws of about six inches or less. Further lengthening the spirals for Curve H52 to optimize the speed and obtain 75 mph (500 foot spirals) would involve shifting track through a major curved bridge over Hilland Road in the center of the curve and is not recommended. All three existing curves are now good for 65 mph.

The most severe of the three curves is H51.1, a 1059-foot curve with spirals of 275 and 199 feet. Normally extending the spirals should be no problem, but Curve H51.1 also contains a major four-lane highway (US 15) curved bridge in the body of the curve. That would prevent moving the track more than a few inches through the bridge. Minimum 360-foot spirals (4.25 inches superelevation) would be required for 70 mph. The existing 200-foot spiral has already offset the track 0.9 feet. The offset for an assumed 3.1-degree curve is 2.8 feet, so the new curve would move inward an additional 1.9 feet if longer spiral is built and the curve sharpened to 3.1 degrees as assumed. The calculated intersection angle is 24.66, so the distance from the intersection point to the center of a three-degrees is 45 feet. To offset the inward movement of the track at the spirals an outward movement of the curve at the center can reduce that distance. For example by making the distance from the intersection point to the center 43.1 feet the center of the curve would not move and the existing bridge may be acceptable. Doing that would increase the curvature to 3.13 degrees; 70 mph would be obtained with 6.5 inches of unbalanced superelevation.

Curve H50 is a long 2935-foot four-degree curve (65 mph) having spirals of 314 and 354 feet. The **goal speed of 60 mph** would be achieved by increasing superelevation to four inches.

Curves H43.1 to Curve H39

Curve H43, a two-degree curve, is 983 feet long including the two spirals. The east spiral is 195 feet and the west spiral is 257 feet and the calculated intersection angle is 15.14 degrees. To make this curve good for 75 mph, spiral lengths of 195 feet and two inches of superelevation are needed. Lengthening the east end of the curve 17 feet to make the curve 964 feet long and create 2.02-degree curve. Less than one -inch throw would be required to accomplish this minor realignment as part of an upcoming maintenance program.

Curve H43.1 and Curve H42.1 are quite similar. Increasing the length of the spirals of each curve to 413 feet and providing 5 inches of superelevation the curves can be made good for 75 mph.

Associated Work: Realigning Curve H42.1, a three-degree curve, for 75 mph would require a new bridge for **Cates Run** (currently 47 feet long). **Curve H41.1** is a 3.5-degree curve that reverses into **Curve 42**, a four-degree curve, with no distance between the two 210 foot spirals. In addition, an industrial switch to Georgia Pacific is located between the curves in the spiral of Curve H42, which would make for a questionable ride at high speed. From a spiral and superelevation standpoint Curve H42 (four degrees) is good for 60 mph, as it now exists. The maximum achievable speed with 5 inches of superelevation is 65 mph, but that speed cannot be achieved without track relocation.

The curvature in **Curve H41.1** would be reduced from **3.5 degrees to 3.15 degrees**, to achieve **75 mph with 5.5 inches superelevation and 455-foot spirals**.

Curve H42 would be reduced from four degrees to three degrees to attain **75 mph with five inches superelevation and 413-foot spirals**.

1. Moving the tangent intersection point of Curve H41.1 west about 200 feet would achieve the 3.15-degree curve desired. That would rotate the tangent between Curve H41.1 and H42 and would create a distance of about 1900 feet between the new intersection points of Curves H41.1 and H42.

These new curves would be good for 75 mph.

Curves H40 and H41 are two-degree curves. The maximum achievable speed with 6 inches of superelevation is 95 mph but because of the proximity of Curve H39.1 that speed appears too optimistic for Curve H40. Curves H40 and H41 are good for 75 mph, as they now exist. **No change is proposed for either curve**.

Curve H39.1 is a four-degree curve. The maximum achievable speed with 5 inches of superelevation is 65 mph.

Curve H39, a three-degree curve, is immediately east of the Eno River Bridge. The curve is currently good for 65 mph and since it is adjacent to Curve H39.1, a four-degree curve (65 mph), it should remain unchanged.

Curves H25.2 to Curves H23

Curve H25.2 is a two-degree curve located just east of the Haw River Bridge. The maximum achievable speed with 6 inches of superelevation would normally be 95 mph but since this curve is adjacent to **Curve H26**, a 75 mph curve, it is not recommended to make this curve good for 95 mph.

Curve H25.1 also is a short three-degree curve (75 mph) with inadequate spirals of 292 and 190 feet good for 60 mph. 413-foot spirals are needed to operate 75 mph, the maximum achievable speed with 5 inches of superelevation. **Associated Work:** To lengthen the 190-foot east spiral a new ballasted-deck **Route 49 bridge** would be required; the current bridge is open deck and the beginning of the spiral is at the very west end of the bridge. The bridge over Haw River is just east of this curve.

Curve H24, a left-hand three-degree curve, reverses into right hand **Curve H25** with no distance between the curves. It is good for 70 mph, as it currently exists. To operate 75 mph, the **target** speed, 413-foot spirals are required. The west spiral for Curve 23 is 310 feet and the east spiral is 492 feet, which is greater than needed. The west spiral for Curve 25 is also 492 feet and the east spiral is 252 feet. By shortening both 492-foot spirals by 50 feet, a tangent distance of 100 feet can be made between the curves. To obtain the 413 west spiral the curve

must be extended 62 feet onto the tangent. The current main track would become the siding and a new main track would be constructed north of the current track with appropriate spirals.

With the minor realignments discussed, both Curves H24 and H25 can be operated at the maximum achievable speed with 5 inches of superelevation of 75 mph. The current main track would also become the siding at this location.

Curve H23 is shown on the track chart as a three-degree curve (75 mph) but the curve data shows that it might be a compound curve of 2.4 and 3 degrees. However the body of the 2.4-degree curve is only 84 feet long. The entire length of curve H23 is 301 feet, which is connected to **Curve H23.1** by a 75-foot spiral. That suggests that curve H23 is really not a curve at all but a malformed spiral for Curve H23.1 376 feet long and is considered as such by this analysis. To operate 75 mph, the maximum achievable speed with 5 inches of superelevation for this curve, requires not less than five inches superelevation and a 413-foot spirals. The current spirals are 376 feet (Curve H23) and 368 feet in length, so only a modest lengthening of the spirals is needed to achieve a speed of 75 mph. Pomeroy Street crossing is in the curve and the turnout to Cannon Mills, an active industry, comes off the high side of this curve, however a siding would be needed in this area so the current main track can become the siding. In that way the industrial switch would come off the siding with less superelevation than the main track and the new main track would be constructed north of the current main track with the appropriate spirals.

Addendum 1

Typical Source Data Arrangement

Cve No.	Trk No.	Cmpnd Curve	Reverse Curve?	R/L Hand Curve	Curve Degrees (Feet, Existing)	Radius Feet (Feet, Existing)	North Or East Spiral (Feet, Existing)	Body Of Curve (Feet)	South or West Spiral (Feet, Existing)	Measured Length Of Curve (Feet)	Exist Ea From Trk Chart (Inch)	Dist to Next Curve (Feet)	Dist to Next MP (Feet)	Time Table Speed (Mph)	Fr V (Mph)	MAS (Mph)
136.70	3	Y		L	1.3	4,407				789	4.5			0	0	25
136.75	3			L	N/A	N/A	-	-		-	3.3					
136.90	2	Y		L	2.4	2,387				1,020	1.3					25
136.95	2				N/A	N/A	-	-		-	1.3			0	0	
137.00	2	Y		L	1.1	5,209				205	0.0			0	0	25
137.05	2				N/A	N/A	-	-		-	0.5					
137.10	2	Y		L	6.3	917				260	0.5			0	0	25
137.15	2				N/A	N/A	-	-		-	0.0			0	0	
137.20	2				2.2	2,604		115	150	265	0.5					35
137.50	2				7.9	730	135	325	155	615	2.0					45
138.10	2				5.9	979	155	485	130	770	1.3					45
138.50	2				1.0	6,031	105	245	175	525	0.5					45
109.40	3	Y		L	1.0	5,730				1,472	1.0					45
109.35	3				N/A	N/A	-	-		-	3.3			0	0	
109.30	3				5.1	1,131		195	160	355	4.3					45
109.20	3				2.8	2,046	148	79	130	357	1.8					45
109.10	3				4.7	1,219	125	171	177	473	3.5					45
108.90	3				2.0	2,865	130	849	130	1,109	1.8					45
108.60	3				5.2	1,113	241	292	200	733	3.8					65
108.50	3	Y		L	4.5	1,283				496	3.8					65
108.45	3				N/A	N/A	186	-		186	2.5					
108.20	3			L	1.4	4,093				760	1.3					65
108.10	3				2.0	2,865	-	470	335	805	2.0					65
106.50	3				2.1	2,772	190	817	292	1,299	4.3					70

Addendum 2

Twist Equations

Twist equations

Amtrak

Speeds from 0 to 50-mph, $\frac{1}{2}$ -inch per 31-feet or 0.01612903 inch per foot

Speeds from 51 to 70-mph, $\frac{3}{8}$ -inch per 31-feet or 0.01209677 inch per foot

Speeds greater than 71-mph, $\frac{1}{4}$ -inch per 31-feet or 0.00806452 inch per foot

Metro-North

Speeds from 0 to 60-mph, $\frac{1}{2}$ -inch per 31-feet or 0.01612903 inch per foot

Speeds from 61 to 90-mph, $\frac{3}{8}$ -inch per 31-feet or 0.01209677 inch per foot

Speeds greater than 91-mph, $\frac{1}{4}$ -inch per 31-feet or 0.00806452 inch per foot

CSX

Speeds from 0 to 50-mph, $\frac{1}{2}$ -inch per 31-feet or 0.01612903 per foot

Speeds from 51 to 70-mph, $\frac{1}{2}$ -inch per 39-feet or 0.01282051 inch per foot

Speeds greater than 71-mph, $\frac{1}{2}$ -inch per 50-feet or 0.01 inch per foot

Norfolk Southern

Speeds from 0 to 60-mph, $\frac{1}{2}$ -inch per 31-feet or 0.01612903 inch per foot

Speeds greater than 61-mph, $\frac{3}{8}$ -inch per 31-feet or 0.01209677 inch per foot

The twist criteria of other major carriers or property owners would be added as information becomes available.

Addendum 3

Line Numbering

The recommended scheme for curve numbering is defined in this Appendix. It would require some modification as unique situations arise, but should be adhered to as much as possible.

Each line of a given run shall be denoted with a unique, thousands place identifier. The first (or starting line) is assigned the zero thousands. Curve numbering, as noted earlier, begins with X.1. Thus, if the first curve occurs between milepost 5 and 6, its name would be 5.1. A curve between mileposts 5 and 6 in the second line would be 1005.1, and so on. This convention would accommodate up to ten different lines and nine curves in a given mile (9001.0) while using only six characters for the name. The benefits of this scheme are easy sorting and filtering of continuous reports of the entire run and avoidance of duplication of names.

**Technical Monograph:
Transportation Planning
for the Richmond–Charlotte Railroad Corridor**

January 2004

**Appendix B
Train Performance Calculator Analysis To Support Project Goals**

**Federal Railroad Administration
United States Department of Transportation**

Appendix B

TRAIN PERFORMANCE CALCULATOR ANALYSIS TO SUPPORT PROJECT GOALS

Introduction

This Appendix discusses the variables, assumptions, and results of the train performance calculator (TPC) analyses informing the Richmond–Charlotte transportation plan.

The purpose of these analyses was to assess and confirm—under varying equipment, infrastructure, and operating scenarios—the capability of the Richmond–Charlotte Corridor to support an intercity rail passenger service that would comply with the States’ goals for travel times and reliability. To accomplish this task, the TPC simulates a single train’s progress over the route to measure trip time differences between existing and proposed track configurations and geometric characteristics. While this particular technology does not model the interactions among multiple trains, such as would typify practical operations, it does fulfill a critical screening function by scoping out the route’s capabilities for high-speed operations, identifying the types of improvements that would realize those capabilities, and projecting the differences between scheduling goals of the States and the likely trip times. It is those differences (if favorable) that could constitute the “pad,” or cushion for lateness, which would provide for schedule reliability in the face of random delays that inevitably affect operations. Further operating analyses, described in Appendix C, build on the TPC results by addressing in detail the crucial topic of interactions among trains.

As described in Chapter 3, the States’ goal is regularly scheduled, safe, and dependable five-stop rail passenger service between Richmond, VA and Charlotte, NC in less than 4 hours and 25 minutes. For all practical purposes, the 4 hour–25 minute, 5-stop goal equates to the benchmark of 4 hour–20 minute, 4-stop service between Richmond and Charlotte, which was originally applied in the TPC runs.

The alignment analysis described in Appendix A was performed interactively with the TPC throughout the trip time analysis process. Initially, the alignment analyzer developed the speed assumptions that were tested in the TPC process. The final runs described in this appendix used speeds that had either been confirmed or adjusted by a manual alignment analysis process, also described in Appendix A.

Conditions used in the TPC simulations, including maximum authorized speeds, speeds through curves, and unbalanced superelevation, represent the collective best judgment of experienced rail operators based on the assumed design and condition of the fixed facilities, equipment, and appurtenances, as well as on applicable engineering, regulatory, and ride quality considerations. Before high-speed operations are

introduced, however, many of these conditions will have to be analyzed in greater detail, tested to ensure the safety and passenger comfort of the total system, and subjected to all applicable review and approval processes by FRA's Office of Safety.

Background: TPC Running Times, Schedule Times, and Pad

The TPC simulated running time is the best achievable time that may be expected of a given train operated over a railroad line with given physical characteristics. The TPC times are therefore the most optimistic running times for each given train consist.

When train schedules are prepared using TPC simulated times as a basis for the train running times, it is necessary to add an allowance for minor operating irregularities en route, which may be expected to occur on a daily basis, while maintaining a high probability of on-time performance. Several terms are used for this allowance, the most common of which are "pad", "cushion time", or "slop". A discussion of the issue of the amount of pad that should be added to the TPC times is found in a later subsection. The addition of this allowance to the TPC running time will enable trains to perform reliably on a day-to-day basis. The pad also will enable trains to regain any lost time resulting from minor delays (i.e., temporary speed restrictions, diversions around maintenance work, time lost at a station when passenger boardings are slow or heavy, etc.). Pad also provides for two additional components: the probability that not all of the configuration and alignment improvements incorporated into the model will prove physically feasible; and the realization that the model assumes that the train engineer operates the train in a consistent and precise manner in response to speed changes.

The final section of this Appendix, "Synthesis and Conclusions," explores the implications of pad and the limitations of pure TPC running times. It is important to note here, however, that **to reliably meet the trip time goal, TPC running times must be substantially better than the trip time goal.**

Summary of the Cases

As applied in this Appendix, the term "case" represents a single run of the TPC model that incorporates a cohesive set of assumptions about the variables that establish the specifications of that run. Summary Table B selectively lists the most prominent cases undertaken in this analysis, shows the choices of variables underlying each case, presents the relevant results, and provides the basis of the following sections. The section on "Variables Addressed in the Cases" deals with the columns of Summary Table B and explores the options available under each column heading; the "Discussion of the Cases" similarly treats the rows of Summary Table B in some detail.

Summary Table B: Specifications and Results of the TPC Cases. (All Cases Assume S Line Restoration.)

Case Number	Propulsion		Hotel power		Number of Cars	Unbalanced Superelevation (inches)	Tilt?		Stops	Alignment				MAS		Minimal MAS if any		Timing, Charlotte-Richmond (hours:minutes:seconds)	Comments
	Diesel	Gas Turbine	From locomotive(s)	From separate source			Yes	No		Existing Optimized (Includes double-tracking P Line except as noted)	With Contemplated Improvements	With Other Combinations of Improvements	Existing (Status Quo Ante for S Line)	Improved (mph)	Charlotte-Richmond	Greensboro-Raleigh only			
1(a)	1		•		6	3	•	•	4	•	•	•	•	•	•	•	•	5:43:32	Baseline case
1(b)	1		•		6	3	•	•	4	•	•	•	•	•	•	•	•	4:47:49	
1(c)	1		•		6	4	•	•	4	•	•	•	•	•	•	•	•	4:45:51	
1(d)	1		•		6	5	•	•	4	•	•	•	•	•	•	•	•	4:40:42	
1(e)	1		•		6	7	•	•	4	•	•	•	•	•	•	•	•	4:37:11	Additional unbalance required tilt. MAS constrains the benefits.
1(f)	1		•		6	9	•	•	4	•	•	•	•	•	•	•	•	4:34:00	This case is only hypothetical as standard Diesel-powered equipment in the U.S. will not safely operate at 9" of unbalance. Other locomotives, now under development, might be certified for such operation. No further details of this case are provided in this Appendix.
1(g)	2		•		6	7	•	•	4	•	•	•	•	•	•	•	•	4:34:00	
2(a)	1		•		6	7	•	•	4	•	•	•	•	•	•	•	•	4:20:05	
2(b)	2		•		6	7	•	•	4	•	•	•	•	•	•	•	•	4:11:29	
3(a)	1		•		6	3	•	•	4	•	•	•	•	•	•	•	•	4:36:52	
3(b)	1		•		6	4	•	•	4	•	•	•	•	•	•	•	•	4:33:36	
3(c)	1		•		6	5	•	•	4	•	•	•	•	•	•	•	•	4:24:30	
3(d)	1		•		6	7	•	•	4	•	•	•	•	•	•	•	•	4:13:39	
3(e)	1		•		6	9	•	•	4	•	•	•	•	•	•	•	•	4:05:30	This case is only hypothetical as standard Diesel-powered equipment in the U.S. will not safely operate at 9" of unbalance. Other locomotives, now under development, might be certified for such operation.
3(f)	2		•		6	7	•	•	4	•	•	•	•	•	•	•	•	3:57:58	
3(g)	2		•		6	7	•	•	4	•	•	•	•	•	•	•	•	4:08:04	Not double-tracking the Charlotte-Greensboro line necessitates diverging moves at interlockings, with negative impacts on trip times.

Summary Table B, Continued: Specifications and Results of the TPC Cases (All Cases Assume S Line Restoration.)

Run Number	Propulsion		Hotel power		Number of Cars	Unbalanced Superelevation (inches)	Tilt?		Stops	Alignment				Fatal flaw in equipment or facility concept?	MAS		Minimal MAS if any		Timing, Charlotte-Richmond (hh:mm)	Comments
	Diesel	Gas Turbine	From locomotive(s)	From separate source			Yes	No		Existing	Existing Optimized (Includes double-tracking P Line except as noted)	With Contemplated Improvements	With Other Combinations of Improvements		Existing	Improved (mph)	Charlotte-Richmond	Greensboro-Raleigh only		
4(a)	•		•		6	7	•	No	4	Existing					Existing	110			3:56:05	
4(b)	•		•		6	7	•		4	•						110			3:54:08	
5(a)	•		•		6	7	•		4			•	+			110	80		3:50:49	+To establish minimal MASs of 80 mph or more between Charlotte and Richmond would require some additional curve realignments (beyond the contemplated improvements) that could prove to be impractical from the environmental viewpoint.
5(b)	•		•		6	7	•		4			•	+			110	85		3:47:18	
5(c)	•		•		6	7	•		4			•	+			110	90		3:43:41	
5(d)	•		•		6	7	•		4			•	+			110	95		3:40:02	
5(e)	•		•		6	7	•		4			•	+			110	100		3:33:47	
5(f)	•		•		6	7	•		4			•	+			110	105		3:28:24	
6(a)	•		•		6	7	•		4			•	+			110	80		3:47:38	
6(b)	•		•		6	7	•		4			•	+			110	85		3:46:19	
6(c)	•		•		6	7	•		4			•	+			110	90		3:45:12	
6(d)	•		•		6	7	•		4			•	+			110	95		3:44:20	
7(a)	•		•		6	7	•		4			• ^a				110			3:47:02	^a With initial optimization of curve alignments, Greensboro to Richmond.
7(b)	•		•		6	7	•		4			• ^a				110			3:44:12	
8(a)	•		•		6	7	•		4			•				110			3:50:56	These options represent the "Contemplated Improvements" with various station stop assumptions.
8(b)	•		•		6	7	•		5			•				110			3:53:17	
8(c)	•		•		6	7	•		6			•				110			3:55:40	
9(a)	•		•		4	7	•		4			•				110			3:52:32	
9(b)	•		•		8	7	•		4			•				110			4:00:42	
9(c)	•		•		10	7	•		4			•				110			4:04:47	
9(d)	•		•		12	7	•		4			•				110			4:09:28	

A Note on Direction

Case 1(a), the “baseline,” was run in both directions and showed a longer trip time northbound (05:43:32¹) than southbound (05:42:27). Existing vertical curvature was the primary factor in the difference in the TPC runs; primarily the ruling grades were in the northbound direction. Since the northbound trip thus presented the more stringent challenge, all subsequent cases were run in the northbound direction only, so as to simulate worst-case conditions.

Variables Addressed in the Cases

This section discusses the variables that the TPC model could use to differentiate among cases. Each TPC case represented a unique combination of choices from options from options available within these variables.

Number of Locomotives

Both one- and two-locomotive trainsets were modeled. However, all cases involving high-performance options used two locomotives per train, with instructive results in comparable cases:

Number of Locomotives	Percent Trip Time (Decrease) Versus 1 Locomotive	Minutes (Saved) Versus 1 Locomotive	Compare Cases
2	(6.2%)	(15.7)	3(f) and 3(d)
3	(7.7%)	(19.5)	4(b) and 3(d)
Number of Locomotives	Percent Trip Time (Decrease) Versus 2 Locomotives	Minutes (Saved) Versus 2 Locomotives	Compare Cases
3	(1.6%)	(3.8)	4(b) and 3(f)

The above results suggest that upgrading from one to two locomotives produces a significant performance benefit (almost 16 minutes), but that diminishing returns set in when the consist increases further to three locomotives

Propulsion Source

All runs assumed from one to three up-to-date Diesel locomotives per trainset, except for a single case, 7(b), which made use of two gas turbine-powered locomotives.

Hotel Power

In modern American railroad practice, electrical power for the train’s utilities originates in the locomotive (hence the similar terms “head-end power” or “hotel power”).² This is the assumption in most of the TPC cases; however, one case, 4(a),

¹ All times in this Appendix are expressed as hours:minutes:seconds.

² This contrasts with former practices, inherited from the steam era, in which wheelset-powered generators and batteries produced and stored power for each individual car, in effect by exerting a drag on the forward movement on the train.

explored the option of providing a separate, on-train generator, thereby increasing the locomotive output available for propulsion. This variation reduced the trip time by 0.8 percent (1.9 minutes).³

Number of Cars

All trainsets were assumed to have six cars, except for a small number of sensitivity excursions that tested two-locomotive trains with 4-, 8-, 10-, and 12-car consists. Comparative results were as follows:

Number of Cars	Percent Trip Time (Reduction) or Increase Versus 6-Car Consist	Minutes (Saved) or Lost Versus 6-Car Consist	Compare Cases
4	(2.3%)	(5.4)	9a and 3f
8	1.1%	2.7	9b and 3f
10	2.9%	6.8	9c and 3f
12	4.8%	11.5	9d and 3f

The study team regarded the five-minute time savings as insufficient to outweigh the constraint on operating flexibility imposed by a four-car consist limit, particularly at peak weekend and holiday periods when capacity, travel times, and reliability must be optimal to encourage repeat business.

Number of Stops

Most of the runs assumed four intermediate station stops per high-speed train from Charlotte to Richmond. Runs 8(a) through 8(c)—representing the contemplated improvements—tested the sensitivity of travel times to five- and six-stop schedules as well, with the following results:

Number of Stops	Percent Trip Time Increase Versus 4 Stops	Minutes Lost Versus 4 Stops	Compare Cases
5	1.0%	2.4	8(b) and 8(a)
6	2.0%	4.7	8(c) and 8(a)

³ Compare cases 4(a) and 3(f).

Alignment

All cases assumed reconstruction and rehabilitation of the S Line, Richmond–Raleigh. The “baseline” case (1(a)) assumed that the restored S Line would retain its legacy alignment, and that no changes whatsoever to the existing Charlotte–Raleigh alignment would occur.

Beyond the baseline case, the TPC runs proceeded over time, in tandem with the curve alignment studies, in a coordinated effort to define the level of betterment that would be necessary and sufficient to allow the Richmond–Charlotte Corridor to reliably fulfill the service goals set by the States. Therefore, as recorded in this Appendix, the study team explored a number of experimental avenues before settling on the “contemplated improvements” and accompanying operational plans.

At the outset, most of the cases (numbered 1(b) through 4⁴) adopted the “existing alignment optimized” assumption—with no major curve realignments but with incremental changes in spirals, superelevation, and curvature within the right-of-way, to maximize performance over the road. Except in Case 3(g), also assumed as part of the “existing alignment optimized” was the restoration of double track throughout the Piedmont Main Line between Greensboro and Charlotte, which would affect not only capacity but also individual train performance, in that it would eliminate slow, diverging moves at the turnouts joining single and double track.

Cases numbered 5, 6, and 7 represented experiments in defining potential sets of curve realignments by means of blanket assumptions; in Summary Table B, these are termed “other combinations of improvements” (i.e., “other” than the “contemplated improvements”).⁵ Finally, as the entire analysis progressed, it became possible to run the TPC simulation over the “contemplated improvements” elaborated iteratively by the study team, and described in detail in the Main Report and other Appendixes.

MAS

The four modeled levels of maximum authorized speed were:

⁴ The sensitivity analyses of train lengths, Cases 9(a) through (d), were also based on the “existing alignment optimized.”

⁵ Cases 7(a) and (b) represented an advance in the analysis, as described further below. Certain project elements would have overlapped between the “other combinations” and the “contemplated improvements.”

- “Existing” speeds—up to 79 mph on existing passenger lines, and, on the S Line, the speed limits for express trains prior to its abandonment;
- A consistent 79 mph MAS;
- 90 mph; and
- 110 mph.

The 110 mph MAS was assumed for all higher-performance options.

Minimal MAS

Experimentation with the imposition of minimal MASs (of 80 mph and above) was an attempt to quickly identify groups of curves that would be ideal candidates for realignment. However, this automated technique identified a number of curves the realignment of which would impose obvious environmental difficulties. As a result, the study team regarded these options—whether applied to the entire corridor or to the H Line alone—as impracticable, and turned to other means of optimizing the alignment.

Timing, Charlotte–Richmond

This column provides a summary result for each case. Further details on the case results appear in Tables B-1 through B-11, which present the results by line segment, and compare the cases incrementally.

Discussion of the Cases

The following sections describe, in some detail, the cases that are listed in the rows of Summary Table B.

Group 1: Conventional-Speed Cases

The TPC analyses began with a group of cases that restricted MASs to 79 mph or below. All the conventional-speed cases shared the following assumptions:

- A trainset consisting of six coaches powered by one P42DC locomotive;
- The former Seaboard Air Line (SAL) trackage between Norlina, NC and Centralia, VA restored;
- Maximum unbalanced superelevation = 3 inches; and
- Four intermediate stops⁶: three-minute dwell at Raleigh, two-minute dwell at Greensboro, one-minute dwell at Durham and Petersburg.

⁶ Initially, four stops were planned, and the earlier TPC runs reflect this. A fifth stop at I-485 (i.e., a “beltway”-type station for Charlotte), was subsequently added for planning purposes.

Beyond these common assumptions, the differences among the cases in Group (1) were significant and are discussed below.

Case 1(a): Baseline

To establish a benchmark for current route capabilities (legacy capabilities in the case of the S Line), a baseline TPC run was performed. The baseline conditions included:

- Existing⁷ passenger train MASs between Charlotte and Raleigh;
- 1975 passenger train MASs between Raleigh and Richmond;
- No changes whatsoever in the existing active alignment between Charlotte and Raleigh, or in the legacy alignment of the S Line between Raleigh and Richmond;
- Curve-related speed restrictions as shown in NS and CSX employee timetables that were in effect in either in 1999 between Charlotte and Raleigh or in 1975 between Raleigh and Richmond; and
- Other civil speed restrictions, i.e., for grade crossings, local restrictions, etc., were assumed to remain in force.

Under these assumptions, the baseline Charlotte–Richmond timing was 5 hours, 44 minutes. By contrast, as this report goes to press, Amtrak’s Charlotte–Richmond timing is 6 hours, 59 minutes—one hour, 15 minutes longer than the baseline.⁸ The difference is easily explained by (a) the twelve intermediate stops that Amtrak currently makes, versus the four assumed in the baseline; and (b) the circuitous A Line routing (35 miles longer than the S Line) that Amtrak now uses.

Cases 1(b) through 1(f): Improved Conventional-Speed Cases

Additional cases explored the capabilities of conventional-speed service under the following assumptions:

- The “existing alignment optimized” option would be effected (see page 7); this includes double-tracking the P Line portion of this corridor.
- Non-track-related civil speed restrictions, e.g., for grade crossings, local restrictions, and the like, would be eliminated.
- The track, its supporting structures, and signal systems would be upgraded and/or maintained, as necessary, to eliminate existing physical conditions that restrict speeds below those which the alignment would support.
- MAS would be 79 mph wherever feasible, but no higher.

⁷ As of 1999, when the analysis for this report began.

⁸ Amtrak System Time, October 27, 2003, p. 76.

- Unbalanced superelevation was assumed to start at 3” in Case 1(b), and was increased to 4” (Case 1(c)), 5” (Case 1(d)), 7” (Case 1(e)), and to a hypothetical 9” (Case 1(f)).⁹
- Jerk rate would be restricted to a maximum of 0.04 g/sec.
- All cases with 7” or more unbalanced superelevation assumed the use of tilt coaches, analogous to Amtrak’s Acela coaches.
- In tilting cases, the tilt mechanism was assumed to be cut out under 45 mph and gradually ramped in to its maximum at 60 mph.

With respect to the unbalance and tilt assumptions, readers should note that non-tilting coaches on Amtrak’s Northeast Corridor presently operate with 5” of unbalanced superelevation. Also, since five inches of unbalanced superelevation would permit speeds in excess of 79 mph on certain curves restricted in these cases to 79 mph or less, the full effect of an increase in unbalanced superelevation from three to five inches is constrained by the 79 mph MAS.

The results of Cases 1(b) through 1(f) are shown in Table B-1 and excerpted in the figure below.

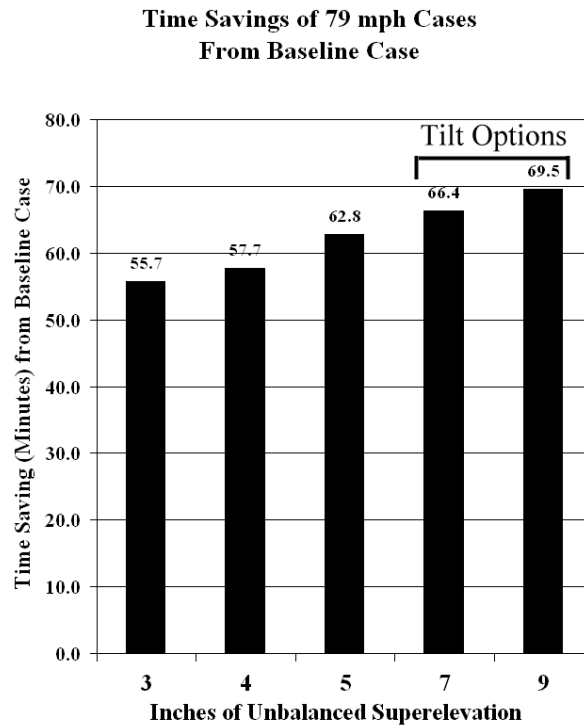

⁹ As explained in Summary Table B, this case is only hypothetical as standard Diesel-powered equipment in the U.S. will not safely operate at 9” of unbalance, because its center of gravity is too high. Other locomotives, now under development, might be certified for such operation.

**Table B-1
COMPARATIVE SIMULATED RUNNING TIMES—GROUP 1**

With Tilt Trainset Consist - 79 MPH MAS

Four Stops—No Diversions. Times Are in Hours : Minutes: Seconds, and Do Not Include Schedule Pad.

Varying levels of unbalanced superelevation (Eu) from Charlotte to Richmond

Case	Description	Segment: Charlotte to Raleigh			Segment: Raleigh to Richmond			Corridor Charlotte to Richmond		
		Segment TPC Timing	Improvement from Baseline	Improvement from Previous Time	Segment TPC Timing	Improvement from Baseline	Improvement from Previous Time	Corridor TPC Timing	Improvement from Baseline	Improvement from Previous Time
1(a)	P42DC-6-car Trainset, Existing Speeds - Baseline	3:07:27	n/a	n/a	2:36:05	n/a	n/a	5:43:32	n/a	n/a
1(b)	P42DC-6-car Trainset, 3" Eu - 79 mph	2:31:25	0:36:02	0:36:02	2:16:24	0:19:41	0:19:41	4:47:49	0:55:43	0:55:43
1(c)	P42DC-6-car Trainset, 4" Eu - 79 mph	2:31:01	0:36:26	0:00:24	2:14:50	0:21:15	0:01:34	4:45:51	0:57:41	0:01:58
1(d)	P42DC-6-car Trainset, 5" Eu - 79 mph	2:28:31	0:38:56	0:02:30	2:12:11	0:23:54	0:02:39	4:40:42	1:02:50	0:05:09
1(e)	P42DC-6-car Trainset, 7" Eu - 79 mph	2:27:06	0:40:21	0:01:25	2:10:05	0:26:00	0:02:06	4:37:11	1:06:21	0:03:31
1(g)	2-P42DC-6-car Trainset 7" Eu - 79 mph	2:25:57	0:41:30	0:01:09	2:08:22	0:27:43	0:01:43	4:34:19	1:09:13	0:02:52

Group 2: 90 mph Cases

Another set of TPC runs projected the time savings from an increase in MAS to 90 mph between Charlotte and Richmond. Seven inches of unbalanced superelevation, with tilting coaches, were assumed. The following conditions applied:

- The “Existing Optimized” alignment was assumed.
- MAS was increased to 90 mph; speeds on individual curves were calculated using a technique developed for this study.
- Positive stops and curve speeds were enforced.
- Spiral length and superelevation of curves were calculated using the curve spreadsheet.
- Tilt cut out under 45 mph and gradually ramped in to maximum at 60 mph;

- Four Intermediate stops: three-minute dwell at Raleigh, two-minute dwell at Greensboro, one-minute dwell at Durham and Petersburg.
- The 90 mph cases included two motive power assumptions:
 - Case 2(a) – one locomotive per train; and
 - Case 2(b) – two locomotives per train.

As shown in Table B-2, the Group 2 cases save over 83 minutes from the baseline timing (case 1(a)), and at least 17 minutes from the comparable 79 mph timing (case 1(b)). With the achievement of 90 mph service, the Charlotte–Richmond timing begins to approach the States’ travel time goal, although a 4-hour, 20-minute TPC result—requiring a flawless run—does not provide the pad necessary for reliable service. Figure B-1 plots the time/distance curve for Case 2(a).

**Table B-2
COMPARATIVE SIMULATED RUNNING TIMES—GROUP 2
With Tilt Trainset Consist - 90 MPH MAS**

Four Stops—No Diversions. Times Are in Hours : Minutes: Seconds, and Do Not Include Schedule Pad

Case	Description	Segment: Charlotte to Raleigh			Segment: Raleigh to Richmond			Corridor Charlotte to Richmond		
		Segment TPC Timing	Improvement from Baseline	Improvement from Previous Time	Segment TPC Timing	Improvement from Baseline	Improvement from Previous Time	Corridor TPC Timing	Improvement from Baseline	Improvement from Previous Time
1(a)	P42DC-6-car Trainset Existing Speeds - Baseline	3:07:27	n/a	n/a	2:36:05	n/a	n/a	5:43:32	n/a	n/a
1(e)	P42DC-6-car Trainset 7" Eu - 79 mph	2:27:06	0:40:21	0:40:21	2:10:05	0:26:00	0:26:00	4:37:11	1:06:21	1:06:21
2(a)	P42DC-6-car Trainset 7" Eu 90 mph	2:17:15	0:50:12	0:09:51	2:02:50	0:33:15	0:07:15	4:20:05	1:23:27	0:17:06
2(b)	2-P42DC-6-car Trainset 7" Eu - 90 mph	2:12:33	0:54:54	0:04:42	1:58:56	0:37:09	0:03:54	4:11:29	1:32:03	0:08:36

Group 3: Initial 110 mph Cases

Another set of TPC runs to determine the amount of time savings to be experienced after increasing MAS to 110 mph between Charlotte and Richmond was performed. Consists of one and two Diesel locomotives were assumed for comparative

Figure B-1: Charlotte to Raleigh, NC -
90-mph. MAS and 7" Eu -
One P42DC Engine + 6 Tilt-Body Cars—Case 2(a)

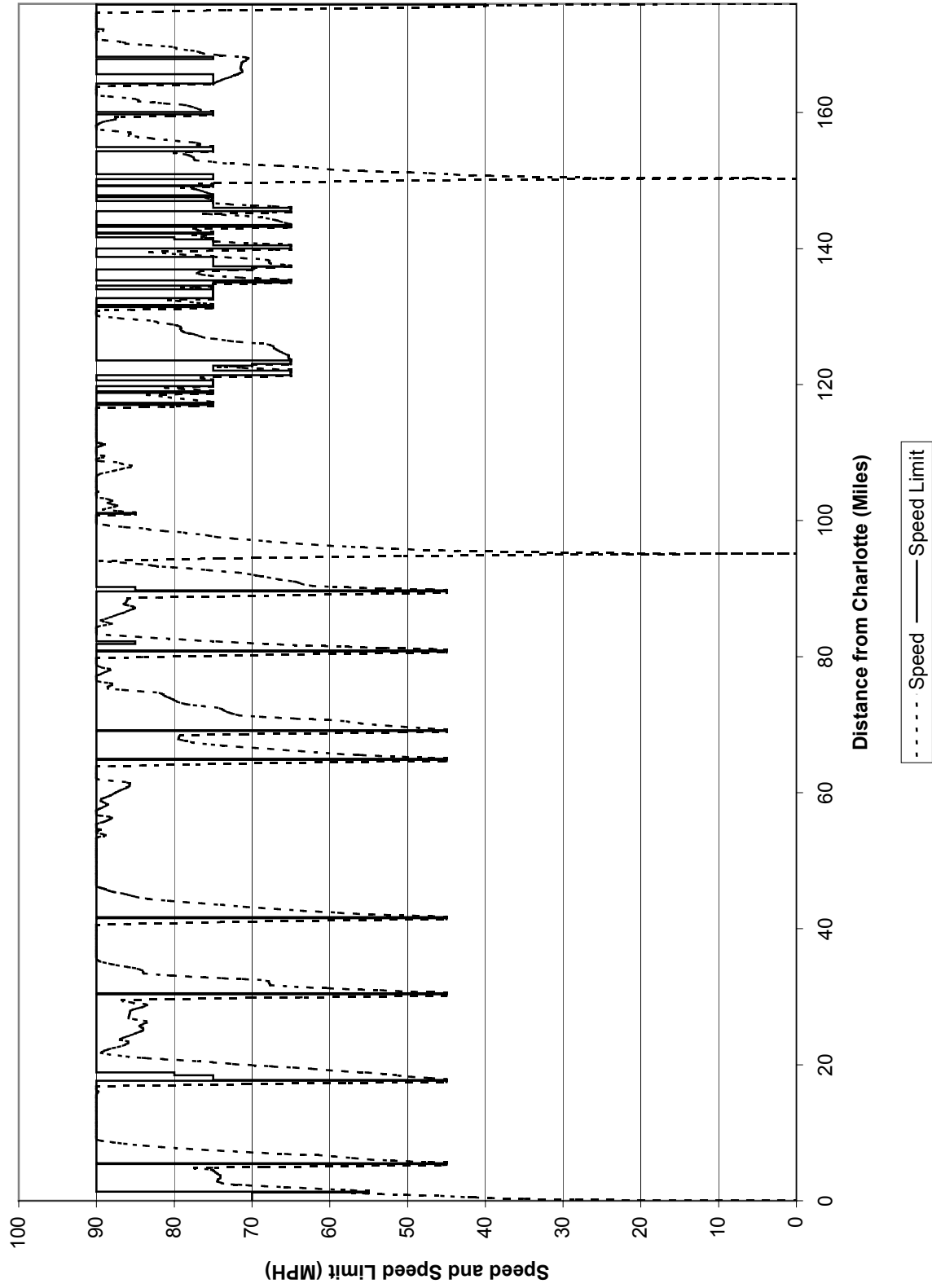

purposes. Also, special analyses were done of diversions on the P Line between Charlotte and Greensboro, as explained below.

The runs determined the time savings resulting from an increase from a 79 mph MAS to a 110 mph MAS for the assumed conditions. The following conditions were used:

- The “Existing Optimized” alignment was assumed.
- MAS was increased to 110 mph; speeds on individual curves were calculated using a technique developed for this study.
- Positive stops and curve speeds were enforced.
- Spiral length and superelevation of curves were calculated using the curve spreadsheet.
- Tilt cut out under 45 mph and gradually ramped in to maximum at 60 mph;
- Four intermediate stops: three-minute dwell at Raleigh, two-minute dwell at Greensboro, one-minute dwell at Durham and Petersburg.
- Speeds were set assuming levels of unbalanced superelevation of from three to nine inches. The last-named level is only hypothetical as standard Diesel-powered equipment in the U.S. will not safely operate at 9 inches of unbalance. Other locomotives, now under development, might be certified for such operation.

As shown in Table B-3, the increase in top speed from 79 to 110 mph (with three-inch unbalance and one locomotive in both cases, 1(b) and 3(a)) yields a time reduction of just under 11 minutes. Beyond that improvement, the use of tilting equipment at a maximum seven inches of unbalance would save over ten minutes more (compare cases 3(c) and 3(d)).

Effects of Adding a Second Locomotive

Vertical elevation has as significant an impact on trip times in the Charlotte to Richmond Corridor as horizontal alignment. Horizontal curvature previously is discussed in Appendix A. The impact of vertical gradient on trip times is illustrated in Figure B-2, which compares Cases 3(d) and 3(f).¹⁰ In the segment excerpted, one P-42 locomotive with six tilt-capable coaches operating at an MAS of 110 mph (assuming seven inches of unbalanced superelevation in numerous locations) never attains 110 mph, even though it appears that sufficient distance is available for the train to accelerate from the lower speed zone to 110 mph. One example is the track segment

¹⁰ In Figure B-2, the vertical scale has been modified from the normal display in which speed on the vertical scale is uniform, to a proportional scale in which the area under the curve created by the plot is equal to time. Since the scale between 0 and 50 mph would dominate the display and the distance traveled at speeds in that range is minimal, that speed range is normally not plotted.

**Table B-3
COMPARATIVE SIMULATED RUNNING TIMES—GROUP 3
With Tilt Trainset Consist - 110 MPH MAS**

**Four Stops—No Diversions. Times Are in Hours : Minutes : Seconds, and Do Not Include Schedule Pad.
Varying levels of unbalanced superelevation from Charlotte to Richmond**

Case	Description	Segment: Charlotte to Raleigh			Segment: Raleigh to Richmond			Corridor Charlotte to Richmond		
		Segment TPC Timing	Improvement From Baseline	Improvement from Previous Time	Segment TPC Timing	Improvement From Baseline	Improvement from Previous Time	Corridor TPC Timing	Improvement From Baseline	Improvement from Previous Time
1(a)	P42DC-6-car Trainset Existing Speeds Baseline	3:07:27	n/a	n/a	2:36:05	n/a	n/a	5:43:32	n/a	n/a
1(b)	P42DC-6-car Trainset 3" Eu - 79 mph	2:31:25	0:36:02	0:36:02	2:16:24	0:19:41	0:19:41	4:47:49	0:55:43	0:55:43
3(a)	P42DC-6-car Trainset 3" Eu - 110 mph	2:24:18	0:43:09	0:07:07	2:12:34	0:23:31	0:23:31	4:36:52	1:06:40	0:10:57
3(b)	P42DC-6-car Trainset 4" Eu - 110 mph	2:23:36	0:43:51	0:00:42	2:10:00	0:26:05	0:02:34	4:33:36	1:09:56	0:03:16
3(c)	P42DC-6-car Trainset 5" Eu - 110 mph	2:18:37	0:48:50	0:04:59	2:05:53	0:30:12	0:04:07	4:24:30	1:19:02	0:09:06
3(d)	P42DC-6-car Trainset 7" Eu - 110 mph	2:13:04	0:54:23	0:05:33	2:00:35	0:35:30	0:05:18	4:13:39	1:29:53	0:10:51
3(e)	P42DC-6-car Trainset 9" Eu - 110 mph ¹¹	2:09:24	0:58:03	0:03:40	1:56:06	0:39:59	0:04:29	4:05:30	1:38:02	0:08:09
3(f)	2-P42DC-6-car Trainset 7" Eu - 110 mph	2:03:36	1:03:51	0:05:48	1:54:22	0:41:43	0:01:44	3:57:58	1:45:34	0:07:32
3(g)	2-P42DC-6-car Trainset 7" Eu - 110 mph. Diverging Moves, Charlotte–Greensboro	2:14:33	0:52:54	(00:10:57)	1:54:22	0:41:43	0:00:00	4:08:54	1:34:37	(00:10:57)

¹¹ This case is only hypothetical as standard Diesel-powered equipment in the U.S. will not safely operate at 9" of unbalance. Other locomotives, now under development, might be certified for such operation.

Figure B-2: Cases 3(d) and 3(f)—Effect of Adding Second P42 Locomotive Greensboro to Raleigh for Example - 110-MPH MAS, Tilt, and 7 Inches of Unbalance

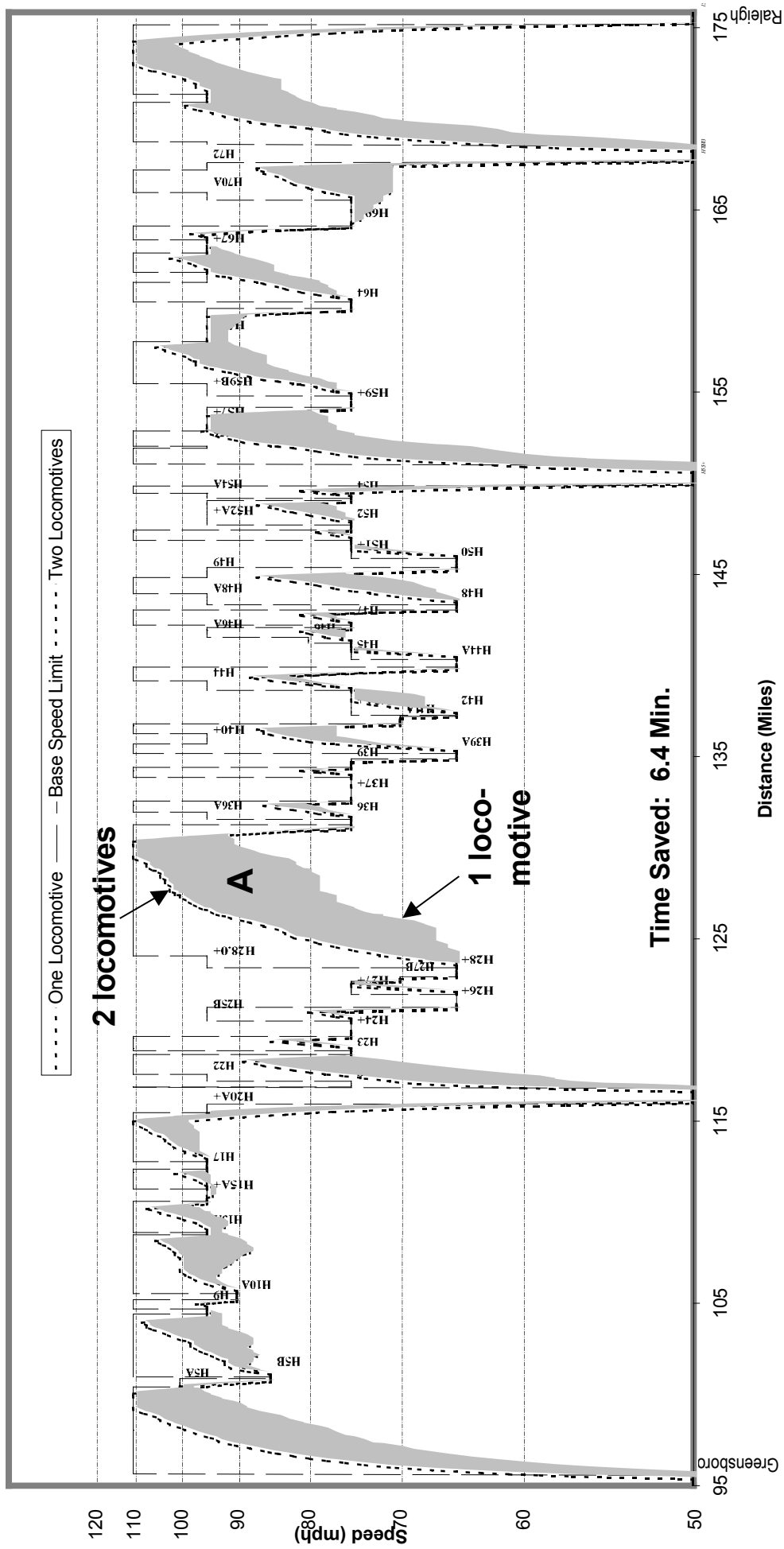

between Burlington (H21.3) and Mebane (H32.6). The controlling grade between Greensboro and Goldsboro (+1.02%) is located between H28 and H29. This is a portion of the approximately 6.5 mile grade between H27.6 and H 34.2. Heading northward towards Mebane, a train after slowing for the two 65 mph 4 degree curves (Curves H28 and H28.1¹²) located at the bottom of the grade, the train with one locomotive never reaches 110 mph in the 10-mile stretch before having to brake for the 3.0-degree curves - H37, H38, H38.1, and H38.2. Several long grades actually serve to reduce train speed in numerous stretches of railroad in which horizontal curvature would permit continuous 110 mph MAS. The difference between the respective performances of the one- and two-locomotive consists becomes evident at grey area “A” on Figure B-2, where the two-locomotive train actually achieves 110 mph for almost a full mile, despite being somewhat restricted by grade. The other, analogous grey areas on the chart show the many locations where the performance of two locomotives makes a perceptible difference: these differentials cumulatively give the two-locomotive consist a 6.4 minute advantage in the Greensboro–Raleigh segment depicted in Figure B-2, and a 15.7 minute advantage over the entire Corridor

The addition of a second locomotive to each trainset would push the differential between 79 mph and 110 mph¹³ to just under 50 minutes and, as described in Chapter 4,¹⁴ would materially improve the corridor’s ability to approach the States’ travel time goals.

Effects of Diversion Assumptions, Charlotte–Greensboro (P Line)

The design of the P Line between Charlotte and Greensboro has direct implications for train performance as revealed in TPC runs. Although originally double-tracked, the line has, in recent decades, been reduced to single track status at four separate locations totaling 35 miles, as described in Chapter 2. Depending on the site-specific design of the turnouts at the transitions between single and double track, a single train may be forced to make multiple diverging moves between Charlotte and Greensboro even in the absence of interference from other traffic—simply because of the layout of the track in this segment.

While most of the TPC cases assumed that continuous double track would be restored all the way from Charlotte to Greensboro, it was also necessary to explore the consequences of retaining the single-track stretches and the resultant diverging moves.

Thus, a set of TPC runs was performed to determine the amount of time loss (or savings) to be experienced if a trainset makes (or does not make) a diverging move at

¹²Curves are numbered consecutively within each mile, i.e., the first curve between MP H28 and MP H 29 is curve H28, and the second curve is H28.1.

¹³ I.e., between Cases 1(b) and 3(f).

¹⁴ See 4-2, 110 mph, two locomotives, existing optimized alignment. Under these assumptions, however, the pad is still insufficient to fully meet the trip time goals, as Chapter 4 makes clear.

45 mph with MAS set at 79 mph and after the MAS has been increased to 110 mph. The trip times assumed that the trains would brake so that speed was reduced to 45 mph prior to entering the interlocking at each single-track-to-double-track junction. The trains were then assumed to accelerate to maximum allowable speed or MAS after the train cleared the interlocking. The following conditions were used:

- MAS was set at either 79 mph or increased to 110 mph; speeds on individual curves were calculated using a technique developed for this study.
- As in the Baseline case, positive stops and curve speeds were enforced.
- Spiral length and superelevation of curves calculated with the spreadsheet were assumed.
- Tilt cut out under 45 mph and gradually ramped in to maximum at 60 mph;
- Intermediate stops at Kannapolis, Salisbury, and High Point were assumed.
- Speeds were set assuming five levels of unbalanced superelevation, ranging from three to nine inches.
- Diversion moves at the following single - double track junction locations were simulated
 - Junker;
 - Haydock;
 - North Kannapolis
 - Reid;
 - Lake;
 - Bowers;
 - Hoskins; and
 - Cox.

Case 3(g) incorporates the results of these analyses. In comparison with case 3(f), Case 3(g) would result in a loss of about 11 minutes of travel time between Charlotte and Greensboro, before taking into account the congestion effects of adding high-speed rail to a partially single-track P Line.

Group 4: Sensitivity Cases—Special Motive Power Options

The study team explored additional motive-power-related options for providing travel time improvements short of major fixed plant modifications. Table B-4 describes two of these attempts: 4(a), which takes hotel power generation responsibilities away from the locomotive and assigns them to a separate generator in one of the coaches; and 4(b), which assumes a third locomotive added to each consist.

Table B-4
COMPARATIVE SIMULATED RUNNING TIMES—GROUP 4
With Tilt Trainset Consist - 110 MPH MAS

Four Stops—No Diversions. Times Are in Hours : Minutes : Seconds, and Do Not Include Schedule Pad.
Tilt operation and seven inches of unbalanced superelevation, Charlotte to Richmond
Assessment of performance gains from separate hotel (“head-end”) power source, or three locomotives

Case	Description	Segment: Charlotte to Raleigh			Segment: Raleigh to Richmond			Corridor Charlotte to Richmond		
		Segment TPC Timing	Improvement From Baseline	Improvement from Previous Time	Segment TPC Timing	Improvement From Baseline	Improvement from Previous Time	Corridor TPC Timing	Improvement From Baseline	Improvement from Previous Time
1(a)	P42DC-6-car Trainset Existing Speeds Baseline	3:07:27	n/a	n/a	2:36:05	n/a	n/a	5:43:32	n/a	n/a
3(f)	2-P42DC-6-car Trainset 7" Eu - 110 mph	2:03:36	1:03:51	0:05:48	1:54:22	0:41:43	0:01:44	3:57:58	1:45:34	0:07:32
4(a)	2-P42DC-6-car Trainset 7" Eu - 110 mph – Hotel Power Provided by Separate Source	2:02:30	1:04:57	0:01:06	1:53:35	0:42:30	0:02:31	3:56:05	1:47:27	0:01:53
4(b)	3-P42DC (Hotel power from 1-locomotive) -6-car Trainset 7" Eu – 110 mph	2:01:18	1:06:09	0:01:12	1:52:50	0:43:15	0:01:32	3:54:08	1:49:24	0:01:57

The incremental benefits of these options were minuscule, in comparison with the 105.6-minute savings already estimated for Case 3(f) from the baseline (1a) timing. Moving the hotel power generation from one of the locomotives to a coach would reduce another 1.9 minutes from the travel time, for an incremental savings of only 1.8 percent. This relatively small trip time improvement must come into comparison with the potential loss of revenue space on every train, and the higher maintenance expenses likely to result from adding locomotive-like components to at least one car per trainset.

Similarly, the 2.0-minute (1.8 percent) trip time reduction from assigning a third locomotive to every train would need to be weighed against the added capital, operating, and maintenance costs to support such power-heavy consists.

Subject to the results of future economic studies, the available evidence suggests that these additional motive power options—while well worth the analytical try—would not be cost-effective. They were, therefore, dropped from further consideration in this study.

Groups 5 and 6: Experiments with Minimal MASs

Applying a minimum speed is a means of testing the possible benefits of eliminating the physical constraints that cause a train to reduce speed and accelerate at intermediate points between stations. Frequently it can be more cost effective to make improvements to eliminate such restrictions than it is to raise the overall maximum speed. This is particularly true where fossil-fueled locomotives are employed, because of their lower rates of acceleration.

To test this principle on the Richmond–Charlotte Corridor, the study team conducted two sets of TPC runs. The first set, Group 5, applied various minimum MAS to the entire Corridor, in five-mph increments beginning at 80 mph. Two locomotives, a 110-mph MAS ceiling, and tilting coaches at seven inches of unbalance were assumed. The Group 5 results appear in Table B-5.

When it became apparent that providing for a minimal MAS of 80 mph or more throughout the Corridor would be require too intensive and environmentally controversial an investment, the study team performed a second set of runs (Group 6) applying minimal MASs to the H Line only (Raleigh–Greensboro). Conditions specific to Group 6 were as follows:

- MAS was assumed to be 95 mph between Charlotte and Greensboro; and speeds on individual curves were calculated using a technique developed for this study.
- MAS was assumed to be 95 mph between Raleigh and the south end of curve 103; and speeds on individual curves were calculated using a technique developed for this study.
- MAS was assumed to be 75 mph between the south end of curve 103 and the north end of Curve 56; and speeds on individual curves were calculated using a technique developed for this study.
- MAS was assumed to be 95 mph between the north end of Curve 56 and Centralia; and speeds on individual curves were calculated using a technique developed for this study.
- MAS was assumed to be 95 mph between Centralia and Main Street Station; and speeds on individual curves were calculated using a technique developed for this study.
- As in the Baseline case, positive stops and curve speeds were enforced.
- Spiral length and superelevation of curves calculated using the spreadsheet were assumed.

**Table B-5
COMPARATIVE SIMULATED RUNNING TIMES—GROUP 5
With Tilt Trainset Consist - 110 MPH MAS**

**Four Stops—No Diversions. Times Are in Hours : Minutes : Seconds, and Do Not Include Schedule Pad.
Tilt operation and seven inches of unbalanced superelevation, Charlotte to Richmond
Varying levels of Minimal MAS from Charlotte to Richmond**

Case	Description	Segment: Charlotte to Raleigh			Segment: Raleigh to Richmond			Corridor Charlotte to Richmond		
		Segment TPC Timing	Improvement From Baseline	Improvement from Previous Time	Segment TPC Timing	Improvement From Baseline	Improvement from Previous Time	Corridor TPC Timing	Improvement From Baseline	Improvement from Previous Time
1(a)	P42DC-6-car Trainset Existing Speeds Baseline	3:07:27	n/a	n/a	2:36:05	n/a	n/a	5:43:32	n/a	n/a
3(f)	2-P42DC-6-car Trainset 7" Eu - 110 mph	2:03:36	1:03:51	1:03:51	1:54:22	0:41:43	0:41:43	3:57:58	1:45:34	1:45:34
5(a)	2-P42DC-6-car Trainset 7" Eu - Floor = 80 mph	2:00:43	1:06:44	0:02:53	1:50:06	0:45:59	0:04:16	3:50:49	1:52:43	0:07:09
5(b)	2-P42DC-6-car Trainset 7" Eu - Floor = 85 mph	1:59:04	1:08:23	0:01:39	1:48:14	0:47:51	0:01:52	3:47:18	1:56:14	0:03:31
5(c)	2-P42DC-6-car Trainset 7" Eu - Floor = 90 mph	1:57:26	1:10:01	0:01:38	1:46:15	0:49:50	0:01:59	3:43:41	1:59:51	0:03:37
5(d)	2-P42DC-6-car Trainset 7" Eu - Floor = 95 mph	1:56:07	1:11:20	0:01:19	1:43:55	0:52:10	0:02:20	3:40:02	2:03:30	0:03:39
5(e)	2-P42DC-6-car Trainset 7" Eu - Floor = 100 mph	1:52:54	1:14:33	0:03:13	1:40:53	0:55:12	0:03:02	3:33:47	2:09:45	0:06:15
5(f)	2-P42DC-6-car Trainset 7" Eu - Floor = 105 mph	1:50:09	1:17:18	0:02:45	1:38:15	0:57:50	0:02:38	3:28:24	2:15:08	0:05:23

- Tilt cut out under 45 mph and gradually ramped in to maximum at 60 mph;
- Four intermediate stops: three-minute dwell at Raleigh, two-minute dwell at Greensboro, one-minute dwell at Durham and Petersburg.
- Speeds were set assuming seven inches of unbalanced superelevation.

The results for Group 6 appear in Table B-6. With respect to the H Line segment of the Corridor, the study team again concluded that it would not be practical to establish an MAS floor and that a more nuanced examination of individual speed-restricted areas would likely yield more useful results. This conclusion influenced the design of subsequent cases.

**Table B-6
COMPARATIVE SIMULATED RUNNING TIMES—GROUP 6
With Tilt Trainset Consist – 110 MPH MAS**

**Four Stops—No Diversions. Times Are in Hours : Minutes : Seconds, and Do Not Include Schedule Pad.
Tilt operation and seven inches of unbalanced superelevation, Charlotte to Richmond
Varying levels of Minimal MAS from Greensboro to Raleigh**

Case	Description	Segment: Charlotte to Raleigh			Segment: Raleigh to Richmond			Corridor Charlotte to Richmond		
		Segment TPC Timing	Improvement From Baseline	Improvement from Previous Time	Segment TPC Timing	Improvement From Baseline	Improvement from Previous Time	Corridor TPC Timing	Improvement From Baseline	Improvement from Previous Time
1(a)	P42DC-6-car Trainset Existing Speeds Baseline	3:07:27	n/a	n/a	2:36:05	n/a	n/a	5:43:32	n/a	n/a
3(f)	2-P42DC-6-car Trainset 7" Eu - 110 mph	2:03:36	1:03:51	1:03:51	1:54:22	0:41:43	0:41:43	3:57:58	1:45:34	1:45:34
6(a)	2-P42DC-6-car Trainset 7" Eu – Floor = 80 mph	1:59:25	1:08:02	0:04:11	1:48:13	0:47:52	0:06:09	3:47:38	1:55:54	0:10:20
6(b)	2-P42DC-6-car Trainset 7" Eu – Floor = 85 mph	1:58:06	1:09:21	0:01:19	1:48:13	0:47:52	0:00:00	3:46:19	1:57:13	0:01:19
6(c)	2-P42DC-6-car Trainset 7" Eu – Floor = 90 mph	1:56:59	1:10:28	0:01:07	1:48:13	0:47:52	0:00:00	3:45:12	1:58:20	0:01:07
6(d)	2-P42DC-6-car Trainset 7" Eu – Floor = 95 mph	1:56:07	1:11:20	0:00:52	1:48:13	0:47:52	0:00:00	3:44:20	1:59:12	0:00:52

Group 7: Simulations Based on Detailed Analysis of Curve Speeds

Since establishing an 80 mph MAS floor between Raleigh and Greensboro did not prove to be an optimal solution, an analysis of individual restricted locations between Greensboro, Raleigh, and Richmond was undertaken to maximize trip time while minimizing investment in realignments and relocations. The analysis, described in

Appendix A, required several revisions. The trip times resulting from the analysis are contained in Table B-7.

Table B-7
COMPARATIVE SIMULATED RUNNING TIMES—GROUP 7
With Tilt Trainset Consist - 110 MPH MAS

Four Stops—No Diversions. Times Are in Hours : Minutes : Seconds, and Do Not Include Schedule Pad.
Tilt operation and seven inches of unbalanced superelevation, Charlotte to Richmond
Curve Speeds Between Greensboro and Richmond Reevaluated to Maximize Speed, Minimize Cost

Case	Description	Segment: Charlotte to Raleigh			Segment: Raleigh to Richmond			Corridor Charlotte to Richmond		
		Segment TPC Timing	Improvement From Baseline	Improvement from Previous Time	Segment TPC Timing	Improvement From Baseline	Improvement from Previous Time	Corridor TPC Timing	Improvement From Baseline	Improvement from Previous Time
1(a)	P42DC-6-car Trainset Existing Speeds Baseline	3:07:27	n/a	n/a	2:36:05	n/a	n/a	5:43:32	n/a	n/a
3(f)	2-P42DC-6-car Trainset 7" Eu - 110 mph	2:03:36	1:03:51	0:15:01	1:54:22	0:41:43	0:06:13	3:57:58	1:45:34	0:15:41
7(a)	2-P42DC-6-car Trainset 7" Eu 110 mph Optimize Greensboro to Richmond	1:58:28	1:08:59	0:05:08	1:48:34	0:47:31	0:05:48	3:47:02	1:56:30	0:10:56
7(b)	2-GT42AC -6-car Trainset 7" Eu - 110 mph Optimize Greensboro to Raleigh	1:56:48	1:10:39	0:01:40	1:47:24	0:48:41	0:01:10	3:44:12	1:59:20	0:02:50

A four-stop northbound trip time of three hours 47 minutes was established (Case 7(a)). Interestingly, the Group 7 curve revisions resulted in the southbound trip time becoming the controlling element—a reversal of the baseline result.¹⁵ The southbound trip time was approximately three hours and 48 minutes.

As simulated in case 7(b), the use of gas turbine propulsion units would result in a northbound trip time of three hours and 44 minutes and a southbound trip time of three hours and 45 minutes.

¹⁵ See the discussion of train direction on page B-5.

Group 8: With the Contemplated Improvements

The initial manual curve revisions underlying the Group 7 TPC cases identified numerous locations requiring further analysis. This final, detailed manual analysis of individual curves and clusters of curves was based on a review of the results of all the preceding cases and also drew upon problems, such as short tangents between curves and potential environmental issues, identified by the study team. The results of the analysis, incorporating the “Contemplated Improvements” that form the main subject of this report, are summarized in Table B-8.

**Table B-8
COMPARATIVE SIMULATED RUNNING TIMES—GROUP 8
With Tilt Trainset Consist - 110 MPH MAS**

**Four Stops—No Diversions. Times Are in Hours : Minutes : Seconds, and Do Not Include Schedule Pad.
Tilt operation and seven inches of unbalanced superelevation, Charlotte to Richmond
Cases With the Contemplated Improvements and Varying Stopping Patterns**

Case	Description	Segment: Charlotte to Raleigh			Segment: Raleigh to Richmond			Corridor Charlotte to Richmond		
		Segment TPC Timing	Improve-ment From Baseline	Improve-ment from Previous Time	Segment TPC Timing	Improve-ment From Baseline	Improve-ment from Previous Time	Corridor TPC Timing	Improve-ment From Baseline	Improve-ment from Previous Time
1(a)	P42DC-6-car Trainset Existing Speeds Baseline	3:07:27	n/a	n/a	2:36:05	n/a	n/a	5:43:32	n/a	n/a
7(a)	2-P42DC-6-car Trainset 7" Eu 110 mph Optimize Greensboro to Richmond	1:58:28	1:08:59	1:08:59	1:48:34	0:47:31	0:47:31	3:47:02	1:56:30	1:56:30
8(a)	2P42DC-6-car Trainset 7" Eu - 110 mph. Revised Manual Curve Analysis. With Contemplated Improvements. Four Stops.	2:02:50	1:04:37	(0:04:22)	1:48:06	0:47:59	0:00:28	3:50:56	1:52:36	(00:03:54)
8(b)	2P42DC-6-car Trainset 7" Eu - 110 mph. With Contemplated Improvements. Five Stops	2:05:10	1:02:17	(00:02:20)	1:48:07	0:47:58	(00:00:01)	3:53:17	1:50:15	(00:02:21)
8(c)	2P42DC-6-car Trainset 7" Eu - 110 mph. With Contemplated Improvements. Six Stops	2:05:10	1:02:17	(00:00:00)	1:50:30	0:45:35	(00:02:23)	3:55:40	1:47:52	(00:02:23)

With the contemplated improvements in place, analysis concluded that the optimal trip time northbound between Charlotte and Richmond was three hours and 51 minutes with four intermediate station stops.

The analysis indicated that the addition of a fifth stop at an I-485 Beltway Station north of Charlotte would increase the trip time by approximately 2.5 minutes to three hours and 53 minutes. The analysis concluded that the addition of a sixth stop at Henderson, North Carolina on certain trains would increase the trip time by an additional 2.5 minutes to approximately three hours and 56 minutes.

Although not directly affecting the Richmond–Charlotte downtown-to-downtown travel times, the addition of a station south of Charlotte, at Charlotte Airport, also was studied. The station would be located about 5.4 miles south of the new Charlotte downtown rail passenger station. The study team assumed that southbound trains whose schedule would be extended to Charlotte Airport Station, would have a three-minute dwell at Charlotte. The trip to the airport station would take approximately 10 minutes.

Group 9: Sensitivity Cases—Train Length

The cases in Groups 3 and 4 explored the effects of varying the motive power arrangements on each train over the “existing alignment optimized”; Group 9, likewise, analyzes the effects of varying the number of coaches per train. While Group 9, too, assumed the existing alignment optimized, the results are applicable to a system based on the contemplated improvements as well. Table B-9 summarizes the Group 9 results.

As shown in Table B-9, each pair of cars added to the standard six-car train adds approximately three to four minutes to the TPC timings. On the other hand, reducing the train lengths from six to four coaches saves about 5½ minutes between Charlotte and Richmond. While this latter time savings is attractive, it is more likely to be theoretical than practicable, as operating timetables must be based on the longest regularly-operated trains if service reliability is to be maintained throughout the year. Further detailed demand, cost, and operational studies would be required to assess whether a change from the assumed six-car consist would accord with the long-term economics of the service, when equipment investments, operating and maintenance expenses, supportable frequencies, ridership, and revenues are all taken into account.

Group 10: Effect of Adding Intermediate Station Stops

As reported in Table B-10, additional TPC runs analyzed the effects of adding specific station stops to the schedule under various assumptions for MAS and unbalanced superelevation.

Table B-9

COMPARATIVE SIMULATED RUNNING TIMES—110 MPH MAS—GROUP 9

Four Stops—No Diversions. Times Are in Hours : Minutes : Seconds, and Do Not Include Schedule Pad.

Tilt operation and seven inches of unbalanced superelevation, Charlotte to Richmond

Effects of Train Length on Performance

Case	Description	Segment: Charlotte to Raleigh			Segment: Raleigh to Richmond			Corridor Charlotte to Richmond		
		Segment TPC Timing	Improvement From Case 3(f)	Improvement from Previous Time	Segment TPC Timing	Improvement From Case 3(f)	Improvement from Previous Time	Corridor TPC Timing	Improvement From Case 3(f)	Improvement from Previous Time
1(a)	P42DC-6-car Trainset Existing Speeds Baseline	3:07:27	n/a	n/a	2:36:05	n/a	n/a	5:43:32	n/a	n/a
3(f)	2-P42DC-6-car Trainset 7" Eu - 110 mph	2:03:36	n/a	1:03:51	1:54:22	n/a	0:41:43	3:57:58	n/a	1:45:34
9(a)	P42DC- 4-car Trainset 7" Eu 110 mph	2:00:19	0:03:17	0:03:17	1:52:13	0:02:09	0:02:09	3:52:32	0:05:26	0:05:26
9(b)	2 P42DC- 8-car Trainset 7" - 110 mph	2:04:52	(0:01:16)	(0:04:33)	1:55:50	(0:01:28)	(0:03:37)	4:00:42	(0:02:44)	(0:08:10)
9(c)	2 P42DC-10-car Trainset 7" Eu - 110	2:07:11	(0:03:35)	(0:02:19)	1:57:36	(0:03:14)	(0:01:46)	4:04:47	(0:06:49)	(0:04:05)
9(d)	2-P42DC-12-car Trainset 7" Eu - 110 mph	2:09:45	(0:06:09)	(0:02:34)	1:59:43	(0:05:21)	(0:02:07)	4:09:28	(0:11:30)	(0:04:41)

The following conditions were used in these station stop analyses:

- MAS was set at 79 mph or increased to 110 mph; speeds on individual curves were calculated using a technique developed for this study.
- As in the Baseline case, positive stops and curve speeds were enforced.
- Spiral length and superelevation of curves calculated using the spreadsheet were assumed.
- Tilt cut out under 45 mph and gradually ramped in to maximum at 60 mph.

Table B-10		
Allowances for Intermediate Station Stops		
Unbalanced superelevation 7 inches		
Time Allowance		
Station (See Note)	79 mph MAS	110 mph MAS
I-485‡	n/a	0:02:21
Kannapolis	0:02:39	0:02:19
Salisbury	0:02:56	0:03:29
High Point	0:02:32	0:03:09
Greensboro*	0:03:56	0:04:42
Burlington	0:02:47	0:02:57
Durham*	0:02:41	0:02:49
Cary	0:02:43	0:02:59
Raleigh*	0:03:57	0:03:57
Henderson	0:02:54	0:03:23
Petersburg*	0:02:41	0:03:09

Note: Appendix F shows how all these locations are assumed to receive improved service (by different types of corridor trains) as part of the transportation plan. This table simply estimates the time allowance that the timetables should associate with corridor trains that stop at each place.

* Asterisks indicate station stops already assumed in the four-stop schedule. For these stations, the allowance timings shown in this table are for the sake of completeness only.

‡ I-485 would be included in the assumed five-stop schedule. See Appendix F.

In general, at the 110 mph MAS, each additional station stop would add from two to four minutes to the projected schedule. The time penalty for a specific stop would depend (a) on the train speed that the track geometry would permit were the stop omitted, (b) and on the projected passenger volumes at the station. At most stations, depending on site-specific details, the allowances for added stops would decrease if the MAS were held to 79 mph.

Synthesis and Conclusions

Recap of the Analysis

Various options to reduce trip time were systematically evaluated; the relative benefits of each, in terms of time saved, were determined. A great variation in benefits and costs in the range of alternatives evaluated was identified. Some of the options created significant benefits at relatively low costs. Other options resulted in relatively minor benefits at relatively high costs. The following description provides an indication of the projected benefits of the options considered.

Several scenarios, each with several options, were examined. The most basic scenario, optimizing the existing alignment, gave the largest increment of improvement. Each scenario initially was based on a 4-stop run between Charlotte and Richmond. Adjusting superelevation and spiral length to optimize the speed through curves, while upgrading the track and signal system, resulted in a 16 percent reduction in trip time with a conventional Amtrak-type train at a maximum authorized speed (MAS) of 79 mph. Increasing superelevation and unbalance, raising the MAS, substituting tilting equipment, and increasing horsepower produced a noticeable improvement, but did not suffice to reliably meet the trip time goals. For that purpose, sufficient additional time saving can only be obtained through a combination of more costly improvements.

The trip time between two points is affected by numerous considerations. For this analysis the primary factors evaluated included:

- The assumed maximum authorized speed (MAS), whether it be 79, 90, or 110 mph,
- The amount of unbalanced superelevation, and
- The speed to be achieved on specific curves.

Additional factors affecting trip time include:

- The number of stops and the dwell time for each stop,
- The assumed method of enforcing speed restrictions,
- The train consist operated,
- The number of coaches, and whether the coaches are tilting or non-tilting,
- The type of locomotive and its characteristics,
- The spacing of signals,
- The speed capability of switches at the locations where mandatory train diversions are required (e.g., on the P Line, at junctions between single- and double-track segments),
- The location and number of non-rail related civil speed restrictions; and

- A variety of lesser factors.

The influence of these latter factors is normally minimized through the consistent application of assumed operating conditions for each TPC run. The assumptions relative to each TPC run are described in the body of the text.

A critical factor to the successful implementation of incremental high-speed rail service operated in a mixed-mode environment is **Ride Comfort**, as experienced and perceived by the passenger. The analyses performed to establish the maximum speed for each curve, which are described in Appendix A, included consideration of factors that serve to theoretically optimize ride comfort.

Whether the trip time goal is reliably met is determined by additional factors, most importantly the capacity of the rail line to adequately handle the levels of intercity passenger, freight, and commuter trains, if applicable, that are projected to be operated. Capacity considerations were not addressed in this part of the analysis. They were evaluated by means of a separate set of operations simulations, which are described in Appendix C. **For this analysis capacity is not a factor. A TPC run only assesses the time required to move a train over the railroad, and the varying speeds it is able to maintain en route.**

When considering run times it is important to realize that actual scheduled run times between two points will be longer than TPC-projected trip times. **Additional time must be added to projected trip times to accommodate the uncertainties (realities) of everyday operation. This difference is compensated for by “pad.”** The trip times referred to thus far in this Appendix reflect perfect runs under ideal conditions and do not include pad. However, pad must be considered in evaluating whether a given TPC-simulated time would, in practical terms, meet a trip time goal on a reliable basis. This method of comparison is the subject of the following section.

Analyzing Trip Time Attainment Using Pad

The basic performance of any train set (cars and locomotive[s]) over a given route, and for a defined stopping pattern, is computed using a Train Performance Calculator (TPC) that has been programmed and calibrated to produce an accurate computation of the train’s speed, energy consumption, and resulting schedule time **under ideal circumstances**. As this Appendix repeatedly points out, the TPC simulates the ideal operation of a single passenger train operating over a hypothetical, Charlotte to Richmond route configured and realigned to support high-speed passenger rail service. The TPC’s running time thus represents the optimal physical performance of the equipment and its operator, with the train running unencumbered by other trains on its route. These conditions obviously will not occur reliably for real, day-to-day operations, so further adjustments to the basic TPC running time must be made to reflect all the factors that will reduce performance, and increase running times, from the TPC optimum.

The process of analyzing optional alignment and configuration alternatives includes the use of pad to determine the likelihood that the trip time goal would be reliably attained. Richmond–Charlotte corridor alternatives were evaluated for their ability to provide TPC travel times that would be sufficiently better than the States’ desired times, so as to provide a pad that would allow for reasonably foreseeable operating contingencies.

The goal of adding “pad” to a train schedule is to produce a schedule that can be operated reliably, repetitively, and with a high degree of confidence. A reliable schedule is essential to satisfy the expectations of the riding public, which needs to know when it will arrive at a given station, and the by train operator, which needs to plan equipment cycles and service frequency. As direct Richmond-Raleigh-Charlotte express service over the contemplated route was not customary in the pre-Amtrak era, there is no historical performance data for rail service planners to draw upon for the Southeast Corridor high-speed service between Richmond and Charlotte. Therefore, schedule design standards and the results of train operations simulations performed for the study were used to estimate how much “pad” must be added to the optimum TPC running times to produce a reliable train schedule.

The FRA and Amtrak have historically used a seven percent planning schedule pad to evaluate train schedules for multiple-track high-speed corridors, and this pad was the starting point in the development of the schedule pad to be used to analyze train schedules for the Southeast Corridor between Richmond and Charlotte. The planning pad comprises three main components that account for:

- Inability to implement all recommended improvements,
- Operator/vehicle variability, and
- Rail system performance.

Accounting for Inability to Implement Improvements

The amount of pad built into the planning level analysis of a project provides allowance for likelihood that some of the recommended configuration and alignment improvements might not be implemented for physical, cost, environmental, or other public interest reasons.

Accounting for Operator/Vehicle/Operations Variability and Rail System Performance

The amount of pad also provides allowance for the reality that:

- Train operations are never precise, things just never go quite according to plan, station stops are slower, bad weather slows operations, equipment failures do occur, etc.,
- Vehicle performance is never uniform,

- Train operators do not consistently and instantaneously adhere to all changes in speeds along the route, and
- Trains incur small increments of delay en route, and overtake and meet other freight and passenger/commuter trains, while still maintaining a high probability of on-time performance.

Recognizing that typical day operations introduce periodic train delays and fluctuations in train speeds along the route, pad takes into account variables that occur in "typical" as opposed to "ideal day" operating conditions. Accounting for rail system performance may account for between 2 and 3 percent of the 7 percent pad.

Accounting for Anticipated Richmond to Charlotte Train Operations

Typical daily variations also include the likelihood that passenger trains would have to divert from one track to a second track to avoid slower moving trains, or divert to a siding in single-track segments to enable a passenger train in the opposing direction to pass. The likelihood of train diversions and meets occurring is significantly greater in the Richmond to Charlotte corridor than in the mainly-double-track Washington to Richmond segment of the Southeast Corridor. More than 60 percent of the Corridor would be operated as a single-track railroad with sidings. The remainder of the Corridor, basically Richmond to Centralia and Greensboro to Charlotte, would be double tracked with occasional passing sidings and additional tracks to support increased levels of through and local freight operations.

Additional schedule allowances also must be made for:

- The large number of Norfolk Southern freight trains operating on the NS main line between Greensboro (Elm) and Charlotte, and
- The occurrence of meets involving two passenger trains on the single-track segments, situations that will **always** result in delaying one of the passenger trains.

Each time a passenger train is required to slow down, enter a siding, and wait for the passenger train coming in the opposite direction to go past, the train adds an average of 9.5 minutes of delay to its performance. Simulation indicated that passenger trains on the 157-mile segment between Richmond and Raleigh and the 73-mile segment between Fetner and Greensboro, where more than twice the number of passenger trains each day (9 pairs, versus 4 pairs north of Raleigh) operate, have a probability of incurring 1.2 meets per day. These meets would produce an expected average delay in excess of 11 minutes for each Charlotte to Richmond train.

This is a much higher exposure to train conflicts than is encountered on the typical Amtrak high-speed operation, which are 2-3-4 track corridors, with limited freight operations.

Between Greensboro and Charlotte on the recommended 2- to 3-track main line, the volume of freight trains ensures that sidings and tracks where passenger trains would otherwise pass without delay will be occupied by freight trains, increasing the probability of some delay to the passenger trains, often simply slowing down while the slower freight trains get out of the way.

The resulting running time for a planned “5 stop” train between Richmond and Charlotte breaks down this way:

- TPC – Pure Trip Time with five intermediate stops – 3 hours, 53.3 minutes (Case 8(b)),
- Typical, 7 Percent Pad – 16.4 minutes – consisting of:
 - Rail system performance – 5.9 minutes,
 - Other factors – 10.5 minutes,
- Single Track Conflicts – 11.4 minutes or 4.9 percent, and
- Multiple Track Congestion – 3.9 minutes or 1.7 percent.

The simulation of corridor operations indicates that a 4:20 four-stop schedule, split into 2:00 hours Richmond-Raleigh and 2:20 between Raleigh and Charlotte, could be operated with over *90 percent reliability*—9 out of 10 trains make the Richmond—Charlotte run within 4:20.

The Ongoing Use of Pad

The TPC simulation database would be continuously updated during the design and construction phases of a project. The database also would be modified to incorporate the performance capabilities of the trainsets selected to operate the high-speed rail service. As the definition of the project became more accurately defined, the likelihood that the schedule goal will be achieved would be continually evaluated, and the schedule and pad adjusted as necessary. The amount of pad would be reduced to reflect the improved level of confidence that alignment and configuration improvements would be funded and implemented. Ultimately, the pad would become the time built into a schedule to enable trains to incur small increments of delay en route, overtake and meet other freight and passenger trains, and still maintains a high probability of on-time performance.

Trip Time Goal Status

The TPC simulations have clearly indicated that the performance characteristics of the intercity rolling stock will be critical to achieving the trip time goal of less than 4 hours 25 minutes for five-stop service between Richmond and Charlotte.

To determine whether a reliable five-stop¹⁶ intercity service of less than 4 hours, 25 minutes can be operated, Table B-11 was prepared to summarize the overall

<p style="text-align: center;">Table B-11 SIMULATED RUN TIMES AND AVAILABLE PAD Compared to Hypothetical 4-Stop 4-Hour 20-Minute (260-Minute) Goal [5-Stop Goal = 4-Hour 25-Minute (265-Minute)]</p>			
Case	Simulated Run Time	Pad (minutes.)	Pad (% of TPC Time)
Existing, 1 P42+6 Amfleet	343.5	N/A	N/A
90 mph/7" Eu/ P42	260.1	-0.1	N/A
90 mph/7" Eu/2 P42	251.5	8.5	3.4%
110 mph/7" Eu/1 P42	253.7	6.3	2.5%
110 mph/7" Eu/2 P42	238.0	22.0	9.2%
110 mph/7" Eu/2 P42 Separate Head End Power Source	236.1	23.9	10.1%
110 mph/7" Eu/2 P42, 80 mph Floor Raleigh - Greensboro	227.6	32.4	14.2%
110 mph/7" Eu/2P42 Recommended Alignment	230.9	29.1	12.6%
110 mph/7" Eu/2P42 Recommended Alignment – Five Stops	233.3	26.7 (31.7 Compared to 265 minutes)	11.4% (13.6% Compared to 265 minutes)

running times for various alignment and train consist options. The results are shown for speeds computed for the varying levels of unbalanced superelevation and Maximum Authorized Speed between Richmond and Charlotte that have been simulated. The amount of pad available for each run also is shown in the table.

¹⁶ A four-stop service was initially planned, however, a fifth stop at a beltway-type station north of Charlotte, called I-485, was added toward the end of the planning process.

Using 4 hours 20 minutes as the goal speed for a four stop service and 4 hours 25 minutes for a five-stop service and the 29.1¹⁷-to 31.7¹⁸-minute pad recommendation mentioned in the previous section, it is clear that **only the cases in which 110 mph MAS, seven inches of unbalanced superelevation, and two power units are assumed resulted in a run time that provides the recommended pad.** The 90 mph 7-inch two locomotive case provides less than 9 (3.4 percent) minutes of pad. A reliable 90 mph 6-inch two locomotive schedule would be three hours and 45 minutes, arrived at by adding 33.5 minutes (13.3 percent) of pad to the four hour, 11.5 minute TPC time.

The service goal for acceptable on-time performance has yet to be established. It is believed that an on-time performance of at least 90 percent should be established as a goal for Richmond to Charlotte train service: such a level would represent the optimal compromise between service quality and required investment, as the additional pad required to meet the trip time goals at higher reliability levels would come at an increasingly high cost per minute.

As previously discussed, a number of potential changes in the conditions upon which the TPC results are based might occur, which further erodes the amount of available pad. For example:

- There may still be some question as to whether all of the curve modifications that are assumed in the TPC runs are feasible from an engineering standpoint;
- If a 110 mile-per-hour MAS cannot be achieved, there is a significant increase in TPC running time; and
- If an unbalanced superelevation lower than 7 inches must be used, the trip time suffers.

¹⁷ I.e., 3 hours 50.9 minutes to 4 hours and 20 minutes—Case 8(a).

¹⁸ I.e., 3 hours 53.3 minutes to 4 hours 25 minutes—Case 8(b).

**Technical Monograph:
Transportation Planning
for the Richmond–Charlotte Railroad Corridor**

January 2004

**Appendix C
Operations Analysis To Support Project Goals**

**Federal Railroad Administration
United States Department of Transportation**

Appendix C

OPERATIONS ANALYSIS TO SUPPORT PROJECT GOALS

2020 Traffic Level Operations—Monte Carlo™ Simulations

Conflicts are likely when several services coexist on the same trackage. The reliability of all services can be jeopardized by the time lost as a result of these conflicts. Simulation of the entire interrelated system of the SEC between Richmond and Charlotte is the only valid methodology that can measure the impact of these conflicts.

Therefore, in addition to the TPC model, a model using the LOGSIM and MONTE CARLO™ simulation packages was developed for the FRA and Amtrak and modified to include the projects initially considered necessary to achieve the trip time and reliability goals.

The purpose of the simulations was to provide information as to:

- Where delays may occur;
- Where schedule changes can eliminate conflicts; and
- Where facility changes can eliminate conflicts.

Throughout this section the term “delay” is used to describe the additional time required to move a train between two points over and above the theoretically perfect TPC run for that type of train. The term does not refer to a “delay” from a schedule or published timetable that includes an acceptable “pad,” which is described later in this section.

The MONTE CARLO™ simulator provides a large number of tabular reports to assist in analysis of the simulation. In addition, string lines of the simulation can be plotted for each simulation run using Amtrak's plotting program. The string lines visually depict the each train's performance and delays.

LOGSIM™

LOGSIM™, a train simulation program embedded in MONTE CARLO™, was developed to evaluate train operations scenarios in the densely traveled Northeast Corridor, was utilized to simulate projected 2020 intercity passenger, commuter, and freight train operations between Richmond, Virginia and Charlotte, North Carolina. Desired frequencies and headways¹ were utilized to develop preliminary schedules, which were later modified to integrate with intercity and freight operations and eliminate obvious conflicts. The train simulation used MONTE CARLO™ to vary performance to more closely replicate real world operations.

A number of individual train performance simulations and preliminary train operations models were created using several different track configurations to determine where the problem areas were likely to be located. Then, the train operations

¹ As provided by Virginia Department of Rail and Public Transportation (VDRPT), Amtrak, North Carolina Department of Transportation (NCDOT), and CSX Transportation (CSX). Norfolk Southern (NS) schedules were developed using the best available information.

model was run through a series of iterations with various modifications to the track configuration (crossover configurations, siding and passing track locations, platform locations, etc.) with the goal of improving the overall operating performance of freight, commuter and intercity passenger trains. When it appeared that the overall performance had stabilized with an economically feasible track configuration, a full 7 day MONTE CARLO™ simulation² was run to observe the impact of various trains deviating from their assigned schedule on a random basis (a reflection of real-world conditions).

Simulation Methodology

The starting point for the simulation was to encode the planned 2020 facility into the MONTE CARLO™ format. Year 2020 schedules were obtained from each entity (VDRPT, NCDOT, CSX, and Amtrak³) and encoded into the model.

Intercity trains enter into the models on their scheduled departure times. When each train enters the system, the model determines whether it will depart the terminal on time or late. If late, the model determines how late by sampling historical departure statistics. Before leaving the terminal, each train's road performance factor is determined, varying from the minimum running time to about 3 percent greater than the minimum. This technique accounts for minor differences in locomotive performances and train handling. Thus the operation of the same train on successive days probably varies, as they do in actual operations.

Long distance Amtrak passenger trains were allowed to enter according to a historical distribution developed from a previous analysis of Amtrak data.

Using the dispatching rules encoded in the model for that train or a group of trains (having the same stopping pattern, for example) simulated an actual dispatcher controlling the operation. The train could be routed on regularly assigned tracks or other tracks if the former were not available. If no track was available, or if an interlocking was blocked, the train waits until a route was available. Trains were kept from following each other too closely just as they actually were by the signaling system.

Every main track crossover and turnout was represented in the model. When a train uses a crossover, either to reach an assigned track or because of contingencies, the additional time, if any, to use the crossover was accounted for by the model. Each interlocking route was blocked for a designated amount of time to preclude conflicting trains from using it simultaneously. The time consumed making station stops also was simulated.

Charlotte to Concord trains commuter trains also entered the model on their scheduled times. These trains were sampled for lateness and performance, and were routed in the same manner as intercity trains.

CSX and NS through and local freight trains randomly entered the simulation ranging from 30 minutes early to 1½ hour late. This gives a wide range of entry for both services. If an intermodal train selects a departure time placing it immediately behind a

² Each scheduled train is entered into the model at the same time each day, but its entry into simulation is controlled by a random number generated within the simulator.

³ NS did not provide schedule information.

regular freight train, the intermodal train was given priority at its origin, which a train dispatcher would normally do. These trains were sampled for lateness and performance, and were routed in a manner similar to intercity trains.

A typical plot of a simulation (drawn from the companion study of the Washington–Richmond Corridor) is shown in Figure C-1. Northbound trains departing the Fredericksburg area move from left to right down the page, while southbound trains departing Washington move from left to right up the page. The density of traffic southbound from Washington is clearly shown. The difference in speed of trains is shown by the variation in slope of the lines.

Figure C-1: Typical Simulation Stringline Plot

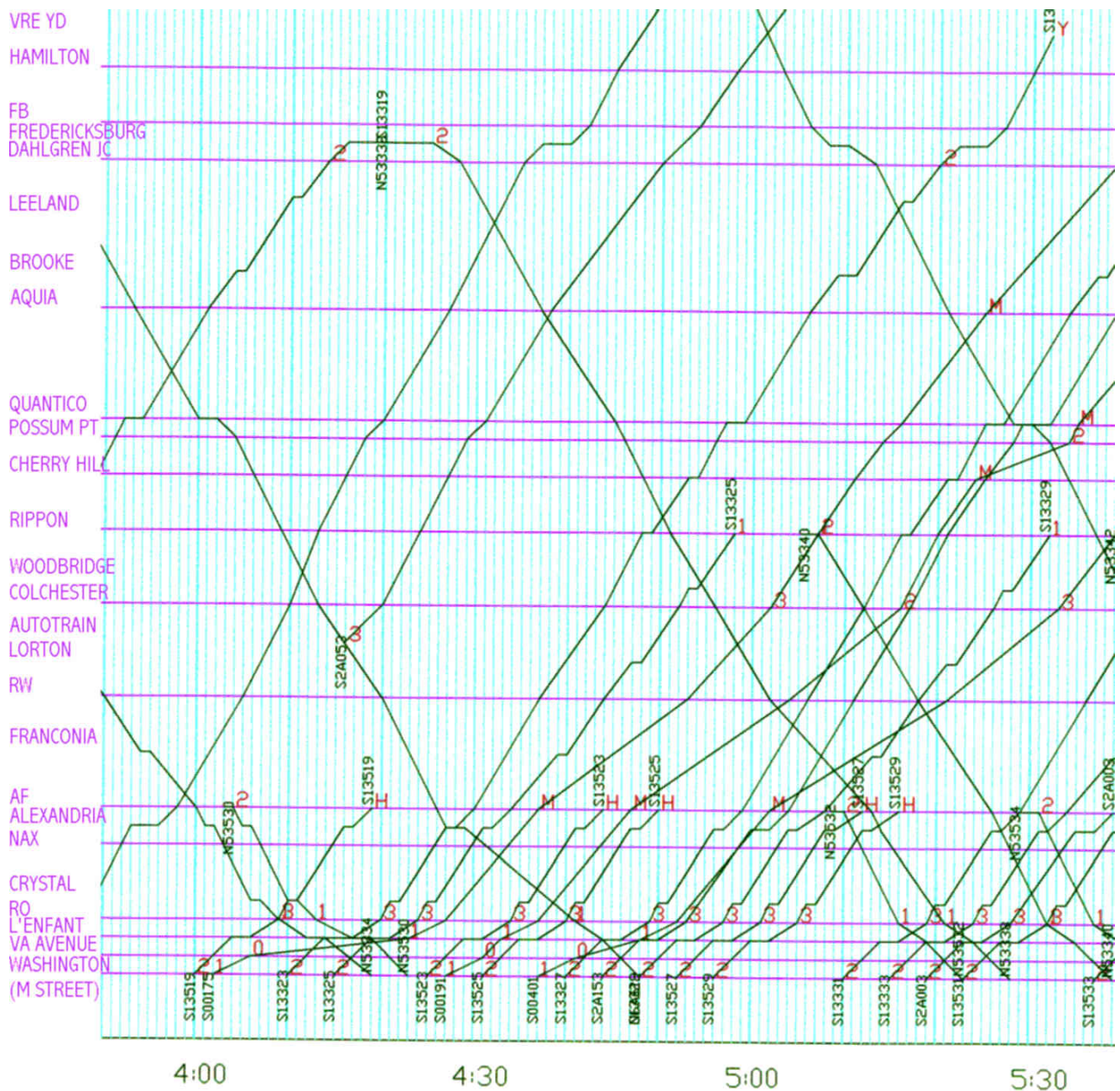

Simulation Results

Richmond to Charlotte

Seven days of simulated transit times of southward passenger trains operating between Richmond and Charlotte are displayed in Table C-1. The times included stops at Petersburg, Raleigh, Durham, Greensboro, and Charlotte I-485 for all trains. Each train was scheduled to have a three-minute dwell time at Raleigh, a two-minute dwell at Greensboro, and one-minute dwells at Petersburg, Durham, and Charlotte I-485. Trains NC06, NC07 and NC14, and NC15 stop at Henderson so their average times should be two to three minutes longer.

Table C-1

RICHMOND - CHARLOTTE

Trip times for Southbound Passenger Trains (hours: minutes)

Train	Day1	Day2	Day3	Day4	Day5	Day6	Day7	Average
NC07	4:09 ⁽¹⁾	4:23 ⁽¹⁾	4:12 ⁽¹⁾	4:08	4:13 ⁽¹⁾	4:20 ⁽¹⁾	4:08	4:13
NC11	4:03	4:09	4:22 ⁽²⁾	4:19 ⁽²⁾	4:18 ⁽²⁾	4:07 ⁽¹⁾	4:09 ⁽¹⁾	4:12
NC15	4:19 ⁽²⁾	4:15 ⁽¹⁾	4:26 ⁽³⁾	4:23 ⁽²⁾	4:08 ⁽¹⁾	4:10	4:22 ⁽¹⁾	4:17
NC17	4:13	4:11 ⁽²⁾	4:24 ⁽¹⁾	4:15 ⁽¹⁾	4:13 ⁽¹⁾	4:18 ⁽¹⁾	4:17	4:15
								4:14

Notes: All trains stop at Petersburg, Raleigh, Durham, Greensboro, and I-485.

Trains NC07 and NC15 also stop at Henderson.

CHARLOTTE - RICHMOND

Trip times for Northbound Passenger Trains (hours:minutes)

Train	Day1	Day2	Day3	Day4	Day5	Day6	Day7	Average
NC02	4:13 ⁽¹⁾	4:13 ⁽²⁾	4:19 ⁽³⁾	4:30 ⁽³⁾	4:26 ⁽²⁾	4:14 ⁽¹⁾	4:27 ⁽¹⁾	4:20
NC06	4:22 ⁽²⁾	4:24 ⁽²⁾	4:17	4:17 ⁽¹⁾	4:22	4:13 ⁽¹⁾	4:17 ⁽²⁾	4:18
NC10	4:15 ⁽¹⁾	4:13 ⁽¹⁾	4:11	4:28 ⁽¹⁾	4:25 ⁽¹⁾	4:19 ⁽²⁾	4:18 ⁽¹⁾	4:18
NC14	4:22 ⁽¹⁾	4:37 ⁽²⁾	4:12 ⁽¹⁾	4:20 ⁽¹⁾	4:18 ⁽²⁾	4:26 ⁽⁴⁾	4:27 ⁽³⁾	4:23
								4:20

Notes: All trains stop at I-485, Greensboro, Durham, Raleigh, and Petersburg.

Trains NC06 and NC14 also stop at Henderson.

(#) Denotes the number of sidings entered.

The times indicate a wide variance in daily performance of the Richmond to Charlotte passenger trains. Northbound station-to-station times ranged from a minimum

of four hours 11 minutes for five-stop NC10 on Day 3 to a maximum of four hours 37 minutes for six-stop NC14 on Day 14.

The results of a 49-day simulation also were analyzed to evaluate the reliability of the proposed timetable. The analysis indicated that the proposed four-hour 25-minute schedule for five-stop trains was attainable.

S Line- Richmond to Raleigh

Seven days of simulated transit times of southward passenger trains operating between Richmond and Raleigh are displayed in Table C-2. The times include a stop at Petersburg for all trains. Each train was scheduled to have a three-minute dwell time at Raleigh prior to departing for Greensboro. Trains NC07 and NC11 stop at Henderson so their average times should be two to three minutes longer. The “NC” trains operated at 110 mph MAS. The Star was operated at 90 mph because mail and express cars will be in the train, so their times will be greater.

Transit times were not the same each day. Even if trains receive no delay the times will not be the same for each run. All engineers do not operate their trains exactly the same and all locomotives, especially when being pushed to their limit, do not perform exactly the same way. Therefore before entering simulation each train randomly selects a performance factor - between zero and two percent greater than the minimum possible time. Therefore, if the minimum transit time was 100, minutes the time for a train having no delay en route can be expected to range between 100 and 102 minutes. Consequently, as in real life, the transit times were not consistent.

The simulated S Line was single track with passing siding spaced about fifteen miles center to center. When two trains of opposite directions approach each other one of the trains must slow down to enter one of the sidings to enable the trains to pass each other on the single-track line. The train that enters the siding runs through the length of the siding to the other end. If the other train has not passed the far end of the siding the train in the siding must stop and wait until the opposing train has passed. The length of time that the train in the siding waits was dependent upon the location of the other train, which varies from day to day. In the simulation the first train arriving at the siding was assumed to enter it. Therefore, when trains were scheduled to meet, one train may enter the siding on one day and the other may enter the siding the next day. Furthermore, even when trains were running close to their scheduled times, they may not meet at the same siding every day; they might meet at an adjacent siding.

Trains also may meet more than one train each day, therefore the number of sidings entered each day by each train is shown in parentheses in Table C-2. A (2) in the table signifies that the train that day entered two sidings. It can be expected that the transit times for trains that enter sidings will be as much as ten minutes per meet greater than trains that do not enter a siding. As a result a schedule that is based solely on the minimum possible time will be unreliable. An allowance must be added so the trains can make meets and be reliably on time.

The simulated time for northward trains also is shown in Table C-2. All trains stop at Petersburg and trains NC06, NC07, NC14 and NC15 stop at Henderson.

The minimum transit times for freight trains are shown in Tables C-3. Four intermodal trains one-merchandise train were operated in each direction in each

direction daily⁴. The intermodal trains perform no work between Fetner and Centralia. However it was assumed that the merchandise trains pick up and set off at Raleigh.

Table C-2
RICHMOND - RALEIGH

***Trip times for Southbound Passenger Trains
(hours:minutes)***

Train	Day1	Day2	Day3	Day4	Day5	Day6	Day7	Average
NC07	1:58 ⁽¹⁾	1:58 ⁽¹⁾	1:57	1:53	1:53	1:59 ⁽¹⁾	1:53	1:55
NC11	1:50	1:56	1:58 ⁽¹⁾	1:55 ⁽¹⁾	2:00 ⁽¹⁾	1:56 ⁽¹⁾	1:51	1:55
NC15	1:58 ⁽¹⁾	1:59 ⁽¹⁾	2:06 ⁽¹⁾	1:53	1:53	1:55	1:53	1:56
NC17	1:59	1:50	1:59 ⁽¹⁾	1:57 ⁽¹⁾	1:59 ⁽¹⁾	2:00	2:00	1:57
								1:58
Silver Star (90 mph)	2:11 ⁽¹⁾	2:17 ⁽¹⁾	2:21 ⁽¹⁾	2:10	2:15 ⁽¹⁾	2:09	2:11	2:13

Note: NC07, NC15 stop at Henderson.

RALEIGH - RICHMOND

***Trip times for Northbound Passenger Trains
(hours:minutes)***

Train	Day1	Day2	Day3	Day4	Day5	Day6	Day7	Average
NC02	1:53 ⁽¹⁾	1:52	1:58 ⁽¹⁾	2:00 ⁽¹⁾	1:58 ⁽¹⁾	1:52	1:58 ⁽¹⁾	1:55
NC06	2:00	1:59 ⁽¹⁾	1:54	1:55	1:56	1:55	1:59 ⁽¹⁾	1:56
NC10	1:57	1:53	1:53	2:01 ⁽¹⁾	2:07 ⁽¹⁾	2:01 ⁽¹⁾	2:00 ⁽¹⁾	1:58
NC14	2:04 ⁽¹⁾	2:00 ⁽¹⁾	1:54	2:02 ⁽¹⁾	1:54	2:08 ⁽²⁾	2:09 ⁽²⁾	2:01
								1:58
Silver Star (90 mph)	2:12	2:12	2:13	2:12	2:12	2:19	2:11	2:13

Note: NC06, NC14 stop at Henderson.

⁽¹⁾ Denotes the number of sidings entered.

⁴ The trains enter the SEC at Fetner on the H line and exit the SEC at Centralia to the A Line.

Table C-3
RALEIGH - RICHMOND
Simulated Running Times For
CSX Freight Trains between Fetner and Centralia

<i>Southbound</i>								
Train	Day 1	Day 2	Day 3	Day 4	Day 5	Day 6	Day 7	Average
CSX1	3:56	4:00	4:02	4:09	4:23	3:55	3:53	4:02
CSX3	4:52	4:33	4:45	5:41	5:33	5:05	4:20	4:58
CSX5	4:20	4:40	4:28	5:18	4:56	4:01	3:57	4:31
CSX7	5:04	5:15	4:48	4:45	5:01	4:52	4:38	4:54
ACHA	4:48	5:27	5:19	5:28	5:25	4:58	5:10	5:13
Average	4:36	4:47	4:40	5:04	5:03	4:34	4:23	4:44

RICHMOND - RALEIGH
Simulated Running Times For
CSX Freight Trains between Centralia and Fetner

<i>Northbound</i>								
Train	Day 1	Day 2	Day 3	Day 4	Day 5	Day 6	Day 7	Average
CSX2	4:11	3:51	3:32	4:14	4:06	3:52	4:37	4:03
CSX4	4:19	5:07	3:45	3:47	3:33	4:30	<i>d.n.o</i>	4:10
CSX6	4:56	5:08	5:06	5:03	5:11	4:23	4:43	4:55
CSX8	2:54	3:26	3:27	3:26	3:35	3:27	3:32	3:23
HAAC	3:57	4:04	4:56	3:56	4:17	3:55	4:03	4:09
Average	4:03	4:19	4:09	4:05	4:08	4:01	4:13	4:08

The transit times for freight trains were highly variable. Freight trains meet passenger trains and other freight trains and were overtaken by passenger trains and other freight trains of the same direction. The simulation was programmed to ascertain that when two freight trains were to meet at a siding that two passenger trains would not meet at that siding too. Therefore, a freight train may stand in a siding to avoid this occurrence, which results in the larger variability in freight train transit times. The table indicates the number of sidings entered; however the reason for entering is not shown.

The daily usage of the S Line sidings during a seven-day period is displayed in Table C-4. Passenger train meets occurred exclusively between Burgess and Norlina, with the exception of the Silver Star, 0079 that used Greystone Siding once. Freight trains very seldom used Burgess Siding; almost exclusively passenger trains used it. The siding used each day by a passenger train varied widely, according to the amount of its lateness or the lateness of the passenger train it met. For example, NC14 on separate days used Burgess, Alberta, Bracey, or Norlina.

Unless a siding has a mid-siding crossover(s) three trains cannot be handled at the same siding. None of the sidings on the S Line were provided with mid-siding crossovers. Mid-siding crossovers may be installed as the number of freight trains increases or to improve the performance of freight trains, which would be held at distant

sidings to avoid the stalemate that would result in three trains converging on a siding without a mid-siding crossover.

Dispatching Single Tracked Lines

Dispatching single tracked lines is often a difficult task for train dispatchers as speed differentials between trains create the biggest headache for dispatchers. The fastest of all trains were the passenger trains, which were to have preference over all other trains. The next in the speed ranking were the intermodal trains. Following the intermodal trains in speed were the merchandize trains. Next in the speed ranking were the drag freight and mineral freight trains. Last were the local freight trains, which often consume much time switching industries.

Siding lengths or lack of sidings also are a problem for dispatchers. Train lengths have often outgrown the length of many sidings. Meeting two trains at a siding that is not long enough to accept either train is a major mistake. The dispatcher’s task is to weave all of the different train types through an often-inadequate facility to minimize delay to all classes. The faster trains are often delayed. The facility proposed for this study has been designed to ensure that a dispatcher has an adequate but not an excessive facility to work with.

Local freight trains must work between through-running trains. If sufficient time cannot be provided on a single track between through trains to accomplish the switching work, a non-signaled siding with hand-operated switches must be provided so the local freight train can switch industries without occupying the main track. Often local freight trains are scheduled to do their work when no or few through trains are operating. That may not always be acceptable to certain industries. In this study it was assumed that local freight trains would operate at the same time of day that they currently operate.

Long sidings to minimize delays and optimize train meets have been recommended. Through passenger and freight trains operating at three maximum speeds on the S Line were assumed: 110 mph high-speed passenger trains; the Silver Star at a maximum of 90 mph because it will be handling express cars and possibly Roadrailleurs; and CSX freight trains operating at 60 mph, grades and curves permitting. The manner in which single tracked lines were dispatched in the project simulations is presented in the following sections.

Table C-4
S Line Trains Using Sidings
By Location And Day

Location	Day 1	Day 2	Day 3	Day 4	Day 5	Day 6	Day 7	Avg.
Chester	ACHA	CSX2	CSX3	HAAC	CSX3	CSX4	ACHA	
	CSX2		CSX4				CSX4	
	CSX8							
Totals	3	1	2	1	1	1	2	1.57
Lynch	CSX4	CSX3	CSX3	ACHA	CSX3	ACHA	CSX3	
				CSX1	CSX5	CSX3		
				CSX3				

[Table C-4 continues on the next page . . .]

Table C-4 (continued)
S Line Trains Using Sidings
By Location And Day

Location	Day 1	Day 2	Day 3	Day 4	Day 5	Day 6	Day 7	Avg.
Lynch [continued]				CSX4				
				CSX5				
Totals	1	1	1	5	2	2	1	1.86
Burgess	NC06	CSX4	NC02	NC11	NC02	CSX8		
	NC07		NC11			NC11		
	NC14							
Totals	3	1	2	1	1	2	0	1.43
De Witt	CSX2	NC07	CSX4	CSX2	NC11	ACHA	CSX2	
	CSX4		NC17	CSX6	NC17	CSX4	NC02	
	CSX6			NC17		NC07	NC06	
Totals	3	1	2	3	2	3	3	2.43
Alberta	CSX7	CSX5	ACHA	CSX5	CSX5	ACHA	ACHA	
		CSX7	CSX3	CSX7		ACHA	NC14	
		NC06		NC02		CSX3		
		NC14				NC14		
Totals	1	4	2	3	1	4	2	2.43
Skelton	CSX2	ACHA	ACHA	CSX6	CSX1	CSX7	ACHA	
	CSX6	CSX3	CSX4	CSX7	CSX2		CSX2	
	CSX7	NC15	CSX7		CSX6		NC10	
	NC15				CSX7			
					NC10			
Totals	4	3	3	2	5	1	3	3.00
Bracey	ACHA	ACHA	0079	CSX1	0079	CSX2	CSX6	
	CSX7	CSX1	CSX2	CSX2	CSX4	CSX4	CSX7	
		CSX7	CSX6	CSX6	CSX6	NC10	NC14	
			CSX7					
			NC15					
Totals	2	3	5	3	3	3	3	3.14
Norlina	0079	ACHA	CSX1	CSX4	CSX2	CSX3	CSX1	
	CSX4	CSX5	CSX6	CSX7	CSX7	CSX6	CSX6	
	CSX5	CSX6	NC15	NC10		CSX7	CSX7	
		CSX7		NC14		NC14		
Totals	3	4	3	4	2	4	3	3.29
Greystone	CSX1	0079	CSX5	CSX3		ACHA		
	CSX6	CSX2	CSX7			CSX1		
		CSX7				F735		
Totals	2	3	2	1	0	3	0	1.57

[Table C-4 continues on the next page . . .]

Table C-4 (continued)
S Line Trains Using Sidings
By Location And Day

Location	Day 1	Day 2	Day 3	Day 4	Day 5	Day 6	Day 7	Avg.		
Kittrell	CSX2	CSX4	CSX3	CSX2	CSX3	ACHA	CSX2			
	CSX3	CSX6	CSX4	CSX3	CSX6	CSX3	CSX3			
	CSX6	CSX7	CSX6	CSX5	CSX7	CSX4	CSX5			
	F735		F735	F735		CSX5	CSX6			
			HAAC		CSX6	F735				
Totals	4	3	4	5	3	5	5	4.14		
Youngsville	CSX3	CSX3	ACHA	F735	CSX1		ACHA			
	CSX5	CSX5	CSX5		CSX5		F735			
	CSX7	F735			HAAC					
	HAAC	HAAC								
Totals	4	4	2	1	3	0	2	2.29		
Neuse	ACHA	ACHA	ACHA	ACHA	0079	ACHA	ACHA			
	CSX1	CSX1	CSX1	CSX1	ACHA	CSX1	CSX1			
	CSX3	CSX3	CSX3	CSX3	CSX1	CSX3	CSX3			
	CSX5	CSX5	CSX5	CSX5	CSX3	CSX5	CSX5			
	CSX7	CSX7	CSX7	CSX7	CSX5	CSX7	CSX7			
	F735	CSX8	CSX8	CSX8	CSX7	CSX8	CSX8			
		F711	F711	F711	F711	F711	F711			
		F735	F735	F735	F735	F735	F711			
					NC15		F735			
	Totals	6	8	8	8	9	8		9	8.00

Southward Freight Train Dispatching - Southward Freight Train Approaching The North End Of De Witt Siding.⁵

Alberta siding is the next siding south of De Witt. The answers to the following questions determined whether the southward freight train could continue to Alberta. The answer to all of the questions had to be negative if the freight train was to continue. If the answer to any one of the several questions was affirmative the southward freight train must enter the De Witt siding

- 1. Is an opposing (northward) train occupying the main track between the south end of Alberta siding and the north end of De Witt siding?** A yes answer would cause the southward train to be routed into the north end of the De

⁵ For a more generalized, graphical presentation of this and similar dispatching situations, see the Annex at the conclusion of this Appendix.

Witt siding to prevent the two trains from attempting to occupy the single track between De Witt and Alberta.

2. **Is a northward opposing train occupying Alberta Siding?** A yes means that the next siding at Alberta was unavailable for southward train at De Witt, so the southward freight train will be routed into De Witt siding. Trains of the opposite direction cannot occupy the same siding unless a mid-siding crossover between the main track and the siding, which converts the siding into two sidings, was provided. A mid-siding crossover was not recommended at Alberta.
3. **Is a northward opposing passenger train, that will arrive at the south end of Alberta siding before the southward freight train at De Witt can run to and clear into Alberta Siding, at some point about 50 miles south of Alberta?**
The purpose of the second question now becomes clearer. If the southward freight train at De Witt had been released when a northward freight train was in Alberta siding, the southward train would have had nowhere to go upon arrival at Alberta. The northward freight train would still be in Alberta siding waiting for the southward train, the northward passenger train would have arrived at Alberta and was standing on the main track beside the northward freight train and the southward freight train that had been released from De Witt was standing at the switch at the north end of Alberta siding facing both trains. This standoff cannot be allowed to occur. The option of routing the northward passenger train behind the freight train that was waiting to be overtaken was undesirable. Therefore, a yes answer to this question would cause the southward freight train to be routed into De Witt siding.
4. **Is a southward following passenger train, that would catch up to the southward freight train before it could run to and clear into Alberta siding, at some point about 20 miles north of De Witt?** A yes answer would cause the southward freight train to be routed into De Witt siding.

Referring to question 3, would a dispatcher actually route the southward freight train into De Witt siding because a northward passenger train was 50 miles away? At first the distance might seem excessive. The north end of De Witt siding was at MP S41 and the north end of the next siding at Alberta was near MP S55. The southward freight train would have to traverse those 14 miles plus another mile to clear into the Alberta siding before the northward passenger train arrives. The southward freight train will take 20 minutes at an average speed of 45 mph to cover the 15 miles. The northward passenger train must not be any closer than MP S60 or about 3 minutes from North Alberta Interlocking (MP S55) where the southward freight train would enter into the siding to avoid delaying the northward passenger train. Twenty minutes earlier a northward passenger train, averaging 90 mph, would have been at MP S90, thirty miles from MP S60, or 49 miles from North De Witt. Therefore, the dispatcher would have to route the southward freight train into De Witt siding when a northward passenger train was at MP S90, 50 miles away. If the average speed of the passenger train had been higher or the average speed of the freight train been lower, the distance would have been even greater, so 50 miles was the absolute minimum distance.

Referring to question 4, where must the northward passenger train be to enable the southward freight train to proceed to Alberta siding and clear the main track

without delaying the southward passenger train? Again, the twenty-minute criterion applies. In this case, the southward passenger train can be no closer than MP S50 (five miles behind the southward freight train when it clears the main track at N De Witt, MP S55). Therefore, the southward passenger train would have to be at MP S20, thirty miles from MP S50, or twenty-one miles behind the northward freight train at De Witt. Again if the average speed of the passenger train had been higher or the average speed of the freight train been lower, the distance would have to be even greater, twenty-one miles was an absolute minimum distance.

Referring to question 2, if a northward freight train were in the Alberta siding for the northward passenger train described above, the southward freight train would enter De Witt Siding and wait for the passenger train to pass De Witt (possibly as long as 30 minutes). The southward freight train would also wait about 15 minutes to let the northward freight train to leave Alberta Siding and pass South De Witt.

The same four conditions that cause a southward freight train to enter De Witt siding also will hold the southward freight train in De Witt Siding until the answers to the questions were negative. The simulation model looks ahead of the freight train for opposing trains; behind the freight train for overtaking trains; and beside the freight train while waiting in the siding when making the decision whether to release a freight train.

Southward Passenger Train Dispatching

The simulation asks one question when a northward passenger train arrives at the south end of Alberta siding:

1. Is there an opposing (southward) passenger train occupying the main track between the north end of De Witt siding and the south end of Alberta Siding?
 - o If the answer were yes the northward passenger train at the south end of Alberta siding was routed into Alberta siding to prevent the two passenger trains from occupying the single track between Alberta and De Witt.

The maximum delay for a meet between passenger trains was ten minutes.

What about an opposing freight train? Question 3 for freight trains at De Witt should prevent a southward freight train from being between De Witt and Alberta. If a southward freight train was proceeding between De Witt and Alberta, the northward passenger train would proceed to the north end of Alberta siding and wait for the southward freight train to clear into the siding at that point.

Existing CSX Operations at Raleigh

CSX operates two local freight trains per day north onto the S Line. The exact operating limits of the trains vary somewhat from day to day depending upon the workload. A typical pattern is described in the following paragraph below.

Train F735 leaves Raleigh first at about 9:00, runs to Henderson, works there for several hours, then serves industries between there and Norlina but rarely going as far as Norlina. At Norlina or some location short of Norlina Train F735 turns (changes direction of travel) and works back to Raleigh, spending a number of hours at Gill and Henderson. It arrives in Raleigh eight to eleven hours after departing Raleigh. Train F711 follows Train F735 from Raleigh at about 10:00 and works the industries short of Henderson, turns at about Wake Forest and returns to Raleigh, and arrives four to five

hours after departure. Train F711 continues south from Raleigh working between Raleigh and Fetner and to Apex on the CSX and return. Train F745 departs Raleigh for Hamlet with cars from F735 and F711 at about 19:30, a number of hours after Trains F735 and F711 have arrived back in Raleigh. Train F745 returns from Hamlet at about 5:00 with cars for that day's F735 and F711.

Raleigh Station

Neither the present Raleigh station nor the old Seaboard station, located in North Raleigh on the S Line, will be used to support the recommended high-speed operation. Therefore, a new station to handle proposed intercity operations to be located west of existing Boylan Interlocking, the crossing with the old Norfolk Southern, will be required.

Proposed Operations Through Raleigh

Raleigh was one of the most complex dispatching locations in the entire route between Charlotte and Richmond. A detailed analysis of the proposed operation in the Raleigh area performed prior to developing the simulation model clearly indicated that the existing configuration would not support the proposed 2020 operations. It was concluded early in the analysis that the location of the proposed new intercity passenger station in Raleigh would result in train operations that could not be supported by the existing track configuration through downtown Raleigh. A revised configuration to support the proposed operation was developed.

Proposed CSX Operations

The 2020 NS and CSX freight trains are presented in Table C-5. CSX would operate two local freight trains per day north onto the S Line. The local freight trains would originate at Raleigh Yard in Raleigh. The exact operating limits of the local freight trains would vary somewhat from day to day depending upon the workload. The second local freight train turns at about Wake Forest and continues south from Raleigh working between Raleigh and Fetner and to Apex on the CSX Line and returns to Raleigh Yard. As initially scheduled the second local freight train received a large number of significant delays because of conflicts with daylight passenger and freight trains. Therefore, it was rescheduled to leave Raleigh at 1:00 a.m. when passenger trains were not operating.

A freight train departs Raleigh for Hamlet, NC with cars from the two local trains and returns to Raleigh Yard from Hamlet with cars for that day's local trains. A northward and a southbound merchandise train HAAC/CAHA (Hamlet/Acca) would operate between Fetner and Centralia; the trains would work at Raleigh.

Four northbound and four southbound CSX intermodal trains were assumed to operate uniformly during the day between Fetner and Centralia. The trains were assumed to randomly enter the corridor between the time entered and two hours later. These trains would not work at Raleigh.

**Table C-5
CSX/NS Freight Trains Originating-Operating Through Raleigh**

Train	From	To	Type	
CSXT CSX2	Fetner	Richmond	Intermodal	<i>Northbound</i>
CSXT CSX4	Fetner	Richmond	Intermodal	<i>Northbound</i>
CSXT CSX6	Fetner	Richmond	Intermodal	<i>Northbound</i>
CSXT CSX6	Fetner	Richmond	Intermodal	<i>Northbound</i>
CSXT HAAC	Fetner	Richmond		<i>Northbound</i>
NS LINS	Linwood	Chocowinity		<i>Northbound</i>
NS LIRA	Linwood	Raleigh		<i>Northbound</i>
NS WSRA	Winston-Salem	Raleigh		<i>Northbound</i>
CSXT ACHA	Richmond	Fetner		<i>Southbound</i>
CSXT CSX1	Richmond	Fetner	Intermodal	<i>Southbound</i>
CSXT CSX3	Richmond	Fetner	Intermodal	<i>Southbound</i>
CSXT CSX5	Richmond	Fetner	Intermodal	<i>Southbound</i>
CSXT CSX7	Richmond	Fetner	Intermodal	<i>Southbound</i>
NS NSLI	Chocowinity	Linwood		<i>Southbound</i>
NS RALI	Raleigh	Linwood		<i>Southbound</i>
NS RAW5	Raleigh	Winston-Salem		<i>Southbound</i>
CSXT F711	Raleigh	Norlina	Local	<i>Turn</i>
CSXT F735	Raleigh	Wake Forest	Local	<i>Turn</i>
NS LCL6	Raleigh	Pomona	Local	<i>Turn</i>

Proposed NS Operations At Raleigh⁶

Four southbound NS and three NS northbound trains were assumed to operate between Glenwood Yard and Greensboro daily.

A local freight train would work between Raleigh and Pomona Yard in Greensboro⁷. The train would serve industries on the branch between Glenn (on the H Line at MP H46.8) and Carrboro. This train was initially scheduled to work during daylight hours, but with the large number of passenger trains the local freight train would not reach Greensboro in less than twelve hours; therefore, its schedule was changed to depart Raleigh at five p.m.. Since nearly all of the industrial sidings between Raleigh and Greensboro are trailing⁸ going west, an eastward counterpart local freight has not been scheduled. Local service to the few trailing switches going east was assumed to be handled by a Linwood to Raleigh train.

Northbound and southbound trains (NSLI/LINS) would operate through Raleigh between Chocowinity (located on the original NS line south of Raleigh) and Linwood

⁶ NS did not provide data on freight service schedules or the locations where trains work and the times that work is performed.

⁷ Locations where this train works and the switching times have been assumed based on an inventory of sidings shown on NS track charts and an inspection of photographs, which indicated sidings that were presently being serviced. NS did not provide the manner in which NS actually operates its local service on the H Line.

⁸ A phrase indicating that the turnout to the siding is located so that a local freight can back into the siding to set off and pick up cars.

Yard via Raleigh. Northbound and southbound trains (RAWS/WSRA) would operate between Raleigh and Roanoke via Winton-Salem. Northbound and southbound freight trains (RALI/LIRA) would operate between Raleigh and Linwood.

All of these trains randomly entered the system at the scheduled time up to two hours late.

Additional trains may leave Glenwood Yard but only daily northbound and southbound freight trains (RAFA/FARA) that operate between Raleigh and Varina/Fayetteville were simulated. Each train crossed the SEC and significantly impacted SEC train operations⁹.

Raleigh Station

A new station to handle proposed intercity operations was located west of existing Boylan Interlocking, the crossing with the old Norfolk Southern to Varina. A new interlocking, Ashe (for Ashe Avenue) would facilitate train operations south of the new station. A low-level, 24-foot wide center-island platform was located between Tracks 2 and 4. A second platform was located adjacent to a new Track 1 between Ashe and Boylan. Track 4 would normally be a freight track but it also was used passenger trains. Track 4 may require that the existing stub ended siding south of Boylan Junction be relocated.

The rigid crossing frogs at Boylan Interlocking are recommended to be removed to enable adequate spirals and superelevation to be installed in the ten-degree curve between Boylan and Hargett Street on the S Line. Speed on the 10-degree curve was raised from the current 10 mph to 30 mph on tracks 1 and 2. The same progressive route that the crossing currently provides from Glenwood Yard through Raleigh to Varina on the original NS Railway was provided by:

1. The crossovers between Tracks 1 and 2 at Southern Junction, located on the S Line west of the entrance to Glenwood Yard, and
2. A new Track 4 between Boylan Interlocking and Southern Junction Interlocking.

It was assumed that the single track between Crabtree and Edgeton on the S Line north of Raleigh Yard would remain because of a major bridge over Crabtree Creek, however double track was restored between Edgeton (actually south of the Edgeton curve (Curve S154.1)) and Southern Junction. The restoration of the double-track was essential if fluid trains operations are to be provided through Raleigh. The south entrance to Raleigh Yard, located south of MP S156, would have hand-operated switches but the lead to the NCDOT Yard off S Line Track 1, located at Peace Street, was interlocked to facilitate Charlotte to Richmond passenger trains moves. Northward trains to both Raleigh Yard and the NCDOT Yard would operate on Track 1 between Southern Junction and the switches leading to the Raleigh and NCDOT yards.

The complexity of rail operations through Raleigh was the result of the combination of:

- Passenger, through freight, and local freight train operations between Fetner on the H Line and Youngsville, on the S Line, 31 miles apart;

⁹ NS did not provide data on the freight service that operates between Raleigh and Goldsboro. It was assumed this service would not significantly impact SEC train operations; therefore, it was not simulated.

- Yard operations in the vicinity of the NS Glenwood Yard, and the CSX Raleigh Yard, and
- Raleigh passenger station.

A track configuration with the flexibility and capacity to enable the trains to operate reliably through the complex freight and passenger terminal location was recommended. The NS and CSX lines between Fetner and Southern Jct must be considered interchangeable to minimize train conflicts and facilitate access to and from the routes that converge at Raleigh.

The operation was further complicated by the need for CSX and NS dispatchers to coordinate the movement of trains between the various lines

Ashe Interlocking (H79.3)

Northward passenger and freight trains could be routed to six destinations from Ashe Interlocking:

1. NS freight trains to Glenwood Yard
2. CSX freight trains to Raleigh Yard
3. NS freight or Amtrak trains to the H Line toward Selma
4. CSX freight trains to north of Raleigh on the S Line
5. Amtrak trains to north of Raleigh on the S Line
6. Amtrak trains to the NCDOT Yard adjacent to CSX Yard at Raleigh.

NS and CSX Northward Freight Trains To Glenwood and Raleigh Yards

NS and CSX northward freight trains to Glenwood Yard and Raleigh Yard could not move from Ashe Interlocking to any track if a northward freight train was occupying any part of Ashe, Boylan, or Southern Junction Interlockings. A northward freight train could not move north of Ashe Interlocking to enter either yard if:

- Either a southward freight train was ready to depart from Glenwood Yard¹⁰, or
- A southward passenger train was located between Youngsville (on the S Line) and Southern Junction, a distance of nineteen miles or approximately 15 minutes.

A northward freight train may enter Track 4 at Ashe between Ashe and Southern Junction provided that Track 4 was clear.

The fifteen minutes clearance time for southward passenger trains from Youngsville may seem excessive, but it was necessary to allow time for the following sequence of events:

1. Five minutes for the head of the freight train to operate between Ashe Interlocking and Southern Junction Interlocking, more than one mile (at about 20 mph.)
2. Six minutes to enable the rear of a mile-long freight train to pull clear of Southern Junction Interlocking at yard speed (10 mph.)
3. Four minutes to realign the switches and display a signal so that the distant signal to Southern Junction Interlocking to display its best aspect to the engineer of the passenger train.

¹⁰ Raleigh Yard for northbound CSX freight trains.

Northward trains routed to Track 4 at Ashe or northward trains from the original NS Line at Boylan may operate into Glenwood Yard¹¹ at Southern Junction if the following conditions simultaneously exist:

1. No southward passenger train on the S Line was less than 10 minutes from Southern Junction;
2. No northward passenger train was located less than ten minutes from Southern Junction. Usually that was true when no northward passenger trains are by Fetner;
3. No southward train was ready to depart from Glenwood Yard or Raleigh Yard within 45 minutes.
4. A track in Glenwood Yard or Raleigh Yard was available to receive the train.
5. Glenwood and Raleigh Yards were beyond the limits of the model, so that assumption was necessary. It was assumed that holdouts¹² would not exist at Glenwood or Raleigh Yards or that trains would not have to double into the yard because of a track long enough to hold the entire train was not available¹³.

Eastward H Line Freight Trains and Northward Freight Trains From The Original NS At Boylan To The H Line East Of Raleigh

Presently southward trains on the S Line do not impact Amtrak trains destined for the H Line east of Raleigh, the third destination for eastward freight trains from Ashe. After Amtrak trains are transferred to the restored S Line the potential for conflict would increase. Freight trains to the H Line at Ashe towards Selma must enter Track 4 at Ashe and it was necessary that:

1. Ashe and Boylan Interlockings were free of all northward trains
2. Track 4 was free between Boylan and Southern Junction (the rear of train between these two interlocking would block the dividing switch at Boylan).
3. There were no preceding or opposing trains on the H Line to Selma.

Northward freight trains from the original NS at Boylan to the H Line east must meet the same four conditions as the trains at Ashe.

Northward CSX Freight Trains to the S Line/Northward NS Freight Trains to Glenwood Yard

Southward trains would not affect northward S Line/NS freight trains at Ashe. Ashe, Boylan, and Southern Junction Interlockings must be clear of northward trains to enable these trains to proceed. The requirement that the segment of Track 2 (northward track) between Southern Junction and Edge Interlockings must be clear before a northward freight train receives a route at Ashe provides an added complexity to train operations in Raleigh. Northward CSX merchandise freight trains (HAAC) were assumed to make a pick up or setoff at Raleigh Yard from Track 2. Northward freight

¹¹ The same conditions must exist for a CSX freight train from Track 4 at Ashe to Raleigh Yard.

¹² Freight trains are not prevented from directly entering the yard upon arrival at the yard because of the lack of track space.

¹³ Data has not been provided by Norfolk Southern to indicate that freight trains are regularly held out of Glenwood Yard.

trains also may have to wait on this segment for southward trains or to be overtaken by northward passenger trains. This may cause a complication that would arise when:

- A northward freight train was occupying Track 2 between Southern Junction and Edgeton, and
- A southward freight train also was occupying Track 1 between the same points at the same time because one or the other freight trains was waiting to be overtaken by a passenger train.

Holding the freight train on Track 2 between Fetner and Ashe creates a single track between Fetner and Ashe. Pulling the second freight train onto Track 2 between Ashe and Southern Junction beside the train on Track 4 was the better solution, if only one passenger train was involved. The second freight train blocks Track 2 at Raleigh station, creating either a one-mile single track between Ashe and Southern Junction on Track 1 or a two-mile single track between Ashe and Crab, depending upon the direction of the passenger train. If two passenger trains were involved, the best solution was to hold the second northward freight out of Raleigh altogether on one of the recommended passing sidings at Cary.

Southward Freight Trains to Fetner

A southward freight from Glenwood Yard to Fetner entered the corridor at Southern Junction Interlocking if five conditions¹⁴ were satisfied:

1. A northward train was not on the southward track between Fetner and Ashe, this was the preferred route for northward passenger trains
2. A southward train, including a passenger train, was not between Southern Junction and the new Ashe Interlocking. The distance between the two points is 7000 feet; therefore, a long southward freight train with its head end at Ashe may not be clear of Southern Junction.
3. A southward train that has passed Crab Interlocking (on the S Line) but has not either passed Southern Junction Interlocking or cleared into the CSX Raleigh Yard
4. A southward passenger train would not pass Southern Junction in the next 30 minutes
5. A southward freight train was not waiting to be overtaken by the passenger train listed in Rule 4 on Track 1 between Edgeton and Peace Street.

Southward CSX freight train movements must satisfy only the first four conditions.

The distance between Edgeton and Peace Street was sufficient that most southward freight trains may stand between the two locations without the rear of a train blocking Edge. Therefore, southward passenger trains could use Track 2, provided that it was not occupied, between Edgeton and Southern Junction or Boylan to run around a southward CSX freight train. **Therefore, restoring the second track between Edgeton and Southern Junction was essential.**

¹⁴ The same rules also would apply to a southward CSX train leaving the CSX Yard.

Simulation Of Raleigh Operations

The freight train delays in a seven-day simulation period are shown in Table C-6. The table includes the length of the delays and the reason for the delay. New track 4, north of Ashe Interlocking, provided a location for northward freight trains to stand while waiting for a route northward to NS Glenwood Yard, the CSX Raleigh Yard, or the S Line.

Track 4 between Southern Junction and Boylan was the normal route for trains RAFA and FARA, the NS Raleigh to Fayetteville turn. These trains were not delayed on Track 4 although Train FARA was held on the original NS line up to twenty-one minutes on four of the seven days before being allowed to enter Track 4. In each case the delay was to allow passenger trains to pass Southern Junction first.

On six of the seven days NS train WSRA was delayed entering Glenwood Yard awaiting NS trains RAWs and LCL6 to depart Glenwood Yard. On days 2, 3, and 4 passenger trains and CSX freight moves caused additional delays for WSRA. On day 7 NS train RALI into Glenwood Yard was delayed to allow NS train NSLI to depart from Glenwood Yard. On days 4 and 7 NS train LIRA was delayed to let Trains NC04 and NC07 pass Southern Junction. NS Local freight LCL6 was delayed each day to follow RALI.

CSX trains CSX6 and HAAC were delayed on Track 4 on various days so that they could follow passenger trains NC12 and NC16 north through Southern Junction. On day 1 CSX6 also waited for NC15 and CSX5 to come off the S Line. CSX local freight train F711 was routed to Track 4 at Ashe for a number of different reasons prior to entering CSX Yard. On Days 2 and 4 F711 was routed to Track 4 to let NC10 pass Southern Junction first and on Day 7 it was routed to Track 4 for NC15.

New Track 4 was used as intended in the simulations and was essential to support proposed future operations.

Thirteen Richmond-bound CSX freight trains were delayed on Track 2 between Southern Junction and Edgeton to permit southbound passenger and freight trains to clear the single-track between Crabtree and Edgeton. Restoration of Track 2 between Southern Junction and Edgeton was essential.

Five NS freight trains (RAWs) departing from Glenwood Yard were delayed to allow southward passenger trains to proceed up the grade to Fetner first. NS Local freight LCL6 was delayed each day to follow RAWs. CSX freight train F711 was delayed three days departing from Raleigh Yard to follow NC01 up the grade to Fetner. The delays departing from NS Glenwood and CSX Raleigh Yards were less than expected.

Table C-6

REASONS FOR FREIGHT TRAIN DELAYS AT RALEIGH

Day	Road	Train	From	To	Reasons
Track 4 - Boylan to Southern Junction					
1	CSX	F711	1623	1625	NC10 north
1	NS	WSRA	1731	1837	Waits for RAW5 to depart from Glenwood Yard
1	NS	FARA	1912	1927	NC14 north
2	CSX	CSX6	1819	1849	NC15 south, NC12 north, CSX5 from S Line
2	NS	FARA	1846	1901	Off NS, waits for CSX6 blocking
2	NS	WSRA	2159	2414	NC17 south, Note 1, NC18 north, ACHA
3	NS	FARA	1829	1845	NC12 to NCDOT Yard
3	CSX	HAAC	2117	2132	NC16 to NCDOT Yard
3	NS	WSRA	2157	2408	NC17 south, Note 1, NC18 north, ACHA
4	NS	LIRA	1020	1058	NC04 to NCDOT Yard, NC07 south
4	CSX	F711	1623	1636	NC10 north
4	NS	WSRA	2204	2306	NC17 south, Note 1
5	NS	WSRA	2159	2341	NC17 south, Note 1, NC18 north
6	NS	LINS	1127	1227	NSLI from Glenwood, NC06 north
6	CSX	HAAC	2110	2135	NC16 to NCDOT Yard
6	NS	WSRA	2200	2302	Note 1
7	NS	LIRA	820	842	NC02 north
7	NS	LINS	1141	1227	NSLI from Glenwood, NC06 north
7	CSX	F711	1747	1756	NC15 south
7	CSX	CSX6	1813	1836	NC12 to NCDOT Yard
7	NS	FARA	1822	1843	From NS CSX6 blocking
7	NS	WSRA	2221	2304	Note 1
Note 1: Waits for RALI and LCL6 to depart from Glenwood Yard before yarding.					
Track 2 - Southern Junction to Edgeton					
1	CSX	CSX6	1812	1854	NC15 and CSX5 off S Line
2	CSX	CSX4	1242	1321	CSX3 off S Line
2	CSX	HAAC	2102	2104	Silver Star off S Line
3	CSX	CSX6	1803	1843	CSX5 and F735 off S Line
3	CSX	HAAC	2203	2233	CSX7 off S Line
4	CSX	CSX2	755	812	CSX1 off S Line
4	CSX	CSX6	1754	1823	NC15 and F735 off S Line
4	CSX	HAAC	2245	2247	CSX7 off S Line
5	CSX	CSX2	858	923	CSX1 off S Line
5	CSX	CSX6	1739	1747	F735 off S Line

[Table C-6 continues on the next page.]

Table C-6 [continued]
REASONS FOR FREIGHT TRAIN DELAYS AT RALEIGH

Day	Road	Train	From	To	Reasons
6	CSX	CSX6	1802	1845	NC15, CSX5, F735 off S Line
6	CSX	HAAC	2202	2244	NC17, CSX7 off S Line
7	CSX	CSX2	854	912	CSX1 off S Line
Departing NS Glenwood Yard					
1	NS	RAWS	1756	1834	Follows NC15 up Fetner Hill
1	NS	LCL6	2215	2300	Follows RALI
2	NS	LCL6	2215	2312	Follows RALI
3	NS	RAWS	1745	1813	Follows NC15 up Fetner Hill
3	NS	LCL6	2215	2307	Follows RALI
4	NS	RAWS	1752	1808	Follows NC15 up Fetner Hill
4	NS	LCL6	2216	2303	Follows RALI
5	NS	LCL6	2215	2317	Follows RALI
6	NS	RAWS	1747	1813	Follows NC15 up Fetner Hill
6	NS	LCL6	2215	2259	Follows RALI
7	NS	RAWS	1752	1811	Follows NC15 up Fetner Hill
7	NS	LCL6	2216	2301	Follows RALI
Departing CSX Yard					
1,2,3					No delays
4	CSX	F711	532	601	NC01 goes south first
5	CSX	F711	538	601	NC01 goes south first
6	CSX	F711	548	601	NC01 goes south first
7					No delays

The One-Percent Ascending Grade to Fetner

A freight train would take approximately twenty-five minutes from the time from when the locomotive enters the main track at Southern Junction until the rear of the train passes Fetner. It would take at least five minutes for a mile long freight train to clear the yard tracks at Southern Junction. When the rear of the train clears Southern Junction the front of the train was at or by Ashe Interlocking. Normally a freight train would accelerate to track speed after clearing the yard track. However, at Southern Junction, a freight train was on an ascending one percent grade. TPC simulations indicated that freight trains close to their maximum tonnage accelerate to only 14 to 15 mph for the first four miles south of the yard track. A new passing siding located just south of Fetner Interlocking on the H Line enables a southward passenger train to overtake a southward freight train. If this new siding did not exist the freight train would have to run to Durham Yard ahead of a passenger train, and the window before the arrival of a southward passenger train at Southern Junction was much greater than 30 minutes, possibly as much as an hour.

Therefore, a freight train was held at Southern Junction until all five conditions were simultaneously met.

An NS freight train would not move from the H Line east of Boylan to Fetner unless the same five conditions were satisfied, however, a sixth condition was necessary:

- A northward train may not be between Fetner and Ashe on either track.

This conflict did not occur. An NS train moving from the H line east to the original NS Line at Boylan only required that Track 4 between Ashe and Southern Junction be clear.

Conclusion

Raleigh will be a busy and complex rail operation. The operation will be further complicated by the need for CSX and NS dispatchers to coordinate the movement of trains between the various lines.

H Line and Piedmont Main Line – Raleigh to Greensboro to Charlotte

Seven days of simulated transit times of southward passenger trains operating between Raleigh and Greensboro are shown in Table C-7. Seven days of simulated transit times of northward passenger trains between Greensboro and Charlotte are displayed in Table C-8. The times include a two-minute stop at Durham and Greensboro for all trains. Every Charlotte to Richmond and Charlotte to Raleigh trains was assumed to stop at the I485 beltway station in Charlotte so their average times should be two to three minutes longer.

H Line

The H Line is double tracked between Raleigh and Fetner, sidings have been provided at Cary, Durham, Funston, Efland, Graham, McLeansville, and English between Fetner and Greensboro to enable passenger trains to overtake freight trains or meet passenger or freight trains. The simulation results indicate that the schedule simulated resulted in numerous meets between passenger trains south of Durham.

Cary Siding

The simulation model assumed that northward passenger trains normally used the southward track (the existing CSX main track) from Fetner into Raleigh to avoid a diverging move at Fetner. If no southward trains are present at Raleigh a passenger train may use the platform located adjacent to the southbound main track. If this occurs a passenger train may not have to diverge until either entering the NCDOT Yard at Peace Street or crossing to the northbound S-Line Main track at Southern Junction to proceed northward to Richmond. Since the speed would be 30 mph around the ten-degree curve between Boylan and Southern Junction, a passenger train diverting at Southern Junction would not encounter a time penalty. A diverging move to access the northward platform at the relocated Raleigh Station was assumed to be made at Ashe Interlocking as a passenger train braked for a station stop at Raleigh. In the simulation

Table C-7

RALEIGH - GREENSBORO

Trip times for Southbound Passenger Trains (hours:minutes)

INTERSTATE

Train	Day1	Day2	Day3	Day4	Day5	Day6	Day7	Average
NC07	1:03	1:03	1:07 ⁽¹⁾	1:03	1:08 ⁽¹⁾	1:14	1:03	1:05
NC11	1:03	1:04	1:07 ⁽¹⁾	1:14 ⁽¹⁾	1:11 ⁽¹⁾	1:04	1:11 ⁽¹⁾	1:07
NC15	1:11 ⁽¹⁾	1:05	1:13 ⁽²⁾	1:23 ⁽²⁾	1:07 ⁽¹⁾	1:08	1:18 ⁽¹⁾	1:12
NC17	1:03	1:10 ⁽²⁾	1:07	1:04	1:04	1:08 ⁽¹⁾	1:04	1:05
								1:07

Note: Includes dwells at Durham and Greensboro.

INTRASTATE

Train	Day1	Day2	Day3	Day4	Day5	Day6	Day7	Average
NC01	1:07	1:11	1:11	1:11 ⁽¹⁾	1:07	1:08	1:07	1:08
NC03	1:07	1:12 ⁽¹⁾	1:07	1:20	1:20	1:13 ⁽¹⁾	1:15 ⁽²⁾	1:13
NC05	1:07	1:14 ⁽²⁾	1:16 ⁽¹⁾	1:14 ⁽²⁾	1:15 ⁽²⁾	1:14 ⁽²⁾	1:07	1:12
NC09	1:08	1:12 ⁽¹⁾	1:08	1:08	1:14 ⁽²⁾	1:07	1:07	1:09
NC13	1:08	1:12	1:07	1:08	1:11	1:08	1:13 ⁽¹⁾	1:09
								1:10

Note: Includes dwells at Greensboro, Burlington, Durham, and Cary.

^(#) Denotes the number of sidings entered.

only about half of the passenger trains operated into Raleigh from Fetner as assumed. The remaining trains found opposing trains occupying the southward track.

Brassfield Siding

This siding arrangement enabled:

- A freight train to be working at the yard and for two passenger trains to meet at the same time, or
- For a southward freight train to wait clear of the main track while a northward freight was working at Durham Yard.

A northward freight train waited at Funston Siding for a southward freight train to finish working at Durham Yard.

Table C-8

Charlotte (Downtown Station) - Greensboro

Trip times for Northbound Passenger Trains (hours:minutes)

INTERSTATE

Train	Day1	Day2	Day3	Day4	Day5	Day6	Day7	Average
NC02	1:10	1:10 ⁽¹⁾	1:10 ⁽¹⁾	1:10 ⁽¹⁾	1:22	1:10	1:21	1:13
NC06	1:11	1:11	1:08	1:10	1:09	1:08	1:06	1:09
NC10	1:06	1:10	1:17	1:09	1:15	1:06	1:08	1:10
NC14	1:12	1:18	1:09	1:13	1:10 ⁽¹⁾	1:06 ⁽¹⁾	1:12 ⁽¹⁾	1:11
								1:10

Note: Includes dwells at I-485 and Greensboro.

INTRASTATE

Train	Day1	Day2	Day3	Day4	Day5	Day6	Day7	Average
NC04	1:23	1:21	1:28	1:19	1:20	1:19	1:24	1:22
NC08	1:13	1:17	1:15	1:13	1:18	1:14	1:15	1:15
NC12	1:14	1:14	1:23	1:14	1:13	1:16	1:16	1:15
NC16	1:31 ⁽¹⁾	1:15	1:13	1:20	1:19 ⁽¹⁾	1:22 ⁽¹⁾	1:16 ⁽¹⁾	1:19
NC18	1:18 ⁽¹⁾	1:14	1:15	1:18	1:15	1:15 ⁽¹⁾	1:27	1:17
								1:17

Notes: Includes dwells at I-485, Kannapolis, Salisbury, High Point, and Greensboro.

Train NC16 used the Bowers center siding on Days 1 and 6.

WASHINGTON TRAINS (90 mph)

Train	Day1	Day2	Day3	Day4	Day5	Day6	Day7	Average
2	1:26	1:29	1:30	1:26	1:29	1:26	1:29	1:27
20	1:32	1:23	1:24	1:24	1:23	1:32	1:24	1:26
								1:26

Note: Includes dwells at I-485, Salisbury, and Greensboro.

⁽¹⁾ Meets on siding at Greensboro station.

Efland-Mebane Siding

Simulations indicated that two passenger trains and a freight train often met at this location. The long siding was advantageous because it also enabled a passenger train to meet one freight train and overtake another.

Center Sidings

The Funston-Glenn siding and the Efland-Mebane sidings would be constructed with a pair of mid-siding crossovers located at Glenn and Mebane, respectively. The crossovers facilitated meets at the sidings and enabled each siding to be operated as either two separate sidings or one long siding.

A southward passenger train approaching the Efland siding entered the north end of the siding at Efland for a meet with a northward passenger train unless:

- The northward passenger train was already in or entering the Mebane portion of the siding, or
- The Efland portion between Efland and Mebane was occupied by a southward freight train.
- In those cases the southward passenger train continued on the main track.

After entering the Efland siding a southward passenger train ran to the mid-siding crossover at Mebane and entered the Mebane portion of the siding, provided a northward opposing train was not occupying the Mebane portion of the siding, and exited at South Mebane to maximize the probability of creating a non-stop meet. If a northward freight train occupied the Mebane portion of the siding, the southward passenger train reentered the main track at the mid-siding crossover at Mebane after the northward passenger train had passed Mebane. Freight trains always reentered the main track at the mid-siding crossover.

Three-Train Meets

A three-way meet of a southward passenger train, a southward freight train, and a northward passenger train occurred as follows:

- The southward freight train occupied the Efland siding,
- The southward passenger train entered the Mebane portion of the siding at the mid-siding crossover at Mebane, unless
 - The train to be met has entered the siding or was entering it at South Mebane, in that case
 - The southward train continues on the main track to South Mebane.

The daily usage of the H Line sidings during a seven-day period is displayed in Table C-9. Six to seven passenger trains entered either the Efland-Mebane siding or the Funston-Glenn siding each day.

The schedule simulated determined the locations where passenger trains meet. The proposed schedule resulted in most meets passenger train meets occurring at either the Funston-Glenn Siding or the Efland-Mebane Siding. Because of the large number of meets at these sidings an evaluation was performed to determine whether to recommended that the north and south ends of both sidings be installed with Number

32 (80 mph) turnouts and that the Efland-Mebane siding have main track speed limits. A cost-effectiveness analysis, described in Appendix G, concluded that Number 20 turnouts should be installed and that the siding would not be realigned. A large portion of the Funston-Glenn siding would be on the original roadbed so it would have a lower speed. Number twenty crossovers also would be installed at the mid-siding locations.

Table C-9
H Line Trains Using Sidings
By Location And Day

Location	Day 1	Day 2	Day 3	Day 4	Day 5	Day 6	Day 7	Avg.
Boylan	F711	CSX6	F711	LIRA	WSRA	LINS	LIRA	
	WSRA	WSRA	HAAC	F711		WSRA	F711	
			WSRA	WSRA			CSX6	
							LINS	
						WSRA		
Totals	2	2	3	3	1	2	5	2.57
Cary	WSRA	LINS	LINS		LINS	LINS		
		LIRA	NC15					
Totals	1	2	2	0	1	1	0	1.00
Brassfield	NC15	NSLI	LIRA	LIRA	NSLI	LIRA	LIRA	
			NSLI	NSLI			NC15	
							NSLI	
Totals	1	1	2	2	1	1	3	1.57
Funston-Glenn	LINS	LINS	NC07	LINS	LINS	LINS	LINS	
	NC06	NC14	NC11	NC11	NC07	NC06	LIRA	
	NC10	NSLI	NC14	NC15	NC11	NC10	NC06	
	NC18	RALI	NSLI	NSLI	NC14	NC14	NC11	
	NSLI	RAWS	RALI	RALI	NSLI	NSLI	NSLI	
	RALI	WSRA	RAWS	RAWS	RALI	RALI	RALI	
	RAWS		WSRA	WSRA	RAWS	RAWS	RAWS	
	WSRA				WSRA	WSRA	WSRA	
Totals	8	6	7	7	8	8	8	7.43
Efland-Mebane	LINS	LIRA	LIRA	LIRA	LIRA	LIRA	LIRA	
	LIRA	NC02	NC02	NC01	NC02	NC02	NC03	
	NC02	NC05	NC08	NC02	NC05	NC05	NC08	
	NC08	NC06	NC15	NC05	NC09	NC08	NC13	

[Table C-9 continues on the next page.]

Table C-9 [continued]
H Line Trains Using Sidings
By Location And Day

Location	Day 1	Day 2	Day 3	Day 4	Day 5	Day 6	Day 7	Avg.
Efland-Mebane <i>[continued]</i>		NC09						
	NC12		NC18	NC06	NC12	NC12		
	RAWS	NC10	RAWS	NC08	NC15	NC17		
		NC12	WSRA	NC12	NC18	RAWS		
		NC17		NC15	RAWS			
			NC18	WSRA				
			RAWS					
			WSRA					
Totals	6	8	7	11	9	7	4	7.43
Haw River	NC04	WSRA	LINS	LINS	LINS	WSRA	NC04	
	NSLI		NC05				NC18	
			NC12					
Totals	2	1	3	1	1	1	2	1.57
McLeansville		LCL6	LCL6	LCL6	LCL6	LCL6	LINS	
		NC03	LINS	LINS	LINS	NC03	NSLI	
		NSLI	NSLI	LIRA	NSLI	NSLI	WSRA	
			WSRA	NSLI		WSRA	LCL6	
Totals	0	3	4	4	3	4	4	3.14
English	RALI	NC02	NSLI	NC02	RALI	LINS	LINS	
	RAWS	LINS	WSRA		WSRA		NC1	
			NC02		NC14			
Totals	2	2	3	1	3	1	2	2.00

English Siding

. This passing siding, located at the junction of these two lines, served several purposes. First, the siding provided a location where a freight train could be held without blocking passenger trains. For example, if the Piedmont Main Line did not have a track available to enable a southward freight train on the H Line to either enter Pomona Yard or to proceed southward to Linwood Yard. Second, the siding provided a location where a northward freight train headed to the single tracked H Line could be held until an oncoming (opposing) southward freight or passenger train passed. The siding also provided capacity to store a northward freight train, without occupying a Piedmont Line track, that may not be able to reach and enter the next siding at McCleansville on the H Line before a northward passenger train caught up to it.

Piedmont Line: Dispatching A Double Track Railroad

Traffic flow on a two-lane highway is analogous to the operation of a double tracked railroad. Automobiles (passenger trains) catch up to slower trucks (freight trains). Automobiles use the opposite lane to overtake or pass trucks when a break in the opposite traffic flow and sight distances permit. When traffic is heavy the breaks between oncoming cars are few and far between. Occasionally a third passing lane (a siding) is provided on hills or other locations to freely enable automobiles to pass the trucks. At the end of the passing lane (end of siding) the trucks must merge back into the automobile flow. At times when a lane is closed for repair work or other reasons (track maintenance or a local freight train) all traffic must use the remaining lane.

In two-lane highways, the locations where automobiles may cross to the opposite lane are unlimited, assuming adequate sight distances exist and a clear lane is available. However, railroads have fixed locations (crossovers) where trains may move to the opposite track and these locations may be many miles apart. Typically railroad crossovers are spaced five to ten miles apart, sometimes greater. Unlike automobile drivers and truck drivers, who make their own decisions when to use the opposite lane, train engineers are directed by train dispatchers when to use the opposite track.

Passenger Trains Overtaking Freight Trains¹⁵

How much “sight” or clear distance is needed for a passenger train moving at 100 mph (0.6 minutes per mile) to overtake a freight train moving at 50 mph (1.2 minutes per mile) by diverting to the opposite track and back? The time differential in this case is 0.6 minutes per mile. Once a freight train has cleared an interlocking a following passenger train, once it has diverted to the opposite track, must arrive at the next interlocking, divert back to the track it was on, and clear the interlocking in sufficient time to not delay the freight train. At a minimum, the freight train must gain nine minutes, which includes:

- Three minutes for the rear of the freight train to clear the first interlocking;
- 1.5 minutes for the passenger train to divert at the first interlocking;
- 1.5 minutes for the passenger train to divert at the second interlocking; and
- Three minutes for the rear of the passenger train to clear the second interlocking.

At 0.6 minutes per mile, it would take a passenger train fifteen miles to complete the pass. The time sequence of events of an ideal overtake of a freight train by a passenger train was as follows:

1. The rear of a freight train passes interlocking at Point 1 at time zero.
2. An opposing passenger train (B) may pass an unknown Point 3 at time zero
3. A passenger train (A) crosses to the other track at Point 1 to run around the freight train at time 3 minutes, with an deceleration/acceleration time loss (100 mph to 45 mph back to 100 mph) of about 1.5 minutes

¹⁵ For a graphical presentation of this dispatching situation, see Annex 2 at the conclusion of this Appendix.

4. Passenger train A returns to original track ahead of the freight train at Point 2 fifteen miles from Point 1 at time 15 minutes, with another diversion delay of about 1.5 minutes.
5. The freight train may pass Point 2 at time 18 minutes, presumably without being slowed
6. Opposing train B also may pass Point 2 at time 18 minutes, presumably without being slowed.

If the opposing train was a passenger train it would have been at the unknown Point 3 eighteen minutes from Point 2 when the freight train passed Point 1. At 100 mph the opposing passenger train would have covered 30 miles in those eighteen minutes.

Therefore, a clear distance of 45 miles was needed for a passenger train moving at 100 mph to overtake a freight train moving at 50 mph - the sum of the distance of Point 3 to Point 2 (30 miles) and Point 2 to Point 1 (15 miles). Therefore, passenger train A cannot use the opposite track to overtake a freight train and avoid delaying an opposing passenger train B if opposing train B was within 45 miles of train A. If train B was within 45 miles of train A, and train A still uses the opposite track, train B was slowed or stopped to enable the passenger train to run around the freight train. However, if the opposing train was a slow moving freight train the dispatcher could not use the opposite track to overtake a freight train if the opposing freight train on the track was within 30 miles. If the interlockings were not ideally spaced, the required clear distances would be greater.

Operating approximately 50 trains daily between Greensboro and Charlotte in 2015 it would often be difficult to find forty-mile or thirty-mile clear opposing distances to enable overtakes to occur. Our analysis indicates that an eighteen-minute gap would not be available nearly 30 percent of the time. Consequently passenger trains may have to follow freight trains for many miles before a clear distance was available. The passenger train would lose 0.6 minutes per mile for each mile it followed a freight train.

Oncoming highway traffic generally does not slow down to create a gap to let a car pass a truck, but a train dispatcher can slow an opposing train to let a passenger train to pass a freight train.

If the distance between Point 1 and Point 2 in the example above was less than fifteen miles, the freight train being overtaken may have to be slowed or stopped to let the overtaking occur. It was possible that allowing a passenger train to overtake a freight train would result in three or more trains losing time or being required to operate at a reduced speed. The three trains was:

1. The freight train being overtaken,
2. The passenger train overtaking the freight train, and possibly
3. One or more opposing trains.

In the initial simulations of a double tracked system between Greensboro and Charlotte this situation occurred several times a day.

A very large number of trains can be operated on two tracks when the speed of the trains was uniform. For example, commuter agencies can operate well over 100 trains per day on two tracks. When the speed of trains was not uniform, the transit time differentials, not the number of trains create the need for overtakes.

Passenger-Freight Overtakes – Charlotte to Greensboro

A freight train can make the 85-mile run between Greensboro and Charlotte in about 2.25 hours. An intermodal train can make the run in slightly less time. It was anticipated that the high-speed passenger train would make the run in about one hour. Consequently, if a freight train departs Greensboro at any time less than 1.25 hours before a passenger train does, the passenger train would overtake the freight train before it arrives at Charlotte. In 2015 as many as nine freight trains each way per day may be operating, so there was fourteen 1.25-hour periods throughout the day that could require a passenger train to overtake a freight train somewhere between Greensboro and Charlotte. Assuming that freight trains can depart Greensboro at any time during the day (the likely NS requirement) it can be estimated based on queuing tables that about:

- 63 percent of the passenger trains can be expected to overtake at least one freight train,
- 16 percent of the passenger trains can be expected to overtake two freight trains, and
- 3 percent can be expected to overtake three freight trains.

The simulated northbound and southbound running times of intermodal trains between Charlotte and Greensboro are shown in Tables C-11 and C-12 respectively.

The Need for Additional Facilities – Charlotte to Greensboro

During the initial development of the model some trains overtook three freight trains, but this occurred rarely. The last simulation performed before additional facilities were added to the model to reduce the number of passenger train diversions indicated that eight of eleven southward passenger trains overtook a freight train or ran around a local freight train working on the main track. None of the eight diverted southward passenger trains overtook two trains. In three of the eight cases the overtaking passenger train required opposing passenger trains to be slowed or stopped to enable the pass to take place. In other words, an eighteen-minute operating window to enable a passenger train to bypass a freight train was not available. In one of the three cases one passenger train that was slowed was behind a freight train that was also slowed. Additionally, four of the eleven southward passenger trains had to follow a freight train prior to finding a clear track to make a diversion. A total of eight southward trains incurred diversion delays of 3 minutes, however the total delay was much more than that.

The same simulation also indicated that seven of eleven northward passenger trains diverted to overtake a freight train or a run around a local freight train. One passenger train overtook two freight trains, making a total of eight, but no train in this simulation overtook three freight trains. One of the eleven trains could not obtain a window to overtake a freight train and had to follow the freight train from Lake to Bowers, a distance of four miles. Two freight trains were held at AT&O Jct., in Charlotte, to enable a passenger train to operate ahead. If that had not been done two more overtakes would have occurred. In addition to that, four of the eleven trains diverted to Track 2 at Cox to enable four southward freight trains to work at Pomona Yard. That makes a total of twelve diversions. In one of the four cases a southward freight train was running around a working freight train at⁶ Pomona and Track 2 was not available.

Densely Trafficked Double Tracked Rail Operations

The simulations clearly illustrated that a densely trafficked double track railroad with reverse signaling on both tracks does not adequately handle all the normal operations without slowing some, perhaps many, trains when great speed differentials exist. Short of having a separate track for every train some trains would have to be delayed. The major advantage of the reverse signaling is that it eliminates the time consuming practice of copying train orders, or their equivalent, when it is necessary to use the second track to run around slower trains, maintenance work, local freight trains or disabled trains. Reverse signaling does little to provide added capacity during normal operations. Consequently, railroads having very heavy passenger traffic, such as the New York Central, the Pennsylvania, and others, found it necessary to have multiple track sections in certain areas.

A continuous four-track or even a three-track system cannot be justified in this corridor. However, railroads have handled traffic that ranged from ten or more passenger trains each way per day and a similar number of freight trains on two tracks that were signaled in only one direction with speed differentials nearly as great as being proposed for this corridor. This is close to the volumes being projected for this corridor. How did they manage to operate that many trains?

In the earlier discussion comparing railroad operations to highway usage it was stated that passing lanes are required on highways when traffic becomes heavy enough that faster vehicles can no longer overtake the slower vehicles. Similarly, railroads must add sidings or additional tracks when traffic becomes heavy. In 1948 the Pennsylvania Railroad was operating fourteen passenger trains each way per day and about ten freight trains each way per day between Chicago and Fort Wayne on a double tracked line that was not reverse signaled. That meant that twenty-four trains per day operated on each track or one per hour on the average. At that time nearly all track work, except rail renewal, was done manually without track occupancy so the need for reverse signaling to run around maintenance work was not as great as it was today. Therefore, very little reverse running was done during normal operations.

The need for passing sidings

The PRR handled the overtake problem by installing directional 1.5 to 2.5 mile-long passing sidings with interlocked switches on both ends on each side of the main tracks at intervals of 15-25 miles. The same technique is proposed for this corridor except that, instead of directional sidings along each main track, bi-directional center sidings between the two main tracks are proposed. The need for two sidings simultaneously to handle overtakes was minimal, consequently, center sidings are recommended. Instead of using two-mile sidings four-mile sidings are proposed. The rationale for the four-mile long sidings is described in Appendix G.

Therefore, in the ninety miles between Greensboro and Charlotte three passing sidings approximately four-mile long are proposed. These sidings would enable freight trains to be passed by passenger trains when clear distances aren't available on the other track. Normally, only one train was slowed or stopped.

Southward Freight Train At Thomas

The manner in which southward freight trains was handled at Thomas (MP 307), the north end of a siding located between MP 307 (south of Thomasville) and MP 311 (a relocated Bowers Interlocking) was as follows:

The dispatcher would check to see:

1. Is a southward passenger train by Pomona, about 12-15 minutes away?
2. If the answer was yes, was the Thomas-Bowers siding free of opposing trains?
 1. If the answer was yes, the freight train would enter the siding to be overtaken
 2. If the answer was no, the freight train would continue southward on Track 2.

If the Thomas-Bowers Siding was not free of opposing trains, passenger trains would have to overtake the freight train by crossing to the opposite track¹⁶ The effect of the addition of the siding was that the dispatcher would no longer try to thread passenger trains through and around freight trains, instead the freight trains would enter the siding to create a route so that the passenger trains would not be diverted. Ultimately, the siding contributes to improved reliability of the passenger schedules.

Center Sidings on the Piedmont Line

Three center sidings have been provided on the Piedmont Main Line to enable passenger trains to overtake freight trains. The simulation results indicate that the sidings do not eliminate the possibility that passenger trains may have to divert to the opposite track to overtake freight trains. Sometimes a freight train was unable to use a siding because another freight train of the opposite direction was occupying it. When this occurs the freight train proceeds on the same track and the passenger train follows it at a reduced speed until it reaches a location (interlocking) where the simulation determines that the opposite track was clear. The passenger train then diverted to the opposite track to overtake the freight train. In the model freight trains were not diverted to the other track to be overtaken by a passenger train. If the freight train diverted it would occupy the opposite track longer than a passenger train would, thereby reducing capacity.

The number of times each day that the three center sidings were used by freight trains is shown in Table C-10. Each time a siding was used it was safe to assume that a passenger train did not have to divert, saving a minimum of about three minutes for a passenger train each time it did not have to divert. However, a passenger train may have been following a freight train for a number of miles before the second track became available, therefore, the delay to the passenger train can be significantly greater than the three minutes lost in diverting from one track to another.

The simulation results indicate that numerous passenger trains diverted to the opposite track to overtake freight trains. Certain trains have a greater chance of diverting than others. To a great extent that depends on when freight trains operate, but local freight trains cause the most diversions.

¹⁶ If the diversion to the opposite track had caused too much delay in the simulation, the siding would have been assumed to have mid-siding crossovers that would enable freight trains of the opposite direction to occupy the same siding. The delays at Thomas-Bowers Siding were not that great and mid-siding crossovers are not recommended.

In a prior seven-day simulation, northward Train NC02 leaving Charlotte at 0600 was the most frequently delayed passenger train. On a typical day NC02 may divert three times (change tracks six times) between Charlotte and Greensboro. On one day:

- NC02 operated on the left hand track going north (track 2) between Charlotte and Junker to overtake a freight train that had changed crews on Track 1 at Charlotte.
- NC02 crossed to Track 1 at Junker ahead of the freight train, and then met a southward commuter train on Track 2 at Shamrock.
- NC02 continued on Track 1 to Sumner where it crossed to Track 2 to run around a local freight train working between Sumner and Salisbury.
 - Since NC02 does not stop at Salisbury moving the passengers to the right platform was not a problem.
- NC02 returned to Track 1 at Salisbury Junction and met a southward freight train on Track 2 between there and Duke.
- NC02 crossed back over to Track 2 At Maybelle to run around a local freight train working at Lexington.
- NC02 overtook a northward freight train on Track 1 between Thomasville and Varner.
 - This freight train had also used Track 2 to run around the local train and it had cleared into the Bowers-Thomasville siding only six minutes before NC02 arrived at Bowers.
- Since no southward trains were on Track 2 NC02 continued north on Track 2 to Varner where it returned to Track 1 ahead of the freight train.
- NC02 met a southward freight train on Track 2 at Jamestown.

NC02 departed Greensboro at 0725. Had no crossover moves been made NC02 could have departed Greensboro at about 0713; therefore, NC02 lost twelve minutes. On another day NC02 had no diversions.

On the same day as NC02 described above NC04 departed Charlotte on Track 1 at 0800. At Junker NC04 crossed to Track 2 to overtake a freight train on Track 1. NC04 stopped at the southward platform at the I485 Station; therefore, passengers would have had to be notified to cross over from the northbound platform¹⁷. Train NC04 returned to Track 1 at Shamrock and met southward NC01 and a southward freight train behind it between Shamrock and Adams. Train NC01 was delayed two minutes at Shamrock to let NC04 clear Track 2.

¹⁷ This could have been avoided if the freight train had been held in Charlotte Yard for about twenty minutes.

Table C-10
Piedmont Line Trains Using Sidings
By Location And Day

Location	Day 1	Day 2	Day 3	Day 4	Day 5	Day 6	Day 7	Avg.
Thomas-Bowers	ATIP	ATCX	ATIP	ATDH	ATNJ	ATNJ	ATNJ	
	LCL1	ATNJ	ATNJ	ATNJ	LCL1	EMTY	IPAT	
	NC16	BVLI	LCL1	BANO	LIHA	ERAT	LCL1	
	NOBA	ERAT	OILI	CXAT	LINF	LCL1	LINF	
	RRER	LCL1		LCL1		NC16	LIWA	
				LINF				
			LIWA					
			OILI					
Totals	5	5	4	8	4	5	5	5.14
Yad-Sal Jct.	ATCX	ATDH	ATWA	CALI	ATWA	ATIP	ATIP	
	KNLI	BANO	CALI	CALI	BANO	ATNJ	CALI	
	LCL2	BHLI	KNLI	KNLI	CALI	BANO	KNLI	
	LCL3	CALI	LCL2	LCL2	KNLI	CALI	LCL2	
		CHLI	LCL3	LCL3	LCL2	CHLI	LCL3	
		CXAT	RRAT	LCL3	LCL3	KNLI	MALI	
		KNLI	SHLI	MALI		LCL2	SVLI	
		LCL2		NOBA		LCL3		
		LCL3		RRAT		NOBA		
						RRNJ		
Totals	4	9	7	9	6	10	7	7.43
Kannapolis	LCL4	ATIP	EMTY	BANO	LCL4	LCL4	ATCX	
	LICH	ATWA	ERAT	IPAT	LISV	LICH	BHLI	
	LIMA	EMTY	LCL4	LCL4	NJAT		LCL4	
	LISV	LCL4	LIAT	LISH	NOBA		LIAT	
	MALI	LISH	LIBI	LISV	RRER		NJAT	
	NOBA	RRAT	LISH	NOBA			WAAT	
			NOBA	WAAT				
			RRNJ					
Totals	6	6	8	7	5	2	6	5.71

NC04 overtook a freight train standing in the Yad-Sal siding. This freight, which was going to Linwood Yard, had entered the siding to clear NC04 but it had to remain in the siding for NC03, after which it used Track 2 to enter the yard. NC04 met NC03, which was operating on Track 2 between Duke and Sharp.

At Bowers NC04 crossed to Track 2 to run around the same local freight train that NC02 had run around at Lexington, but which now was working at Thomasville. NC04 returned to Track 1 at Varner. It met another southward freight on Track 2 at Cox and departed Greensboro at 0926. Because of the stopping pattern of this train the best departure time it could have made with no diversions was 0917, so NC04 lost nine minutes.

Not all trains make the same diversions each day and not every train diverts every day; but when making a schedule, additional time must be allocated as if they were to divert. If this was not done trains would be late on many days, but on days when the trains did not divert trains would become ahead of time and must wait at some station. One way of handling this situation was to allow more time at a station than was really needed to allow trains to be on time. The added time is often called pad.

Table C-11
Simulated Running Times (hours:minutes)
NORTHBOUND NS Intermodal Trains
Charlotte to Pomona

Train	Day 1	Day 2	Day 3	Day 4	Day 5	Day 6	Day 7	Average
ATCX	2:23	2:27	2:08	2:10	2:09	2:24	2:24	2:17
ATIP	2:27	2:36	2:32	2:08	2:08	2:25	2:20	2:22
ATNJ	2:16	2:43	2:48	2:20	2:33	2:32	2:16	2:29
ATWA	2:08	2:17	2:24	2:15	2:33	2:24	2:09	2:18
NOBA	2:44	2:09	2:19	2:43	2:49	2:22	2:09	2:27
RRER	2:22	2:08	2:08	2:09	2:17	2:09	2:08	2:11
RRNJ	2:35	2:27	2:26	2:23	2:28	2:33	2:23	2:27
Average	2:25	2:23	2:23	2:18	2:25	2:24	2:15	2:22

Table C-12
Simulated Running Times (hours:minutes)
SOUTHBOUND NS Intermodal Trains
Pomona to Charlotte

Train	Day 1	Day 2	Day 3	Day 4	Day 5	Day 6	Day 7	Average
IPAT	2:00	2:19	1:59	2:23	2:04	1:59	2:22	2:09
CXAT	1:52	2:10	1:53	2:04	2:04	1:53	1:53	1:58
NJAT	2:07	2:15	2:02	2:28	2:48	2:29	2:56	2:26
WAAT	2:02	2:00	2:19	2:14	2:03	2:06	2:18	2:08
BANO	2:18	2:20	2:01	2:44	2:08	2:17	2:00	2:15
ERAT	2:39	2:40	2:49	2:31	2:24	2:37	2:26	2:35
RRAT	2:18	2:13	2:10	2:17	2:07	2:00	2:01	2:09
Average	2:10	2:16	2:10	2:23	2:14	2:11	2:16	2:14

Pomona Yard

Analyses performed while developing the simulation model through Greensboro and the Pomona Yard area indicated that trains working¹⁸ at Pomona Yard potentially could be a serious bottleneck when frequent passenger service is being operated. Experience has shown that a clear track should always be available to operate the passenger trains and non-working freight trains around working freight trains. Between Cox Interlocking and Elm Interlocking this would require single tracking the passenger and non-working freight trains on one track when a working train occupied one of the main tracks. Even this could subject trains to some delay, therefore, the possibility of establishing four tracks between Pomona and Elm was explored. It was concluded that the cost of installing a fourth track would be prohibitive, and that the track was infeasible for a number of reasons. Therefore, options, including operational changes, to provide the open track for passenger trains and non-working freight trains were evaluated.

Existing Operation and Facilities

The existing Greensboro Station is located to the west of the north-south NS Main Line¹⁹. Pomona Yard is located to the east of the NS Piedmont Main Line about two miles south of Greensboro. Tracks 1 and 2 are the main tracks; Track 2 is the

¹⁸A phrase used to denote a through-freight train stopping at a yard or wayside location to set-off and/or pick-up freight cars.

¹⁹ The NS Main Line extends between AF Interlocking in Alexandria, VA to Atlanta, GA, approximately 610 miles. It consists of the Washington, Danville, and Piedmont Subdivisions. The Danville District ends at Spencer and the Piedmont Subdivision extends through Charlotte.

southward track and Track 1 is the northward track. The existing passenger station/platform is located adjacent to Track 2.

Elm Interlocking, at the north end of Greensboro, is located at the intersection of the H Line to/from Raleigh and Goldsboro and the NS Piedmont Main Line. Passenger trains to/from Raleigh/Goldsboro use the crossovers at Elm Interlocking to access Track 2. Cox Interlocking is located 2.5 miles south of the existing Greensboro station.

Current Freight Operations

The Aycock Street and Pomona hand-operated crossovers are located at the north and south ends of Pomona Yard, respectively. A southward freight train on Track 2, which is to work at Pomona Yard, pulls south to the hand-operated Pomona crossovers, just south of Pomona Station and yard office, to make a pick-up, a set-off or both. The hand-operated crossovers provide access to the yard by enabling the train to cross Track 1²⁰. This move requires that no northward through running trains are approaching on Track 1. At the same time a northward freight train can be working on Track 1 near Aycock Street provided that the northward freight train is less than about 5,000 feet long. The northward freight train on Track 1 stops at the Aycock hand-operated crossovers to access the yard²¹. Long southward trains on Track 2 do not block the Aycock Street crossovers. A long northward freight train stopped at Aycock Street will block the switches at Pomona unless a cut (uncoupling) is made to provide access across Track 1 for a southward freight train. However, making a cut greatly increases the working time of the northward freight train on Track 1 and adds to the track occupancy time. The object of the operational analysis performed by the study team was to reduce track occupancy times by developing more efficient operations or facilities. In today's configuration northward freight trains can neither access Track 3 nor enter the yard except by using hand-operated switches. (Track 3 is a name arbitrarily given to the yard track east of and adjacent to Track 1.) Track 3 extends from Elm to a location south of the intermodal facility near MP 288, where it dead-ends. Unless a utility person is on duty to throw the switches, it is unlikely that long northward freight trains working at Pomona normally use hand-operated turnouts to pull the entire freight train into Track 3 to work. Once the move to Track 3 was completed the turnouts would have to be manually restored by the train crew; the time consumed in these manual operations make this a slow, inefficient operation. Therefore, it seems almost certain that northward freight trains work from Track 1 in today's operation. Southward freight trains having crossed over from Track 2 at Elm Interlocking also may work from Track 1. They would be able to return to Track 2 using the number 20 crossover at Pomona Interlocking; however, that violates Condition 2.

Freight trains operating between the Winston-Salem line and Pomona Yard use hand-operated switches to enter or leave the yard. A large industrial complex has grown on the Winston-Salem line west of Pomona. It was therefore assumed that the industrial complex is served from Pomona Yard. It also was assumed that through

²⁰ A southward freight train accesses the yard by moving clear of the Pomona crossovers on Track 2 and backing into the yard.

²¹ A northward freight train accesses the yard by moving clear of the Aycock Street crossovers on Track 1 and backing into the yard.

freight trains also operate to and from that line and use hand-operated switches to access/depart Pomona Yard²².

Proposed Freight Operations

One of the questions the operations analysis was designed to answer was:
How often would two freight trains be working at Pomona at the same time?

The analysis indicated that at least ten freight trains in each direction are projected to work at Pomona daily. The average track occupancy for each working freight train was assumed to be 45 minutes (the working time includes total occupancy, work, delay, and running between Elm and Pomona Interlockings). Therefore, freight trains worked approximately fifteen hours per day at Pomona, or 62 percent of the time. If all freight trains worked from Track 1, to keep Track 2 open for passenger trains, it was highly probable that a second working freight train would arrive before the previous working freight train has finished work. An analysis indicated that about 50 percent, or more, of the time a working freight train would arrive while another freight train was still working, therefore, nearly 10 freight trains per day would have to wait their turn, if all freight trains worked off the same track. It was concluded that this percentage was high enough that one working track for freight trains would not suffice.

Therefore, two requirements were considered necessary:

1. An open track (Track 2) between Pomona and Elm Interlocking for passenger and non-working freight moves while the second main track (Track 1) was occupied by a working freight train. Working freight trains would not use track 2.
2. Separate locations where southward and northward freight trains could work at Pomona simultaneously without conflicting with each other.

Condition 2 partially exists today, when freight trains are short enough, but both main tracks are used to accomplish this requirement. This operation would not satisfy the first condition and therefore would be unacceptable for future increased levels of passenger train operations and long freight trains.

Proposed Operating Plan

The new turnout to Track 3 at Cox would enable northward working freight trains to use Track 3 to set-off and pick-up. Southward freight trains would work off of Track 1. This configuration and operation would accomplish the first requirement of always having an open track (Track 2) for passenger train and through freight train operations, while freight trains work at Pomona. However, the turnout would not satisfy the second requirement of having the ability to work a northward and a southward freight train at the same time. Long northward freight trains would still block the switches at Pomona, and could potentially delay southward freight trains.

If two long freight trains arrived at approximately the same time the northward freight could delay the southward freight train from beginning to work by as much as 45 minutes. Thus, in a worst-case situation, the southward freight train could occupy Main Track 1 for nearly 1.5 hours. That would be unacceptable.

²²Data indicates that a Roanoke to Raleigh freight train (WSRA) operates each way through Winston-Salem and Pomona. A Raleigh to Winston-Salem train (RAWS) also operates.

A configuration and operating plan that would prevent long working freight trains from blocking other working freight trains was therefore developed. The recommended concept is as follows.

A new "Pomona Running Track" between the Intermodal Terminal and Aycock Street would be less than a main track but more than a yard track and it would be controlled by the yardmaster at Pomona.

Northward working freight trains would enter Track 3 at the relocated Cox Interlocking and proceed to the Intermodal Terminal, where they would enter the new running track at about MP 287.15. The normal position of the switches would be from Track 3 to the Pomona Running Track so that the northward move can be made, at yard speed, without stopping. Between MP 287.15 and Pomona. The Pomona Running Track would be the track immediately east of Track 3. A determination would have to be made whether the switches should be locked in their normal positions, except when yard-switching crews were using them. At Pomona this track is currently aligned directly into a thoroughfare track through the body of the yard to Chapman Street. Going northward from Chapman Street to Aycock the thoroughfare track would be aligned directly to Track 3. Track 3 is not continuous today and would continue to end just south of Aycock.

The running track would enable intermodal trains to make set-offs directly into the Intermodal Terminal and/or pick-ups from the track east of the Pomona Running Track or the Intermodal Terminal. Other working freight trains would pull north to approximately Aycock Street to ensure that the rear of the intermodal train cleared the Intermodal Terminal.

If the pick-up or set-off involved the east portion of the yard (to the left of the running track) the intermodal train would stop at Chapman Street. The first yard track east of the Pomona Running Track should be removed to enable freight train crews to have an open space to walk, inspect, couple, and uncouple cars.

Long northward freight trains would still block access to the east (left) portion of the yard at Pomona while working, but the west portion of the yard (to the right of the running track) would be open for switching and access by southward working freight trains on Main Track 1.

The Pomona Running Track also would enable southward freight trains of any length to work clear of both main tracks and enable northward and southward freight trains to work independently and in parallel without conflict. Accessing the Running Track would require that Track 1 be crossed at both Cox and Elm Interlockings. However, the crossing freight trains would occupy Track 1 significantly less than a southward freight train working from it.

Therefore, freight trains of both directions would work off the running track, unless the Running Track was in use by another working freight train. In that case the second freight train would work from Track 1

Two additional crossovers at Chapman Street would enable northward freight trains to work on Track 1 without being blocked by a long southward freight train standing on the switches at Aycock Street. The crossovers at Chapman Street would enable two long freight trains of any length to work simultaneously without conflicting with each other.

Pomona Interlocking would provide interlocked access to Track 3. The entry to the Winston-Salem line does not require a 45 mph turnout because the speed on the Wye track behind the frog apparently is restricted to 10 mph and apparently the signal aspect leading to the line is slow speed, therefore number 10 crossovers would be installed. The crossovers would not adversely impact southward Winston Salem-bound freight trains. The interlocked crossovers should reduce the time to access the Winston Salem Line from Pomona Yard. The right hand 45 mph crossover from Track 1 to Track 2 would be retained.

Simulation Results

Delays to northbound trains at Pomona caused by trains working ahead during a seven-day simulation of the proposed operation are shown in Table C-13. These northbound train delays occurred on new Track 3 between Cox and Pomona. Delays to southbound trains at Pomona caused by trains working ahead of a freight train during a seven-day simulation are shown in Table C-14. These southbound trains were delayed on Main Track 1 between Elm and Aycock Street.

Conclusion

The simulation indicated that the recommended configuration and operations achieved the desired objective of enabling northward and southward freight trains to work at Pomona Yard with out interfering with passenger train and through-freight train operations.

High Point

A local freight train serving the M Line to Asheboro apparently originates at High Point²³. A small yard is located east of the siding at about MP 300.5. The manner in which High Point is serviced by NS is not known, so it was assumed that an early morning train originating at Linwood sets off cars for the originating local and a late afternoon train picks up cars from High Point to be delivered to Linwood. This operation enabled inbound cars to High Point to be placed the same day they depart Linwood and the cars picked up by the High Point local to be delivered to Linwood on the same day they are picked up. The High Point, Thomasville and Denton Railroad (a CSX property) Freight also serves High Point. It is not known if the railroad interchanges cars with NS.

The left hand and right hand crossovers between Tracks 1 and 2 recently have been removed. Consequently, a northward local on Track 2 must serve the active industry at MP 301 and another industry at MP 298.5. These industries have facing point switches going south. It is not recommended that these apparently removed crossovers be replaced.

²³ The NS timetable shows that a train register for originating and terminating trains exists at High Point.

Table C-13
Delays To NORTHBOUND NS Trains At Pomona
Caused By Other NS Trains Working Ahead

Day	Train	Arrived	Departed	Delay (mins.)
Day 1	LIOI	5:00	5:26	0:26
	LINF	6:08	6:14	0:06
	ATNJ	6:31	7:13	0:42
	NOBA	13:44	14:17	0:33
Day 2	LINS	5:33	6:01	0:28
	LIOI	6:20	7:13	0:53
	ATNJ	7:30	8:00	0:30
Day 3	LINS	5:04	5:42	0:38
	LINF	6:09	6:29	0:20
	ATNJ	6:58	7:14	0:16
	LIHA	14:15	14:24	0:09
	ATCX	14:45	15:32	0:47
Day 4	LINS	4:27	5:06	0:39
	LINF	7:03	7:28	0:25
	ATWA	17:03	17:31	0:28
Day 5	LIOI	5:28	6:05	0:37
	LINF	6:53	6:56	0:03
	ATNJ	7:13	7:50	0:37
	NOBA	13:56	14:33	0:37
Day 6	LINS	5:34	5:58	0:24
	LIHA	14:09	14:20	0:11
	ATCX	16:48	16:57	0:09
Day 7	LINS	5:31	5:43	0:12
	ATNJ	7:02	7:06	0:04
	NOBA	14:20	14:21	0:01
	ATWA	16:34	16:49	0:15

Note: These delays occur on new Track 3 between Cox and Pomona.

Table C-14

**Delays To SOUTHBOUND NS Trains At Pomona
Caused By Other NS Trains Working Ahead**

Day	Train	Arrived	Departed	Delay (min.)
Day 1	WALI	3:26	3:37	0:11
	NJAT	4:32	4:38	0:06
	BANO	12:08	12:29	0:21
	HALI	19:48	19:59	0:11
Day 2	NJAT	3:50	4:13	0:23
	BANO	12:58	13:15	0:17
	HALI	20:04	20:13	0:09
Day 3	NJAT	3:46	4:16	0:30
	BANO	12:14	12:43	0:29
	HALI	20:55	21:12	0:17
	RAWS	21:40	22:13	0:33
Day 4	WALI	2:27	2:48	0:21
	NJAT	3:39	4:06	0:27
	RAWS	21:46	22:16	0:30
	OILI	23:19	23:29	0:10
Day 5	NJAT	5:03	5:06	0:03
	WAAT	20:31	20:59	0:28
	RAWS	21:45	21:48	0:03
Day 6	NJAT	4:06	4:16	0:10
	WAAT	20:24	20:25	0:01
Day 7	NJAT	4:06	4:51	0:45
	IPAT	11:27	12:38	1:11
	BANO	12:18	13:41	1:23
	WAAT	20:54	21:36	0:42
	RAWS	22:24	22:26	0:02

Note: These trains are delayed on Main Track 1 between Elm and Aycock Street.

Linwood Yard

Spencer Yard at Linwood, NC is alternately referred to as Spencer Yard or Linwood Yard. Linwood is a major freight classification Yard for the Norfolk Southern system. Trains from distant points arrive at Linwood and have their cars sorted

(classified) for other points on the system. Linwood performs as a hub. For example, cars going to Charleston, SC may arrive on inbound trains from Norfolk, Roanoke, Knoxville, TN or other distant points such as Binghamton, NY. The cars to Charleston are grouped together for a train going to Charleston or other points, north of Charleston. About twelve inbound trains daily arrive from the north or south to have their cars classified to about the same number of outbound trains.

Sharp Interlocking at MP 324.6 consists of two crossovers between the main tracks and a turnout, which is used by trains to enter the receiving yard at Spencer Yard.

Duke, located at the south end of Spencer Yard, consists of inbound and outbound yard leads. The inbound lead is the entry to the receiving yard and the outbound lead is the exit from the departure yard. The leads are arranged in parallel to permit outbound (southward) trains to leave the yard to Track 2 (south crossover) while inbound (northward) trains enter the yard from Track 1 (north crossover).

Local Freight Trains From Linwood

Linwood serves as a distribution point for local freight trains that switch industries along the Piedmont Main Line, however NS did not provide the schedule for local freight trains. It was therefore necessary to generate an operating plan by making assumptions as to how often industries are served and how long it takes to switch.

A video of the territory between Pomona and Charlotte was reviewed to determine where local trains might work with regularity. An earlier simulation performed for NCDOT provided data on the local freight trains that may be operating. The simulation did not provide data on track occupancy and apparently did not include service to all industries having local freight service. Therefore a local service schedule that served the points that have active industries was developed.

The following local schedules were simulated.

LCL1. A local train named LCL1 for modeling purposes originated at Linwood at 5:00 am²⁴. The train carried cars for the same day local originating at High Point.

This train operated northward on Track 2 (left handed) serving the industries between Maybelle and Lee, which have trailing switches for northward travel. The train arrived on the right hand track at Lexington at approximately 06:00. Between 06:00 and 08:00 the train sorted the WSSB interchange and served industries at Lexington including those off Track 2. Any cars received from the WSSB interchange that were destined to High Point as well as those from Linwood, were delivered by this local to High Point for placement by the High Point local on the same day. This local also carried any cars destined to points between High Point and Pomona.

It was assumed that this train would arrive at Thomasville at approximately 08:15 and would switch the one trailing point track north of Thomasville. The train finished at Thomasville at approximately 08:45 and arrived at High Point at 09:00.

²⁴ There should be a four-hour gap between northward freight trains and no passenger trains at that time.

High point cars were set off. Cars picked up between Linwood and High Point that were to be taken to Linwood for classification may, were set off at High Point, rather than being carried through to Pomona, if yard space permitted. Cars from the High Point local or the HPT&D going north were picked up. It was assumed that work at High Point was finished at 10:00.

LCL1 switched the trailing point industries between Hoskins and Cox. It was assumed that LCL1 would arrive at Pomona at approximately 11:00. At Pomona, cars for Pomona were set off; some cars remained with the train for the return trip; and cars for High Point and other points south of High Point were picked up.

At this time the crew would have been on duty seven or more hours, so it was assumed a new crew was called at approximately 10:00 at Linwood. The new crew was driven to Pomona, and the on-duty crew was driven back to Linwood to sign-off. It was assumed that the new crew would leave Pomona at 14:00.

LCL1 switched the trailing point industries between Cox and Hoskins and arrived at High Point at 15:00. The train operated left-handed on Track 1 from Hoskins to facilitate, picking up or setting off at High Point. This train cleared the main track in the long siding, and picked up the Linwood cars dropped off on the northward trip as well as the Linwood cars produced that day by the High Point local. At High Point, this train ran to MP 302.5 and back to serve the industry located adjacent to Track 1 as well as the two industries adjacent to Track 2. It was assumed that the work at High Point finished at 18:00, approximately when the High Point local went off duty, if it worked the full ten hours allocated to it.

LCL1 local continued south on Track 1 to work the industries having a facing point in the northward direction at Thomasville. Even though it appears many of these tracks are unused, it was assumed that some work was done there. The train finished Thomasville at 19:00 and arrived at Lexington on Track 1 at 19:30, assuming that there was cars to be set-off at the WSSB interchange. Carrying these cars through to Linwood and back the next day would have delayed them a day. At High Point, the WSSB cars, if any, were arranged to be on the head end of the train. They were moved onto the run-around track off Track 1 and placed into the interchange track. These tasks should have been completed by 20:00, after which the train ran to Linwood to an assumed 21:00 sign off, after being on duty eleven hours.

LCL2. A local train, named LCL2 for modeling purposes, was originated at Linwood at 03:00 and served two industries on Track 2 between Linwood and Salisbury. At Salisbury the local worked outside the limits of the model doing unknown work until it reappeared seven hours later to return to Linwood.

LCL3. Local train LCL3 originated at Linwood at 07:00, ran to Yadkin Junction, and served the N Line to Albemarle. LCL3 was assumed to return to Yadkin Junction at about 14:45 and returned to Linwood.

LCL4. It was assumed that local LCL4 originated in Linwood at 21:30, traveled to Charlotte and returned. The local passed Salisbury at 22:00. Industries with trailing switches for southward moves between Reid and Kannapolis were served and LCL4 arrived at Kannapolis at 22:15. All industrial switches in Kannapolis are facing for southward moves so Kannapolis cars were set-off on the siding for placement on the return trip. The train departed Kannapolis at approximately 22:45.

There are no trailing switches through Concord. The industries between Haydock and Junker were served between 23:01 and 23:59. It was assumed that Charlotte yard crews would serve the industries between Junker and AT&O Junction.

The train turned in Charlotte Yard and was ready to return at 01:30. Industries between Junker and Adams, including Concord, were switched, and LCL4 arrived at Adams at 03:00. At Adams the local operated left-handed to Kannapolis, departing from Kannapolis at 04:00. Left-handed operation continued to Reid to serve Sumner. Industries between Adams and Salisbury were switched with an anticipated 05:30 departure from Salisbury. The crew then ran to Linwood and signed-off at 06:00, after nine hours on duty. Initially LCL4 was scheduled to operate during daylight hours but the large number of passenger trains did not provide sufficient working time and created numerous diversions for passenger trains.

Salisbury Configuration And Operation

Four miles south of Duke, a mostly unused Salisbury Yard extends along Track 2 to Salisbury Interlocking, where trains to/from Asheville (the NS Asheville Line) leave/enter the Piedmont Main Line on a double-tracked Wye. The Wye tracks joining the Main Tracks at Salisbury are called the north Wye and are arranged so that northward trains from the Asheville Line can cross Track 2 to access Track 1 while a southward train is also entering the Asheville Line from Track 2. The speed of trains on the Wye is restricted to 15 mph and this may cause long freight trains to occupy the interlocking at Salisbury five to eight minutes, depending upon whether the train is stopped or not. The double track of the Asheville Line extends 2.1 miles to Majolica where the line becomes single track at a spring switch. The track between Salisbury and Majolica has automatic block signals for unidirectional flow only. Therefore, trains arriving at Salisbury on the left-hand track of the Asheville Line should be rare. About four trains in each direction use the Asheville Line each day to and from Spencer Yard.

Since a south Wye also joins the Piedmont Main Line from the Asheville Line, the interlocking joining the north Wye and the Piedmont Main Line at MP 333 has been named Saljct for modeling purposes.

Operations Analysis: Duke to Salisbury Junction

Several curves in Salisbury have highway crossings in them. It is proposed to maintain the current superelevation and alignment in the curves and restrict the speed to 70 mph through the city of Salisbury.

The initial operating analysis indicated that with the anticipated level of train service on the Piedmont Main Line that trains coming from the Asheville Line most likely would not be able to:

1. Cross the flow of southward trains on Track 2 to go onto Track 1 at Saljct,
2. Operate on Track 1 six miles north to Duke, and
3. Cross from Track 1 to Track 2 to access the turnout on Track 2 leading to the Spencer Yard arrival yard.

The following requirements would have to be satisfied to enable a Spencer Yard-bound freight train to cross Track 2 to access Track 1 at Saljct without delaying a southward train on Track 2.

1. A gap of about ten minutes between southward trains
2. A simultaneous ten-minute clear window ahead of each northward freight train on Track 1 at Saljct, and
3. A fifteen-minute clear window ahead of each passenger train on Track 1 at Saljct.

The last two requirements would ensure that northward trains are not delayed by the freight train clearing in Spencer Yard.

Upon arrival at Duke another ten-minute gap between southward trains is needed to let the Asheville Line train enter the yard from Track 1.

Is a fifteen-minute gap before a northward passenger train adequate? The fifteen-minute gap ahead of a passenger train would begin when the signal is displayed to the Asheville Line train at Saljct. It is estimated that it would take at least five minutes to start the train and pull the entire train onto the main track at 15 mph²⁵. The northbound freight train would then accelerate to whatever speed it could achieve before it must begin to slow down to crossover at Duke Interlocking to enter the yard. Eight minutes for the head end to traverse the four miles to Duke Interlocking is a good estimate. It would take at least another four minutes for freight train to cross to Track 2 and into the arrival yard and for the rear of the train to clear the main track. If a passenger train is not to be delayed, it must not have passed the distant signal for Duke. Therefore, the passenger train must be at least three minutes away from Duke Interlocking. Therefore about twenty minutes (5+8+4+3) after the signal is displayed by for the Asheville Line freight train at Saljct a following passenger train could pass Duke Interlocking.

Since the time reference started at Saljct, by deducting the four minute non-delay running time for the passenger train to run between Saljct and Duke, a sixteen minute gap would be needed at Saljct. The 16 minutes optimistically assumed that the freight train could enter the yard without being delayed by conditions in the yard (filled receiving tracks) or by southward trains at Duke. If a southward freight train were approaching Duke the Asheville Line freight train would likely enter the yard first to prevent a delay to a following passenger train. If the southward train were a passenger train, a determination would need to be made as to which passenger train was to be delayed. Therefore the fifteen-minute gap ahead of northward passenger at Saljct was quite conservative.

An alternative would be to operate northward Asheville Line freight trains between Salisbury and Duke on Track 2 rather than Track 1. Northward traffic on the Piedmont Main Line would not be impacted at all if this alternative were selected. This concept has two drawbacks. First, a twenty-five to thirty-minute window at Saljct would be needed to make the move from Saljct to Duke between southward trains on Track 2. Secondly, this move would block an outbound train from Spencer Yard from leaving until the Asheville Line freight train was yarded.

²⁵ The Wye track speed on the Asheville Line is 15 mph

Center Siding Yadkin to Salisbury Junction

A new third track west of Track 2 between Duke and Saljct would let Asheville Line freight trains operate in both directions totally independently of Piedmont Main Line traffic between Duke and Saljct. Windows on either Tracks 1 or 2 would not be needed for through running trains; however parallel moves into or out of the yard would not be possible. The third track would require a large 639-foot third-track bridge over the Yadkin River, which lessens the viability of that option.

Scaling back the third track to the south end of the bridge over Yadkin River would appear to be a reasonable, less-expensive compromise. The time that Track 2 would be occupied would be shortened - since the Yadkin River is about one-mile from Duke, compared to five miles from Saljct. However a new third track west of Track 2 would have little value for Piedmont Main Line trains. Therefore, it was concluded that the third track, if it were to be built, would provide the maximum utility if it were constructed between Tracks 1 and 2.

The center siding north of Saljct would be one of the three center sidings that would be constructed between Greensboro and AT and O Jct

The yard track west of and adjacent to Track 2 would be upgraded to create a new track from Saljct at MP 333 to MP 330.7 and a new track would be built from MP 330.7 to MP 328.5 at the south end of a 1.7-degree curve. The new track would best be built adjacent to Track 1 north of Salisbury Yard. Yad interlocking would be installed south of the Yadkin River; it would actually be an extension of Duke. It is simulated in that way. Cut and throws would be necessary at MP 330.7. The new track would be aligned so that it is the northward main Track 1 at Yad. The current Track 2 would become a signaled center siding equivalent to a main track. The current Track 2 would remain Track 2. Number twenty turnouts would connect the siding Tracks 1 and 2 at Yad; these would enable a northward train on the siding to enter either track at 45 mph. In addition a right-hand number twenty crossover would be placed between the siding and Track 2 to enable trains to crossover from Track 2 to the siding to Track 1 at Yad/Duke.

The center siding operated in the following manner. Northward freight trains that enter Spencer Yard entered the center track at Saljct unless it was known that they could continue on Track 1 and enter the yard without being delayed at Duke or delaying a train behind it. Northward Asheville Line trains entered the center track unless it was known that they could operate against the flow on Track 2 to Duke and enter Spencer Yard without being delayed or delaying other trains. Asheville Line trains entering the center siding required a ten-minute gap on Track 2 between southward trains. Northbound Asheville Line freight trains entering at Saljct could not avoid interfacing with southward Piedmont Main Line trains.

The center siding eliminated:

1. Any conflict of northbound Asheville Line freight trains with northward through-running trains on Track 1, and
2. The need for the simultaneous windows on Tracks 1 and 2 to access Track 1 from the Wye at Saljct.

The center siding provided northward freight trains at Yad a location to wait clear of through running trains on Tracks 1 and 2 if they could not immediately enter Spencer Yard. Trains on the center siding at Yad had two routing choices. The first choice would be to use Track 2 between Yad and Duke to enter Spencer Yard without regard to northward trains on Track 1 if the following three conditions were met:

1. No outbound train was ready to leave or was leaving the yard,
2. A gap of fifteen minutes between southward trains existed, and
3. Room was available in the receiving yard.

If the first condition was not met, the alternative was to use Track 1 and the train could enter the yard in parallel to the outbound train if the following three conditions were met:

1. A gap of fifteen minutes between southward trains existed,
2. A gap of fifteen minutes between northward trains existed, and
3. Room was available in the receiving yard.

Southward freight trains normally operated on Track 2 south of Yad but they also may use the center siding to be overtaken by southward passenger trains when the siding was available. Passenger trains normally did not use the siding.

Charlotte Yard

Existing Configuration/Operations

Charlotte Yard, like Pomona Yard, is located east of the Main Tracks. Crossovers access the yard from the Main Tracks. Again like Pomona, long trains can block trains of the opposite direction from working at the yard. Long trains were not a problem when the yard was originally built, because trains of that era could fit between the crossovers.

About ten trains per day in each direction would work at Charlotte. Therefore, the potential of having trains conflicting with each other is about the same as at Pomona.

However, unlike Pomona, it is possible to remove all working freight trains from both of the two Main Tracks, so working trains would not interfere with passenger trains and non-working freight trains. A configuration that would enable two long freight trains of the opposite direction to set-off and pickup without conflicting with each other also was developed.

AT&O Jct.: A Problem Area

AT&O Jct. Interlocking is partially located on a 1.8-degree curve with two inches of superelevation in the main tracks. Consequently, some turnouts may have negative superelevation. All turnouts and crossovers are number 10s, which limits train speeds into and out of the yard or to the O Line to 10 mph, so a configuration that would permit greater entry or departure speeds to/from the proposed freight tracks is desirable. Slow entry/departure speeds result in freight trains tying up AT&O interlocking for significantly periods of time. Therefore, it is necessary to modify AT&O Jct.

The NS crosses the CSX at Graham on a curve. Currently two NS tracks cross one CSX track. It is recommended that two additional NS tracks be added to separate the freight and passenger operations in Charlotte.

The Northward Freight Track

Creating a working track for northward freight trains independent of Main Tracks would be relatively straightforward. The yard track adjacent to Main Track 1, called Track 3 for convenience, would be upgraded to serve as the northward freight-working track. Northward trains would enter Track 3 at a new interlocking (named **Stadium** because of its location next to Erickson Stadium) immediately south of the proposed new passenger station. Northward freight trains, after entering the new Track 3, would proceed to their working location near MP 375.5 without interference from or interfering with other NS freight trains or passenger trains. However, the freight trains would have to cross the CSX tracks at grade at Graham Interlocking. The northward freight train working location would be about 7,500 feet from the CSX crossing so nearly all trains should be able to work with the rear of the train clear of the CSX at-grade crossing. However, Lidell Street may be blocked. The potential of closing this crossing should be evaluated. Northward working freight trains that arrive before the previous working train has departed would wait south of the CSX crossing, leaving the crossing clear for CSX trains. Over 25 CSX moves per day, including yard moves, would use the crossing.

Upon completing work, northward freight trains would access Track 1 to proceed northward. Entering the main track over the existing number 10 mph crossovers, if AT&O Junction remains un-reconfigured, would be slow. Therefore a new interlocked left hand number 15 or number 20 crossover from Track 3 to Track 1 would be installed just south of the AT&O curve so that trains could depart at 30 mph.

The new interlocked crossover from Track 3 to Track 1 would replace an existing hand operated crossover between Track 3 and Track 1 and the existing crossover would be removed. Two right-hand crossovers between Tracks 3 and 1 and Tracks 1 and the yard track adjacent to Track 3 also would be removed. Since northward working freight trains would no longer be occupying the Main Tracks, these crossovers would no longer serve a useful purpose. A pair of crossovers, located between Tryon Street and Lidell Street, between the same tracks would remain for emergency use.

Simulation Results

The number of northbound trains delayed at Charlotte caused by other NS trains working ahead of them during a seven-day simulation is shown in C-15. These trains were delayed on new Track 3 between Stadium and CSX Graham crossing. A portion of the delay for these trains occurred between Charlotte Jct. and Stadium.

**Table C-15:
Delays To NORTHBOUND NS Trains At Charlotte
Caused By Other NS Trains Working Ahead**

Day	Train	Arrived	Departed	Delay (min.)
Day 1	BHLI	10:27	11:00	0:33
	CHLI	12:57	13:22	0:25
Day 2	NOBA	10:16	10:57	0:41
	ATCX	11:44	12:10	0:26
Day 3	RRNJ	7:58	8:24	0:26
	BHLI	9:08	9:39	0:31
	NOBA	9:41	10:47	1:06
Day 4	RRNJ	7:19	7:26	0:07
	BHLI	8:34	8:35	0:01
Day 5	NOBA	9:16	10:13	0:57
	BHLI	10:15	11:07	0:52
	CHLI	13:28	14:10	0:42
Day 6	RRNJ	7:29	8:10	0:41
	BHLI	8:58	9:17	0:19
	NOBA	10:11	10:32	0:21
	CHLI	13:34	14:24	0:50
	ATWA	14:26	15:17	0:51
	SVLI	20:56	21:13	0:17
Day 7	NOBA	10:27	11:19	0:52
	CHLI	13:03	13:37	0:34

Notes: These trains are delayed on new Track 3 between Stadium and CSX Graham crossing.
Some of the above trains may have also incurred some delay between Stadium and the CSX crossing at Graham

The Southward Freight Track

The southward freight track would require more extensive changes. A third track, new Track 4, would be installed between MP 372 at Junker Interlocking and AT&O Jct. **Junker Interlocking** would be configured to enable southward freight trains to enter

Track 4 at 45 mph. Track 4 also would provide a holding location for a southward freight train to wait short of the yard without blocking Track 2. Avoiding freight trains blocking Track 2 is essential to facilitate the operation of 17 daily southward passenger trains; including seven morning commuter trains from Concord. The new Track 4 would be placed through the east opening under 30th Street overhead bridge. A new connecting track would parallel the switching ladder at the north end of the yard so that standing or arriving working freight trains would not block switching operations.

This new connecting track may require straightening the small stream parallel to the switching ladder and a retaining wall may be required to support the track.

The new connecting track would tie into the existing easternmost track in the yard, which is adjacent to the Intermodal Terminal, and would be upgraded to become a new running Track 4 between AT&O Jct. and Tryon Street. This track apparently is used as a thoroughfare track today. Track 4 has access to the north and south entrances to the Intermodal Terminal, therefore intermodal trains could use Track 4 to directly set off or pick up to/from the Intermodal Terminal. However, as previously described, it has been assumed that this work would be normally accomplished from Track 3.

The new Track 4 would become parallel to the Piedmont Main Line at Tryon Street. Southward pick-ups and set-offs would be made using the switches from Track 4 to the yard at Tryon Street. Alternatively, the switches located near the south end of the intermodal terminal could be used.

The rear of long southward freight trains working at Charlotte Yard would be at or north of AT&O Junction; which is the reason that Track 4 would be isolated from the switching lead. Track 4 would reenter the Piedmont Main Line at Stadium Interlocking south of the proposed Charlotte passenger station. In emergency situations the hand-operated crossovers at Tryon Street would provide access to the Main Tracks at that location.

The configurations described would enable northward and southward freight trains to set-off and pick-up at Charlotte without conflicting with each other and the goal of enabling passenger trains and non-working freight trains to have their own tracks would be achieved.

Tracks 3 and 4 would be signaled between Stadium Interlocking and Tryon Street. Track 3 would have a 30 mph maximum speed between Stadium Interlocking and AT&O Junction. The hand-operated crossovers south of Tryon Street would be electrically locked. All switches on Northward Freight Track 3 between Tryon Street and AT&O Junction would have switch locks installed to enable the 30 mph MAS to be established between Tryon Street and AT&O Jct. Eliminating the yard speed on Track 3 and increasing it to 30 mph would enable long trains that have finished work to accelerate to 30 mph prior to accessing the Piedmont Main Line.

Track 4 would have a 30 mph maximum speed between Tryon Street and Stadium Interlocking. Switch locks would be installed on the numerous switches between Tryon Street and AT&O Jct. to eliminate the restricted yard speed between those points. Track curvature near the intermodal terminal may restrict speed to that level anyway. It was assumed that timetable instructions would say that the normal position of switches would be for movement on Track 4 and that they would be locked except when being used for switching moves.

Simulation Results

The number of southbound freight trains delayed at Charlotte by other NS freight trains working ahead of them during a seven-day simulation is shown in Table C-16. These trains were delayed on the new Track 4 between Junker and ATO Jct.

Table C-16
Delays To SOUTHBOUND NS Trains At Charlotte
Caused By Other NS Trains Working Ahead

Day	Train	Arrived	Departed	Delay (mins.)
Day 1	WAAT	22:01	22:58	0:57
Day 2	LIAT	7:54	7:57	0:03
	LICH	14:15	14:28	0:13
	RRAT	21:03	21:43	0:40
	WAAT	22:13	22:49	0:36
Day 3	LICH	13:30	13:39	0:09
Day 4	LIAT	7:58	8:05	0:07
	LICH	13:44	13:55	0:11
	RRAT	21:05	21:17	0:12
Day 5	IPAT	13:12	13:57	0:45
	BANO	14:15	14:22	0:07
Day 6	LICH	13:43	13:49	0:06
Day 7	LIAT	9:09	9:29	0:20
	BANO	16:15	16:37	0:22
	LISV	17:07	17:46	0:39
	RRAT	20:37	21:14	0:37

Note: These trains are delayed on the new Track 4 between Junker and ATO Jct.

CSX Delays at Graham Interlocking

The large increase in passenger trains operating over the CSX crossing at Graham interlocking resulted in approximately 50 percent of the 28 CSX trains per day being delayed. Presently, only two passenger trains per day operate over the CSX crossing. Twenty-two inter-city trains and 18 commuter trains would operate over the CSX crossing in 2015. The passenger trains should have priority while NS and CSX freight trains would use the crossing on a first come-first served basis. CSX train freight trains would not be permitted to enter the crossing for a period of about ten minutes

before the arrival of each passenger train. Eight minutes per freight movement has been assumed, so that leaves only two minutes to display a signal for passenger trains.

The CSX Charlotte Subdivision is single tracked and therefore a window for NS trains following a CSX train always existed. It was assumed that successive CSX moves would be fifteen or minutes apart. Therefore NS delays were small.

The delays to CSX freight trains for a seven-day period are shown in Table C-17.

Table C-17
Delays to CSX Transportation trains at Graham crossing in Charlotte,
caused by Norfolk Southern freight trains and passenger trains

	Day 1	Day 2	Day 3	Day 4	Day 5	Day 6	Day 7
Number of trains delayed	15	14	12	12	16	13	14
Maximum delay in minutes	46	24	37	32	21	24	38
Total delay in minutes	186	150	176	128	126	144	159
Average delay (mins.)	12.4	10.7	14.7	10.7	7.9	11.1	11.4

Charlotte Passenger Tracks And Passenger Station

Charlotte Station, located at MP 377.9, would consist of three tracks west of Track 3. Tracks 1 and 2 between AT&O Junction and Stadium would be the passenger tracks through Charlotte. A pair of number fifteen interlocked crossovers between Tracks 1 and 2 would be located at 6th Street (MP 377.5). **6th Street** is a new interlocking at the north end of Charlotte Station. A number fifteen turnout off Track 1 would lead to a third station track. At this time, only three station tracks are planned.

Two additional station tracks may later be placed east of Track 4 for a possible commuter service from the CSX. A single-track lead parallel to and east of Track 4 between the CSX at Graham (MP 377.1) and Stadium would provide access to these tracks. In addition a second at grade crossing over the CSX at Graham may be restored to provide access to the former O Line for additional commuter service.

Freight trains that do not work at Charlotte nor terminate at Linwood would change crews at Charlotte. These trains could operate on Tracks 1 and 2 through Charlotte Station and exchange crews at a convenient location between Stadium and AT&O Junction. It was assumed the exchange would take about ten minutes. Freight trains that pick up or set off at Charlotte would not use the passenger tracks.

Stadium interlocking, just south of Charlotte Station, would initially consist of three number twenty crossovers and three number fifteen turnouts. The crossovers would be arranged so that freight trains can move in parallel to and from Tracks 3 and 4. It was assumed that most southward freight trains going to Columbia would operate left handed between Stadium and Charlotte Junction.

Charlotte Station to Charlotte Airport

A servicing and storage yard would be constructed south of the Airport Station, adjacent to the Airport Freeway. Just south of Little Rock Road a loop track would diverge westward from the southbound main track, passing over both main tracks and becoming parallel to the northbound main track. The new passenger storage and servicing tracks would be just south of Little Rock Road east of the northbound main track. Three equipment sets will layover at night at the Airport.

Two trains to Atlanta originated each day at Washington and re-entered the SEC at Greensboro. These trains stopped at the Airport.

Three of the seven commuter trains from Concord each morning turned back to Concord for a second trip. Thirty-minute headways from Concord for this service were assumed. If these trains operated to the Airport they would not be able to return to Concord for a second trip. Layover facilities in Charlotte for day storage of commuter trains have not yet been identified. It was assumed that overnight facilities will be provide somewhere near Adams Interlocking.

**ANNEX TO APPENDIX C:
Graphical Presentation of Dispatching Situations**

For readers interested in an alternative explanation of the complex dispatching situations discussed in Appendix C, this annex provides a generalized, graphical presentation.

Meets and Overtakes Involving Three or More Trains

When evaluating the status of southward freight train approaching the north end of Siding A and making the decision whether to release the southward freight train (F1), a train dispatcher would:

- Look ahead of the southward freight train (F1) for opposing northward freight or passenger train (F2);
- Look behind the southward freight train for an overtaking southward passenger train (P1); and
- Look beside the freight train while it is waiting in a siding.

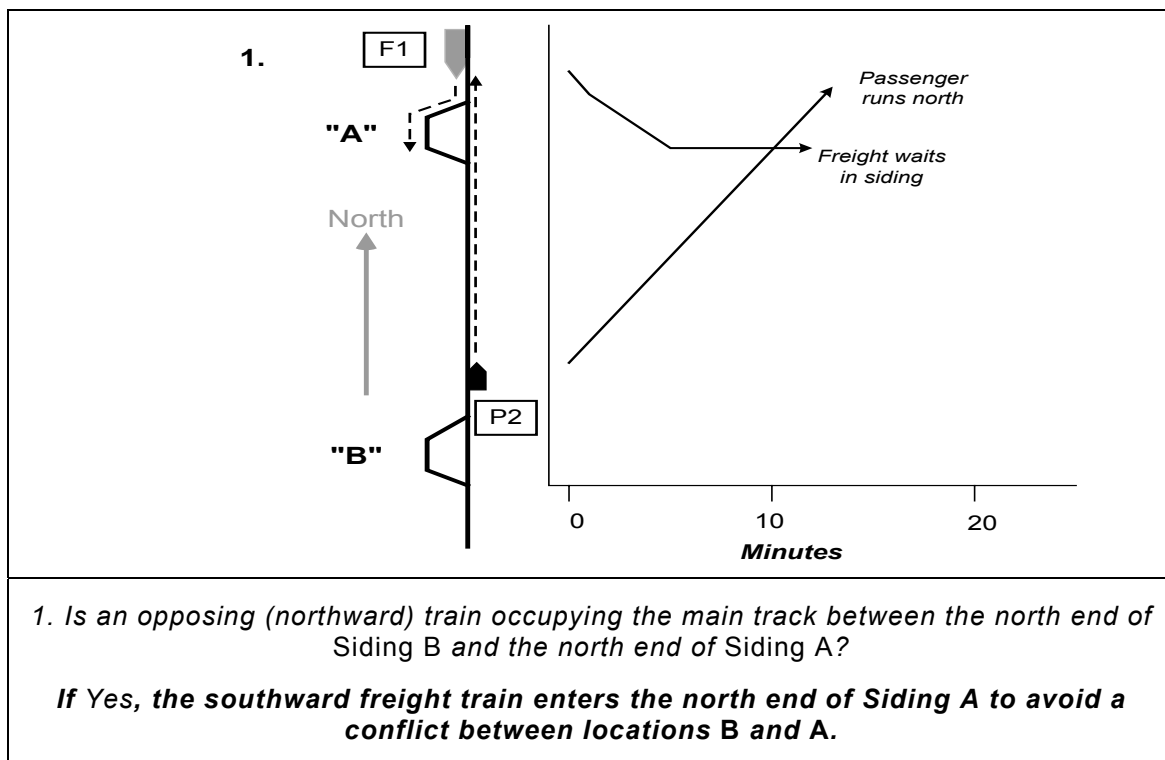

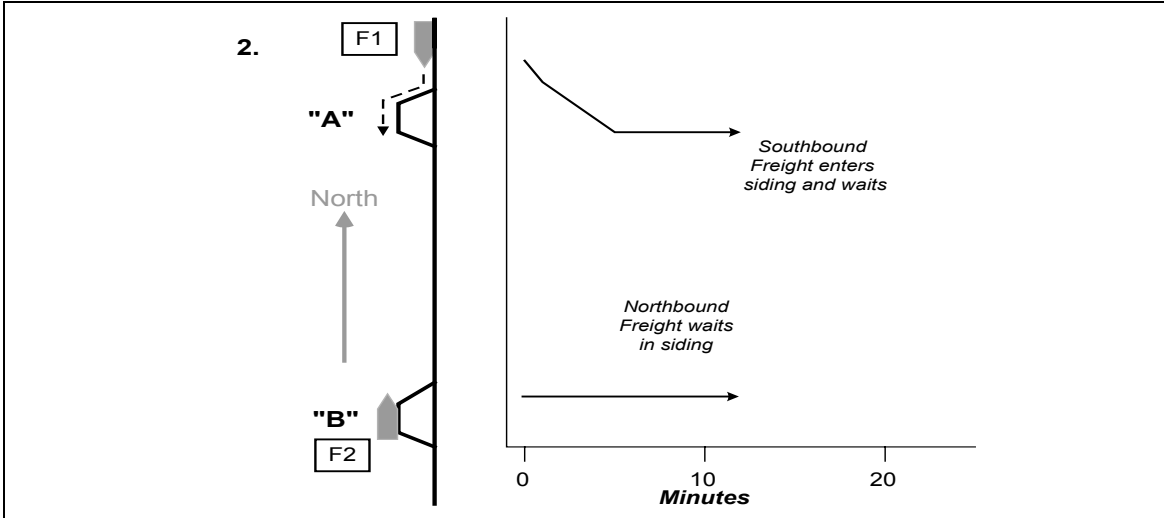

2. Is a northward opposing train occupying Siding B?
If Yes, the southward freight train will be routed into Siding A because Siding B is unavailable for the southward freight train at location A.

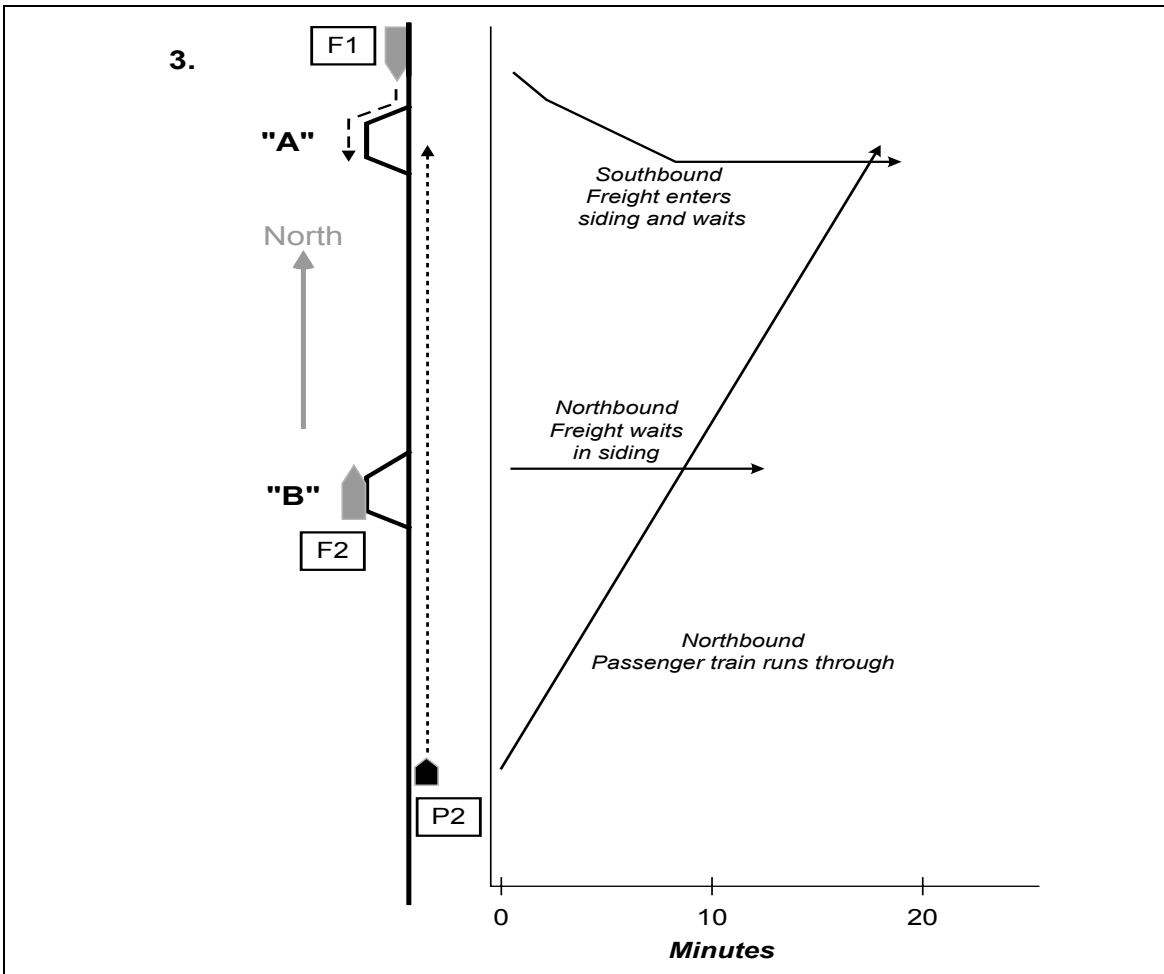

3. Is there a northward opposing passenger train at some point about 50 miles south of location B that will arrive at the south end of Siding B before the southward freight train at location A can run to and clear into Siding B?

The rationale for the second question now becomes clearer:

- a. The southward freight train would have had nowhere to go upon arrival at *Siding B*.
- b. The northward freight train would still be in *Siding B* waiting for the southward train.
- c. The northward passenger train would have arrived at *Siding B* and would be standing on the main track beside the northward freight train, and
- d. The southward freight train that had been released from *Siding A* would be standing at the switch at the north end of *Siding B* facing both trains.

The option of routing the northward passenger train behind the northward freight train in *Siding B* would be undesirable²⁶.

Therefore, the southward freight train would be routed into *Siding A*.

The rationale for the southward freight train being routed into *Siding A*, if a northward passenger train was a minimum of 50 miles away is as follows:

- If the north end of *Siding A* were 14 miles north of the north end of *Siding B*, the southward freight train would have to:
 - Traverse those 14 miles, and
 - At least one train length to clear into *Siding B*.

The CTC would have to restore the turnout to enable the northward passenger train to receive a clear signal to proceed on the main track.

Location of the first locomotive of the southward freight train	Location of the first locomotive of the northward passenger train
At time 0	
Passes the turnout at the north end of <i>Siding A</i> .	Passes a point 50 miles south of the south end of <i>Siding B</i> .
At time 18²⁷	
Arrives at the north end of <i>Siding B</i> , and begins to enter <i>Siding B</i> at 45 mph.	Has traveled 27 miles at an average speed of 90 mph.
At time 21	
Has entered into <i>Siding B</i> , and <ul style="list-style-type: none"> ▪ The rear of the train would just have cleared the turnout at the north end of the siding, the switch had been reset, and the northward signal set to clear. 	Has traveled 32 miles at an average speed of 90 mph, and: <ul style="list-style-type: none"> ▪ Would be passing the south end of <i>Siding B</i> with a clear signal.
At time 24	
Stopped at the south end of <i>Siding B</i> .	Has traveled 36 miles and is passing the north end of <i>Siding B</i> .

²⁶ The northward passenger train would either have to back out of *Siding B* to proceed ahead of the northward freight train or follow the northward freight train north of *Siding B* at a reduced speed.

²⁷ Time rounded to nearest minute.

The northward passenger train, averaging 90 mph, must not be any closer than 24 minutes/36 miles from north end of Siding B to ensure time separation between trains at siding B.

Therefore, the northward passenger train, averaging 90 mph, would have to be a minimum of 49 miles south of the north end of Siding A to enable the southward freight train to proceed beyond the north end of Siding A. This distance would enable the northward passenger train to maintain suitable spacing and not have to decelerate approaching the north end of Siding B. **Fifty miles is the absolute minimum distance.** The southward freight train would be routed into Siding A when:

- A northward passenger train was 50 miles away, or closer, or
- An opposing freight train was already in or routed to Siding B.

The northward passenger would have to be more than 50 miles south of Siding B if the average speed of the northward passenger train had been higher, or the speed of the southward freight train lower.

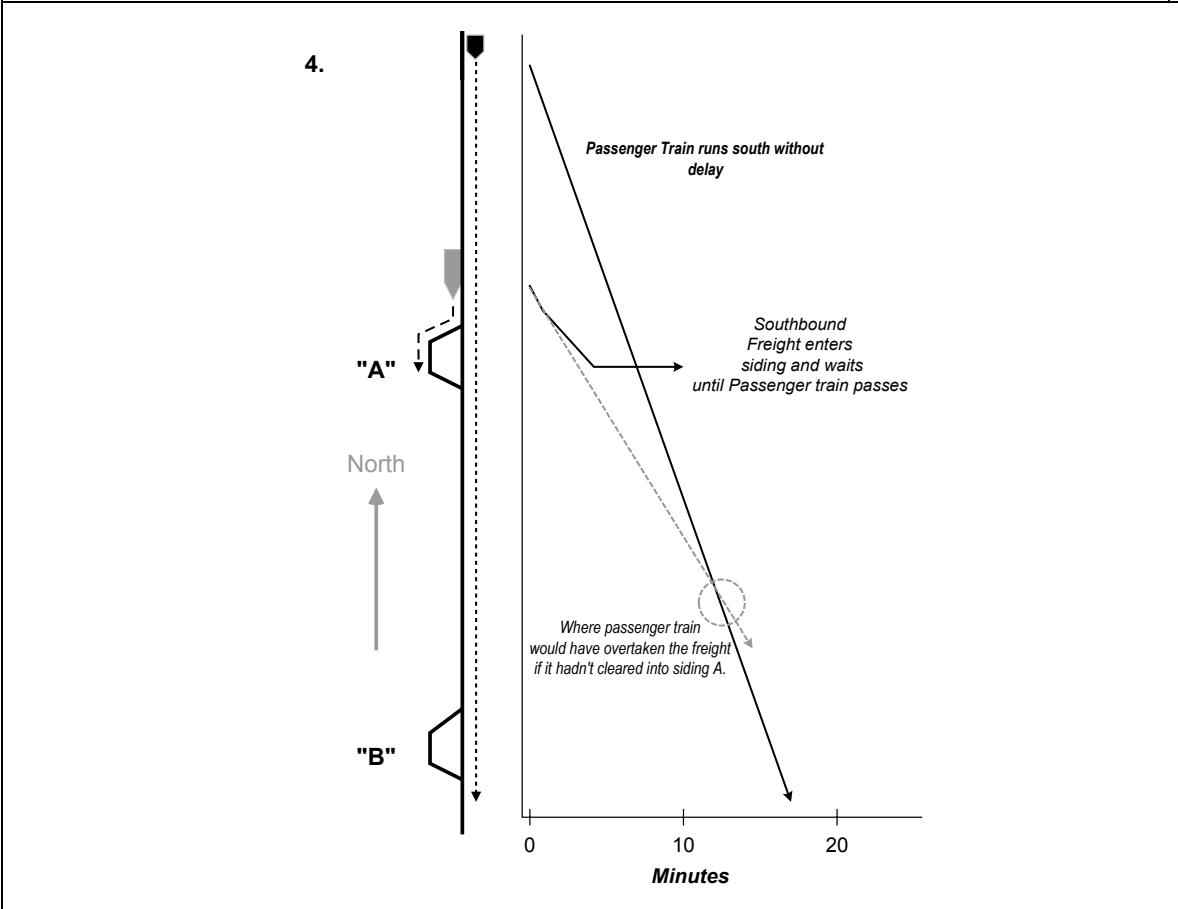

4. *Is there a southward following passenger train at some point about 21 miles north of Siding A that would catch up to the southward freight train before it could run to, and clear, into Siding B?*

If Yes - The southward freight train would be routed into *Siding A*.
 The 21-mile criterion applies to the determination of the distance the southward passenger train would have to be behind the southward freight train, to enable the freight train to proceed to *Siding B* and clear the main track without delaying the southward passenger train. The rationale for the 21 miles is as follows:

Location of the first locomotive of the southward freight train	Location of the first locomotive of the southward passenger train
At time 0	
Passes the turnout at the north end of <i>Siding A</i> .	Passes a point 21 miles north of the north end of <i>Siding A</i> .
At time 18²⁸	
Arrives at the north end of <i>Siding B</i> , and begins to enter <i>Siding B</i> at 45 mph.	Has traveled 26 miles at an average speed of 90 mph and is on the single-track between Sidings A and B.
At time 21	
Has passed into <i>Siding B</i> , and <ul style="list-style-type: none"> • The rear of the train would just have cleared the turnout at the north end of the siding; and • The CTC system has restored the turnout to enable the southward passenger train to receive a clear signal to proceed on the main track. 	Has traveled 32 miles at an average speed of 90 mph, and: <ul style="list-style-type: none"> • Would be 3 miles from the north end of <i>Siding B</i>, and • Within 40 seconds (1 mile) would have to begin to decelerate approaching <i>Siding B</i>, if a clear signal had not yet been displayed.
<p>The southward passenger train would have traveled 32 miles, at an average speed of 90 mph, in the time it took the southward freight train, at an average of 45 mph, to travel 16 miles into the clear at <i>Siding B</i>.</p> <p>Therefore, the southward passenger train would have to be:</p> <ul style="list-style-type: none"> ▪ At least 36 miles north of <i>Siding B</i>, or ▪ A minimum of twenty-one miles behind the northward freight train when it passed <i>Siding A</i>, to be able to maintain suitable spacing and not have to decelerate approaching <i>Siding B</i>. <p>Twenty-one miles is the absolute minimum distance. If the average speed of the southward passenger train had been higher, or the average speed of the southward freight train been lower, the southward passenger would have to be even farther north of <i>Siding A</i>.</p>	

²⁸ Time rounded to nearest minute.

Referring to Question 2 above, if a northward freight train were located in *Siding B*, the southward freight train north of *Siding A* would enter the siding and wait for both the northward passenger train and the northward freight train to pass the south end of *Siding A*, before exiting the siding to head towards *Siding B*. The time sequence of the train moves would be as follows:

Location of the first locomotive of northward freight train B	Location of the first locomotive of the northward passenger train	Location of the first locomotive of southward freight train A
Time 0		
North end of <i>Siding B</i>	Passes a point 50 miles south of the north end of <i>Siding A</i> .	North of <i>Siding A</i> , on main track
Time 24 minutes		
North end of <i>Siding B</i>	Passes south end of <i>Siding B</i>	Standing at south end of <i>Siding A</i>
Time 29 minutes		
Leaves <i>Siding B</i> , following the northward passenger train	North of <i>Siding B</i>	Standing at south end of <i>Siding A</i>
Time 50 minutes		
Head end clears south end of <i>Siding A</i>	20 miles north of the north end of <i>Siding A</i>	Standing at south end of <i>Siding A</i>
Time 55 minutes		
Approaching north end of <i>Siding A</i>	28 miles north of the north end of <i>Siding A</i>	Leaves south end of <i>Siding A</i>
<i>A southward freight train, having entered <i>Siding A</i>, would not depart the siding until the answers to the four questions are negative.</i>		

There are times that a passenger train would take a siding. For example:

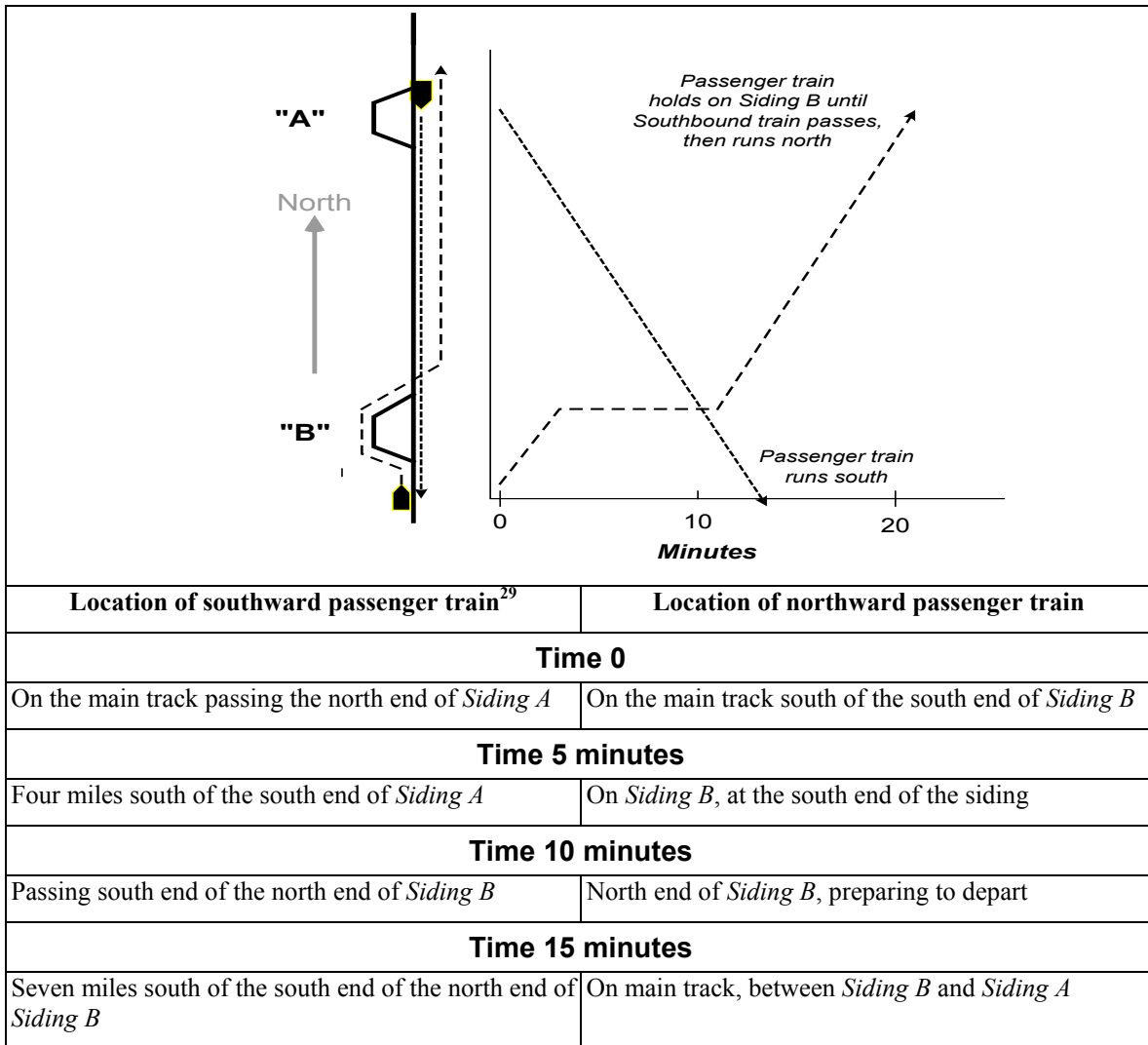

The amount of delay encountered by the northward passenger train would vary according to how far south of the south end of *Siding B* at Time 0.

Double-Track Railroad: Passenger Trains Overtaking Freight Trains

A train dispatcher evaluating the status of a northward passenger train (P1) following a northward freight train (F1) would look ahead of the trains for southward freight/passenger trains on the opposing track to determine whether the northward passenger train (P1) would be allowed to pass the northward freight train (F1). The amount of clear distance³⁰ a northward passenger train (P1), moving at 100 mph (0.6 minutes per mile), requires to overtake a northward freight train (F1), moving at 50 mph (1.2 minutes per mile), by diverting to the opposite (southward) track and back is:

²⁹ Both trains assumed to be averaging 90 mph.

³⁰ The equivalent to "sight distance" in the highway analogy.

- 30 miles, if the southward train approaching on the opposite track is a freight train, and
- 45 miles, if the southward train approaching on the opposite track is a passenger train.

The minimum distance required by the northward passenger train (P1) to ideally overtake and pass a preceding freight is determined by the time to accomplish a number of moves, including:

- 3 minutes - The time separation between the northward freight (F1) and the northward passenger train (P1) to ensure that the northward passenger train (P1) obtains an optimal signal to crossover over to the opposite (southward) track at location A;
- 1.5 minutes - The time for the northward passenger train (P1) to crossover to the opposite track and accelerate to MAS (100 mph to 45 mph back to 100 mph);
- 1.5 minutes - The time for the northward passenger train (P1) to decelerate and cross back to its original track at location B; and
- 3 minutes - The time separation between the northward passenger train (P1) and the northward freight train (F1), which is now behind it, to ensure that the northward freight train (F1) obtains an optimal signal to proceed without slowing down and thereby being delayed.

Consequently, at a minimum, the northward passenger train (P1) must gain nine minutes relative to the freight train. At 0.6 minutes per mile, it would take a northward passenger train (P1) a minimum of fifteen miles to complete the pass of a northward freight train (F1).

Meets and Overtakes Involving Three Trains: Northward Passenger Train (P1) Overtaking Northward Freight Train (F1), and Approaching Southward Passenger Train (P2)

The time sequence of events of an ideal overtake of northward freight train (F1) by northward passenger train P1, being approached by southward passenger train P2, is as follows:

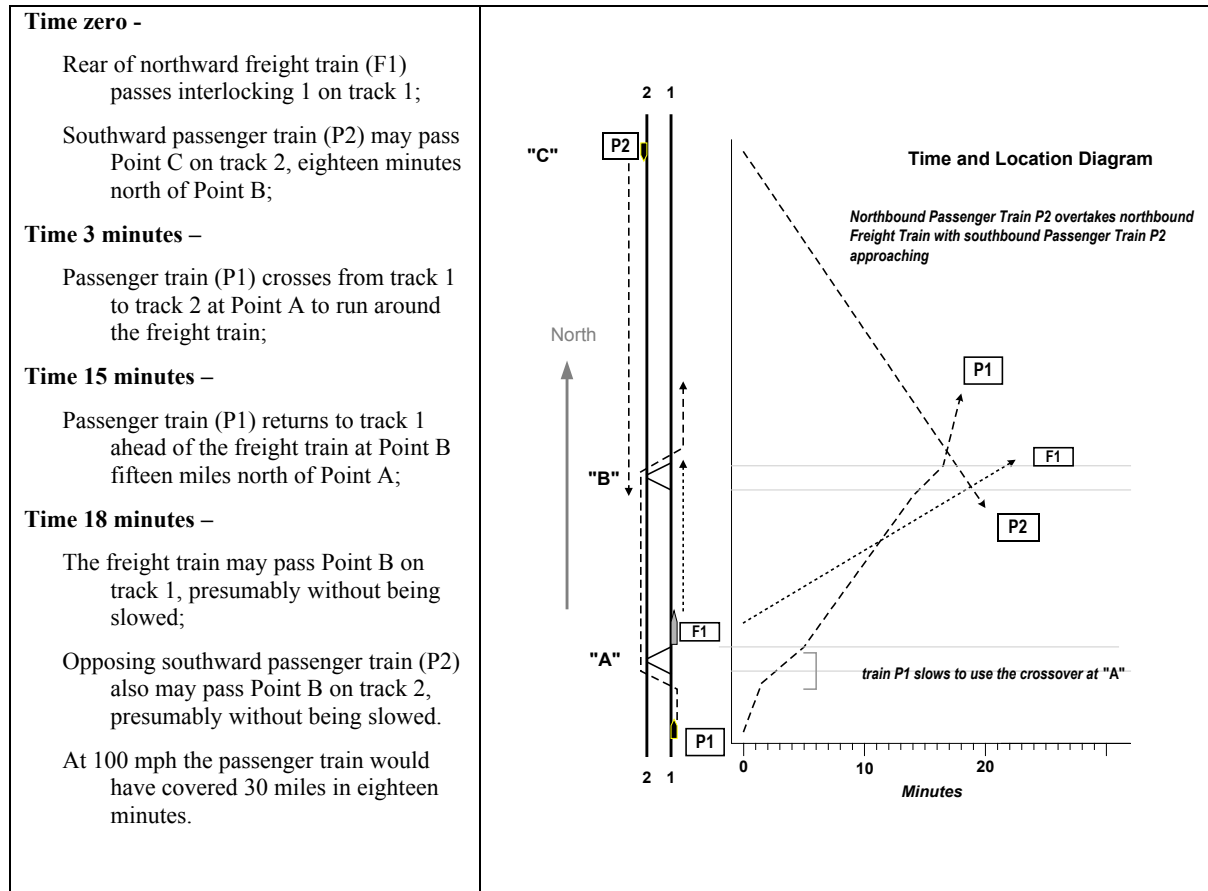

As the table indicates, a clear distance of 45 miles is needed for a northward passenger train (P1) moving at 100 mph to overtake a northward freight train (F1) moving at 50 mph –

- The sum of the distance of
 - i. Point C to Point B (30 miles), and
 - ii. Point B to Point A (15 miles).

If southward passenger train (P2) is within 45 miles of northward passenger train (P1), and northward passenger train (P1) still uses the opposite track, southward passenger train (P2) would be slowed or stopped to enable the northward passenger train (P1) to run around the northward freight train (F1).

Southward Train is a Freight Train (F2)

If the opposing train was a southward freight train (F2), it would cover 15 miles in 18 minutes, and a clear distance of 30 miles would be needed for a northward passenger train (P1) moving at 100 mph to overtake a northward freight train (F1) moving at 50 mph –

- The sum of the distance of
 - i. Point C to Point B (15 miles), and
 - ii. Point B to Point A (15 miles).

Thus, if southward freight train (F2) is within 30 miles of northward passenger train (P1), and northward passenger train (P1) still uses the opposite track, southward freight train (F2) would

be slowed or stopped to enable the northward passenger train (P1) to run around the northward freight train (F1). If the interlockings were not ideally spaced, the required clear distances would be greater.

More Detailed Rationale for Passing Sidings, Greensboro–Charlotte

With approximately 50 trains projected to operate daily between Greensboro and Charlotte in 2020 it will be difficult to find forty-mile, or even thirty-mile, clear “gaps” in opposing trains to enable overtakes to occur. An eighteen-minute gap would not be available nearly 30 percent of the time. Consequently if further improvements were not implemented, passenger trains would have to follow freight trains for many miles before a clear distance would be available. The following passenger train would lose 0.6 minutes per mile for each mile it followed a freight train.

Oncoming highway traffic generally does not slow down to create a gap to let a car pass a truck, but a train dispatcher, having overall control of the traffic, **can** slow the opposing train to enable a passenger train to pass a freight train.

If the distance between Point A and Point B in the example above is less than fifteen miles, the freight train being overtaken may have to be slowed or stopped to let the passenger train overtake it. It is possible that allowing a passenger train to overtake a freight train would result in three or more trains losing time or being required to operate at a reduced speed. The three trains would be:

1. The freight train being overtaken,
2. The passenger train overtaking the freight train, and possibly
3. One or more opposing trains.

**Technical Monograph:
Transportation Planning
for the Richmond–Charlotte Railroad Corridor**

January 2004

**Appendix D
Track Charts**

**Federal Railroad Administration
United States Department of Transportation**

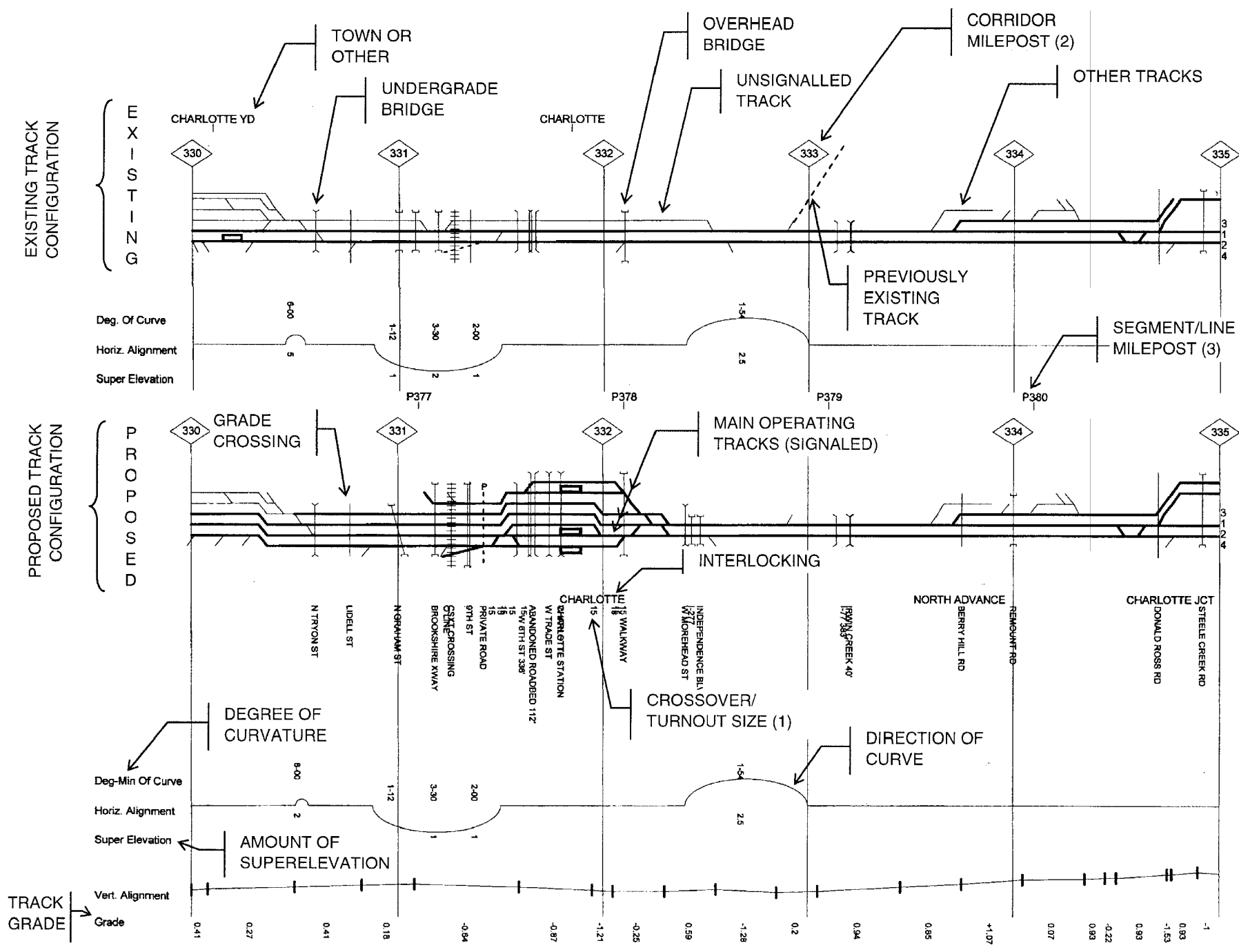

- (1) ALL MAIN TRACK CROSSOVERS/TURNOUTS (DARK LINES) ARE #20, UNLESS OTHERWISE NOTED.
- (2) CORRIDOR MILEPOSTS ARE NUMBERED CONSECUTIVELY FROM RICHMOND TO CHARLOTTE
- (3) SEGMENTS OF THE CORRIDOR HAVE UNIQUE MILEPOST NUMBERING SCHEMES

Track Chart Legend
Track Chart 14a

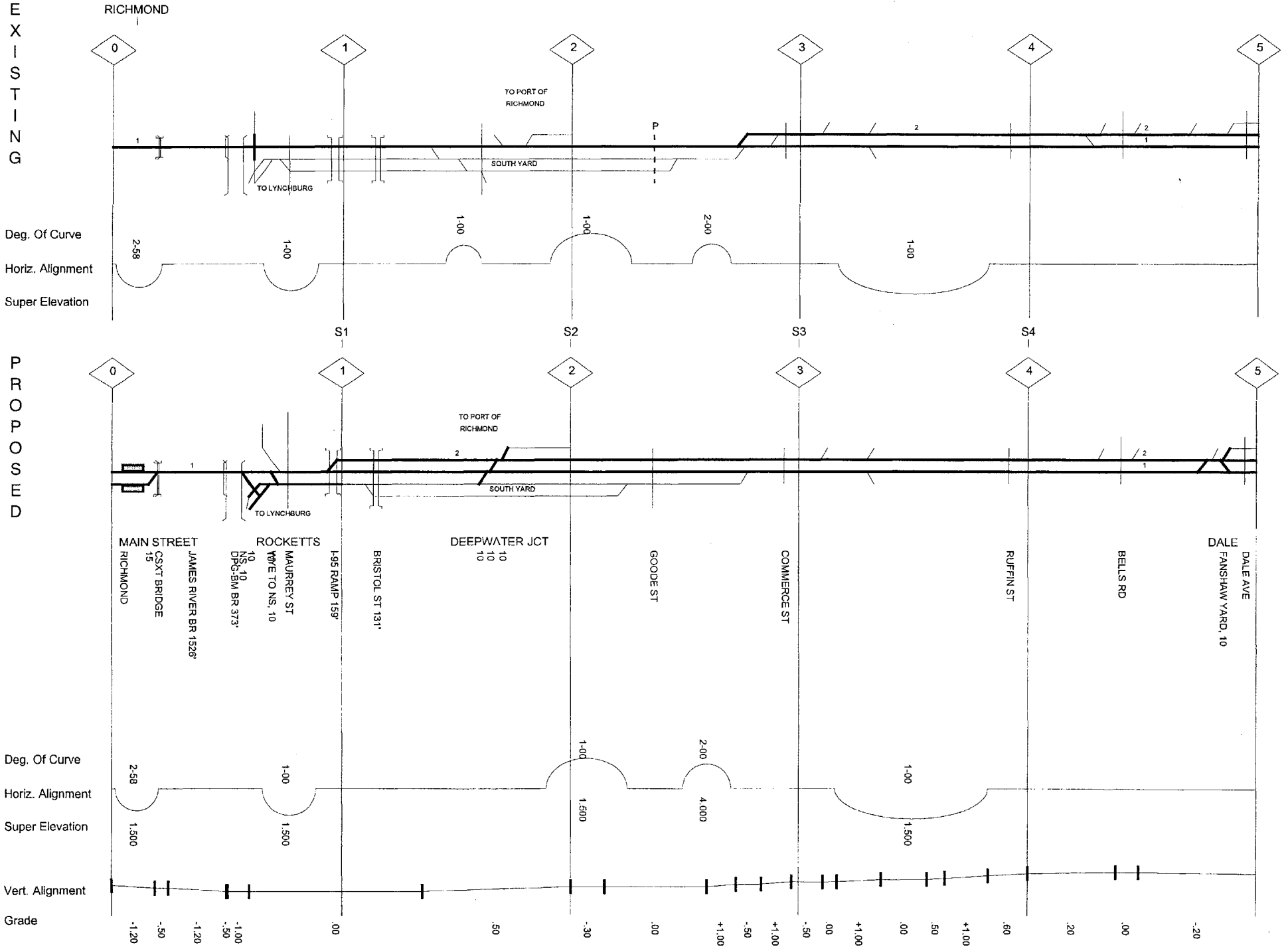

Track Chart 1

E X I S T I N G

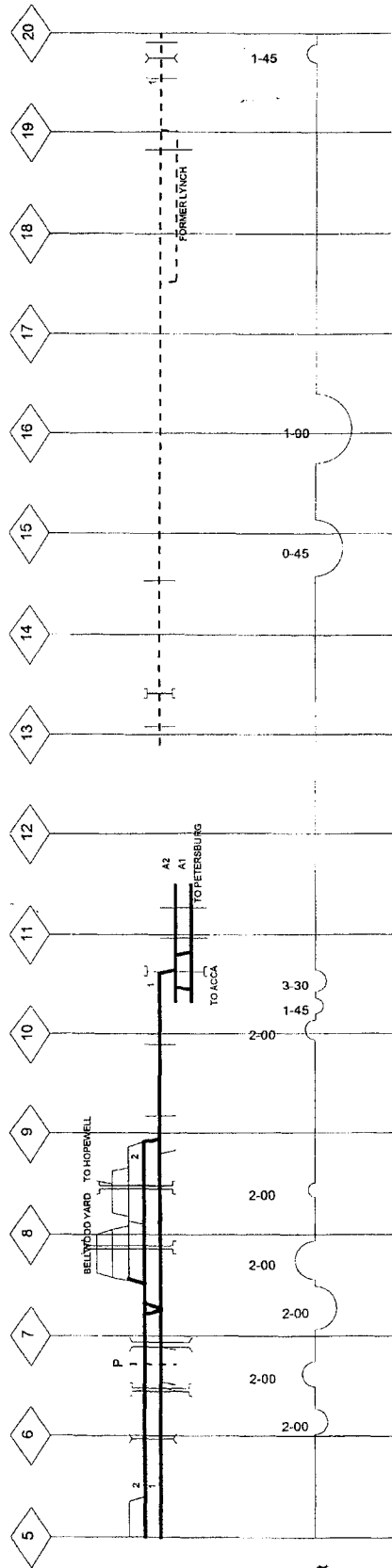

Deg. Of Curve
 Horiz. Alignment
 Super Elevation

P R O P O S E D

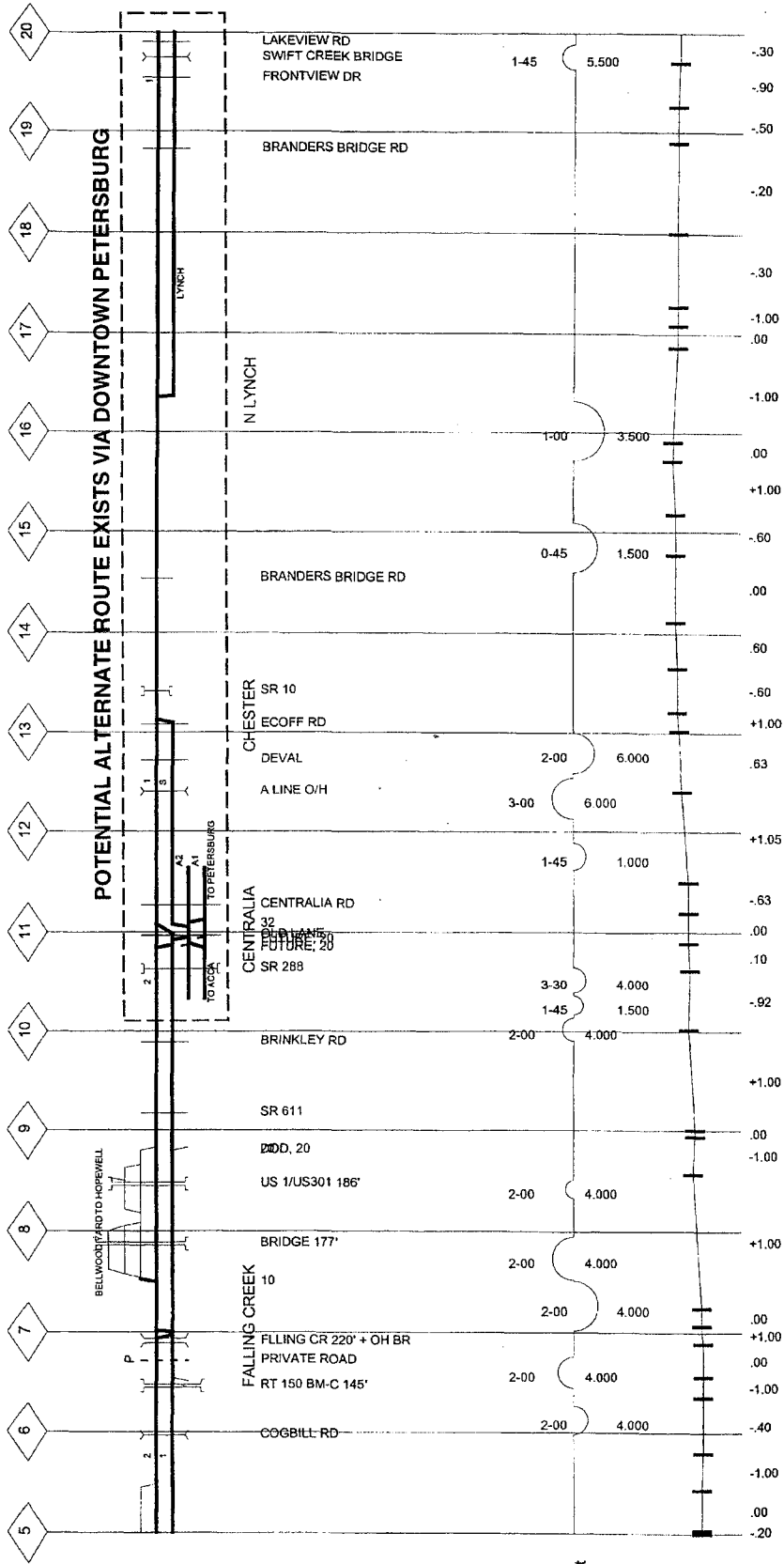

Deg. Of Curve
 Horiz. Alignment
 Super Elevation
 Vert. Alignment
 Grade

POTENTIAL ALTERNATE ROUTE EXISTS VIA DOWNTOWN PETERSBURG

Track Chart 2

E X I S T I N G

PETERSBURG

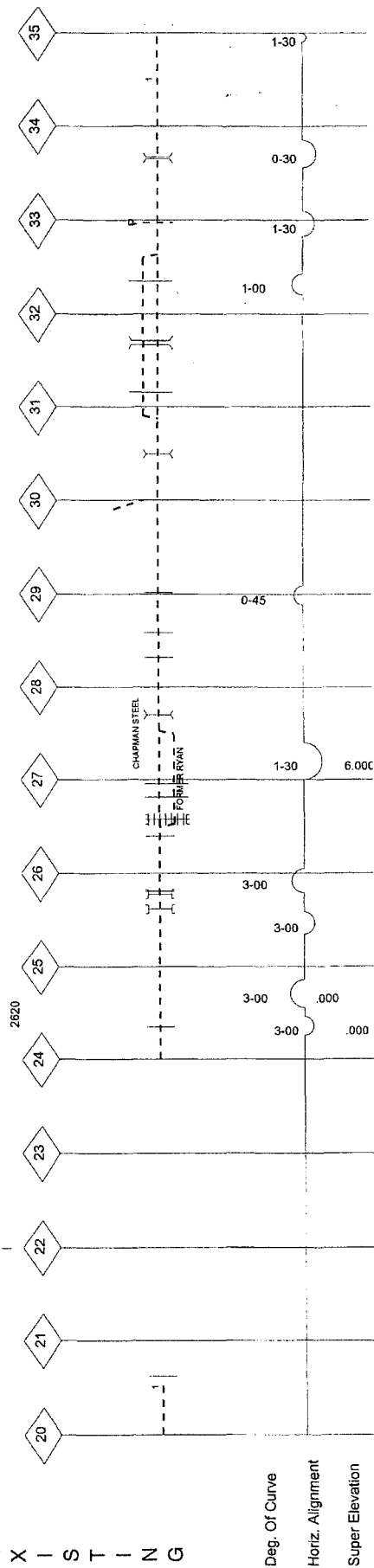

P R O P O S E D

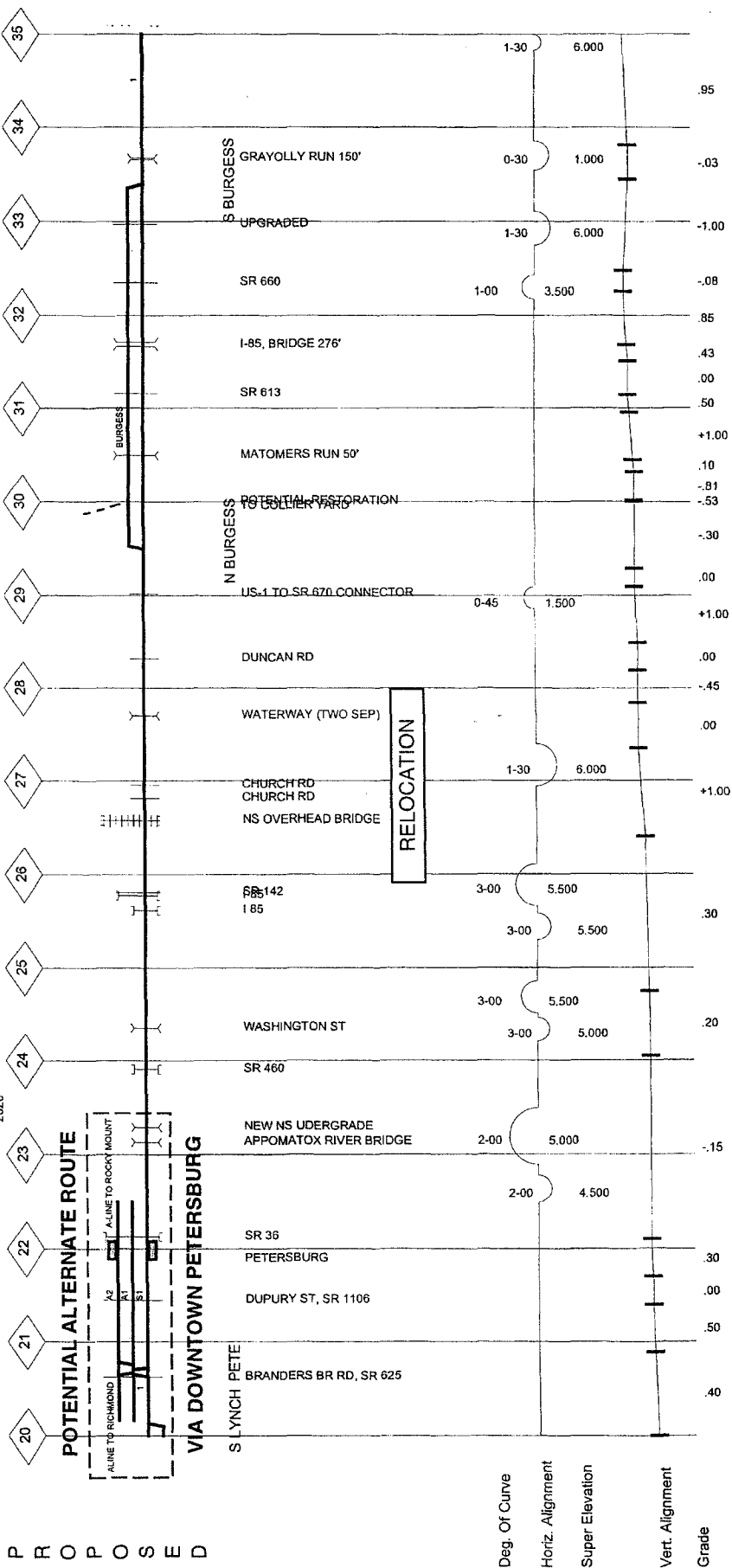

Track Chart 3

DINWIDDIE

E X I S T I N G

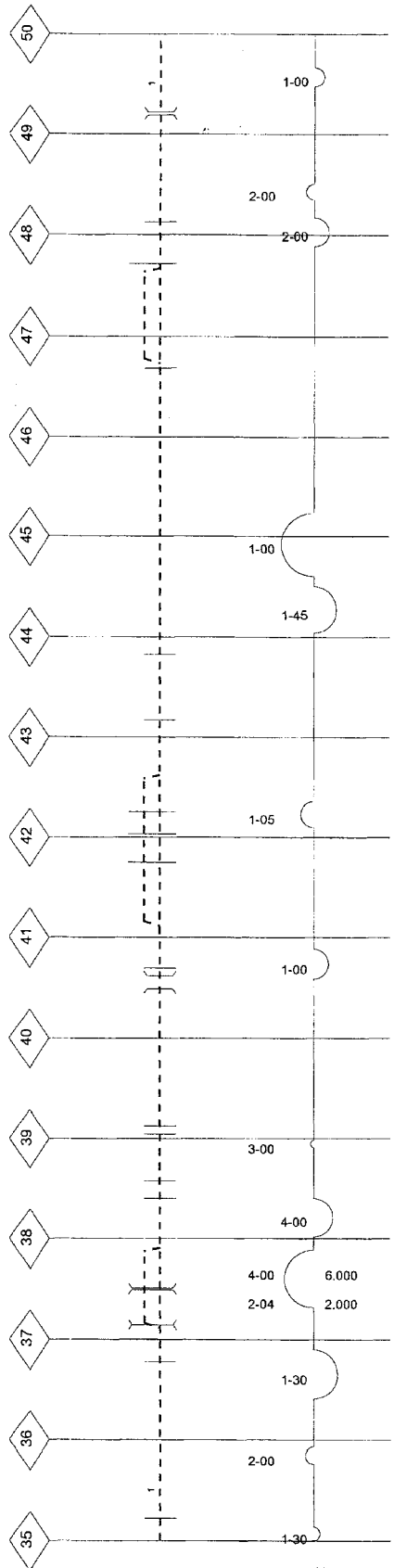

P R O P O S E D

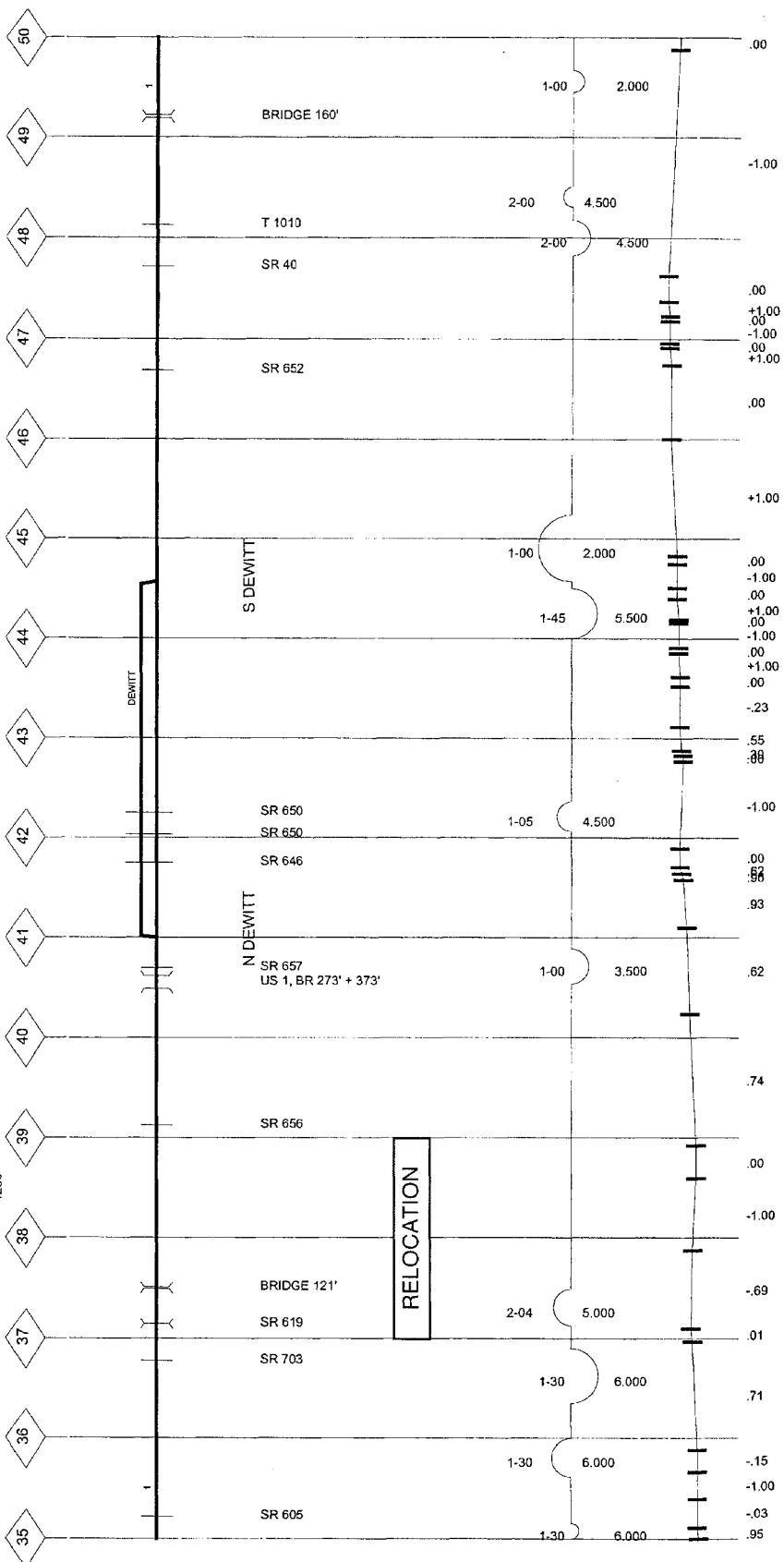

Track Chart 4

E X I S T I N G

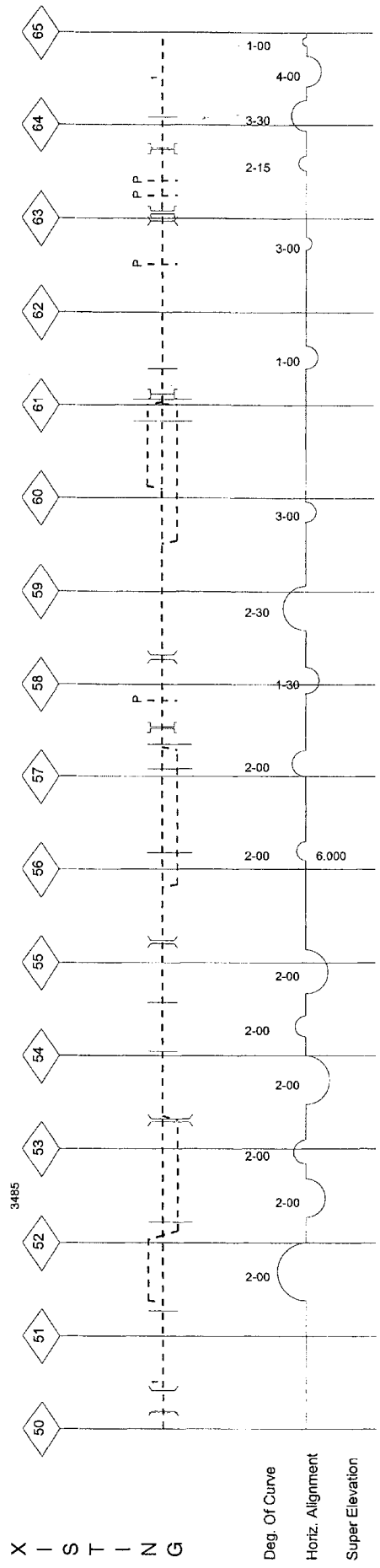

Deg. Of Curve
 Horiz. Alignment
 Super Elevation

P R O P O S E D

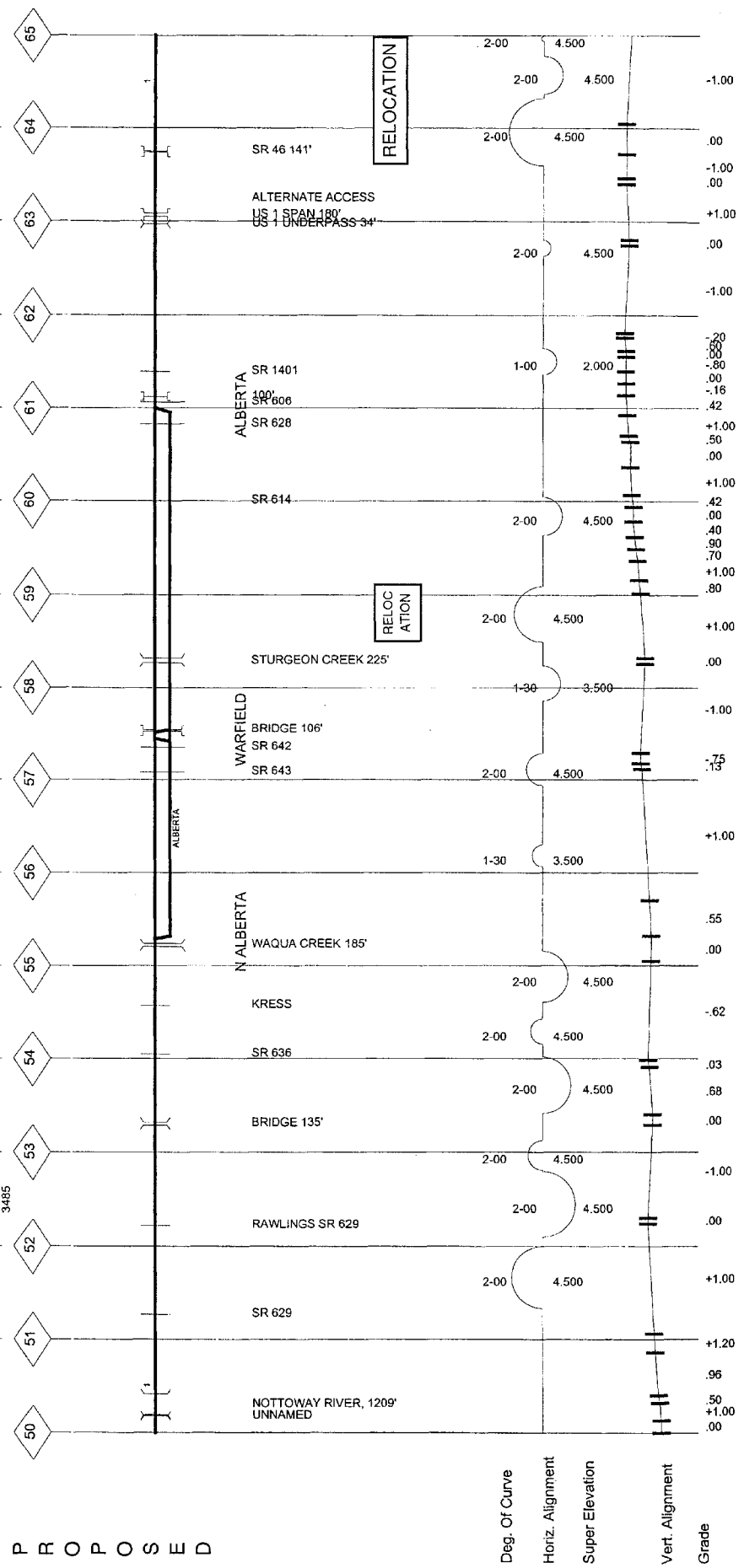

Deg. Of Curve
 Horiz. Alignment
 Super Elevation
 Vert. Alignment
 Grade

Track Chart 5

E X I S T I N G

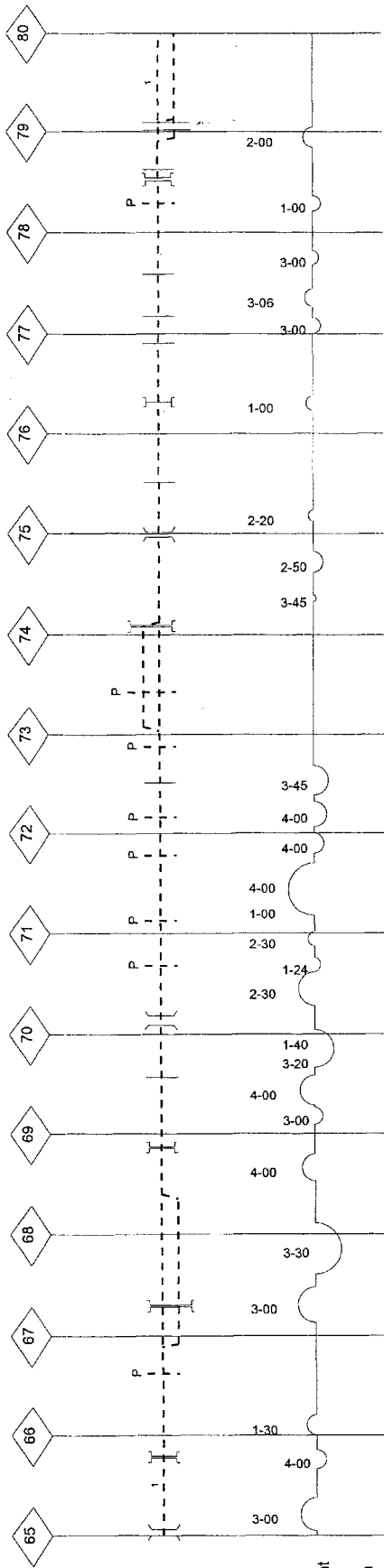

P R O P O S E D

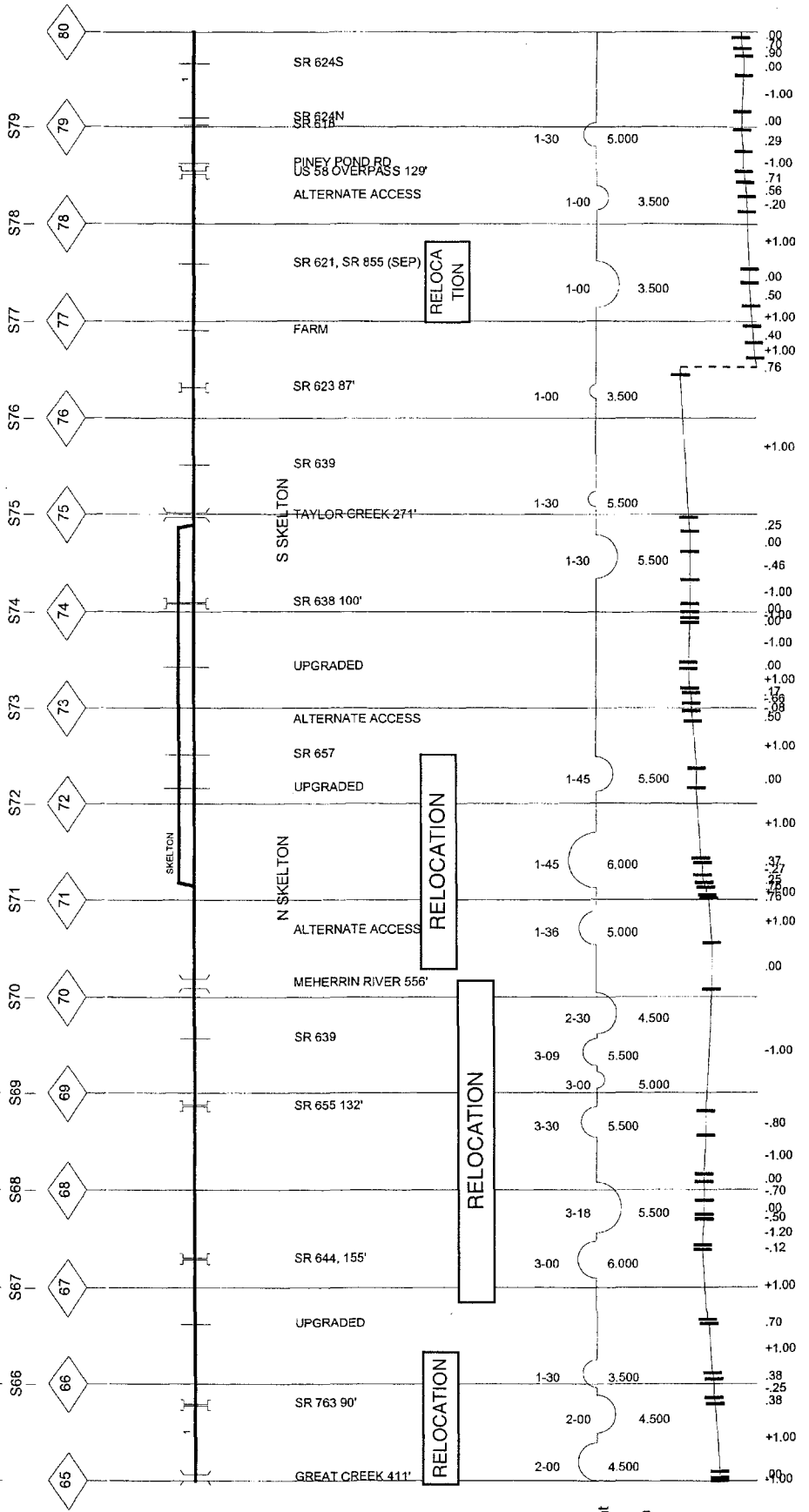

Track Chart 6

E X I S T I N G

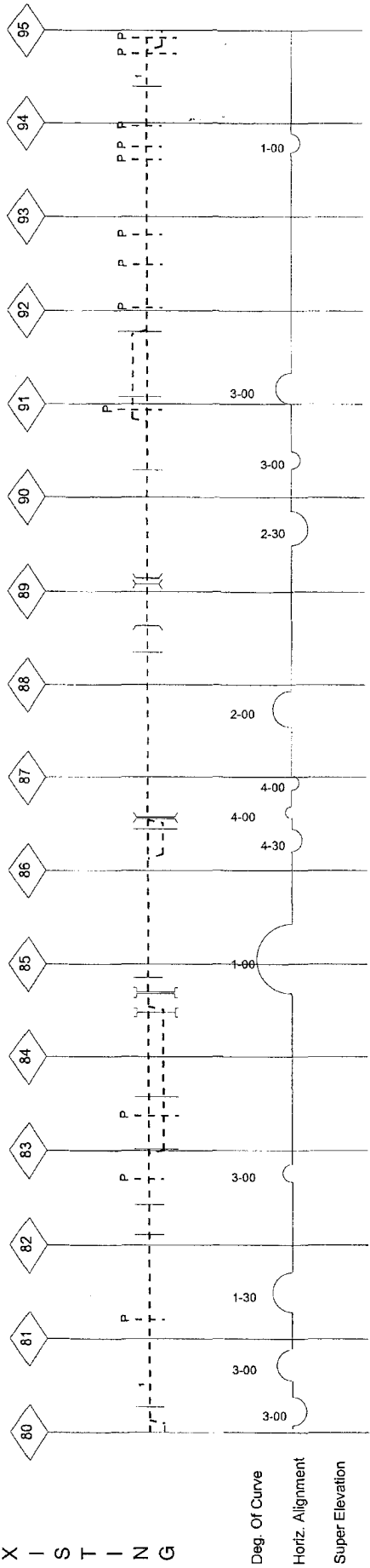

P R O P O S E D

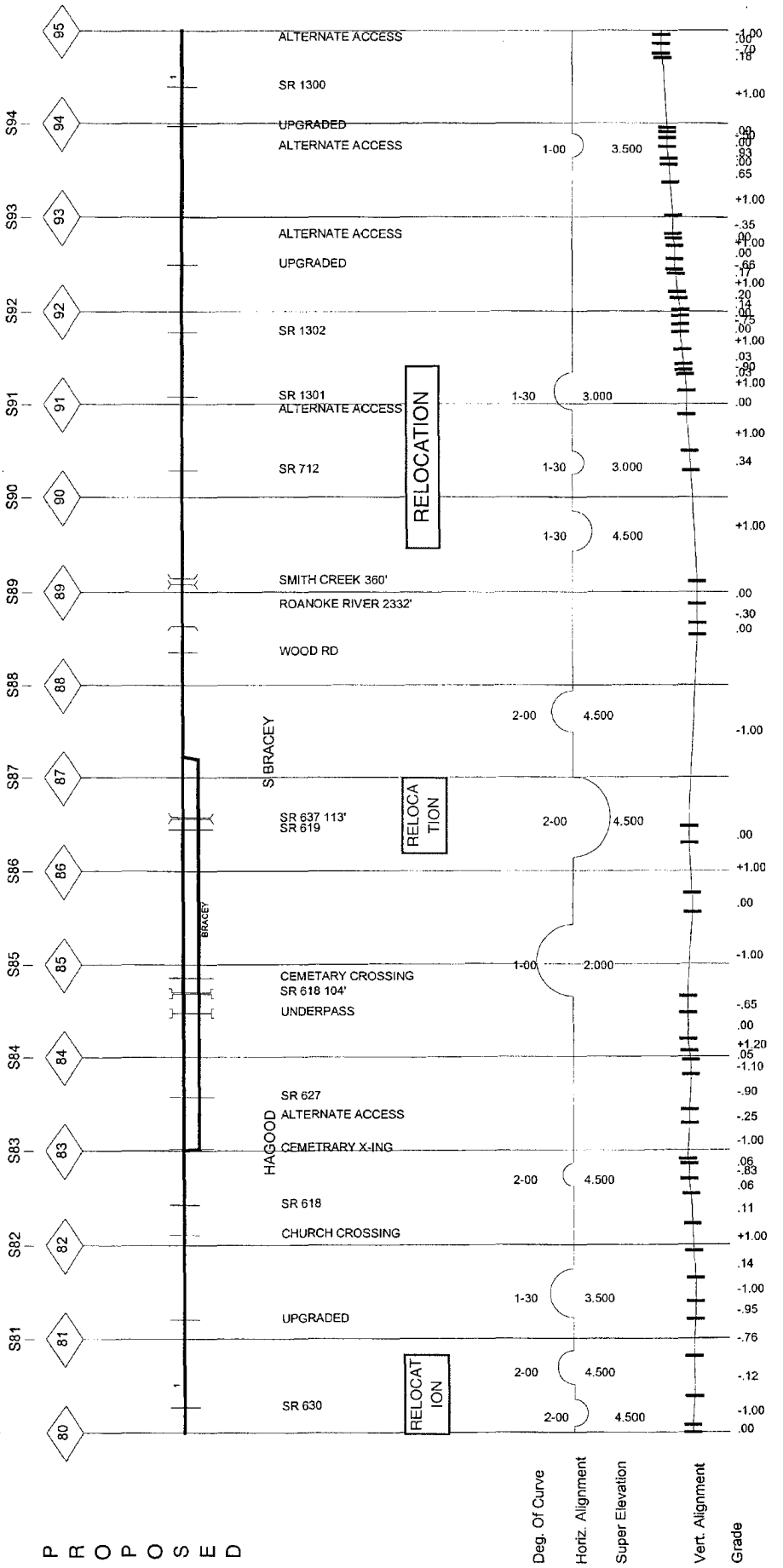

Track Chart 7

E X I S T I N G

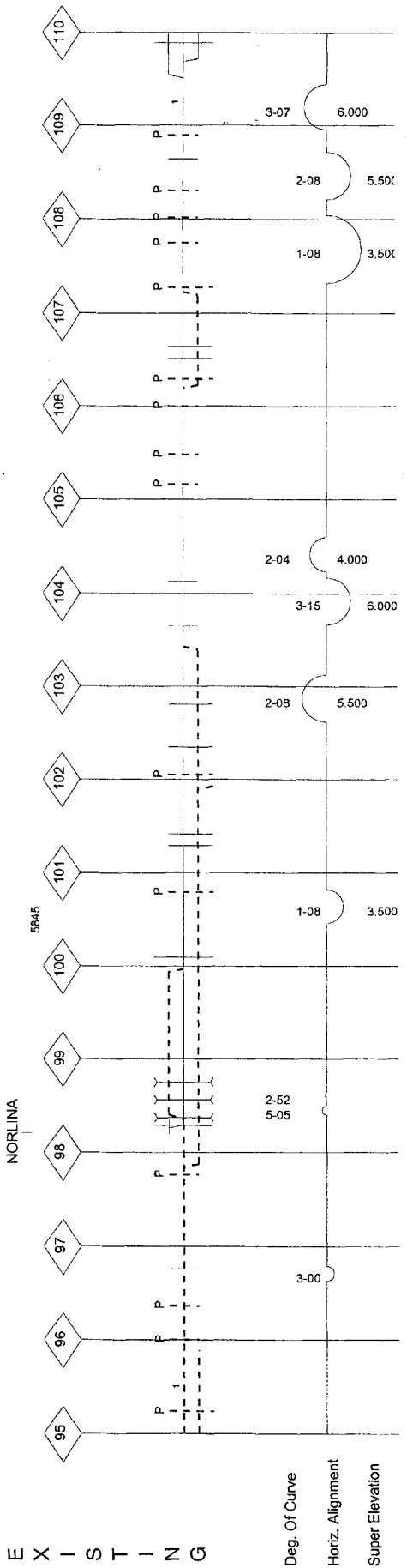

P R O P O S E D

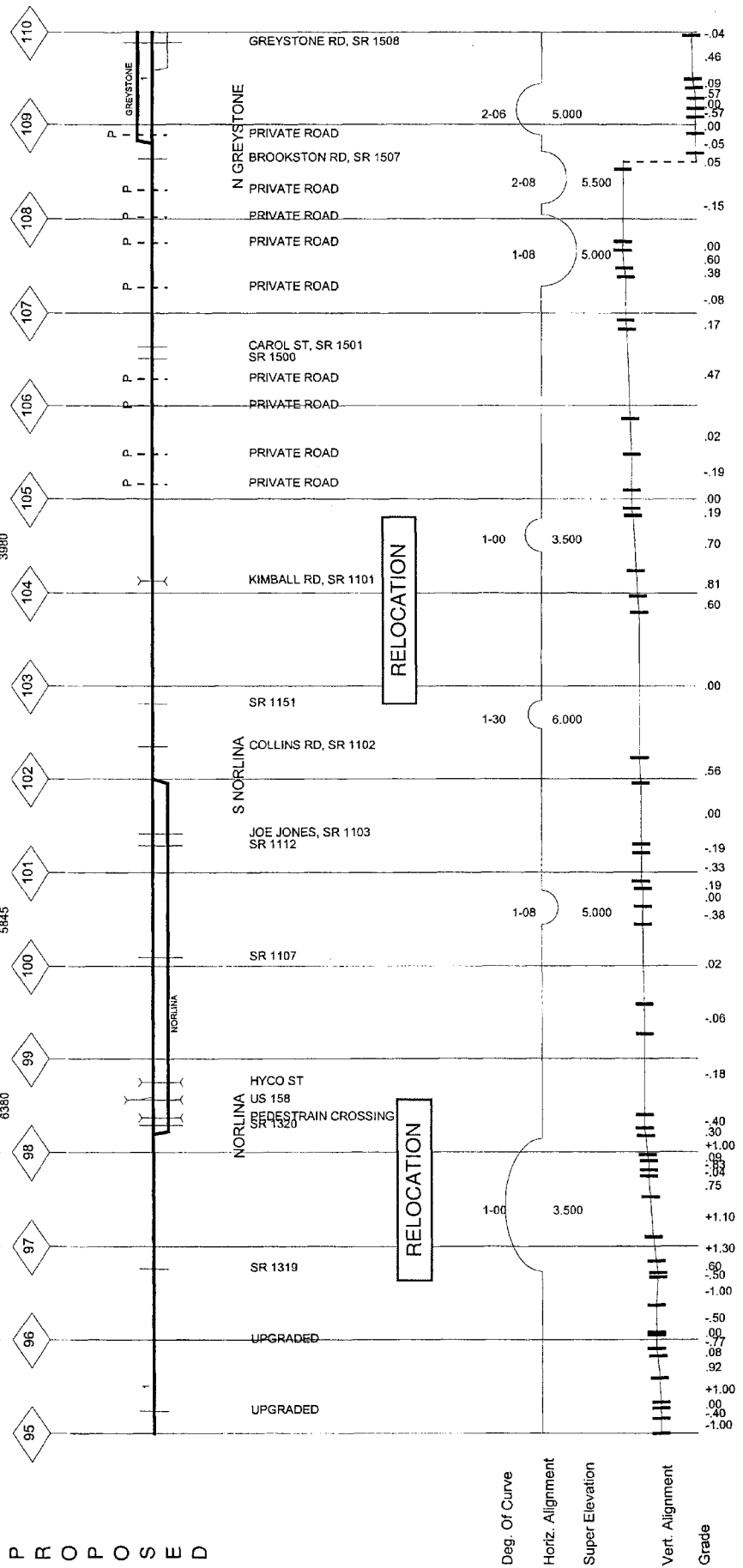

Track Chart 8

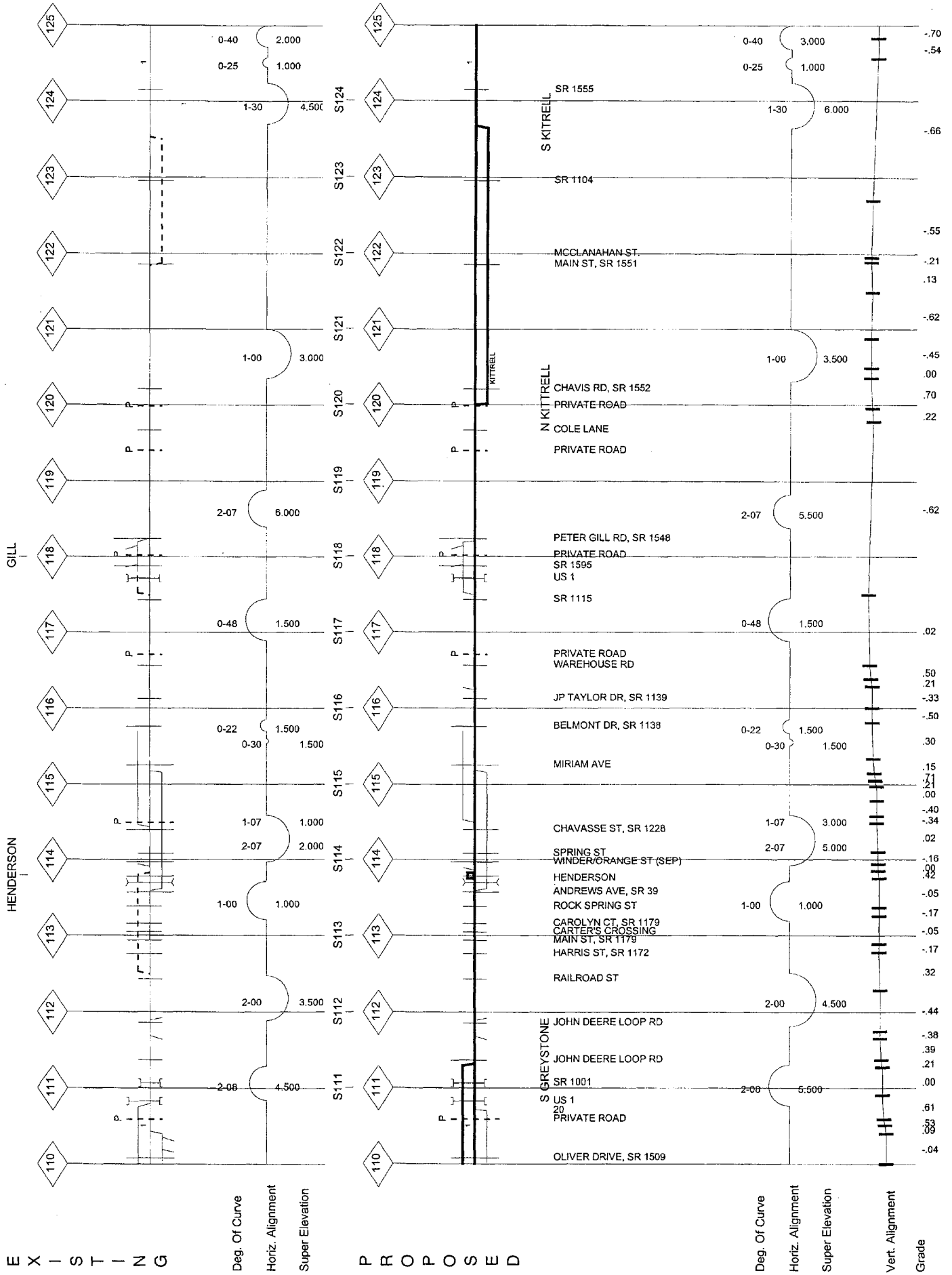

Track Chart 9

E X I S T I N G

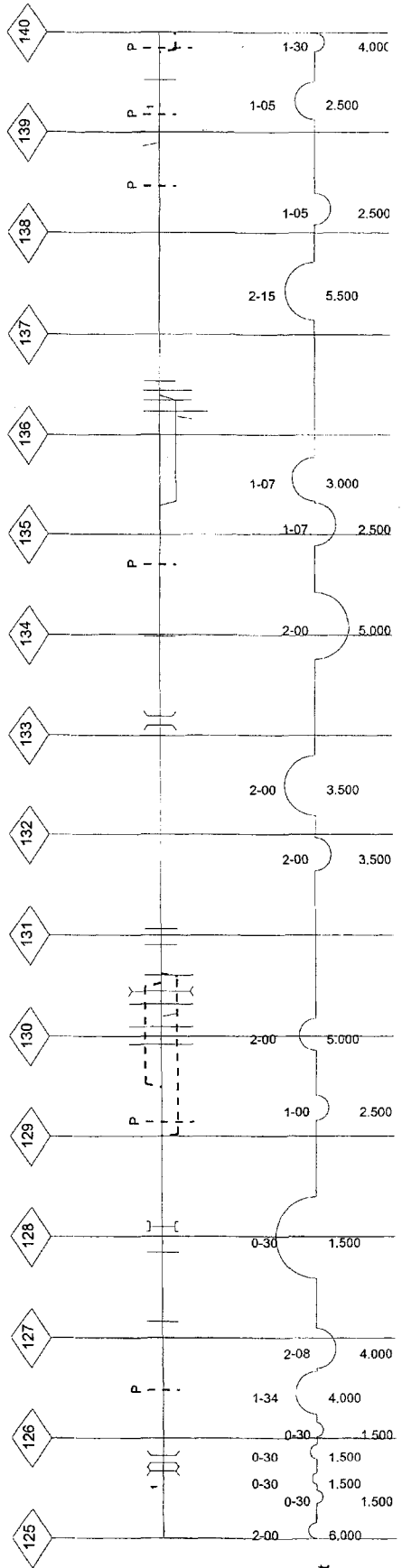

Deg. Of Curve
Horiz. Alignment
Super Elevation

P R O P O S E E D

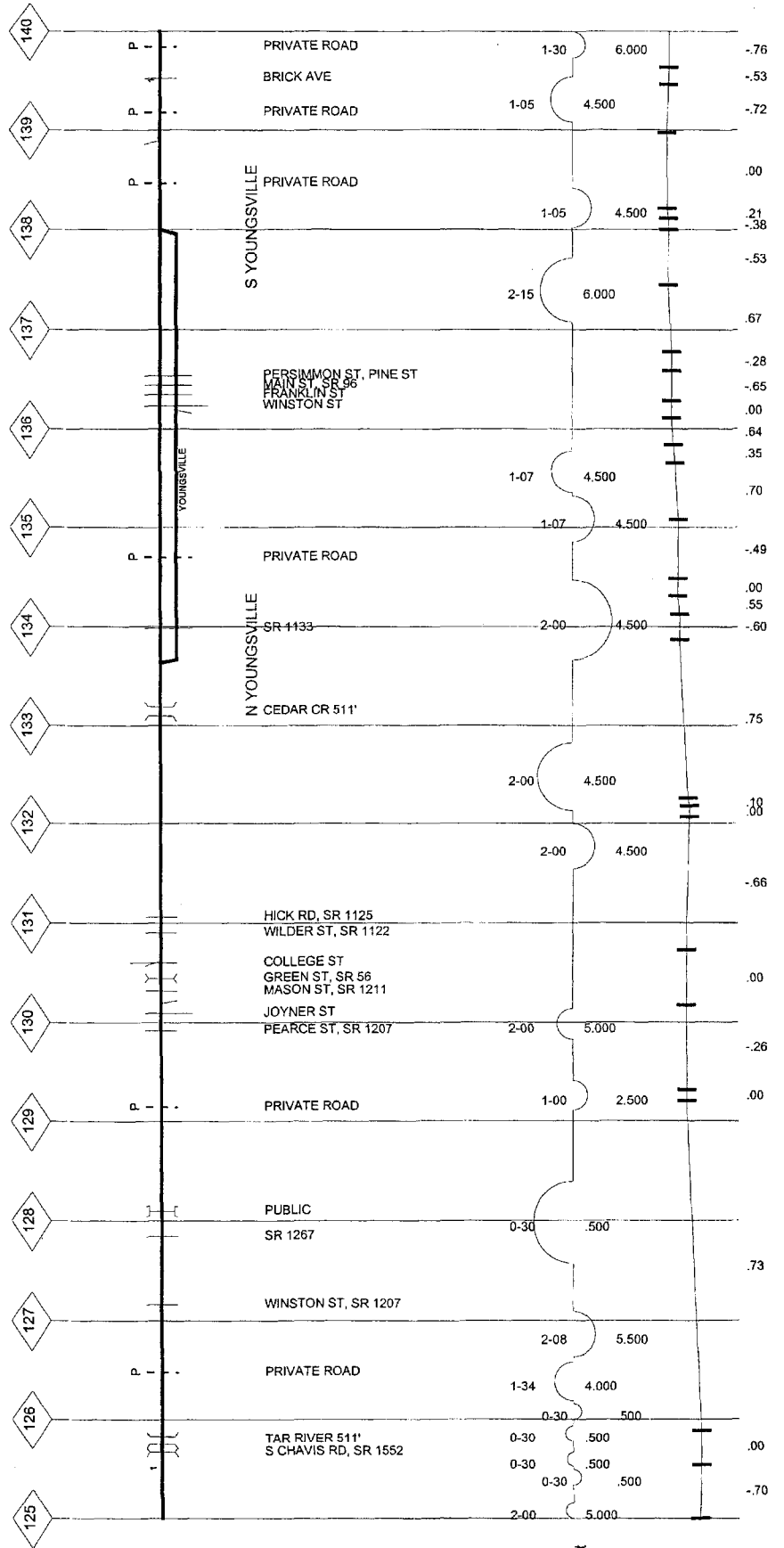

Deg. Of Curve
Horiz. Alignment
Super Elevation
Vert. Alignment
Grade

Track Chart 10

WAKEFOREST

EXISTING

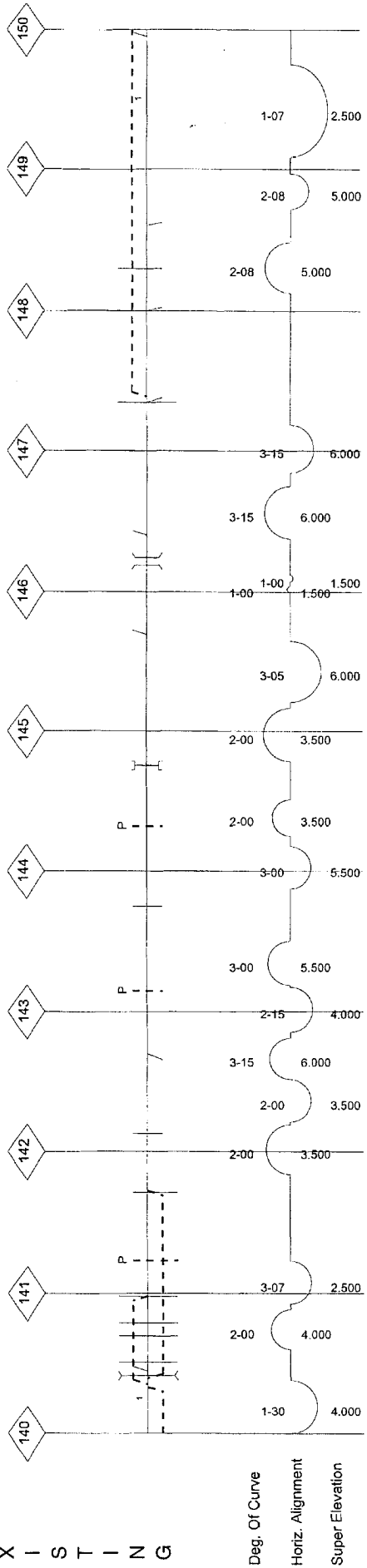

PROPOSED

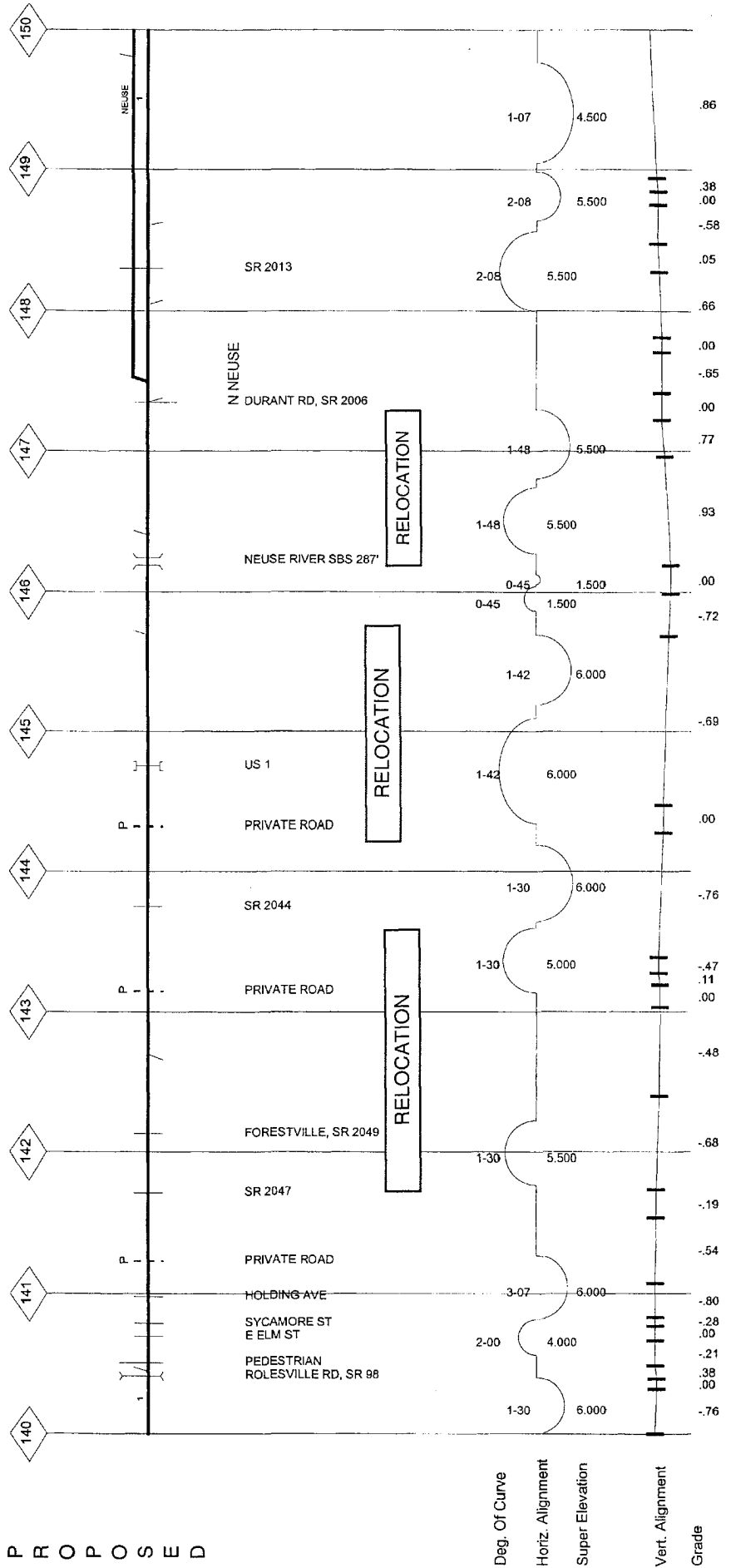

Track Chart 11

E X I S T I N G

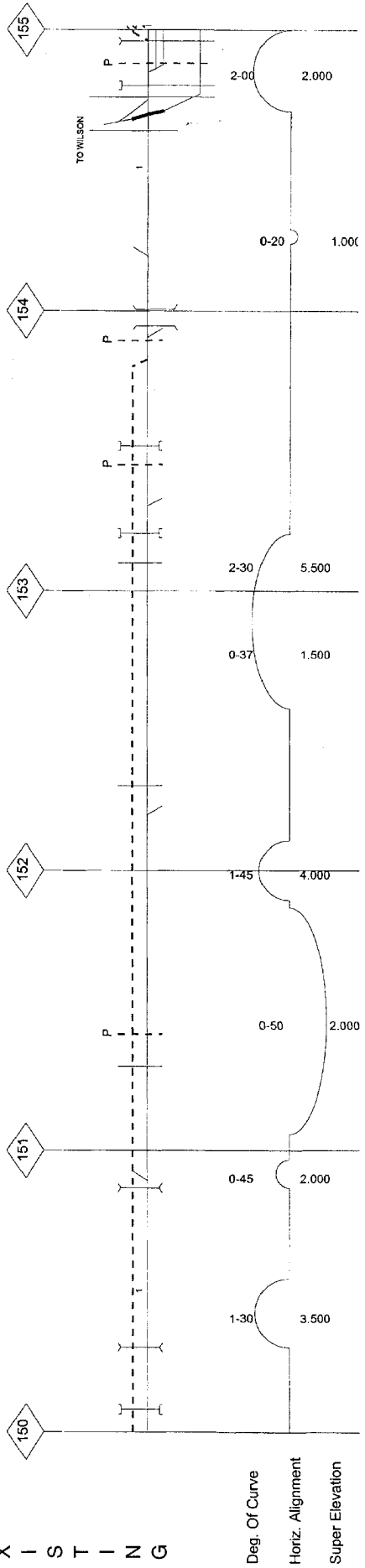

Deg. Of Curve
 Horiz. Alignment
 Super Elevation

P R O P O S E D

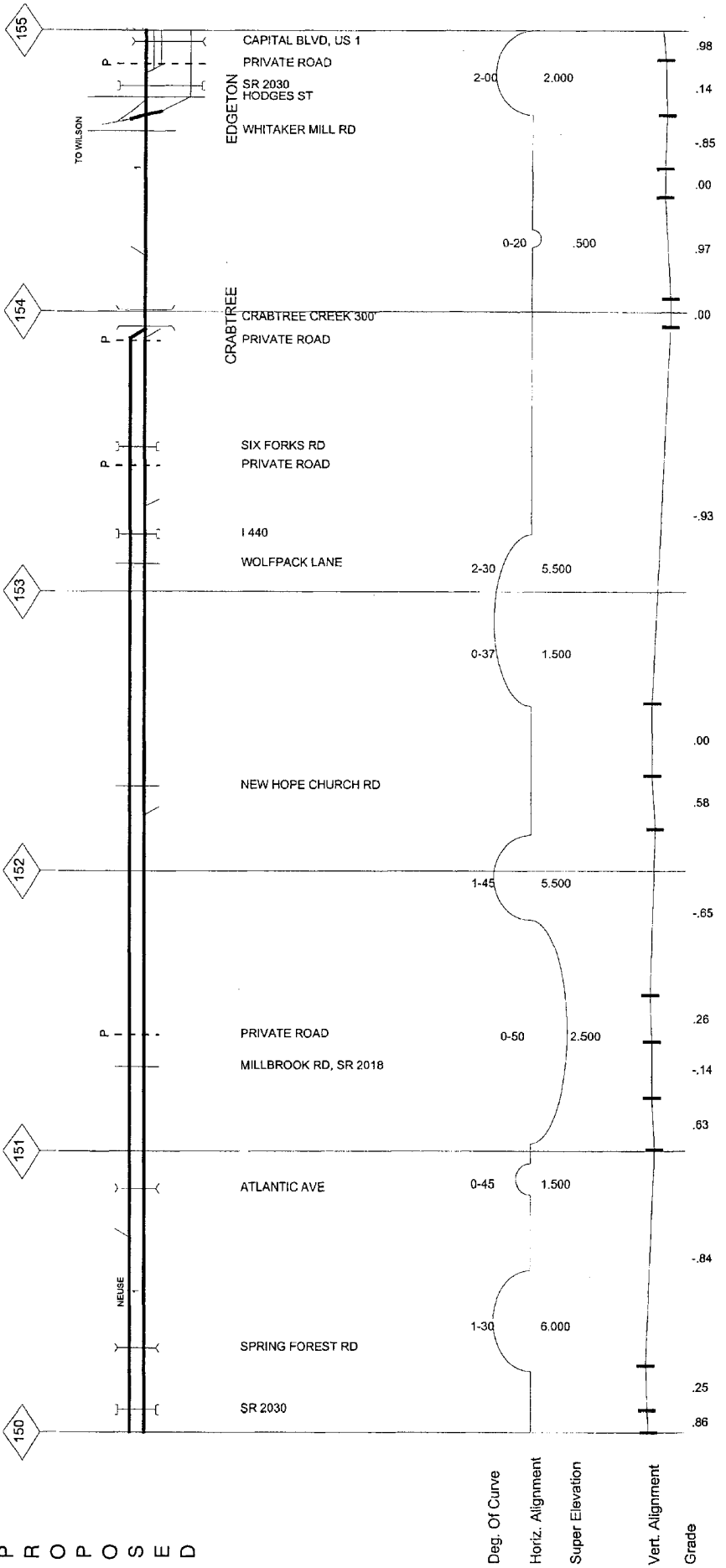

Deg. Of Curve
 Horiz. Alignment
 Super Elevation
 Vert. Alignment
 Grade

CAPITAL BLVD, US 1
 PRIVATE ROAD
 SR 2030
 HODGES ST
 EDGETON
 WHITAKER MILL RD

CRABTREE
 CRABTREE CREEK 300'
 PRIVATE ROAD

SIX FORKS RD
 PRIVATE ROAD

1440
 WOLFPACK LANE

NEW HOPE CHURCH RD

PRIVATE ROAD
 MILLBROOK RD, SR 2018

ATLANTIC AVE

SPRING FOREST RD

SR 2030

Track Chart 12

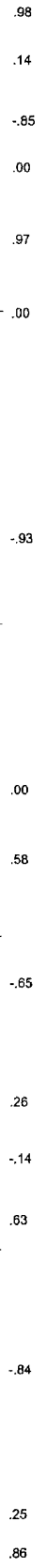

MP S157.4=H80.6, RALEIGH

E X I S T I N G

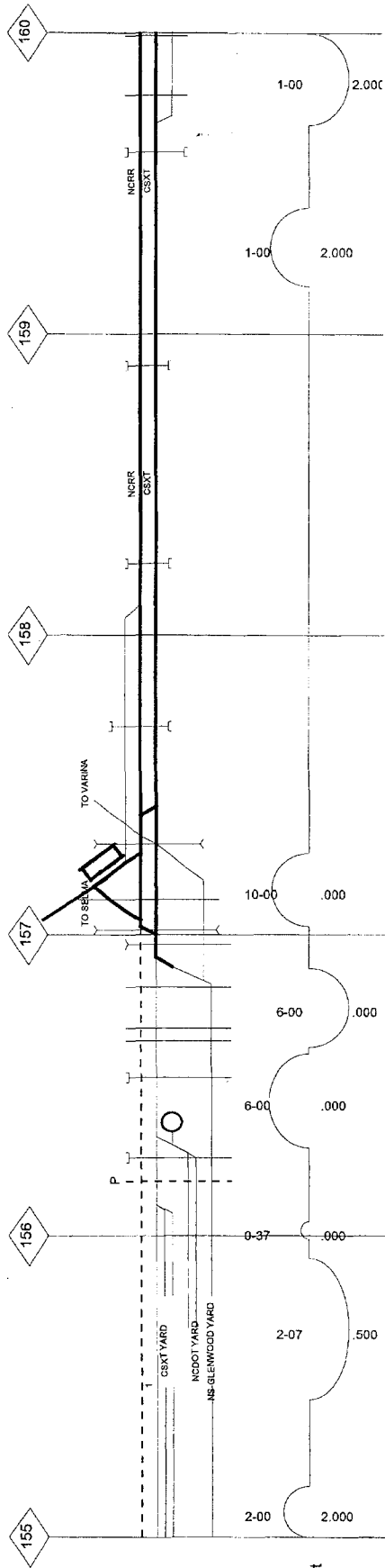

Deg. Of Curve
 Horiz. Alignment
 Super Elevation

P R O P O S E D

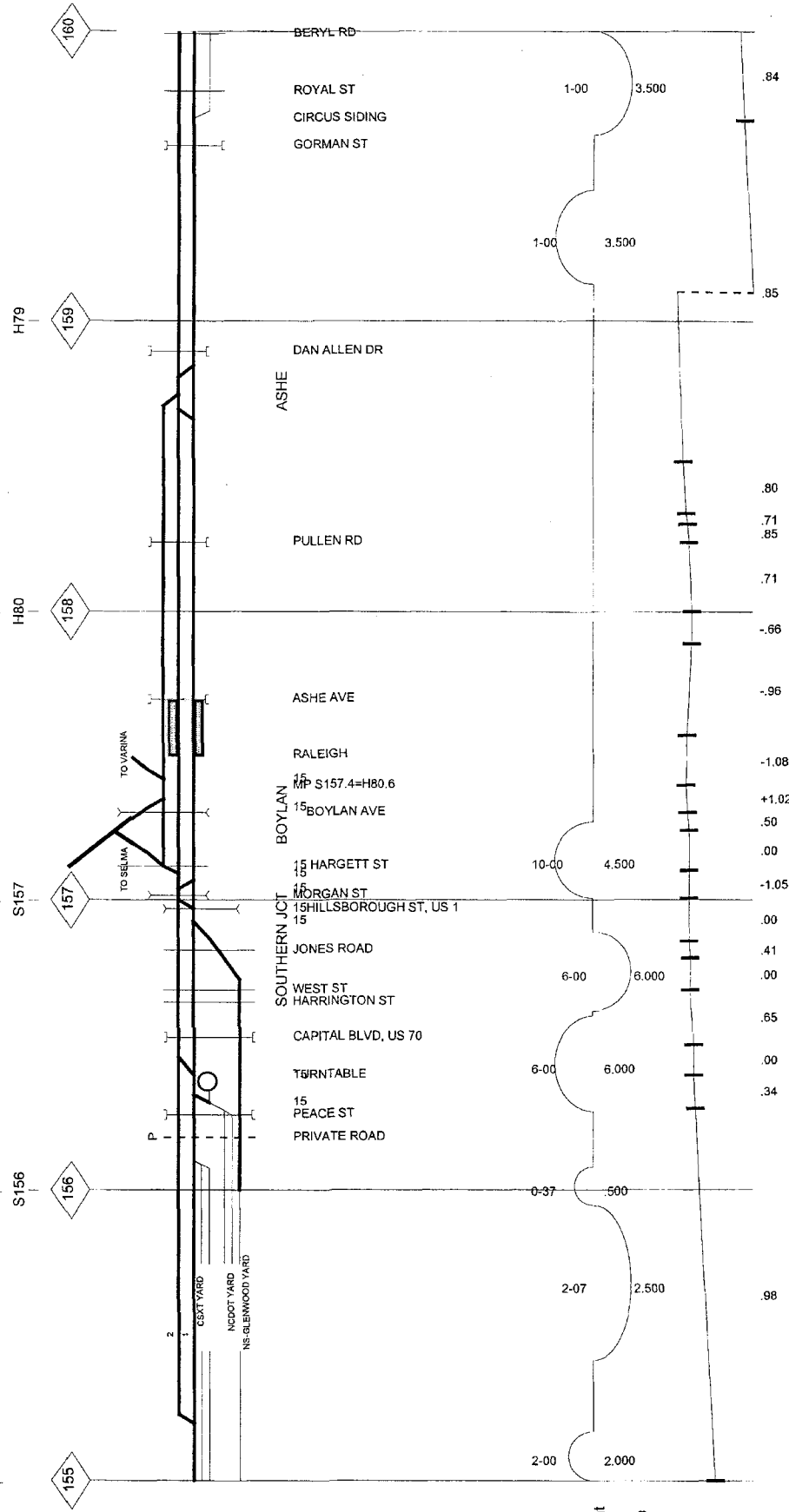

Deg. Of Curve
 Horiz. Alignment
 Super Elevation
 Vert. Alignment
 Grade

E X I S T I N G

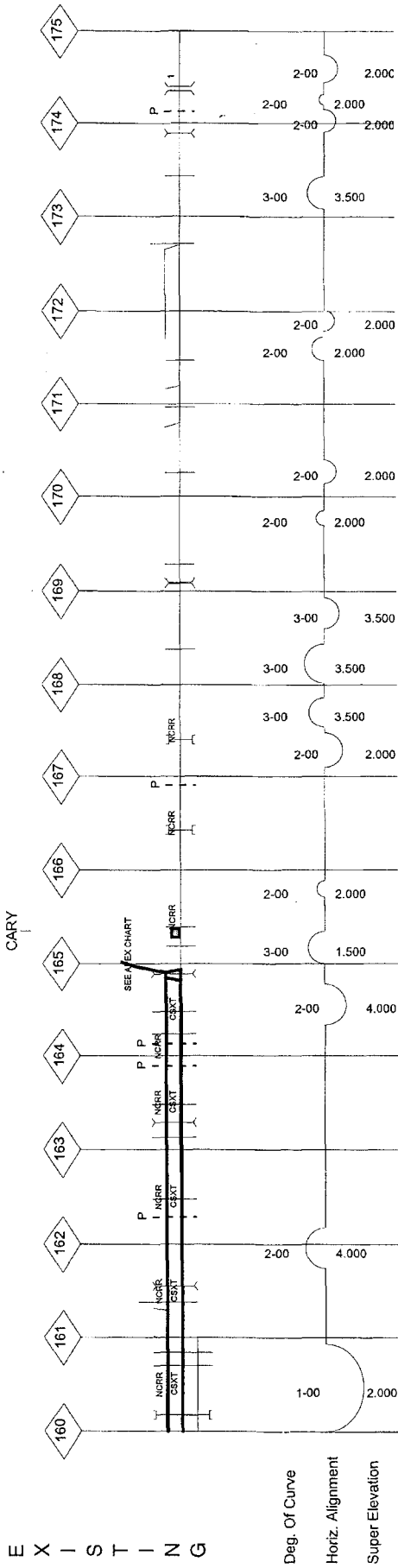

Deg. Of Curve
 Horiz. Alignment
 Super Elevation

P R O P O S E E D

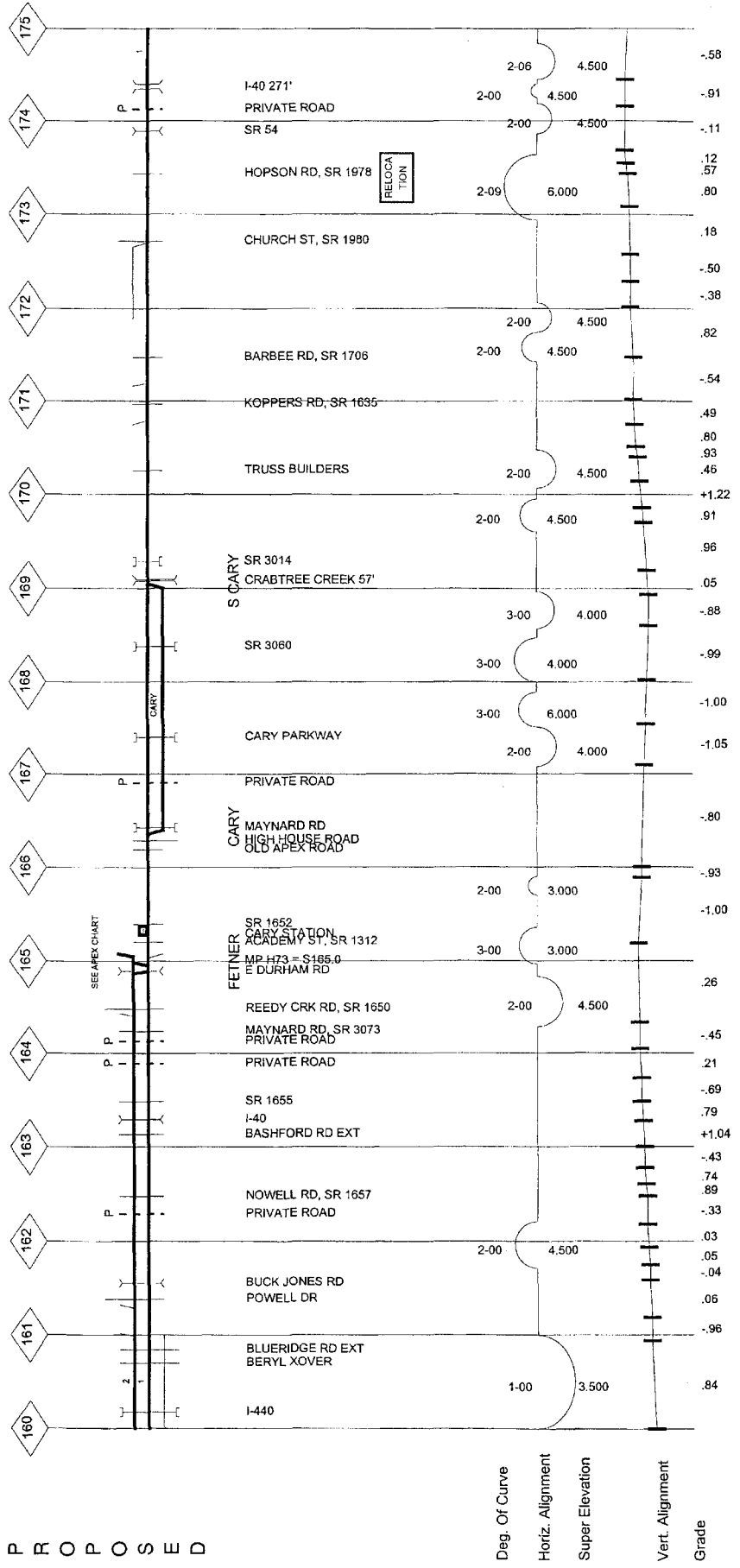

Deg. Of Curve
 Horiz. Alignment
 Super Elevation
 Vert. Alignment
 Grade

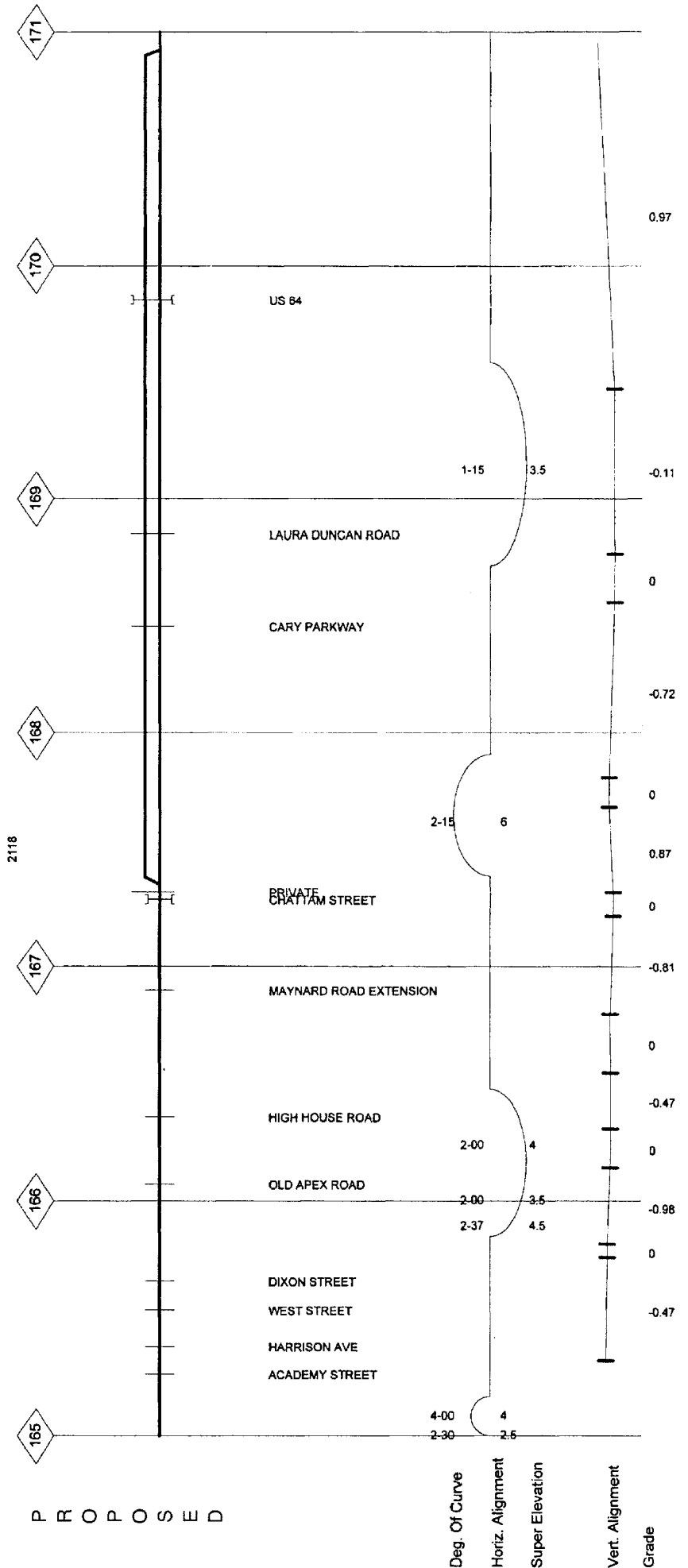
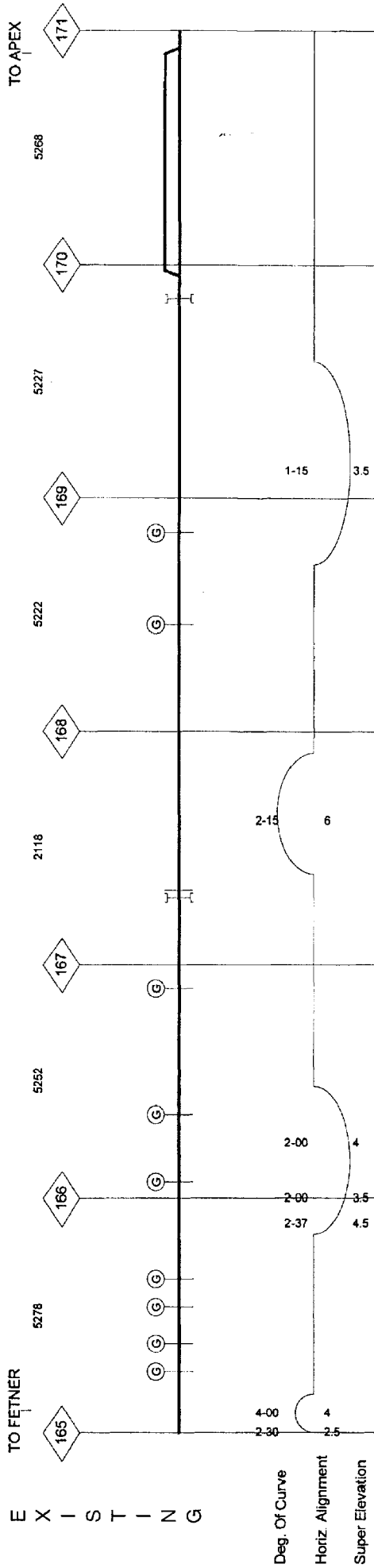

Track Chart 14a

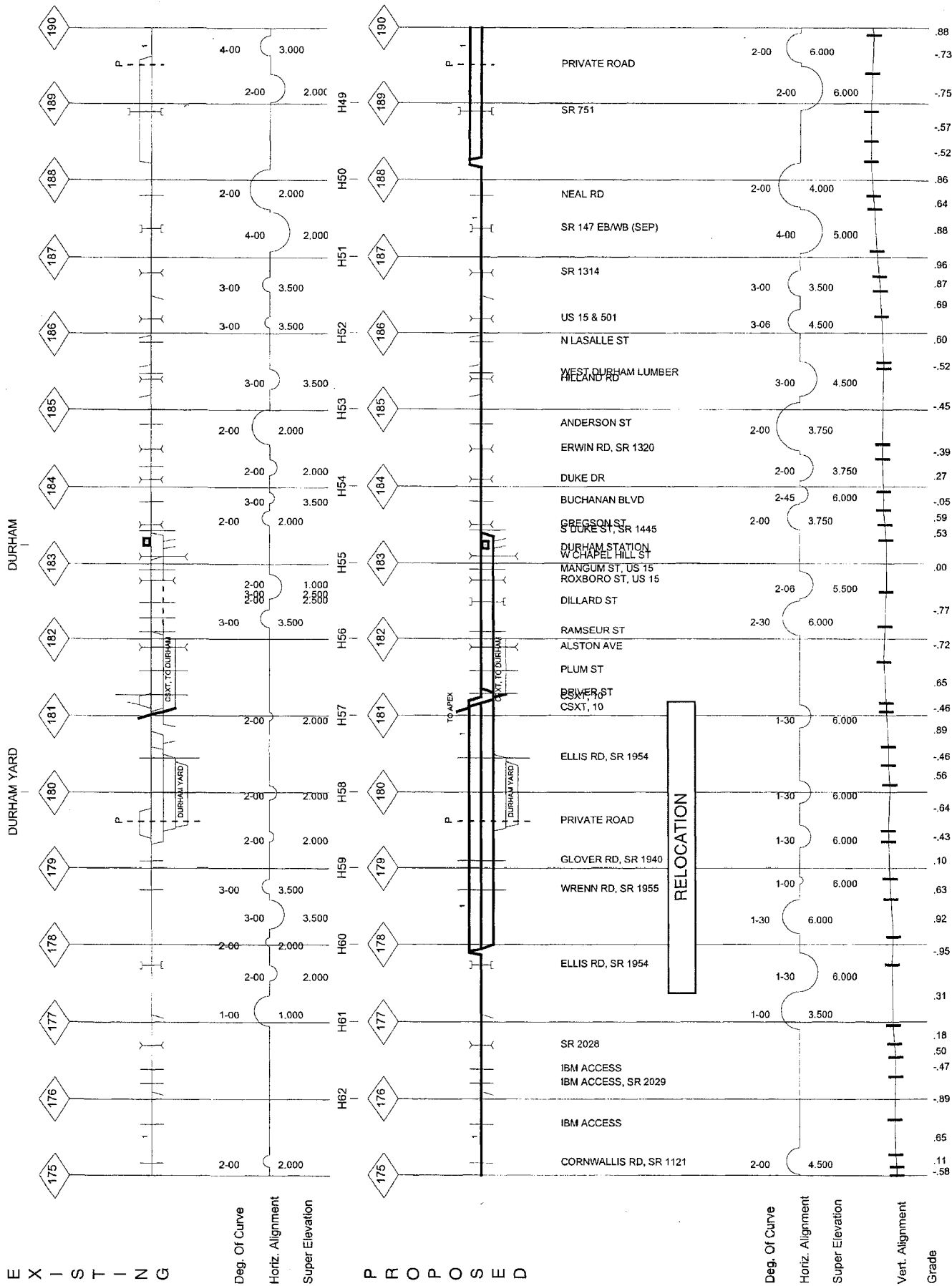

Track Chart 15

E X I S T I N G

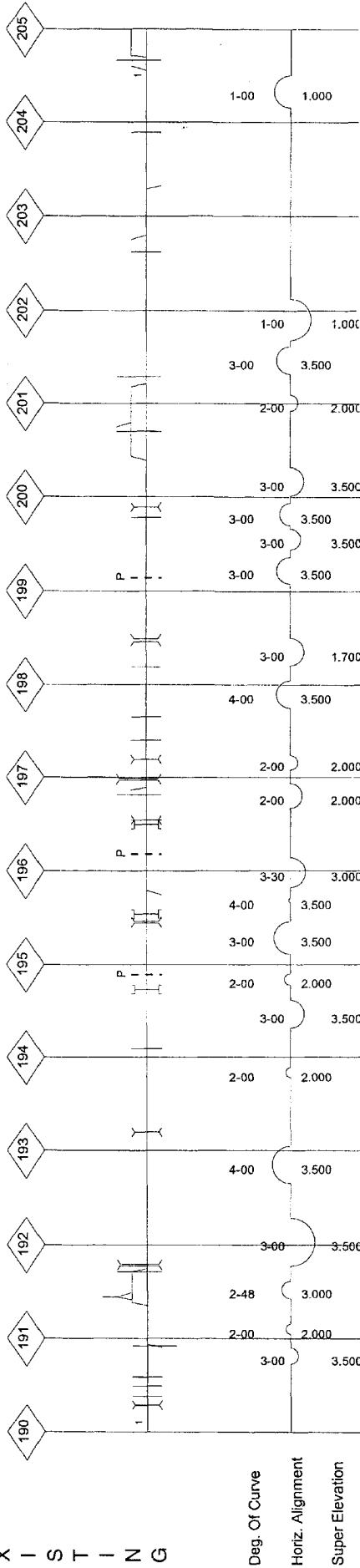

Deg. Of Curve
Horiz. Alignment
Super Elevation

P R O P O S E D

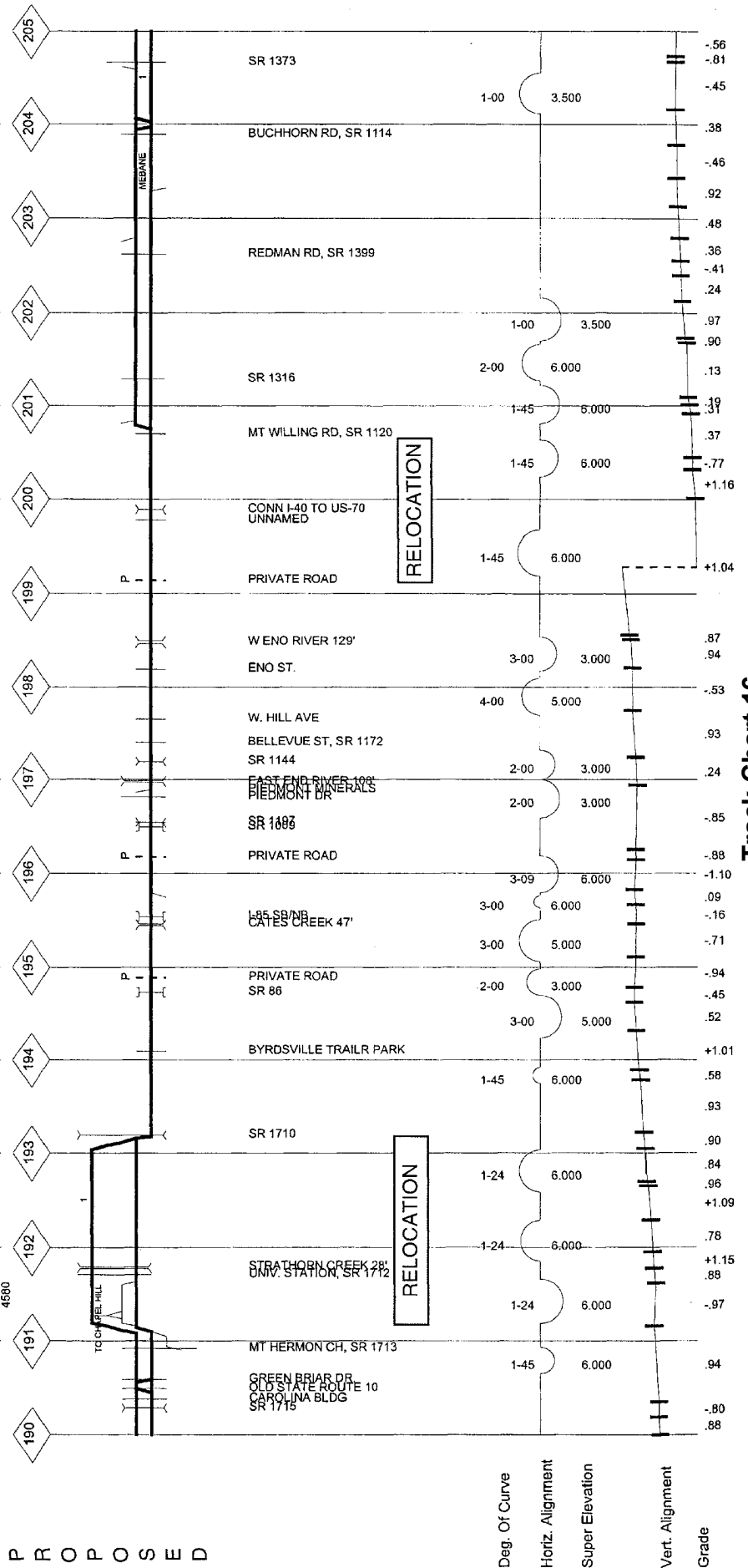

Deg. Of Curve
Horiz. Alignment
Super Elevation
Vert. Alignment
Grade

Track Chart 16

E X I S T I N G

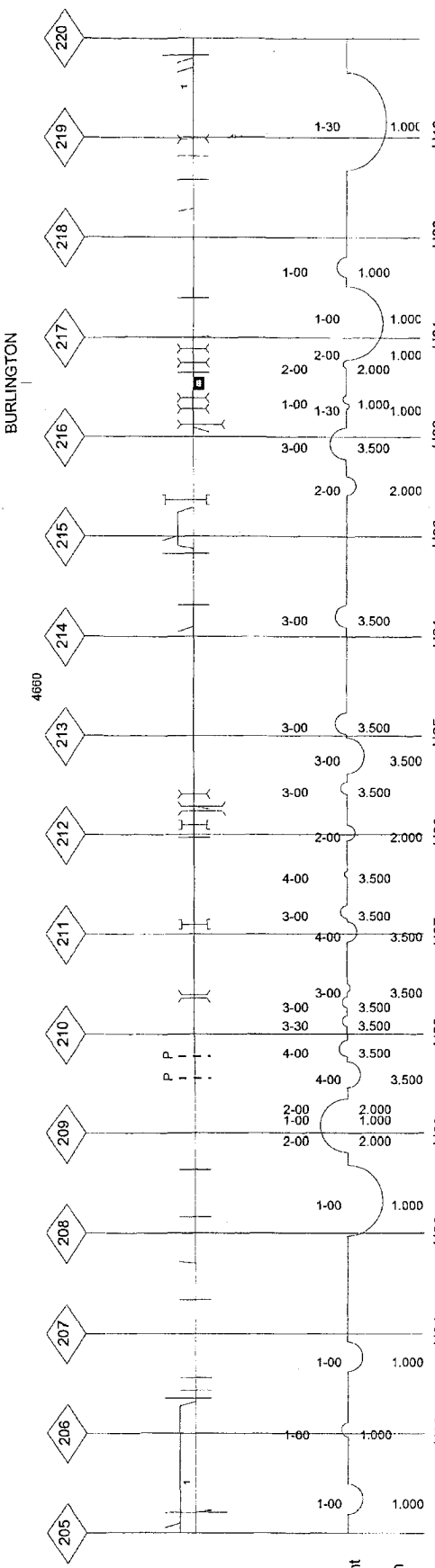

P R O P O S E D

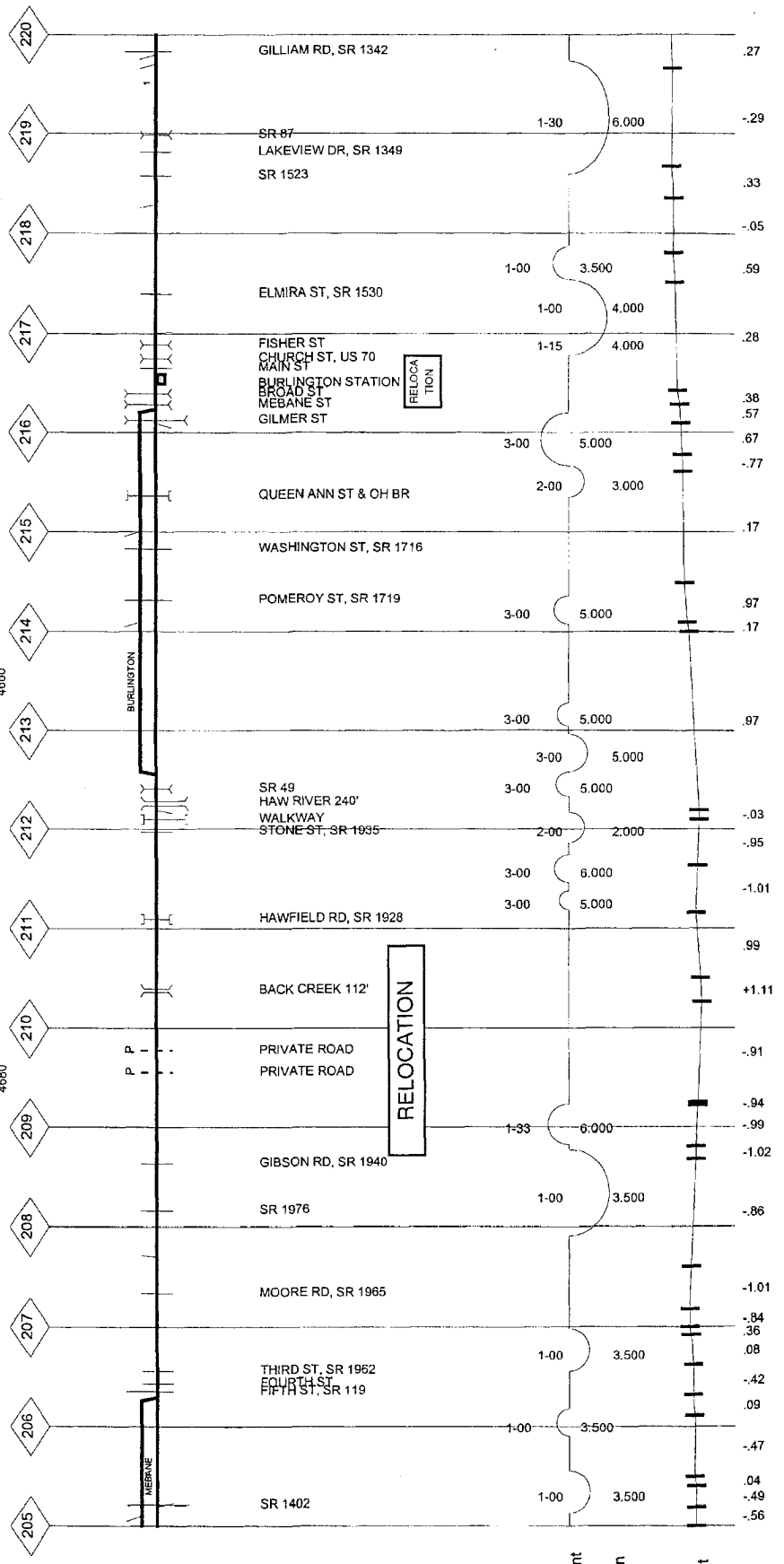

Track Chart 17

BURLINGTON

BURLINGTON

RELOCATION

RELOCATION

4660

4660

4680

P P

P P

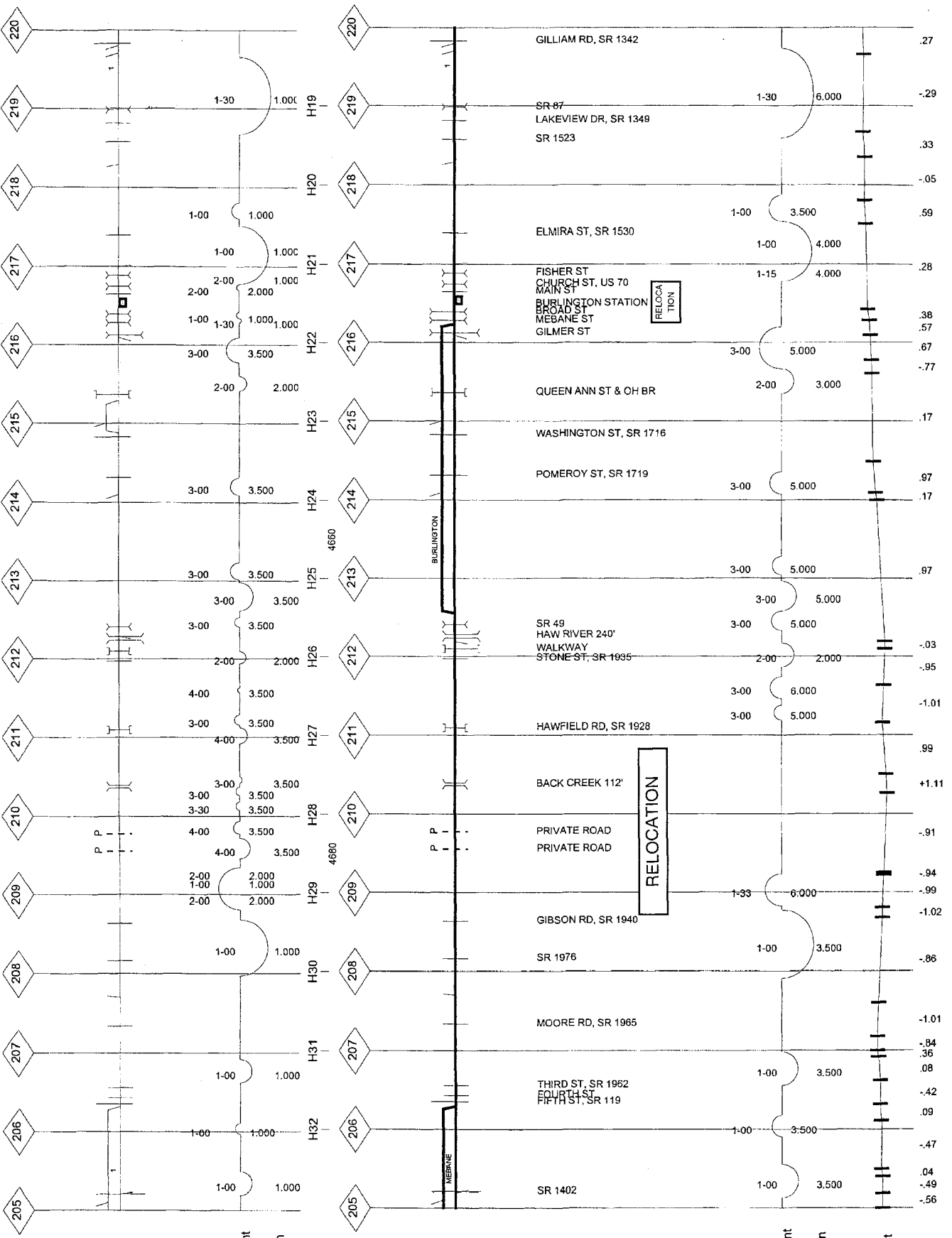

E X I S T I N G

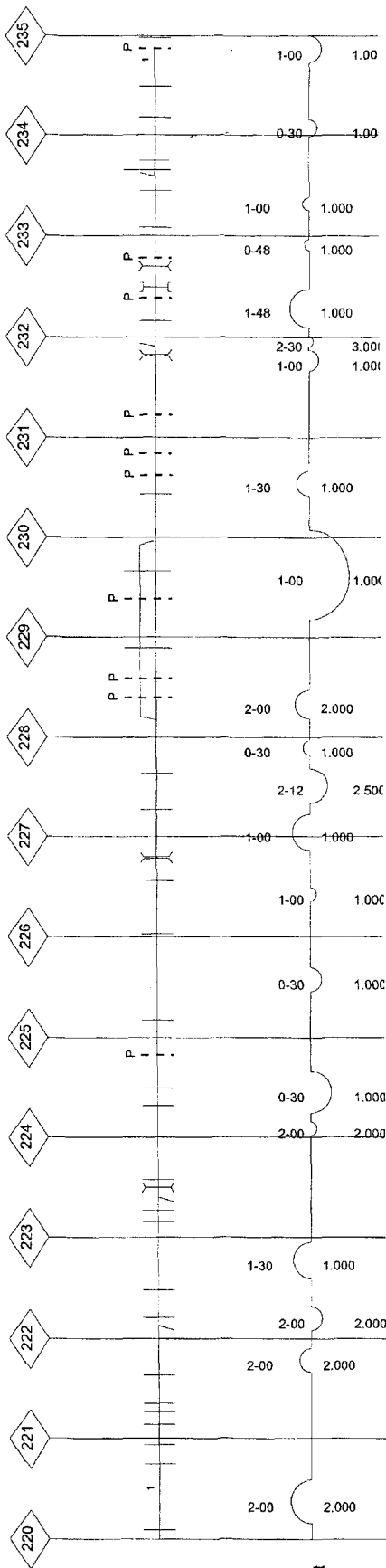

Deg. Of Curve
Horiz. Alignment
Super Elevation

P R O P O S E E D

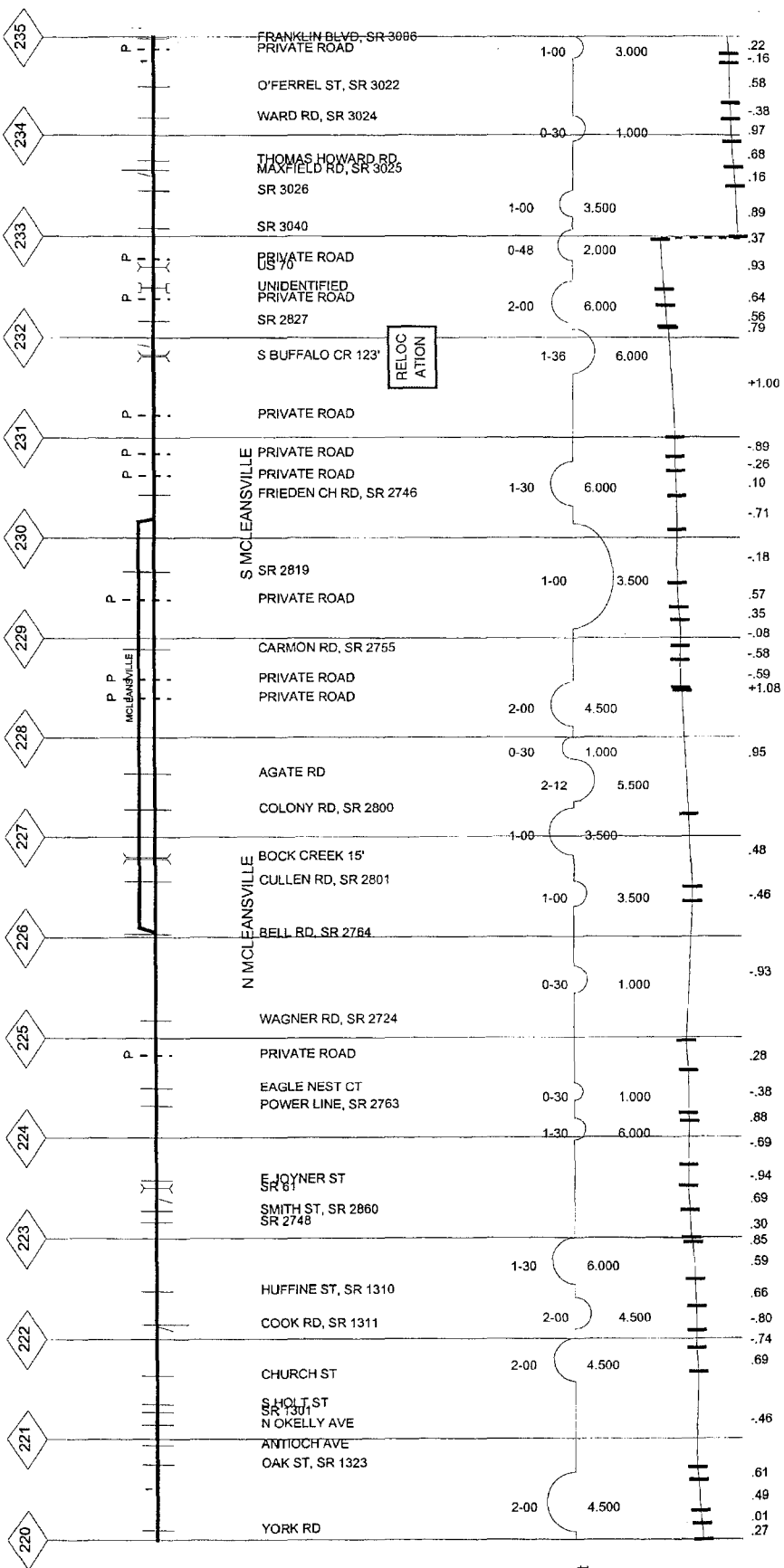

Deg. Of Curve
Horiz. Alignment
Super Elevation
Vert. Alignment
Grade

Track Chart 18

MP H0=P283.9, GREENSBORO

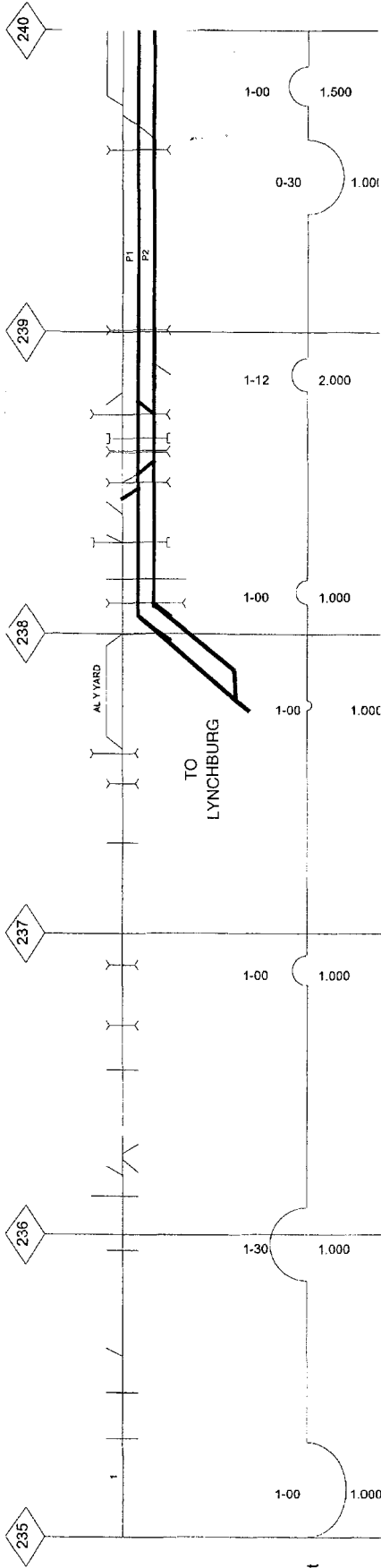

P285

P R O P O S E D

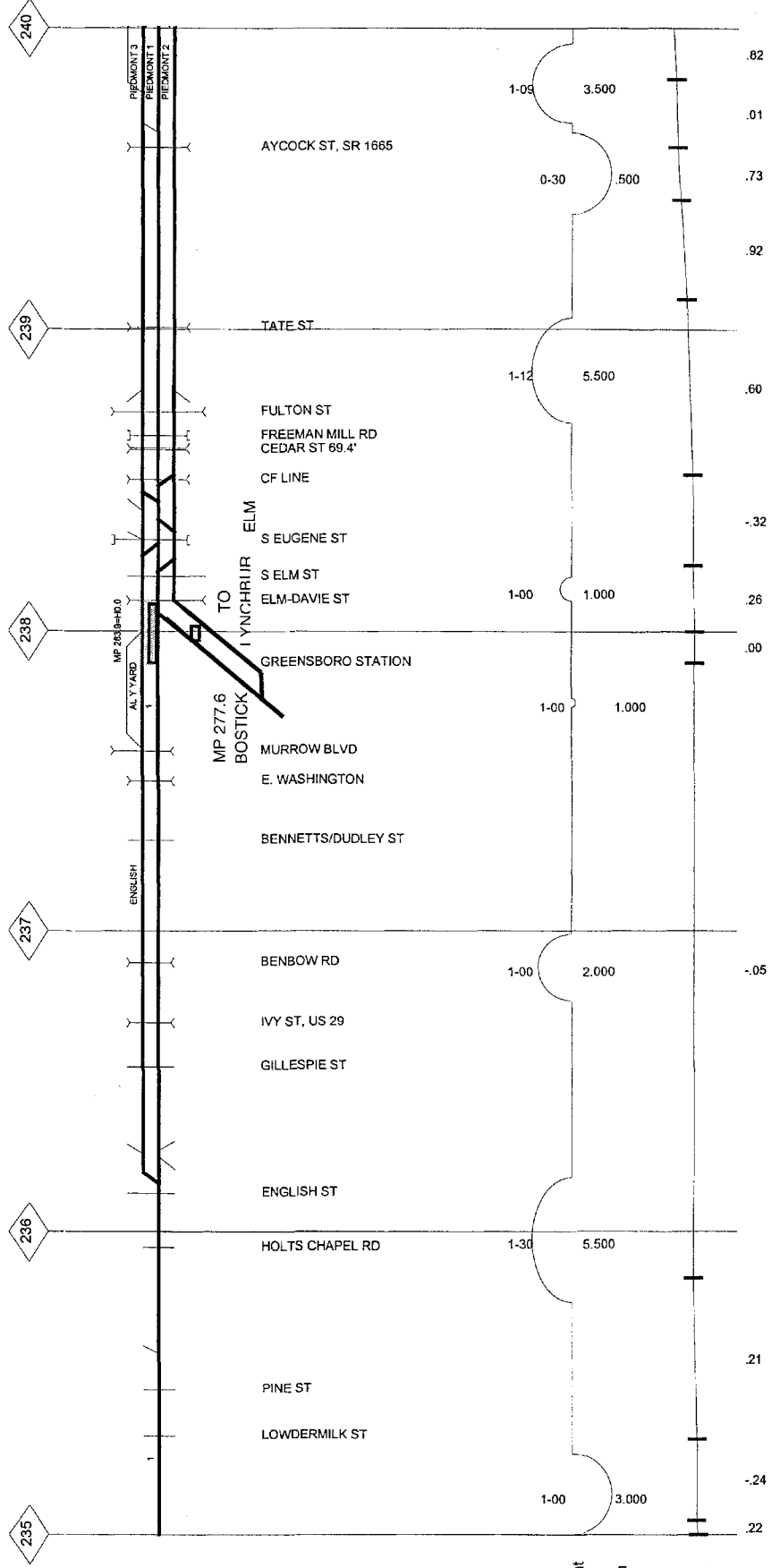

Track Chart 19

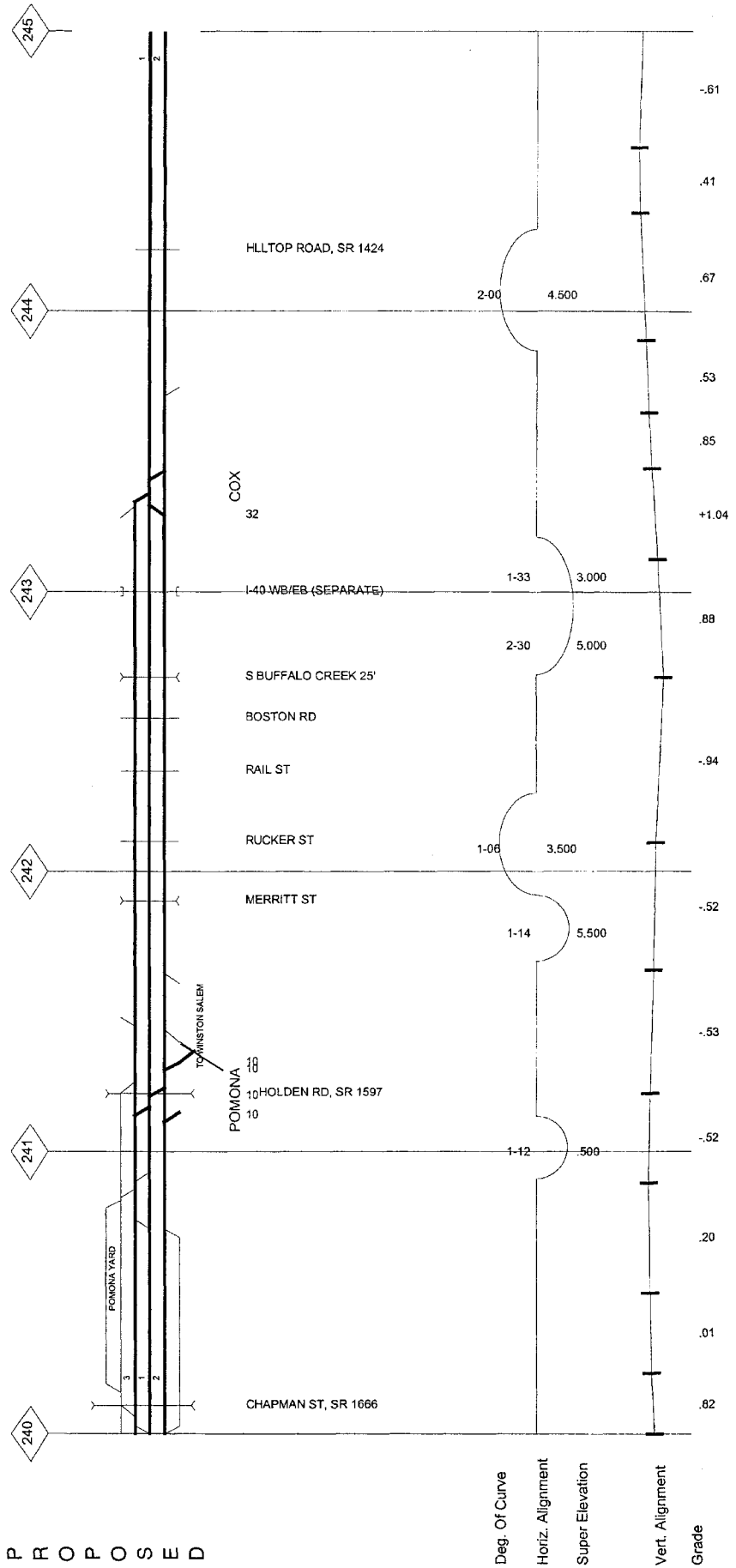
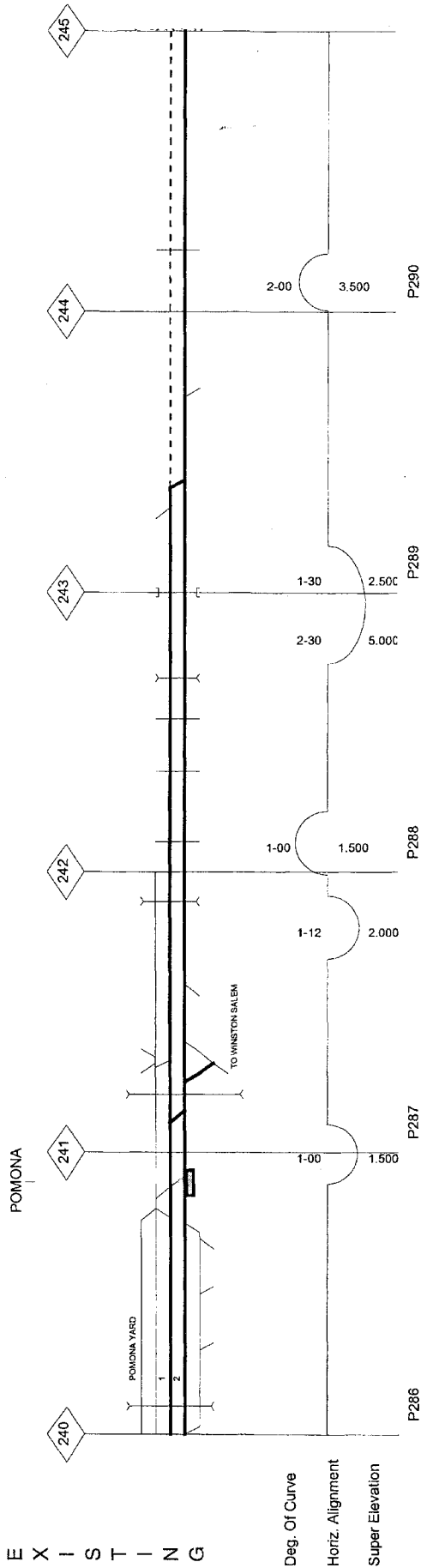

Track Chart 20

HIGHPOINT HIGHPOINT YARD

E X I S T I N G

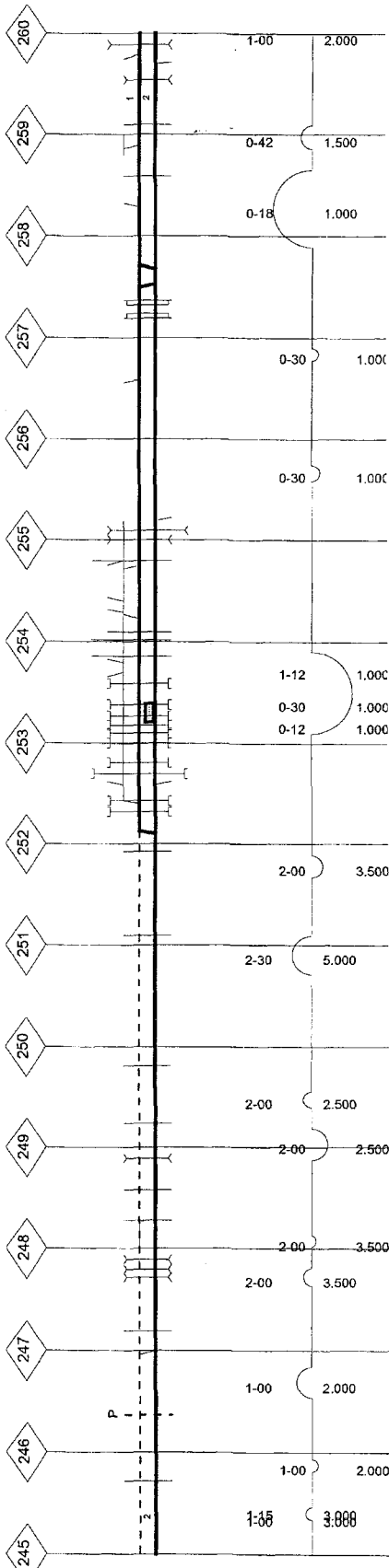

P R O P O S E E D

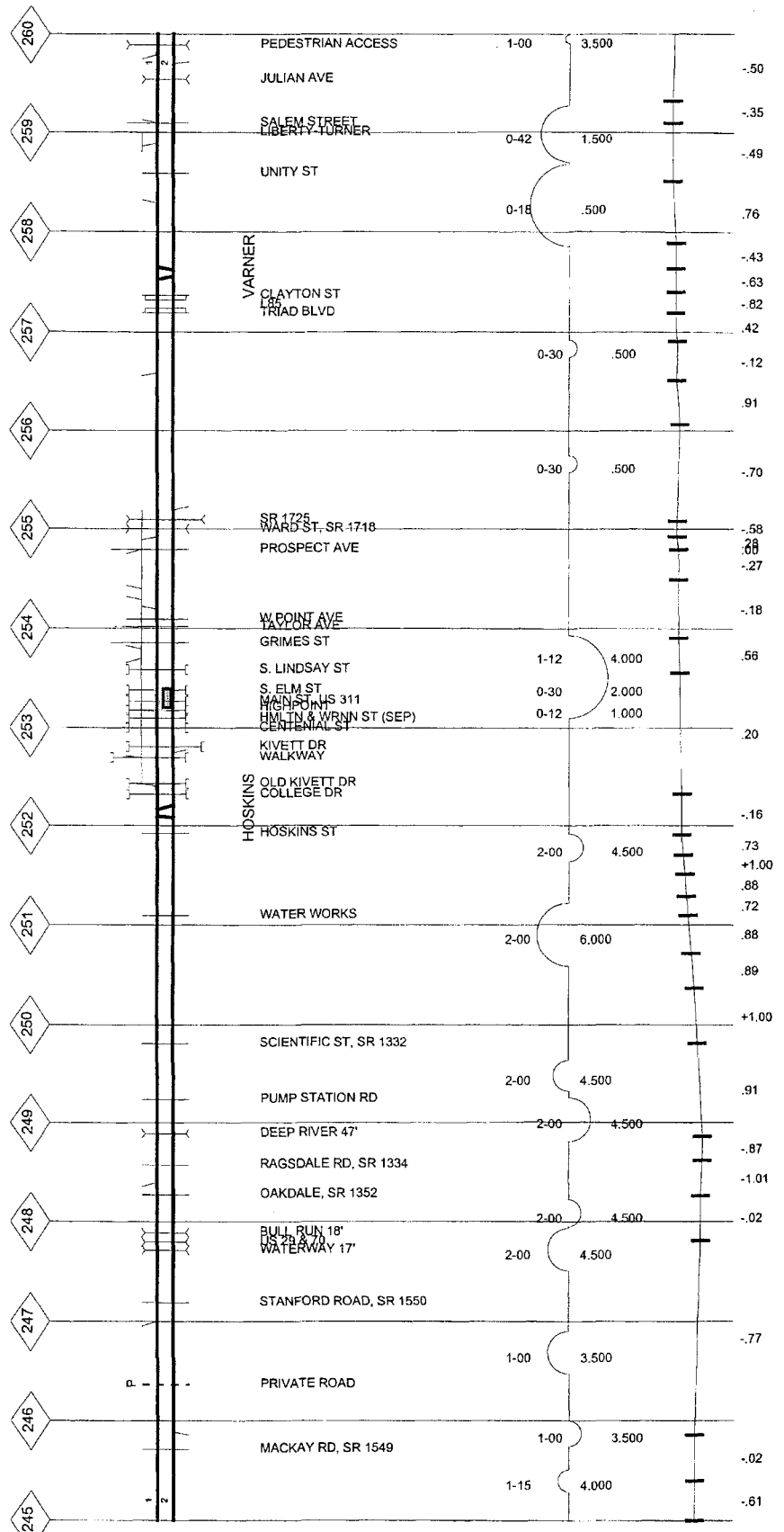

Track Chart 21

E X I S T I N G

LEXINGTON

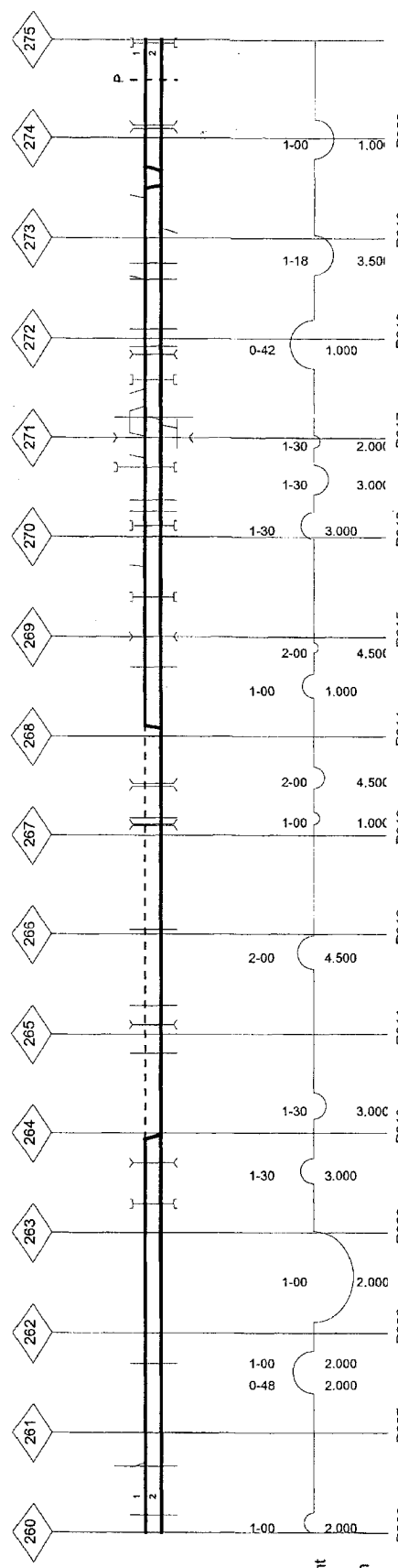

Deg. Of Curve
Horiz. Alignment
Super Elevation

P R O P O S E D

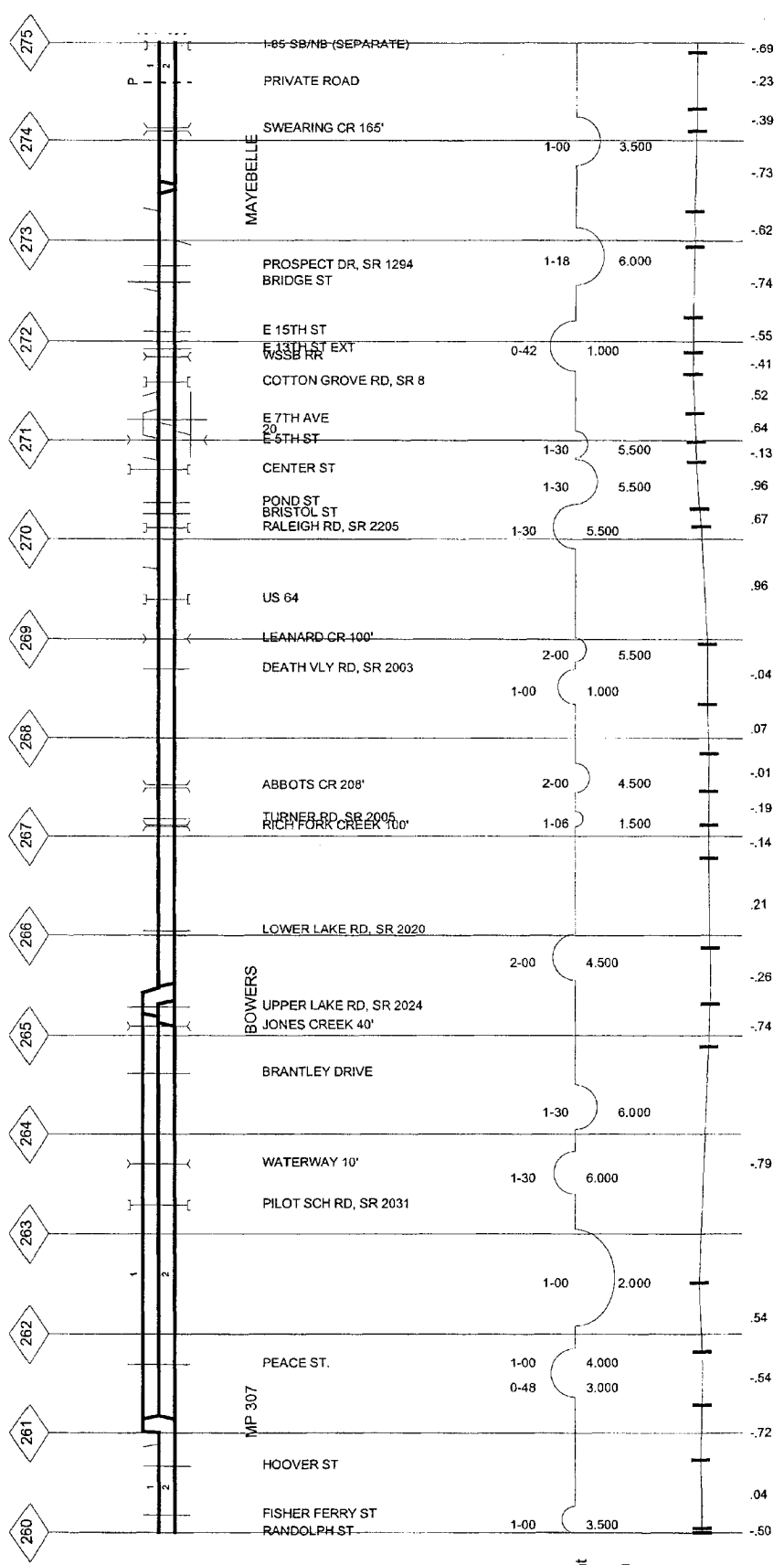

Deg. Of Curve
Horiz. Alignment
Super Elevation
Vert. Alignment
Grade

Track Chart 22

E
X
I
S
T
I
N
G

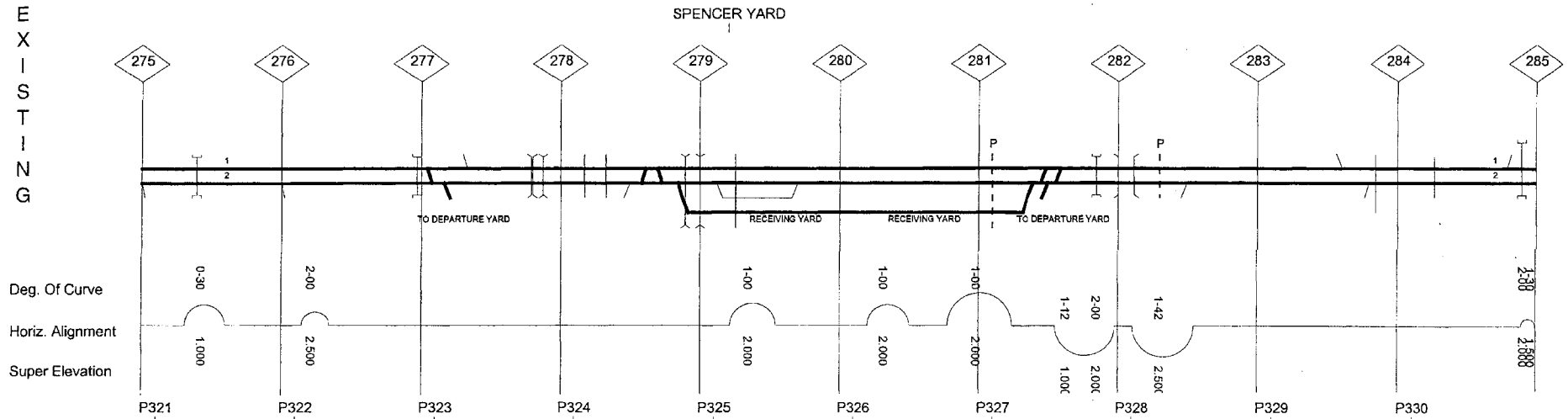

P
R
O
P
O
S
E
D

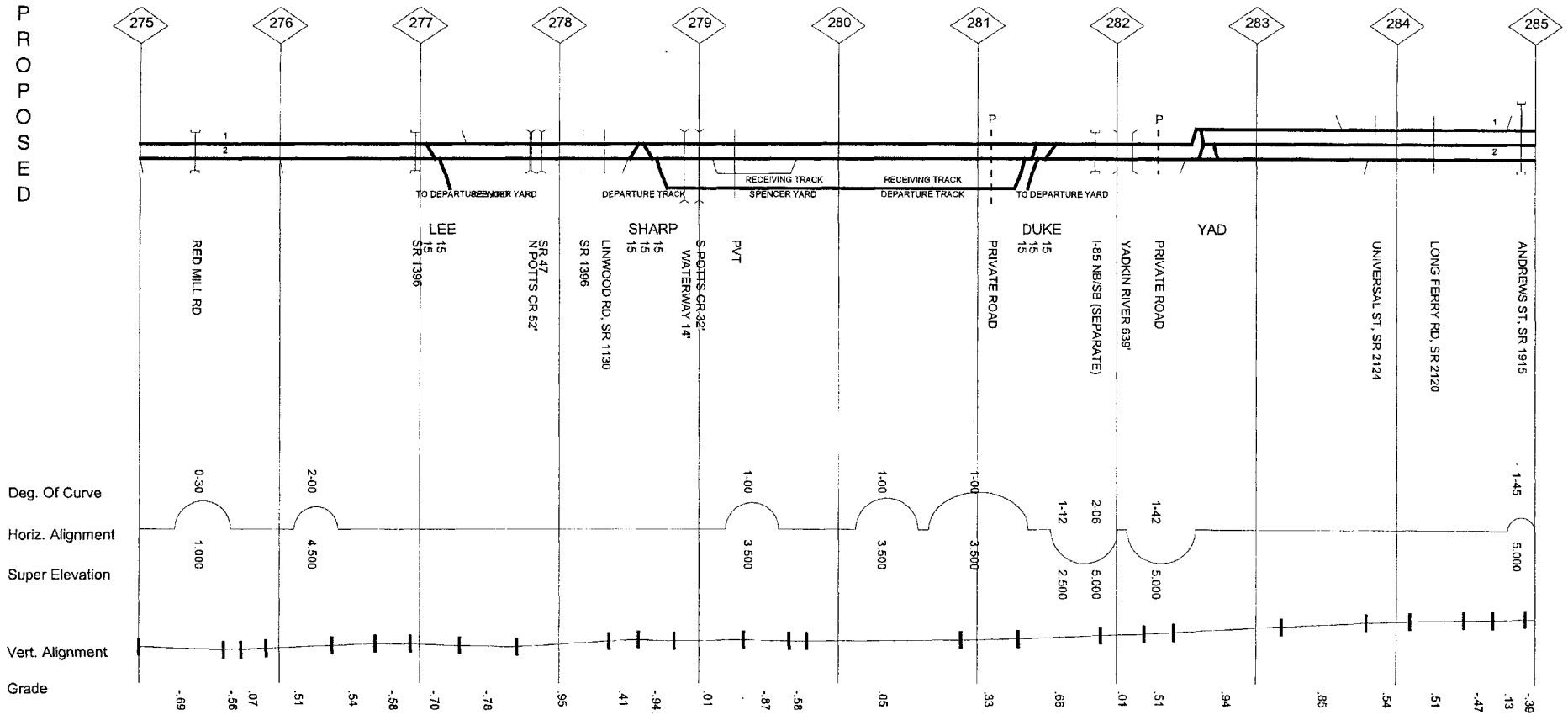

Track Chart 23

EXISTING

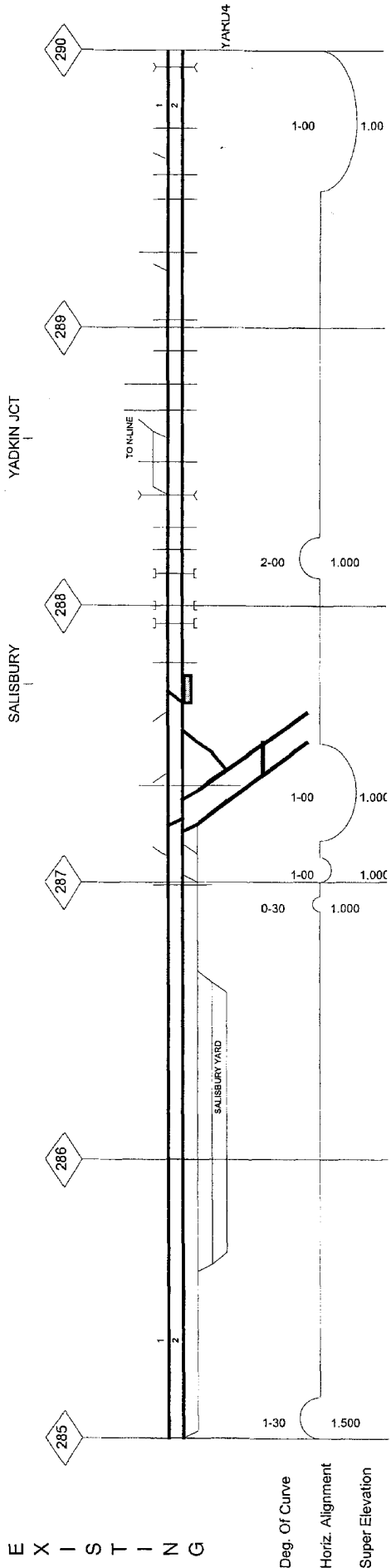

Deg. Of Curve
 Horiz. Alignment
 Super Elevation

PROPOSED

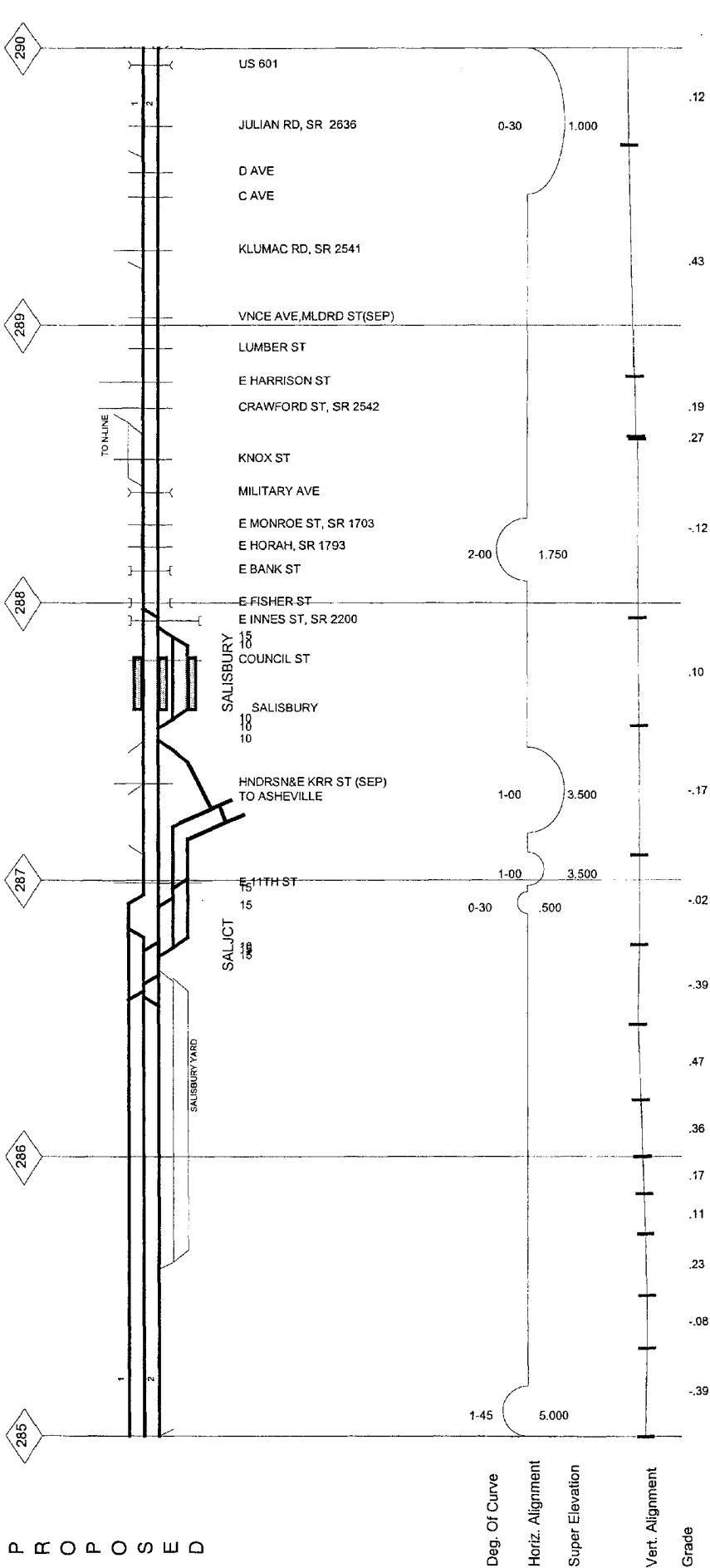

Deg. Of Curve
 Horiz. Alignment
 Super Elevation
 Vert. Alignment
 Grade

KANNAPOLIS

E X I S T I N G

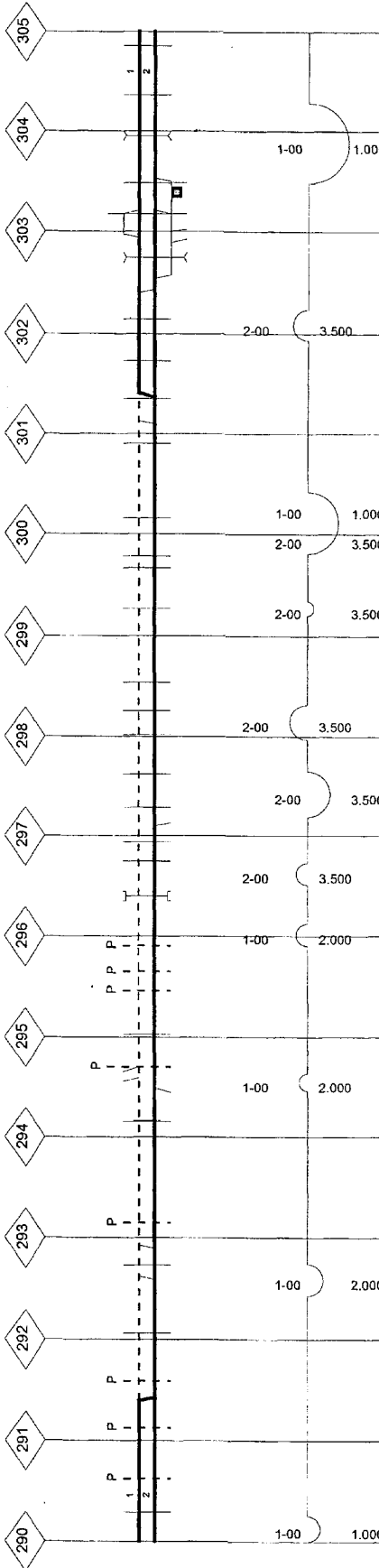

Deg. Of Curve
 Horiz. Alignment
 Super Elevation

P R O P O S E D

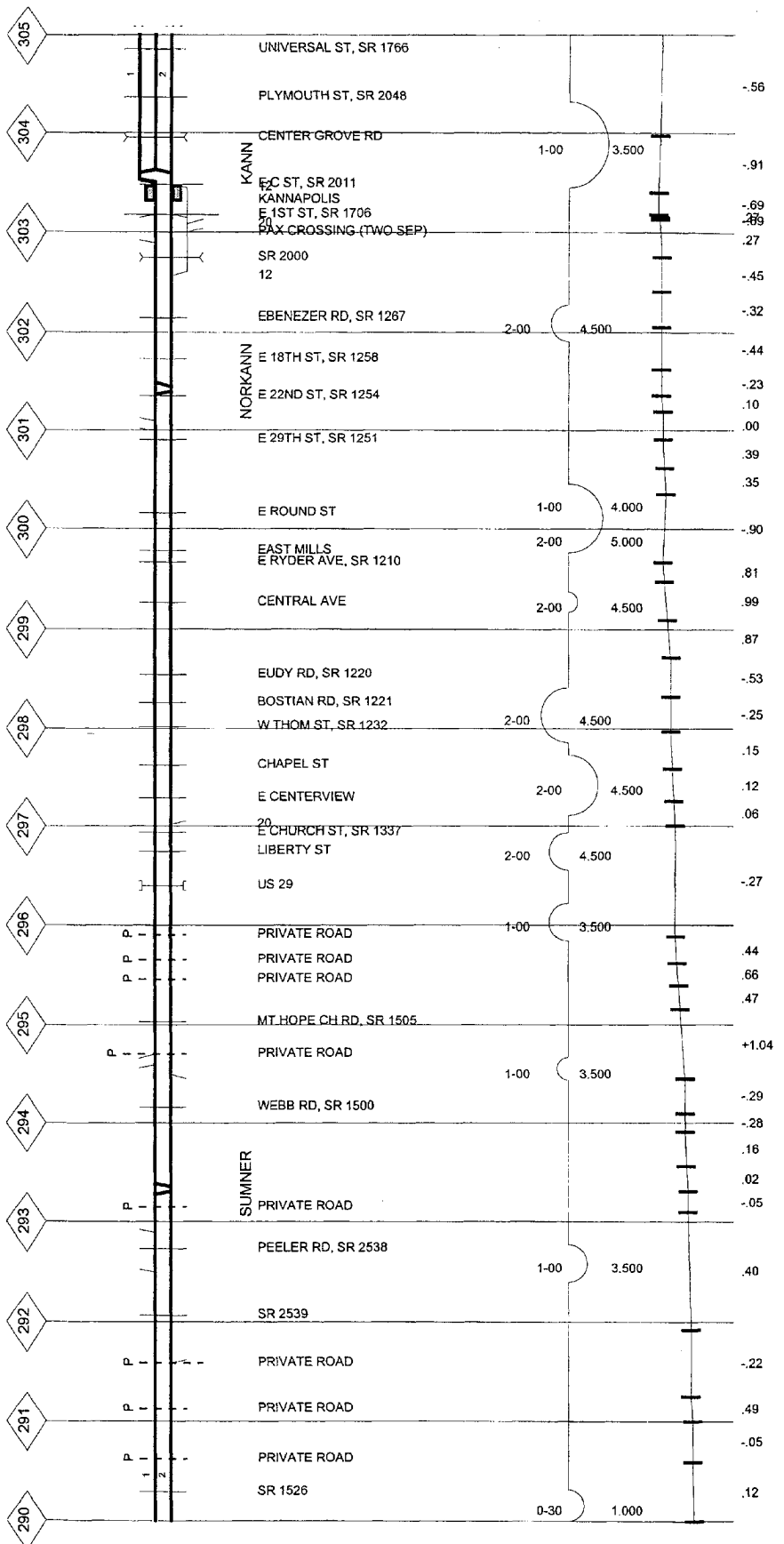

Deg. Of Curve
 Horiz. Alignment
 Super Elevation
 Vert. Alignment
 Grade

Track Chart 25

E X I S T I N G

CONCORD

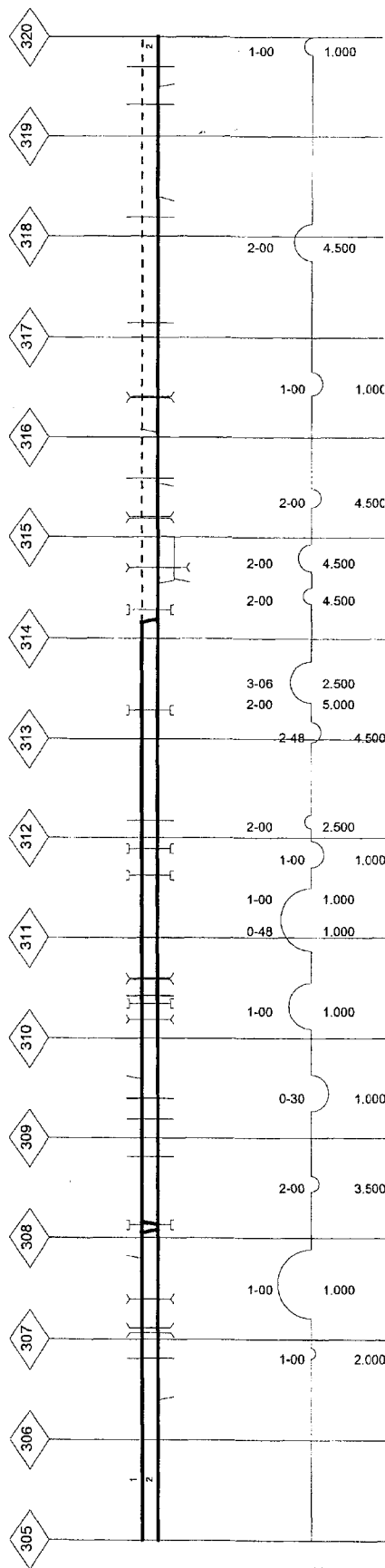

P R O P O S E D

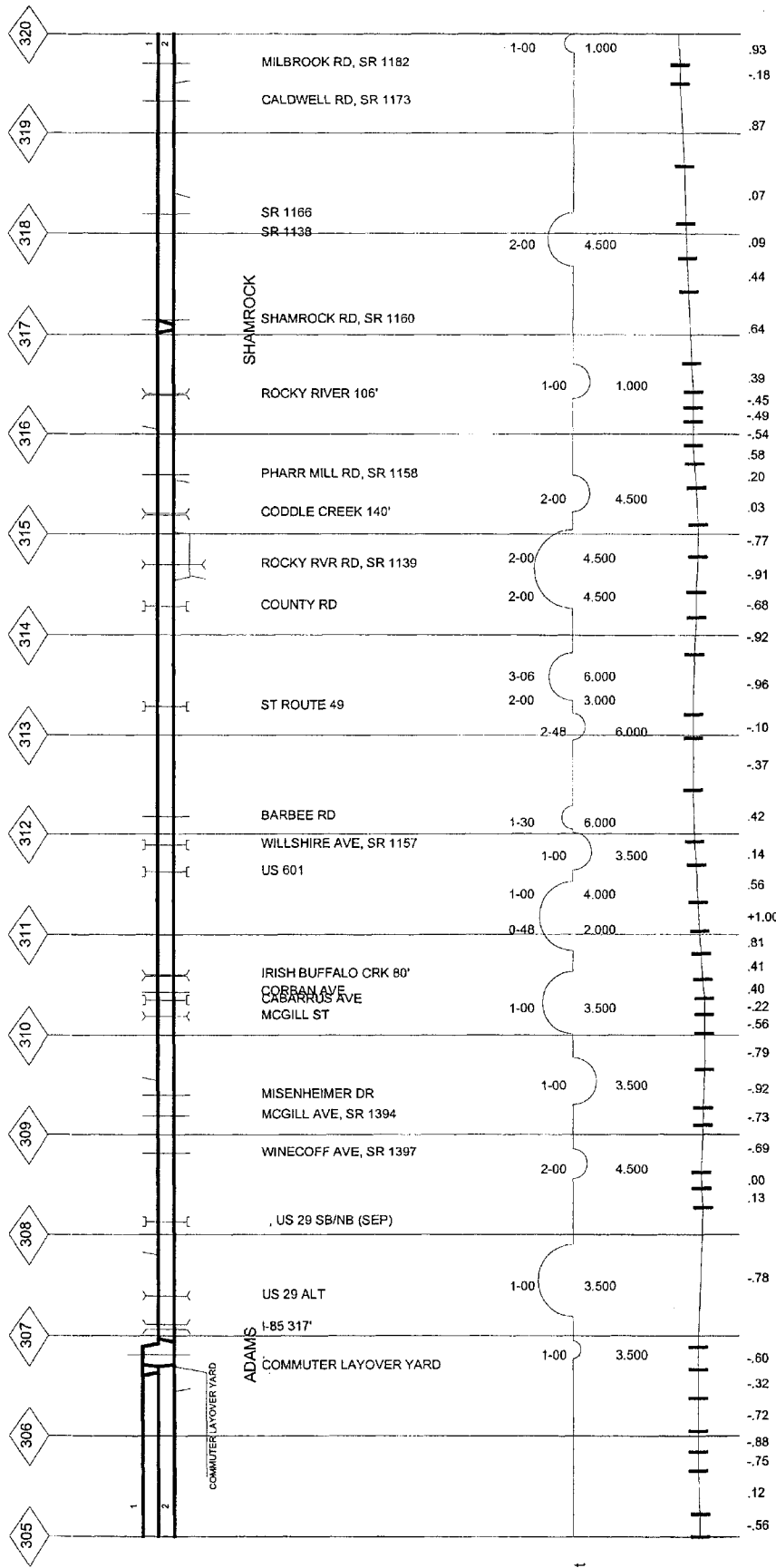

Track Chart 26

E X I S T I N G

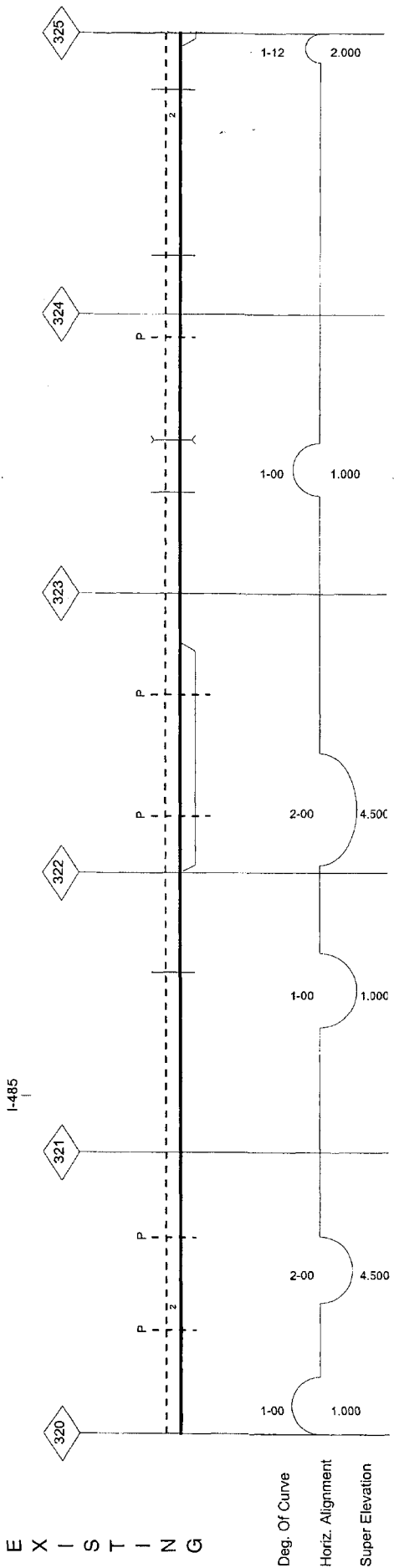

Deg. Of Curve
 Horiz. Alignment
 Super Elevation

P R O P O S E D

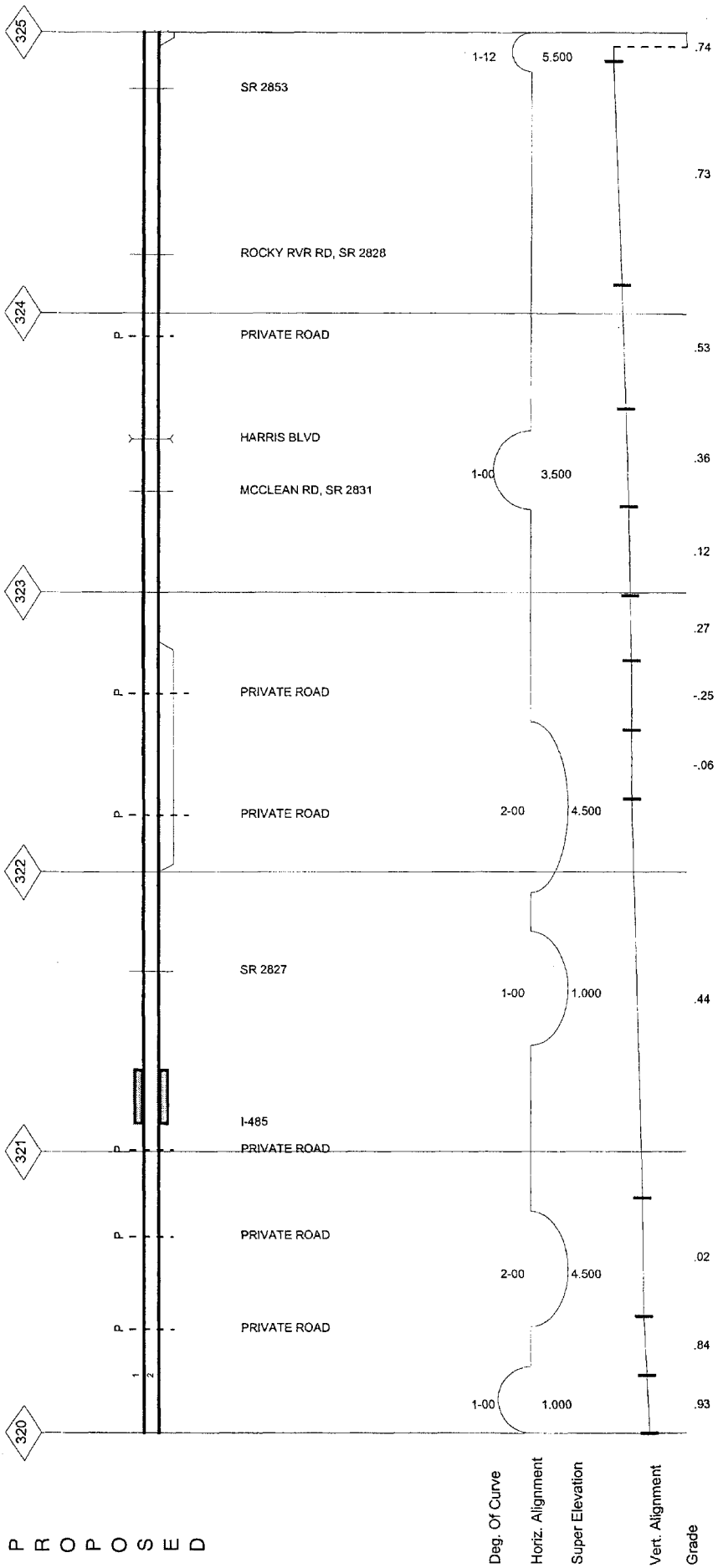

Deg. Of Curve
 Horiz. Alignment
 Super Elevation
 Vert. Alignment
 Grade

Track Chart 27

E X I S T I N G

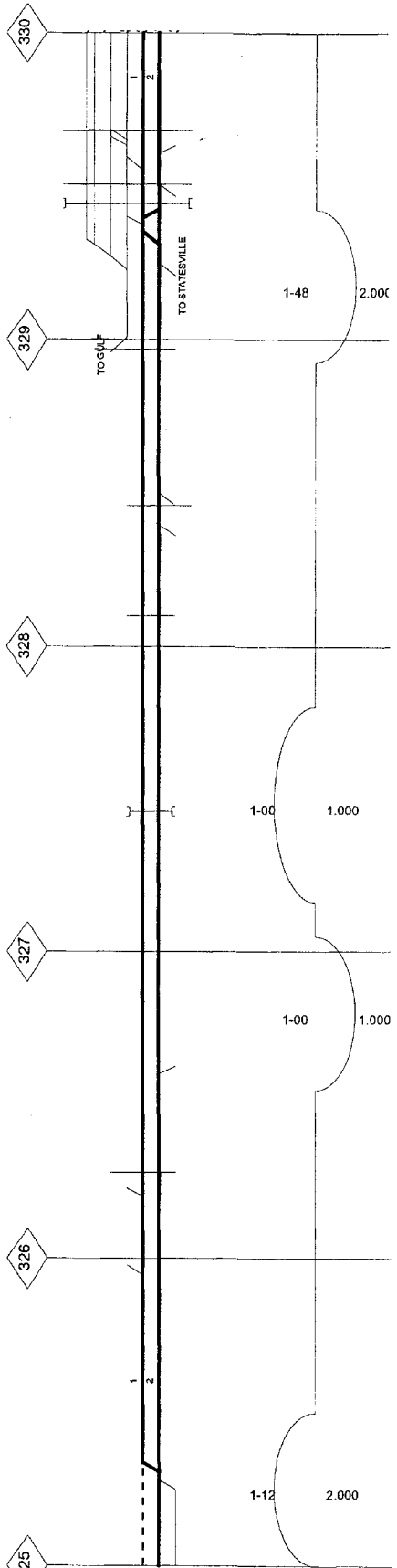

Deg. Of Curve
 Horiz. Alignment
 Super Elevation

P R O P O S E D

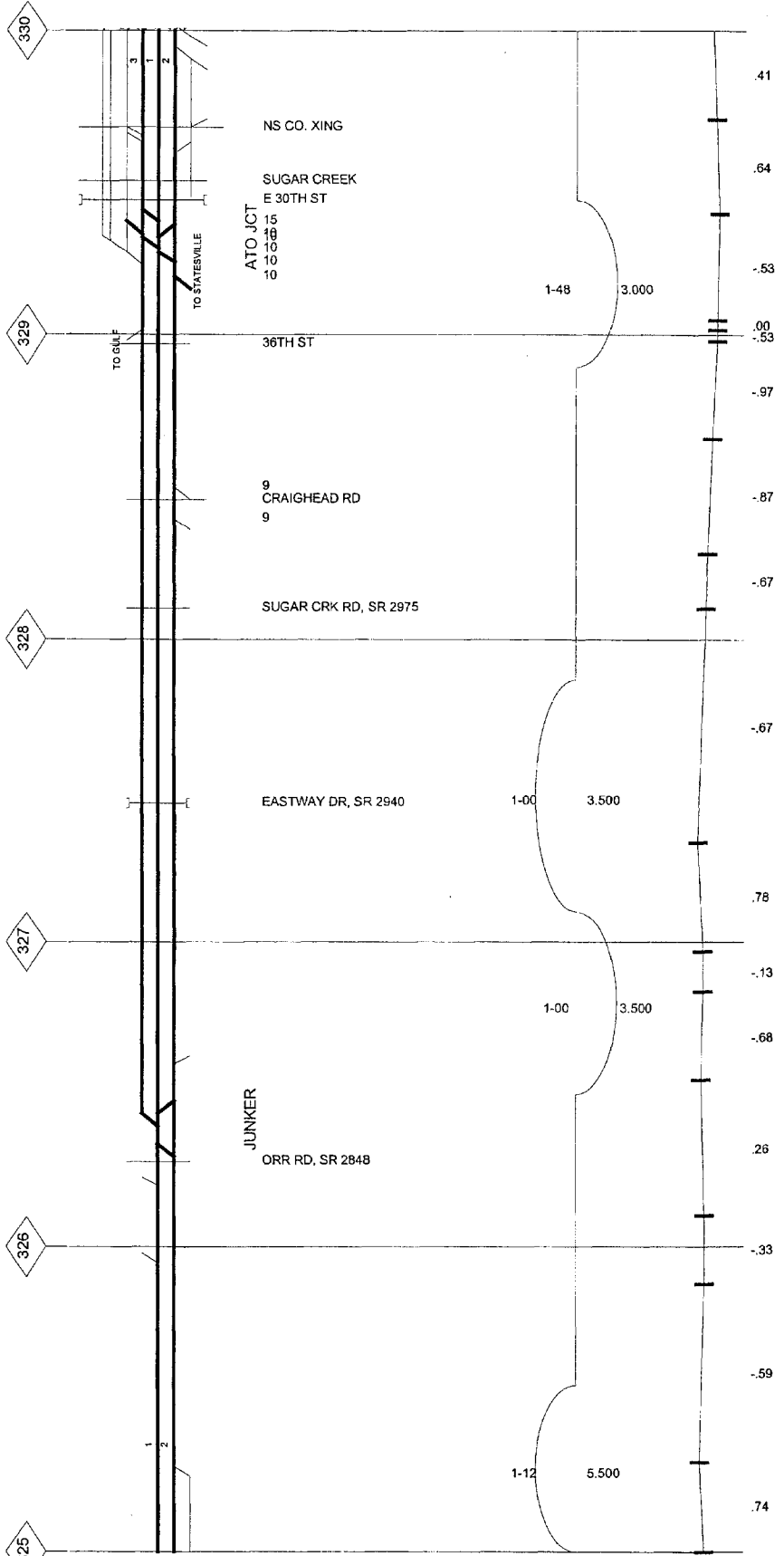

Deg. Of Curve
 Horiz. Alignment
 Super Elevation
 Vert. Alignment
 Grade

Track Chart 28

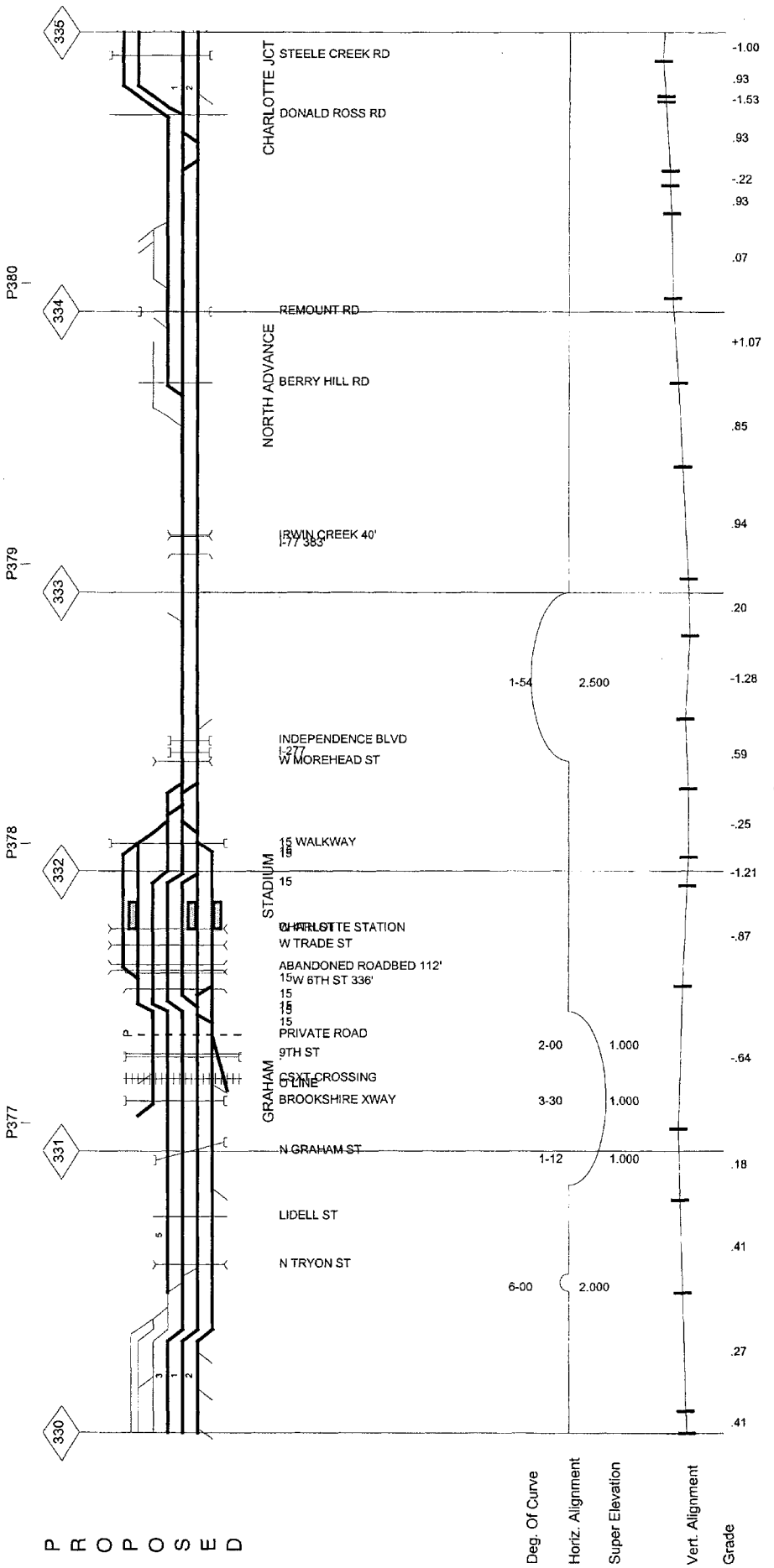
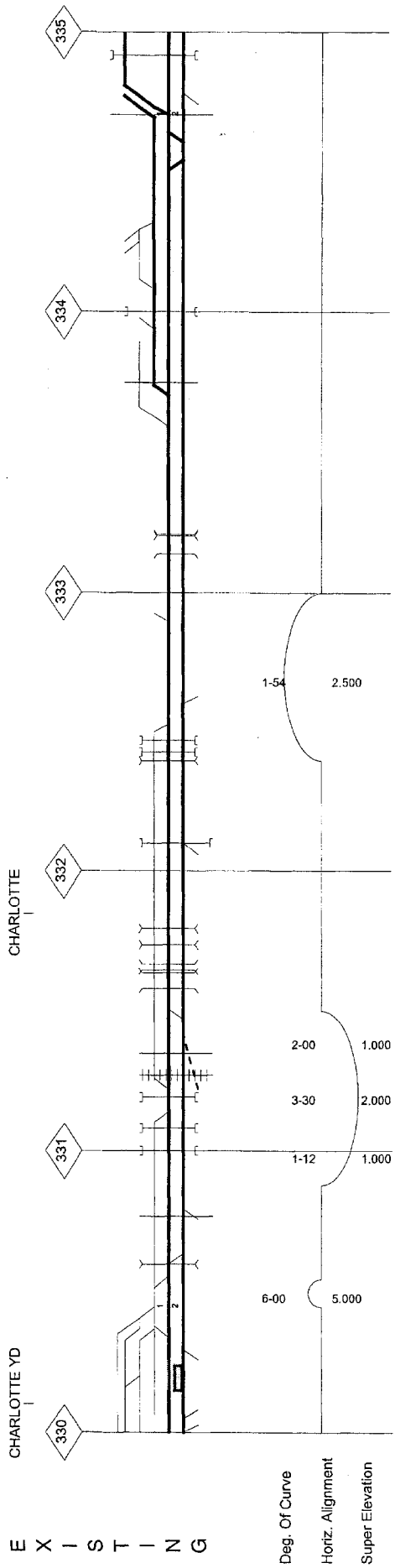

Track Chart 29

E X I S T I N G

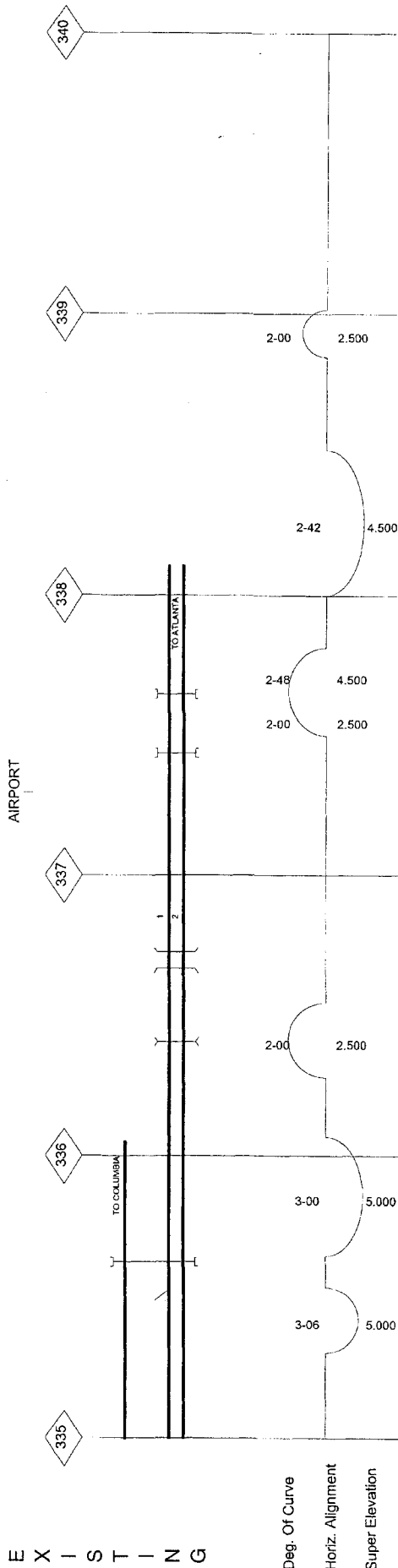

P R O P O S E D

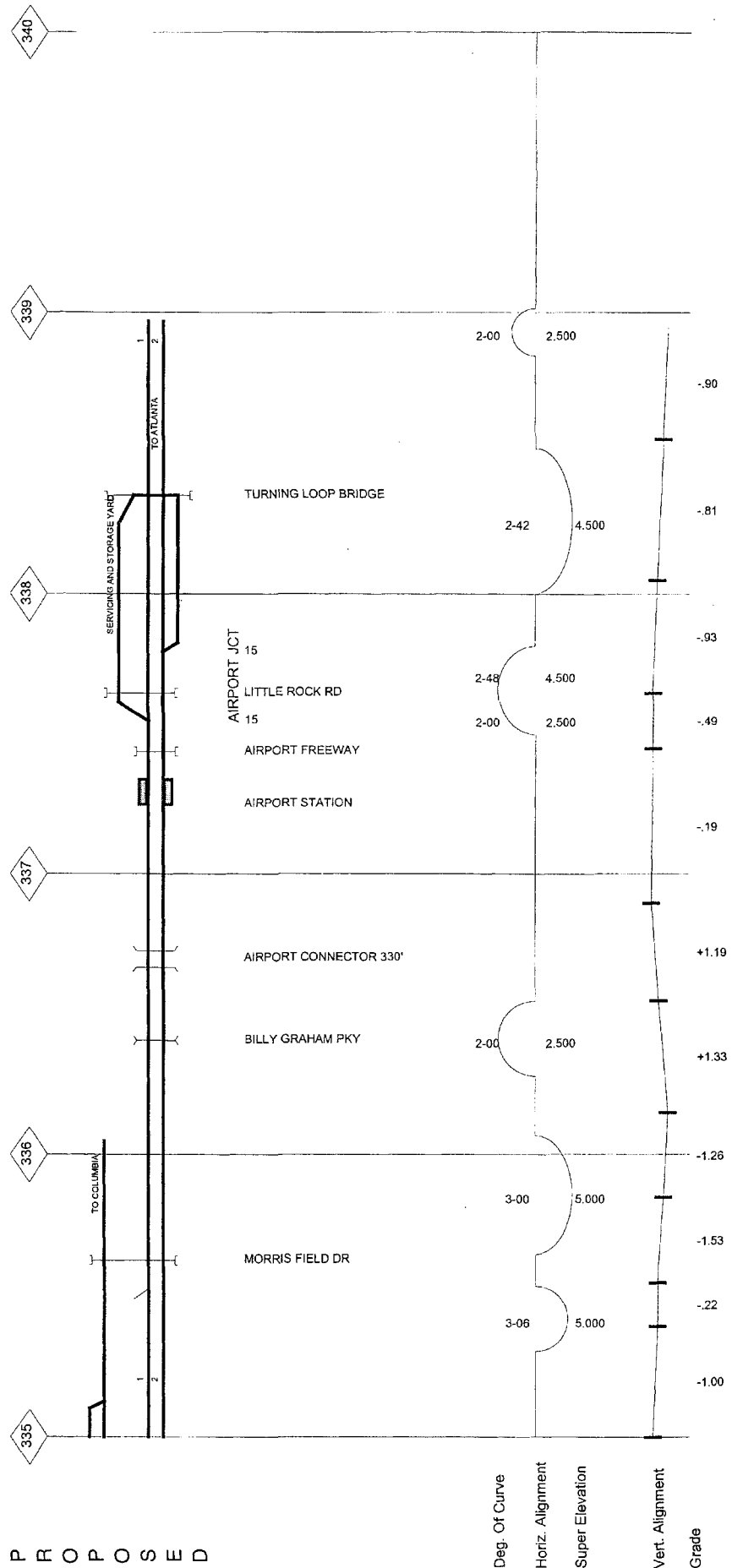

Track Chart 30

**Technical Monograph:
Transportation Planning
for the Richmond–Charlotte Railroad Corridor**

January 2004

**Appendix E
Ownership and Operating Rights**

**Federal Railroad Administration
United States Department of Transportation**

Appendix E

OWNERSHIP AND OPERATING RIGHTS

INTRODUCTION

The following summary is for information purposes only. It is not intended to establish the legal effects of the various agreements or the rights of the parties thereto. The summaries of the agreements do not necessarily include all of the points covered by the agreements.

SUMMARY OF OWNERSHIP AND OPERATING RIGHTS

Definition

The precise definition of the rail corridor considered in this report is the route extending from Richmond Virginia to Charlotte, North Carolina, via the tracks of CSXT, to Raleigh; the North Carolina Railroad, to A.T.&O. Jct. (2.5 miles north of Charlotte); and NS, to Charlotte. It is important to note that the FRA defines the “Southeast Corridor” differently, considering it to extend from Washington, DC to New Orleans (via Atlanta), and Washington, DC to Jacksonville, FL, via both Atlanta, GA and Columbia, SC. This report considers only the line between Richmond and Charlotte. Amtrak’s operating definition is different again, including Washington, DC to Richmond in the Northeast Corridor.

Ownership

The primary owners of the Corridor are CSX Transportation Company (CSXT) and the North Carolina Railroad Company (NCRR). CSXT owns all of the line north of Raleigh, with some minor exceptions discussed below. The North Carolina Railroad owns all of the line to the west and south of Raleigh, with the exception of the short segment within the Charlotte terminal area. Between Boylan Jct. (Raleigh) and Fetner (Cary), a distance of about eight miles, CSX Transportation owns the north track on the NCRR right-of-way. The two tracks are operated as a double-track railroad, and dispatched by CSXT.

Operators

CSXT operates frequent freight service between Richmond and Petersburg, using both the A Line and the S Line north of Centralia. Between Petersburg and Norlina, the S Line is inactive, and the tracks have been removed. From Norlina, the first nine miles on the line is inactive, to Middleburg. Local freight trains are operated between Middleburg and Raleigh. South of Raleigh, CSX Transportation operates as far as Fetner with a daily through freight round trip to Hamlet, NC and local service to Apex.

Norfolk Southern operates the North Carolina Railroad under a contract with the State. NS operates limited through freight and local service between

Boylan and Greensboro, and an extensive array of freight services between Greensboro and Charlotte.

Amtrak maintains operating agreements with NS and CSXT to operate its trains between Richmond and Charlotte. The major points of these agreements are highlighted below. Amtrak's agreement with CSXT does not cover operation between Main Street Station and Centralia. Prior to initiation of service between Main Street Station and Raleigh, N.C. the agreement between Amtrak and CSXT will have to be modified.

NORTH CAROLINA RAILROAD / NORFOLK SOUTHERN RAILWAY

Virtually all of the outstanding stock in the North Carolina Railroad is owned by the State of North Carolina. For over a century, the railroad has been operated by Norfolk Southern and its predecessors. The current agreement was made effective January 1, 2000. NCRR grants NS the "exclusive freight trackage rights over the lines and properties of NCRR". It is noted that "The rights granted to [NS] do not eliminate, modify or diminish the rights of CSX Transportation to operate and serve customers between Fetner and Raleigh (Boylan)." (See a discussion of the agreement with CSXT concerning Raleigh to Cary, below.)

The agreement provides for passenger operations with speeds up to 90 mph on a "shared-use basis", that is, passenger and freight trains sharing the same tracks. Liability provisions currently in effect will apply. Provisions for increasing capacity, including double track between Greensboro and Charlotte are provided.

Separate tracks would be required to operate passenger trains at 90 mph and above, and the trains must be "...operated on a dedicated separate new infrastructure". High-Speed passenger operations "...will not be undertaken ... in close proximity to the tracks on which NSR has trackage right, unless an appropriate type and level of liability, indemnity and insurance protection ... has been implemented". The definition of "close proximity" is left to future negotiations and a "dispute resolution process." [The restriction is not in conformance with 49 CFR Part 213 Section 307 (a), which authorizes freight and passenger service on the same tracks at speeds up to 150 mph.]

There are a number of provisions to provide for the study of increased freight and passenger services, commuter services, higher speed services, and alternative routes, and industrial development.

The term of the agreement is 15 years, through December 31, 2014, with an option for NSR to extend for two additional 15-year terms.

OPERATIONS BETWEEN RALEIGH AND CARY

Joint operations between Boylan (Raleigh) and Fetner (Cary) are defined by an agreement between the predecessor railroads signed in 1862. At that time, the North Carolina Railroad permitted The Chatham Railroad Company to "...continue their road across the said North Carolina Railroad, at or near Cary, and thence down and along the Northern side of the North Carolina Railroad and upon the land heretofore set apart for the same such point for the depot at

Raleigh....” The agreement further stated that “The intent and meaning of this covenant is that Whenever [sic] the two tracks shall be finished, each company shall control its own, as if the other was miles away, and if for the mutual convenience they be worked together as a common double track....”

Current operations reflect this arrangement. The NCR owns the right of way and the south track, and CSXT owns the north track. By agreement, NS, the operator of the NCR maintains the south track, and CSX Transportation maintains the north track. Both tracks are dispatched by CSX Transportation, which reflects the greater level of traffic that the Seaboard Airline once operated. Before the SCL merger, it ran many more trains than did the Southern.

STATE OF NORTH CAROLINA/CSX TRANSPORTATION

There is a 1997 Memorandum of Understanding between the two parties that recognizes the state’s interest in procuring CSXT lines, including the S Line from the Virginia state line to Fetner (Cary), via Raleigh. The parties agree to negotiate ways to operate freight and passenger services, and upgrade and maintain the lines.

There is no current information as to the status of this memorandum, or any subsequent agreement.

AMTRAK AGREEMENTS

CSX TRANSPORTATION Agreement effective June 1, 1999

Section

3.1 Rights of Services

“CSXT agrees to provide Amtrak with the use of facilities and services.... for.... Intercity Rail Passenger Service, including carrying of mail and express on Intercity Rail Passenger Trains to the extent authorized by the Act.” Includes the right to modify or increase services, and the obligation to provide emergency services.

3.2A Modification of Services

“Amtrak shall have the right ...to request, and ...CSXT hereby agrees to provide modified or additional services.... The services requested shall be subject to the physical limitations of CSXT and shall give due regard to ...the avoidance of unreasonable interference with the adequacy, safety, and efficiency of its other railroad operations.”

4.1 Rail Lines

“CSXT shall retain and not.... abandon its Rail Lines used in the operation of regular Amtrak Trains.... without Amtrak’s prior written approval....”

4.2 Rail Lines

“Rail Lines” used by Amtrak “shall be maintained by CSXT at the level of utility existing on June 1, 1999”, so that the same schedules can be “operated with a reasonable degree of regularity and with a reasonable degree of passenger comfort.

4.3 Additional Maintenance and Improvements.

Level of utility can be increased at Amtrak's expense. CSXT can be required to make the improvements necessary.

5.1 Basis of Payment.

Amtrak pays various avoidable unit costs specified (Appendix IV), plus performance payments (Appendix V).

5.1.D Payment Adjustment.

Subsection 3.

"Amtrak may notify CSXT that it no longer desires ... specific services, activities, or facilities...."

7.2 Risk of Liability.

"Amtrak agrees to indemnify and save harmless CSXT, irrespective of any negligence or fault of CSXT, its employees, [etc.] from any and all liability for " injuries to, or death of, and loss, damage, or destruction of property of any Amtrak employee, any passenger or person meeting a passenger, any Amtrak equipment, or any vehicle or person struck at a grade crossing or by a derailed passenger train. CSXT agrees to indemnify and save harmless Amtrak for any liability for injury, death to any CSXT employee, or damage or destruction to any CSXT property.

8.8 Term.

Remains in effect "... through May 31, 2004, and thereafter until terminated by 12 months written notice to either party. Such notice may be given at any time after May 31, 2003"

NORFOLK SOUTHERN

January 2, 1979 agreement, as amended, effective June 1, 1999.

Section

3.1 Right to Services.

"...NS ...agrees to provide Amtrak ...with the services requested.... for.... operation of the Crescent and other routes and trains that may be agreed upon... including carrying of mail and express.

3.2A Modification of Services.

"Amtrak shall have the right ...to request, and ...NS hereby agrees to provide modified services The services requested ...shall be subject to the physical and financial capabilities of NS and shall give due regard to ...the avoidance of unreasonable interference with the adequacy, safety, and efficiency of other NS operations."

3.4 NS's Right to Cease Performing Services.

"NS may, on not less than two year's prior notice to Amtrak ...terminate its obligations to provide services to Amtrak"

3.7 Performance by Other Than NS.

"...Amtrak shall have the right to use NS's track, ...and to require NS to perform all services necessary, in connection with operation by Amtrak or others on its behalf, of Amtrak Intercity Rail Passenger Trains"

[3.4 and 3.7 appear to give Amtrak the right to employ its own crews to operate its trains over NS.]

4.1 Rail Lines.

“NS shall retain and not... abandon its Rail Lines used in the initial operation of Amtrak trains, for as long as such use continues....”

[This appears to only apply to the Washington, DC-Atlanta-New Orleans Crescent route.]

4.2 Maintenance of Rail Lines

“The Rail Lines of NS used in Amtrak’s Intercity Rail Passenger Service ...shall be maintained by NS at not less than the level of utility existing on the date of the beginning of such use.”

4.3 Additional Maintenance and Improvements.

Level of utility can be increased at Amtrak’s expense. NS can be required to make the improvements necessary.

5.1 Basis of Payment.

Amtrak pays various avoidable unit costs specified (Appendix IV), plus performance payments (Appendix V).

5.1.D Payment Adjustment.

Subsection 3.

Amtrak may terminate “services, activities, or facilities” provided by NS on 30 days’ written notice.

7.2 Risk of Liability

“Amtrak agrees to indemnify and save harmless NS, irrespective of any negligence or fault of NS, its employees, [etc.] from any and all liability for ” injuries to, or death of, and loss, damage, or destruction of property of any Amtrak employee, any passenger or person meeting a passenger, any Amtrak equipment, or any vehicle or person at a grade crossing. NS agrees to indemnify and save harmless Amtrak for any liability for injury, death to any NS employee, or damage or destruction to any NS property, in return for compensation of 7.34 cents per passenger train mile.

8.9 Term.

Remains in effect “... through April 30, 2003, and thereafter until either party gives at least six (6) months notice”

OWNERSHIP OF VARIOUS S LINE SEGMENTS

There are unofficial reports of scattered segments of the S Line having been sold off to various independent entities. Typically, they are sold in one-mile segments. The extent to which these sales have been made is not currently known, and would need further research. The reported sales include:

Location (Milepost)	Unofficially Reported Owner
12.5 to 14.5	Chesterfield County
25.9 to 26.6	Chaparral Steel
46.72 to 47.72	D. W. Lyle Corp.
50	Nottaway River Bridge (North) Farm (Hunting Preserve)
Quarry to 52.4	Quarry Access Road

**Technical Monograph:
Transportation Planning
for the Richmond–Charlotte Railroad Corridor**

January 2004

**Appendix F
Projected 2020 Schedules for Intercity Passenger,
Freight, and Commuter Trains**

**Federal Railroad Administration
United States Department of Transportation**

SEC Southbound Intercity Rail Passenger Timetable

		Type		Daily Amtrak South Florida1	Daily HSR South NC Local	Daily HSR South NC Local	Daily Amtrak South Bristol	Daily HSR South NC Local	Daily HSR South 6 stop	Daily Amtrak South NPN	Daily Amtrak South NSRoute	Daily HSR South RFP Local	Daily HSR South RFP Local	Daily HSR South NC Local	Daily HSR South RFP Local
DOWN Southbound		Direction		A85	NC01	NC03	BR1	NC05	NC07	A613	A001	3311	3351	NC09	A79
Milepost	Distance	Station													
0.000	0.000	Washington	Ar	10:00 PM						6:55 AM	7:01 AM				9:50 AM
0.000	0.000	Washington	Dp	10:15 PM					6:55 AM	7:10 AM	7:16 AM	8:10 AM	9:10 AM		10:05 AM
8.200	8.200	Alexandria	Ar	10:28 PM					7:08 AM	7:23 AM	7:33 AM	8:23 AM	9:23 AM		10:18 AM
8.200	8.200	Alexandria	Dp	10:30 PM					7:10 AM	7:25 AM	7:35 AM	8:25 AM	9:25 AM		10:20 AM
21.400	21.400	Lorton	Dp												
34.400	34.400	Quantico	Dp							7:50 AM		8:50 AM	9:50 AM		10:45 AM
53.899	53.899	Fredericksburg	Ar						7:48 AM	8:07 AM		9:13 AM	10:13 AM		11:02 AM
53.899	53.899	Fredericksburg	Dp						7:50 AM	8:09 AM		9:15 AM	10:15 AM		11:04 AM
108.800	108.800	Staples Mill	Ar	12:08 AM					8:33 AM	9:03 AM		10:09 AM	11:09 AM		11:58 AM
108.800	108.800	Staples Mill	Dp	12:10 AM					8:35 AM	9:05 AM		10:05 AM	11:05 AM		12:00 PM
116.410	116.410	Richmond-Main St	Ar	12:30 AM					8:50 AM	9:25 AM		10:25 AM	11:25 AM		12:20 PM
0.000	116.410	Richmond-Main St	Dp	12:32 AM			7:45 AM		8:52 AM	9:27 AM					
0.600	117.010	Rocketts	By				7:50 AM								
		Newport News	Ar							10:57 AM					
11.000	127.410	Centralia	By	12:42 AM					9:03 AM						
22.356	138.766	Petersburg	Ar						9:12 AM						
22.356	138.766	Petersburg	Dp						9:13 AM						
		Norfolk	Ar												
113.393	229.803	Henderson	Ar						10:19 AM						
113.393	229.803	Henderson	Dp						10:20 AM						
156.788	273.198	Raleigh	Ar						10:54 AM						
156.788	273.198	Raleigh	Dp		6:00 AM	7:00 AM		9:00 AM	10:57 AM					1:00 PM	
156.788	273.198	Fetner	By		6:06 AM	7:06 AM		9:06 AM	11:03 AM					1:06 PM	
165.300	281.710	Cary	Ar		6:07 AM	7:07 AM		9:07 AM						1:07 PM	
165.300	281.710	Cary	Dp		6:08 AM	7:08 AM		9:08 AM						1:08 PM	
182.265	298.675	Durham	Ar		6:22 AM	7:22 AM		9:22 AM	11:18 AM					1:22 PM	
182.265	298.675	Durham	Dp		6:23 AM	7:23 AM		9:23 AM	11:19 AM					1:23 PM	
216.500	332.910	Burlington	Ar		6:51 AM	7:51 AM		9:51 AM						1:51 PM	
216.500	332.910	Burlington	Dp		6:52 AM	7:52 AM		9:52 AM						1:52 PM	
236.833	353.243	Greensboro	Ar		7:08 AM	8:08 AM		10:08 AM	12:03 PM		1:03 PM			2:08 PM	
236.833	353.243	Greensboro	Dp		7:10 AM	8:10 AM		10:10 AM	12:05 PM		1:05 PM			2:10 PM	
253.310	369.720	Highpoint	Ar		7:23 AM	8:23 AM		10:23 AM						2:23 PM	
253.310	369.720	Highpoint	Dp		7:24 AM	8:24 AM		10:24 AM						2:24 PM	
287.722	404.132	Salisbury	Ar		7:49 AM	8:49 AM		10:49 AM			1:48 PM			2:49 PM	
287.722	404.132	Salisbury	Dp		7:50 AM	8:50 AM		10:50 AM			1:50 PM			2:50 PM	
303.050	419.460	Kannapolis	Ar		8:02 AM	9:02 AM		11:02 AM						3:02 PM	
303.050	419.460	Kannapolis	Dp		8:03 AM	9:03 AM		11:03 AM						3:03 PM	
319.876	436.286	I-485	Ar		8:18 AM	9:18 AM		11:18 AM	1:05 PM					3:18 PM	
319.876	436.286	I-485	Dp		8:19 AM	9:19 AM		11:19 AM	1:06 PM					3:19 PM	
331.850	448.260	Charlotte	Ar		8:30 AM	9:30 AM		11:30 AM	1:17 PM		2:33 PM			3:30 PM	
331.850	448.260	Charlotte	Dp		8:30 AM	9:30 AM		11:30 AM	1:17 PM		2:35 PM			3:30 PM	

SEC Southbound Intercity Rail Passenger Timetable

Daily HSR South 5 stop	Daily Amtrak South Florida3	Daily HSR South NC Local	Daily Amtrak South SilverStar	Daily Amtrak South Bristol	Daily HSR South 6 stop	Daily HSR South RFP Local	Daily Amtrak South NPN	Daily Amtrak South RFP Local	Daily Amtrak South AutoTrain	Daily HSR South NPN	Daily HSR South 5 stop	Daily Amtrak South NSRoute	Daily HSR South RFP Local	Daily Amtrak South Florida2
NC11	A89	NC13	A81	BR2	NC15	A405	A605	A153	A053	A609	NC17	A019	A611	A83
10:40 AM	11:05 AM		12:59 PM		1:45 PM	2:15 PM	3:24 PM	4:21 PM		5:24 PM	5:45 PM	5:50 PM	6:24 PM	6:54 PM
10:55 AM	11:20 AM		1:14 PM		2:00 PM	2:30 PM	3:39 PM	4:36 PM		5:39 PM	6:00 PM	6:05 PM	6:39 PM	7:09 PM
11:08 AM	11:33 AM		1:27 PM		2:13 PM	2:43 PM	3:52 PM	4:49 PM		5:52 PM	6:13 PM	6:18 PM	6:52 PM	7:22 PM
11:10 AM	11:35 AM		1:29 PM		2:15 PM	2:45 PM	3:54 PM	4:51 PM		5:54 PM	6:15 PM	6:20 PM	6:54 PM	7:24 PM
	12:00 PM								4:15 PM					
11:48 AM	12:17 PM		2:07 PM		2:53 PM	3:33 PM	4:36 PM	5:33 PM		6:19 PM			7:19 PM	
11:50 AM	12:19 PM		2:09 PM		2:55 PM	3:35 PM	4:38 PM	5:35 PM		6:36 PM	6:53 PM		7:36 PM	8:02 PM
12:33 PM	1:13 PM		2:52 PM		3:38 PM	4:23 PM	5:32 PM	6:29 PM		6:38 PM	6:55 PM		7:38 PM	8:04 PM
12:35 PM	1:15 PM		2:54 PM		3:40 PM	4:25 PM	5:34 PM	6:31 PM	6:15 PM	7:32 PM	7:38 PM		8:26 PM	8:52 PM
12:50 PM	1:35 PM		3:09 PM		3:55 PM	4:45 PM	5:54 PM	6:51 PM		7:34 PM	7:40 PM		8:28 PM	8:54 PM
12:52 PM	1:37 PM		3:11 PM	3:30 PM	3:57 PM		5:56 PM			7:54 PM	7:55 PM		8:48 PM	9:14 PM
				3:35 PM						7:56 PM	7:57 PM			9:16 PM
							7:26 PM			9:26 PM				
1:03 PM	1:47 PM		3:24 PM		4:08 PM						8:08 PM			9:26 PM
1:12 PM			3:35 PM		4:17 PM						8:17 PM			
1:13 PM			3:36 PM		4:18 PM						8:18 PM			
					5:24 PM									
					5:25 PM									
					5:59 PM						9:57 PM			
2:52 PM			5:31 PM		6:02 PM						10:00 PM			
2:55 PM		5:00 PM	5:33 PM		6:08 PM						10:06 PM			
3:01 PM		5:06 PM	5:40 PM											
		5:07 PM												
		5:08 PM												
3:16 PM		5:22 PM			6:23 PM						10:21 PM			
3:17 PM		5:23 PM			6:24 PM						10:22 PM			
		5:51 PM												
		5:52 PM												
4:00 PM		6:08 PM			7:08 PM						11:05 PM	12:13 AM		
4:02 PM		6:10 PM			7:10 PM						11:07 PM	12:15 AM		
		6:23 PM												
		6:24 PM												
		6:49 PM												
		6:50 PM												
		7:02 PM												
		7:03 PM												
5:03 PM		7:18 PM			8:10 PM						12:08 AM			
5:04 PM		7:19 PM			8:11 PM						12:09 AM			
5:15 PM		7:30 PM			8:22 PM						12:20 AM	1:43 AM		
5:15 PM		7:30 PM			8:22 PM						12:20 AM	1:45 AM		

SEC Northbound Intercity Rail Passenger Timetable

DOWN Northbound		Type	Daily Amtrak North Florida1	Daily Amtrak North Florida3	Daily Amtrak North NS Route	Daily Amtrak North RFP Local	Daily Amtrak North AutoTrain	Daily Amtrak North RFP Local	Daily Amtrak North SilverStar	Daily HSR North RFP Local	Daily HSR North NPN	Daily HSR North 5 stop	Daily HSR North NC Local	Daily HSR North RFP Local	Daily Amtrak North Florida1	Daily HSR North RFP Local
Milepost	Distance	Station	A82	A84	A020	3318	A052	A602	A80	A128	A604	NC02	NC04	A156	A86	3332
331.850	0.000	Charlotte	Ar		12:53 AM							6:00 AM	8:00 AM			
331.850	0.000	Charlotte	Dp		12:55 AM							6:00 AM	8:00 AM			
319.876	11.974	I-485	Ar									6:10 AM	8:10 AM			
319.876	11.974	I-485	Dp									6:11 AM	8:11 AM			
303.050	28.800	Kannapolis	Ar										8:25 AM			
303.050	28.800	Kannapolis	Dp										8:26 AM			
287.722	44.128	Salisbury	Ar		1:40 AM								8:39 AM			
287.722	44.128	Salisbury	Dp		1:42 AM								8:40 AM			
253.310	78.540	Highpoint	Ar										9:04 AM			
253.310	78.540	Highpoint	Dp										9:05 AM			
236.833	95.017	Greensboro	Ar		2:23 AM							7:11 AM	9:18 AM			
236.833	95.017	Greensboro	Dp		2:25 AM							7:13 AM	9:20 AM			
216.500	115.350	Burlington	Ar										9:36 AM			
216.500	115.350	Burlington	Dp										9:37 AM			
182.265	149.585	Durham	Ar									7:57 AM	10:05 AM			
182.265	149.585	Durham	Dp									7:58 AM	10:06 AM			
165.300	166.550	Cary	Ar										10:21 AM			
165.300	166.550	Cary	Dp										10:22 AM			
164.900	166.950	Fetner	By					5:30 AM				8:13 AM	10:22 AM			
156.788	175.062	Raleigh	Ar					5:38 AM				8:20 AM	10:30 AM			
156.788	175.062	Raleigh	Dp					5:40 AM				8:23 AM				
113.393	218.457	Henderson	Ar													
113.393	218.457	Henderson	Dp													
		Norfolk	Dp													
22.356	309.494	Petersburg	Ar						7:34 AM			10:01 AM				
22.356	309.494	Petersburg	Dp						7:35 AM			10:02 AM				
11.000	320.850	Centralia	By	3:10 AM	5:00 AM				7:45 AM			10:10 AM			12:00 PM	
		Newport News	Dp								7:53 AM					
		Rocketts	By													
0.000	331.850	Richmond-Main St	Ar	3:23 AM	5:13 AM				8:00 AM			9:23 AM	10:23 AM			12:13 PM
116.410	331.850	Richmond-Main St	Dp	3:25 AM	5:15 AM	6:15 AM		7:30 AM	8:02 AM	8:15 AM	9:25 AM	10:25 AM		11:00 AM	12:15 PM	1:00 PM
108.800	339.460	Staples Mill	Ar	3:43 AM	5:33 AM	6:33 AM	6:55 AM	7:48 AM	8:17 AM	8:33 AM	9:43 AM	10:40 AM		11:18 AM	12:33 PM	1:18 PM
108.800	339.460	Staples Mill	Dp	3:45 AM	5:35 AM	6:35 AM		7:50 AM	8:19 AM	8:35 AM	9:45 AM	10:42 AM		11:20 AM	12:35 PM	1:20 PM
53.899	394.361	Fredericksburg	Ar		6:23 AM	7:23 AM		8:38 AM	9:02 AM	9:23 AM	10:33 AM	11:25 AM		12:08 PM	12:35 PM	2:08 PM
53.899	394.361	Fredericksburg	Dp		6:25 AM	7:30 AM		8:40 AM	9:04 AM	9:25 AM	10:35 AM	11:27 AM		12:10 PM	12:35 PM	2:10 PM
34.400	413.860	Quantico	Dp		6:45 AM			9:00 AM			10:55 AM					
21.400	426.860	Lorton	Ar				8:45 AM									
8.200	440.060	Alexandria	Ar		7:08 AM	7:55 AM	8:25 AM	9:23 AM	9:42 AM	10:08 AM	11:18 AM	12:05 PM		12:33 PM	12:35 PM	2:58 PM
8.200	440.060	Alexandria	Dp		7:10 AM	7:57 AM	8:30 AM	9:25 AM	9:44 AM	10:10 AM	11:20 AM	12:07 PM		12:35 PM	12:35 PM	3:00 PM
0.000	448.260	Washington	Ar	5:35 AM	7:25 AM	8:10 AM	8:45 AM	9:40 AM	9:57 AM	10:25 AM	11:35 AM	12:20 PM		12:50 PM	2:25 PM	3:15 PM
0.000	448.260	Washington	Dp	5:50 AM	7:40 AM	8:25 AM		9:55 AM	10:12 AM	10:40 AM	11:50 AM	12:35 PM		1:05 PM	2:40 PM	3:30 PM

SEC Northbound Intercity Rail Passenger Timetable

Daily Amtrak North Bristol	smtwtfs seconds 86400	Daily HSR North 6 stop	Daily HSR North NPN	Daily Amtrak North NS Route	Daily HSR North NC Local	Daily HSR North RFP Local	Daily Amtrak North Florida2	Daily HSR North RFP Local	Daily HSR North 5 stop	Daily HSR North NC Local	Daily Amtrak North NPN	Daily HSR North 6 stop	Daily Amtrak North Bristol	Daily HSR North NC Local	Daily HSR North NC Local
BR2	BR2	NC06	A612	A002	NC08	A080	A090	3348	NC10	NC12	A618	NC14	BR1	NC16	NC18
		10:00 AM		11:13 AM	12:00 PM				2:00 PM	4:00 PM		5:00 PM		7:00 PM	9:00 PM
		10:00 AM		11:15 AM	12:00 PM				2:00 PM	4:00 PM		5:00 PM		7:00 PM	9:00 PM
		10:10 AM			12:10 PM				2:10 PM	4:10 PM		5:10 PM		7:10 PM	9:10 PM
		10:11 AM			12:11 PM				2:11 PM	4:11 PM		5:11 PM		7:11 PM	9:11 PM
					12:25 PM					4:25 PM				7:25 PM	9:25 PM
					12:26 PM					4:26 PM				7:26 PM	9:26 PM
				12:00 PM	12:39 PM					4:39 PM				7:39 PM	9:39 PM
				12:02 PM	12:40 PM					4:40 PM				7:40 PM	9:40 PM
					1:04 PM					5:04 PM				8:04 PM	10:04 PM
					1:05 PM					5:05 PM				8:05 PM	10:05 PM
		11:11 AM		12:43 PM	1:18 PM				3:11 PM	5:18 PM		6:11 PM		8:18 PM	10:18 PM
		11:13 AM		12:45 PM	1:20 PM				3:13 PM	5:20 PM		6:13 PM		8:20 PM	10:20 PM
					1:36 PM					5:36 PM				8:36 PM	10:36 PM
					1:37 PM					5:37 PM				8:37 PM	10:37 PM
		11:57 AM			2:05 PM				3:57 PM	6:05 PM		6:57 PM		9:05 PM	11:05 PM
		11:58 AM			2:06 PM				3:58 PM	6:06 PM		6:58 PM		9:06 PM	11:06 PM
					2:21 PM					6:21 PM				9:21 PM	11:21 PM
					2:22 PM					6:22 PM				9:22 PM	11:22 PM
		12:13 PM			2:22 PM				4:13 PM	6:22 PM		7:13 PM		9:22 PM	11:22 PM
		12:20 PM			2:30 PM				4:20 PM	6:30 PM		7:20 PM		9:30 PM	11:30 PM
		12:23 PM							4:23 PM			7:23 PM			
		12:57 PM										7:57 PM			
		12:58 PM										7:58 PM			
		2:03 PM							6:01 PM			9:03 PM			
		2:04 PM							6:02 PM			9:04 PM			
		2:13 PM					4:45 PM		6:10 PM			9:13 PM			
			12:58 PM								6:23 PM				
1:50 PM													9:45 PM		
1:55 PM	300	2:25 PM	2:28 PM				4:58 PM	5:00 PM	6:23 PM		7:53 PM	9:25 PM	9:50 PM		
		2:27 PM	2:30 PM				4:00 PM	5:00 PM	6:25 PM		7:55 PM	9:27 PM			
		2:42 PM	2:48 PM				4:18 PM	5:18 PM	6:40 PM		8:13 PM	9:42 PM			
		2:44 PM	2:50 PM				4:20 PM	5:20 PM	6:42 PM		8:15 PM	9:44 PM			
		3:27 PM	3:38 PM				5:08 PM	6:13 PM	7:08 PM	7:25 PM	9:03 PM	10:27 PM			
		3:29 PM	3:40 PM				5:10 PM	6:15 PM	7:10 PM	7:27 PM	9:05 PM	10:29 PM			
			4:00 PM								9:25 PM				
		4:07 PM	4:23 PM	6:56 PM			5:58 PM	6:58 PM	7:53 PM	8:05 PM	9:48 PM	11:07 PM			
		4:09 PM	4:25 PM	6:58 PM			6:00 PM	7:00 PM	7:55 PM	8:07 PM	9:50 PM	11:09 PM			
		4:22 PM	4:40 PM	7:15 PM			6:15 PM	7:15 PM	8:10 PM	8:20 PM	10:05 PM	11:22 PM			
		4:37 PM	4:55 PM				6:30 PM	7:30 PM		8:35 PM	10:20 PM				

SEC Southbound Freight Timetable

DOWN Southbound		Type	Daily Local South Linwood S	Daily Freight South Linwood S	Daily Intermodal South Elm S	Daily Freight South Linwood S	Daily Freight South Elm S	Daily Local South Linwood S	Daily Freight South Elm S	Daily Intermodal South Elm S	Daily Freight South Linwood S	Daily Freight South Linwood S	Daily Intermodal South Elm S	Daily Freight South Elm S	Daily Intermodal South Elm S	Daily Freight South Linwood S	Daily Freight South Linwood S	Daily Freight South Linwood S
GROWTH TRAINS		Direction Pattern	LCL2	LCL4	NJAT	LIAT	BHAT	LCL3	COAL	ERAT	LICH	LICA	IPAT	BVLI	BANO	LISH	LISV	LIBI
Milepost	Distance	Station																
0.000	0.000	Richmond-Main St Ar																
0.000	0.000	Richmond-Main St Dp																
11.000	11.000	A-Line By																
0.600	0.600	Rocketts By																
1.600	1.600	Deepwater Jct By																
5.000	5.000	Fanshaw By																
8.000	8.000	Bellwood By																
11.000	11.000	Centralia By																
22.356	22.356	Petersburg Ar																
22.356	22.356	Petersburg Dp																
98.500	98.500	Norlina Ar																
98.500	98.500	Norlina Dp																
136.000	136.000	Youngsville Siding Ar																
136.000	136.000	Youngsville Siding Dp																
156.400	156.400	Southern Jct Ar																
156.400	156.400	Southern Jct Dp																
157.400	157.400	Raleigh Ar																
80.600	157.400	Raleigh Dp																
73.000	165.000	Fetner Ar																
73.000	165.000	Fetner Dp																
58.000	180.000	Durham Yard Ar																
58.000	180.000	Durham Yard Dp																
21.000	217.000	Burlington Ar																
21.000	217.000	Burlington Dp																
0.000	238.000	Greensboro-Elm Ar			2:30 AM		1:30 AM		5:30 AM	8:00 AM			9:30 AM	10:30 AM	11:00 AM			
283.900	238.000	Greensboro-Elm Dp			2:30 AM		1:30 AM		5:30 AM	8:00 AM			9:30 AM	10:30 AM	11:00 AM			
286.000	240.100	Pomona Yard Ar			2:40 AM								9:40 AM	10:40 AM	11:15 AM			
286.000	240.100	Pomona Yard Dp			3:40 AM								10:40 AM	11:20 AM	11:45 AM			
300.500	254.600	Highpoint Ar																
300.500	254.600	Highpoint Dp																
305.500	259.600	Thomasville Ar																
305.500	259.600	Thomasville Dp																
317.000	271.100	Lexington Ar																
317.000	271.100	Lexington Dp																
325.000	279.100	Linwood Yard Ar	3:00 AM	4:30 AM	4:40 AM	5:00 AM	2:45 AM	7:00 AM	7:30 AM	9:00 AM	10:30 AM	11:00 AM	11:40 AM	1:20 PM	1:15 PM	2:45 PM	2:30 PM	5:00 PM
325.000	279.100	Linwood Yard Dp	3:00 AM	4:30 AM	4:40 AM	5:00 AM	6:45 AM	7:00 AM	8:30 AM	9:00 AM	10:30 AM	11:00 AM	11:40 AM		1:15 PM	2:45 PM	2:30 PM	5:00 PM
332.000	286.100	Salisbury Ar	3:45 AM	5:00 AM				7:45 AM				11:30 AM						
332.000	286.100	Salisbury Dp		5:00 AM														
349.000	303.100	Kannapolis Ar		6:15 AM														
349.000	303.100	Kannapolis Dp		6:45 AM														
352.800	306.900	Adams Ar																
352.800	306.900	Adams Dp																
376.000	330.100	Charlotte Ar		8:30 AM	6:00 AM	7:00 AM	8:15 AM			10:30 AM	12:10 PM		2:00 PM		3:00 PM		4:10 PM	6:40 PM
376.000	330.100	Charlotte Dp			7:00 AM	8:00 AM	8:15 AM			10:40 AM	12:55 PM		3:00 PM		3:30 PM		4:55 PM	7:10 PM
381.000	335.100	Charlotte Jct Ar			7:15 AM	8:15 AM	9:15 AM		10:00 AM	10:55 AM	1:10 PM		3:15 PM		3:45 PM	4:30 PM	5:10 PM	7:20 PM
381.000	335.100	Charlotte Jct Dp			7:15 AM	8:15 AM	9:15 AM		10:00 AM	10:55 AM	1:10 PM		3:15 PM		3:45 PM	4:30 PM	5:10 PM	7:20 PM

Running Time

0:45	4:00	4:45	3:15	7:45	0:45	4:30	2:55	2:40	0:30	5:45	2:50	4:45	1:45	2:40	2:20
------	------	------	------	------	------	------	------	------	------	------	------	------	------	------	------

- Linwood-Salisbury Turn
- Linwood-Charlotte Turn
- Croxton-Atlanta Intermodal
- Linwood-Atlanta
- Binghamton (DH)-Atlanta
- Linwood-N-Line Turn
- Coal Loads
- E-Rail-Atlanta RoadRailer
- Linwood-Charleston
- Linwood-Chattanooga
- Inland Port-Atlanta Intermodal
- Bellevue-Linwood
- Baltimore-New Orleans Intermodal
- Linwood-Sheffield
- Linwood-Savannah
- Linwood-Birmingham

SEC Southbound Freight Timetable

DOWN Southbound		Type	Daily Freight South Raleigh S	Daily Local South Raleigh S	Daily RoadRailer South Elm S	Daily Freight South Linwood S	Daily Intermodal South Elm S	Daily Intermodal South Elm S	Daily Freight South Raleigh S	Daily Freight South Linwood S	Daily Freight South Raleigh S	Daily Local South Raleigh S	Daily Freight South Elm S	Daily Freight South Elm S	Daily Freight South Elm S	Daily Freight South Elm S	Daily Freight South CSXT	Daily Freight South CSXT
GROWTH TRAINS		Direction	NSLI	LCL1	RRAT	LIMA	CXAT	WAAT	RAWS	LIKX	RALI	LCL6	HALI	NFLI	OILI	WALI	CSX1	CSX3
Milepost	Distance	Station	Ar	By	Ar	Dp	Ar	By	Ar	Dp	Ar	By	Ar	Dp	Ar	Dp	Ar	Dp
0.000	0.000	Richmond-Main St	Ar															
0.000	0.000	Richmond-Main St	Dp															
11.000	11.000	A-Line		By													4:30 AM	8:30 AM
0.600	0.600	Rocketts	By															
1.600	1.600	Deepwater Jct	By															
5.000	5.000	Fanshaw	By															
8.000	8.000	Bellwood	By															
11.000	11.000	Centralia	By															
22.356	22.356	Petersburg	Ar															
22.356	22.356	Petersburg	Dp															
98.500	98.500	Norlina	Ar															
98.500	98.500	Norlina	Dp															
136.000	136.000	Youngsville Siding	Ar															
136.000	136.000	Youngsville Siding	Dp															
156.400	156.400	Southern Jct	Ar															
156.400	156.400	Southern Jct	Dp															
157.400	157.400	Raleigh	Ar						5:00 PM									
80.600	157.400	Raleigh	Dp						5:00 PM									
73.000	165.000	Fetner	Ar															
73.000	165.000	Fetner	Dp															
58.000	180.000	Durham Yard	Ar						6:10 PM									
58.000	180.000	Durham Yard	Dp						6:25 PM									
21.000	217.000	Burlington	Ar															
21.000	217.000	Burlington	Dp															
0.000	238.000	Greensboro-Elm	Ar		6:00 PM			6:25 PM	6:45 PM				7:20 PM	11:30 PM	12:01 AM	12:50 AM		
283.900	238.000	Greensboro-Elm	Dp		6:00 PM			6:25 PM	6:45 PM				7:20 PM	11:30 PM	12:01 AM	12:50 AM		
286.000	240.100	Pomona Yard	Ar	3:15 PM	2:00 PM				6:55 PM	8:00 PM		2:15 AM	9:00 AM	7:30 PM	12:15 AM	1:00 AM		
286.000	240.100	Pomona Yard	Dp	3:45 PM	2:00 PM				7:35 PM	8:40 PM		3:00 AM		8:15 PM	12:45 AM	2:00 AM		
300.500	254.600	Highpoint	Ar	4:30 PM	3:00 PM													
300.500	254.600	Highpoint	Dp	5:00 PM	4:30 PM													
305.500	259.600	Thomasville	Ar	5:45 PM	4:45 PM													
305.500	259.600	Thomasville	Dp	6:15 PM	5:45 PM													
317.000	271.100	Lexington	Ar	7:00 PM	6:00 PM													
317.000	271.100	Lexington	Dp	7:30 PM	6:45 PM													
325.000	279.100	Linwood Yard	Ar	6:15 PM	7:45 PM	6:50 PM	7:00 PM	7:45 PM	9:00 PM		11:00 PM		9:30 PM	1:00 AM	2:15 AM	4:15 AM		
325.000	279.100	Linwood Yard	Dp			6:50 PM	7:00 PM	7:45 PM	9:00 PM		11:00 PM							
332.000	286.100	Salisbury	Ar															
332.000	286.100	Salisbury	Dp															
349.000	303.100	Kannapolis	Ar															
349.000	303.100	Kannapolis	Dp															
352.800	306.900	Adams	Ar															
352.800	306.900	Adams	Dp															
376.000	330.100	Charlotte	Ar			7:50 PM		9:25 PM	10:50 PM									
376.000	330.100	Charlotte	Dp			8:20 PM		9:35 PM	11:30 PM									
381.000	335.100	Charlotte Jct	Ar			8:30 PM	8:40 PM	9:45 PM	11:45 PM									
381.000	335.100	Charlotte Jct	Dp			8:30 PM	8:40 PM	9:45 PM	11:45 PM									

Running Time

7:15	5:45	2:30	1:40	3:20	5:00	3:40	0:30	5:15	9:30	2:10	1:30	2:14	3:25	4:00	4:00
------	------	------	------	------	------	------	------	------	------	------	------	------	------	------	------

Chocowinity-Linwood

Linwood-Pomona Turn

E-Rail-Atlanta RoadRailer

Linwood-Macon

Croton-Atlanta Intermodal

Alexandria-Atlanta Intermodal

Raleigh-Roanoke

Linwood-Knoxville

Raleigh-Linwood

Raleigh-Pomona Local

Hagerstown-Linwood

Norfolk-Linwood

Oak Island-Linwood

Alexandria-Linwood

SEC Southbound Freight Timetable

DOWN <small>Southbound</small>		Type	Daily Local South CSXT	Daily Local South CSXT	Daily Freight South CSXT	Daily Freight South CSXT	Daily Freight South CSXT	Daily Local South CSXT	Daily Local South CSXT	Daily Freight South Ral S	Daily Freight South Ral S
GROWTH TRAINS		Direction Pattern	DEEP	F735	CSX5	CSX7	ACHA	F769	F723	F742	F711
Milepost	Distance	Station									
0.000	0.000	Richmond-Main St	Ar								
0.000	0.000	Richmond-Main St	Dp								
11.000	11.000	A-Line	By		2:30 PM	6:30 PM	7:00 PM				
0.600	0.600	Rocketts	By	10:00 AM							
1.600	1.600	Deepwater Jct	By	1:00 PM							
5.000	5.000	Fanshaw	By						4:00 PM		
8.000	8.000	Bellwood	By					4:00 PM			
11.000	11.000	Centralia	By					4:10 PM	4:30 PM		
22.356	22.356	Petersburg	Ar								
22.356	22.356	Petersburg	Dp								
98.500	98.500	Norlina	Ar		2:00 PM						
98.500	98.500	Norlina	Dp		2:00 PM						
136.000	136.000	Youngsville Siding	Ar								4:00 AM
136.000	136.000	Youngsville Siding	Dp								4:00 AM
156.400	156.400	Southern Jct	Ar				10:00 PM			7:30 PM	5:00 AM
156.400	156.400	Southern Jct	Dp				10:30 PM			7:30 PM	6:00 AM
157.400	157.400	Raleigh	Ar								
80.600	157.400	Raleigh	Dp								
73.000	165.000	Fetner	Ar		5:30 PM	6:30 PM	10:30 PM	2:30 AM		8:00 PM	6:30 AM
73.000	165.000	Fetner	Dp								
58.000	180.000	Durham Yard	Ar								
58.000	180.000	Durham Yard	Dp								
21.000	217.000	Burlington	Ar								
21.000	217.000	Burlington	Dp								
0.000	238.000	Greensboro-Elm	Ar								
283.900	238.000	Greensboro-Elm	Dp								
286.000	240.100	Pomona Yard	Ar								
286.000	240.100	Pomona Yard	Dp								
300.500	254.600	Highpoint	Ar								
300.500	254.600	Highpoint	Dp								
305.500	259.600	Thomasville	Ar								
305.500	259.600	Thomasville	Dp								
317.000	271.100	Lexington	Ar								
317.000	271.100	Lexington	Dp								
325.000	279.100	Linwood Yard	Ar								
325.000	279.100	Linwood Yard	Dp								
332.000	286.100	Salisbury	Ar								
332.000	286.100	Salisbury	Dp								
349.000	303.100	Kannapolis	Ar								
349.000	303.100	Kannapolis	Dp								
352.800	306.900	Adams	Ar								
352.800	306.900	Adams	Dp								
376.000	330.100	Charlotte	Ar								
376.000	330.100	Charlotte	Dp								
381.000	335.100	Charlotte Jct	Ar								
381.000	335.100	Charlotte Jct	Dp								

Running Time

3:10	3:30	4:00	4:00	7:30	0:10	0:30	0:30	
------	------	------	------	------	------	------	------	--

Deepwater Switcher

Raleigh-Norlina Turn

Collier-Bellwood Turn

Collier-Fanshaw Turn

Raleigh-Hamlet Turn

Raleigh-Wake Forest-Apex Turn

SEC Northbound Freight Timetable

DOWN GROWTH TRAINS	Milepost	Distance	Station	Type Direction Pattern	Daily Local North	Daily Local North	Daily Intermodal North	Daily Local North	Daily Freight North	Daily Local North	Daily Freight North	Daily Freight North	Daily Intermodal North	Daily Intermodal North	Daily Freight North	Daily Local North	Daily Local North	Daily Intermodal North	Daily Freight North	Daily Intermodal North	Daily Freight North	
					N Linwood	N Linwood	NS Main	N Linwood	N Linwood	N Linwood	NS Main	N Linwood	NS Main	NS Main	N Linwood	N Linwood	N Linwood	NS Main	NS Main	N Linwood	N Linwood	N Linwood
					LCL3	KNLI	ATNJ	KXLI	SHLI	LCL1	ATDH	MALI	RRNJ	NOBA	BHLI	LCL2	LCL4	ATCX	EMTY	ATIP	CHLI	
	381.000	0.000	Charlotte Jct	Ar			2:50 AM		4:45 AM		5:00 AM	6:00 AM	7:00 AM	8:00 AM	8:00 AM			10:45 AM	12:00 PM	12:10 PM	12:15 PM	
	381.000	0.000	Charlotte Jct	Dp			2:50 AM		4:45 AM		5:00 AM	6:00 AM	7:00 AM	8:00 AM	8:00 AM			10:45 AM	12:00 PM	12:10 PM	12:15 PM	
	376.000	5.000	Charlotte	Ar			3:00 AM		5:00 AM				7:10 AM	8:15 AM	8:10 AM	10:00 AM		10:55 AM		12:20 PM	12:30 PM	
	376.000	5.000	Charlotte	Dp			3:30 AM		6:00 AM				8:10 AM	9:00 AM	8:35 AM	10:00 AM		11:40 AM		12:30 PM	1:10 PM	
	352.000	29.000	Adams	Ar																		
	352.000	29.000	Adams	Dp																		
	349.000	32.000	Kannapolis	Ar																		
	349.000	32.000	Kannapolis	Dp													11:30 AM					
	332.000	49.000	Salisbury	Ar	2:45 PM	1:30 AM		5:15 AM								9:30 AM						
	332.000	49.000	Salisbury	Dp	2:45 PM	1:30 AM		5:15 AM								9:30 AM						
	325.000	56.000	Linwood Yard	Ar	3:45 PM	2:00 AM	5:00 AM	5:45 AM	7:40 AM	5:00 AM	7:00 AM	8:00 AM	9:25 AM	10:30 AM	11:15 AM	10:00 AM	2:30 PM	1:00 PM	2:00 PM	1:45 PM	2:50 PM	
	325.000	56.000	Linwood Yard	Dp			5:00 AM				3:00 PM		9:25 AM	10:30 AM				1:00 PM	3:00 PM	1:45 PM		
	317.000	64.000	Lexington	Ar																		
	317.000	64.000	Lexington	Dp																		
	305.500	75.500	Thomasville	Ar																		
	305.500	75.500	Thomasville	Dp																		
	300.500	80.500	Highpoint	Ar																		
	300.500	80.500	Highpoint	Dp																		
	286.000	95.000	Pomona Yard	Ar																		
	286.000	95.000	Pomona Yard	Dp																		
	283.900	97.100	Greensboro-Elm	Ar			6:00 AM				4:30 PM											
	0.000	97.100	Greensboro-Elm	Dp			6:30 AM				4:30 PM											
	21.000	118.100	Burlington	Ar			6:40 AM															
	21.000	118.100	Burlington	Dp																		
	58.000	155.100	Durham Yard	Ar																		
	58.000	155.100	Durham Yard	Dp																		
	73.000	170.100	Fetner	Ar																		
	73.000	170.100	Fetner	Dp																		
	80.600	177.700	Raleigh	Ar																		
	157.400	177.700	Raleigh	Dp																		
	156.400	178.700	Southern Jct	Ar																		
	156.400	178.700	Southern Jct	Dp																		
	136.000	199.100	Youngsville Siding	Ar																		
	136.000	199.100	Youngsville Siding	Dp																		
	98.500	236.600	Norlina	Ar																		
	98.500	236.600	Norlina	Dp																		
	22.356	312.744	Petersburg	Ar																		
	22.356	312.744	Petersburg	Dp																		
	11.000	324.100	Centralia	By																		
	8.000	327.100	Bellwood	By																		
	5.000	330.100	Fanshaw	By																		
	1.600	333.500	Deepwater Jct	By																		
	0.600	334.500	Rocketts	By																		
	11.000	324.100	A-Line	By																		
	0.000	335.100	Richmond-Main St	Ar																		
	0.000	335.100	Richmond-Main St	Dp																		

Running Time	from LCL3 South										from LCL2 South									
	1:00	0:30	3:50	0:30	2:55	6:00	11:30	2:00	3:10	4:15	3:15	0:30	4:30	4:15	4:30	2:20	2:35			
	Linwood-N-Line Turn	Knoxville-Linwood	Atlanta-Croton Intermodal	Knoxville-Linwood	Sheffield-Linwood	Linwood-Pomona Turn	Atlanta-Binghamton (DH)	Macon-Linwood	Atlanta-E-Rail Road/Railer	New Orleans-Baltimore Intermodal	Birmingham-Linwood	Linwood-Salisbury Turn	Linwood-Charlotte Turn	Atlanta-Croton Intermodal	Coal Employs	Atlanta-Inland Port (VA) Intermodal	Charleston-Linwood			

SEC Northbound Freight Timetable

DOWN		Type	Daily	Daily	Daily	Daily	Daily	Daily	Daily	Daily	Daily	Daily	Daily	Daily	Daily	Daily	Daily	Daily	Daily	
GROWTH TRAINS		Direction	Intermodal	Freight	Intermodal	Freight	Local	Freight	Freight	Freight	Freight	Freight	Freight	Freight	Freight	Freight	Freight	Freight	Freight	
Milepost	Distance	Station	North	North	North	North	North	North	North	North	North	North	North	North	North	North	North	North	North	
			NS Main	N Linwood	NS Main	N Linwood	N Linwood	N Linwood	N Linwood	N Linwood	N Linwood	N Linwood	N Linwood	N Linwood	N Linwood	N Linwood	N Linwood	N CSX	N CSX	N CSX
			ATWA	SVLI	RRER	BILI	CALI	LIRA	LIOI	LINF	LINS	LIHA	WSRA	LIWA	LIBV	CSX2	F711	F742	CSX4	
381.000	0.000	Charlotte Jct	Ar	1:45 PM	6:50 PM	7:00 PM	9:10 PM													
381.000	0.000	Charlotte Jct	Dp	1:45 PM	6:50 PM	7:00 PM	9:10 PM													
376.000	5.000	Charlotte	Ar	1:50 PM	7:00 PM	7:10 PM	9:20 PM													
376.000	5.000	Charlotte	Dp	2:00 PM	7:30 PM	7:20 PM	9:50 PM													
352.000	29.000	Adams	Ar																	
352.000	29.000	Adams	Dp																	
349.000	32.000	Kannapolis	Ar																	
349.000	32.000	Kannapolis	Dp																	
332.000	49.000	Salisbury	Ar				10:30 PM													
332.000	49.000	Salisbury	Dp				10:30 PM													
325.000	56.000	Linwood Yard	Ar	3:15 PM	9:00 PM	8:50 PM	1:15 AM	11:00 PM	1:00 AM	3:00 AM	4:00 AM	9:30 AM	11:00 AM		4:30 PM	8:30 PM				
325.000	56.000	Linwood Yard	Dp	3:15 PM		8:50 PM			1:00 AM	3:00 AM	4:00 AM	9:30 AM	11:00 AM		4:30 PM	8:30 PM				
317.000	64.000	Lexington	Ar																	
317.000	64.000	Lexington	Dp																	
305.500	75.500	Thomasville	Ar																	
305.500	75.500	Thomasville	Dp																	
300.500	80.500	Highpoint	Ar							5:00 AM										
300.500	80.500	Highpoint	Dp							5:30 AM										
286.000	95.000	Pomona Yard	Ar						1:15 AM	5:00 AM	6:15 AM	11:00 AM	1:00 PM	10:15 AM		10:00 PM				
286.000	95.000	Pomona Yard	Dp	4:00 PM					1:15 AM	5:45 AM	7:00 AM	11:45 AM	2:00 PM	10:50 AM		11:00 PM				
283.900	97.100	Greensboro-Elm	Ar	4:45 PM		9:50 PM				6:00 AM	7:10 AM			6:10 PM						
0.000	97.100	Greensboro-Elm	Dp	5:00 PM		9:50 PM														
21.000	118.100	Burlington	Ar						2:00 AM											
21.000	118.100	Burlington	Dp						2:15 AM											
58.000	155.100	Durham Yard	Ar									1:20 PM		11:50 AM						
58.000	155.100	Durham Yard	Dp									1:50 PM		12:20 PM						
73.000	170.100	Fetner	Ar													12:30 AM	8:00 AM	6:00 AM	7:30 AM	
73.000	170.100	Fetner	Dp													12:30 AM	8:00 AM	6:00 AM	7:30 AM	
80.600	177.700	Raleigh	Ar						6:00 AM			3:00 PM		1:00 PM						
157.400	177.700	Raleigh	Dp																	
156.400	178.700	Southern Jct	Ar															1:30 AM	6:30 AM	
156.400	178.700	Southern Jct	Dp															1:30 AM		
136.000	199.100	Youngsville Siding	Ar															3:30 AM		
136.000	199.100	Youngsville Siding	Dp																	
98.500	236.600	Norlina	Ar																	
98.500	236.600	Norlina	Dp																	
22.356	312.744	Petersburg	Ar																	
22.356	312.744	Petersburg	Dp																	
11.000	324.100	Centralia	By																	
8.000	327.100	Bellwood	By																	
5.000	330.100	Fanshaw	By																	
1.600	333.500	Deepwater Jct	By																	
0.600	334.500	Rocketts	By																	
11.000	324.100	A-Line	By													4:30 AM				11:30 AM
0.000	335.100	Richmond-Main St	Ar																	
0.000	335.100	Richmond-Main St	Dp																	

Running Time	3:15	2:10	2:50	3:55	0:30	5:00	3:00	3:10	5:30	3:20	2:45	1:40	2:40	4:00			0:30	4:00
	Atlanta-Alexandria Intermodal	Savannah-Linwood	Atlanta-E-Rail Road/Railer	Birmingham-Hagerstown	Chattanooga-Linwood	Linwood-Raleigh	Linwood-Oak Island	Linwood-Norfolk	Linwood-Chocowinity	Birmingham-Hagerstown	Roanoke-Raleigh	Linwood-Alexandria	Linwood-Bellevue			Raleigh-Wake Forest-Apex Turn	Raleigh-Hamlet (re)Turn	

SEC Northbound Freight Timetable

DOWN Northbound		Type	Daily Freight North N CSX	Daily Freight North N CSX	Daily Freight North N CSX	Daily Freight North N CSX	Daily Freight North N CSX	Daily MtYCoal North N CSX	smtwfts seconds 86400	Daily Local North N CSX	Daily Freight North N CSX	Daily MtYCoal North N CSX	Daily Local North N CSX	Daily MtYCoal North N CSX	Daily Freight North N CSX	Daily MtYCoal North N CSX	Daily MtYCoal North N CSX	Daily MtYCoal North N CSX	
GROWTH TRAINS		Direction Pattern	F735	CSX6	HAAC	MANF	CSX8	MTY1	MTY1	F769	MIX1	MTY2	F723	MTY3	TRSH	MTY4	MTY6	MTY7	MTY8
Milepost	Distance	Station																	
381.000	0.000	Charlotte Jct	Ar																
381.000	0.000	Charlotte Jct	Dp																
376.000	5.000	Charlotte	Ar																
376.000	5.000	Charlotte	Dp																
352.000	29.000	Adams	Ar																
352.000	29.000	Adams	Dp																
349.000	32.000	Kannapolis	Ar																
349.000	32.000	Kannapolis	Dp																
332.000	49.000	Salisbury	Ar																
332.000	49.000	Salisbury	Dp																
325.000	56.000	Linwood Yard	Ar																
325.000	56.000	Linwood Yard	Dp																
317.000	64.000	Lexington	Ar																
317.000	64.000	Lexington	Dp																
305.500	75.500	Thomasville	Ar																
305.500	75.500	Thomasville	Dp																
300.500	80.500	Highpoint	Ar																
300.500	80.500	Highpoint	Dp																
286.000	95.000	Pomona Yard	Ar																
286.000	95.000	Pomona Yard	Dp																
283.900	97.100	Greensboro-Elm	Ar																
0.000	97.100	Greensboro-Elm	Dp																
21.000	118.100	Burlington	Ar																
21.000	118.100	Burlington	Dp																
58.000	155.100	Durham Yard	Ar																
58.000	155.100	Durham Yard	Dp																
73.000	170.100	Fetner	Ar	12:30 PM	8:30 PM		10:30 PM												
73.000	170.100	Fetner	Dp	12:30 PM	8:30 PM		10:30 PM												
80.600	177.700	Raleigh	Ar		9:00 PM														
157.400	177.700	Raleigh	Dp		9:30 PM														
156.400	178.700	Southern Jct	Ar	9:30 AM															
156.400	178.700	Southern Jct	Dp	9:30 AM															
136.000	199.100	Youngsville Siding	Ar																
136.000	199.100	Youngsville Siding	Dp																
98.500	236.600	Norlina	Ar	1:30 PM															
98.500	236.600	Norlina	Dp																
22.356	312.744	Petersburg	Ar																
22.356	312.744	Petersburg	Dp																
11.000	324.100	Centralia	By			1:00 AM		2:00 AM		2:40 AM	4:00 AM	6:00 AM	7:30 AM	8:00 AM	10:00 AM	12:00 PM	2:00 PM	4:00 PM	6:00 PM
8.000	327.100	Bellwood	By							2:50 AM			8:00 AM						
5.000	330.100	Fanshaw	By										9:30 AM						
1.600	333.500	Deepwater Jct	By																
0.600	334.500	Rocketts	By																
11.000	324.100	A-Line	By		4:30 PM	12:30 AM		2:30 AM											
0.000	335.100	Richmond-Main St	Ar				1:30 AM	2:30 AM	1800		4:30 AM	6:30 AM		8:30 AM	10:30 AM	12:30 PM	2:30 PM	4:30 PM	6:30 PM
0.000	335.100	Richmond-Main St	Dp																

Running Time

4:00	4:00	3:30	0:30	4:00	0:30
------	------	------	------	------	------

0:10	0:30	0:30	2:00	0:30	0:30	0:30	0:30	0:30	0:30
------	------	------	------	------	------	------	------	------	------

Raleigh-Norlina Turn

Collier-Bellwood Turn

Collier-Fanshaw Turn

SEC Southbound Commuter Timetable

Milepost	Distance	Type Direction Pattern	Station	Daily Commuter South Commute S		Daily Commuter South Commute S		Daily Commuter South Commute S		Daily Commuter South Commute S		Daily Commuter South Commute S	
				1001	1003	1005	1007	1009	1011	1013	1015	1017	1019
332.000	286.100	Ar	Salisbury										
332.000	286.100	Dp	Salisbury										
349.000	303.100	Ar	Kannapolis										
349.000	303.100	Dp	Kannapolis										
352.800	306.900	Ar	Adams	5:30 AM	6:00 AM	6:30 AM	7:00 AM	7:30 AM	8:00 AM	8:30 AM	9:00 AM	5:35 PM	6:05 PM
352.800	306.900	Dp	Adams	5:30 AM	6:00 AM	6:30 AM	7:00 AM	7:30 AM	8:00 AM	8:30 AM	9:00 AM	5:35 PM	6:05 PM
376.000	330.100	Ar	Charlotte	6:05 AM	6:35 AM	7:05 AM	7:35 AM	8:05 AM	8:35 AM	9:05 AM	9:35 AM	6:00 PM	
376.000	330.100	Dp	Charlotte										
381.000	335.100	Ar	Charlotte Jct										
381.000	335.100	Dp	Charlotte Jct										

Running Time

0:35	0:35	0:35	0:35	0:35	0:35	0:35	0:35	0:35	0:35	0:35	0:35	0:25
------	------	------	------	------	------	------	------	------	------	------	------	------

SEC Northbound Commuter Timetable

Milepost	Distance	Type Direction Pattern	Station	Daily Commuter North Commute N		Daily Commuter North Commute N		Daily Commuter North Commute N		Daily Commuter North Commute N		Daily Commuter North Commute N	
				1002	1004	1006	1008	1010	1012	1014	1016	1018	1020
381.000	0.000	Ar	Charlotte Jct										
381.000	0.000	Dp	Charlotte Jct										
376.000	5.000	Ar	Charlotte	6:25 AM	6:55 AM	7:25 AM	4:05 PM	4:35 PM	5:05 PM	5:35 PM	6:05 PM	7:05 PM	7:35 AM
376.000	5.000	Dp	Charlotte	6:25 AM	6:55 AM	7:25 AM	4:05 PM	4:35 PM	5:05 PM	5:35 PM	6:05 PM	7:05 PM	7:35 AM
352.000	29.000	Ar	Adams	6:50 AM	7:20 AM	7:50 AM	4:45 PM	5:15 PM	5:45 PM	6:15 PM	6:45 PM	7:45 PM	8:15 AM
352.000	29.000	Dp	Adams										
349.000	32.000	Ar	Kannapolis										
349.000	32.000	Dp	Kannapolis										
332.000	49.000	Ar	Salisbury										
332.000	49.000	Dp	Salisbury										

Running Time

0:25	0:25	0:25	0:25	0:25	0:25	0:25	0:40	0:40	0:40	0:40	0:40	0:40	0:40
------	------	------	------	------	------	------	------	------	------	------	------	------	------

**Technical Monograph:
Transportation Planning
for the Richmond–Charlotte Railroad Corridor**

January 2004

**Appendix G
Descriptions of Individual Projects**

**Federal Railroad Administration
United States Department of Transportation**

Appendix G

DESCRIPTION OF INDIVIDUAL PROJECTS

In response to the growth and expansion expected along the Richmond to Charlotte Corridor, analyses performed for the FRA identified improvements that would be required to support projected 2020 levels of intercity, freight, and commuter operations. These projects and improvements have been integrated into the Richmond to Charlotte CTP.

This appendix presents descriptions of the various projects and Corridor program improvements that have been initially evaluated and found to be necessary and sufficient to support safe and dependable rail passenger service between Richmond and Charlotte in less than 4 hours 20 minutes. The projects would accommodate the projected level of intercity passenger, commuter and freight service in the year 2020. Proposed projects are listed according to the categories outlined in the body of the report.

Each proposed project is described under the following headings:

- Needs assessment; and
- Project description.

Information on project location and priorities is presented, however, information on design and construction schedules, and construction impact on operations has not been developed.

Costs are discussed in Chapter 7.

The geographic locations of the projects and their interrelationships are shown in Appendix D.

Considerations for All Projects

The following considerations should be included, as appropriate, in the scope of each of these projects:

- Lengthen spans of overhead bridges as necessary.
- Provide independent structures at existing undergrade bridges where necessary to accommodate new tracks.
- Extend existing grade crossings to include improved approaches, maintenance of adequate site distances, and relocation of grade crossing signals.¹

¹ As part of a separate initiative, the potential for eliminating individual grade crossings would be analyzed.

- Provide adequate drainage facilities, including the extension of existing culverts under the railroad.
- Relocate wayside signals, as necessary, to accommodate the new track.
- Optimize spacing of signals approaching new interlockings as part of upgrading the signal system.
- Maximize the use of 45 mph main line crossovers and turnouts.
- Maintain access to existing sidings and local industries.

TRIP TIME-RELATED PROJECTS

Curve Realignment

The rail lines proposed to be utilized by high-speed rail service south of Richmond were built when railroad technology was in its infancy. Although numerous line relocations have been made over the years, it remains a railroad with a significant number of curves. At many locations the surrounding community has developed to the point where relocation of the alignment is unrealistic. Environmental concerns make relocation difficult elsewhere. Nevertheless, several types of fixed-plant improvements to reduce the speed constraints associated with curves in the Richmond to Charlotte Corridor should be implemented:

- Changing horizontal and vertical alignment, either within the existing right-of-way, or by acquiring land outside the existing right-of-way;
- Increasing superelevation to the maximum allowable for a particular track alignment;
- Increasing the amount of unbalanced superelevation used to calculate speeds through curves to minimize track shifts; and
- Modifying spirals (the length of track that provides a smooth transition from tangent track to curved track) to provide a smoother ride.

The alternative of changing horizontal and vertical alignment, either within the existing right-of-way, or by acquiring land outside the existing right-of-way, has been considered but deemed not necessary to meet the trip time goal of less than two hours between Washington and Richmond. However, the analysis of the requirements to meet the trip time goal of less than four hours and 20 minutes between Richmond and Charlotte lead to the conclusion that a judicious number of curve relocations would be required. The recommended alignment changes were selected to allow higher speeds that can be sustained for meaningful periods of time by eliminating or reducing the effect of slow-speed curves.

The initial analysis represents a "best case". Though listed here as two projects, the improvements would actually consist of a large number of separate "sub-projects" at individual curves or groups of curves. It is likely that detailed study will reveal local constraints that would limit the feasibility or practicality of implementing some specific sub-projects.

The curve realignment program will contribute significantly to the improvement in travel times in the corridor, thereby justifying the time and expense required to implement the program.

Analysis of Curves

Preliminary analysis of curves between Richmond and Charlotte used recent FRA track geometry car data, and NS and CSXT track chart data. The maximum lateral acceleration allowed in the body of the curve was kept below 0.15 g and maximum jerk rate was limited to 0.04 g per sec.² Spirals for increased speed were calculated in accordance with criteria previously used for the Northeast Corridor Improvement Project. Unbalanced superelevation was limited to 7 inches for tilt-bodied high-speed trains and 5 inches for commuter and conventional train operations, in conformance with criteria (based on ride comfort, maintenance, and spiral length concerns) utilized in the analysis of Northeast Corridor operations.

For the purpose of the analysis, it was assumed that superelevation, for the 157 miles between Richmond and Raleigh, would be increased (or similarly decreased) at linear rates specified by CSXT. For the 221 miles to the relocated Charlotte station the NS criteria were used.

The analyses identified curves that should be realigned to adjust spiral length, and, if need be, superelevation to optimize goal speeds and enable trip times to be decreased.

Determination Of Curves Or Segments Of Track To Be Relocated

Once the spiral analysis was completed, a series of Train Performance Calculator (TPC) runs were made to evaluate trip time performance and test alternatives to reduce trip times to meet the 4-hour 20-minute goal. Computerized and manual techniques were then utilized to determine the amount that individual curves or groups of curves would have to be relocated to increase speeds in slow-speed of restrictive locations identified by the TPC runs. The methodologies and results are documented in Appendix A.

Additional Requirements

Centralia to Norlina

It has been assumed that the restored S Line between Centralia and Norlina would be reconstructed to the optimal trip time, spiral, and comfort requirements. Additionally, it has been assumed the alignment would be graded to accommodate all of the proposed sidings, although certain of the sidings would not be built until the level of passenger and freight service dictated the need for them.

²Operations at 7 inches of unbalanced superelevation would require the installation of concrete ties on curves where unbalance would exceed 5 inches to provide for economical maintenance.

Surveying

As part of the project, the line needs to be surveyed to accurately record current conditions and enable final design to be completed. For the most part, the line has not been surveyed recently. Trip time sensitive realignments would be completed in conjunction with other improvements.

Safe Braking Distances

Safe braking distances at the increased speeds projected for the line would be established during the redesign of the signal system, which is described below.

Premium Ties and Fasteners

If tilt trains capable of operating at seven inches of unbalanced superelevation and a MAS of 110 mph are utilized in the corridor premium ties and fasteners would need to be installed on curves in which the trains would operate at greater than five inches of unbalanced superelevation. Preliminary analysis indicates that tilt trains would operate at greater than five inches of unbalanced superelevation on approximately 160 curves or approximately 90 track miles of curves. Allowing ten percent for the approaches to curves or for short stretches connecting adjacent curves, 100 miles of premium ties and fasteners would be required to safely and efficiently operate tilt trains in the Richmond to Charlotte Corridor.

The Benefits Of Curve Realignment Come In Small Increments

Many small sub-projects would be undertaken to implement the program. Even though the curve realignments would be within the right-of-way, implementation implies expenditures that would disrupt train operations, with only small benefits being derived for each curve realigned. Improvements of this nature are only warranted in the context of an overall program directed toward significant trip time reduction.

Curve Adjustment Program

Almost every curve in the corridor, that is not relocated, will require that individual curves be modified by either:

- Increasing superelevation to the maximum allowable for a particular track alignment;
- Increasing the amount of unbalanced superelevation used to calculate speeds through curves to minimize track shifts; and
- Modifying spirals (the length of track that provides a smooth transition from tangent track to curved track) to provide a smoother ride.

The work required to modify the curves was classified in accordance with four levels of shift:

- Less than six inches;
- Between six and 36 inches;
- Between 36 inches and 10 feet; and
- More than 10 feet.

For the most part these curves require shifts of less than three feet, which generally can be accommodated within the existing rail alignment. It is assumed that shifts of less than six inches can be achieved during planned surfacing and line maintenance activities.

Shifts greater than six inches are assumed to require specific scheduled work outside of the normal maintenance requirements.

In a limited number of instances the curves must be relocated in excess of 10 feet to obtain the desired spiral or superelevation modifications. In those instances it is assumed that significant levels of new roadbed will be constructed. USGS maps, photos of the right-of-way and other data were used to develop the estimates.

Curve Relocation Program

A description of recommended infrastructure and operating modifications is provided in Appendix A. This initial list of improvements represents a “best case” situation. It is likely that detailed study would reveal additional local constraints that might limit the feasibility or practicality of implementing some specific sub-projects. This curve realignment program would contribute significantly to travel time improvement in the Corridor thereby justifying the time and expense required to implement the program.

The curve relocations identified are as follows:

S Line – Modifications to Alignment that Existed Prior to Abandonment

- Dinwiddie Relocation (MP S37.1 – MP S39)
- MP S58.5 TO MP S60.1
- MP S62.6 TO MP S65.9
- MP S68.5 to MP S75.3
- MP S77 to MP S77.8 (Curves S77³, S77.1 and S77.2)
- MP S86.1 to MP S87 (Curves S86, S86.1, S86.2), and
- MP S96.5 to MP S98.7.

Modifications to Active S Line – Norlina to Raleigh

- Manson Curve (S103), and
- Curves South of Wake Forest.

Modifications to H Line – Raleigh to Greensboro

- Curve H64
- MP H62.7 – MP H54.6 (Curves H55 to H60.1)

³ Curves are numbered in ascending milepost order in relation to the mile of the line where the beginning of the curve is located; i.e., Curve S77 is the first curve south of MP S77 and Curve S77.1 is the second curve south of MP S77.

- MP H50.3 – MP H43.8 (Curve H49 to Curve H44)
- MP H42.9 - MP H 41.8 (Curves H42.2, H42, and H41.1)
- MP H38.9 – MP H36.4 (Curves H36 to H38.2)
- MP H29.2 to MP H26.3 (Curves H28.4 to H26)
- H20.1 to h 21.3 (h20.5 to h22.3), and
- H 6 to H5.1 (MPH6.3 to MPH5.6).

Modifications to Washington to Atlanta Main – Greensboro to Charlotte Line

- Curve 296.

Restoration Of The S Line

Existing Amtrak Route – Richmond to Raleigh

The daily Carolinian between New York and Charlotte is routed from Staples Mill Road Station, Richmond, to Amtrak’s Raleigh Station by means of the CSXT A Line via Petersburg, VA, Rocky Mount, NC, Wilson, NC, and Selma, NC and the NS H line between Selma and Richmond. The 197-mile trip takes 3 hours and 45 minutes (52 mph average speed) southbound and 3 hours and 34 minutes northbound. The route does not use Main Street Station, Richmond, and requires a slow move from the S to H Lines at Selma.

The A Line is the principal CSXT north-south, I-95, freight route; it is primarily single track with sidings. Achieving a two-hour Richmond to Raleigh trip time would require an average speed of almost 100 mph, which is not achieved on the NEC, and would require significant improvements to the A and H Lines. Therefore, NCDOT and VDRPT have selected the alternative of restoring the S Line.

The Proposed Restoration of the S Line – Richmond to Raleigh

The portion of the former Seaboard Line, (called the S Line), included in the Southeast Corridor extends from Richmond Main Street Station to Raleigh, a distance of 157 miles. The route between Centralia and Norlina, about 88 miles, has been abandoned and the tracks have been removed. Some bridges remain. The remainder of the tracks has been downgraded to a branch freight only Class II status. To restore passenger service the abandoned tracks would have to be restored, new passing sidings provided, bridges rebuilt or upgraded and the remainder of the tracks upgraded to passenger speeds. The discussion below outlines the facilities needed to restore passenger service between Centralia and Raleigh. The portion between Richmond and Centralia has been described in a previous report.

The restored line is planned to have four passenger trains each way between Charlotte and Washington or New York. In addition Amtrak proposes to reroute its Silver Star, now operating each way via the A Line and Selma and Raleigh, to the S Line. CSXT has stated that if the S Line is restored they would liked to operate four intermodal trains each way per day and one merchandise train each way. Description of these trains is discussed in a section covering Raleigh operations. Therefore the number of trains per day could be ten passenger trains and ten freight trains per day.

South of Norlina two local freight trains each way per weekday operate currently over a portion of the S Line in addition to the twenty trains mentioned above. The operation of these trains also would be covered in the section describing Raleigh's operations and configurations.

South from Richmond the current S Line ends at Centralia and joins the former Atlantic Coast Line (called the A Line) there. A connection to join the two lines was constructed when the S Line was abandoned south of Centralia.

Alternative routes are being studied in the Petersburg area as part of the Richmond to South Hampton Roads High-Speed Rail Feasibility Study. Three of the more promising options that might result in rerouting the Richmond, VA to Raleigh, NC corridor traffic include:

- Constructing a third main on the east side of the A line from Centralia to Dunlop in Colonial Heights, VA;
- Reinstalling track on the old ACL passenger main through Colonial Heights to the former N&W passenger station in downtown Petersburg where it would split into two routes, one route would connect to the NS line to Norfolk and the other route would go west on the NS line to new connections to the A line and former S line on the west end of Petersburg; and
- Constructing a third main on the east side of the A line from Centralia through Dunlop and the existing Ettrick (Petersburg) station, where it would split into two tracks before crossing the Appomattox River on a new bridge; one track would curve east and join the NS track through Petersburg to Norfolk; the second track would curve west to briefly join the NS route before connecting to the former S line on the west end of Petersburg. Access to the A line would be via an interlocking at Ettrick.

The Restored "S" Line

Where the S Line is restored starting at MP S10.9, a full universal interlocking would be required at Centralia to provide full connectivity between the A Line and The S Line in both directions. About ten northward CSXT freight trains would operate from the A Line to the S Line between Centralia and Main Street as well as the six-passenger trains to/from Florida. One Florida train and the four North Carolina trains would continue southward to Raleigh on the restored S Line. Because of clearances just south of Main Street Station, the Auto Train must operate on the A Line around Richmond.

South of Centralia the restored S Line would parallel the A Line for about two miles and would bridge over the A Line at the location (MP S12.5) where the S Line previously had crossed over the A Line on an overhead bridge.

South of Chester the restored S Line would be on the roadbed of the abandoned S Line to about MP S20. At that point rather than passing under the A Line as the S Line formerly did, crossing the Appomattox River on a major bridge now removed and then passing under the A Line again just south of the A Line Appomattox bridge, the restored S Line would curve to become parallel to the A Line through Petersburg. The parallel lines would serve one passenger station in Petersburg, which would be at Ettrick (about MP S 22). A universal interlocking is planned between the A Line and The S Line one mile north of the passenger station. This interlocking, named Pete for this

study, would allow passenger trains to operate on either the A Line or the S Line between Centralia and Pete. Freight trains that operate on the S line may enter or leave the A Line at Pete. In short, CSXT would become a triple tracked between Centralia and Pete. Normally CSXT A Line freight trains would remain on the A Line to avoid conflicts with passenger trains; however, passenger trains operating on the A Line could use the restored S Line between Pete and Centralia, but that operation was not simulated.

At about MP S23 the A Line and the restored S Line separate again. The A Line curves onto its bridge over the Appomattox River. This bridge is a 60-foot high single-track bridge about 1300 feet long in an otherwise double tracked line. It appears that the bridge has always been a single-track bridge. The elevation of the bridge according to the Petersburg USGS map is about 100 feet and the stream level is about 40 feet. The restored S Line would also require a new bridge of about the same length and height about a half mile upstream.

A complicating factor for the new S Line Bridge is a Norfolk Southern branch line (the original main line) that must either be bridged or gone under. The NS line has significant grade descending from west to east. The best alignment for the restored S Line would be about one half mile upstream from the A Line Bridge, and the elevation of the S Line would be about 85 feet at its intersection with the NS Line. The NS elevation at that point is also 85-90 feet, and that suggests an unwanted crossing at grade. Lowering the NS is a poor option because of their grade and raising the S Line is also a poor option because of the excessive downgrade that would create on the S Line south of the bridge. Going under the NS is not a good option either because the elevation of the S Line would have to be about 60-65 feet. That elevation would be near the water level of Cattail Run south of the under-crossing and only 10-15 feet above Appomattox River.

Having the bridge over the NS down stream to where the NS elevation is about 75 feet gives a better vertical separation. The S Line can cross over the NS at an elevation of about 100 feet because the elevation of the escarpment on the north side of the river is 110 feet and the elevation on the south side is about 90 feet. The restored S Line rejoins the former line on the south side of the river at new MP S23.5. The milepost of the former line is about MP S24.05 so paralleling the A Line through Petersburg is about one-half mile shorter than the original Seaboard alignment. Further references to the mileposts would be for the original mileposts.

A second complicating factor in the Petersburg area is at Secoast (MP S26.5) where the NS Belt Line passes over the former S Line. The access road to a new Chaparral Steel plant occupies a portion of the alignment of the former S Line south of that location. Given this, a new S Line alignment could possibly be located west of the former line, but it would require a new bridge under the NS. The new line would eliminate a 2-degree reverse curve that existed on the former alignment. It is also possible that a connection may be constructed from the S Line to the NS Belt Line to provide passenger train access to Norfolk. A separate study sponsored by VDRPT is evaluating the potential for high-speed rail service to Norfolk. The potential Norfolk trains have not been included in any train simulations.

Sidings

All proposed sidings on the restored S Line are planned to be 3.5 to 4 miles long. All end-of-siding turnouts are No. 20 installed on straight track. The rationale for 4-mile sidings is to minimize signal delay for trains entering the siding and to increase the probability of making moving meets. The long siding would permit an intermediate signal to be placed about mid-siding. If the signal at the opposite end of the siding displays a stop aspect, as one would expect when a train is entering the siding, the intermediate signal would display an approach aspect. That means the train is to begin braking at the approach signal and be prepared to stop at the signal at the leaving end of the siding. Enough braking distance must be provided between the intermediate signal and the stop signal so that a freight train can be stopped.

When the intermediate signal displays an approach aspect the signal at the entering end of the siding would display a limited clear aspect good for 45 mph if the end of the siding has a No. 20 turnout. That aspect tells the engineer that the train may operate at 45 mph until the entire train has entered the siding or the train has passed the intermediate signal, whichever occurs first. If the train is short enough, as passenger trains would be, the train may actually accelerate to the intermediate signal if the allowable siding speed is greater than 45 mph. By arranging the signals in this way the long freight train would clear the single track in the least possible time.

If the siding is so short that the intermediate signal could not provide sufficient braking distance to a stop signal, the intermediate signal may serve little or no purpose because the signal at the entering end of the siding would have to provide the safe braking distance needed. In a case like that the entering aspect would display a limited approach aspect (CSXT Signal Rule 281-D). The engineer may enter the siding at 45 mph but must immediately begin to brake so the train can be stopped at the opposite end of the siding. Thus the rear of the train could be crawling into the siding at fifteen mph or less depending upon the siding length, thereby occupying the single track for a longer than necessary period of time⁴.

The spacing of the sidings on a single-track system determines the capacity of the system and also the length of the delays when meets do occur. Since the S Line is being restored for passenger service, the latter consideration is most important. A maximum delay of ten minutes for a meet between two passenger trains is the worst-case that should be tolerated for reliability of service. A meet between two passenger trains would require that a passenger train would have to divert from one track to a second track to avoid slower moving trains, or divert to a siding in single-track segments to enable a passenger train in the opposing direction to pass. Each time this occurred a passenger train would be required to slow down, enter a siding, and wait for the passenger train coming in the opposite direction to go past, each train added an average of 9.5 minutes of delay to its performance. Therefore, to ensure the reliability of the passenger train operations, a maximum delay of ten minutes for a meet between

⁴ Greystone, S109, at about 2.5 miles is the only recommended siding that this would apply to.

two passenger trains was the worst-case scenario that would be tolerated. Accordingly, the design criterion for siding spacing was expressed in time rather than miles⁵

While the maximum speed on the S Line would be 110 mph, the prevailing speed is more like 90 mph because of the many curves. Thus a train would travel a mile in about two-thirds of a minute. Dividing two-thirds into ten minutes gives a maximum center-to-center siding spacing of 15 miles. If the sidings are four miles long as explained earlier the length of single track between siding switches should not exceed 11 miles.

Spacing every siding at the ideal distance is often not possible. Major bridges, clusters of road crossings, and curves may make it too expensive or operationally infeasible to place sidings ideally. Therefore a location where no grade crossings or curves exist should be sought. Even then such a location may not be found. Sidings that require standing freight trains to cut crossings (uncoupling the train to let automobiles use a crossing and then re-coupling the train to depart) are unacceptable because many freight trains have only two crewpersons: an engineer and a conductor. Therefore constant communication between a dispatcher and the engineer is required so that the engineer may pace the train's arrival at a siding so that meets can be made without stopping the freight train. This is another reason for having long sidings.

Installing Number 32 Turnouts (80 mph) in Place of Number 20 Turnouts (45 mph) at the End of Sidings

A passenger train slowing from 100 mph to 80 mph to enter a passing siding would depart the single track one minute sooner than if it slowed to 45 mph. Whether the time saved in entering the siding at 80 mph actually results in an overall reduced transit time for the train entering the siding depends where the opposing train to be met is located when the siding is entered. If the siding spacing is fifteen miles the opposing train may be from a fraction of a minute to as much as nine minutes away from the exiting end of the siding being entered.

Siding With Number 20 Turnout

A passenger train traveling at 100 mph entering a siding to meet another train would be delayed a minimum of five-minutes due to: receiving a signal in advance of the turnout and decelerating to 45 mph, traversing the siding at 45 mph, and accelerating to 100 mph. For this to occur the opposing train can be no farther than three minutes (4 miles) from the exiting end of the siding when the initial passenger train entered the north end of the siding.

Siding With Number 32 Turnout

A passenger train traveling at 100 mph entering a siding to meet another train would be delayed a minimum of 1.5-minutes due to: receiving a signal in advance of the turnout and decelerating to 80 mph, traversing the siding at 80 mph, and accelerating to 100 mph. For this to occur the opposing train can be no farther than one minute (1.3

⁵ In an operation where the train speeds are uniform, miles would be acceptable criteria.

miles) from the exiting end of the siding when the initial passenger train entered the siding. Consequently, it is highly likely that few, even any, trains would achieve a no-slowdown meet with the Number 32 turnout installed.

Reduction in Delay

The least delay time that can be saved is zero minutes (same as at 45 mph) and the most is 3.5 minutes (5 minutes less 1.5 minutes) but about three minutes is about the best that can be achieved.

Therefore, if only one or two meets occur at a siding each day the added cost for number 32 turnouts cannot be justified. However, when the number of passenger meets is five per day at a siding the increased reliability of operations might justify the cost.

Siding Location and Curve Relocations.

If the ideal location of a siding is where curve relocation may eventually be made, constructing the siding there prior to the line change would be wasted money. Therefore, if adequate siding spacing can be maintained sidings should be constructed where no line change is likely.

There would be locations discussed later where siding locations cannot be changed to avoid possible future relocations. In that case a choice should be made whether to either build a new main track with the current main track becoming the siding in its current position or to build a new siding concurrently to relocating the main track. These areas are identified in the following discussion.

SIDING-BY-SIDING DISCUSSION – Restored S Line, Centralia to Norlina

Chester Siding

Between Centralia and MP S13 at Chester a passing siding is provided so that northward trains entering the A Line from the restored S line can wait clear of the S Line or A Line if access to the A Line is not immediately available. Also southward trains entering the S Line at Centralia would have a place to wait clear of both the A Line and S Line if the S line is not immediately available.

Lynch Siding S16.4 to S20.2

Between Pete and Chester a 4-mile long passing siding at Lynch is proposed between about MP S16 to MP S 20. A siding previously existed at Lynch but it was much shorter than the one now being proposed.

Burgess Siding (MP S29.6 to MP S34.5)

The south end of the proposed siding at Lynch is at about MP S20, so the ideal location of the next siding would be about MP S31. The north end of a signaled Burgess Siding was formerly at MP S31.2 and much of the new siding can be built of the former siding roadbed. The limits of the new Burgess siding are from MP S29.6 to MP S34.5.

De Witt Siding (MP S41 to MP S44.5)

De Witt was the location of a former signaled passing siding that began at MP S41.2 and extended to MP S42.6. Reusing the roadbed of the former siding results in the spacing between the De Witt siding and the Burgess siding being about 7 miles or 3 miles less than the ideal 10 miles. The west end of the siding would be extended to MP S44.5 and would be located between curves 44 and 44.1.

Alberta Siding (MP S55.4 to MP S61)

Ideally, the north end of the next siding would be at about MP S55. Conveniently, a former signaled siding at Warfield began at MP S55.8 and extended to MP S57.3. A second un-signalized siding for Alberta began at MP S59.5 and extended to MP S61. It is proposed that the two former sidings would be connected into one 5.6 mile long Alberta siding. The former Warfield siding would be extended 0.4 miles northward to MP S55.4.

Skelton Siding (MP S71.2 to MP S 74.9)

Grandy was the next signaled siding south of Alberta; it extended between MP S66.9 and MP S68.3, but was only 5.9 miles from Alberta. The north end of the next siding should be about 10-11 miles south of Alberta or at MP S70-71, so clearly the former Grandy siding does not meet the required siding spacing.

A former mile-long non-signalized passing siding at Skelton (Skelton is the railroad name, Forksville is the name on USGS maps) was located between MP S73 and MP S74. This former siding is located in difficult terrain⁶ and extending it to a 4-mile siding would be difficult. However, it is proposed that the new siding would be extended north to about MP S71.2 and south to the north end of the former 271-foot deck plate girder Taylor Creek Bridge at MP S74.9.

Associated Curve Relocation. Four curves (a right-hand 4-degree curve, a left-hand 4-degree curve, a right-hand 4-degree curve, and a left-hand 3.75-degree curve) are located south of MP 71. It is proposed that a 7,900-foot line change be made when the siding is built and the four curves replaced by one right-hand curve of 1.75 degrees and one left hand curve also of 1.75 degrees. The relocation would be about 400 feet shorter than the original alignment, but because of two small grade breaks in the original alignment the maximum grade could remain at one percent.

The southward portion of the siding includes two left-hand curves of 2.5 degrees and 3.75 degrees. It appears that the two curves could be rather easily combined into a single 1.5-degree curve with a 2900-foot relocation. Relocating these two curves would increase the amount of tangent distance north of the Taylor Creek Bridge to place the turnout to the south end of the siding.

Bracey Siding

The north end of the next siding should be located about 10-11 miles south of MP S75 or at MP S85-86. If the north end of the new Bracey siding were located at MP S84, as desired, the south end of the siding would be located at MP S88, which is about

⁶ A major bridge crossing of the Meherrin River is about three miles north at MP S70.2 and the former S Line alignment is on a serpentine climb of one percent from that point to Skelton.

one-half mile north of a bridge over Roanoke River, which is more than one-half mile long. Locating the siding further south would overlap the bridge. A former signaled siding at Hagood extended from MP S83 to MP S84.5. While MP S83 is only eight miles from the Skelton siding the roadbed of the former siding might be reused and extended to MP S86.5 between two curves of 4.5 degrees and 4.0 degrees.

Associated Curve Relocations. Southward between MP S86 and MP S87 are three curves: a left-hand curve of 4.5 degrees, a right-hand curve of 4 degrees, and left-hand curve of 4 degrees. It is proposed relocations that these three curves be replaced with one 2-degree curve. This length of the relocation is approximately 4,200-feet.

The south end of the relocation would be approximately MP S87, so if the relocation was made at the time the siding was being built the new Bracey siding could extend from MP S83 to S87.

Signal System Upgrade

Signal system upgrades are necessary to efficiently handle increased train traffic on the Corridor and to permit improved intercity passenger service with greater safety. These improvements also would enable freight service, and any potential commuter service, to safely and efficiently operate on the same tracks. New block layout and signal aspects would accommodate speeds up to 110 miles per hour⁷. The signal system would use microprocessor-based track circuits and control/indication equipment. Block spacing would anticipate increased train speeds. Cab signals would be installed and all locomotives operating on the line would be equipped with Automatic Train Control (ATC). Reverse signaling would be installed throughout the corridor. Interlockings would be remotely controlled from Jacksonville, Florida on the S Line and from Greensboro, North Carolina for the H Line, and along the Washington to Atlanta Main Line.

The new signal system would improve the reliability of train operations for all services, contribute to maintenance-related operating costs, and would be a component critical to enabling higher speed train operations.

High-Speed Intercity Trainsets

High-Speed Rail planning by Virginia Department of Rail and Public Transportation (VDRPT) and North Carolina DOT assumes an increased number of trains operating between New York City and points south of Washington. Their objective is to offer the public a reliable, high-quality, cost-effective, competitive high-speed intercity passenger rail service. Neither state has selected the trainsets (locomotive plus coaches) that will be used to provide this improved intercity rail service. Diesels and Amtrak Amfleet coaches are presently operated south of Washington.

A variety of train set alternatives are being evaluated nationwide and will provide state planners with numerous options. Among the alternatives, the FRA's Next Generation High-Speed Rail Technology Program has initiated a program to develop

⁷ The braking distance for a 110 mph passenger train is essentially equal to that of a 60 mph freight train.

and demonstrate a high-speed turbine-electric locomotive that would approach the speed and acceleration capability of electric trains without the cost of railroad electrification. Upon successful completion of a demonstration program, the non-electric locomotive would be a viable option to high-speed intercity passenger operators. Tilt-train equipment to enable trains to operate at increased speed safely and comfortably through curves is being operated in the Pacific Northwest and will be introduced in the Northeast Corridor in late 1999.

The train set selected by the state planners will have to be compatible with NEC operating requirements and facilitate timely engine changes (between diesel and electric) in Washington.

The trainsets that would be operated south of Washington to provide improved high-speed rail service have not been identified. Once a determination has been made, the cost of acquiring the trainsets would be evaluated. It is essential that rolling stock compatible with Amtrak's Northeast Corridor train service be selected.

Capacity Related Improvements

Route Realignment/Augmentation – Richmond Main Street Station to Centralia

Main Street Station

A single track and platform on the west side of Main Street Station would be insufficient to reliably operate the volume of freight trains, through passenger trains, and terminating/originating passenger trains projected for 2020. Two tracks would be constructed on the west side of Main Street station. Thus, northward freight trains can be passing through the station on Track 2 while southward passenger trains and/or northward originating trains are routed to or loading/unloading in the station on Track 1. Similarly, northward and southward passenger trains may be routed to or load/unload simultaneously.

Richmond to Centralia

High-speed rail services proposed by the states of Virginia and North Carolina would utilize Main Street Station, which the City of Richmond is in the process of upgrading as a multi-modal transportation center.

The existing track configuration between Richmond and Centralia is inadequate to support the proposed level of 2020 train operations.

The most significant constraint between Main Street Station and Centralia would be the single-tracked James River Bridge. It is assumed that passenger trains would have preference over freight trains for the use of the bridge. Therefore, northward freight trains require sequencing to enable them to follow a northward passenger train at Rocketts (located at the south end of the James River bridge). Northward freight trains would be held at Dale Avenue, just south of Dale Interlocking, to avoid blocking highway crossings. Freight trains would not be released from Dale Avenue unless they could clear Main Street station before a southward passenger train operating to Centralia was scheduled to depart Main Street Station (Main St Interlocking, at the south end of the

Station, is the north end of the single track on the bridge). A northward freight train released from Dale Avenue must be assured non-stop access to the James River Bridge.

Southward freight trains would not be released to enter Main Street Station if a northward freight train has been released from Dale Avenue. The numerous highway crossings between Dale and Rocketts cause a de facto single-track operation for freight trains between Brown Street and Dale, even though two tracks actually exist on both sides of the James River Bridge³. Any train that must be held, must be stopped clear of these crossings.

Restoration of passenger rail operations from Staples Mill Road Station, through Main Street Station, to Centralia would require that:

- Rocketts Interlocking be reconfigured to accommodate the proposed Richmond to Bristol TransDominion Express rail service;
- The existing crossovers in the vicinity of MP S1.5 would be relocated to Deepwater Junction (MP S-1.8) to facilitate the movement of the Acca-Deepwater turn from South Yard (located west of the railroad) to Deepwater (located east of the railroad). The new crossovers would be positioned so that a progressive move, from north to south, can be made from the siding (Sixth Street lead);
- The existing interlocking at Marlboro (S4.5) be replaced with an universal interlocking (with two No. 20 crossovers to enable 45 mph moves) at Dale (S4.8);
- The existing Falling Creek interlocking (S-7.3) would be removed and a universal interlocking (with two No. 20 crossovers) constructed north of MP S-7 to replace it. The interlocking would be located on the tangent track between the north end of the 2-degree curve, at MP S-7.0, and the Falling Creek Bridge; and
- The double track south of Rocketts would be extended from MP S8.9 to Centralia (approximately S10.7).

The principal conclusions relative to the re-institution of passenger train operations in Main Street Station and the results of the recent simulation of proposed 2020 freight and passenger trains between Staples Mill Road Station, Centralia, and Fulton Yard are:

- Terminating, and originating trains, at Main Street Station is not possible without storage and turning facilities located in close proximity to the station, and
- Full reverse signaling and universal interlockings at Dale and Falling Creek are essential to provide the operating flexibility and capacity to enable the train dispatcher to manipulate trains through the available windows between Rocketts and Main Street, over the James River Bridge.

³Stopping a freight train between Dale and Rocketts would result in crossings being blocked, thereby, delaying cross-street traffic.

Route Realignment/Augmentation - Norlina to Raleigh

Norlina Siding

The north end of the next siding south of Bracey should be about 10-11 miles south of MP S87 or at MP S97-98. Norlina is at MP S98, which is where a stretch of double track previously began.

The route from Portsmouth, VA to Raleigh, NC was apparently constructed before the route from Richmond to Norlina, and the original route had no curves through Norlina. When the railroad was built from Richmond it was connected to the original line with a 5 plus-degree curve (60 mph) at Norlina Station. A 3-degree curve (75 mph) was located one and a half miles north of Norlina at MP S96.5. A 1.6-mile relocation using a 7000-foot long one-degree curve to tie the two routes together would create an eleven-mile long stretch between Paschall and Manson where trains could operate at a constant 110 mph. This would be the longest continuous high-speed length between Richmond and Raleigh. This relocation was used in the trip time analysis.

While the former double track extended to MP S103.6, the new Norlina siding is proposed to end at MP S102.

Greystone Siding

The north end of the next siding south of Norlina should begin in the vicinity of MP S112-113. A former signaled siding began at MP S112.5; that location would be ideal except the new siding would extend through Henderson with its many highway crossings. A non-signaled Greystone siding exists between MP S109.5 and MP S110.9.

Because of the closeness to the Norlina siding, it is proposed that only a 2.4-mile Greystone siding be installed between MP S108.9 to MP S111.3 mostly using the current siding. This siding would take place of the one that should be at Henderson.

Kittrell Siding

The north end of the next siding south of Greystone should begin in the vicinity of MP S121-122, 10-11 miles from Greystone. A formerly signaled siding at Kittrell extends from MP S121.9 to MP S123.5. It is proposed to reuse the current siding but extend it its limits to cover the area between MP S121 to MP S124.8.

Youngsville Siding

The north end of the next siding should begin in the vicinity of about MP S134-135. A formerly signaled siding at Franklinton extended from MP S129 to MP S130.5, but that siding is too close to Kittrell. However a non-signaled siding at Youngsville extended from MP S135.3 to MP 136.6. It is proposed to reuse the Youngsville siding and extend its limits from MP S133.9 to MP S 137.9.

Neuse – Crabtree Siding

The north end of the next siding should begin in the vicinity of about MP148. The north end of a former double track, now removed, was at Neuse (MP S147.6). The double track extended for six miles to MP S153.9 at Crabtree. It is proposed that this double track be rebuilt.

Edgeton to Southern Jct

The single track between Crabtree and Edgeton on the S Line north of Raleigh Yard would remain because a major bridge over Crabtree Creek can accommodate only a single-track. However, double track would be restored between Edgeton (actually south of the Edgeton curve (Curve S154.1) and Southern Junction. The restoration of this double-track would be essential to provide for efficient train movements throughout Raleigh. The south entrance to CSXT Raleigh Yard, located south of MP S156, would have hand-operated switches but the lead to the NCDOT Yard off S Line Track 1, located at Peace Street, would be interlocked to facilitate Richmond to Charlotte passenger train movement. Northward trains to both CSXT Raleigh Yard and the NCDOT Yard would operate on Track 1 between Southern Junction and the switches leading to the CSXT Raleigh and NCDOT yards.

Triangle Transit Authority has developed a phased plan that involves the development of a Regional Rail system supported by shuttle and local bus service. This service, planned to be operational by 2007, would use self-propelled, bi-directional, diesel rail cars using a separate rail line constructed within the existing railroad rights-of-way to connect Durham, RTP, Morrisville, Cary, Raleigh and North Raleigh. The joint utilization of the freight rail corridor will require ongoing coordination between freight, intercity rail, and transit personnel.

Southern Jct to Ashe

A series of track and interlocking improvements to facilitate passenger and freight operations through the existing Boylan Interlocking and the new Raleigh Station to serve proposed intercity operations, which would be located west of the existing Boylan Interlocking, the crossing with the old Norfolk Southern Railway to Varina would be constructed. The improvements would include:

- Reconfiguration of the crossovers between Tracks 1 and 2 at Southern Junction, located on the S Line west of the entrance to Glenwood Yard;
- Construction of a new Track 4 between Boylan Interlocking and Southern Junction Interlocking;
 - Track 4 would predominantly serve freight trains, but also could be used for passenger trains;
- Removal of the rigid crossing frogs at Boylan Interlocking and installation of a new interlocking to facilitate train movements displaced by the removal of the crossing frogs;
 - The new interlocking would provide the same progressive route that the crossing currently provides from Glenwood Yard through Raleigh to Varina on the original NS Railway;
 - The revised configuration would enable adequate spirals and superelevation to be installed in the ten-degree curve between Boylan and Hargett Street on the S Line. Speed on the 10-degree curve would be raised from the current 10 mph to 30 mph on tracks 1 and 2;

- Construction of a new Track 4, a third track south of Boylan Interlocking, which would be configured to accommodate the proposed station; and
- Construction of a new interlocking, Ashe (for Ashe Avenue) to facilitate train operations south of the new station.
- The station would consist of: a low-level, 24-foot wide center-island platform located between Tracks 2 and 4, and a second platform located adjacent to Track 1.

Route Realignment/Augmentation - H-Line: Raleigh To Greensboro

The North Carolina Railroad owns the 81-mile corridor segment between Raleigh and Greensboro. The 12-mile portion of the line between Raleigh and Cary, Fetner Interlocking, consists of a pair of single-track lines operated by NS and CSXT. CSXT trains cross the NS at Fetner to access the Aberdeen Subdivision to Hamlet. The remainder of the H Line to Greensboro essentially is single-tracked with passing sidings.

The alignment has numerous sharp curves, steep grades, and grade crossings. The controlling grade is -1.16 percent, between mileposts H38 and H39. TPC simulations reveal that freight trains ascending this grade decelerate to as slow as 11 mph. The line passes through numerous cities and small towns, Durham being the principal city. Existing sidings are located at:

- Durham,
- Funston,
- Efland,
- Mebane, and
- McLeansville.

The sidings are short, normally less than two miles, and are accessed through hand-thrown switches whose use is authorized by the dispatcher.

Fifty-nine mph is the existing MAS for passenger trains and forty-nine mph is the maximum for freight trains. There are numerous slow speed areas as the result of curvature and grade crossings. The line would be upgraded to have a 110 mph MAS. However, although passenger trains speeds would be increased throughout the line, numerous restricted speed locations would remain.

Traffic on this portion of the line would increase greatly:

- The number of passenger trains is expected to increase from four passenger trains per day to eighteen passenger trains per day.
- The number of freight trains is expected to remain about the same - approximately six or seven freight trains per day.

Sidings spaced to minimize delays to passenger and freight trains would be located between Fetner and Greensboro to accommodate this traffic increase.

Fetner Sidings

A siding would be installed just south of Fetner on the CSXT Aberdeen Subdivision. The siding would serve as a location where trains to and from the Aberdeen Subdivision may meet. If, for example, an eastbound freight train was to meet a westbound freight train at Fetner, the eastbound train can be held on the siding allowing the westbound train to easily access the lines, minimizing main line delays. The siding would be located so that a freight train occupying the siding would not block any of the grade crossings located just south of Cary Station.

Reconfigure Fetner Interlocking

Located at the junction of the H Line and the CSXT Aberdeen Subdivision, the interlocking enables CSXT trains on the CSXT owned track between Raleigh and Fetner to access the Aberdeen Subdivision and NS trains on the H Line track to access the H Line south of Fetner. The existing interlocking would be reconfigured to facilitate these train movements. A 1000-foot tangent would provide room for the interlocking between the two curves at Fetner. The interlocking can be reconfigured independent of the work on the Fetner or Cary Sidings.

Cary Siding

The Cary passenger station is located between Henderson and Academy Streets at MP H72.6. A 3.6-mile siding would be located just west of the station and would extend between MP H72.6 and Crabtree Creek at MP H69. Two highway crossings, one public and one private, would be located within the limits of the siding. The public crossing, Morrisville Blvd would have to be grade separated because of superelevation in both the Main track and the siding. The siding would not extend into Fetner Interlocking. It was anticipated that the siding would be used primarily by freight trains. The sidings provide locations for slow moving southward freight – climbing the four miles of significant grade south of Boylan, to be overtaken by a passenger train. The siding also would provide capacity to store a northward freight train if the route between Fetner and Raleigh was congested because CSXT and NS freight trains were occupying the tracks.

Brassfield Siding

A 3.5-mile siding between a new Brassfield Interlocking and a reconfigured East Durham Interlocking would enable freight trains to set off or pick up from Durham Yard without blocking the main track of the H Line.

The new siding would be provided on the east side (geographically west) of the current main track between Brassfield and East Durham. The existing track would not be realigned to improve speed through several short two-degree curves but rather the new main track be built with three 110 mph 1.5-degree curves (H56, H57, and H58). It is proposed that the existing tracks not be realigned at all but rather the new main track be built with the three proposed 1.5-degree curves good for 110 mph. The siding tracks, - could be good for 90-mph, but that would serve no real purpose because of the 45 mph entry and exit speed to the siding tracks.

A siding does not exist to enable a freight train to set off or pick up from Durham Yard without blocking the main track of the H Line. The yard is heavily used and appears to have very little remaining capacity. Therefore, a new main track would be provided on the east side (geographically west) of the current main track, which would become a passing siding. The existing siding would be extended north to Brassfield to provide additional capacity and provide a location for freight trains to stand or work independently of passenger trains.

The current configuration requires that working trains occupy the Main track. The south siding switch, actually a crossover, would be located at MP H56.9, the location where the CSXT Apex Line crosses the H Line. An existing, apparently unused siding would be upgraded to provide a tail track to facilitate switching at the south end of the yard clear of the main track. One Main track (the new track) and two sidings would extend between Brassfield (MP H60) and South Durham MP H56.9). The largest segment of track in these sidings without highway crossings would only be approximately one mile.

Durham Siding

Durham passenger station would be relocated to MP H54.8. A siding to enable passenger trains to meet would be installed between East Durham and West Durham Interlockings. The simulated schedule does not have passenger trains normally meeting at Durham; however, future schedules may include this meet. This siding would have numerous highway crossings located within its limits.

Funston-Glenn Siding

The north end of the next siding should begin in the vicinity of MP H50. The north end of the existing Funston-Glenn Siding would be at MP H49.7; the north end of the siding would be located at the south end of the Curve H49, a two-degree curve. The current south end of the existing Funston siding is at MP S48.5 and the siding would be extended southward to MP H44.1 to South Glenn and would include the short siding at Glenn MP H46.3, which is where the branch to Carrboro (Chapel Hill) joins the H Line. Wye tracks connect this siding to the branch track. The Funston end of the siding approximately has a two-mile stretch free of highway crossings.

The south end of the siding coincides with the south end of the recommended solution to reduce the curvature of Curve H44.1; an 11,000-foot relocation that would increase MAS to 100 mph or greater. The relocation would begin near the NC10 underpass west of the current west end of Curve H44.1 and would cut directly across Stony Creek valley on a 50-foot fill. It is estimated that about 800 feet in distance would be saved. The existing main track would remain in place as the siding and the newly constructed track would be the main track. The new track would bridge over the branch to Chapel Hill and an existing highway intersection would pass over the relocated track. There would be no connection between the new Main track and the Chapel Hill Branch.

Efland-South Mebane Siding

It is recommended that the existing Mebane siding, located between MP H31.6 and MP H32.4, be extended northward to include the existing siding at Efland (MP H36.7 to MP H37.5). A curve reduction at Efland would allow the existing Main track to

become the new siding at that location. The extension would result in a 5.9-mile long siding between MP H31.6 and MP H37.5. However the south end of the Mebane siding would be closer to the north end of the proposed Burlington Siding than ideal. The north portion of the siding has a stretch over two miles without a highway crossing.

Mebane Interlocking would be constructed at MP H34 and would serve to facilitate the meeting of three trains within the siding.

Route Realignment/Augmentation – Haw River Siding

Applying the 10-11 mile spacing between siding switches criterion, indicates that the south end of the next siding from McCleansville (to be described next) should be at MP H22-23. That places the switch south of the Burlington passenger station. A siding does not exist at this location; therefore, a totally new siding called Haw River would be placed between MP H21.7 and MP H25.4. This siding cannot extend further north because it would involve reconstruction of the bridge over the Haw River. Besides, the north end of this siding would be only 6 miles from the south end of the proposed Mebane siding. Simulations show that numerous passenger trains would meet at this siding during each day. Approximately a two-mile stretch in the north portion of the siding and a 1.5-mile stretch at the south end of the siding would be free of crossings.

Pomeroy Street crossing is located in **Curve H23** and the turnout to Cannon Mills, an active industry, comes off the high side of this curve, it is recommended that the current main track become the siding. This would enable the industrial switch to come off the siding with less superelevation than the main track and the new main track would be constructed north of the current main track with appropriate spirals.

McLeansville Siding

An existing siding at McLeansville extends between MP H9.8 and MP8. It is recommended that the siding be extended northward to MP H11.8 and southward to MP H 7.8 to create a four-mile long siding. This siding would have an interval of about 1.6 miles where a freight train can stand without blocking any highway crossings.

English Siding

A new passing siding, English, would be installed from English Street at MP H1.7 to an upgraded Piedmont Line Track 3 at MP H0 in Greensboro. Two highway at-grade crossings would be located in the siding, and they may have to be modified to accommodate the siding, closed, or separated. The siding would be configured to accommodate the relocated Greensboro Station. The main H Line track would be relocated and connected to Piedmont Main Track 1 with a Number 20 Turnout. The siding track would connect to Track 3.

Route Realignment/Augmentation – Charlotte To Greensboro

Elm to Cox

Elm Interlocking would be reconfigured and all crossovers would be Number 20s. Parallel routes would be provided so that trains to and from the H Line can make simultaneous moves.

It is assumed that reinstalling the double track between Cox and Hoskins Interlockings, the following project, would be completed prior to this improvement. Therefore, the Elm to Cox improvements only would include the addition of a right-hand Number 20 Turnout that would provide access to Track 3, which would be extended southward from the Rail Street grade crossing. Track 3 formerly extended further south than it does today, therefore the extended track would be constructed where a track once existed. The new turnout at Cox would provide northward freight trains interlocked access to Track 3 at 40-45 mph. Signaling on Track 3 would extend northward to the Intermodal Terminal at MP 287.2. From that point to Aycock Street, MP 285.5, Track 3 would not be signaled; it would be operated under yard rules under control of a yardmaster. Signaling Track 3 as a main track between these points is not recommended.

The new number 10 crossovers and turnouts at Pomona Interlocking would be located on tangent track. The configuration should fit between existing signals. Signaling would indicate whether the number 20 crossover or the number 10 crossover between Track 1 and Track 2 is set to provide the diverging movement. Diverging clear or diverging approach aspects would be displayed only when the 45 mph crossover is reversed. Most likely, a restricting aspect would be used to indicate when the route containing a number 10 turnout or crossover is to be used.

The hand-operated number 10 crossover between Tracks 3 and Track 1 near the Intermodal Terminal would be relocated northward into the interlocking in the vicinity of Holden Road. The low signals in Track 3 would normally display restricting for yard moves. The train dispatcher would require the permission of the yardmaster to take control of these low signals adjacent to Track 3. Thus, the dispatcher would not be concerned with movements on Track 3 until he/she needs to use the crossover.

Cox to Hoskins

Presently Cox (MP 289.3) is the north end of a single-track segment extending to Hoskins (MP 298). It is recommended that double track be restored between Cox and Hoskins. Cox Interlocking would be relocated and reconfigured. Because of the large number of trains (about six a day) that would be diverting from Track 1 to Track 2 at Cox to use Track 2 between Cox and Elm, a left-hand Number 32 crossover good for 80 mph would be installed in Cox Interlocking. Hoskins would be made universal with two number twenty crossovers.

Thomas (MP 307) to Lake (MP 314)

The double track from south of Hoskins presently extends southward to Bowers (MP 309.8). The five-mile segment between Bowers and Lake (MP 314) presently is single tracked. The double-track segment between Bowers and Lake would be reinstalled.

The north end of one of the three high-speed passing sidings between Greensboro and Charlotte would be installed between MP 307, south of Thomasville, and Bowers. Bowers Interlocking would be relocated to MP 311.4, north of a two-degree curve. Bowers would be configured to provide universal move capabilities with number twenty crossovers. Lake, located three miles south of MP 311, would be

eliminated. The high-speed passing siding would be located between both main tracks. Forty-five mph crossovers would provide access for northward and southward trains to the center siding. The north end of the siding would be called Thomas. In addition to the number twenty turnouts to/from the siding, the new Bowers interlocking would also have a pair of number twenty crossovers between the main tracks. The new center siding would enable faster passenger trains to overtake slower moving freight trains without having to divert to the opposite track and then back again in the face of opposing traffic.

Yad (MP 328.6) To Salisbury (MP 333)

The second of the three high-speed passing sidings between Greensboro and Charlotte would be installed between Yad (MP 328.6) and Salisbury (MP 333).

Yad Interlocking, a new interlocking, would be located south of Curve 329, the north end of which abuts the Yadkin River Bridge.

The existing crossovers in the current Saljct interlocking are sandwiched between curves. Therefore a portion of the interlocking would be relocated northward about 1500 feet to ensure that turnouts and crossovers are on straight track. However, because several curves in Salisbury have highway crossings in them, it is proposed to maintain the current superelevation and alignment and restrict the speed to 70 mph through the city of Salisbury.

Saljct Interlocking

Reverse curves on Tracks 1 and 2 At Saljct appear to off set the two main tracks one-track center space. Therefore, the yard track adjacent to the present Track 2 would be aligned into the existing Track 2 creating a nearly straight track north of MP 333, eliminating the reverse curve in Track 2. Most of the current Saljct interlocking is located on a short tangent south of MP 333.

Saljct Interlocking would be reconfigured to locate the interlocking north of the reverse curve. The Asheville Line tracks would be extended northward and parallel 30 mph routes would be provided to enable northbound and southbound Asheville Line freight trains to operate simultaneously. The primary southbound Asheville Line route would consist of

- A right-hand number 15 crossover between the center siding and Track 2, and
- A right-hand number 15 turnout leading to Asheville Line.

A left-hand turnout from the southbound Asheville Line track would provide a connection to the northbound Asheville Line track.

A right-hand number 20 crossover from Track 1 to the center siding would be located immediately north of the number 15 crossover.

The primary northbound Asheville Line route would consist of:

- A right-hand number 15 crossover between the northbound Asheville Line track and Track 2, and
- A number 20 crossover between Track 2 and the center siding.

The parallel connections to the Asheville Line would enable a northbound Asheville Line freight train to access the center siding⁸ while a southbound Asheville Line freight train access the southbound Asheville Line from Track 2.

A left-hand number 20 would provide access from Track 1 to the center siding. A left-hand number 20 crossover would provide access from the center siding to Track 1

Connections to the yard would be a number ten turnout and a number ten crossover.

South Salisbury and Salisbury Station Configurations

The speed on the south Wye at Salisbury is only ten mph. A number 10 Turnout connects the south leg of the Salisbury Wye⁹ to Track 2 of the Piedmont Main Line at Kerr Street (MP 333.5). Currently one passenger platform exists along Track 2 between Kerr Street and Council Street, therefore every northward passenger trains stopping at Salisbury would have to operate left-handed on Track 2 between Sumner (MP 339.3), a new Interlocking described in a subsequent project and at least Saljct (MP 333). That practice would be unsatisfactory for future operations. Therefore platforms would be located adjacent to both Tracks 1 and 2. The current left-hand crossover between Tracks 1 and 2 would be moved southward out of the station area to south of Innes Street (MP 334.9). It would be a number twenty crossover good for 45 mph.

Provisions would be made to add new Tracks 4 and 6 in the station area to accommodate future commuter trains or Asheville trains, these tracks would not be built until such service is implemented.

Yadkin Junction at MP 334.5, which is about one mile south of Salisbury Station, consists of a run around track adjacent to Track 1 and a hand operated turnout to the former Yadkin Railroad now the NS N Line. One train per day has been assumed to operate to and from the branch. No change is proposed for this location.

Reid (MP 337.3) to North Kannapolis (MP 347.4)

Salisbury to Reid, MP 337.3, presently is double tracked. Reid to North Kannapolis, MP 347.4, presently is single tracked. A number of active industries are located on the single track. Most likely local freight trains either have difficulty obtaining track time to do their work or freight trains are held to give local trains time to work, double track would be necessary if this problem is to be minimized. It is recommended that the double track between Reid and North Kannapolis be restored to minimize the local service freight problem, when passenger service is increased. This segment of double track construction would have a high priority.

Saljct (MP 333) and Reid (MP337.3) are four miles apart, while Reid and North Kannapolis are located ten miles apart. Consequently, Reid is too close to Saljct and

⁸ The right-hand number 20 crossover would enable the northbound train to crossover to Track 1, if necessary.

⁹ The south Wye apparently is quite sharp; according to the employees' timetable the use of dynamic brakes is prohibited.

too far from North Kannapolis. Therefore it is recommended that Reid interlocking be relocated to a point about midway between Saljct and North Kannapolis, approximately MP 339.5. The new interlocking would be called Sumner.

Kannapolis (MP349.5) to Adams (MP 354.1)

North Kannapolis (MP347.4) to Haydock (MP360.1) currently is double tracked. Kannapolis and Concord are located in this segment. Interlocked crossovers at Adams (MP 354) are located approximately midway between North Kannapolis and Haydock. It is recommended that the third of the three center sidings between Charlotte and Greensboro begin at MP 349.5, at the north end of the long one-degree curve (East C Street), and end at Winecoff School Road at MP 352.9. C Street, formerly the southernmost grade crossing in Kannapolis, has been removed. The siding is much shorter than desired, however, the 317-foot bridge over I-85 prevents the end of the siding from being extended farther south to Adams.

Adams is located exactly where the siding should end, but rather than having an interlocking at MP 353 and another at MP 354, Adams would be relocated northward one mile to MP 352.9. Placement of the interlocking at MP 352.9 would not be easy. The left-hand crossover between Tracks 1 and 2 would be placed north of the bridge over I-85 and the crossovers and turnout providing access to the center siding would be located north of Winecoff School Crossing. The widening of the two main tracks to make room for the center siding would be accommodated by a redesign of Curve 306, a one-degree curve south of the crossing. The left-hand crossover providing access to the center siding from Track 1 and the right-hand turnout providing access to Track 2 from the center siding would be installed adjacent to the Winecoff School crossing. A right-hand crossover between the center siding and Track 1 would be installed north of these turnouts. Despite the short length of the siding a clear space of nearly two miles would exist so that a freight train can be held without blocking any highway crossings.

Haydock (MP360.1) to Junker (Existing at MP 371.2)

Haydock to Junker (MP 372.2), a distance of about twelve miles, currently is single tracked. It is proposed that double track be restored between Haydock and Junker. The segment between Adams and Junker is about eighteen miles therefore it is recommended that an interlocking **Shamrock**, consisting of a double crossovers, be located about half way between those locations, at about MP 363, just north of Shamrock Road. It is proposed that Haydock interlocking be removed when double track is restored.

Junker (Proposed new at MP 372.2) to AT&O Jct (MP 375.3)

A third track, new Track 3, would be installed between Junker Interlocking (MP 372.4) and A.T. &O Jct (MP 375.3). Junker Interlocking would be configured to enable southward freight trains to enter Track 3 at 45 mph. Track 3 also would provide a holding location for a southward freight train to wait short of the yard without blocking Track 2. This is essential to facilitate the operation of 17 daily southward intercity and commuter passenger trains.

AT&O Jct (MP 375.3) to North End Charlotte Station (MP377.5)

Northward Freight Track

The yard track adjacent to Main Track 1, called Track 3, would be upgraded to serve as the northward freight-working track. Northward trains would enter Track 3 at a new interlocking (named Stadium because of its location next to Erickson Stadium, described in a subsequent project) immediately south of the proposed new passenger station. Northward freight trains then proceed to their working location near MP 375.5 without interference from or interfering with other NS freight trains or passenger trains. However, they would have to cross the CSXT tracks at grade, at Graham Interlocking. The northward freight train working location is about 7,500 feet from the CSXT crossing; so nearly all trains should be able to work with the rear of the train clear of the CSXT at-grade crossing. However, Lidell Street may be blocked. The potential of closing or eliminating this crossing should be evaluated. Northward working freight trains that arrive before the previous working train departs would wait south of the CSXT crossing, leaving the crossing clear for CSXT trains. Over 25 CSXT moves per day, including yard moves, would use the crossing.

A.T. & O Jct would be reconfigured to enable freight trains to access Track 1 at 30 mph upon completing work. A new interlocked crossover from Track 3 to Track 1 would replace an existing hand operated crossover between the yard and Track 1. Two right-hand crossovers between Tracks 3 and 1 and Tracks 1 and the yard track adjacent to Track 3 would be removed. Since northward working freight trains would no longer occupy the Main Tracks, these crossovers would no longer be needed. A pair of crossovers, located between Tryon Street and Lidell Street, between the same tracks would remain for emergency use.

Southward Freight Track

A new connecting track leading southward out of AT&O Jct. would parallel the switching ladder at the north end of the yard so that standing or arriving working freight trains would not block switching operations.

The new connecting track would tie into the existing easternmost track in the yard, which is adjacent to the Intermodal Terminal, and would be upgraded to become a new running Track 4 between A.T. & O Jct. and Tryon Street.

The rear of a long southward freight train working at Charlotte Yard would be at, or north of, A.T. & O Jct; which is the reason that Track 4 would be isolated from the switching lead. Track 4 would become Track 1 at Stadium Interlocking, south of the proposed Charlotte passenger station.

The configurations described would enable northward and southward freight trains to set-off and pick-up at Charlotte, without conflicting with each other. The goal of enabling passenger trains and non-working freight trains to have their own tracks would be achieved.

Tracks 3 and 4 would be signaled between Stadium Interlocking and Tryon Street. Track 3 would have a 30 mph maximum speed between Stadium Interlocking

and A.T. &O Junction. The hand-operated crossovers south of Tryon Street would be electrically locked. All switches on Northward Freight Track 3, between Tryon Street and A.T. &O, Jct would have switch locks installed to enable the 30 mph MAS to be established between Tryon Street and A.T. &O Jct. Eliminating the yard speed on Track 3 and increasing MAS to 30 mph would enable long trains that have finished their work to accelerate to 30 mph prior to accessing the Washington to Atlanta Main Line.

Charlotte Station, 6th Street Interlocking to Stadium Interlocking

Charlotte Passenger Tracks And Passenger Station

Charlotte Station, located at MP 377.9, would consist of three tracks west of Track 3. Tracks 1 and 2 between A.T. &O Junction and Stadium would be the passenger tracks through Charlotte.

At this time, only three station tracks are planned. Two additional station tracks may later be placed east of Track 4 for a possible commuter service entering from the CSXT. A second at-grade crossing over the CSXT, at Graham, may be restored to provide access to the former O Line to Monroe, for additional commuter service. Freight trains that pick up or set off at Charlotte would not use the passenger tracks.

Stadium interlocking, just south of Charlotte Station, would be arranged so that freight trains can move in parallel to and from Tracks 3 and 4. It is assumed that most southward freight trains going to Columbia would operate left handed between Stadium and Charlotte Junction (3.5 miles).

Charlotte Station to Charlotte Airport

Extending high-speed trains from Charlotte Station to the Airport Station would provide access to Charlotte Airport. The Airport Station would be located adjacent to the Airport Freeway. Just south of Little Rock Road a loop track for turning trains terminating at Charlotte would diverge westward from the southbound main track, passing over both main tracks and rejoining the northbound main track. The Airport Station would consist of platforms adjacent to Tracks 1 and 2.

Two Washington to Atlanta trains entered/departed the SEC at Greensboro; these trains also stopped at the Airport Station.

A left hand Number 15 turnout at North Advance will be upgraded to a Number 20 Turnout to improve access to the NS line to Columbia, SC from the Piedmont Main Line.

Commuter Rail Service to the Airport Station

Three of the seven commuter trains from Concord each morning turned back to Concord for a second trip. Thirty-minute headways from Concord for this service were assumed. If these trains operated to the Airport they would not be able to return to Concord for a second trip and additional equipment sets would be required. Layover facilities in Charlotte for day storage of commuter trains have not yet been identified. It was assumed that over night facilities will be provide somewhere near Adams Interlocking.

Maintenance and Layover Facilities

NCDOT Raleigh Storage Yard and Servicing Facility

The existing facilities, located adjacent to the S Line between Southern Jct and Edgeton, would be expanded and upgraded to accommodate the increased level of daily passenger service, five round trips instead of the one presently operated, between Raleigh and Charlotte.

Charlotte Storage Yard and Servicing Facility

An efficient storage yard and maintenance facility in the vicinity of Charlotte Airport Station to store trains both during the day and overnight, enable various equipment cleaning functions to be performed, and accomplish assigned maintenance functions. The facilities would ensure that passengers traveling northward from Charlotte are provided safe, reliable, and clean trains. The new passenger storage and servicing tracks would be just south of Little Rock Road east of the northbound main track. Three equipment sets are projected to layover at night at the Airport.

The storage yard would provide sufficient yard storage capacity to handle overnight layovers for trains scheduled to depart Charlotte the next day, and to store equipment scheduled for maintenance. Additional space should be preserved for future Charlotte to Atlanta service.

Station Improvement Projects

The provision of marketable (and potentially profitable) station facilities, parking, and amenities will merit careful attention and focused investment in the preparation of a development plan for the Southeast Corridor. Stations represent the beginning and end of each passenger's experience with the railroad and as such will play a significant role in providing improved passenger service in the Southeast Corridor. Stations will serve as the focus for local participation and investment, as an image-builder for train service, and as an enhancement to passenger comfort and convenience.

This study has emphasized train operations and related facilities, and therefore has confined itself to identifying only a few of the many issues related to stations; cost estimates for all station improvements have not been developed. The corridor partners will, however, need to devote significant resources to this topic if rail service in the corridor is to be optimized.

Stations

Although several stations have benefited from recent refurbishment efforts, certain of the stations in the corridor would have to be upgraded to conform to track alignment enhancements and to properly attract and accommodate the increase in traffic made possible by the high-speed service. Marketing studies would be needed to properly direct station investments and train schedules at these locations.

Upgrade Petersburg Station

The present station has one platform, on the north or eastbound track. The construction of a new S Line track on the west side of the existing tracks through the

station would require that a second platform, adjacent to the S Line track, be constructed¹⁰.

Restore Henderson Passenger Station

Passenger service to Henderson ceased when Amtrak discontinued limited service on the S Line in the late 1980s. Restoration of passenger service would require construction of station and platform facilities.

Raleigh Station

Neither the present Raleigh station nor the old Seaboard station, located in North Raleigh on the S Line, would be used. A new multi-modal terminal (serving bus, TTA, long distance bus, taxi, auto, etc) would be located west of existing Boylan Interlocking, the crossing with the old Norfolk Southern Railway, to Varina. A new interlocking, Ashe (for Ashe Avenue), would facilitate train operations south of the new station. A low-level, 24-foot-wide center-island platform would be located between Tracks 2 and 4; and a second platform would be located adjacent to Track 1. The simulation revealed that the platform configuration and the adjacent interlocking were shown to have important capacity implications.

New Amtrak Station - Durham

In July 1996 the City of Durham and the NCDOT opened a new interim station downtown. The station replaced a small bus-type shelter that served the City for six years. A new multi-modal center, with an island platform for intercity passenger service, is planned for Durham in the vicinity of the old Liggett & Myers Tobacco Company. The site is located alongside the longest section of track unbroken by city streets in downtown. The multi-modal center will be adjacent to several other historic buildings that are being refurbished for residential, entertainment and office use.

Relocated Greensboro Station

The relocated Greensboro passenger station would be placed where the former Southern Railway station is situated in Greensboro, just east of Elm Interlocking. Two low-level island platforms would be provided. One platform would be between the NS Main tracks and the other would be between the H Line and English Siding, described in the discussion of the H Line. A walkway under the main tracks would connect the two platforms. Once the station is reactivated and the new platforms and pedestrian access structures constructed, passenger trains would no longer stop in Pomona. The English Siding would be configured to access the H Line platform.

I-485 Station – North of Charlotte

The Richmond to Charlotte corridor study identified the need for a beltway station to be located north of Charlotte in the vicinity of MP P367 where I-485 passes over the rail line. University City Boulevard parallels the rail line at this location. The station would be used by intercity and commuter passengers. The benefit to both modes of the

¹⁰ Alternative routes through Petersburg are presently under evaluation as part of a study to extend high-speed rail service to Norfolk.

interface of rail passenger service and major regional highways has been successfully demonstrated at New Carrollton station located north Washington. The rail station constructed in the early 1980s has proven to be an effective traffic generator.

Convenient access to I-485 would be provided. The station would serve the rapidly developing area north of Charlotte. It was assumed that all Richmond to Charlotte and Raleigh to Charlotte trains would stop at the station. Proposed Concord to Charlotte commuter trains also served the station.

Charlotte Airport Station

The benefit to both modes of the intermodal interface of high-speed rail and regional air service has been effectively demonstrated at Baltimore Washington International (BWI) Airport, located between Baltimore and Washington. The BWI Airport Rail Station, constructed in the early 1980s, has proven to be an effective traffic generator of air-to-rail and rail-to-air transfers.

The success of the BWI connection has resulted in the planning for a similar connection at Greene Airport in Providence, RI, and led to the recommendation that an intermodal rail-air station be constructed adjacent to Charlotte Airport. The airport is located approximately six miles southwest of downtown Charlotte, adjacent to the NS Washington to Atlanta Main Line.

Extending high-speed trains from Charlotte Station to the Airport Station would provide this interface. The extension requires that a servicing and storage yard be constructed south of the Airport Station, which would be located adjacent to the Airport Freeway. Just south of Little Rock Road, a loop track for turning trains terminating at Charlotte would diverge westward from the southbound main track, passing over both main tracks and becoming parallel to the northbound main track. The new passenger storage and servicing tracks would be just south of Little Rock Road, east of the northbound main track.

Other Stations: Burlington, High Point, Kannapolis, and Cary Stations

Various improvements to accommodate the projected intercity service levels may be necessary at each of these stations.

Americans with Disabilities Act (ADA) Issues

The ADA requires reasonable accommodation of the needs of the disabled. To implement the transportation provisions of ADA, the U.S. Department of Transportation has issued rules that require all Amtrak stations to meet ADA standards by 2010, with the exception of flag stops. These standards include: accessible routes, signage to include Braille, full accessibility to both north- and southbound platforms, new platforms with tactile edging and striping, modified ticket counters, updated public address and telephone systems, and accessible restrooms.

To meet these standards, various improvements would be implemented at Amtrak stations, including but not limited to: new platforms, new lighting and canopies, and improved public address systems. These actions would make all Amtrak stations, fully accessible to disabled passengers.

While assuming that Amtrak, NCDOT, and VDRPT will accomplish the ADA modifications, this study has not identified the related costs.

Station Platforms

Low-level platforms are assumed to be constructed or to be upgraded at all stations, which generally handle lower volumes of intercity passengers. Provision for future high-level platforms, when justified by ridership, should be included. The installation of audio and visual warnings of approaching trains is recommended at locations where non-stopping train speeds would exceed 45 mph.

The cost of the platforms is included in the projects identified for Petersburg, Henderson, Raleigh, Greensboro, Salisbury, I-485, Charlotte Station, and Charlotte Airport Station. Requirements at other stations were not evaluated as part of this study.

Parking

Enhanced train service would necessitate expanded parking facilities at existing intercity stations along the Corridor. Parking at existing stations most likely would not accommodate the projected passenger volumes. Follow-on planning and design work would project the number of spaces needed at each.

New stations serving intercity traffic (for instance, Charlotte I-485) would, of course, need parking facilities, which the design phase for these facilities would identify.

Station/Parking Access

Automobile access to existing and proposed station facilities also will have to be evaluated as part of the follow-on planning and design work.

Grade Crossing Improvements

Increasing speeds and the frequency of trains raises concern for safety at the numerous public and private at-grade highway crossings on the rail lines between Richmond and Charlotte. All of the public crossings are protected, at a minimum, by crossbucks, flashing lights, gates, and ringing bells.

Protection and Elimination

The VDRPT has an on-going program to identify crossings that can either be:

- Eliminated, through closing them:
- Separated, through construction of a bridge or underpass; or
- Improved, through the installation of more extensive and more highly visible protection devices.

Decreasing grade crossing hazards is an essential element of ensuring safety in implementing HSGT on existing lines. Virginia received about \$4 million under Section 1010 of ISTEA for high-speed rail grade crossing improvements, and is eligible for additional funding under TEA 21 section 1103(c). Completed and planned grade crossing improvements north of Richmond to date include construction of a pedestrian

bridge and new roadway bridge at Featherstone in Prince William County, and the provision of Constant Warning Time systems at crossings.

In conjunction with development of the Southeast Corridor, NCDOT has instituted an innovative highway/rail crossing hazard elimination program known as the Sealed Corridor Initiative. Aided by Federal funding under the ISTEA and TEA-21 specialized high-speed rail grade crossing programs and the Next Generation High-Speed Rail Program, the Sealed Corridor Initiative aims at improving or closing every crossing along the North Carolina portion of the Southeast Corridor, thus helping to ensure safe high speed operation along the line. NCDOT has developed a comprehensive strategy for treating the different types of crossings across the route, with solutions including four-quadrant gates, longer gate arms, inexpensive median barriers, and video enforcement. Video surveillance at specific unimproved and improved crossings has provided incontrovertible proof that advanced highway-rail crossing protection systems, such as four-quadrant gates and median barriers, reduce driver "run-around" violations dramatically and thus significantly reduce the risk of train/auto collisions.

The Sealed Corridor Initiative serves as a model for grade crossing hazard elimination. With its program of technology installation, testing, and assessment, the Initiative is a prime example of a cost-effective, comprehensive, corridor-wide grade crossing treatment. This experiment has provided useful information to the FRA, the FHWA, and the other States as they work to enhance grade crossing safety on other emerging corridors.

Safety is a primary concern when raising speeds between Richmond and Charlotte. Higher speeds will require, at minimum, that the actuating circuits be lengthened to initiate warnings sufficiently in advance of the arrival of the faster trains. Faster trains take less time to traverse the length of the circuit, and reach the crossing sooner than slower trains. At crossings with fixed circuits, warning time must be set for the fastest possible train. This creates a potential problem, in that when a slow train approaches the crossing, the gates are held down for an inordinate amount of time. Some motorists lose patience with the situation, and drive around the gate at the risk of a collision.

Constant Warning Time circuits can offset this problem by automatically adjusting the length of the warning to a time appropriate to the speed of each individual oncoming train. The system has the ability to determine the speed of an approaching train, and initiate the crossing warning cycle so that a predetermined period of warning will have transpired when the train reaches the crossing, regardless of the train speed

A new innovation, which could be applied at selected crossings, is a system of four-quadrant gates, wherein four gates, instead of two, are lowered across the traffic lanes, blocking both directions on both sides, and barriers are placed down the center of the roadway. This system prevents a motor vehicle from driving around the gates after they are lowered. The possibility of closing additional crossings must also constantly be re-examined.

Effect on Speed on Crossings Located on Curves

Speed is a significant concern when considering increased speed on crossings that are located on curves. In numerous instances, an increase in superelevation would be necessary to attain the projected increase in speed planned over the crossings and reduce lateral “G” forces felt by the passengers.

With superelevation, the outside rail on each track on the curve is raised as much as six inches above the level of the inside rail. With a multiple-track crossing, which many crossings are and will be after the improvements, this means that there is a series of inclines to be crossed, one between the rails of each track, and a dip from the slope of one track to the next. There is also likely to be a slope upward to the tracks on each side, the one on the outside of the curve being significantly greater than the one on the inside of the curve. This is not practical on a heavily traveled road, and may require that these crossings be closed, or grade-separated. Analysis will be required to develop a recommendation for each crossing.

Grade Crossing Summary

With the introduction of more trains, many of which would be traveling at higher speeds, it is imperative that the effort be continued to eliminate as many crossings as possible, and increase protection on those that remain. Efforts to eliminate lightly used crossings, by finding alternatives, or other means, should continue. Separation of traffic at as many high-density crossings as possible must be achieved. Improved crossing protection should be installed at crossings for which separation cannot be justified.

Improvements Evaluated By Others

The Main Street Station Improvement project previously was evaluated by others and is incorporated in this report to ensure that projects impacting train operations or facility considerations are included. The cost of the track and interlocking improvements required to provide the capacity and achieve the desired operational flexibility are listed in a previous project.