



U.S. Department
of Transportation
**Federal Railroad
Administration**

RAILROAD TANK CAR NONDESTRUCTIVE METHODS EVALUATION

Office of Research and
Development
Washington, D.C. 20590

DISCLAIMER

This report is disseminated by the Association of American Railroads (AAR) and the Federal Railroad Administration (FRA) for informational purposes only and is given to, and is accepted by, the recipient at the recipient's sole risk. The AAR and FRA make no representation or warranties, either expressed or implied, with respect to this report or its contents. The AAR and FRA assume no liability to anyone for special, collateral, exemplary, indirect, incidental, consequential, or any other kind of damages resulting from the use or application of this report or its contents. Any attempt to apply the information contained in this report is made at the recipient's own risk.

REPORT DOCUMENTATION PAGE			<i>Form approved OMB No. 0704-0188</i>	
Public reporting burden for this collection of information is estimated to average 1 hour per response, including the time for reviewing instructions, searching existing data sources, gathering and maintaining the data needed, and completing and reviewing the collection of information. Send comments regarding this burden estimate or any other aspect of this collection of information, including suggestions for reducing this burden to Washington Headquarters Services, Directorate for Information Operations and Reports, 1215 Jefferson Davis Highway, Suite 1204, Arlington, VA 22202-4302, and to the Office of Management and Budget, Paperwork Reduction Project (0702-0288), Washington, D.C. 20503				
1. AGENCY USE ONLY (Leave blank)		2. REPORT DATE January 2002		3. REPORT TYPE AND DATES COVERED Scientific Report
4. TITLE AND SUBTITLE Railroad Tank Car Nondestructive Methods Evaluation			5. FUNDING NUMBERS	
6. AUTHOR(S) Gregory A. Garcia				
7. PERFORMING ORGANIZATION NAME(S) AND ADDRESS(ES) Transportation Technology Center, Inc. P.O. Box 11130 Pueblo, CO 81001			8. PERFORMING ORGANIZATION REPORT NUMBERS	
9. SPONSORING/MONITORING AGENCY NAME(S) AND ADDRESS(ES) U.S. Department of Transportation Federal Railroad Administration Office of Research and Development 1120 Vermont Avenue, NW Washington, DC 20590			10. SPONSORING/MONITORING AGENCY REPORT NUMBER DOT/FRA/ORD-01/04	
11. SUPPLEMENTARY NOTES Approved for Public Release; Distribution Unlimited				
12a. DISTRIBUTION/ABAILABILITY STATEMENT This document is available through National Technical Information Service, Springfield, VA 22161			12b. DISTRIBUTION CODE	
13. ABSTRACT An evaluation of nondestructive testing (NDT) methods, authorized for use in replacing the current hydrostatic pressure test for qualification or re-qualification of railroad tank cars, has been performed by the Transportation Technology Center, Inc. (TTCI), a subsidiary of the Association of American Railroads (AAR). The project was accomplished through funding provided by the Federal Railroad Administration (FRA) and cooperative efforts from the tank car industry. The accomplishments made with this government/industry effort include; 1) the base line evaluations of four railroad tank cars using Department of Transportation (DOT)/FRA approved NDE methods; 2) the development of a validation methodology to assess new and existing NDE technologies; 3) the performance of a base line probability of detection (POD) evaluation of the transverse butt weld on a DOT 111A tank car design; and 4) the initiation of a defect library containing tank cars and sections of tank cars containing service and artificially induced defects. The accomplishments identified provide the railroad tank car industry as well as government, academic and commercial organizations with the tools to address the economic and reliability issues introduced with the HM 201 rule making.				
14. SUBJECT TERMS Acoustic emissions (AE), liquid penetrant (LP), magnetic particle (MP), radiography (RT), ultrasonics (UT), and visual testing (VT), probability of detection (POD), nondestructive evaluation (NDE), nondestructive testing (NDT), nondestructive inspection (NDI), damage tolerance			15. NUMBER OF PAGES	
			16. PRICE CODE	
17. SECURITY CLASSIFICATION UNCLASSIFIED	18. SECURITY CLASSIFICATION OF THIS PAGE UNCLASSIFIED	19. SECURITY CLASSIFICATION OF ABSTRACT UNCLASSIFIED	20. LIMITATION OF ABSTRACT SAR	

METRIC CONVERSION FACTORS

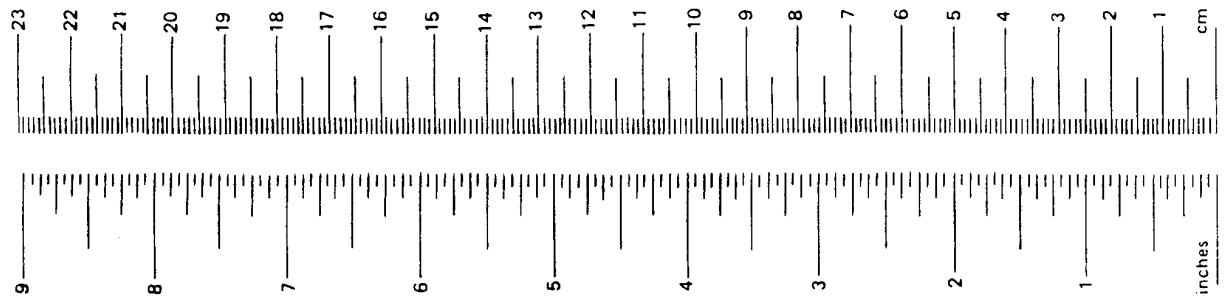

Approximate Conversions to Metric Measures

Symbol	When You Know	Multiply by	To Find	Symbol
LENGTH				
in	inches	*2.50	centimeters	cm
ft	feet	30.00	centimeters	cm
yd	yards	0.90	meters	m
mi	miles	1.60	kilometers	km
AREA				
in ²	square inches	6.50	square centimeters	cm ²
ft ²	square feet	0.09	square meters	m ²
yd ²	square yards	0.80	square meters	m ²
mi ²	square miles	2.60	square kilometers	km ²
	acres	0.40	hectares	ha
MASS (weight)				
oz	ounces	28.00	grams	g
lb	pounds	0.45	kilograms	kg
	short tons (2000 lb)	0.90	tonnes	t
VOLUME				
tsp	teaspoons	5.00	milliliters	ml
Tbsp	tablespoons	15.00	milliliters	ml
fl oz	fluid ounces	30.00	milliliters	ml
c	cups	0.24	liters	l
pt	pints	0.47	liters	l
qt	quarts	0.95	liters	l
gal	gallons	3.80	liters	l
ft ³	cubic feet	0.03	cubic meters	m ³
yd ³	cubic yards	0.76	cubic meters	m ³
TEMPERATURE (exact)				
°F	Fahrenheit temperature	5/9 (after subtracting 32)	Celsius temperature	°C

Approximate Conversions from Metric Measures

Symbol	When You Know	Multiply by	To Find	Symbol
LENGTH				
mm	millimeters	0.04	inches	in
cm	centimeters	0.40	inches	in
m	meters	3.30	feet	ft
m	meters	1.10	yards	yd
km	kilometers	0.60	miles	mi
AREA				
cm ²	square centim.	0.16	square inches	in ²
m ²	square meters	1.20	square yards	yd ²
km ²	square kilom.	0.40	square miles	mi ²
ha	hectares (10,000 m ²)	2.50	acres	
MASS (weight)				
g	grams	0.035	ounces	oz
kg	kilograms	2.2	pounds	lb
t	tonnes (1000 kg)	1.1	short tons	
VOLUME				
ml	milliliters	0.03	fluid ounces	fl oz
l	liters	2.10	pints	pt
l	liters	1.06	quarts	qt
l	liters	0.26	gallons	gal
m ³	cubic meters	36.00	cubic feet	ft ³
m ³	cubic meters	1.30	cubic yards	yd ³
TEMPERATURE (exact)				
°C	Celsius temperature	9/5 (then add 32)	Fahrenheit temperature	°F

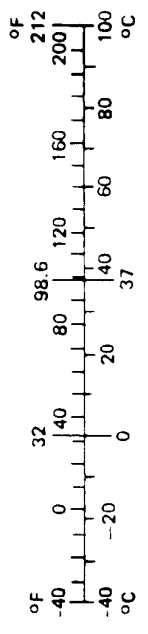

* 1 in. = 2.54 cm (exactly)

EXECUTIVE SUMMARY

An evaluation of nondestructive (NDE) testing methods used for structural integrity inspections of railroad tank cars was performed by the Transportation Technology Center, Inc. (TTCI), a subsidiary of the Association of American Railroads (AAR). The project was a cooperative effort, with funding supplied by the Federal Railroad Administration (FRA) and personnel, equipment, tank cars, and guidance provided by members of the tank car industry.

The focus of this project has been to provide direction and insight into the current capabilities of the industry in the use of the allowed NDE methods for tank car inspections. In cooperation with the FRA and the industry, the following has been accomplished:

- Baseline inspections of four tank cars have been completed using accepted NDE methods, to include acoustic emissions testing (AET), liquid penetrant (LP), magnetic particle (MP), radiography (RT), ultrasonics (UT), and visual testing (VT).
- A validation methodology for new and existing NDE technology has been developed to provide a uniform assessment of NDE technologies in the future.
- A probability of detection (POD) study has been performed on transverse butt welds providing a capability comparison of the allowed NDE methods.
- A defect library of full tank cars and sections of tank cars containing both artificial and service-induced defects has been initiated at the Transportation Technology Center (TTC) in Pueblo, Colorado.

These identified accomplishments provide the industry with the tools to address the economic and reliability issues introduced by the HM 201-rule making. By using the library of defects, along with the validation and POD methodologies developed, the industry can determine the reliability of inspections (which directly impacts improved safety) through technology development. The tools developed can also be used to help address industry needs in the areas of maintenance, inspection, and damage tolerance.

(blank)

Acknowledgements

The Tank Car Nondestructive Evaluation Project has been a true cooperative effort between the FRA, the AAR/TTCI, and the railroad tank car industry. Thanks to the following Tank Car NDE steering committee members and industry participants: Jose Pena and Gunars Spons (FRA Office of Research and Development); Jim Rader and Brenda Hattery (FRA Office of Safety); Larry Strouse, John Anderson, Dwaine Davidson, and Jerdon Veal of GATX; Paul Williams and Raymond Parker of Safety Railway Services; Lee Verhey, Paul Hayes, Randy Johnson, and Dan Snellgrove of Trinity Industries; Ed Andruszkiewicz, Tom Delafosse, Carl Hybinette, Alan Giffin, and Marty Riedlinger of Union Tank Car; Sam Ternowchek of Physical Acoustics Corporation; David Cackovic, Greg Giebel, Denzel Savage, Mike Sandoval, Mark Mauger and the TTCI Machine Shop; and Dave Hyndman and the RVM group of the TTCI. A special thanks to Ward Rummel for his input and guidance during the POD development phase of this project. His expertise has been invaluable. There were many more individuals involved too numerous to mention but the industry input has been greatly appreciated and a key to the success of this project.

“One test is worth a thousand expert opinions.”

From a sign donated to TTCI by the Southern Pacific Railroad
from their headquarters in San Francisco, California.

(blank)

Table of Contents

1.0	BACKGROUND	1
1.1	Program Steering Group.....	2
2.0	OBJECTIVE	2
3.0	PROCEDURES	3
3.1	Observation, Review, and Documentation of Prior Work.....	3
3.1.1	Industry-sponsored Tests.....	3
3.1.2	Literature Search.....	3
3.2	Baselining Current NDE	4
3.2.1	Defining Tank Car Criteria for Baseline and POD Testing	5
3.2.2	Baseline Testing	8
3.2.2.1	Structural Integrity Inspections and Tests	9
3.3	Developing a Validation Methodology.....	20
3.3.1	Liquid Penetrant Test Method	21
3.3.1.1	Summary	21
3.3.1.2	Technical Background	21
3.3.1.3	Applications	22
3.3.1.4	Railroad Tank Car Applications using Liquid Penetrant Testing	22
3.3.1.5	Technical Considerations	23
3.3.1.6	Status of Liquid Penetrant Testing in Current Tank Car Inspections	24
3.3.1.7	Recommended Future Applications in Tank Car Inspections	24
3.3.2	Magnetic Particle Test Method	24
3.3.2.1	Summary	25
3.3.2.2	Technical Background	25
3.3.2.3	Applications	25
3.3.2.4	Railroad Tank Car Applications using Magnetic Particle Testing	26
3.3.2.5	Technical Considerations	27
3.3.2.6	Status of Magnetic Particle Testing in Current Tank Car Inspections	28
3.3.2.7	Recommended Future Applications in Tank Car Inspections	28
3.3.3	Radiographic Test Method.....	28
3.3.3.1	Summary	29
3.3.3.2	Technical Background	29
3.3.3.3	Applications	30
3.3.3.4	Railroad Tank Car Applications using Magnetic Particle Testing	31
3.3.3.5	Technical Considerations	31
3.3.3.6	Status of Magnetic Particle Testing in Current Tank Car Inspections	32
3.3.3.7	Recommended Future Applications in Tank Car Inspections	32

Table of Contents (continued)

3.3.4	Ultrasonic Test Method	33
3.3.4.1	Summary	33
3.3.4.2	Technical Background	33
3.3.4.3	Applications	34
3.3.4.4	Railroad Tank Car Applications using Ultrasonic Testing.....	36
3.3.4.5	Technical Considerations	36
3.3.4.6	Status of Ultrasonic Testing in Current Tank Car Inspections.....	37
3.3.4.7	Recommended Future Applications in Tank Car Inspections	37
3.3.5	Visual Test Method	38
3.3.5.1	Summary	38
3.3.5.2	Technical Background	38
3.3.5.3	Applications	39
3.3.5.4	Railroad Tank Car Applications using Visual Testing.....	40
3.3.5.5	Technical Considerations	40
3.3.5.6	Status of Visual Testing in Current Tank Car Inspections.....	41
3.3.5.7	Recommended Future Applications in Tank Car Inspections	41
3.3.6	Acoustic Emission Test Method.....	42
3.3.6.1	Summary	42
3.3.6.2	Technical Background	42
3.3.6.3	Applications	43
3.3.6.4	Railroad Tank Car Applications using Acoustic Emission Testing	44
3.3.6.5	Technical Considerations	44
3.3.6.6	Status of Acoustic Emission Testing in Current Tank Car Inspections ...	45
3.3.6.7	Recommended Future Applications in Tank Car Inspections	45
3.4	Probability of Detection (POD)	46
3.4.1	POD Method Background	47
3.4.2	Sample Crack Panel Generation	52
3.4.3	Master Gage Calibration	59
3.4.4	POD Test Panel Evaluations	61
3.5	Initiating A Defect Library: the Tank Re-Qualification and Inspection Center (TRIC)	63
4.0	RESULTS	68
4.1	Safety Railway Services Test Results.....	68
4.2	Baseline Inspection Results	71
4.2.1	Acoustic Emissions Test Results	71
4.2.2	HM 201 Rulemaking for Accepted NDE Inspection Results	74
4.3	Probability of Detection (POD) Results	79

Table of Contents (continued)

4.3.1	Liquid POD Results.....	80
4.3.2	Magnetic Particle POD Results.....	86
4.3.3	Ultrasonic (Shear Wave) POD Results.....	91
4.3.4	Visual Testing (Optically Aided) POD Results	96
4.3.5	Comparison of POD Results.....	101
5.0	CONCLUSIONS AND RECOMMENDATIONS	105
	References	108

List of Figures

Figure

1.	General Service Jacketed Tank Car Used in Baseline Evaluations	6
2.	Dual Diameter Jacketed Pressure Tank Car Used in Baseline Evaluations	6
3.	Non-jacketed General Service Tank Car Used in Baseline Evaluations	7
4.	Non-jacketed Pressure Tank Car Used in Baseline Evaluations.....	7
5.	Weld Definitions for the Bottom View of the Tank Car	11
6.	AAR Drawing No. NDE-S1 Detailing Tank Envelopes, Nozzles and Welded Attachments	12
7.	AAR Drawing No. NDE-S2 Detailing the Stub Sill with Head Braces	13
8.	AAR Drawing No. NDE-S3 Identifying the Inspection Zone Locations	14
9.	AAR Drawing No. NDE-B1 Detailing the Full Length Pad and Bottom Shell.....	15
10.	AAR Drawing No. NDE-B2 Detailing a Non-continuous Pad and Bottom Shell	16
11.	AAR Drawing No. NDE-B3 Detailing the Reinforcement Pad Arrangement and Bottom Shell	17
12.	AAR Drawing No. NDE-B4 Detailing the Reinforcement Bar Arrangement and Bottom Shell	18
13.	AAR Drawing No. NDE-B5 Detailing Tank Car Anchor and Bottom Shell “Full Sill Tank Cars	19
14.	Typical Probability of Detection (POD) Curve.....	50
15.	Fatigue Crack Test Panel During Preparation for Fatigue Initiation	53
16.	Instrumentation Used in the Setup for Tank Car Test Panel Dynamic Loading	54
17.	Tank Car Test Panel Setup for Dynamic Loading on the 200-kip Load Frame.....	54
18.	Position of the Platen Adjacent to the Butt Weld Prior to Dynamic Loading.....	55
19.	Test Setup Around Butt Weld during Crack Initiation and Propagation.....	56
20.	Fatigue Cracks Initiated Under a 25-kip Maximum Dynamic Load.....	57
21.	Fatigue Cracks from Figure 20 Broken Open and Showing Propagation in the Longitudinal and Transverse Directions.....	57
22.	Fatigue Crack Generated from a Maximum Dynamic Load of 17 kips.....	58
23.	Fatigue Cracks from Figure 22 Broken Open and Showing Propagation in the Longitudinal Direction.....	58
24.	Master Gage Constructed of Tank Car Material Representative of ASTM A515, Grade 70 Steel.	60
25.	112T Tank Car Located in the Defect Library.....	66
26.	111A Tank Cars Located in the Defect Library.....	66
27.	Transverse Butt Weld Panels Included in the Defect Library	67
28.	Master Gage Standard #1 Located in the Defect Library	67
29.	AE Pressure Test Setup on Baseline Tank Car	72
30.	AE Jacking Test Setup on Baseline Tank Car.....	72
31.	AE Sill Twist Test Setup on Baseline Tank Car.....	73
32.	AE Data Collection and Monitoring System Used	73
33.	Liquid Penetrant Inspection of Transverse Butt Weld from the Interior of the Tank Car.....	76

List of Figures (continued)

34.	Liquid Penetrant Inspection Showing 0.050-inch Crack at Fillet Weld Termination of the Sill Bearing Plate	77
35.	Magnetic Particle Inspection of the Transverse Butt Weld from the Interior of the Tank Car	77
36.	Film Placement at the Transverse Butt Weld in the Interior of the Tank for Radiographic Inspection	78
37.	Gamma Ray Source Location for Transverse Butt Weld Inspection with Source at the Exterior of the Tank.....	78
38.	Ultrasonic Evaluation of the Transverse Butt Weld from the Interior of the Tank	79
39.	Fluorescent Liquid Penetrant Crack Indications on Tank Car Test Panels	82
40.	Fluorescent Liquid Penetrant POD Curve for Operator Number 1	83
41.	Fluorescent Liquid Penetrant POD Curve for Operator Number 2	84
42.	Fluorescent Liquid Penetrant POD Curve for Operator Number 3	84
43.	Fluorescent Liquid Penetrant POD Curve for Operator Number 4	85
44.	Fluorescent Liquid Penetrant POD Curve for All Operators	85
45.	Fluorescent Magnetic Particle Longitudinal and Transverse Crack Indications	87
46.	Fluorescent Magnetic Particle Inspection POD Curve for Operator Number 1	88
47.	Fluorescent Magnetic Particle Inspection POD Curve for Operator Number 2	89
48.	Fluorescent Magnetic Particle Inspection POD Curve for Operator Number 3	89
49.	Fluorescent Magnetic Particle Inspection POD Curve for Operator Number 4	90
50.	Fluorescent Magnetic Particle Inspection POD Curve for All Operators	90
51.	Shear Wave Ultrasonic Calibration and Scanning to Detect Fatigue Crack on Tank Car Test Panels	92
52.	Shear Wave Ultrasonics POD Curve for Operator Number 1	93
53.	Shear Wave Ultrasonics POD Curve for Operator Number 2	94
54.	Shear Wave Ultrasonics POD Curve for Operator Number 3	94
55.	Shear Wave Ultrasonics POD Curve for Operator Number 4	95
56.	Shear Wave Ultrasonics POD Curve for All Operators	95
57.	Optically Aided Visual Inspection on the Inside and Outside Diameters of the Tank Car Test Panels	97
58.	Optically Aided Visual POD Curve for Operator Number 1	98
59.	Optically Aided Visual POD Curve for Operator Number 2	98
60.	Optically Aided Visual POD Curve for Operator Number 3	99
61.	Optically Aided Visual POD Curve for Operator Number 4	99
62.	Optically Aided Visual POD Curve for All Operators.....	100
63.	Fluorescent Liquid Penetrant POD Curve for All Operators Combined.....	103
64.	Fluorescent Magnetic Particle POD Curve for All Operators Combined	103

List of Figures (continued)

65.	Shear Wave Ultrasonics POD Curve for All Operators Combined.....	104
66.	Optically Aided Visual POD Curve for All Operators Combined.....	104
67.	POD Curve Comparison for All Methods for All Operators Combined	105
68.	POD Curve Comparison of All Methods for All Operators Combined, Showing Variability Showing Variability Between NDE Test Methods	107
69.	Fluorescent Magnetic Particle POD Curve Comparison for All Operators	107

List of Tables

1.	Railroad Tank Cars Available for the Tank Car NDE Program	5
2.	Actual-to-Targeted Flaw Size Distribution for POD Test Panels	59
3.	Defect Dimensions and Orientations for TTCI Tank Car Crack Panel Master Gage Standard #1.....	60
4.	Defect Dimensions and Orientations for TTCI Tank Car Crack Panel Master Gage Standard #2.....	60
5.	Ultrasonic Signal Response Comparison between Operators During POD Evaluations	61
6.	Operator Profiles Showing Level of Qualification	63
7.	Tank Car and Tank Car Artifacts in the Defect Library.....	65
8.	Defects Identified During Interior Visual Inspection of Tank Car Number 1 by SRS.....	68
9.	Discontinuities Identified During Interior Visual Inspection of Tank Car Number 2 by SRS.....	69
10.	Discontinuities Identified During Magnetic Particle Inspection of Tank Car Number 2 by SRS	69
11.	SRS Findings from Ultrasonic Inspection of Tank Car Number 2	69
12.	Discontinuities Identified During Visual Inspection of Tank Car Number 3 by SRS	70
13.	SRS Findings from Ultrasonic Inspection of Tank Car Number 3	70
14.	Results of Global Testing Using Acoustic Emissions on Baseline Tank Cars.....	71
15.	Baseline Inspection Results from Tank Car Number GATX 92487.....	75
16.	Baseline Inspection Results from Tank Car Number AAR 300	75
17.	Baseline Inspection Results from Tank Car Number AAR 302	75
18.	Baseline Inspection Results from Tank Car Number AAR 303	75
19.	Fluorescent Liquid Penetrant Inspection POD Percentages	83
20.	Fluorescent Magnetic Particle Inspection POD and Average POD Percentages.....	88
21.	Ultrasonic Shear Wave Signal Amplitude Responses on the 0.50-inch (1.27 cm) EDM Notch	91
22.	Ultrasonic Shear Wave Inspection POD Percentages	93
23.	Optically Aided Visual Inspection POD Percentages.....	97
24.	POD Percentages from All Evaluations Combined for Each NDE Method	102

1.0 BACKGROUND

The Department of Transportation (DOT) no longer considers the hydrostatic pressure test part of the optimum way to qualify fusion welded tank cars for continued service. This is based on the ineffectiveness of the hydrostatic test in detecting significant fatigue cracking in tank cars resulting from service loadings, stress risers, and welding defects. On September 21, 1995, the DOT changed the Federal regulations to require the use of nondestructive evaluation (NDE) to verify tank structural integrity.⁽¹⁾

The adequacy of the prescribed hydrostatic testing of tank cars has been debated over the years. The National Transportation Safety Board (NTSB), based on previous accident experience, urged the Department of Transportation to seek a possible replacement of the test. Under HM 201, the DOT's Federal Railroad Administration (FRA) and the Research and Special Programs Administration (RSPA) revised the Hazardous Materials Regulations (HMR) to replace the hydrostatic test with appropriate nondestructive testing (NDT) methods. The NDT methods would increase the confidence of detection of critical tank car defects; thereby enhancing safe transportation of hazardous materials.

Under 49 CFR (Code of Federal Regulations) Parts 173, 174, and 180, Docket No. HM 201, the Research and Special Programs Administration revised the HMR requiring the development and implementation of Quality Assurance Programs (QAP) at facilities that build, repair, and inspect tank cars. The rule requires NDE in lieu of the current periodic hydrostatic pressure tests for fusion welded tank cars. The rule change was made to incorporate inspection methods that will:

- More adequately detect critical cracks
- Require thickness measurements of tank cars
- Allow the continued use of tank cars with reduced shell thickness
- Revise the inspection and test intervals for tank cars
- Clarify the inspection requirements relating to tank cars prior to and during transportation.

These actions were deemed necessary to increase the confidence that critical tank car defects will be detected. The intended effect of these actions is to enhance the safe transportation of hazardous materials in tank cars.

In support of HM 201, the FRA Office of Research and Development contracted with the Transportation Technology Center, Inc. (TTCI), a subsidiary of the AAR, to perform a joint government/industry evaluation of possible replacement tests/inspections for the presently prescribed hydrostatic test/visual inspection of tank cars. Evaluations were performed at the FRA's Transportation Technology Center (TTC), Pueblo, Colorado.

1.1 PROGRAM STEERING GROUP

A steering group, led by Jim Rader and Jose Pena of the FRA, was formed to ensure industry participation and input into the test procedures. The following industry representatives, who are also members of the AAR NDE Task Force, are steering group members:

- Tom Delafosse, Union Tank Car Company Company
- Warner Fencl, American Railcar Industries
- Paul Hayes, Trinity Industries
- Larry Strouse, General American Transportation Corporation
- Sam Ternowchek, Physical Acoustics Corporation
- Lee Verhey, Trinity Industries
- Paul Williams, Safety Railway Service

2.0 OBJECTIVE

The objectives of the Tank Car NDE program have been to:

- Observe, review, and document previously performed industry related work
- Baseline current NDE processes allowed for use in railroad tank car inspection
- Develop a validation methodology for the NDE processes
- Introduce a standard process to determine the probability of detection (POD) for the NDE methods
- Establish the Tank Re-qualification and Inspection Center (TRIC) at TTC

Ultimately, the TRIC will be used to validate NDE processes for the inspection of tank cars similar to that which Sandia National Laboratories (SNL) and the Federal Aviation Administration (FAA) have established at their Aging Aircraft Nondestructive Investigation Validation Center (AANC) in Albuquerque, New Mexico.

3.0 PROCEDURES

3.1 OBSERVATION, REVIEW, AND DOCUMENTATION OF PRIOR WORK

3.1.1 Industry Sponsored Tests

As part of an industry-sponsored effort in the spring of 1994, Safety Railway Service Company (SRS) of Victoria, Texas performed nondestructive evaluations on tank cars with known defects using the NDE methods allowed in the HM 201 rulemaking. Results of the SRS efforts were presented to the AAR Tank Car Subcommittee NDE Task Force on May 24, 1994. The results were included in the various NDE method reports; an official summary report was not required of SRS. TTCI has reviewed the results of the SRS evaluations, along with their daily test operation. The test cars were no longer available at SRS; hence, TTCI evaluated the NDE reports compiled from testing and conducted onsite interviews of NDE technicians performing the tests. A summary of the SRS evaluations is included in the results section of this report.

3.1.2 Literature Search

A program for validating nondestructive evaluation has been established at SNL through funding by the DOT and the FAA. The Validation Center (AANC) officially opened in February 1993. The AANC was established as a means of validating NDE processes for application to aging aircraft and has been used as a model for the TRIC located in Pueblo. A number of studies performed by the aircraft industry in the area of NDE have been researched and some of the methodology and processes were incorporated into the NDE performed during this project. Information supplied or made available by Ms. Catherine Bigelow and Mr. Dave Galella from the FAA, Dr. Floyd Spencer from SNL, and Dr. Bill Shurtleff, Program Manager of the AANC, has proven invaluable during this project.

The Tank Car NDE steering committee toured the AANC April 9, 1996. Dr. Shurtleff conducted the AANC tour and provided the steering committee with an overview of how and why the Validation Center was created. The AANC is located in a hanger at the west end of Albuquerque International Airport. The major objective of the Validation Center is “to provide the developers, users, and regulators of aircraft NDI, maintenance, and repair processes with comprehensive, independent, and quantitative evaluations of new and enhanced inspection, maintenance and repair techniques.”⁽²⁾

The tour of the AANC was very informative and supplied the basic model for the development of

a defect library and the TRIC. The roles of the TRIC correlate with those of the AANC in that both offer their prospective industries a means of developing and evaluating NDE technology.

An obvious benefit of the validation center is that it provides a tool for:

- Determining the reliability of inspections
- Improving safety through technology development
- Addressing industry needs in the areas of maintenance, inspection, and damage tolerance
- Validating inspection technologies developed by government, academic, and commercial organizations
- Developing validation models for probability of detection assessments
- Performing cost benefit analysis
- Promoting technology transfer

Approaches used in NDE work sponsored by the FAA were used to address the evaluation of performance capabilities on NDE allowed for railroad tank car inspection. A key to maximizing the benefit from information available by the FAA was to properly assess the current status of NDE in the railroad tank car industry. The assessment included applying current NDE processes and procedures used in railroad tank car evaluations to baseline and POD activities conducted during this project. The NDE steering committee was very helpful in assuring that procedures used were representative of industry practices.

3.2 BASELINING CURRENT NDE METHODS

The NDE methods called out in the HM 201 rulemaking, along with acoustic emissions which is allowed under FRA guidelines and DOT exemption status to qualifying companies, were used in the baseline inspection of four tank cars. NDE technicians in the tank car industry who routinely conduct tank car inspections for their companies performed the baseline evaluations. The NDE methods used during baseline operations included:

- Acoustic emissions testing (AET)
- Liquid penetrant testing (PT)
- Magnetic particle testing (MT)
- Radiographic testing (RT)
- Ultrasonic Testing (UT)
- Optically aided visual testing (VT)

3.2.1 Defining Tank Car Criteria for Baseline and POD Testing

The railroad tank cars requested for this project included tank cars containing known defects initiated in service. Representative samples were not made available in time for the Tank Car NDE program. As a result, the Steering Committee approached tank car selection by what tank cars were actually available. The tank cars available to the NDE project were presented during the November 14, 1996 Steering Committee meeting and included five tank cars from TTCI and four tank cars donated by General American Transportation Corporation (GATX). Table 1 lists the available tank cars.

Table 1. Railroad Tank Cars Available for the Tank Car NDE Program

Tank Car Designation	Identification Number	Tank Size (gallons)	Date of Manufacture
DOT 103ALW	DUPX-7808	10,058	3/61
DOT 111T	AAR-302	29,408	?
DOT 111A	GATX-92487	10,401	9/69
DOT 111A	GATX-92488	10,408	9/69
DOT 111A	GATX-92493	10,413	9/69
DOT 111A	GATX-92496	10,425	9/69
DOT 112J	AAR-300	25,960	12/66
DOT 112T	AAR-303	33,586	3/70
DOT 112T	AAR-301	26,063	6/74

The list identifies the tank cars used during the baseline portion of the program (shaded rows) and those used for the POD evaluations (black background, white text). The cars used during baseline operations include two general service cars and two pressure cars. The cars consisted of two jacketed tank cars and two non-jacketed tank cars with thermal coating of the tank exterior. Drawings of the baselined tank cars used in this project are available through TTCI. The tank car identified as AAR-300 is a dual diameter car and was included in baseline operations at the request of the FRA. The suggestion was made as an effort to identify defects at the draft sill that would parallel defect findings from other dual diameter cars manufactured during the same time period. The tank cars shown in Figures 1 through 4 are the tank cars used in the baseline evaluations.



Figure 1. General Service Jacketed Tank Car Used in Baseline Evaluations



Figure 2. Dual Diameter Jacketed Pressure Tank Car



Figure 3. Non-jacketed General Service Tank Car Used in Baseline Evaluations

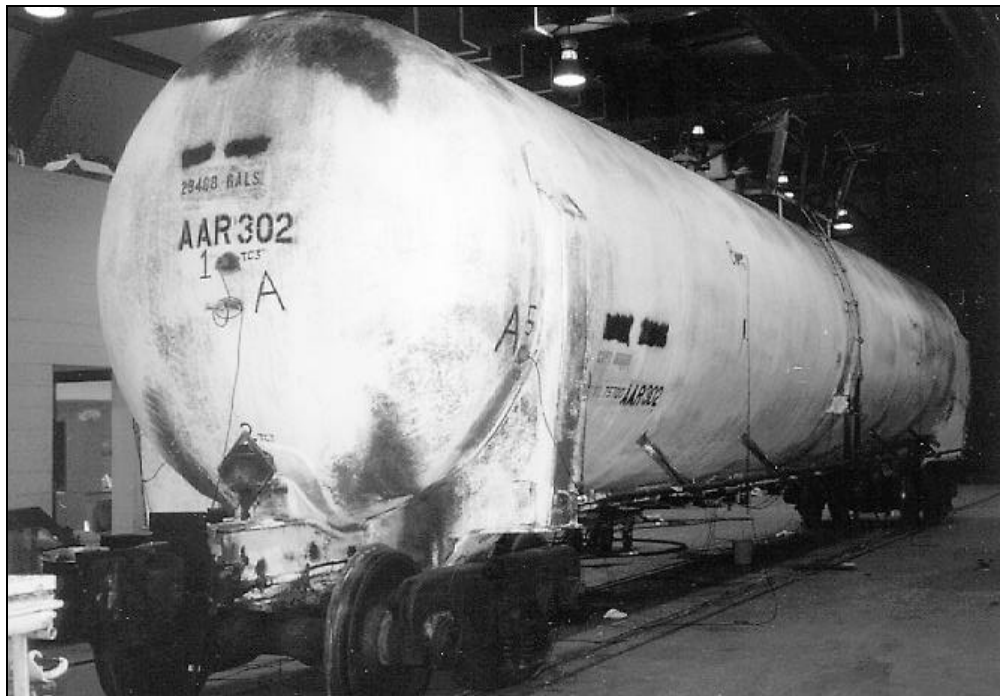

Figure 4. Non-jacketed Pressure Tank Car Used in Baseline Evaluations

Tank cars supplied to TTCI for evaluation purposes and/or as part of the TRIC have been placed in a remote area at TTC known as the SREMP (Source Regional Electromagnetic Pulse) site. The SREMP site is a fenced in area with wayside power sources available for equipment requiring electricity. The remoteness for the tank car locations provides safety for employees and visitors during the performance of NDE processes during which special safety precautions are necessary, such as radiographic inspection, which resulted in the emission of radiation.

3.2.2 Baseline Testing

Baseline evaluations began January 1997 and were performed as an industry effort with GATX, SRS, and Union Tank Car Company (UTC) volunteering personnel and equipment to conduct the inspections. TTCI engineering and support staff oversaw the baseline inspections to collect data and document the inspection processes. Representatives from the FRA and Transport Canada periodically provided input and guidance during the performance of the inspections and were onsite during some of the baseline efforts. The baseline evaluations were performed to determine the structural integrity of the tank cars and to document typical inspection processes used during railroad tank car inspection.

Evaluation of the four tank cars was performed by NDE technicians from the railroad tank car industry who perform tank car inspections regularly as part of their job assignments. The baseline testing was performed between January and July 1997 at the Urban Rail Building (URB) at TTC. The NDE methods used during baseline evaluations include global inspection using acoustic emissions (AE) supplemented by the methods allowed in the HM 201 rulemaking which are: liquid penetrant (PT), magnetic particle (MT), radiography (RT), ultrasonic (UT), and visual testing (VT). The NDE procedures used were agreed upon by the Tank Car NDE Steering Committee and were representative of typical procedures used for tank car inspection.

The areas of interest during baseline evaluations addressed requirements from the HM 201 rulemaking contained in Federal Register 49 CFR Section 180.509, Requirements for inspection and test of specification tank cars, paragraph (e) Structural integrity inspections and tests.⁽³⁾ The inspection areas per 49 CFR are identified as follows.

3.2.2.1 Structural Integrity Inspections and Tests

At a minimum, each tank car facility shall inspect the tank for structural integrity as specified in this section. The structural integrity inspection and test shall include all transverse fillet welds greater than 0.64 cm (0.25 in.) within 121.92 cm (4 ft.) of the bottom longitudinal centerline; the termination of longitudinal fillet welds greater than 0.64 cm (0.25 in.) within 121.92 cm (4 ft.) of the bottom longitudinal centerline; and all tank shell butt welds within 60.96 cm (2 ft.) of the bottom longitudinal center line. This will be determined by one or more of the following inspection and test methods to determine that the welds are in proper condition:

- Dye penetrant test;
- Radiography test;
- Magnetic particle test;
- Ultrasonic test; or
- Optically-aided visual inspection (e.g., magnifiers, fiberscopes, borescopes, and machine vision technology).

Rule 88B.2 of the field *Manual of the AAR Interchange Rules* also identifies the inspection requirements:⁽⁴⁾

“Rule 88 – Mechanical Requirements for Acceptance

B. From Owner

2. Inspection and Repair

- b. A thorough inspection must be performed and repairs where necessary must be made to the following:
1. Body bolsters and center plates.
 2. Center sills.
 3. Crossbearers.
 4. Crossties.
 5. Draft systems and components.
 6. End sills.
 7. Side sills.
 8. Trucks.

Note 11: Removal of portions of tank jackets is required in order to conduct a thorough inspection of the bolster to stub sill welds and all stub sill attachment welds unless fiber optics, acoustic emission, or equivalent inspection techniques are used.”

Other Federal and industry programs mandating inspection requirements include:

- O&M Circular No. 1 dated July 17, 1997⁽⁵⁾
 - Mandates the inspection and repair of stub sills on all tank cars built before 1984, many on a priority basis.
 - Supplement No. 2 (CPC-1030), issued 8/10/94
 - Supplement No. 3, issued 6/10/95
- FRA Emergency Order No. 17, Notice No. 1 (57 FR 41799), 9/11/92⁽⁶⁾
 - Requires inspection and repair of stub sill tank cars
 - Notice No. 2 (58 FR 8647), 2/16/93
 - Notice No. 3 (FR 27 MR 95-118), 3/27/95

The NDE drawing task force has put together a set of generic NDE drawings that provide a visual interpretation of inspection areas mandated under various Federal and industry programs. The drawings have been developed as an industry tool to aid in understanding what items to inspect and to identify the NDE methods authorized to conduct the inspections. The drawings included as Figures 5 through 13 provide a definition of longitudinal and transverse (fillet) welds and identify the tank areas requiring NDE.

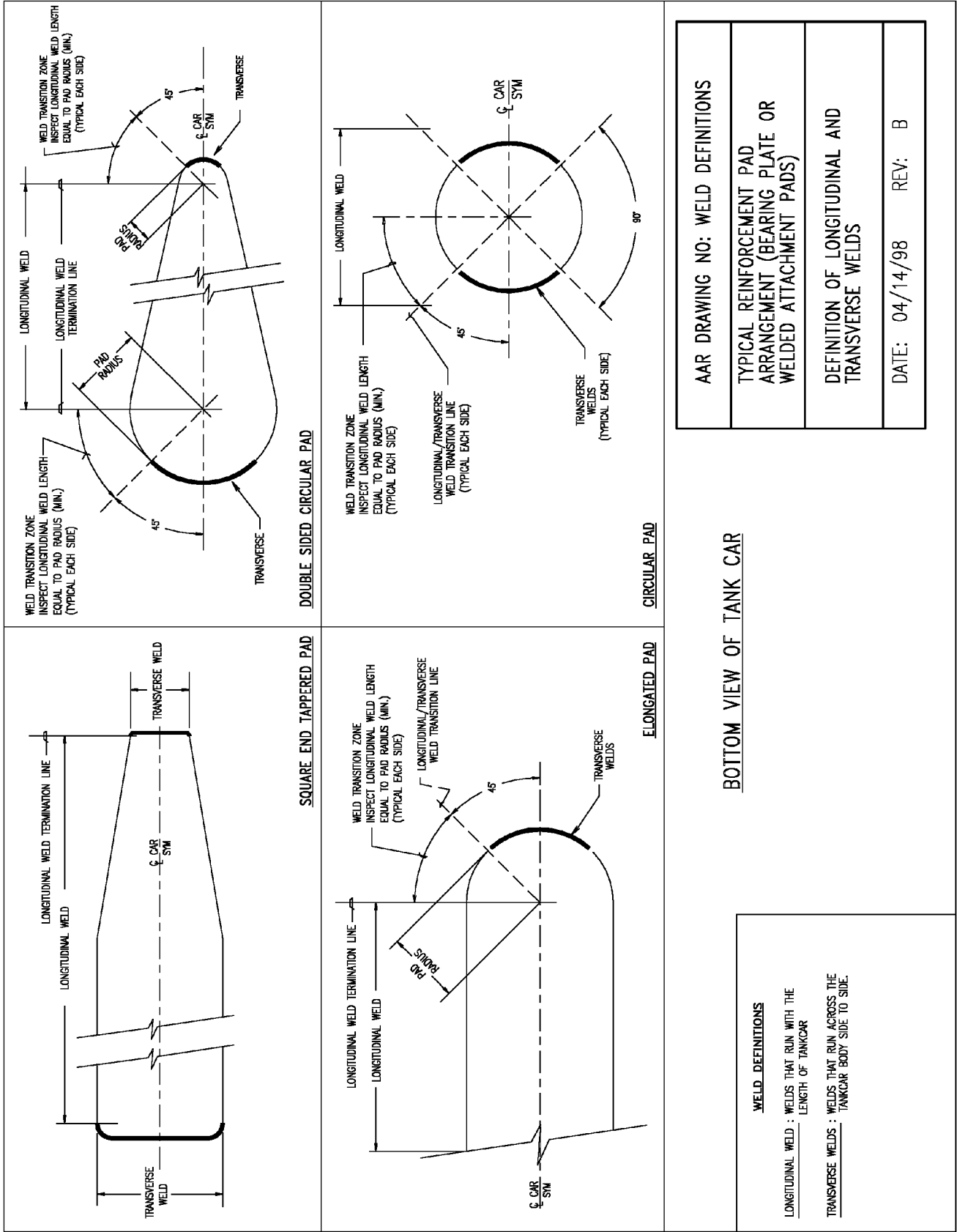

Figure 5. Weld Definitions for the Bottom View of the Tank Car

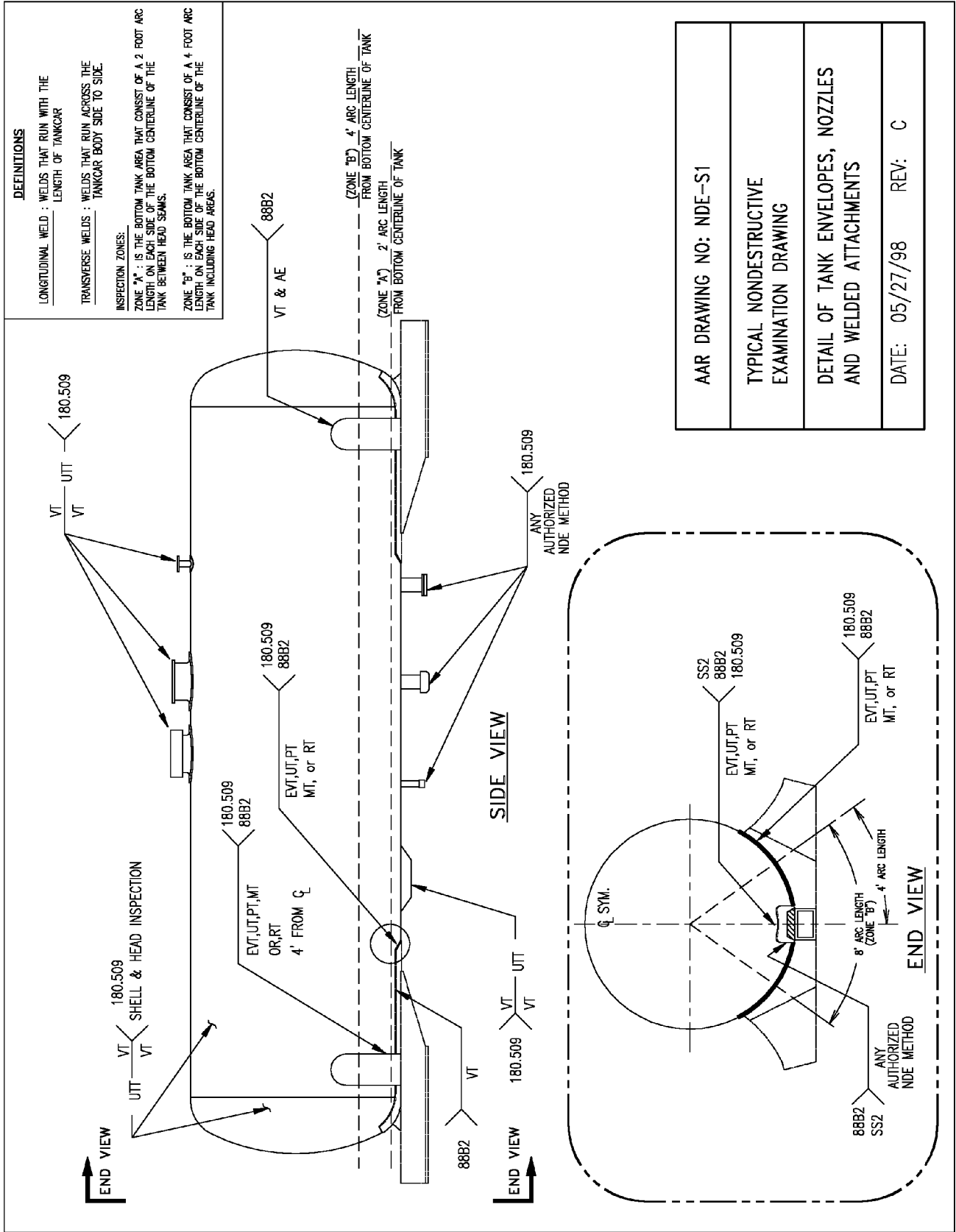

Figure 6. AAR Drawing No. NDE-S1 Detailing Tank Envelopes, Nozzles and Welded Attachments

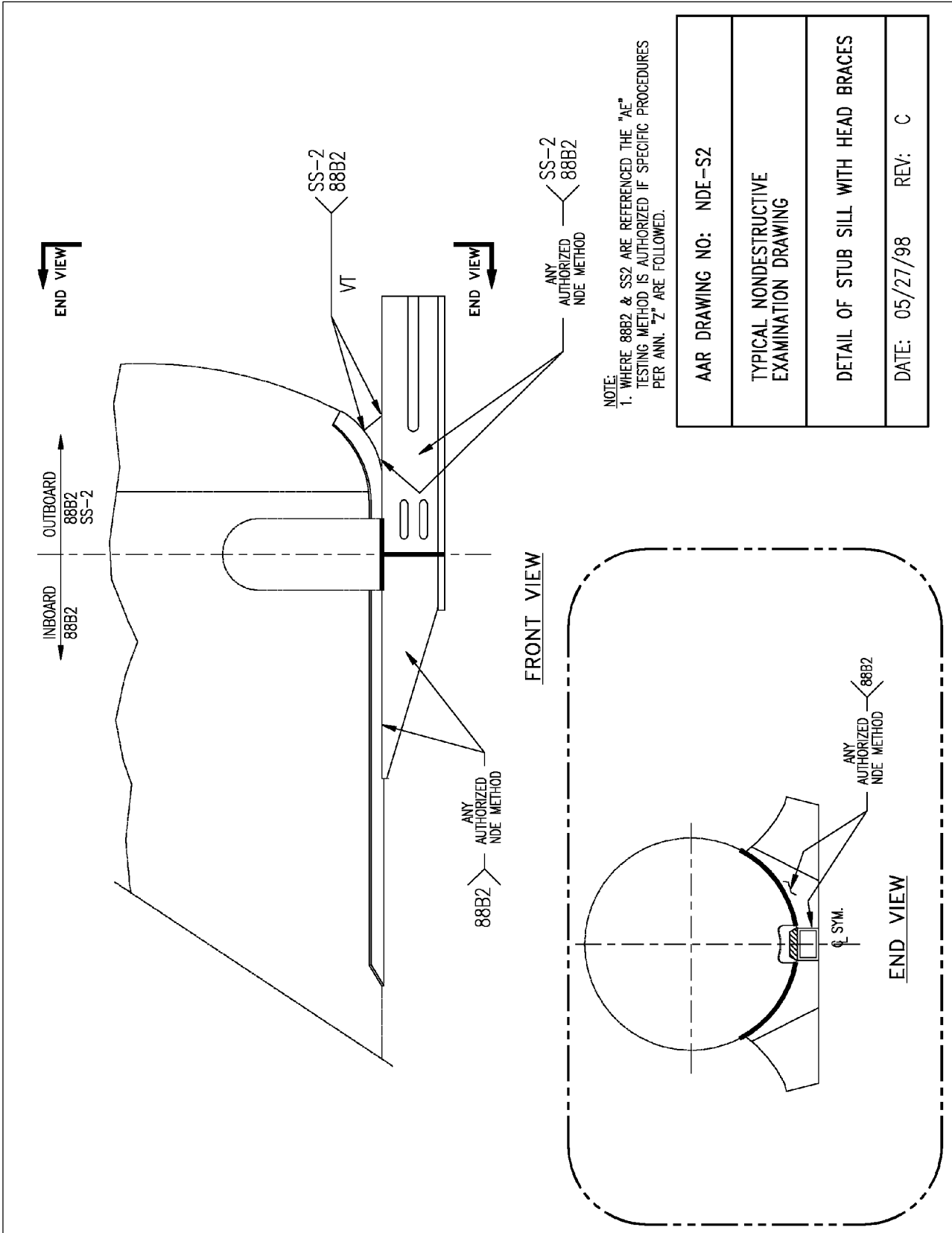

Figure 7. AAR Drawing No. NDE-S2 Detailing the Stub Sill with Head Braces

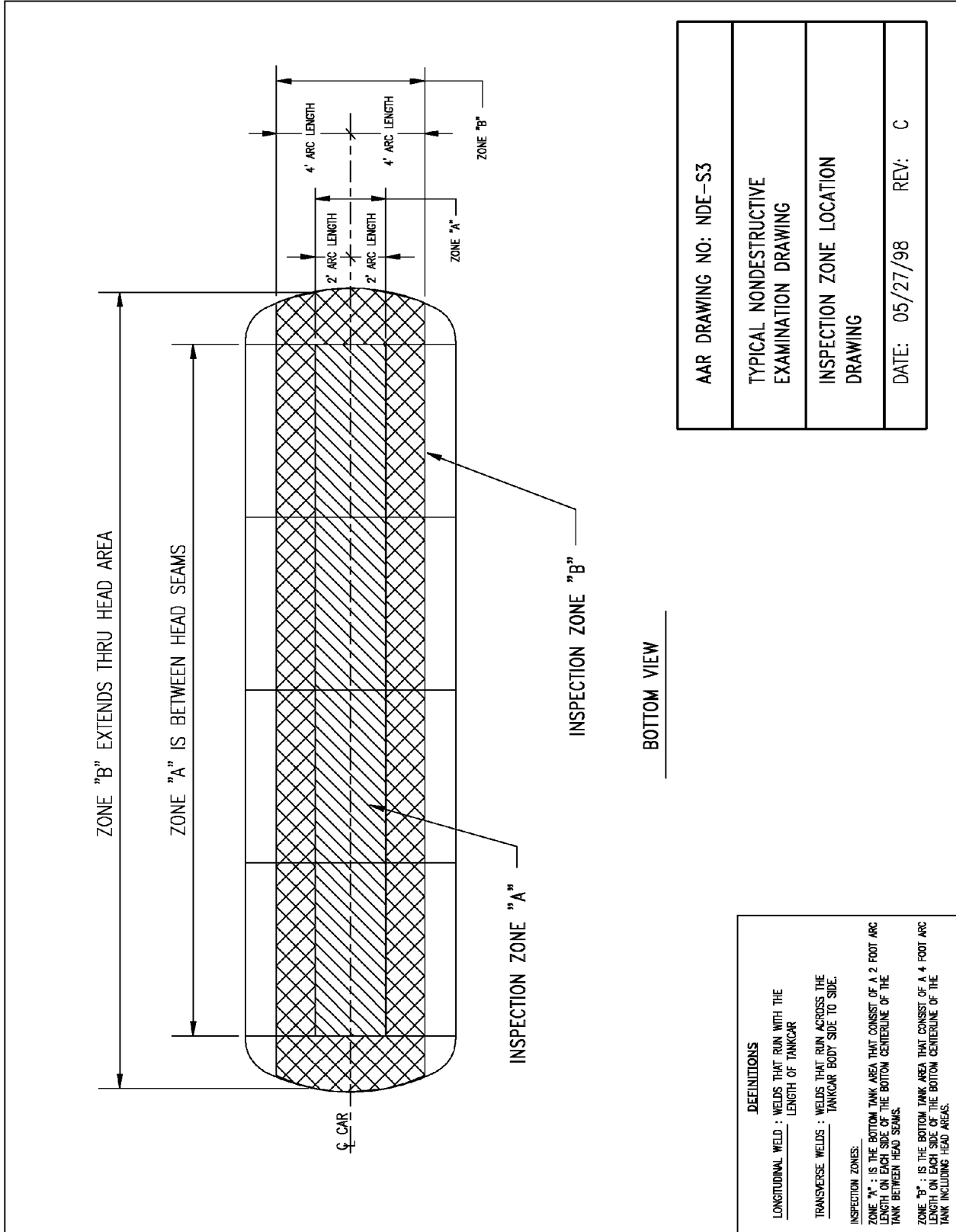

Figure 8. AAR Drawing No. NDE-S3 Identifying the Inspection Zone Locations

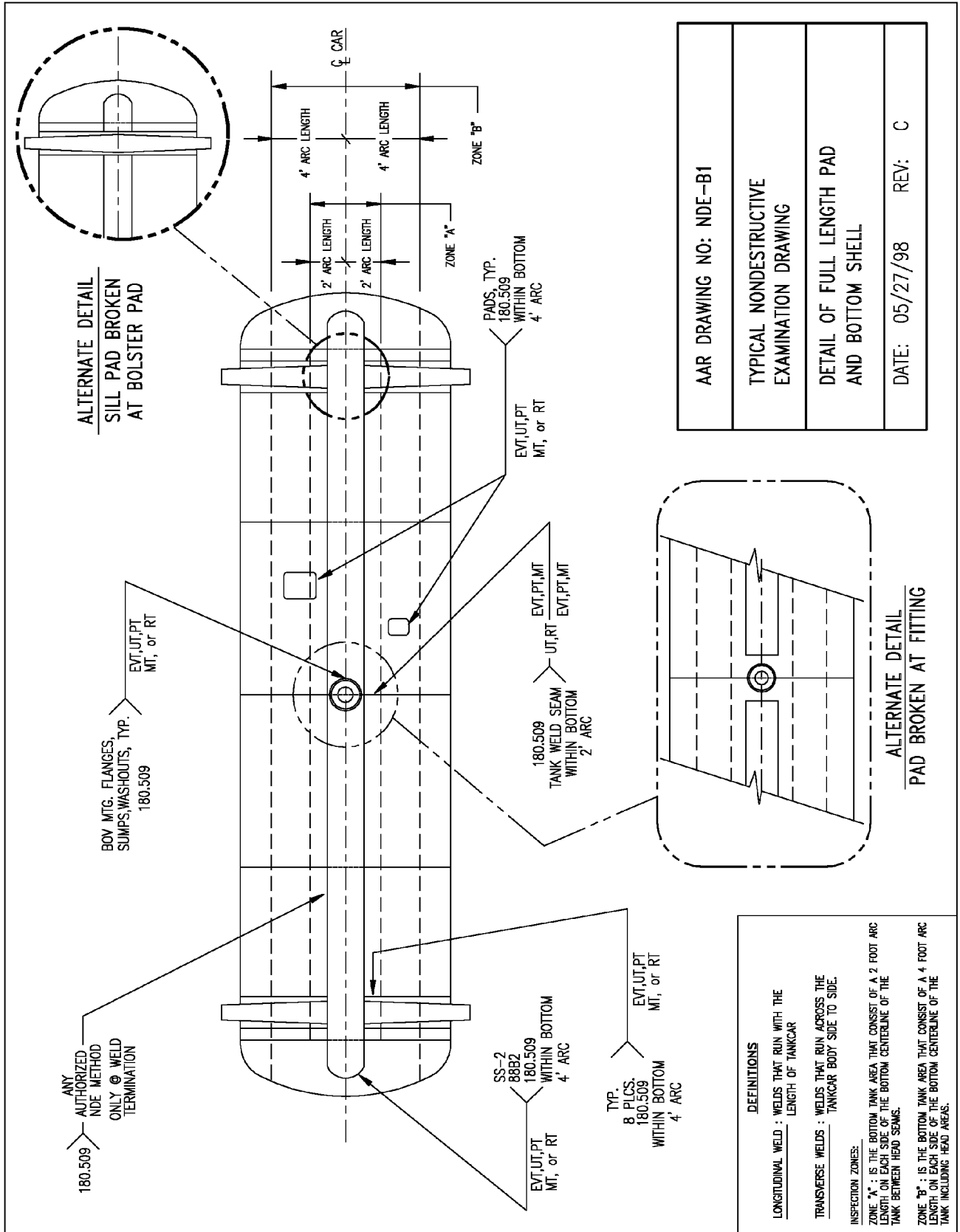

Figure 9. AAR Drawing No. NDE-B1 Detailing the Full Length Pad and Bottom Shell

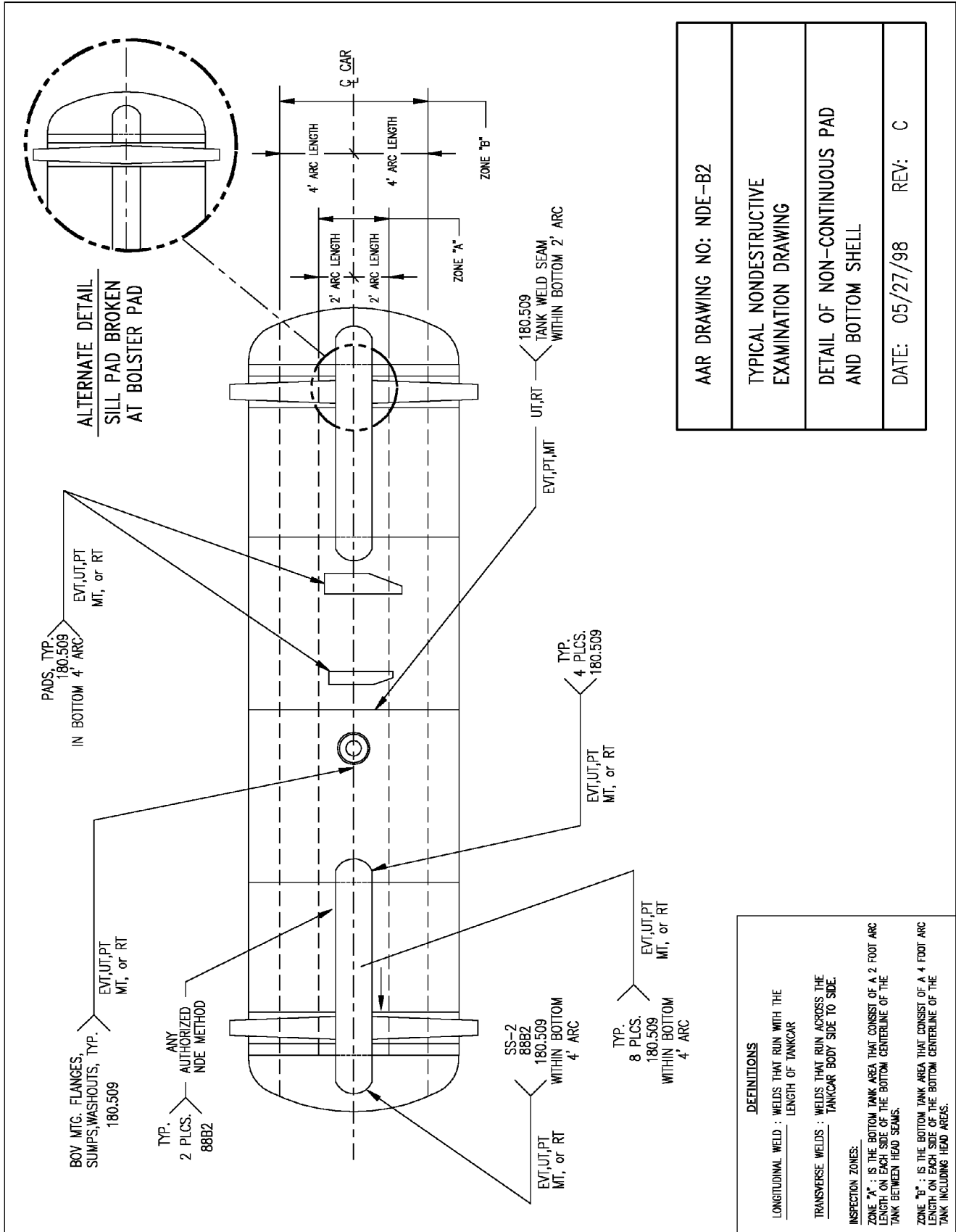

Figure 10. AAR Drawing No. NDE-B2 Detailing a Non-continuous Pad and Bottom Shell

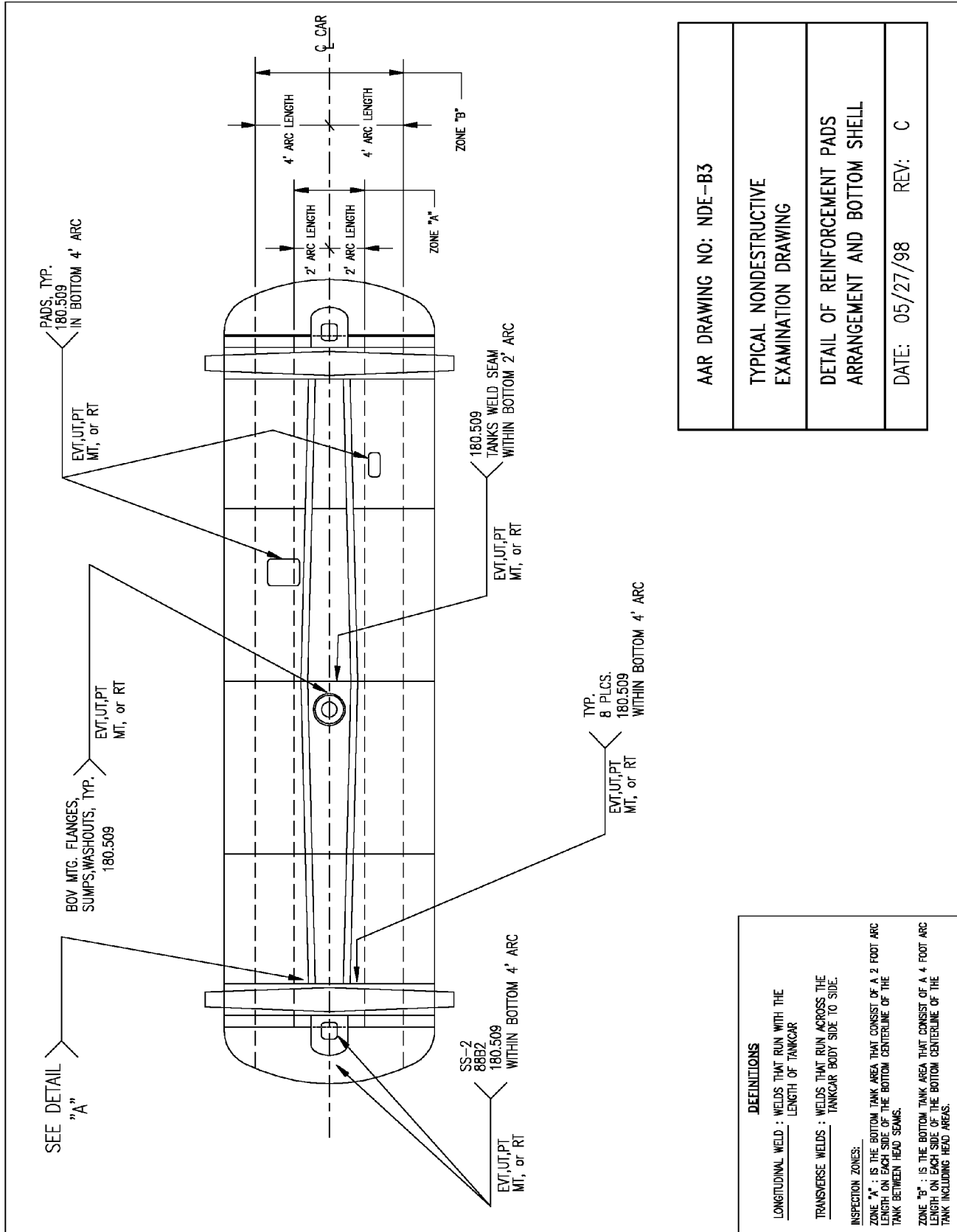
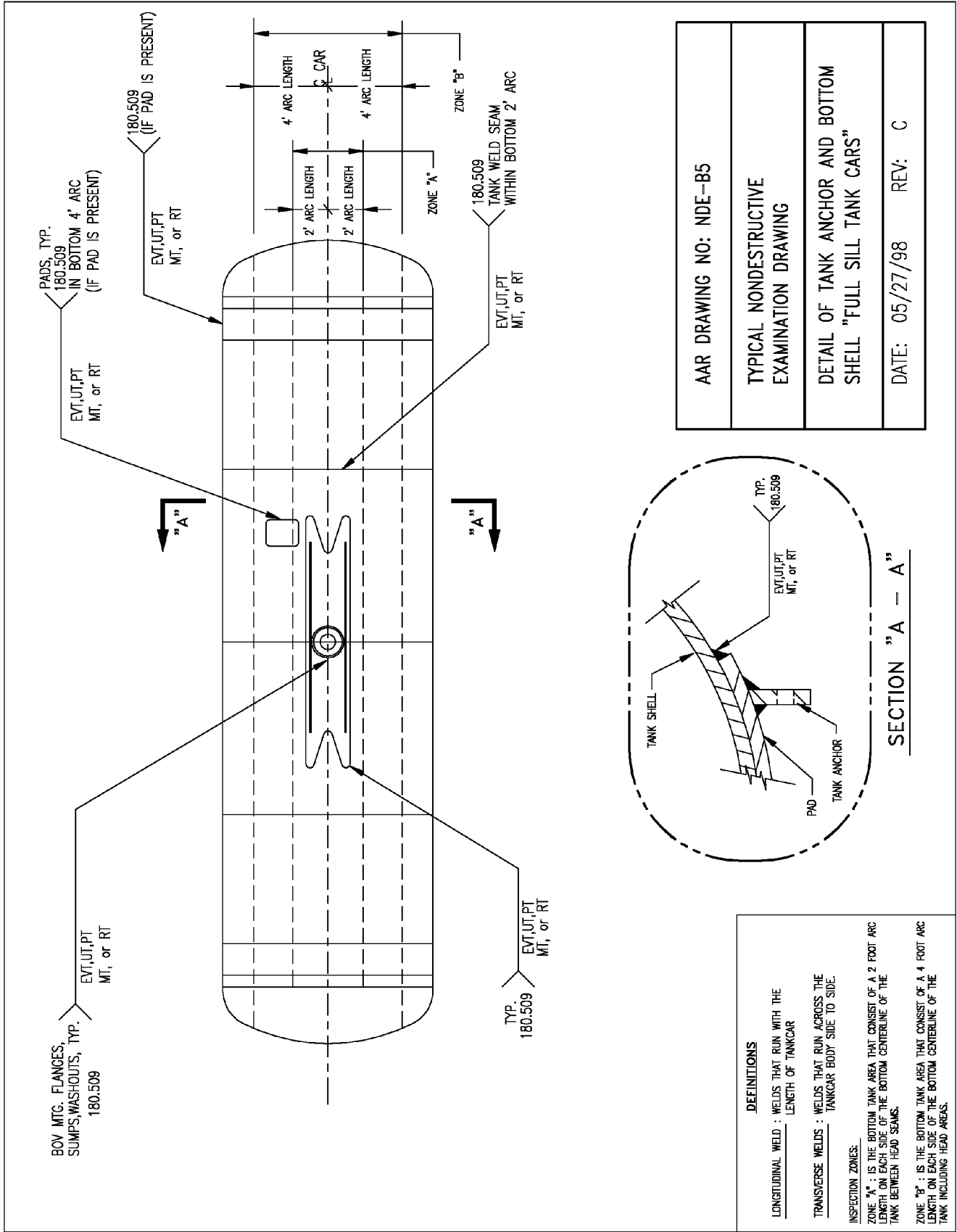

Figure 11. AAR Drawing No. NDE-B3 Detailing the Reinforcement Pad Arrangement and Bottom Shell



BOV MTC, FLANGES,
SUMPS, WASHOUTS, TYP.
180.509

PADS, TYP.
180.509
IN BOTTOM 4' ARC
(IF PAD IS PRESENT)

EVT, UT, PT
MT, or RT

180.509 (IF PAD IS PRESENT)

EVT, UT, PT
MT, or RT

EVT, UT, PT
MT, or RT

EVT, UT, PT
MT, or RT

TYP.
180.509

EVT, UT, PT
MT, or RT

4' ARC LENGTH

2' ARC LENGTH

2' ARC LENGTH

4' ARC LENGTH

4' ARC LENGTH

ZONE "A"

ZONE "B"

180.509
TANK WELD SEAM
WITHIN BOTTOM 2' ARC

180.509

EVT, UT, PT
MT, or RT

TANK SHELL

TANK ANCHOR

PAD

TYP.
180.509

EVT, UT, PT
MT, or RT

SECTION "A - A"

DEFINITIONS

LONGITUDINAL WELD : WELDS THAT RUN WITH THE LENGTH OF TANKCAR

TRANSVERSE WELDS : WELDS THAT RUN ACROSS THE TANKCAR BODY SIDE TO SIDE.

INSPECTION ZONES:

ZONE "A" : IS THE BOTTOM TANK AREA THAT CONSIST OF A 2 FOOT ARC LENGTH ON EACH SIDE OF THE BOTTOM CENTERLINE OF THE TANK BETWEEN HEAD SEAMS.

ZONE "B" : IS THE BOTTOM TANK AREA THAT CONSIST OF A 4 FOOT ARC LENGTH ON EACH SIDE OF THE BOTTOM CENTERLINE OF THE TANK INCLUDING HEAD AREAS.

AAR DRAWING NO: NDE-B5

TYPICAL NONDESTRUCTIVE EXAMINATION DRAWING

DETAIL OF TANK ANCHOR AND BOTTOM SHELL "FULL SILL TANK CARS"

DATE: 05/27/98 REV: C

Figure 13. AAR Drawing No. NDE-B5 Detailing the Tank Car Anchor and Bottom Shell "Full Sill T

3.3 DEVELOPING A VALIDATION METHODOLOGY

Information generated in the aerospace and nuclear industries was used as models for determining a methodology to validate NDE processes for the inspection of railroad tank cars. A report released by the FAA titled “Emerging Nondestructive Inspection For Aging Aircraft” outlines the methodology used by SNL at the AANC to provide a validation methodology for nondestructive evaluation technologies.⁽⁷⁾ The following sections provide the validation methodology for the NDE methods allowed under the HM 201 rulemaking. In general, the methodology requires the following steps and information.

- Identify the test method
- Provide a summary of the test method
- Provide a technical background of the test method
- Identify present applications for the test method
- Identify applications in inspecting tank cars for the test method
- Identify technical considerations in utilizing the test method for tank car inspection
- Identify the status of the test method in current tank car inspections
- Recommend future applications for using the test method in tank car inspection

An NDE process includes the NDE systems and procedures used for inspection, as well as the NDE equipment, operator, inspection environment, and the object being inspected. By validating a NDE process, an assessment of the reliability and the implementation cost of that process can be performed.

The requirements for structural integrity inspections called out in the HM 201 rulemaking identify the allowed NDE methods but do not specify the most applicable method for the various tank car inspection areas. As with any NDE method, those allowed in the rulemaking have advantages, as well as limitations, that are identified later in this report. The use of a validation methodology to assess the applications, advantages and limitations of an NDE method is a valuable tool to assure inspection reliability. The validation methodology for the six NDE methods used in tank car inspection have been taken from Appendix T, Attachment A of the *AAR Manual of Standards and Recommended Practices Specifications for Tank Cars*, and Volume 10 of the American Society for Nondestructive Testing (ASNT), *Nondestructive Testing Handbook*.^(8, 9)

Note: Acoustic emission testing has been included since it is allowed under approved FRA guidelines and DOT exemption status.

3.3.1 Liquid Penetrant Test Method

References to this particular test method include liquid penetrant (LP) testing, penetrant testing (PT), or dye penetrant testing.

3.3.1.1 Summary

Liquid penetrant testing is a physical and chemical nondestructive testing process designed to expose discontinuities open to the surface. The liquid penetrant method relies on the capillary interaction between the penetrating liquid and the surface of the part being inspected. The liquid enters surface cavities and later emerges as visual evidence of discontinuities such as cracks, porosity, laps, or seams. With proper technique, liquid penetrant testing is capable of detecting a variety of discontinuities ranging in size from readily visible to microscopic. Liquid penetrants can consist of water or oil based visible or fluorescent dyes or alcohol (used in alcohol wipe tests).

3.3.1.2 Technical Background

Liquid penetrant testing is one of the oldest of modern nondestructive testing methods, the first documented use of this application is in railroad maintenance shops in the late 1800's. The parts to be inspected were immersed in machine oil for a set time and then removed with the excess oil wiped off of the surface with rags or wadding. The surface of the part was then coated with a white chalk powder or a mixture of chalk and alcohol. The bleed out of the oil trapped in the discontinuities caused a noticeable stain in the chalk coating identifying areas containing discontinuities.

The need for tools more sophisticated than machine oil and chalk sparked the development and introduction of fluorescent dye materials into the penetrating oil to make a fluorescent penetrant material in 1941. Non-fluorescent or visible dyes were introduced a little later. Chemistry developments have introduced water based as well as improved oil based penetrant formulations designed to provide different levels of sensitivity. Penetrant removal and development materials have also evolved to help enhance the penetrant process. The development and improvement of the penetrant materials are constantly being pursued to provide increased inspection process economics and address environmental concerns.

3.3.1.3 Applications

Liquid penetrant testing is widely used due to its relative ease and range of applications. It is easily applied to field inspections since it is based on physical and chemical properties rather than electrical or thermal phenomena. Production testing may introduce the use of automated PT testing, which when designed properly, can provide highly economical inspections.

The materials and geometries for which PT testing is applied include:

- Ferrous and nonferrous metals and alloys
- Fired ceramics and cermets
- Powdered metal products
- Glass, and some types of organic materials
- Complex shapes can be immersed or sprayed with penetrant to provide complete surface coverage

Advantages of the liquid penetrant test method include:

- Rapid, simple, large coverage possible (complete surface of part being inspected)
- Economical to use
- Can be used on a variety of materials and shapes with minimum capital investment
- Many parts can be processed simultaneously in batch processing or in continuous penetrant processing systems
- Applicable to all solid, homogeneous materials including metals and alloys, ceramics and cermets and organic resins (plastics)

Limitations of the liquid penetrant test method include:

- Cannot detect subsurface discontinuities that are not open to the exposed surfaces of the part being inspected
- Does not reveal depth of discontinuities
- Cannot reveal location or provide indications of discontinuities that are filled with foreign substances that seal internal defect cavities so as to totally block the entry of penetrating liquid or on surfaces that have been peened or smeared by mechanical treatments. Discontinuities on excessively porous or rough surfaces may be masked by overall bleed-out of penetrant

3.3.1.4 Railroad Tank Car Applications using Liquid Penetrant Testing

The railroad tank car industry currently uses the liquid penetrant method for inspection of welds accessible by the technician and as a tool for spot checking areas on the tank containing suspected surface discontinuities. The primary type of penetrant used is a water washable visible red dye provided from either a spray can or a penetrant liquid applied via a spray bottle.

Although fluorescent penetrant inspection is usually the more sensitive method visible dye is often preferred due to its ease of use in field environments.

The liquid penetrant test technique is performed to the provisions of ASME Section V, Article 6, T-640 and the provisions identified in Appendix “T” of the *AAR Manual of Standards and Recommended Practices*, Section C-III, Specifications for Tank Cars M-1002.

3.3.1.5 Technical Considerations for Using Liquid Penetrant Testing for Tank Car Inspections

The foremost consideration when using the liquid penetrant method is that it will only detect discontinuities open to the surface. The area to be inspected must be clean and free of obstacles or contaminants such as paint, oil, grease, thermal coatings, or any other obstacle that prevents the penetrant from entering the discontinuity. The condition on the inside of the discontinuity will also affect the ability of the penetrant to adequately enter a surface opening. If the inside of the discontinuity contains corrosion, oil, moisture, or any other contaminants, entry of the penetrant will be restricted. Mechanical operations such as shot peening, machining, abrasive blasting, buffing, grinding, or sanding will smear orpeen the surface of metals creating an obstacle for the penetrant to enter a discontinuity.

Special procedures must be used when inspecting porous areas or PT testing is impractical since the penetrant quickly enters the pores and the penetrant material becomes trapped and may not completely wash out during penetrant removal operations. The trapped penetrant will reappear during development and may mask any discontinuities present. Materials used in the manufacturing of penetrants, solvents, and some types of developers have very good wetting and detergent properties. The liquid penetrant materials can clean metal so thoroughly that rust will begin almost immediately if a corrosion inhibitor is not applied. The penetrant materials may cause irritation if allowed to remain in contact with the skin for extended periods.

Post-cleaning of the inspection area is very important. If penetrant is allowed to remain inside the discontinuities, the growth rate can be influenced by the presence of corrosion. The lack of penetrant removal may also hamper the penetrating ability during future or follow-up penetrant inspections.

The keys to providing a reliable liquid penetrant inspection are:

- Proper pre-cleaning and surface preparation
- Sufficient dwell time for the penetrant
- Sufficient removal of excess penetrant prior to developing
- Proper application of developer and sufficient developing time
- Post-cleaning at the inspection area

3.3.1.6 Status of Liquid Penetrant Testing in Current Tank Car Inspections

Liquid penetrant inspection is currently permitted for all structural integrity inspections. The decision to use the PT method for tank car inspections is at the discretion of the car owner or company responsible for performing or requiring the performance of nondestructive evaluation. PT testing is allowed for all nozzles and welded attachments identified for structural integrity inspections in 49 CFR 180.509. (See NDE drawings for further details of allowed PT inspection areas.)

3.3.1.7 Recommended Future Applications in Tank Car Inspections

Liquid penetrant testing provides an economical NDT method to evaluate discontinuities that are open to the surface. Many weld defects found during tank car inspections originate at the surface or slightly below the surface (eventually propagating to the surface); which suggests that liquid penetrant testing should continue to be a valuable method for tank car inspection.

Reliability of inspections can be enhanced through emphasis on operator training, equipment calibrations, and inspection procedures. Through familiarity of the test method, the inspection area and the specifications pertaining to the evaluation operator proficiency would be increased. The use of penetrant materials that provide the desired sensitivity of inspection should be emphasized and kept uniform from inspection to inspection. If the inspection process is changed the operator should be familiarized with the changes prior to performing further inspections.

3.3.2 Magnetic Particle Test Method

Although magnetic technology is used in a variety of nondestructive testing methods, basic magnetic particle testing continues to provide a wide range of applications in the inspection of ferrous materials and is referred to as magnetic particle testing (MT).

3.3.2.1 Summary

MT is a nondestructive test method that uses magnetic leakage fields and indicating materials to disclose surface and near surface discontinuities. Magnetic particle testing can reveal surface discontinuities that may be too small or too tight to be seen with the unaided eye. The MT indications form at the surface above a discontinuity identifying the location and the approximate size of the discontinuity. MT may also reveal defects located slightly below the surface, depending on their size.

3.3.2.2 Technical Background

MT is used to reveal surface and slightly subsurface discontinuities in materials susceptible to magnetization. It is used in the inspection of raw materials and in the evaluation of service related discontinuities.

The MT method is based on the principle that magnetic flux is locally distorted by a discontinuity. Due to the phenomena of flux leakage the magnetic field exits and reenters the magnetized object at the discontinuity. The leakage field attracts the magnetic particles applied to the test area forming an indication or outline of the discontinuity.

3.3.2.3 Applications

The use of magnetic particle testing for inspection of materials considers the origin of discontinuities in all stages of fabrication and service. MT is used from the initial production and processing stages of pouring and solidification to the production of shapes including sheet, bar, pipe, tubing, forgings, and castings. The production and processing inspections are performed to identify inherent discontinuities and primary processing discontinuities such as laps, bursts, and stringers, which are open to the surface or slightly subsurface. The introduction of a part into secondary processing (manufacturing and fabrication) where raw stock is converted into finished components requires inspection for discontinuities introduced from forming, machining, welding, and heat treating. In-service testing is performed to identify discontinuities introduced due to overstress conditions and fatigue cracking.

The materials and geometries for which MT is applied include:

- Materials:
 - Ferromagnetic materials
- Features and forms:
 - Surface and substrate; regular, and uniform shapes

- Example structures and components:
 - Bars, forgings, weldments, extrusions, fasteners, engine components, shafts, and gears

Advantages of the magnetic particle test method include:

- Relatively economical and expedient
- Inspection equipment is considered portable
- Unlike dye penetrants, magnetic particle can detect some discontinuities slightly below the surface

Limitations of the magnetic particle test method include:

- Access, contact and/or preparation:
 - Requires clean and relatively smooth surface
- Probe and object limits:
 - Fixturing required for holding and magnetizing some parts
- Sensitivity and/or resolution:
 - Cracks to the order of 0.02 in. (0.5 mm) major dimension
- Interpretation limits:
 - Magnetic field alignment and field strength are critical
- Other limits:
 - Follow-up metal removal may be required
 - Part demagnetization may be problematic
 - Removal of powder and vehicle required
 - Applicable only to ferromagnetic material
 - Thick coatings may mask rejectable discontinuities
 - Requires use of electrical energy for most applications

3.3.2.4 Railroad Tank Car Applications using Magnetic Particle Testing

The railroad tank car industry currently uses the magnetic particle test method for the inspection of welds accessible by the technician and as a tool for spot checking areas on the tank containing suspected surface or slightly subsurface discontinuities. A portable, hand-held yoke is the primary magnetizing equipment used for tank car inspection. The hand-held yoke is maneuverable and allows adjustment of the legs for either fixed distance or articulating inspections. The hand-held probe contains small transformers that generate low voltage and high current that generates a longitudinal magnetic field. A longitudinal field exists between the legs (poles) of the unit when the probe is coupled to the test surface.

Magnetic particle yokes are usually cable connected to a mobile or portable unit that provides the magnetizing current, although some models do contain their own re-chargeable portable power source. Yokes are specified by their lifting ability or the surface field created between their poles. Lifting power is determined by lifting a certified ferrous block while the magnetic field is being generated. The block's weight must be documented and traceable to the National Institute of Standards and Technology (NIST). The surface field is measured with a certified gauss meter.

The magnetic particle test technique is performed to the provisions of ASME Section V, Article 7, T-740 and the provisions identified in appendix "T" of the AAR *Manual of Standards and Recommended Practices*, Section C-III, Specifications for Tank Cars M-1002.

3.3.2.5 Technical Considerations

The magnetic particle test method reveals surface and/or slightly subsurface discontinuities in ferrous materials only. Magnetic particle testing can not be used on non-magnetic materials including glass, ceramics, plastics, aluminum, magnesium, copper, and austenitic stainless steel alloys. The penetrating ability is limited but can be determined by the applied field strength and the size, depth, type, and shape of the discontinuity. Special techniques and equipment are available to improve the test's ability to detect subsurface discontinuities.

The magnetic field produced is directional; therefore, positional limitations require that for best results the generated field must be perpendicular to the discontinuity. A complete evaluation of an inspection area requires that the magnetizing field be applied in different directions to detect discontinuities with different orientations. The magnetic field is generated using either alternating current (AC) or direct current (DC), depending on the depth of field required. AC generation of the magnetic field provides greater sensitivity to surface defects, while DC generation of the magnetic field allows for deeper penetration into the part. Demagnetization of the part is usually required after magnetic particle testing. The MT process consists of the following operations:

- Applying a suitable magnetic flux into the test object
- Applying either dry powder or a liquid suspension of magnetic particles at the inspection area
- Evaluating test indications under suitable lighting conditions
 - Ample white light for non-fluorescent applications

- Ample ultraviolet light for fluorescent applications
- Reduced white light (two lumens maximum) for inspection and viewing of fluorescent indications

3.3.2.6 Status of Magnetic Particle Testing in Current Tank Car Inspections

Magnetic particle testing is currently permitted for all structural integrity inspections. The decision to use the MT method for tank car inspections is at the discretion of the car owner or company responsible for performing or requiring the performance of nondestructive evaluation. MT is allowed for all nozzles and welded attachments identified for structural integrity inspections in 49 CFR 180.509. (See NDE drawings for details of allowed MT inspection areas.)

3.3.2.7 Recommended Future Applications in Tank Car Inspections

Magnetic particle testing provides an economical NDT method to evaluate discontinuities that are open to the surface and/or slightly subsurface. Many weld defects found during tank car inspections originate at the surface or slightly below the surface (eventually propagating to the surface); which suggests that magnetic particle testing should continue to be a valuable method for tank car inspection. The magnetic particle test can be performed with minimal surface preparation as it can provide a reliable inspection under thin coats of some paints and can detect slightly subsurface discontinuities.

Reliability of inspections can be enhanced through emphasis on operator training, equipment calibrations, and inspection procedures. Operator proficiency would be increased through familiarity of the test method, the inspection area, and the specifications pertaining to the evaluation. The use of magnetic particle equipment and materials that provide the desired sensitivity of inspection should be emphasized and kept uniform from inspection to inspection. If the inspection process is changed the operator should be familiarized with the changes prior to performing further inspections.

3.3.3 Radiographic Test Method

The use of radiation to evaluate materials for industrial applications is referred to as radiography or radiographic testing (RT). Similar applications are used in the medical field and are referred to as radiology.

3.3.3.1 Summary

Radiographic testing is a nondestructive test method which uses radiant energy in the form of X-rays or gamma rays for nondestructive testing of opaque objects in order to produce graphical records on a medium that indicates the comparative soundness of the object being tested. The radiographic process provides an evaluation into the cause and significance of subsurface discontinuities indicated on a radiograph (film). The determination of the acceptability or rejectability of the material is dependent upon the radiographic specifications and/or standards governing the material.

3.3.3.2 Technical Background

Radiography is one of the oldest and most widely used NDE methods. The RT method is used extensively in the industrial and scientific arenas and has continued to produce technical and economical advances in the area of NDE. Special equipment and techniques available today include microfocus x-ray generators, portable linear accelerators, radioscopy, neutron radiography, paper imaging, digital image analysis, and image enhancement.

Basic radiography uses a photographic record (radiograph) produced by the passage of x-rays or gamma rays through an object onto a film. When the film is exposed a latent image is produced in the film's emulsion. The exposed areas become dark when the film is developed, with the areas receiving the greatest amount of exposure becoming darkest. Once the film has been developed it is placed into a solution that stops further development. The film is then rinsed and placed into a fixing solution that dissolves the non-darkened portions of the emulsion's sensitive salt. The film is then washed and allowed to dry prior to handling, interpretation, and filing.

Radiation can be generated as x-rays or gamma rays. X-rays are produced when streams of high-energy electrons are allowed to impinge on a metal target, producing photons by deceleration of the electrons. The X-rays can also be produced by tangential acceleration of high-energy electrons by a very strong magnetic field. Gamma rays are electromagnetic radiation originating from the nuclei of atoms and have very short wavelengths. X-rays originate in the extra-nuclear structure of the atom while gamma rays are emitted by atomic nuclei in the state of excitation. The emission of gamma rays occurs in close association with the emission of alpha and beta particles. Photon energy produced by x-rays ranged from 50 electron volts to 25 million electron volts. The range of photon energy produced by gamma radiation is from 10,000 to 25 million electron volts.

3.3.3.3 Applications

Industrial radiography is extremely versatile. Radiographed objects range in size from microscopic electronic parts to mammoth missile components. It has been used for evaluation of almost every known material and manufactured form over a variety of castings, weldments and assemblies. Radiographic examination has been applied to organic and inorganic materials, to solids, liquids, and even to gases. Production of radiographs can range from an occasional examination of one or several pieces to the examination of hundreds of pieces per hour. The wide range of radiographic applications has resulted in the establishment of independent, professional radiographic laboratories as well as radiographic departments within manufacturing plants.

The materials and geometries for which RT is applied include:

- Materials:
 - Metals, nonmetals and composites
- Features and forms:
 - Range of objects and features
- Example structures and components:
 - Welds which have voluminous discontinuities such as porosity, incomplete joint penetration and/or corrosion
 - Lamellar type discontinuities such as cracks and incomplete fusion can be detected with a lesser degree of reliability
- May also be used in certain applications to evaluate dimensional requirements such as fit-up, root conditions, and wall thickness

Advantages of the radiographic test method include:

- Radioisotopes:
 - Generally not restricted by type of material or grain structure
 - Surface and subsurface inspection capability
 - Radiographic images aid in characterizing discontinuities
 - Provides a permanent record for future review
- X-ray machines:
 - Adjustable energy levels, generally produces higher quality radiographs than radioisotopes, all other advantages of radioisotopes

Limitations of the radiographic test method include:

- Access, contact and/or preparation
 - Two-sided access required for external source

- Probe and object limits
 - Special filters, screens and/or scintillators needed for image quality
- Sensitivity and/or resolution
 - Resolution ranges to order of 2,000 line pairs per centimeter (787 line pairs per inch)
- Interpretation limits
 - Image quality impaired by scatter radiation and finite source or focal spot size gamma fogging; requires control of chemicals and photo-processing conditions for reproducible results
- Other limits
 - Planar discontinuities must be favorably aligned with radiation beam to be reliably detected
 - Cost of radiographic equipment, facilities, safety programs and related licensing is relatively high
 - A relatively long amount of time between exposure process and availability of results

3.3.3.4 Railroad Tank Car Applications using Radiographic Testing

The railroad tank car industry currently uses the radiographic test method for the inspection of tank car and tank car components during the manufacturing process, as well as for repair and in-service evaluations. Both X-ray and gamma radiation sources are used for evaluation of tank cars with the selection of the process dependent upon car location, accessibility, and available power sources. Radiographic services are performed by in-house radiographic departments or subcontracted out to qualified radiographic contractors/laboratories.

The radiographic technique is performed to the provisions of ASME Section V, Article 2, T-270 and the provisions identified in appendix “T” of the AAR *Manual of Standards and Recommended Practices*, Section C-III, Specifications for Tank Cars M-1002.

3.3.3.5 Technical Considerations

The essential features for radiographic testing include: the level and amount of radiation energy generated, beam-to-discontinuity orientation, and speed of film. The exposure of a radiograph is obtained from emanation of radiation from a focal spot during x-radiography and the capsule containing the radioactive source for gamma radiography. In either case, the radiation proceeds in straight lines towards the inspection object. The amount of radiation transmitted through the object is dependent on the nature of the material and its thickness. The amount of radiation energy passing through an object at a void will display a higher film density than the surrounding areas due to a reduction of material at the void.

The density of a radiograph depends on the amount of radiation absorbed by the emulsion of the film. The amount of radiation generated depends on the total amount of radiation emitted by the x-ray tube or the gamma ray source, the amount of radiation reaching the specimen, the proportion of this radiation that passes through the specimen, and the intensifying action of the screens used. The emission of radiation by x-ray tube depends on the tube current (milliamperage), kilovoltage, and the time the tube is energized. Gamma radiation emission is approximately proportional to the activity (curies) of the source. This proportionality would be exact if it were not for the absorption of the gamma rays within the radioactive material itself.

The major difference between x-ray and gamma ray capabilities is that x-ray allows the operator to change the kilovoltage and milliamperage of the x-ray machine, therefore adjusting the radiation intensity being generated. To adjust the intensity for gamma radiography one must change the radiation source altogether; i.e., cobalt-60 (1.33 million electron volts) in place of iridium-192 (0.60 million electron volts). The advantage of gamma radiography includes the portability of the radiation source for both low- and high-energy radiography.

3.3.3.6 Status of Radiographic Testing in Current Tank Car Inspections

Radiographic testing is currently permitted for all structural integrity inspections. The decision to use the RT method for tank car inspections is at the discretion of the car owner or company responsible for performing or requiring the performance of nondestructive evaluation. RT is allowed for all nozzles and welded attachments identified for structural integrity inspections in 49 CFR 180.509.(See NDE drawings for further details of allowed RT inspection areas.)

Radiography is also used in manufacturing inspections of welds, joints and parent materials.

3.3.3.7 Recommended Future Applications Tank Car Inspections

Radiographic testing provides an NDT method to evaluate discontinuities that are surface and/or subsurface. The usefulness of radiography is it provides photographic proof of the presence and/or non-presence of discontinuities in an object. The location, size, and orientation of discontinuities can be determined by using appropriate angles and orientations of the radiation source and proper radiographic film placement.

Technological advancements from research and development in the area of radiography provide a large number of RT processes for use in railroad tank car inspection. The introduction of lighter,

more powerful, and more portable x-ray machines as well as new sources of radiation such as neutron generators and radioactive isotopes offer new methods of radiation generation. The introduction of digitized film evaluation systems and real time radiography help to increase inspection sensitivity and speed of evaluation.

Reliability of inspections can be enhanced through emphasis on operator training, equipment calibrations, and inspection procedures. Operator proficiency would be increased through familiarity of the test method, the inspection area and the specifications pertaining to the evaluation, The use of radiographic equipment and materials that provide the desired sensitivity of inspection should be emphasized and kept uniform from inspection to inspection. If the inspection process is changed the operator should be familiarized with the changes prior to performing further inspections.

3.3.4 Ultrasonic Test Method

The use of sound waves in the range of 20 kHz to 25 MHz to generate acoustic energy for use in the interrogation of materials is referred to as ultrasonic testing (UT).

3.3.4.1 Summary

Ultrasonic testing is a versatile NDT method used to test a variety of metallic and nonmetallic materials. UT only requires access to one side of a specimen and does not present a hazard to the operator or nearby personnel during testing.

3.3.4.2 Technical Background

The UT method applies ultrasonic sound to a specimen to determine its soundness, thickness, or some physical property. The sound energy originates at the transducer and causes material displacements within the specimen. The transducer converts electrical energy to mechanical or mechanical energy to electrical. Electrical energy is applied by two wires connected to a piezoelectric crystal in the transducer causing expansion and contraction of the crystal, forming mechanical vibrations. The transducer can also convert mechanical energy back to electrical energy so a transducer can both send and receive energy (be a transmitter, a receiver, or a combination of both).

The two basic ultrasonic test systems are pulse-echo and through transmission inspections. The pulse-echo system is the most widely used system. During pulse-echo inspections, short, evenly

timed pulses of ultrasonic waves are transmitted into the object being tested. The pulses reflect from discontinuities in their path or from any other boundaries they may strike with the received reflections displayed on a cathode ray tube. The same transducer can be used as both the transmitter and receiver. The through transmission technique requires the use of two transducers, one for transmitting and one for receiving. Either short pulses or continuous waves are transmitted into the object. The quality of the material is measured by the loss of energy as it travels through the material. A discontinuity is identified when either the received signal has a noticeable drop in amplitude or is lost altogether.

The two test methods normally used in ultrasonic testing are contact testing and immersion testing. Contact testing is achieved by applying a thin layer of couplant to the test object and scanning the transducer over the part. Immersion testing is performed by immersing both the transducer and the material in a tank of couplant (usually water). Contact testing is more commonly used in field and production applications whereas immersion testing is used in research and development although it is used for some production applications.

The location of discontinuities in a test part is determined by the presence of a spike (PIP) on the cathode ray tube (CRT). The CRT horizontal display is divided into convenient increments such as inches or centimeters. At a given sensitivity setting the amplitude of the PIP is determined by the strength of signal generated by the sound wave. The CRT displays two types of information: the distance or time of the discontinuity from the transducer and the relative magnitude of the reflected energy.

3.3.4.3 Applications

Ultrasonic methods are commonly used for discontinuity detection and thickness measurements. Discontinuities detected may include voids, cracks, inclusions, segregation, laminations, bursts, flakes, or welding anomalies. The discontinuities may originate from the raw material, occur during manufacturing and heat treatment, or occur in service from fatigue, corrosion, and other causes.

The materials and geometries for which UT is applied include:

- Materials:
 - Metals, nonmetals, and composites

- Features and forms
 - Substrates, joints and bonds, and structure components
- Process and control applications
 - Heat treatment, grinding, joining, crack monitoring and control (flaw sizing)
- In situ and diagnostic applications
 - Rolling mill process control and monitoring
- Example structures and components
 - Sheet, plate, bar and tube stock; castings; forgings; welds; airframe and engine components; pressure vessels; and nuclear reactor components

Advantages of the ultrasonic test method include:

- Most sensitive to planar type discontinuities
- Test results known immediately
- Portable
- Most ultrasonic flaw detectors do not require an electrical power outlet
- High penetration capability

Limitations of the ultrasonic test method include:

- Access, contact and/or preparation
 - Access to one side and liquid coupling to object
- Probe and object limits
 - Requires special probes, coupling and alignment fixtures usual
- Sensitivity and/or resolution
 - Flaws to order of 0.0004 in. (0.01 mm) in size
- Interpretation limits:
 - Ambiguous signals may arise as a result of scatter effects, multiple reflections and geometric complexity
- Other limits:
 - Small or thin parts are difficult to inspect
 - Surface condition must be suitable for coupling of transducer
 - Couplant (liquid) required
 - Reference standards are required
 - Requires a relatively skilled operator or inspector
 - May not detect fusion bonded interfaces such as:
 - Lack of fusion
 - Lack of penetration

3.3.4.4 Railroad Tank Car Applications using Ultrasonic Testing

The railroad tank car industry currently uses the ultrasonic test method for the inspection of tank car and tank car components during the manufacturing process and for repair and in-service evaluations. Pulse–echo, contact testing is primarily used for both thickness measurements and structural integrity inspections. Shear wave angles of 45, 60, and 70 degrees are used for angle beam inspection with a 0-degree (straight beam) transducer used for lamination detection prior to angle beam testing.

The ultrasonic technique is performed to the provisions of ASME Section V, Article 5, T-540 and the provisions identified in Appendix “T” of the *AAR Manual of Standards and Recommended Practices*, Section C-III, Specifications for Tank Cars M-1002.

3.3.4.5 Technical Considerations

Ultrasonic waves are mechanical vibrations so UT is best suited to detection of elastic anomalies and measurement of physical properties such as porosity, structure, and elastic constants.

Optical, magnetic, chemical, and other properties are not ordinarily indicated. In order of detectability, the anomalies typically determined with ultrasonics include geometric variations, gross discontinuities, minute discontinuities, and minute structure.

Ultrasonic instrumentation is electronic; indications are displayed and may be obtained in real time. This characteristic allows for rapid scanning with automatic positioning, plotting, and alarming. The ultrasonic beam almost instantaneously traverses the complete volume of a material under the transducer extending from the front to the back surface of the test object. Each incremental scan requires only a fraction of a second. The instrument response time is negligible, so practical test speeds are determined by factors such as the scanning mechanism, handling equipment, human reaction time, and pulse repetition rate.

The ultrasonic method permits testing of a wide range of part sizes and geometries. UT is capable of detecting internal, hidden discontinuities deep below the surface. Transducers and coupling wedges are available to generate waves of several types, including longitudinal, shear, and surface waves. Applications range from thickness measurements of thin steel plate to internal testing of large turbine rotors.

3.3.4.6 Status of Ultrasonic Testing in Current Tank Car Inspections

Ultrasonic testing is currently permitted for all structural integrity inspections. The decision to use the UT method for tank car inspections is at the discretion of the car owner or company responsible for performing or requiring the performance of nondestructive evaluation. UT is allowed for all nozzles and welded attachments identified for structural integrity inspections in 49 CFR 180.509. Ultrasonic testing is also used for thickness measurements of the tank car. (See NDE drawings for further details of allowed UT inspection areas.)

3.3.4.7 Recommended Future Applications in Tank Car Inspections

Ultrasonic testing provides an NDT method to evaluate discontinuities that are surface and/or subsurface. The usefulness of UT includes real time evaluation of the presence and/or non-presence of discontinuities in an object. The use of ultrasonics is desirable when access to only one side of the tank car is available (i.e., the inside of the tank car when jacketed or thermal coated). Ultrasonic equipment currently available can provide highly reliable evaluations when proper calibration procedures are followed and efficient signal interpretation is performed.

The technological advancements in ultrasonics provide a large number of UT processes available for use in railroad tank car inspection. The portability of ultrasonic equipment, along with the memory and storage capacity of the ultrasonic instruments, allows for faster and more efficient calibration processes. The increased storage capacities available with current machines provide the technician with documentation capabilities in the field that allow for rapid report generation. The variety of transducers available with different sizes, angles, frequencies, and material design introduce the possibilities for inspection at most locations of the tank car.

Reliability of inspections can be enhanced through emphasis on operator training, equipment calibrations, and inspection procedures. Operator proficiency would be increased through familiarity of the test method, the inspection area, and the specifications pertaining to the evaluation. The use of ultrasonic equipment and materials that provide the desired sensitivity of inspection should be emphasized and kept uniform from inspection to inspection. If the inspection process is changed, the operator should be familiarized with the changes prior to performing further inspections.

3.3.5 Visual Test Method

The method of nondestructive testing using electromagnetic radiation at visible frequencies is referred to as visual testing (VT). A visual inspection that uses tools such as magnifiers, borescopes, and flashlights to aid the technician in evaluation of an object is referred to as optically aided visual testing (OVT).

3.3.5.1 Summary

Visual testing is used to supplement most nondestructive tests through either visual interpretation of a radiograph (RT), signal interpretation on a CRT (UT), contrast between a liquid and a developer (PT), or identification of the accumulation of magnetic particles at a discontinuity (MT). Visual and optically aided visual tests use probing energy from the visible portion of the electromagnetic spectrum. Changes to the light's properties after contact with an object may be detected by human or machine vision. The detection of those property changes can be enhanced through the use of vision-enhancing accessories such as mirrors, magnifiers, or borescopes.

3.3.5.2 Technical Background

Visual testing has been referred to as the first method of nondestructive testing. It can be a very basic test or may be extremely complex with the introduction of light sources and elaborate optical investigation techniques. An advantage of many visual tests is that quantitative data can be provided more readily than other nondestructive tests.

Visual testing is performed for two primary reasons: to test exposed or accessible surfaces of opaque objects, and to test the interior of transparent test objects. Visual testing is used to determine quantity, size, shape, surface finish, reflectivity, color characteristics, fit, functional characteristics, and the presence of surface discontinuities. Lighting is a key environmental factor affecting visual tests. Although equipment variables such as borescope view angle and degree of magnification are important, no magnification is going to improve the image if the lighting is incorrect. Operator discomfort and fatigue also influence inspection results.

In the FAA report DOT/FAA/AAR-96/65 "Visual Inspection Research Project Report on Benchmark Inspections"⁽¹⁰⁾ written by Floyd Spencer of Sandia National Laboratories, a definition of visual inspection as defined in FAA Draft Advisory Circular AC 43-XX was expanded upon.⁽¹¹⁾ The initial definition was "...the process of using the eye, alone or in

conjunction with various aids, as the sensing mechanism from which judgements may be made about the condition of a unit to be inspected.” The FAA report identifies the eye as the primary tool for visual inspection but also states that the sense of sight is not acting alone during visual evaluations and in fact other senses such as touch, hearing, and even smell contribute to proper assessment during visual testing. Therefore, the definition of “visual inspection” identified in the Visual Research Inspection Program is:

“Visual inspection is the process of examination and evaluation of systems and components by use of human sensory systems aided only by such mechanical enhancements to sensory input as magnifiers, dental picks, stethoscopes, and the like. The inspection process may be done using such behaviors as looking, listening, feeling, smelling, shaking, and twisting. It includes a cognitive component wherein observations are correlated with knowledge of structure and with descriptions and diagrams from service literature.”⁽¹⁰⁾

3.3.5.3 Applications

Visual inspection is used to determine material or product quantity, size, shape, surface finish as well as fit, functional characteristics, and the presence of surface discontinuities. Testing can be performed with the unaided eye or with the use of equipment such as borescopes, magnifiers, mirrors, flashlights, microscopes, and photographic techniques. The use of mirrors and flashlights provide efficient tools for weld inspection and hard to get to corner inspections. Industrial fiber optic borescopes provide the capability to inspect remote or confined areas that basic aids cannot reach. Automated equipment in the form of borescopes or other video technology also provide real time documentation during inspection; whereas, the unaided visual inspection requires supplemental tools for documentation.

The materials and geometries for which VT is applied include:

- Materials:
 - Most materials to include metals, nonmetals, glass, and composites
- Features and forms:
 - Substrates, joints and bonds, structure components
- Example structures and components:
 - Most structures during all phases of manufacturing to in service environments

Advantages of the visual test method include:

- Economical
- Expedient
- Requires relatively little training or equipment for many applications

Limitations of the visual test method include:

- Limited to external or surface conditions only
- Limited to the visual acuity of the observer or inspector

3.3.5.4 Railroad Tank Car Applications using Visual Testing

The railroad tank car industry currently uses the visual test method for the inspection of tank car and tank car components during the manufacturing process and for repair and in-service evaluations. Visual testing is usually the first line of inspection in manufacturing and repair operations. The use of aids such as the industrial fiberoptic borescope provide the capability to inspect remote areas such as the outside tank shell on jacketed cars.

The visual technique, to include direct and remote visual testing, is performed to the provisions identified in Appendix “T” of the AAR *Manual of Standards and Recommended Practices*, Section C-III, Specifications for Tank Cars M-1002.

3.3.5.5 Technical Considerations for using Visual Testing for Tank Car Inspections

Visual testing is usually the initial inspection performed on an object whether it is planned or not.

The reliability of the inspections depends on the environment surrounding the inspection area. Environmental effects can either hamper or hinder visual inspection. The presence of rust or corrosion can either mask or provide evidence that a discontinuity exists. Determining which case the corrosion represents is dependent on the skill level of the operator performing the inspection.

Other factors that influence the operator during testing include:

- Importance of speed or accuracy
- Background reflections
- Inspector variables
 - Physiological processes
 - Psychological state
 - Experience
 - Health
 - Fatigue

The materials used in the manufacturing of railroad tank cars are usually on the darker end of the gray scale due to either painting or the nature of the material used. The environment this introduces makes proper lighting extremely important during inspection. When light interacts with the inspection area, the resulting light waves provide test signals that the operator can visually record. The recommended ratio of light intensity differentials between the inspection area and the surrounding background are 3:1 for backgrounds darker than the inspection area and 1:3 for backgrounds lighter than the inspection area.

The neural acuity of the human eye is a primary component of visual testing. However, there are times when the eye may not be sensitive enough or cannot access the test site. In these cases, mechanical and optical equipment should be used to supplement the eye while performing a visual inspection.

3.3.5.6 Status of Visual Testing in Current Tank Car Inspections

Visual testing is currently required for internal and external inspection of railroad tank cars. Internal and external visual inspection of the tank shell includes, as a minimum, heads for abrasion and overall tank inspection for corrosion, cracks, dents, distortions, defects in welds, or any other conditions that makes the tank car unsafe for transportation. Visual inspection is not required in areas that cannot be seen due to insulation or a thermal protection system. If inspection is required in areas having insulation of thermal protection other applicable NDE methods would be used. Piping, valves, fittings, and gaskets are visually inspected for corrosion or other conditions that make the tank car unsafe for transportation. An overall inspection of the tank car is performed to identify anomalies such as loose bolts or nuts, proper securement of tank car closures, threaded seats to assure tightness of excess flow valves, and legibility of required tank car markings. (See NDE drawings for further detail of required VT inspection areas.)

3.3.5.7 Recommended Future Applications in Tank Car Inspections

Visual testing provides a fast, economical NDE method to perform tank car inspections. The VT method provides effective determination of many surface discontinuities but is dependent upon lighting and operator influences. Visual testing alone may not be suitable for detection without the aid of supplemental equipment and/or test methods to adequately determine small discontinuities and tight cracks.

The technology provided from visual enhancement equipment, such as magnifiers and borescopes, should continue to be used to aid in the visual inspection of tank cars. It is essential that the operators are properly aware of the effect from lighting and the influence it has on evaluation. Reliability of inspections can be enhanced through emphasis on operator training and procedures. Operator proficiency would be increased through familiarity of the test method, the inspection area and the specifications pertaining to the evaluation. The use of available equipment and materials that provide the desired sensitivity of inspection should be emphasized and kept uniform from inspection to inspection. If the inspection process is changed, the operator should be familiarized with the changes prior to performing further inspections.

3.3.6 Acoustic Emission Test Method

The test method that measures transient elastic waves resulting from local internal micro displacements in a material is referred to as acoustic emission testing (AET). Other references to the AE phenomena include stress wave emission, stress waves, microseism, microseismic activity and rock noise.

3.3.6.1 Summary

Acoustic emission testing is a rapidly evolving nondestructive test method used to monitor structural integrity, leak detection, and characterization of materials behavior. Formally defined, AET is “the class of phenomena where transient elastic waves are generated by the rapid release of energy from localized sources within a material, or the transient elastic waves so generated.”

AET technology was introduced in the early 1960’s with the monitoring and detection of acoustic emission signals of growing cracks and discontinuities in pressure vessels. Sources of acoustic emission include earthquakes and rock bursts (naturally occurring sources), crack growth and moving dislocations (in metals), and matrix cracking and debonding (in composites).

3.3.6.2 Technical Background

There are two distinct differences between AET and other NDE methods. First, in the AET, the detected energy originates from the test object rather than the inspection equipment; and second, AET detects the dynamic process related to the degradation of a structure. AE examination is non-directional so emission sources will usually be detected with little or no dependency on their orientation provided a sensor is located in the vicinity of the emission source.

The AET monitors the dynamic redistribution of stress/strain levels at or adjacent to latent discontinuities within a material. This phenomenon requires that the material or structure be subjected to an applied load in order for AE monitoring to be effective. Stressing of the material can be accomplished by pressurizing a vessel or applying a tension or bending load to the structure.

AE is susceptible to mode conversion similar to ultrasonics; therefore, the further away an emission source is located from a sensor, the less sensitive the detected signal will be. The sensitivity of the AE test is also influenced by the acoustic transmission characteristics of the material being inspected, limiting the maximum sensor spacing that can be used. Background noise must be compensated for during AE testing as emissions can be generated from pump noise and other vibrations, as well as, leakage of the pressurizing system that could be mistaken as discontinuities without proper signal response interpretation.

3.3.6.3 Applications

Acoustic emissions testing can be applied to limited zones or global inspection of large structures. It can be used in the evaluation of metals, nonmetals, or a combination thereof by applying a load to those materials or components. AET has been used in the periodic or continuous monitoring of pressure vessels, the detection of fatigue flaws, the characterization of various failure mechanisms, and the monitoring of welds during the welding or cooling periods. AE is used for pre-service proof testing, in-service re-qualification testing, and leak detection/location.

The materials and geometries for which AET is applied include:

- Materials:
 - Metals, nonmetals and composites
- Features and forms:
 - Substrates, joints and bonds, structure components
- Example structures and components:
 - Most structures during all phases of manufacturing to in service environments as long as a sufficient load or environment is in place to allow the generation of acoustic emissions

Advantages of the acoustic emission test method include:

- Is a dynamic inspection method
- Provides evaluation of an entire structure during a single test

- Detects flaws affected by stressing regardless of geometry
- Requires only limited access

Limitations of the acoustic emission test method include:

- Does not provide accurate flaw sizing
- Requires a relatively skilled operator or inspector
- Defect response requires concentrated loading at the area to be interrogated
 - Requires excitation with a force that is higher than the last suspected largest loading
- Sensitive to false indications from environmental interruptions (wind, insects)

3.3.6.4 Railroad Tank Car Applications using Acoustic Emission Testing

The railroad tank car industry currently uses the acoustic emissions test method for the global inspection and qualification testing of various tank car designs. The AE method is also allowed for tank car re-qualification inspections under special exemptions obtained through the FRA’s Office of Safety. The AE test is conducted by either certified in house technicians or a certified contracting agency allowed to use the test method under the FRA’s exemption. If discontinuities are suspected due to signal responses acquired during AE testing the target areas must be evaluated further using supplemental NDE methods.

The acoustic emission technique is performed to the provisions identified in Appendix “T” of the *AAR Manual of Standards and Recommended Practices*, Section C-III, Specifications for Tank Cars M-1002. Appendix “T” identifies the following AAR written procedures for AE testing:

- “Procedure for Acoustic Emission Evaluation of Tank Cars and IM-101 Tanks”
- “Stub Sill Evaluation Procedure,” Annex Z

3.3.6.5 Technical Considerations

Acoustic emissions testing uses attributes of particular waves to characterize the material in which the waves are traveling. Waveform parameters that are regularly monitored in AE tests include frequency and amplitude. Factors related to tank cars that tend to increase the relative amplitude of the acoustic emission response include material characteristics such as high strength and high strain rate. The introduction of a discontinuity under the conditions mentioned may provide detectable signal responses during tank car inspection.

The proper signal response interpretation is essential with AE testing due to its sensitivity to emissions which can emanate not only from actual discontinuities but from environmental influences such as wind, rain, and other vibrations that may cause emissions. Many advancements have been made to continuously improve the evaluation capabilities of AE; from the equipment and procedures to operator training; but as with all NDE methods there is still room for improvement. Signal processing and interpretation are the areas that will have the greatest effect on the AET system. The tank car industry and their NDE contractors are actively addressing these areas.

3.3.6.6 Status of Acoustic Emission Testing in Current Tank Car Inspections

Acoustic emission testing is currently allowed under DOT exemption number DOT-E-10589, which allows AET "...for evaluating the continuing qualification of tanks that are mounted on or form part of a railroad freight car structure."⁽¹²⁾ Tank cars allowed for AE evaluation are DOT specification tank car tanks or tank car tanks built to an AAR specification that are – in lieu of the required hydrostatic qualification test method – qualified by an acoustic emission test method. The AE test must be in accordance with the procedures outlined in the "Procedure for Acoustic Evaluation of Tank Cars and IM-101 Portable Tanks," current issue. Holders of the DOT exemption are required to provide the FRA with stress analysis results of the tank car design along with the AE test procedure, supporting documentation, and the qualifications of each individual scheduled to perform the test. Under the exemption, any facility requesting participation under the exemption is required to obtain FRA approval prior to performing the AE test for tank car qualification or re-qualification. (See NDE drawings for further detail of allowed AE inspection areas.)

3.3.6.7 Recommended Future Applications in Tank Car Inspections

Acoustic emission testing is an NDT method that provides global evaluation of a tank car. AE is capable of identifying areas of suspected discontinuities that can be further evaluated using quantitative NDE methods such as PT, MT, RT, UT, or VT. Key considerations for AET is that it allows the test to be performed without removal of the tank car jacket and can produce an inspection of the entire car in a single operation. The AAR Tank Car Committee has charged the AE Task Force, a subgroup of the NDE Task Force, with the following issues to address:

- Procedure maintenance/revision
- Requirements for AET indication follow-up
- Single end testing of inboard welds for Rule 88B inspections
- Over-packaged cars
- Signature analysis
- Performance standard development
- Through-wall cracks

Reliability of inspections can be enhanced through emphasis on operator training, equipment calibration, and inspection procedures. Operator proficiency would be increased through familiarity of the test method, the inspection area, and the specifications pertaining to the evaluation. The use of available equipment and materials that provide the desired sensitivity of inspection should be emphasized and kept uniform from inspection to inspection. If the inspection process is changed, the operator should be familiarized with the changes prior to performing further inspections.

3.4 PROBABILITY OF DETECTION (POD)

The emergence of a damage tolerance approach to determine inspection intervals for an engineered structure, such as railroad tank cars, requires the quantification of the detectable flaw size for the NDE methods used during inspection. Traditionally, NDE methods have not been quantified and assumed capabilities have often been found to be in error. Damage tolerance techniques have initiated a revolution in NDE understanding, methods, and requirements. NTSB Safety Recommendations R-92-21 through R-92-24 address the suggested process of performing reliable inspection of railroad tank cars based on a damage tolerance approach. Damage tolerance design and maintenance will improve the reliability and confidence level of tank car acceptance and maintenance. NDE quantified using the POD approach — a key measure of NDE effectiveness -- is integral to damage tolerance requirements. The nature and complexity of developing and demonstrating inspection capabilities warrants pooling resources at a central location.

The probability of detection (POD) has been evaluated as a function of flaw size, that is, the fraction of flaws of a nominal size that are expected to be detected using a given inspection. At a meeting of the Tank Car NDE Steering Committee, held prior to baseline evaluations, a consensus was reached to produce artificial flaws in tank car samples if there were not enough

defects identified during baseline operations. The baseline tank cars did not contain enough defects to perform a POD study; therefore, test panels were developed from two of the general service type tank cars donated by GATX. Fatigue cracks were initiated and propagated at the circumferential butt weld areas of the test panels. The test panels developed represent the structural integrity inspection requirement for all tank shell butt welds within 2 feet of the bottom longitudinal centerline called for in 49 CFR Part 180.509.

3.4.1 POD Method Background

The quantification of NDE methods has been accurately accomplished by using the POD approach. The POD curve generated from this approach is an experimentally developed characterization of NDE capability based on a statistically significant number of test sample data. POD measurement is both specific and complex. Specific influences in POD determination include:

- Flaw (artifact) variables
- Test object variables
- NDE method variables
- NDE materials variables
- NDE equipment variables
- NDE procedure variables
- NDE process variables
- Calibration variables
- Acceptance criteria/decision variables
- Human factors

The initial method for generating the POD, as shown in the tutorial handbook *Quantitative NDE Capabilities (Probability of Detection) in Relation to HM-201 Rulemaking*,⁽¹³⁾ was based on work performed by Martin Marrietta for the National Aeronautical and Space Agency (NASA). The objective of the contracts was to perform exploratory research and characterization of typically applied NDE procedures. The data presentation method developed by Martin Marrieta, reported in NASA CR-2369 “The Detection of Fatigue Cracks Nondestructive Testing”⁽¹⁴⁾ was accepted by NASA and was later generally accepted as the method of data presentation.⁽¹⁴⁾ The data evaluation method identifying a 90/95 percent reliability for flaw detection originated with these NASA sponsored programs. The 90/95 percent reliability ratio identifies the 90th percentile point as that point where the probability of detecting a specific size

flaw 90 percent of the time at a confidence limit of 95 percent is achieved. The confidence limit is used as a calculated value to provide a margin in the POD value. This method has established many of the requirements in current specifications and was identified as a possible goal for use in railroad tank car nondestructive inspections during initial discussions of the HM-201 rule making.

In keeping with the program's aim to utilize advances in the quantification of NDE made in other industries, the expertise of Mr. Ward Rummel, P.E. / NDT Level III, D & W Enterprises Ltd. was contracted by TTCI. Mr. Rummel is a noted pioneer in the area of NDE. While working for Martin Marietta Aerospace, he was instrumental in developing the probability of detection (POD) to quantify or provide a figure of merit for NDE processes. Mr. Rummel conducted a tutorial for the Tank Car NDE Steering Committee and interested parties on July 28, 1997. The title of the tutorial was "Quantitative Nondestructive Evaluation Capabilities (Probability of Detection) in Relation to HM-201 Rulemaking." Mr. Rummel submitted a report to TTCI titled "Project Report, Tank Car Nondestructive Evaluation – Analysis, Tutorial and Recommendations."⁽¹⁵⁾ The report provides an overview of the tutorial and how the application of quantitative NDE can be utilized for tank car NDE. The approach identified in the report has been used during the POD development by TTCI. Parts of that report are included in the following:

The use of damage tolerance principles for initial "fitness for purpose" acceptance and for life cycle management offers potential for increase in tank car safety, for extension of tank car life, and for reduction of life cycle management costs. The primary difference between the traditional "SAFE LIFE" management and "DAMAGE TOLERANCE" management is the requirement to quantify an assumed flaw at initial acceptance and validation/revalidation that the tank contains no flaws larger than the assumed size at initial acceptance and at each inspection/maintenance interval. A quantitative measure of the design and acceptance/re-acceptance margin (structural integrity) is thus provided throughout the tank life and quantified criteria for retirement-for-cause are provided. It is important to emphasize that quantification of structural integrity is based on design requirements. Re-analysis and requirements identification is necessary for alternate (other than intended) use for incurred damage, as well as for rework and repairs.

The key to damage tolerance management is the identification (detection) and quantification of the flaw size assumed in the design and maintenance requirements. Detection must necessarily be nondestructive and must provide a quantified detection capability output. Non quantitative nondestructive evaluation (NDE) tools such as proof test (burst test) and acoustic emission monitoring are considered to be used as tools for analysis and design qualification, but do not provide a quantifiable output. NDE test methods that cannot be conventionally quantified are not considered for purposes of acceptance and life cycle management to damage tolerance requirements. Applicable NDE methods for purposes of damage tolerance management include:

- Visual inspection
- Liquid penetrant inspection
- Magnetic particle and magnetic flux methods
- Ultrasonic inspection
- X-radiography
- Eddy current
- Thermography

The established “figure of merit” for determining and assessing the capabilities of applied NDE procedures is by characterization of the “Probability of Detection -- POD.”

Implementation of damage tolerance principles requires both a change in the design practices and a change in inspection practices to include characterization, qualification, and validation of nondestructive evaluation procedures. It should be emphasized that design options may be established such that “traditional” NDE industry practices are sufficient to meet design requirements at the margins incorporated. Baseline data supporting the capabilities of industry practices are required, but re-qualification for each design/procedure application is not required. Specific NDE capabilities, validation, and demonstration are required for detection of flaws that are of a size that is below the documented industry capability limits. Validation and demonstration are most readily accomplished by the POD method.

The POD is a figure of merit for a specific inspection procedure and is achieved by subjecting a statistically significant number of flaws of varying size through an inspection procedure and plotting the detection/miss results as a function of flaw size.

Two standard methods of data analysis and plotting are:

- For HIT / MISS data, data are fit to a straight line using a maximum likelihood fit and the resultant is input to a LOGIT or PROBIT model to produce the probability of detection curve (Figure 14).
- For data that provides a scalar output with respect to flaw size, the causal model fit may be generated by plotting the NDE response output as a function of flaw size (a/ahat method) and then input to a LOGIT or PROBIT model to produce the probability of detection curve.

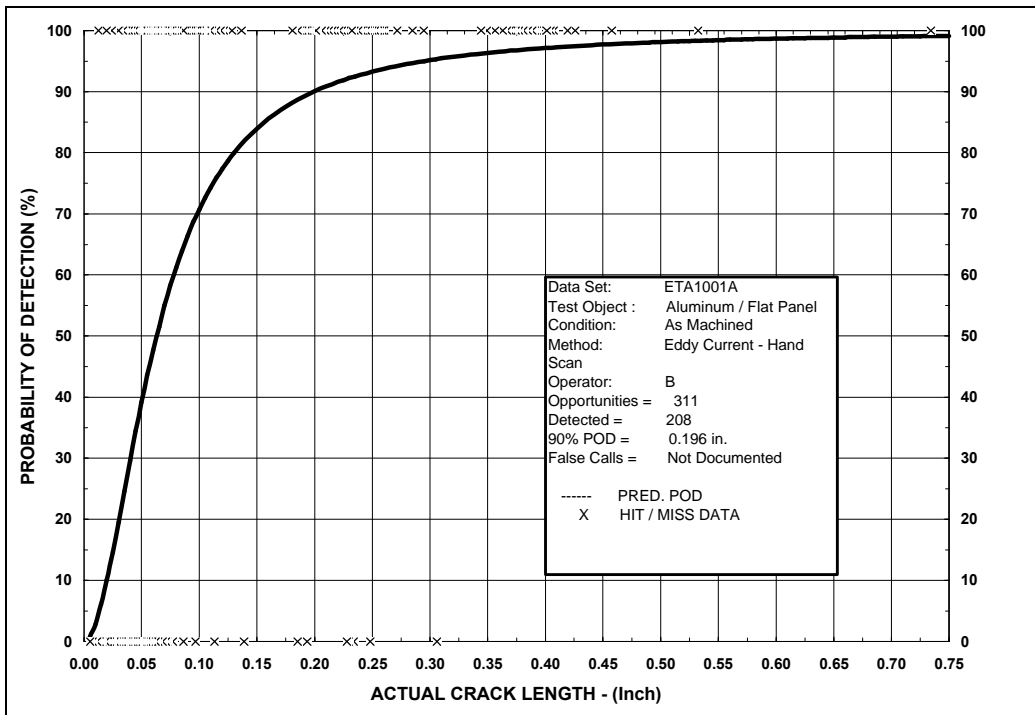

Figure 14. Typical Probability of Detection (POD) Curve

The LOGIT model, introduced by Berens and Hovey, was first applied to aircraft structures analysis. The LOGIT model may be described as:

$$POD(a) = F(a + b(\text{Log}(a))), \quad (1)$$

where α and β are parameters to be fit to the data and F is an increasing function of (a).

The log approximates the cumulative log-normal (LOGIT) distribution function - odds model and the data may be described by:

$$\text{POD}(a) = \frac{\exp [a + b \ln(a)]}{1 + \exp [a + b \ln(a)]} \quad (21)$$

where (a) = crack length.

The maximum likelihood or a/ahat methods are used to estimate the α and β parameters of the model. The PROBIT model was introduced by Dr. Steve Doctor and was first used in nuclear applications. The PROBIT model provides less severe penalty for a random miss of a large flaw and is therefor more generally applicable. The PROBIT model is the basis of current FAA programs.

It must be re-emphasized that probability of detection is affected by:

- Flaw (artifact) variables
- Test object variables
- NDE method variables
- NDE materials variables
- NDE equipment variables
- NDE procedure variables
- NDE process variables
- Calibration variables
- Acceptance criteria / decision variables
- Human factors

Once full POD capability is established, under conditions of maximum control of all variables, the effects of individual variables on overall capability can be assessed by comparison to the capability established under controlled conditions.

In like manner, subset samples may be used to ascertain data fit to the full POD population for purposes of comparison and re-qualification. The full POD method was used for purposes of personnel demonstration/method qualification. The first step in quantifying and assuring reproducibility of response to both established and new NDE procedures is the development of a calibration artifact. The type of artifact to be used with each NDE procedure should be consistent with those used and planned for use in industry. Care must be taken to preserve and periodically revalidate response and response linearity for the artifact. Each artifact

selected would be used as a “master gage” and response comparison of those artifacts used in the field would be periodically measured and documented by reference to the “master gage.”

It will be necessary to establish measurement procedures and provide a historical record of instrumentation and instrumentation maintenance actions in conjunction with “master gage” measurements.

Baseline PODs have been developed at TTCI using “standard industry” NDE procedures. This data is intended to provide the basis for design/life cycle maintenance assumptions for general NDE inspections. The data is to be anchored by application and response to the tank car master gages. The PODs have been established to provide a capability that can be used for qualification of “equivalent” NDE procedures and for personnel skill demonstrations. Master gages may also be used for specific NDE procedures developed for “critical inspections.”

Test tank cars from the defect library may be used to establish a signal analysis map of areas on the cars used to accept the capability values for field assessment and for tank car quality control/maintenance. The importance of the test cars is to provide the transfer of experience and skill development to the master gages to be inspected in the field. The primary measure of reliability in field inspection is repeatability and reproducibility.

The same signal levels from test tank car defects should be generated by repetitive inspections and by inspections performed by qualified inspectors. A cumulative record of the location and signal levels recorded by all operators will provide a confidence level in the capability of inspectors and in the reliability of the applied inspection.

3.4.2 Sample Crack Panel Generation

Test panels containing manufactured fatigue cracks were produced by TTCI to provide a statistically significant distribution of flaw sizes during NDE of the samples. A total of seven panels were developed containing different numbers and sizes of fatigue cracks. Test panels were made from tank car shell sections donated by GATX for use in the Tank Car NDE Program.

The panels were removed from the tank cars by torch cutting sections approximately 4 ft. ×11 ft. around the circumferential butt welds. The panels were then moved to the TTCI machine shop and saw cut into sections approximately 3.5 ft. ×10 ft. Areas around the weld containing heater coils were

also removed by cutting the coils away from the butt weld area by approximately 12 in. (30.48 cm). During development it was found that the coils were providing support to the weld area thus prohibiting early crack initiation. The heater coils were then removed entirely to provide uniformity between panels. Figure 15 is an example of a test panel prepared for crack initiation.



Figure 15. Fatigue Crack Test Panel during Preparation for Fatigue Initiation

The areas around the weld were buffed with an electric grinding brush and diamond scribe marks were placed at various locations at the toe of the weld to provide a starter notch for crack initiation. Crack growth was produced by fixturing a panel into a 150-kip load frame and dynamically loading the panel at the area where the scribe mark was placed. The setup for the panels is shown in Figures 16 and 17.

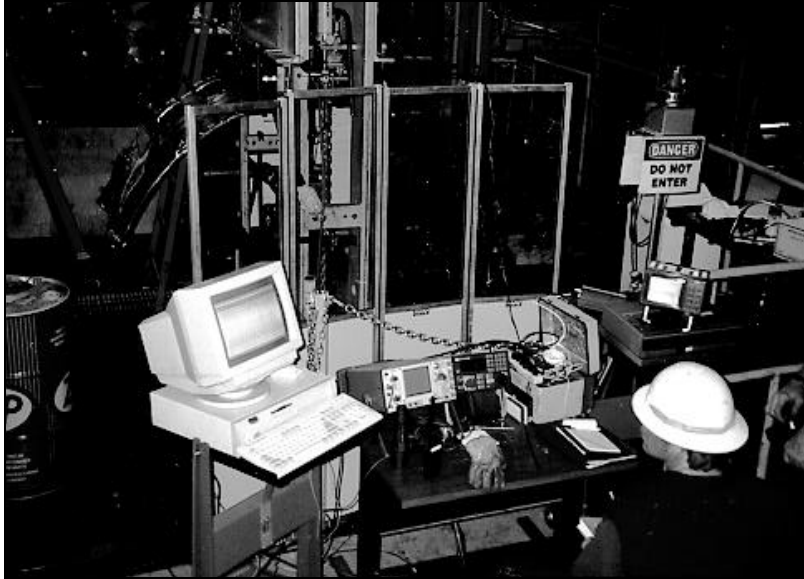

Figure 16. Instrumentation Used in the Setup for Tank Car Test Panel Dynamic Loading

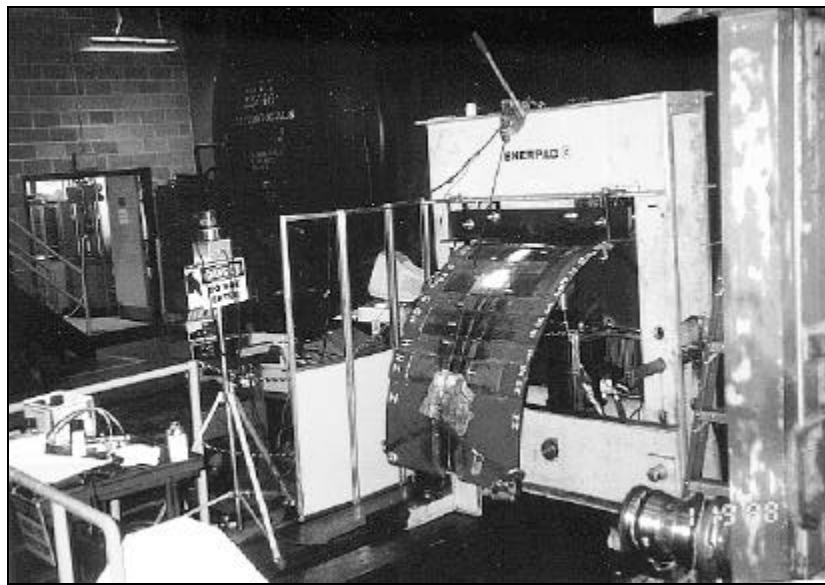

Figure 17. Tank Car Test Panel Setup for Dynamic Loading on the 200-kip Load Frame

The loading point used to produce the fatigue cracks was an oval tip approximately 0.19 in. \times 0.38 in. (0.483 cm \times 0.965 cm) welded to the top of the platen. The oval-shaped platen tip was designed to provide a point load at the opposite side of the test panel from where the diamond scribe marks were made. Figure 18 shows the placement of the platen adjacent to the butt weld prior to dynamic loading. The scribe marks on the test panels were generally in the range of 0.06 to 0.10 in. (0.15-0.25 cm) in length and were manually applied. The depth of the notches were not measured but were estimated to be about 0.02 to 0.03 in. (0.05-0.08 cm).

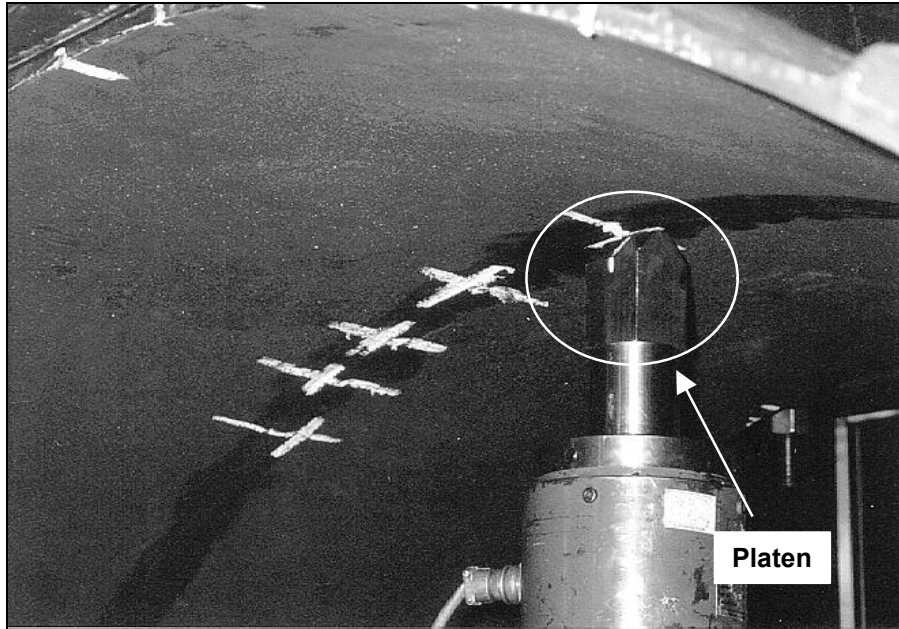

Figure 18. Position of the Platen Adjacent to the Butt Weld Prior to Dynamic Loading

The test panels were taken from retired tank cars and the material is representative of the ASTM A515 Grade 70 steel used for tank car fabrication. The tank panel thickness is approximately 0.44 in. (1.12 cm) and the thickness at the butt weld area is approximately 0.61 in. (1.55 cm). Mechanical properties for ASTM A515 Grade 70, as specified in Volume 1 of the *ASM Metals Handbook*, are:

- Tensile strength - 79 to 90 ksi (485 to 620 MPa)
- Yield strength - 38 ksi (260 MPa)
- Minimum elongation in 2 in. (50 mm) is 21 percent

The cracks were grown in bending under a maximum dynamic load of 25,000 pounds (25 kips). The mean load was set at 15 kips with a range of ± 10 kips. The load setting at a maximum dynamic load of 25 kips was determined to be too high as the platen was indenting the material at the areas of point loading. It should be noted that although the setup samples were indenting, fatigue cracks did propagate from the scribe marks. The maximum dynamic load was then reduced to 17 kips with the load set at a mean of 12 kips with a range of ± 5 kips. The frequency during dynamic loading was set at 10 hertz.

A 20 \times video camera was magnetically mounted to the test panel to monitor crack initiation and growth. The camera was electronically connected to both a video monitor and VHS recorder to

allow the technician to identify and record crack initiation and growth. Fluorescent liquid penetrant was placed at the scribe mark, allowed to dwell, and then cleaned from the area around the scribe. Developer was then applied at and around the scribe area. A fluorescent light was attached to the load frame to illuminate the scribe area and provide a better contrast for the technician to identify any indication of crack initiation and growth. A magnetic rule was placed parallel to the scribe mark to provide a tool for the technician to estimate crack length during loading. A photograph of the setup is shown in Figure 19.

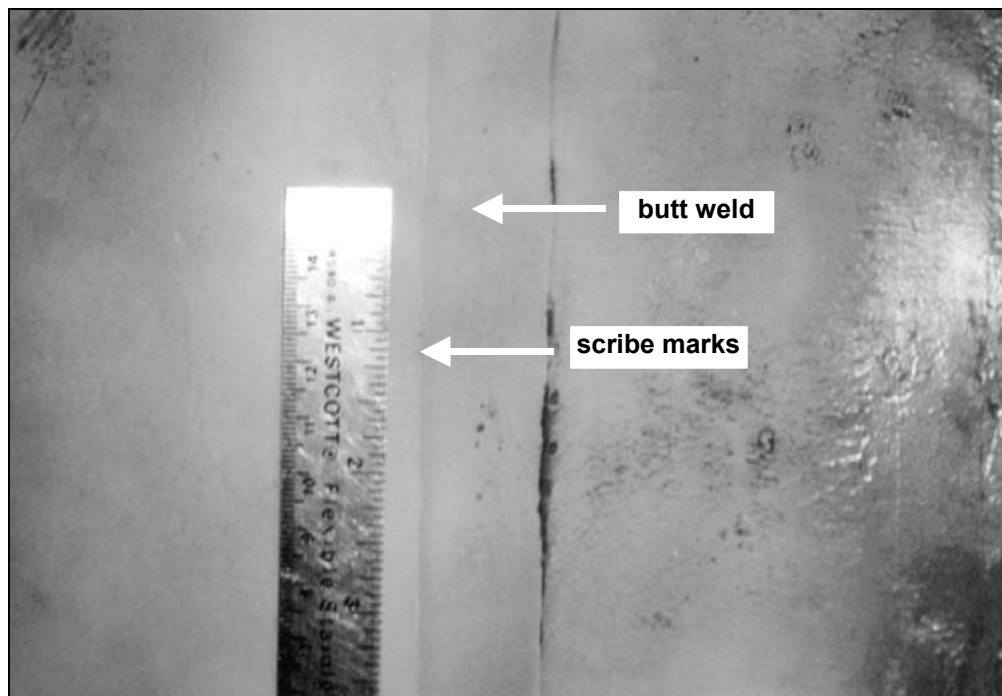

Figure 19. Test Setup Around Butt Weld during Crack Initiation and Propagation

The first several toe cracks generated from the test setup were evaluated and the crack length measured using optically aided visual, fluorescent liquid penetrant, and magnetic particle inspections. The cracks were then broken open to correlate the measurement results between the NDE methods and the actual size of fatigue development. The correlation in size between the NDE and the actual measured length was within approximately 0.10 in. The photographs in Figures 20 and 21 show the crack samples that were evaluated and broken open. Figure 22 illustrates the effect of overloading when the maximum load was set at 25 kips and the crack shown in Figure 23 illustrates a higher level of control once the load was adjusted to a maximum of 17 kips. The overload environment resulted in the indentation of the test panel at the contact point. Crack initiation and growth occurred in both the longitudinal and the transverse

directions. The lower load environment also produced transverse cracks in some cases, but the predominant orientation of cracking was in the longitudinal direction.

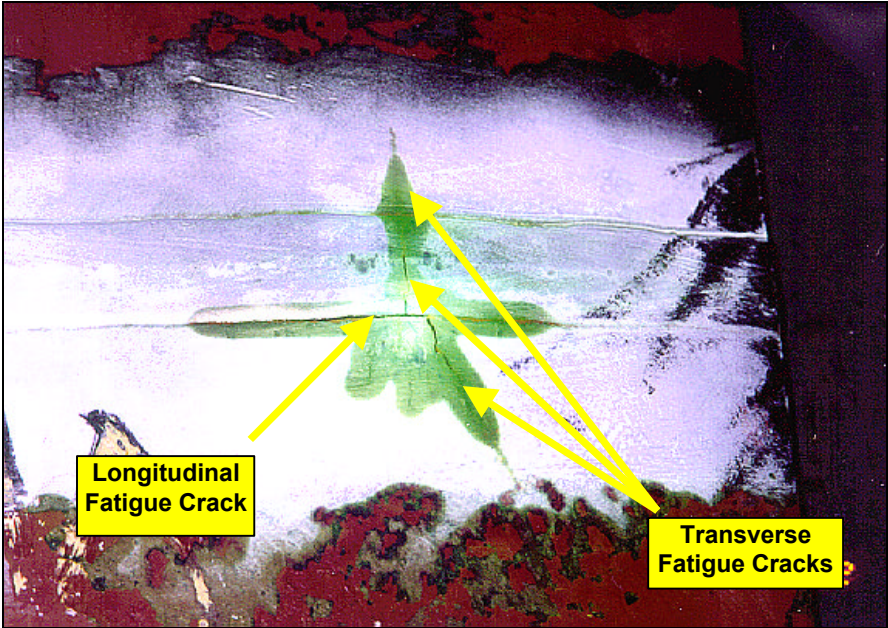

Figure 20. Fatigue Cracks Initiated Under a 25-kip Maximum Dynamic Load

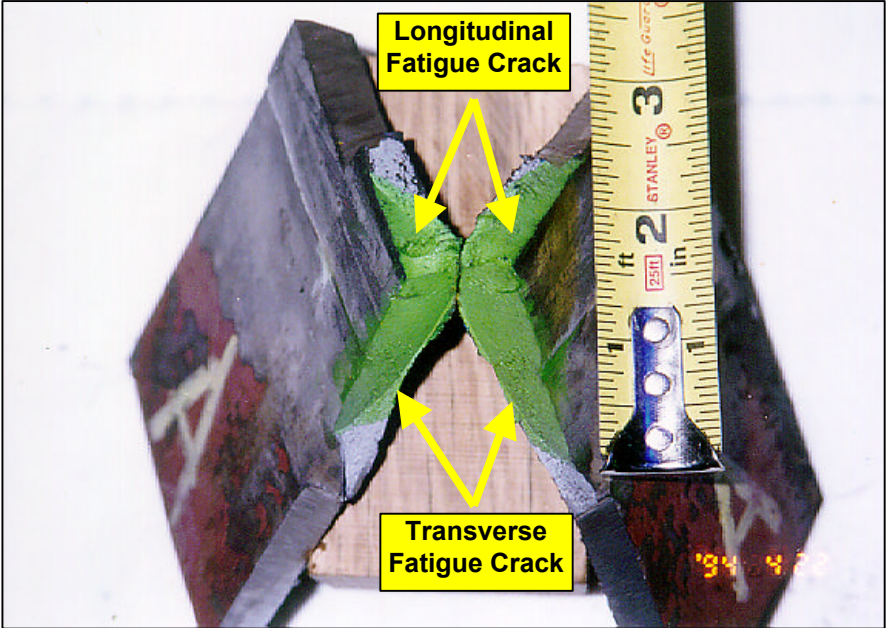

Figure 21. Fatigue Cracks from Figure 20 Broken Open and Showing Propagation in the Longitudinal and Transverse Directions

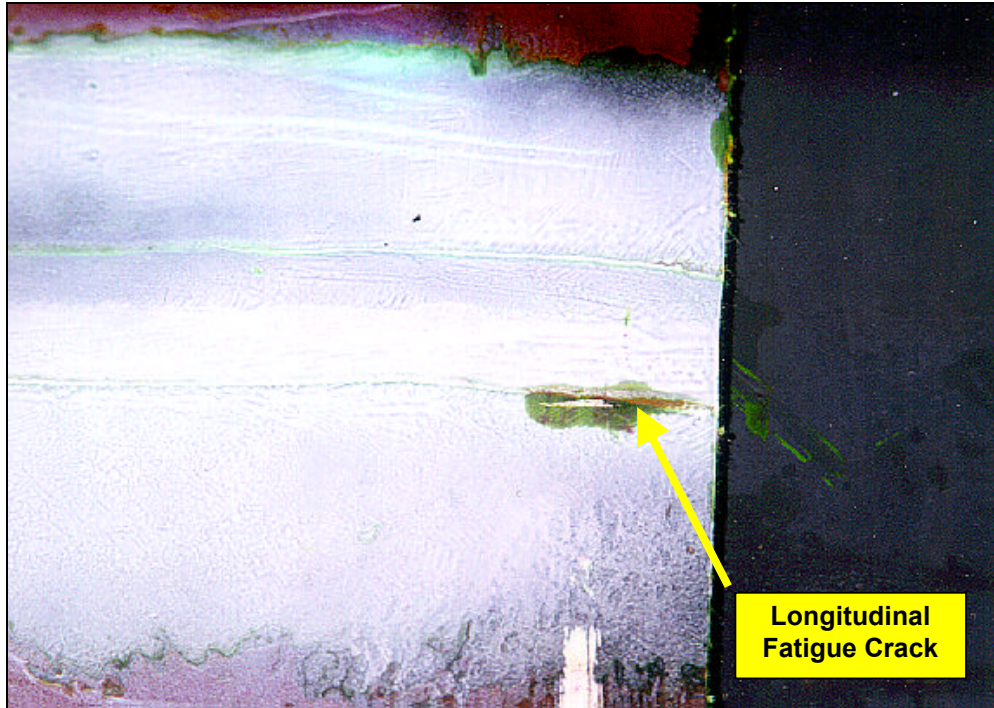

Figure 22. Fatigue Crack Generated from a Maximum Dynamic Load of 17 Kips

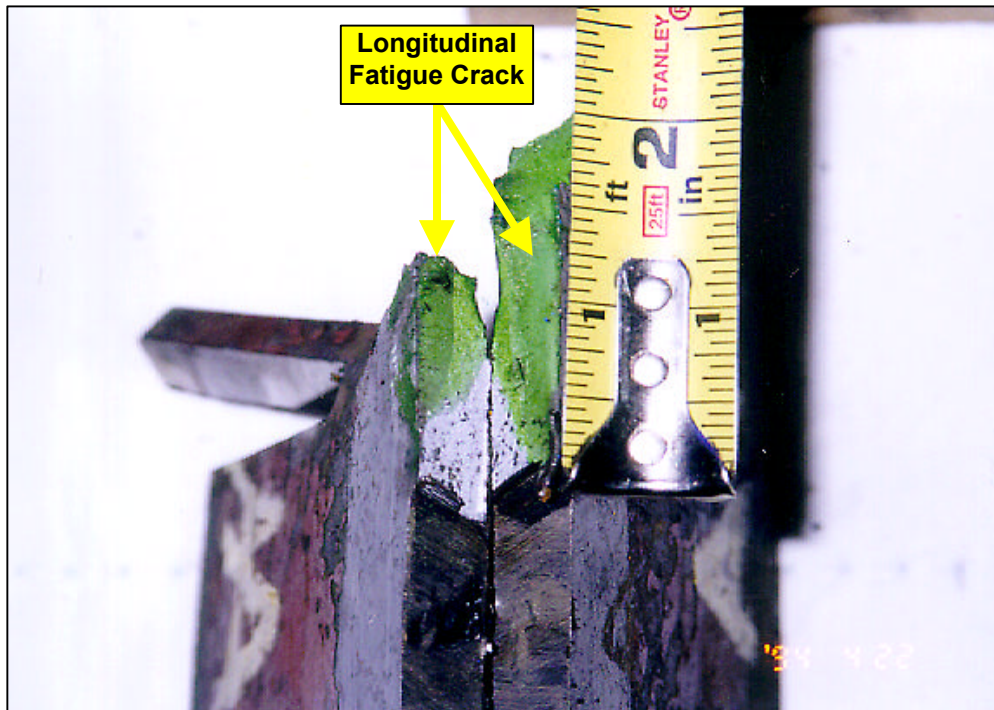

Figure 23. Fatigue Cracks from Figure 22 Broken Open and Showing Propagation in the Longitudinal Direction

The number of cracks generated for POD development purposes show 75 oriented in the longitudinal direction and 5 oriented in a transverse direction for a total of 80 manufactured fatigue cracks. The crack size distribution targeted to provide a statistically significant distribution of flaw sizes was approximately 60 longitudinal fatigue cracks. The size distribution targeted 60 percent of the cracks to be at or around the “(a) critical” flaw size, 20 percent of the d 20 percent smaller than the “(a) critical” flaw size. The actual flaw size distribution achieved is shown in Table 2. The flaws were grouped by flaw size length with the recommended ‘target’ or threshold flaw size identified at 0.50 in. (1.27 cm). It should be noted that the “(a) critical” flaw size was chosen as a target for purposes of this test only and is not intended to represent the size of the actual butt weld “(a) critical” flaw size for this design of railroad tank car. At the time of this test an “(a) critical” flaw size for industry wide use was not available and it was the consensus of the NDE steering committee to use a crack length of 0.50 in. (1.27 cm) as the target “(a) critical” flaw size.

Table 2. Actual-to-Targeted Flaw Size Distribution for POD Test Panels

FLAW SIZE		TARGETED FLAW DISTRIBUTION		ACTUAL FLAW DISTRIBUTION	
Inches	Centimeters	Number of Flaws	Distribution Percentage (%)	Number of Flaws	Distribution Percentage (%)
0 to 0.20	0 to 0.51	12	20	14	19
>0.20 to 0.80	>0.51 to 2.03	36	60	35	47
>0.80	>2.03	12	20	26	35

3.4.3 Master Gage Calibration

The material taken from the tank cars used for the POD evaluations was also used to manufacture two master gages measuring 12.00×24.00 in. (30.48×60.96 cm). The master gages were developed as calibration artifacts to assure reproducibility of response linearity during ultrasonic evaluation of the POD test panels and are part of the defect library initiated by TTCI. Electro-discharged machined (EDM) notches were placed into the master gage panels at the toe of the butt weld. The EDM notches were placed both parallel and perpendicular to the weld. Six notches were machined into the panels, one each in the parallel and perpendicular orientations, consisting of the following approximate lengths of 0.25, 0.50, and 0.75 in. (0.64, 1.27, and 1.91 cm). Figure 24 is a photograph of tank car crack panel Number 1. Tables 3 and 4 list the dimensions determined using dimensional equipment certified and traceable to NIST.

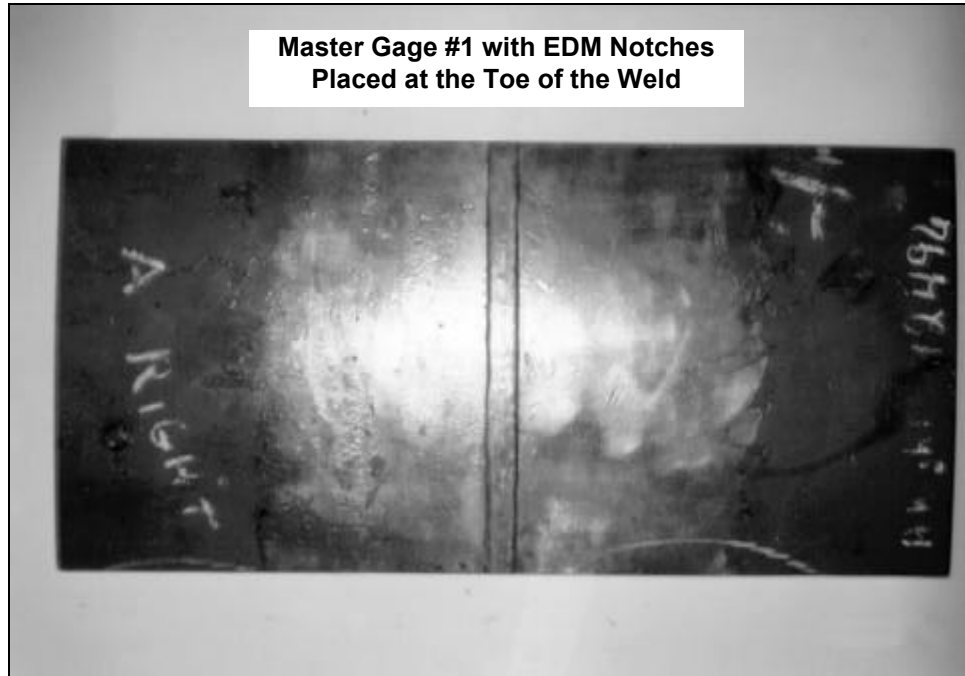

Figure 24. Master Gage Constructed of Tank Car Material Representative of ASTM A515, Grade 70 Steel

Table 3. Defect Dimensions and Orientations for TTCI Tank Car Crack Panel Master Gage Standard #1

Notch ID	Defect Dimensions in Inches (mm)						Defect Orientation	
	Length		Width		Depth		Longitudinal	Transverse
	in.	mm.	in.	mm.	in.	mm.		
A	0.7763	19.72	0.0114	0.29	0.3711	9.43	X	
B	0.5073	12.89	0.0127	0.32	0.2427	6.16	X	
C	0.2533	6.43	0.0068	0.17	0.1262	3.21	X	
D	0.7555	19.19	0.0101	0.26	0.3752	9.53		X
E	0.4995	12.69	0.0090	0.23	0.2477	6.29		X
F	0.2511	6.38	0.0093	0.24	0.1256	3.19		X

Table 4. Defect Dimensions and Orientations, TTCI Tank Car Crack Panel Master Gage Standard #2

Notch ID	Defect Dimensions in Inches (mm)						Defect Orientation	
	Length		Width		Depth		Longitudinal	Transverse
	in.	mm.	in.	mm.	in.	mm.		
A	0.7716	19.60	0.0110	0.28	0.3759	9.55	X	
B	0.5086	12.92	0.0099	0.25	0.2449	6.22	X	
C	0.2509	6.37	0.0076	0.19	0.1240	3.15	X	
D	0.7579	19.25	0.0126	0.32	0.3744	9.51		X
E	0.5061	12.85	0.0101	0.26	0.2419	6.14		X
F	0.2566	6.52	0.0086	0.22	0.1230	3.12		X

The gages were developed as calibration references to determine signal response comparisons during POD evaluations. The master gages were not used as calibration blocks for the technicians participating in this study but were used to determine signal responses after normal

calibration by each technician, since the intent of the study was to baseline current practices and capabilities. The signal responses were recorded prior to and immediately following each panel inspection. The amplitude response at each of the manufactured notches was recorded on the ultrasonic test setup sheet. Table 5 lists the signal responses for each of the operators prior to and after evaluation of the POD test panels.

Table 5. Ultrasonic Signal Response Comparison between Operators During POD Evaluations

Operator	Transducer Size		Transducer Frequency (MHz)	Wedge Angle (degrees)	Scanning Level (dB)	Amplitude Responses from the Longitudinal EDM Notches in Master Gage No. 2		
	in.	cm				0.75 in. (1.91 cm)	0.50 in. (1.27 cm)	0.25 in. (0.64 cm)
1 (pre)	0.50 x 1.00	1.27x 2.54	2.25	70	60	52	42	18
1 (post)	0.50 x 1.00	1.27X 2.54	2.25	70	60	50	46	17
2 (pre)	0.50 dia.	1.27 dia.	2.25	60	46	40	40	18
2 (post)	0.50 dia.	1.27 dia.	2.25	60	46	36	55	30
3 (pre)	0.50 dia.	1.27 dia.	2.25	70	60	99	80	80
3 (post)	0.50 dia.	1.27 dia.	2.25	70	60	100	100	70
4 (pre)	0.75 x 0.75	1.91x 1.91	2.25	70	61	100	100	72
4 (post)	0.75 x 0.75	1.91x 1.91	2.25	70	61	100	100	100

3.4.4 POD Test Panel Evaluations

The POD test panels containing the manufactured flaws were evaluated using visual, liquid penetrant, magnetic particle and ultrasonic inspection. TTCI NDE technicians and engineers evaluated the panels in order to document size and locations of cracks. The test methods used for evaluation were supplemented by a video recording taken during crack initiation and propagation along with prior knowledge as to expected crack locations. The crack size and locations were recorded and entered into a database to be used for POD curve generation.

The actual data collected for the PODs generated during this project were from evaluations performed by industry representatives who perform NDE for their respective companies as part of their assigned job functions. The technicians who participated in the panel evaluations were scheduled for four days of onsite testing. There were four companies represented during the POD evaluations. The participants were from GATX, SRS, Trinity Industries, and UTC. The

objective was to have each of the NDE technicians evaluate all seven of the test panels using the NDE methods identified in the HM 201 rulemaking. The schedule of activities for panel evaluation and data collection was performed as follows.

- Evaluations scheduled between Tuesday and Friday:
 - Monday was used as a logistics and sample preparation day for TTCI
- A pre-test meeting was conducted prior to evaluations:
 - Included TTCI Safety Manager, project engineer and the industry NDE technician
 - Addressed schedule and objectives for evaluations
 - Provided background information to the industry technician on why the evaluations were being performed
 - Provided time to conduct an operator profile on the technician
 - Provided a forum to voice concerns or questions prior to testing
- Evaluations performed after pre-test meeting:
 - NDE technician performed all evaluations and flaw interpretations
 - Order of inspections:
 - Visual
 - Magnetic particle
 - Ultrasonics
 - Liquid penetrant
 - TTCI personnel documented all finds by technician
 - Video and photographs were taken during the evaluations
- Post-test meeting conducted after all inspections were complete
 - Opportunity to critique evaluations
 - Opportunity to identify areas for improvement

The order of NDE method evaluations was different the first week of testing with liquid penetrant inspection following the visual testing, rather than being performed last. The residual fluorescent penetrant remaining in the cracks and showing up during fluorescent magnetic particle inspection necessitated the change in method order. Performing liquid penetrant after the other inspections helped to eliminate false calls during magnetic particle testing due to residual penetrant. The new evaluation order provided TTCI with enough time to clean out any residual penetrant prior to the next week of testing.

An operator profile for each of the NDE technicians was performed during the pretest meeting. The profile was not conducted to assess the individual but to provide an understanding of the over all level of operator qualification during the panel evaluations. Similar profiles of this sort have been used in other programs such as the one used by Lockheed in the “Have Cracks Will Travel Program.” Table 6 lists the level of qualification for evaluations performed during this project. The intent was to have the evaluations performed by industry technicians with qualifications equivalent to NDT Level II as required in Appendix “T” of the AAR *Manual of Standards and Recommended Practices*.⁽⁸⁾

Table 6. Operator Profiles Showing Level of Qualification

Operator Parameter	Evaluator A	Evaluator B	Evaluator C	Evaluator D
Certifications	Level II – RT, UT & VT	Level II – AE, PT, MT, UT & VT CWI	Level II – AE, PT, MT, UT & VT	Level III – PT, RT & UT Level II – AE Level I – MT CWI
Qualifications	PT, MT, RT, UT & VT	AE, CWI, PT, MT, UT & VT	AE, PT, MT, UT & VT	AE, PT, MT, RT, UT & CWI
Average time using method	PT - Weekly MT - Weekly RT - Monthly UT - Biweekly VT - Monthly	AE - Weekly PT - Quarterly MT - Quarterly UT - Rarely VT - Monthly	AE - 6 wks/year PT - 20 hrs/month MT - 10 hrs/month UT - 20 hrs/month VT - 100 hrs/month	Over sees NDE program
NDE experience	10 years	10 years	15 years	18 years

3.5 INITIATING A DEFECT LIBRARY: THE TANK RE-QUALIFICATION AND INSPECTION CENTER (TRIC)

A defect library containing sample artifacts such as railroad tank cars and sections of railroad tank cars, donated by the railroad tank car industry, has been initiated by TTCI through funding from the FRA. The test panels used in the POD evaluations, along with the master gages developed for test evaluations, are also included as defect library artifacts. The combination of specimens contains discontinuities developed in service as well as manufactured flaws simulating location and type of discontinuities developed during service.

The defect library (TRIC) has been initiated to provide the tank car industry with resources similar to those established in the aerospace and nuclear industries. The aircraft industry has established the Aging Aircraft Nondestructive Inspection Validation Center (AANC) in Albuquerque, New Mexico, while the nuclear and power industries have established the EPRI NDE Center in Charlotte, North Carolina and the Inspection Validation Centre, AEA

Technology, Risley, United Kingdom. The primary benefits for establishing a defect library and validation center is to offer industry a facility to perform comprehensive, independent, and quantitative evaluations of new and enhanced inspection, maintenance and repair techniques.⁽²⁾

The accumulation of tank car artifacts containing discontinuities at a central location was included as part of this project to provide industry with available tools to evaluate and validate NDE technology. The use of full-scale tank car samples is invaluable in relating to the inspection environment and providing NDE technicians with actual defects to test and develop their skills. The availability of tank car sections that can be easily shipped to other sites is a valuable tool for industry to evaluate their NDE systems with uniform industry tools containing documented discontinuities. Important uses for the tank cars and the tank car artifacts include human skill development, capability demonstrations, and re-qualification by demonstration. A list of tank car and tank car artifacts currently included in the defect library can be found in Table 7. Photographs showing examples of the tank car and tank car artifacts are shown in Figures 25 to 28.

Table 7. Tank Car and Tank Car Artifacts in the Defect Library

Tank Car or Artifact Designation	Identification Number	Tank Car or Artifact Size	Date of Manufacture
103ALW	DUPX-7808	10,058 gallon	3/61
111 (*)	CGBX-4088	20,000 gallon	?
105A500W (*)	HCPX-1071	10,600 gallon	7/65
111A100W-1 (*)	CGTX-18442	?	3/69
111T	AAR-302	29,408	?
111A	GATX-92487	10,401	9/69
111A	GATX-92488	10,408	9/69
111A	GATX-92493	10,413	9/69
111A	GATX-92496	10,425	9/69
112J	AAR-300	25,960	12/66
112T	AAR-303	33,586	3/70
112T	AAR-301	26,063	6/74
111A	Master Gage Standard #1	12 in.x 24 in.x 0.44 in. (30.48 cm x 60.96 cm x 1.12 cm)	3/98
111A	Master Gage Standard #2	12 in.x 24 in.x 0.44 in. (30.48 cm x 60.96 cm x 1.12 cm)	3/98
111A	Butt Weld Test Panel #1	3 ft.x 5 ft.x 0.44 in. (90 cm x150 cm x 1.12 cm)	3/98
111A	Butt Weld Test Panel #2	3 ft.x 5 ft.x 0.44 in. (90 cm x150 cm x 1.12 cm)	3/98
111A	Butt Weld Test Panel #3	3 ft.x 5 ft.x 0.44 in. (90 cm x150 cm x 1.12 cm)	3/98
111A	Butt Weld Test Panel #4	3 ft.x 5 ft.x 0.44 in. (90 cm x150 cm x 1.12 cm)	3/98
111A	Butt Weld Test Panel #5	3 ft.x 5 ft.x 0.44 in. (90 cm x150 cm x 1.12 cm)	3/98
111A	Butt Weld Test Panel #6	3 ft.x 5 ft.x 0.44 in. (90 cm x150 cm x 1.12 cm)	3/98
111A	Butt Weld Test Panel #7	3 ft.x 5 ft.x 0.44 in. (90 cm x150 cm x 1.12 cm)	3/98

(*) Donated tank cars en-route to TTC



Figure 25. 112T Tank Car Located in the Defect Library



Figure 26. 111A Tank Cars Located in the Defect Library



Figure 27. Transverse Butt Weld Test Panels Included in the Defect Library



Figure 28. Master Gage Standard #1 Located in the Defect Library

4.0 RESULTS

4.1 SAFETY RAILWAY SERVICES TEST RESULTS

In May of 1994 Safety Railway Services performed nondestructive evaluations on three railroad tank cars. The tank cars were identified as Tank Car Numbers 1, 2, and 3. The tank cars were no longer available during a TTCI tour of SRS in 1995 and results from copies of the SRS inspection reports are reported herein.

Tank car Number 1 was identified as a 103-W and a copy of the interior visual inspection report was given to TTCI. The inspection reports available for tank car Number 2 include magnetic particle, ultrasonic, and interior visual testing. Tank car Number 3 reports include ultrasonic, interior, and exterior visual inspections.

The interior visual inspection performed on tank car Number 1 identified five areas containing some type of discontinuity. The discontinuities described in the inspection report are both weld related and corrosion induced discontinuities. The list in Table 8 identifies the discontinuity size and location as documented after interior visual inspection by SRS.

Table 8. Defects Identified During Interior Visual Inspection of Tank Car Number 1 by SRS

Discontinuity Number	Location	Type	Size and Description
1	A-end left at the longitudinal tank sheet weld	Porosity	Two 0.50-in. (1.27 cm) diameter areas with cluster porosity at the weld reinforcement
2	A-end ceiling	Rifling	26.00 in. (66 cm) in length
3	A-end through B-end tank weld seams	Excessive weld reinforcement	Random measurements show weld thickness variances of 0.624, 0.750 to 0.868 in. (1.58, 1.91 to 2.20 cm)
4	A-end through B-end tank weld seams	Pitting	Pitting in the range of 0.007 to 0.051 in. (0.02 to 0.13 cm)
5	A-end through B-end tank weld seams	Weld discontinuities	Variety of weld discontinuities

The interior visual inspection performed on tank car Number 2 identified two areas containing some type of discontinuity. The discontinuities described in the inspection report are both weld related and corrosion induced type discontinuities. The list in Table 9 identifies the discontinuity size and location as documented after interior visual inspection by SRS.

Table 9. Discontinuities Identified During Interior Visual Inspection of Tank Car Number 2 by SRS

Discontinuity Number	Location	Type	Size and Description
1	A-end through B-end	Lining failure	Lining failure at butt weld, some thick weld seams at manway and multiple house nozzles
2	A-end through B-end (left & right of tank)	Pitting	Pits are up to 0.05 in. (0.13 cm) in depth, tank shell ranges from 0.529 to 0.550 in. (1.34 to 1.40 cm) in thickness

The magnetic particle inspection performed on tank car Number 2 identified four areas containing discontinuities. The discontinuities described in the inspection report are located in both the tank shell and weld. The list in Table 10 identifies the defect size and location as documented after magnetic particle inspection by SRS.

Table 10. Discontinuities Identified During Magnetic Particle Inspection of Tank Car Number 2 by SRS

Discontinuity Number	Location	Type	Size and Description
1	B-end left, inboard tank pads to tank	Crack	1.00 in. (2.54 cm) in tank shell
2	B-end right, inboard tank pads to tank	Crack	1.25 in. (3.18 cm) in tank shell
3	A-end left, inboard tank pads to tank	Crack	1.50 in. (3.81 cm) in tank shell
4	A-end right, inboard tank pads to tank	Crack	1.00 in. (2.54 cm) in weld

The ultrasonic inspection performed on tank car Number 2 identified a loss of the back reflection at the heat affected zone of transverse butt weld Number 3 during both longitudinal and shear wave inspection. The loss of signal would suggest a metallurgical irregularity (most likely due to the welding process) and would have to be evaluated further using another NDE method and/or methods. The list in Table 11 identifies the SRS findings from the ultrasonic inspection.

Table 11. SRS Findings from Ultrasonic Inspection of Tank Car Number 2

Discontinuity Number	Location	Type	Size and Description
1	Transverse weld 3	Loss of signal	Unable to maintain back reflection at heat affected zone; total loss of signal

The interior visual inspection performed on tank car Number 3 identified one area containing corrosion related discontinuities. The inside surface was glazed with sulfur commodity; thus, a thorough inspection of the surface could not be performed. The exterior visual inspection performed on tank car Number 3 did not identify any surface discontinuities. There were some signs of minor corrosion at weld areas around the manway and reinforcement pads but the amount of corrosion was minimal. The car was jacketed so the visual inspection was performed using an industrial measuring fiberscope with a high intensity light source. The list in Table 12 identifies the discontinuities documented during interior visual inspection of tank car Number 3 by SRS.

Table 12. Discontinuities Identified During Visual Inspection of Tank Car Number 3 by SRS

Discontinuity Number	Location	Type	Size and Description
1	A-end through B-end	Corrosion	The interior surface of the car was glazed with sulfur commodity; could not inspect interior surface.
NA	NA	NA	No defects found (exterior)

The ultrasonic inspection performed on tank car Number 3 did not identify defects at the transverse welds. The inspection of weld seams 1 and 4 were only performed on the inboard side of the weld. The technician was unable to maintain constant contact on the outboard side of the weld due to corrosion and the knuckle radius of the tank head. The list in Table 13 identifies the SRS findings from ultrasonic inspection of tank Number 3.

Table 13. SRS Findings from Ultrasonic Inspection of Tank Car Number 3

Discontinuity Number	Location	Type	Size and Description
1	Transverse weld 1	NA	Unable to maintain constant contact on outboard side of weld due to corrosion and knuckle radius of tank head.
2	Transverse weld 4	NA	Unable to maintain constant contact on outboard side of weld due to corrosion and knuckle radius of tank head.

4.2 **BASELINE INSPECTION RESULTS**

The baseline inspections of the four tank cars located at TTC were initially evaluated using acoustic emissions (AE) testing followed by the methods allowed for railroad tank car inspection as identified in the HM 201 rulemaking. NDE technicians from GATX and UTC performed the AE evaluations at TTC. The AE testing included a pressure test, a jacking test and a stub sill twist test. Testing was performed in accordance with the AAR’s Procedure for Acoustic Emission Evaluation of Tank Cars and IM101 Tanks, Issue 5, dated January 1996. Test equipment used for the evaluations was supplied by GATX and UTC and manufactured by the Physical Acoustics Corporation. The NDE methods MT, PT, RT, UT, and VT were also used, as identified in the rulemaking.

4.2.1 **Acoustic Emissions Test Results**

Tank cars evaluated using AE included a 111A (jacketed), a 111T (non-jacketed but thermal coated), a 112J (jacketed), and a 112T (non-jacketed, but thermal coated). The 111A tank car, GATX 92487, passed the pressure test but did not meet (failed) the minimum acceptance requirements identified in the AE procedure for the jacking and twist tests. The 112J tank car, AAR 300, failed the pressure, the jacking, and the twist tests. The 111T tank car, AAR 302, passed the pressure test but failed both the jacking and twist tests. The 112T tank car, AAR 303, passed the jacking tests and failed the twist tests. The pressure head on tank car AAR 303 leaked when pressurized; thus, an accurate pressure test could not be performed. The test was continued and emissions from the sensor located by the B-end inboard stub sill termination and the center of the car were noted for future evaluation with another NDE method. Table 14 lists the results from AE testing of the four tank cars. Figures 29 through 32 show the AE setup for the pressure, jacking, and twists tests along with the monitoring/recording equipment used during testing.

Table 14. Results Of Global Testing Using Acoustic Emissions on Baseline Tank Cars

Tank Car I.D.	Pressure Test	Jacking Test		Twist Test			
		A-End	B-End	A-End Right	A-End Left	B-End Right	B-End Left
GATX 92487	Pass	Fail	Fail	Fail	Fail	Pass	Pass
AAR 300	Fail	Fail	Fail	Pass	Fail	Fail	Pass
AAR 302	Pass	Fail	Fail	Fail	Fail	Fail	Fail
AAR 303	NA	Pass	Pass	Pass	Fail	Fail	Fail



Figure 29. AE Pressure Test Setup on Baseline Tank Car



Figure 30. AE Jacking Test Setup on Baseline Tank Car

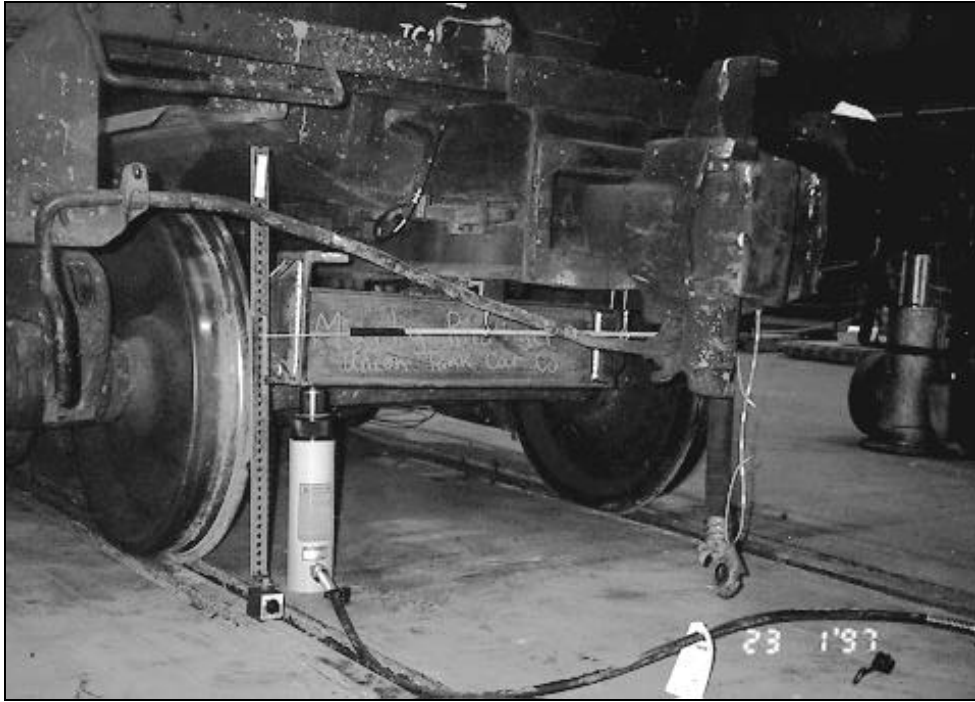

Figure 31. AE Sill Twist Test Setup on Baseline Tank Car

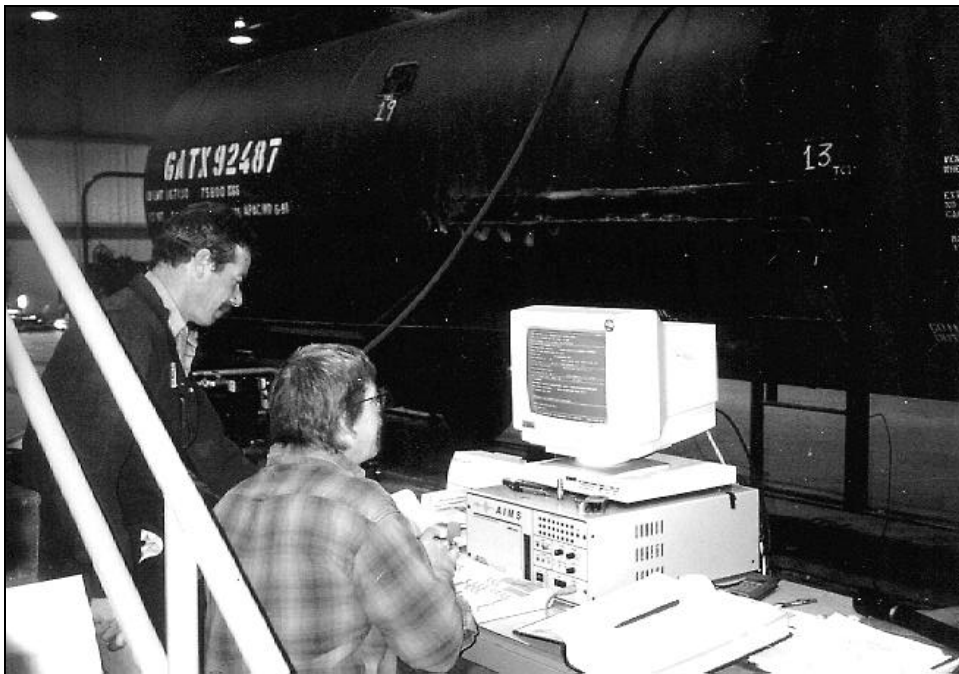

Figure 32. AE Data Collection and Monitoring System Used

Acoustic emissions testing of GATX 92487 identified areas recommended for further evaluation as the B-end left inboard bottom re-pad termination, the B-end side of the head seam weld (likely noise), the front of the head block area, and the A-end left sill (outboard of the body bolster). Areas recommended for further evaluation of AAR 300 included the A- and B-end left transition at the bottom of the tank, the inboard stub sill termination, the A-end left and the B-end right body bolster down to the stub sill, and the front end of the head block area. Further evaluation recommendations for AAR 302 included the A-end right side of the body bolster, the A-end and B-end head block area, and the B-end around the body bolster down by the center filler area. It was recommended that further evaluation is performed for tank car number AAR 303 at the B-end inboard stub sill termination, the A-end left stub sill (outboard of the body bolster), and the B-left and B-right sides of the stub sill (outboard of the body bolster).

4.2.2 HM 201 Rulemaking for Accepted NDE Inspection Results

Accepted NDE methods for structural integrity inspection of railroad tank cars include PT, MT, RT, UT, and VT inspection. The results of the baseline inspections using the accepted NDE methods are detailed in this section of the report. As previously mentioned, the evaluations performed during the baseline operations were conducted by tank car industry NDE technicians with the evaluations monitored and documented by TTCI staff.

The areas of interest during the baseline evaluations included the required inspection areas from the HM 201 rulemaking and areas recommended for further evaluation from the AE test results. Tables 15 through 18 list the results from the baseline evaluations.

Table 15. Baseline Inspection Results From Tank Car Number GATX 92487

Inspection Method	Results
Liquid Penetrant	Interior – no cracks found. Exterior – B end left and right fillet weld terminations of the sill bearing plate: B-right (0.50" crack at the toe of the weld) B-left (1.50" crack at the toe of the weld)
Magnetic Particle	No indications. (Fillet weld inspections not performed.)
Radiography	No indications. (Fillet weld inspections not performed.)
Ultrasonics	Structural Integrity (angle beam) - no cracks found. (Fillet weld inspections not performed.) Thickness (straight beam) – Reduced thickness at safety valve nozzle, multiple housing nozzle, sump, manway nozzle, right side of tank up approximately 75% there is a reduction area of about 532 sq. in. (3,458 sq. cm)
Visual (optically aided)	No indications. Fillet weld termination cracks identified after being detected with liquid penetrant inspection.

Table 16. Baseline Inspection Results from Tank Car Number AAR 300

Inspection Method	Results
Liquid Penetrant	No cracks found.
Magnetic Particle	No cracks found.
Radiography	No cracks found.
Ultrasonics	Structural Integrity (angle beam) ○ no cracks found. Thickness (straight beam) ○ no reductions found.
Visual (optically aided)	No cracks found.

Table 17. Baseline Inspection Results from Tank Car Number AAR 302

Inspection Method	Results
Liquid Penetrant	No cracks found.
Magnetic Particle	No cracks found.
Radiography	No cracks found.
Ultrasonics	Structural Integrity (angle beam) ○ no cracks found. Thickness (straight beam) ○ no reductions found.
Visual (optically aided)	No cracks found.

Table 18. Baseline Inspection Results from Tank Car Number AAR 303

Inspection Method	Results
Liquid Penetrant	No cracks found.
Magnetic Particle	No cracks found.
Radiography	No cracks found.
Ultrasonics	Structural Integrity (angle beam) – no cracks found. Thickness (straight beam) – no reductions found.
Visual (optically aided)	No cracks found.

A correlation between the AE testing and the HM 201 allowed methods was found with the verification of two cracks at the B end fillet weld terminations of the sill bearing plate. The other areas identified for further evaluation by AE did not identify cracks or other defects on any of the other tank cars. It should be noted that the AE reports did suggest that some of the indications from the AE testing could be attributed to noise (undesired signals that interfere with the normal reception or processing of a desired signal); thus, the results were inconclusive. The final result is that the tank cars used in the baseline evaluation did not contain an adequate number of defects to perform a statistically valid POD study; therefore, artificial flaws were manufactured around the transverse butt weld areas of two tank cars and were used for the POD evaluations. Photographs of the HM 201 accepted NDE methods used in baseline evaluation are shown in Figures 33 through 38.



Figure 33. Liquid Penetrant Inspection of Transverse Butt Weld from the Interior of the Tank Car



Figure 34. Liquid Penetrant Inspection Showing 0.050-inch Crack at Fillet Weld Termination of the Sill Bearing Plate

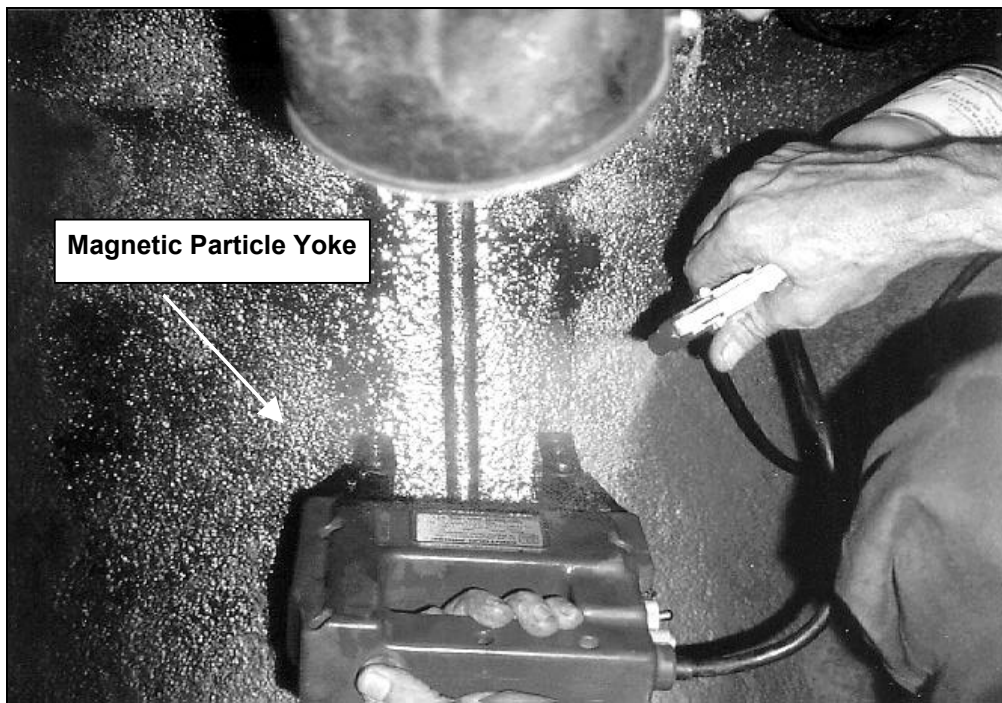

Figure 35. Magnetic Particle Inspection of the Transverse Butt Weld from the Interior of the Tank Car



Figure 36. Film Placement at the Transverse Butt Weld in the Interior of the Tank for Radiographic Inspection



Figure 37. Gamma Ray Source Location for Transverse Butt Weld Inspection with Source at the Exterior of the Tank



Figure 38. Ultrasonic Evaluation of the Transverse Butt Weld

4.3 PROBABILITY OF DETECTION (POD) RESULTS

The evaluation results for the seven cracked test panels used in the Tank Car NDE project are included in this section. The test panels contained a cumulative total of 80 cracks (75 longitudinal and 5 transverse) ranging from 0.10 to 3.25 in. (0.25 to 8.26 cm) in length. NDE technicians from the railroad tank car industry performed the panel evaluations. The NDE methods used for the evaluations included visual, magnetic particle, liquid penetrant, and ultrasonic inspection. The guidelines followed by the technicians to perform the evaluations were from generic procedures agreed upon by the Tank Car NDE steering committee. The procedures were representative of typical procedures used in railroad tank car inspections. The data gathered from each of the tests was entered into a database and evaluated against the documented defect size and location database developed by TTCI.

The graphs shown in Figures 39 through 62 show the NDT methods with the corresponding POD curves developed for each panel evaluation with the last graph shown in each section providing a comparison of evaluation results between operators. The tables preceding each set of graphs list the POD percentage at various crack lengths for each evaluation. A POD comparison for each of the NDE methods as performed by all operators combined is shown in Figures 63 through 66.

The graph shown in Figure 67 shows the POD results for all operators combined from each of the test methods. Table 24 lists the POD percentages for the combined results. A summary of the results for each of the test methods has been included at the end of each section of graphs.

Magnetic particle and liquid penetrant POD curves generated are specific to fluorescent methods used on all of the test panels. Visible liquid penetrant inspections were performed on one or two of the test panels during each set of evaluations but there was not sufficient data to develop a POD curve for this method. Gamma radiography was also performed but film density in the butt weld area (area of interest) exceeded the maximum allowable requirement of 4.0 H&D and proper film evaluation could not be performed. Radiography (gamma and x-radiography) will be included in future evaluations and results will be generated in the format used for this report to assure direct correlation of results.

4.3.1 Liquid Penetrant POD Results

Tank car panel evaluations performed using the liquid penetrant test method were performed in accordance with Procedure No. TTCI/LPPOD.1, Penetrant Inspections for Standard Temperatures, dated March 6, 1998. A liquid penetrant set-up sheet was established and parameters identified on the sheet were checked and verified by the evaluating technician and a TTCI test representative prior to panel inspections. The parameters required identification and documentation of the penetrant, cleaner, and developer used for the evaluation. The area of interest, surface preparation, and post examination cleaning method were entered on to the set-up sheet. The light intensity of the ultraviolet light source and background light was also verified and documented on the sheet before actual panel inspection.

During panel inspection the technicians identified all detected cracks by applying a 0.5 in. x 0.125 in. (1.27 cm x 0.318 cm) magnetic strip adjacent to the weld where the crack was identified. After completing a panel inspection the technician who performed the evaluation along with a TTCI representative would identify and document the size and location of the detected cracks for entry into the POD database.

Test panel evaluation results for fluorescent liquid penetrant inspection identify a 90 percent probability of detection (POD) being achieved in two of the four evaluations. The evaluations that reached a 90 percent POD accomplished this at a crack length of larger than 2.00 in. (5.08

cm). At the 2.00-inch crack length the lowest POD percentage identified from the evaluations is shown to be 72 percent with the maximum at that point being 89 percent. The minimum POD at 1.00 in. is 61 percent and the maximum was 78 percent. At 0.50 in. (1.27 cm) the minimum POD is 44 percent and the maximum POD at that point was 60 percent. The minimum POD at 0.25 in. (.64 cm) is 26 percent and the maximum was 38 percent. The percentage of spread between the crack lengths identified ranged from 12 percent at 0.25 inch to 17 percent at the 2.00-inch length.

The 50-percent POD achieved for the evaluations occur at cracks lengths of 0.37 in. or .94 cm (Operator 2), 0.53 in. or 1.35 cm (Operators 1 and 3), and 0.63 in. or 1.60 cm (Operator 4). When averaged, the crack length at which a 50-percent POD was achieved occurs at approximately 0.52 inch (1.32 cm). From Table 19, the average POD at the largest range of crack lengths (3.00 in. or 7.62 cm) used in this evaluation is approximately 87 percent. In summary, at a crack length of approximately 0.52 in. an average POD of 50 percent was achieved and at the largest range of crack length, (approximately 3.00 in. or 7.6 cm) an overall average POD of 87 percent was achieved. Figure 44 is a graph plotting the cracks detected using the fluorescent liquid penetrant NDE method.

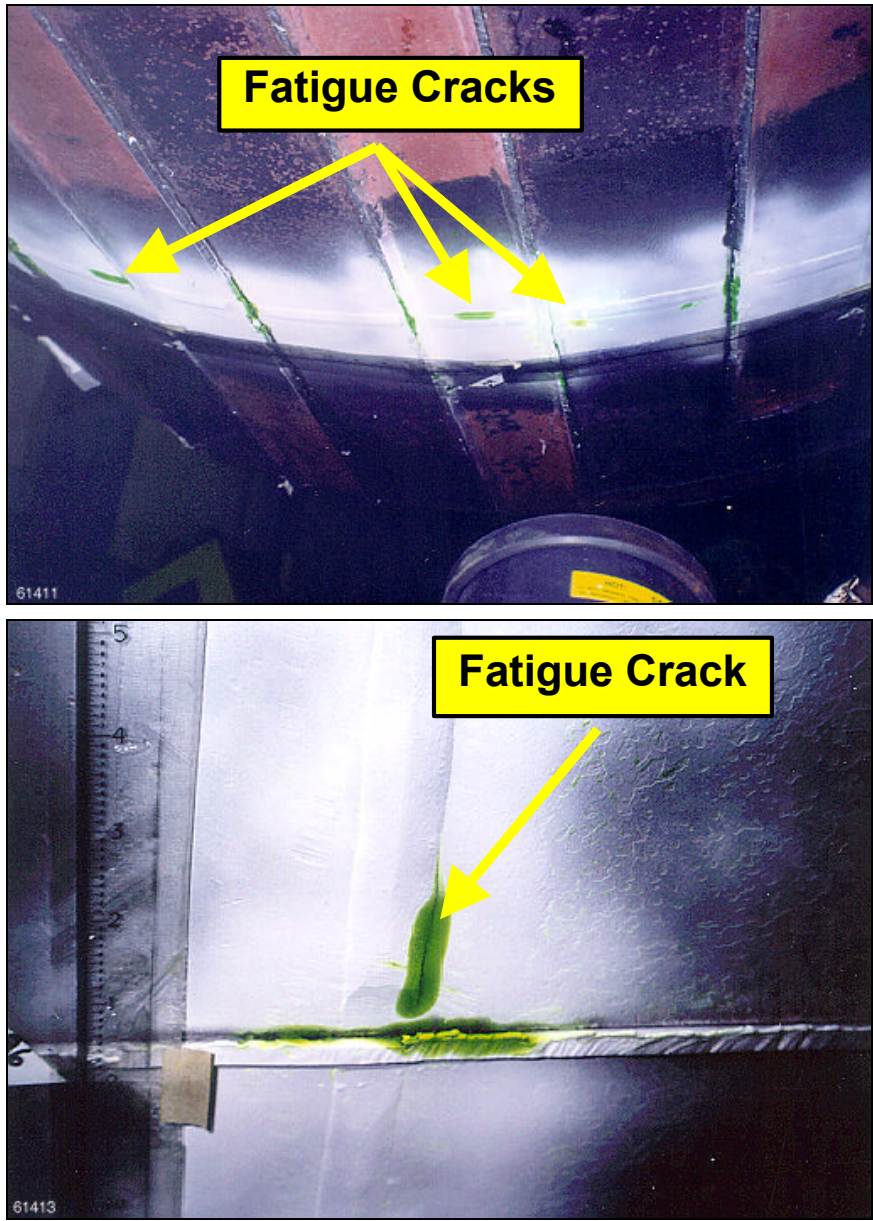

Figure 39. Fluorescent Liquid Penetrant Crack Indications on Tank Car Test Panels

Table 19. Fluorescent Liquid Penetrant Inspection POD Percentages

Crack Length	POD Percentage			
	Operator 1 (%)	Operator 2 (%)	Operator 3 (%)	Operator 4 (%)
0.00	0	0	0	0
0.13	27	21	13	15
0.25	37	38	26	27
0.50	49	60	46	44
0.75	56	71	60	55
1.00	61	78	68	63
1.50	68	85	79	72
2.00	72	89	84	78
2.50	75	92	88	82
3.00	78	93	90	85

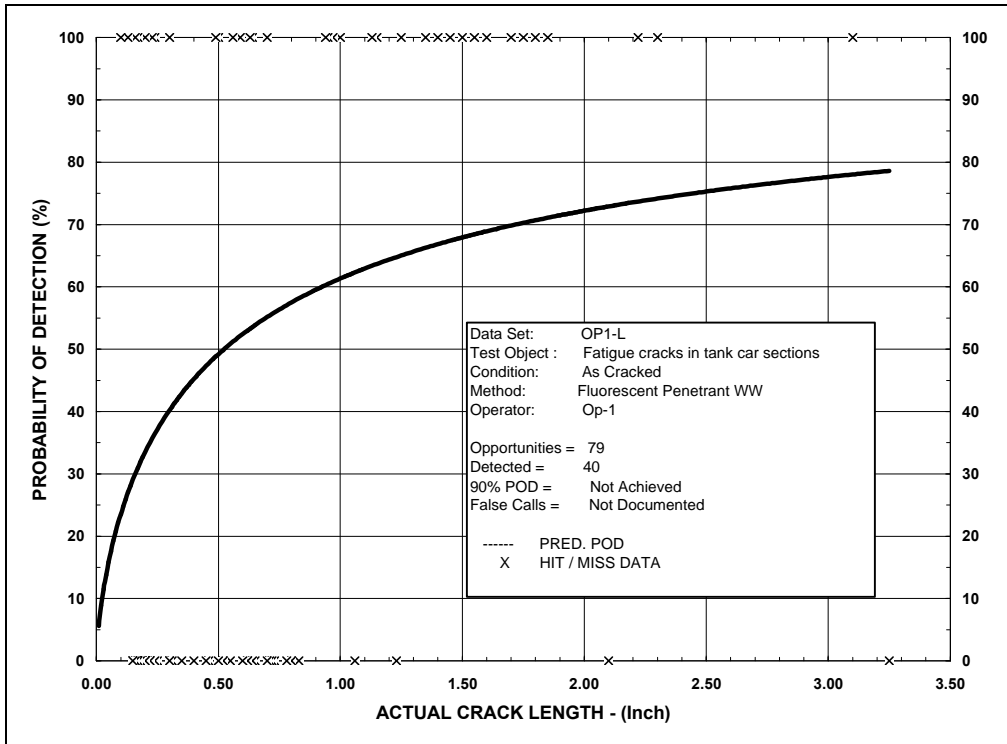

Figure 40. Fluorescent Liquid Penetrant POD Curve for Operator Number 1

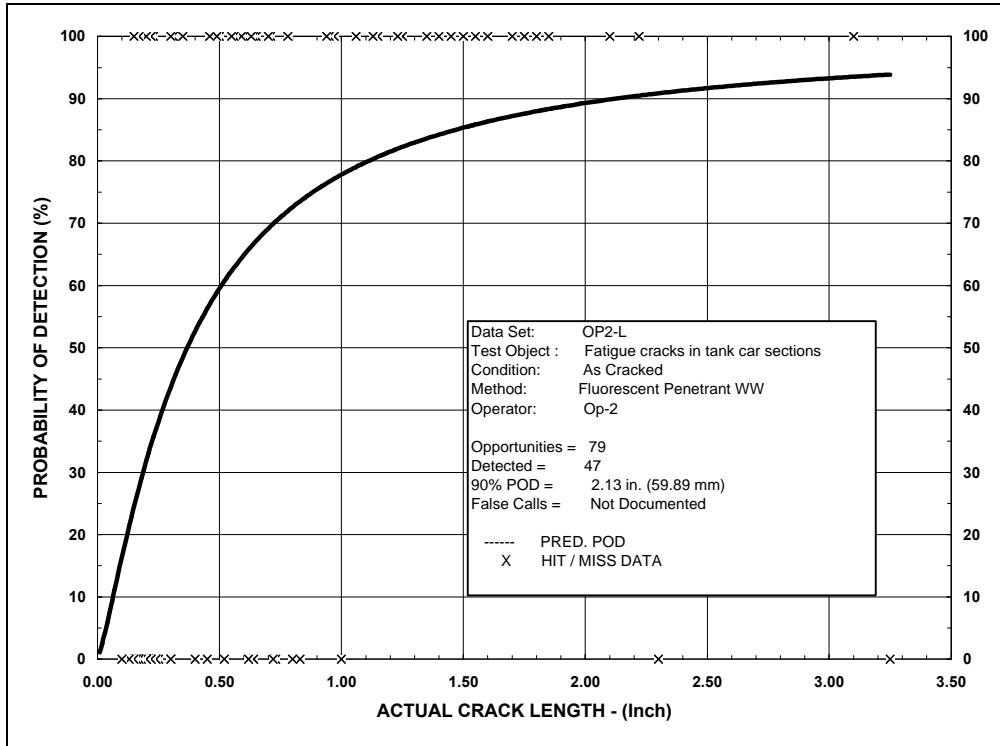

Figure 41. Fluorescent Liquid Penetrant Pod Curve For Operator Number 2

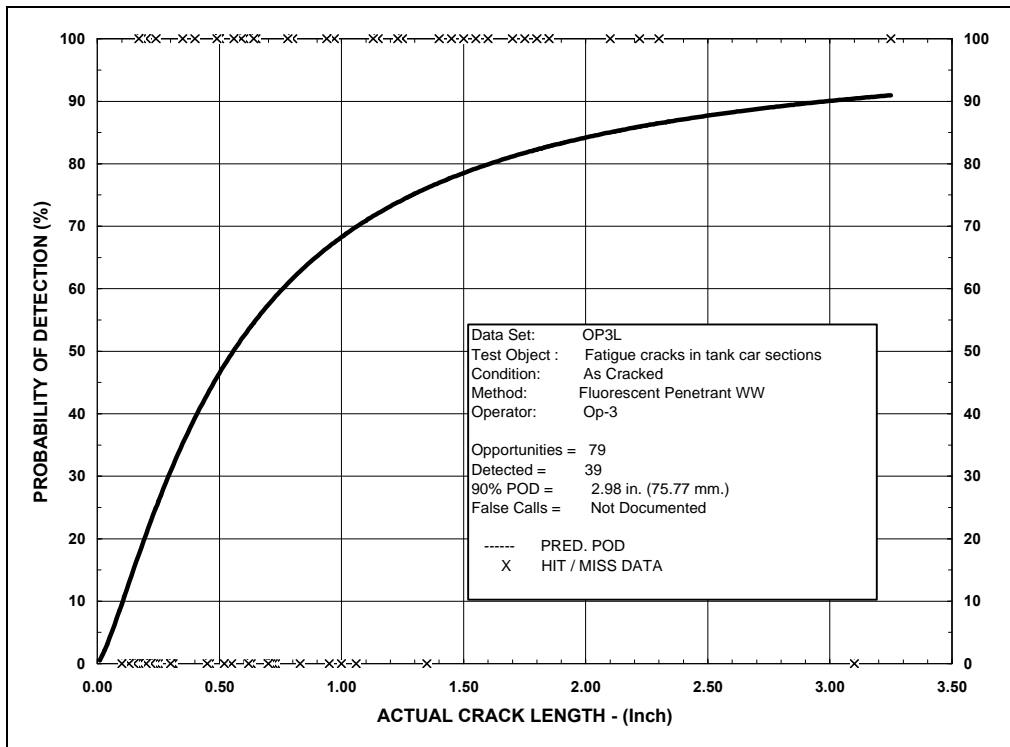

Figure 42. Fluorescent Liquid Penetrant POD Curve for Operator Number 3

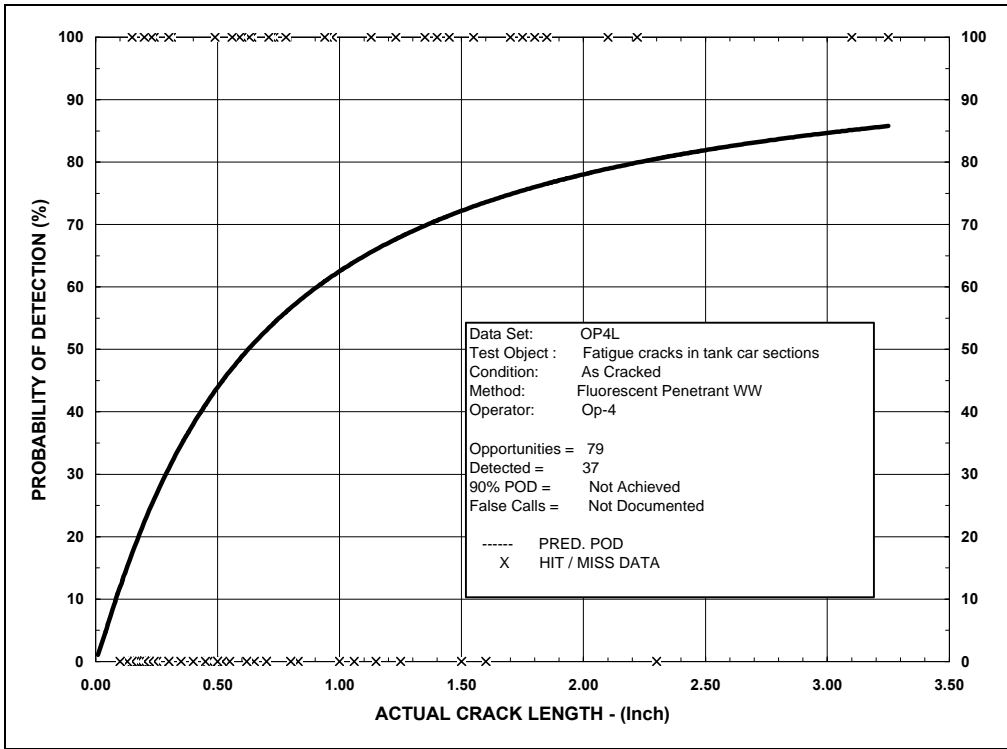

Figure 43. Fluorescent Liquid Penetrant POD Curve for Operator Number 4

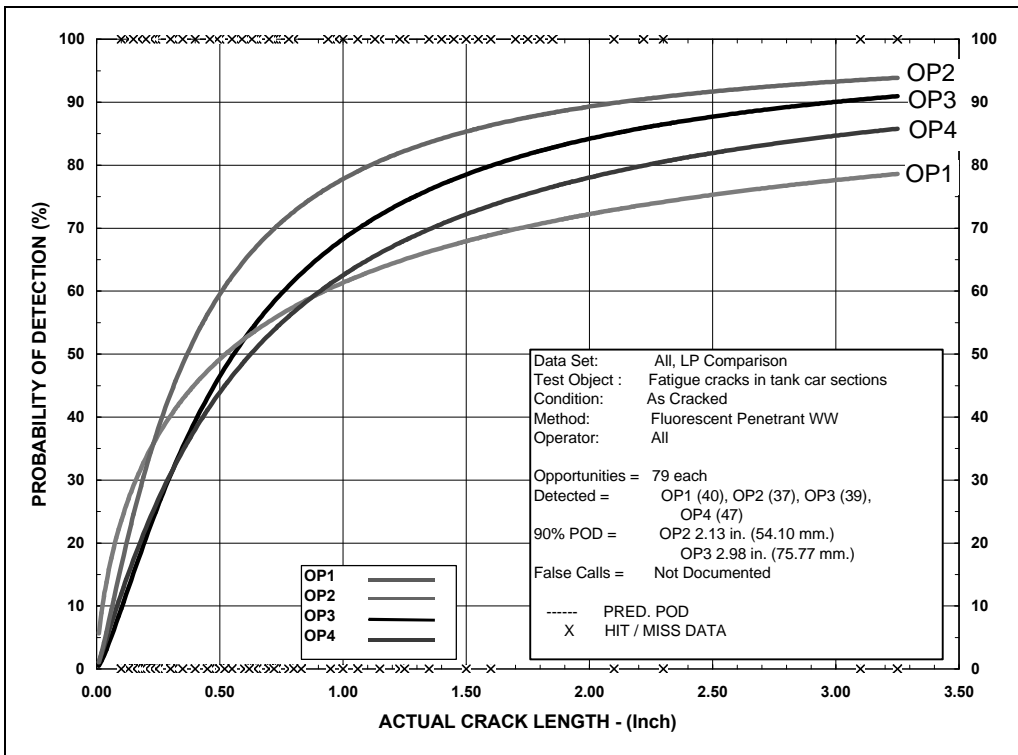

Figure 44. Fluorescent Liquid Penetrant POD Curve Comparison of All Operators

4.3.2 Magnetic Particle POD Results

Tank car panel evaluations performed using the magnetic particle test method were performed in accordance with Procedure No. TTCI/MPPOD.1, Magnetic Particle Inspections – Yoke Method, dated 3/6/98. A magnetic particle set-up sheet was established and parameters identified on the sheet were checked and verified by the evaluating technician and a TTCI test representative prior to panel inspections. The parameters required identification and documentation of the yoke manufacturer and type, the particles used, magnetizing process (continuous, residual), magnetizing current (AC or DC), and direction of the magnetic field. Calibration included documenting the lifting power of the yoke, in the AC mode, with a 10-pound weight at a pole spacing of 4 in. (10.16 cm). The light intensity of the ultraviolet light source and background light was also verified and documented on the sheet before actual panel inspection.

During panel inspection the technicians identified all detected cracks by applying a 0.5 in. x 0.125 in. (1.27 cm x 0.318 cm) magnetic strip adjacent to the weld where the crack was identified. After completing a panel inspection the technician who performed the evaluation along with a TTCI representative would identify and document the size and location of the detected cracks for entry into the POD database.

Test panel evaluation results for fluorescent magnetic particle inspection identified a 90-percent probability of detection (POD) being achieved in two of the four evaluations. The evaluations that reached a 90-percent POD accomplished this at crack lengths of 1.08 (2.71 cm) and 2.80 in. (7.11 cm). At the 2.00-inch crack length the lowest POD percentage identified from the evaluations is shown to be 82 percent with the maximum at that point being 94 percent. The minimum POD at 1.00 in. (2.54 cm) is 74 percent and the maximum was 89 percent. At 0.50 in. the minimum POD is 56 percent and the maximum POD at that point was 81 percent. The minimum POD at 0.25 in. is 37 percent and the maximum was 74 percent. The percentage of spread between the crack lengths identified range from 37 percent at 0.25 in. to 12 percent at the 2.00-inch length.

The 50-percent POD achieved for the evaluations occur at cracks lengths of 0.11 in. or .28 cm (Operator 3), 0.19 in. or .48 cm (Operator 2), and 0.41 in. or 1.04 cm (Operator 4). The results from the evaluation by Operator 1 are not included in averaging analysis since data shows the

curve for that evaluation starting with a 63-percent POD at a crack length of approximately 0.020 in. (.051 cm) The averaged crack length at which a 50-percent POD was achieved occurs at approximately 0.24 in. (.61 cm). From Table 20, the average POD at the largest range of crack lengths (3.00 in.) used in this evaluation is approximately 89 percent. In summary, at a crack length of approximately 0.24 in. (6.09 mm) an average POD of 50 percent was achieved and at the largest range of crack length, which is approximately 3.00 in., an over all average POD of 89 percent was achieved. Figure 50 is an example of cracks detected using the fluorescent magnetic particle NDE method.

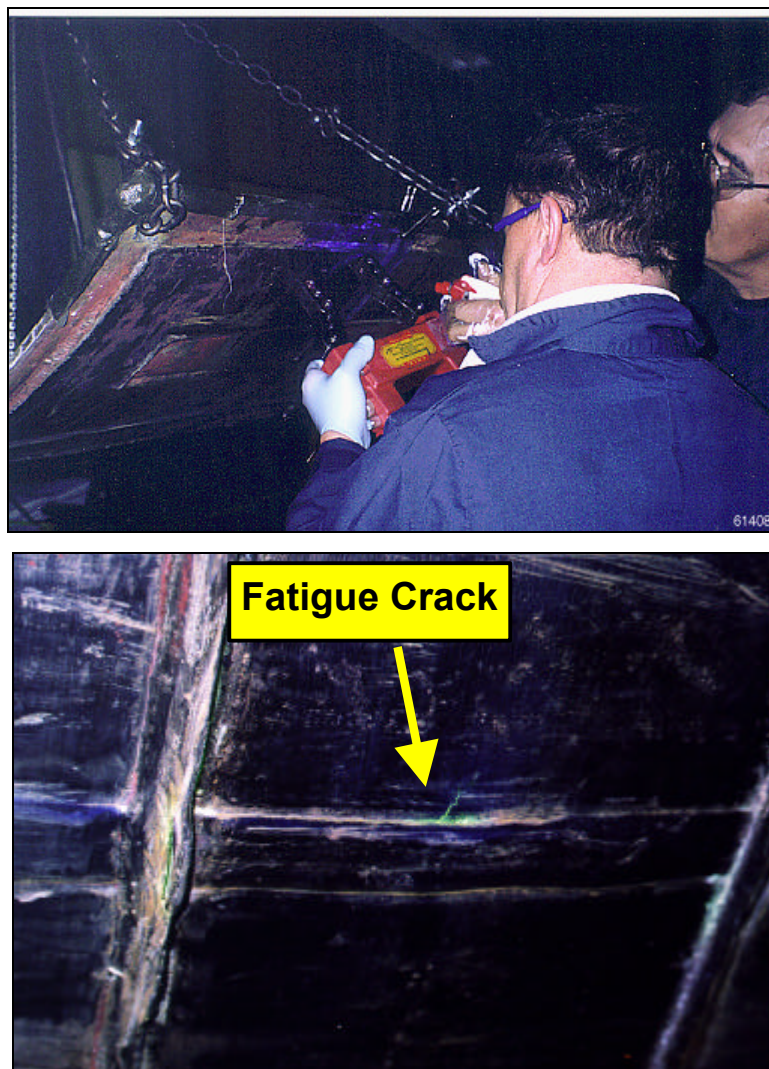

Figure 45. Fluorescent Magnetic Particle Longitudinal and Transverse Crack Indications

Table 20. Fluorescent Magnetic Particle Inspection POD and Average POD Percentages

Crack Length	POD Percentage			
	Operator 1 (%)	Operator 2 (%)	Operator 3 (%)	Operator 4 (%)
0.00	0	0	0	0
0.13	72	45	55	22
0.25	74	55	70	37
0.50	77	66	81	56
0.75	79	71	86	67
1.00	80	75	89	74
1.50	81	79	92	82
2.00	82	82	94	86
2.50	83	84	95	89
3.00	83	86	96	91

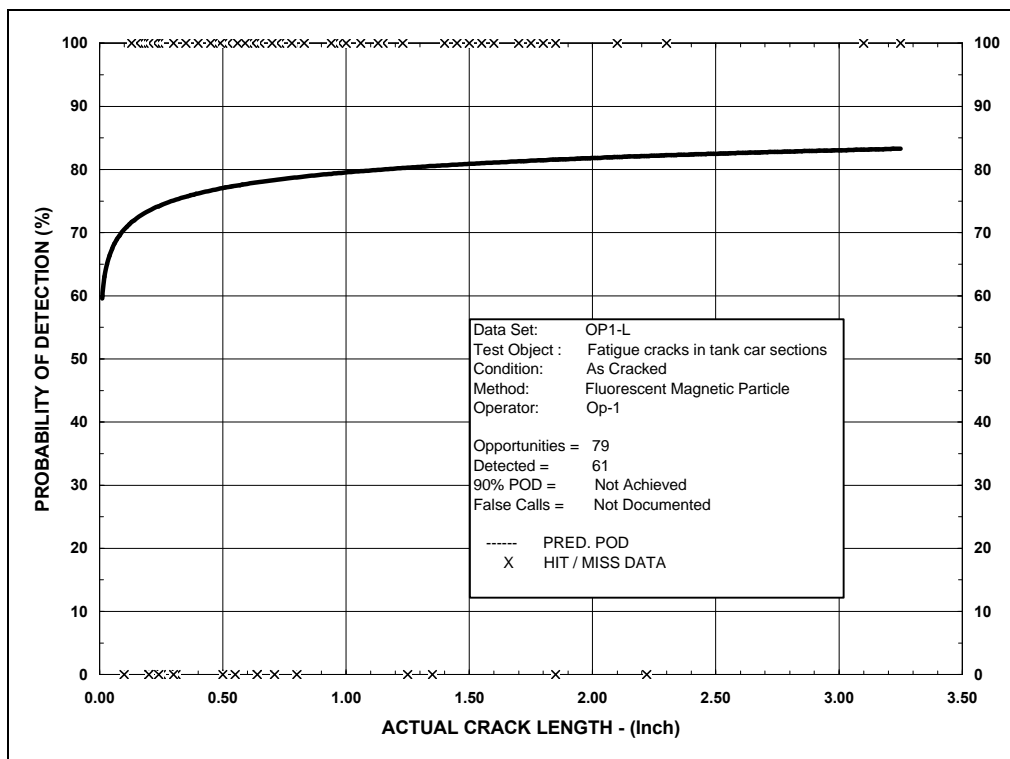

Figure 46. Fluorescent Magnetic Particle POD Curve for Operator Number 1

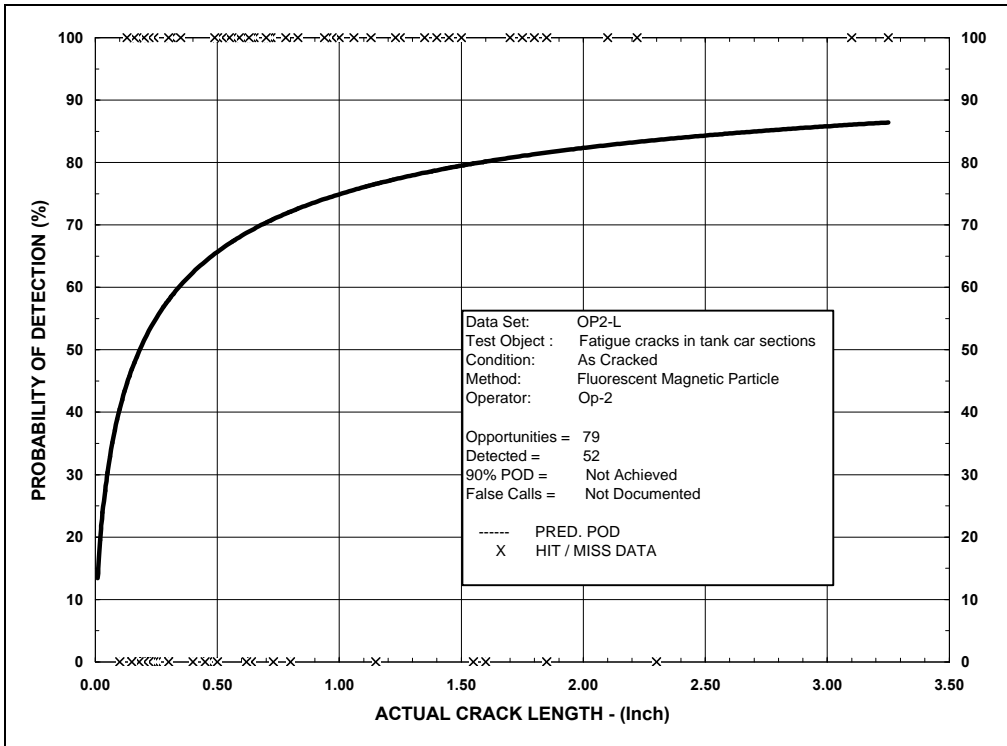

Figure 47. Fluorescent Magnetic Particle POD Curve for Operator Number 2

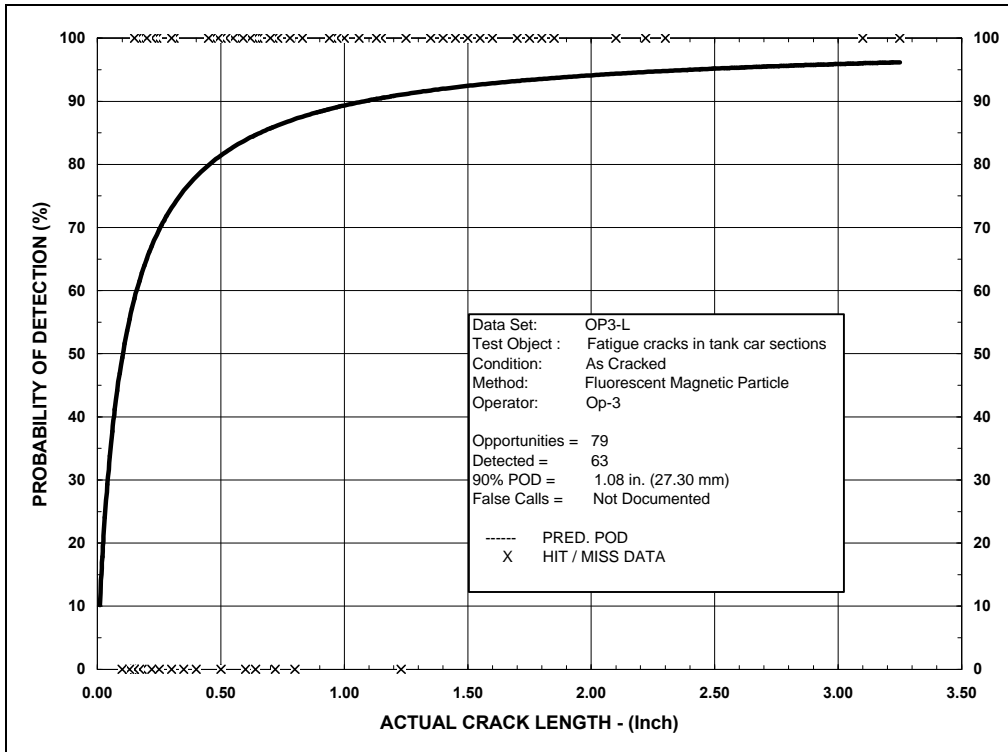

Figure 48. Fluorescent Magnetic Particle POD Curve For Operator Number 3

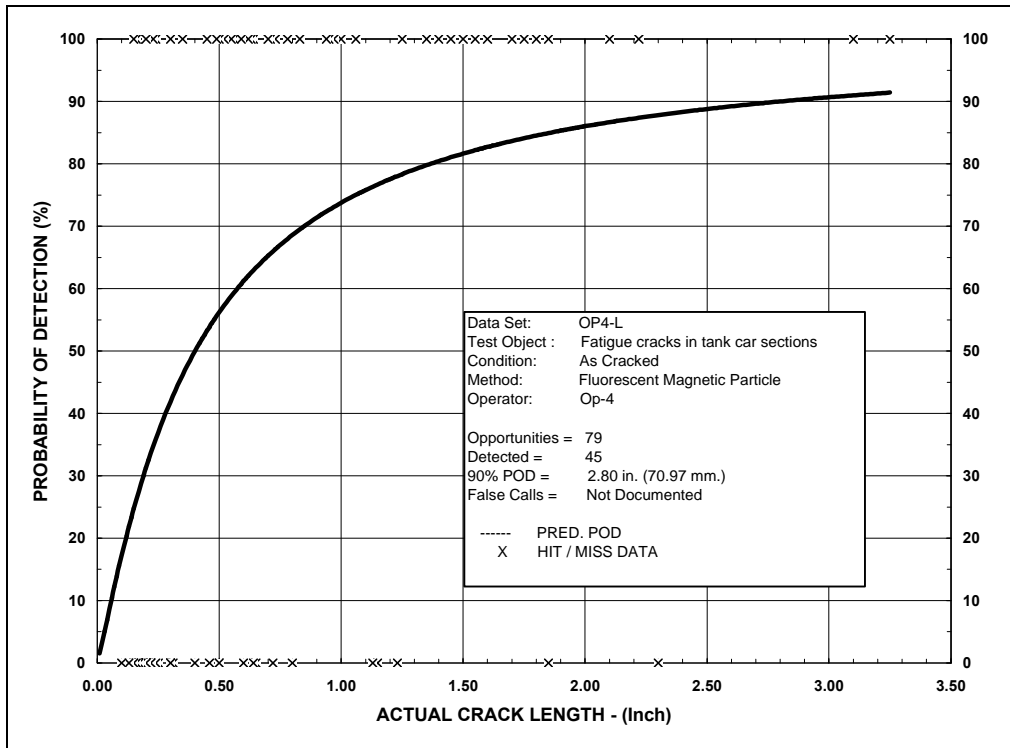

Figure 49. Fluorescent Magnetic Particle POD Curve For Operator Number 4

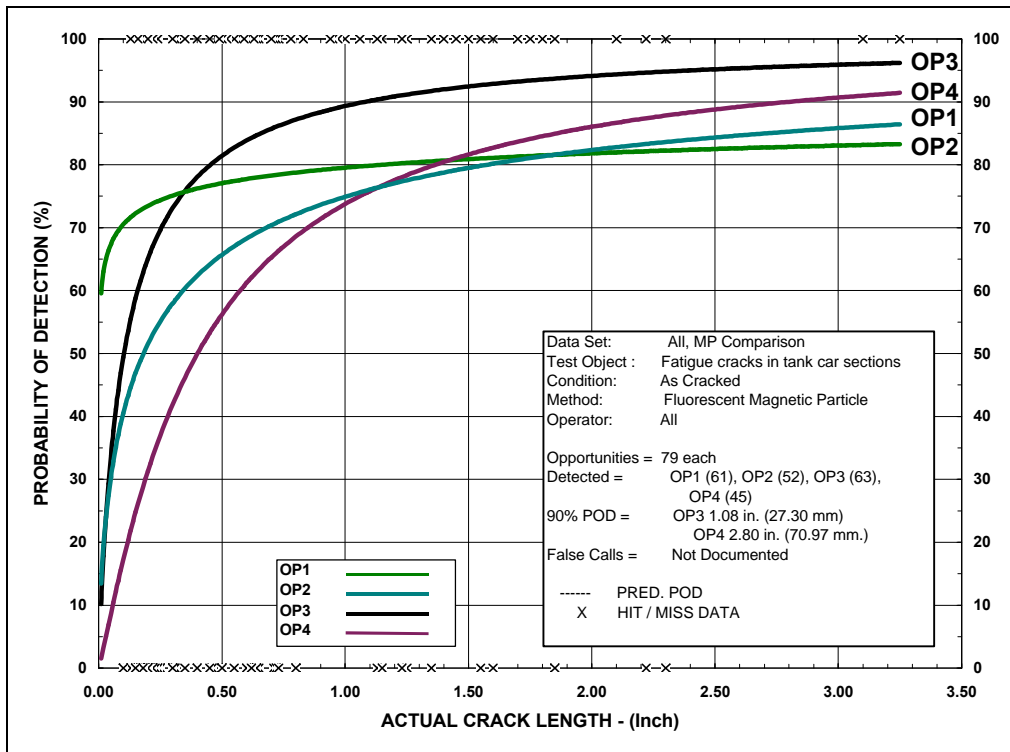

Figure 50. Fluorescent Magnetic Particle POD Curve Comparison for All Operators

4.3.3 Ultrasonic (Shear Wave) POD Results

Tank car panel evaluations performed using the ultrasonic (shear wave) test method were performed in accordance with Procedure No. TTCI/UTPOD.1, Ultrasonic Examinations (Other than Thickness Measurements), dated March 6, 1998. An ultrasonic procedure set-up sheet was established and the parameters identified on the sheet were checked and verified by the evaluating technician and a TTCI test representative prior to panel inspections. The parameters required identification and documentation of the UT instrument manufacturer and type, transducer type (manufacturer, frequency, shape, size, serial number), and wedge angle.

Calibration included documentation of the calibration block used, the date of last linearity check performed (screen height, amplitude control), and the instrument settings. Once calibration was complete the technicians determined their reference dB and added an additional 6 dB as their actual scanning dB for the panel evaluations. This process is in accordance with Section V of applicable ASME Boiler and Pressure Vessel Codes used in railroad tank car inspection.

Documentation of the various calibration processes was critical due to the variety of ultrasonic instruments and calibration materials used by the technicians (each participant was allowed to use their own ultrasonic equipment for the purpose of familiarity). Prior to panel evaluation by the technicians the measurement response from scanning of the master gage EDM notches were recorded to document the amplitude of the signal after calibration with various calibration blocks. Table 21 lists the signal amplitude recorded from the evaluation of the 0.50 in. (1.27 cm) EDM notch by each of the technicians prior to panel evaluation.

Table 21. Ultrasonic Shear Wave Signal Amplitude Responses on the 0.50-inch (1.27-cm) EDM Notch

Operator	Calibration Amplitude (including scan dB of +6)	Master Gage Signal Amplitude Recorded
1	100+	40
2	90	47
3	100+	80
4	95	100

During panel inspection the technicians identified all detected cracks by applying a 0.5 in. x 0.125 in. (1.27 cm x 0.318 cm) magnetic strip adjacent to the weld where the crack was identified.

After completing a panel inspection the technician who performed the evaluation along with a TTCI representative would identify and document the size and location of the detected cracks for entry into the POD database.

Test panel evaluation results for shear wave ultrasonic inspection identified a 90-percent probability of detection (POD) being achieved in three of the four evaluations. The evaluations that reached a 90-percent POD accomplished this at crack lengths of 1.68 (4.27 cm), 1.87 (4.75 cm), and 2.16 in. (5.49 cm). At a crack length of 2.00-inches the lowest POD percentage identified from the evaluations is shown to be 76 percent with the maximum at that point being 92 percent. The minimum POD at 1.00 in. is 48 percent and the maximum was 81 percent. At 0.50 in., the minimum POD is 14 percent and the maximum POD at that point was 67 percent. The minimum POD at 0.25 in. is 2 percent and the maximum was 49 percent. The percentage of spread between the crack lengths identified range from 53 percent at 0.50 in. to 16 percent at the 2.00-inch length.

The 50-percent POD achieved for the evaluations occur at cracks lengths of 0.26 in. or .66 cm (Operator 3), 0.38 in. or .97 cm (Operator 2), 0.92 in. or 2.34 cm (Operator 1) and 1.05 in. or 2.67 cm (Operator 4). When averaged the crack length at which a 50-percent POD was achieved occurs at approximately 0.65 in. (1.65 cm). From Table 22, the average POD at the largest range of crack lengths (3.00 in.) used in this evaluation is approximately 93 percent. In summary, at a crack length of approximately 0.65 in. an average POD of 50 percent was achieved and at the largest range of crack length, which is approximately 3.00 in., an over all average POD of 93 percent was achieved. Figure 56 shows an example of the shear wave ultrasonic NDE method performed on a tank car test panel.

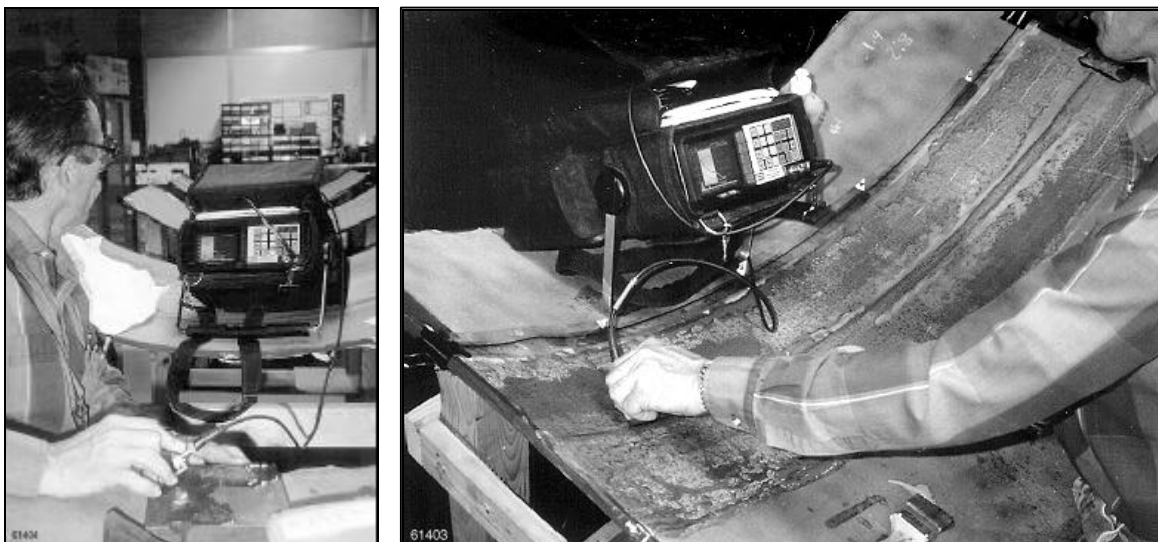

Figure 51. Shear Wave Ultrasonic Calibration and Scanning to Detect Fatigue Cracks in Tank Car Test Panels

Table 22. Ultrasonic Shear Wave Inspection POD Percentages

Crack Length	POD Percentage			
	Operator 1 (%)	Operator 2 (%)	Operator 3 (%)	Operator 4 (%)
0.00	0	0	0	0
0.13	0.3	17	33	3
0.25	2	35	49	8
0.50	14	60	67	22
0.75	35	73	75	36
1.00	57	81	80	48
1.50	82	88	86	65
2.00	92	92	89	76
2.50	96	94	91	82
3.00	97	95	93	86

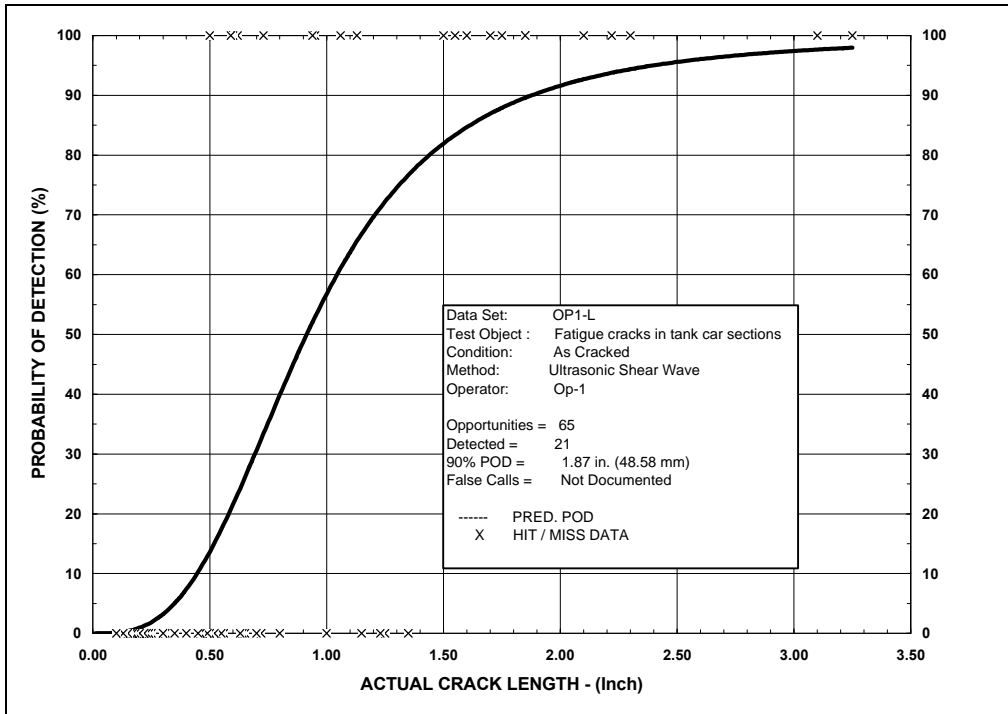

Figure 52. Shear Wave Ultrasonics POD Curve for Operator Number 1

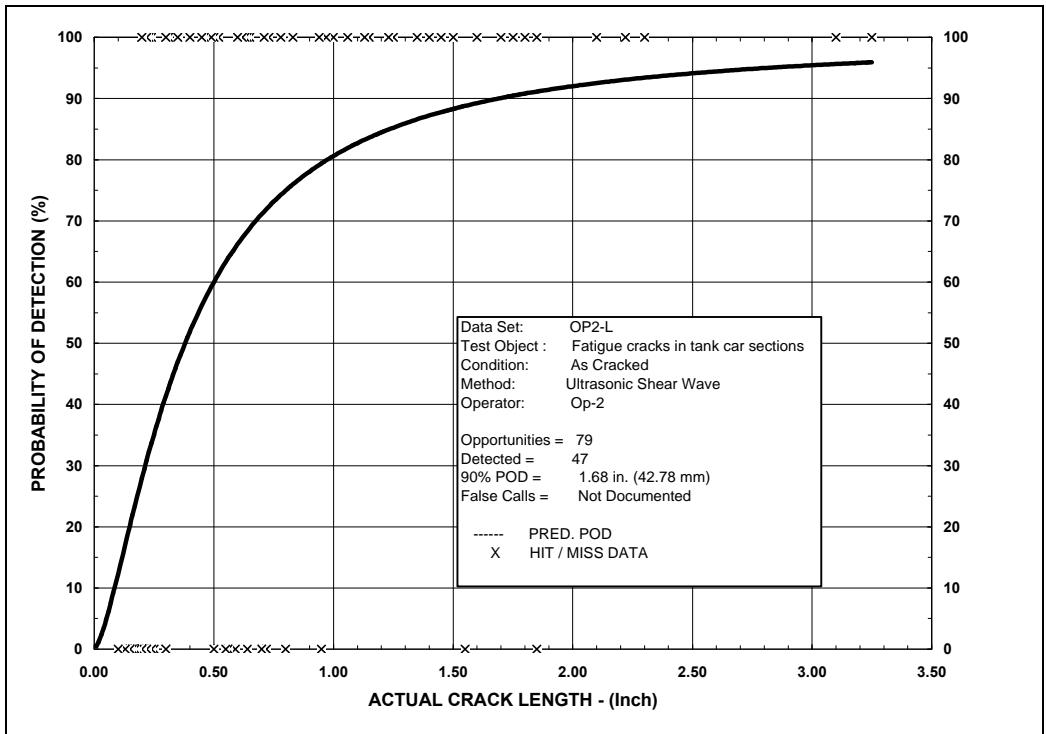

Figure 53. Shear Wave Ultrasonics POD Curve for Operator Number 2

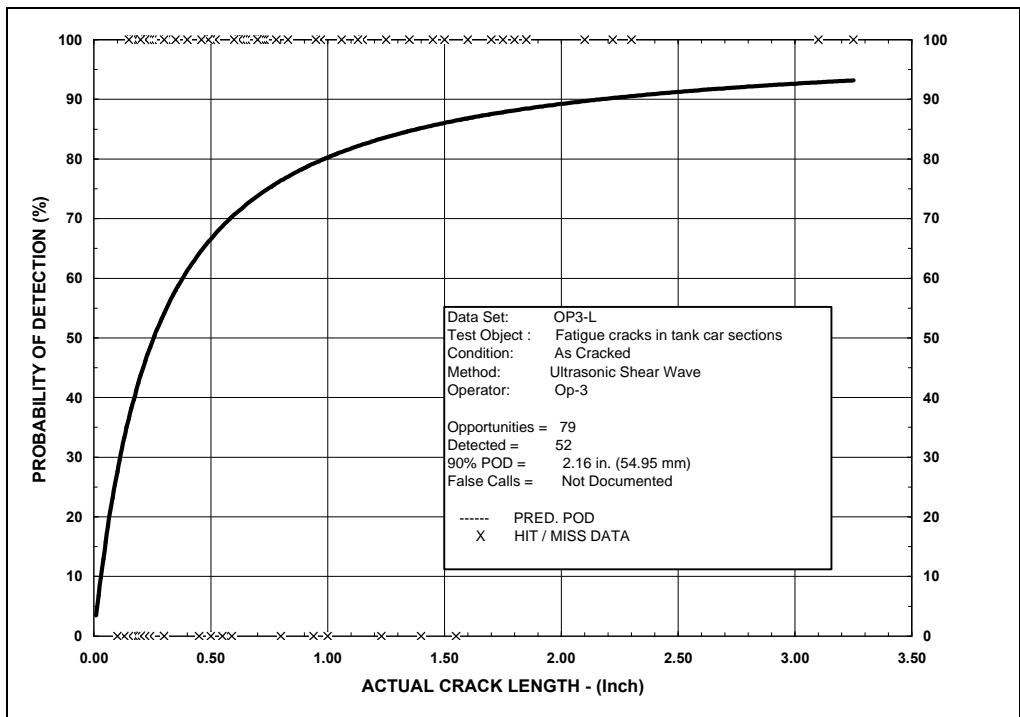

Figure 54. Shear Wave Ultrasonics POD Curve for Operator Number 3

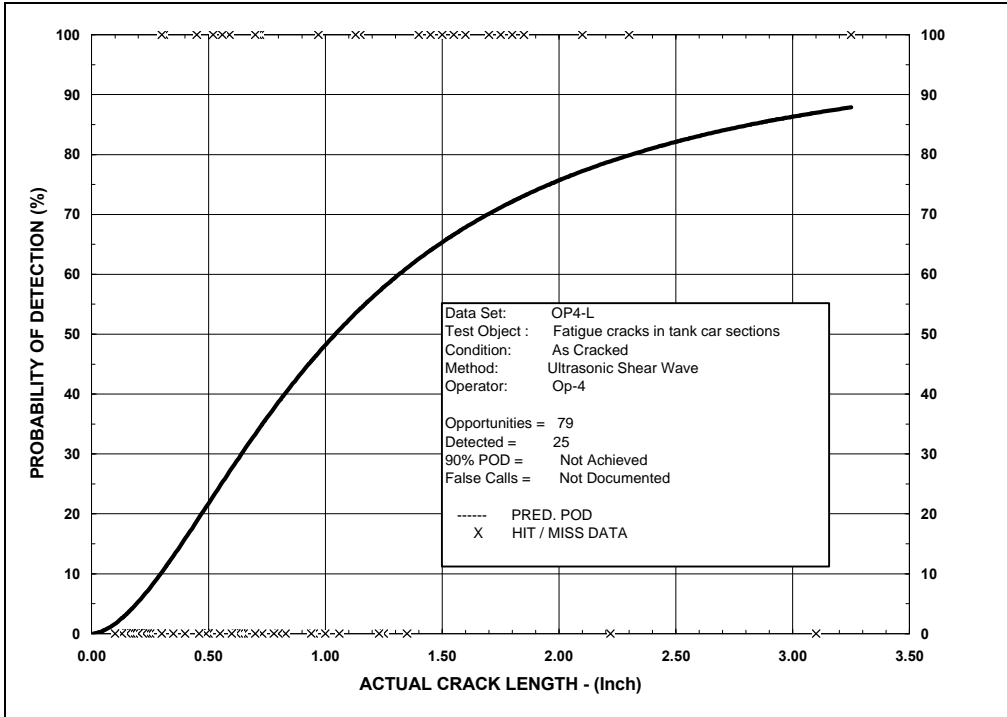

Figure 55. Shear Wave Ultrasonics POD Curve for Operator Number 4

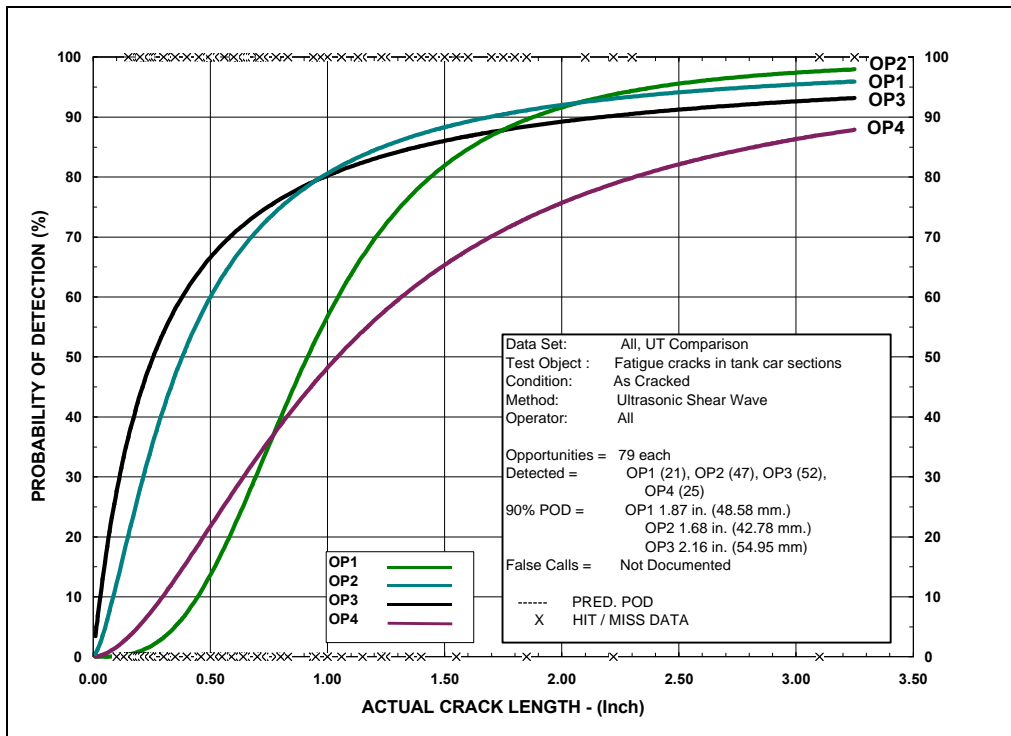

Figure 56. Shear Wave Ultrasonics POD Curve Comparison for All Operators

4.3.4 Visual Testing (Optically Aided) POD Results

Tank car panel evaluations performed using the visual test method were performed in accordance with the AAR *Manual of Standards and Recommended Practices*, Section C – Part III, Specifications for Tank Cars, Specification M-1002, Appendix “T,” Part T8.00 – Direct Visual Testing, dated 1/1/96. A visual testing procedure set-up sheet was established and the parameters identified on the sheet were checked and verified by the evaluating technician and a TTCI test representative prior to panel inspections. The parameters required identification and documentation of the VT equipment used to aid in the inspection (e.g., flashlight, magnifying glass, and mirrors), and the light intensity at and around the inspection surface.

During panel inspection the technicians identified all detected cracks by applying a 0.5 in. x 0.125 in. (1.27 cm x 0.318 cm) magnetic strip adjacent to the weld where the crack was identified. After completing a panel inspection the technician who performed the evaluation along with a TTCI representative would identify and document the size and location of the detected cracks for entry into the POD database.

Test panel evaluation results for optically aided visual inspection identified that a 90 percent probability of detection (POD) was not achieved on any of the four evaluations. The highest POD percentage reached by any of the operators was approximately 75 percent at a crack length of 3.25 in. (8.26 cm). At the 2.00-inch crack length the lowest POD percentage identified from the evaluations is shown to be 24 percent with the maximum at that point being 60 percent. The minimum POD at 1.00 in. is 22 percent and the maximum was 52 percent. At 0.50 in. the minimum POD is 11 percent and the maximum POD at that point was 44 percent. The minimum POD at 0.25 in. is 5 percent and the maximum was 37 percent. The percentage of spread between the crack lengths identified range from 30 percent at 1.00 in. to 36 percent at the 2.00-inch length.

The 50-percent POD achieved for the evaluations occur at cracks lengths of 0.83 in. or 2.11 cm (Operator 2), 1.46 in. or 3.71 cm (Operator 4), and 2.86 in. or 7.26 cm (Operator 1). Operator 3 never reached a POD of 50 percent. Including a maximum POD of 25 percent at a crack length of 3.00 in., for Operator 3, an average crack length to achieve a 50 percent POD is estimated to be approximately 2.04 in. (5.18 cm). From Table 23, the average POD at the largest range of crack lengths (3.00 in.) used in this evaluation is approximately 53 percent. In summary, at a

crack length of approximately 2.04 in. (5.18 cm) an average POD of 50 percent was achieved and at the largest range of crack length, which is approximately 3.00 in., an over all average POD of 53 percent was achieved. Figure 62 is an example of the optically aided visual NDE method performed on railroad tank car test panels.



Figure 57. Optically Aided Visual Inspection on the Inside and Outside Diameters of the Tank Car Test Panels

Table 23. Optically Aided Visual Inspection POD Percentages

Crack Length	POD Percentage			
	Operator 1 (%)	Operator 2 (%)	Operator 3 (%)	Operator 4 (%)
0.00	0	0	0	0
0.13	3	31	16	4
0.25	5	37	18	9
0.50	11	44	20	20
0.75	17	49	21	29
1.00	22	52	22	38
1.50	32	57	23	51
2.00	40	60	24	60
2.50	46	62	25	67
3.00	52	64	25	72

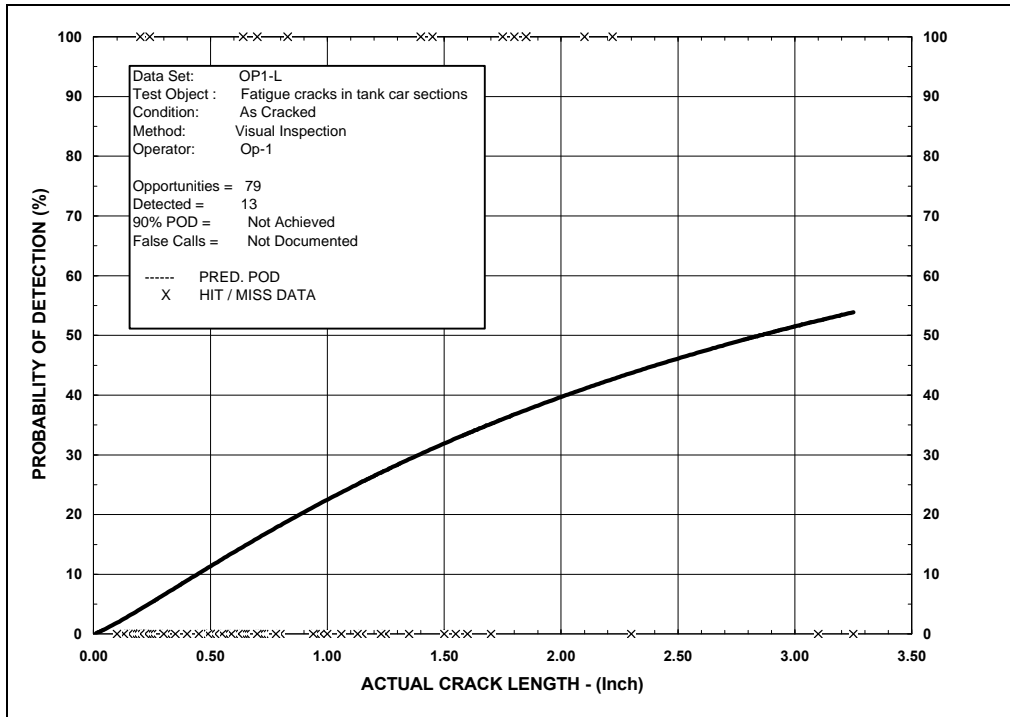

Figure 58. Optically Aided Visual POD Curve for Operator Number 1

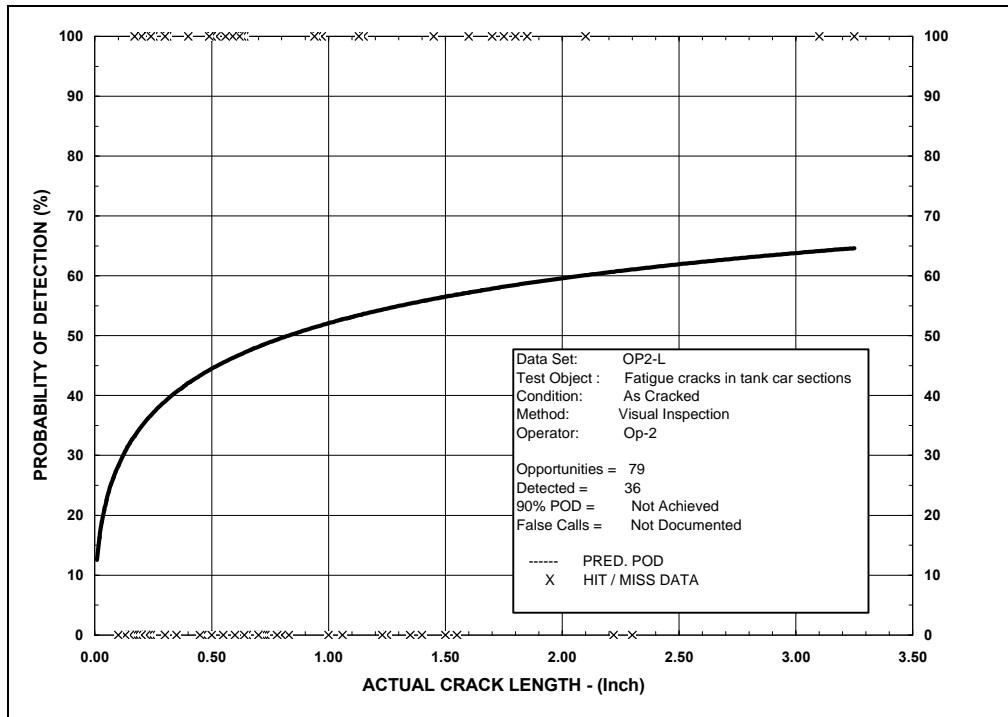

Figure 59. Optically Aided Visual POD Curve for Operator Number 2

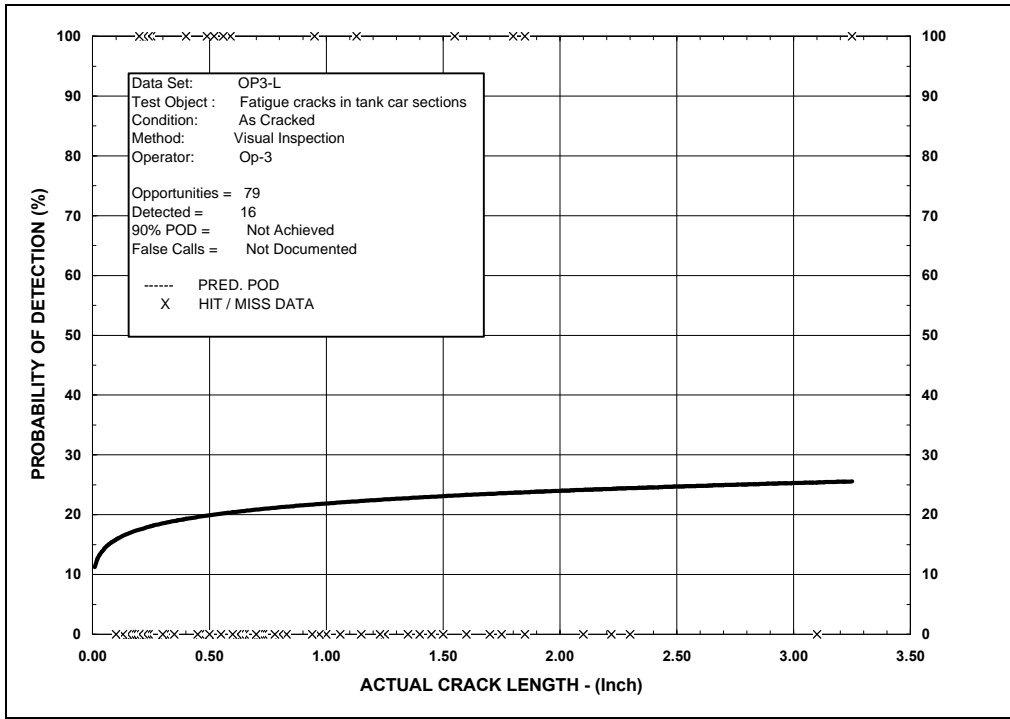

Figure 60. Optically Aided Visual POD Curve for Operator Number 3

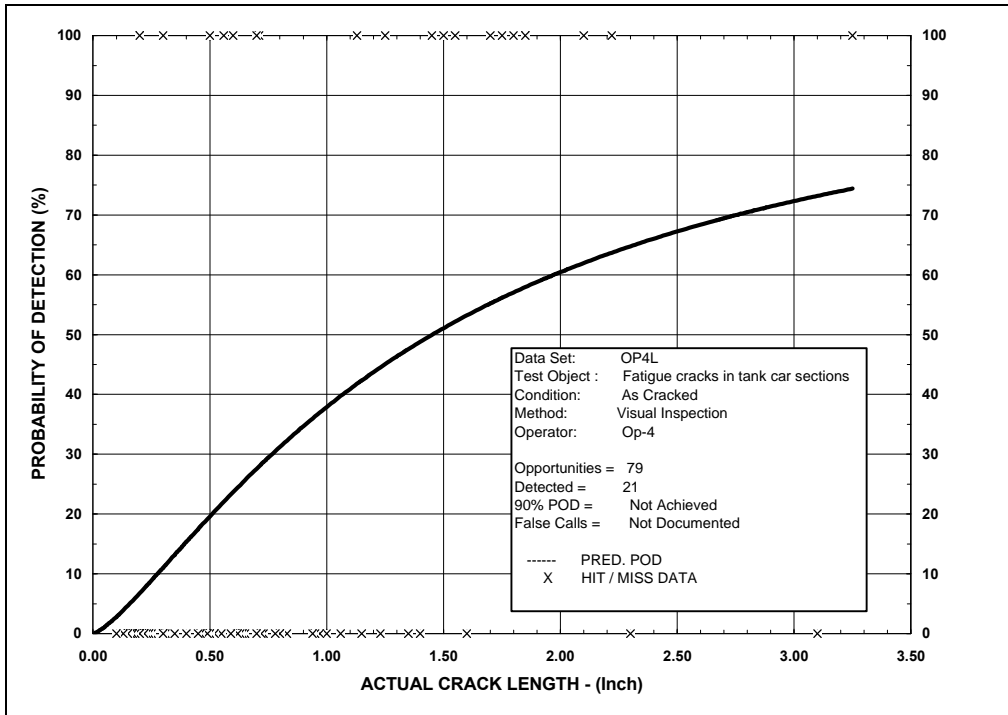

Figure 61. Optically Aided Visual POD Curve for Operator Number 4

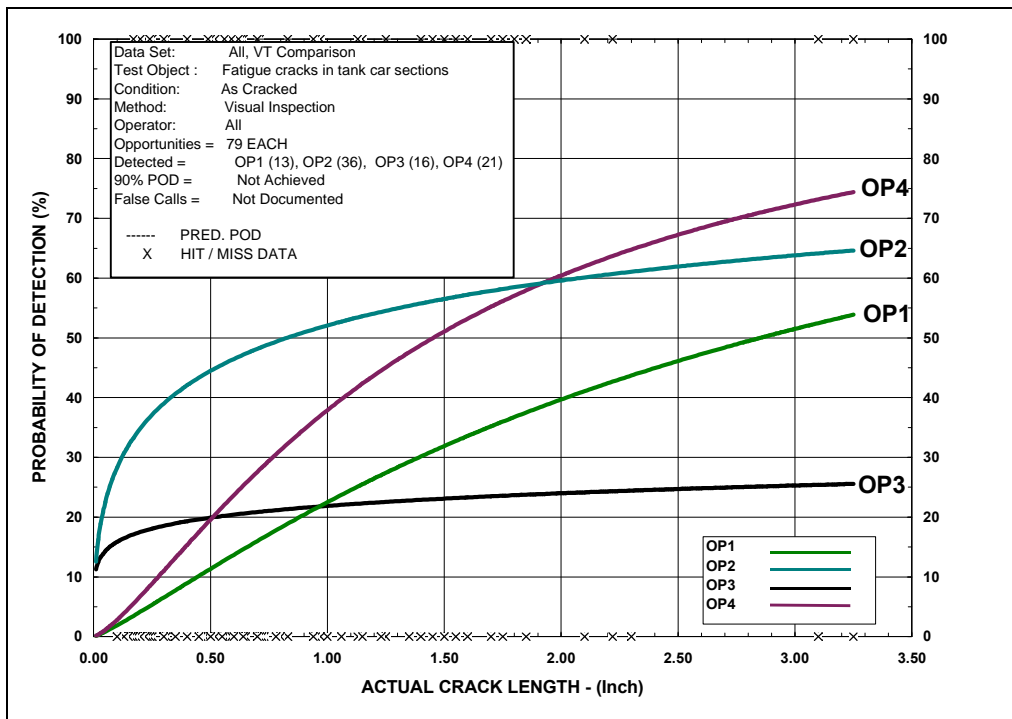

Figure 62. Optically Aided Visual POD Curve Comparison for All Operators

4.3.5 Comparison of POD Results

A comparison of POD results, using combined data from all of the evaluations performed shows that two of the four NDE methods used reached a POD of 90 percent. The combined data identifies that at a crack length of 2.90 in. (7.36 cm) shear wave ultrasonics reached a 90-percent POD and at a crack length of 3.39 in. (8.61 cm) a 90-percent POD was reached using fluorescent magnetic particle inspection. A 50-percent POD was achieved for all of the NDE methods at approximate crack lengths of 0.51 in. or 1.29 cm (PT), 0.22 in. or .56 cm (MT), 0.59 in. or 1.49 cm (UT), and 2.76 in. or 7.01 cm (VT).

The highest POD achieved for each of the test methods was 89 percent (PT), 90 percent (MT), 92 percent (UT), and 54 percent (VT). At crack lengths up to approximately 1.00 inch fluorescent magnetic particle inspection demonstrates a POD of at least 10 percent or greater over the other methods used for the test panel evaluations. Fluorescent magnetic particle, fluorescent liquid penetrant, and shear wave ultrasonics start to exhibit a comparable POD at approximate crack lengths of 1.50 in. (3.8 cm) and above.

Results show that of the four test methods used during tank car panel butt weld evaluations performed at TTC the fluorescent magnetic particle inspection method demonstrated the greatest probability of detection (at 0.50 in. or 1.27 cm) for fatigue cracks opened to the surface. Fluorescent liquid penetrant and shear wave ultrasonic inspections also demonstrate a reliable POD over the range of crack lengths used in the evaluations. It should be noted that three of the four methods used for the test panel evaluations require that defects be at or near the surface for detectability. Shear wave ultrasonics does not require that defects are located at or near the surface and while all three of the other inspections methods were performed on the outside diameter of the panels, UT was performed on the opposite side or the inside diameter. The POD demonstrated by the visual inspections suggests that although visual inspection may be the initial evaluation method used during any inspection further verification using supplemental NDE methods may also be required to provide reliable evaluation of suspected flaws.

The focus of this study has been to provide direction and insight into the current capability of the industry. The information/data generated should be used to enhance the inspection capabilities of not only the allowed NDE methods but also any new technologies that may be introduced for railroad tank car inspection.

Areas that could be targeted to increase the inspection reliability include:

- Operator training
- Calibration and set up
- Pre- and post-cleaning at the inspection area
- Determining proper efficiency for transducer frequency and size (ultrasonic inspection)
- Selection of the most desirable ultrasonic couplant
 - Viscosity (minimize air bubbles)
 - Non-corrosive

The tools to address and/or pursue increased inspection reliability are in place, along with full tank cars and tank car sections containing in-service and artificially induced defects. The POD evaluations performed during this project have provided the baseline capabilities of the industry along with the methodology to assess future technological improvements.

Table 24. POD Percentages from All Evaluations Combined for Each NDE Method

Crack Length	POD % (PT)	POD % (MT)	POD % (UT)	POD % (VT)
0.00	0	0	0	0
0.13	19	40	11	12
0.25	32	53	24	17
0.50	50	66	45	25
0.75	60	73	58	30
1.00	67	77	68	34
1.50	76	82	78	40
2.00	81	85	84	45
2.50	84	88	88	48
3.00	87	89	90	51

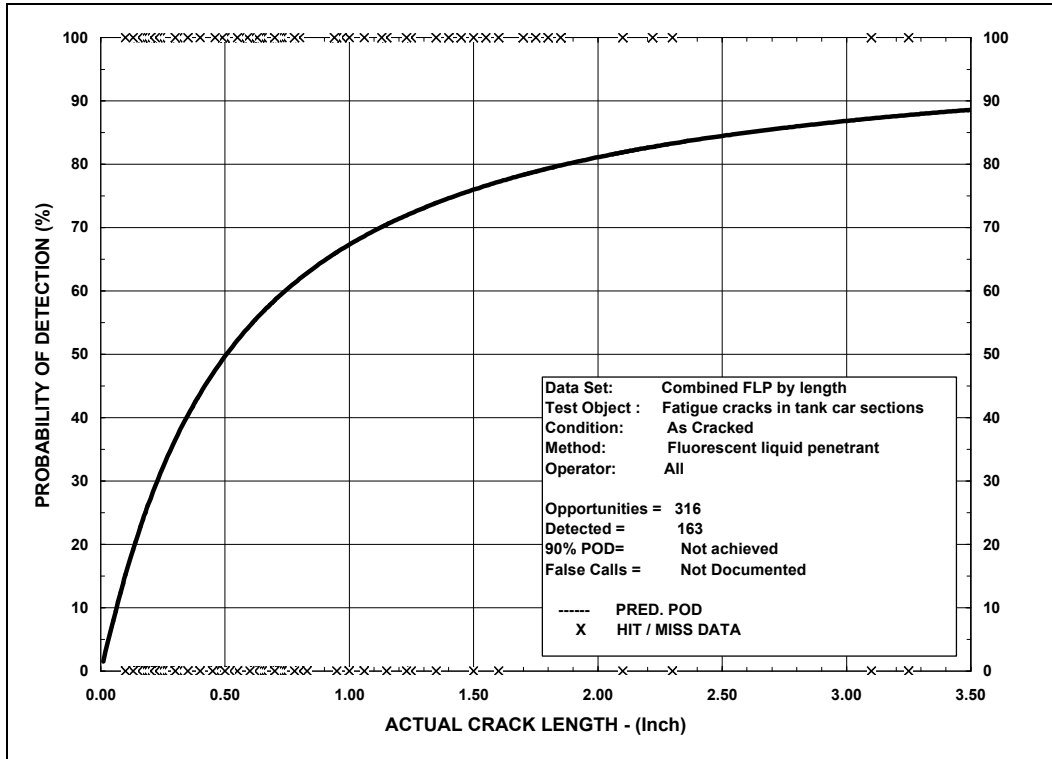

Figure 63. Fluorescent Liquid Penetrant POD Curve for All Operators Combined

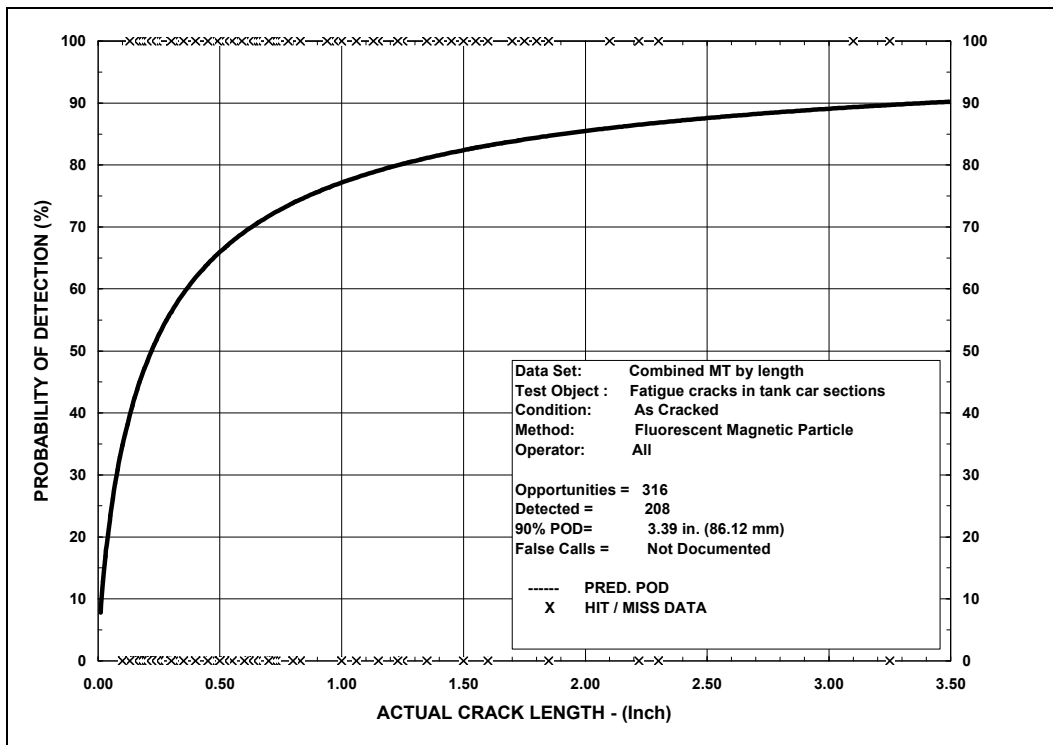

Figure 64. Fluorescent Magnetic Particle POD Curve for All Operators Combined

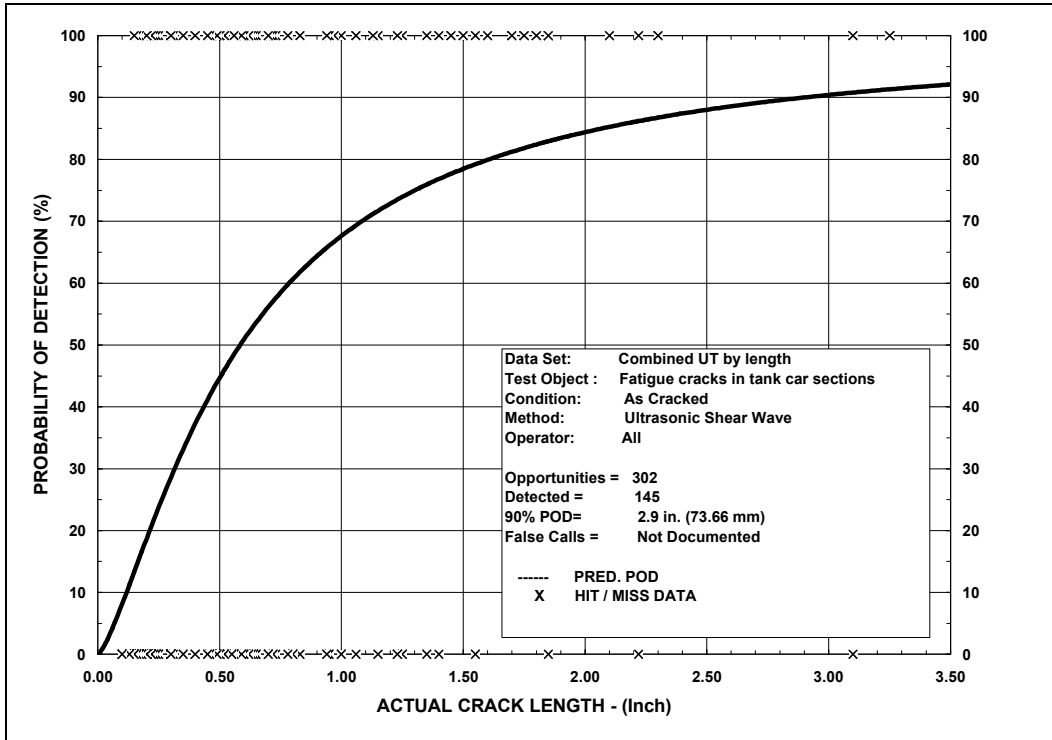

Figure 65. Shear Wave Ultrasonics POD Curve for All Operators Combined

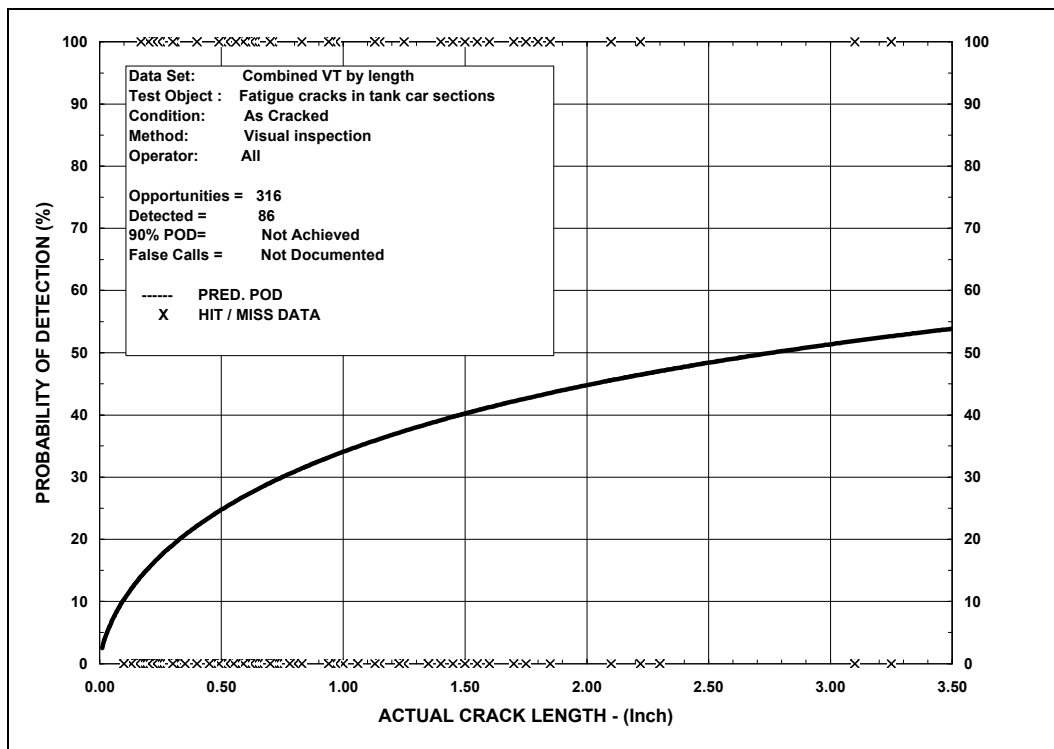

Figure 66. Optically Aided Visual POD Curve for All Operators Combined

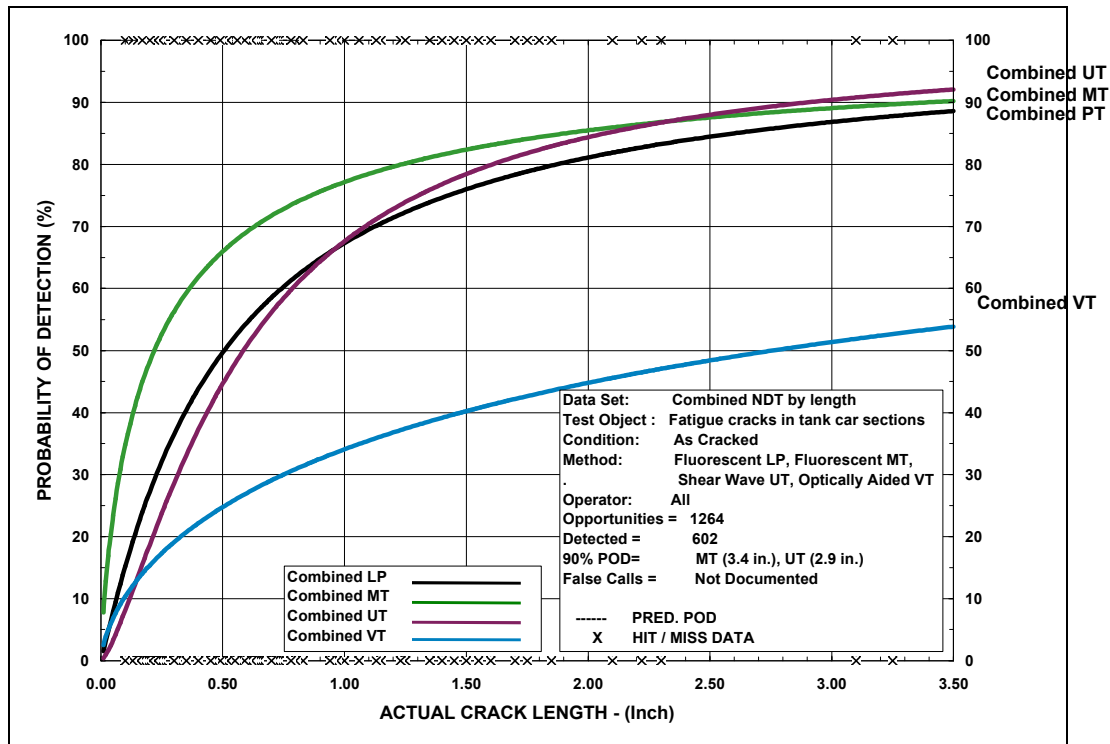

Figure 67. POD Curve Comparison for All Methods for All Operators Combined

5.0 CONCLUSIONS AND RECOMMENDATIONS

The focus of the Tank Car NDE project has been to provide direction and insight into the current capabilities of the railroad tank car industry in the use of the allowed NDE methods for tank car structural integrity inspections. Through government and industry cooperation the accomplishments from this project should play a vital role in the continued assessment and improvements in the reliability of inspections. The current industry effort focusing on life cycle management through the use of damage tolerance methods is reliant on NDE procedures that are capable, reliable and quantitative. The use of the POD to quantify NDE capabilities provides a sound base for the implementation of damage tolerance design and life cycle management applications.

The initiation of the defect library provides the railroad tank car industry with tank cars and tank car sections containing service and/or artificially induced discontinuities that can be used for operator or technology assessment and development. The base line validation and POD methodologies developed during this project can be used to assess and validate improvements in current and new technologies introduced for inspection. Benefits to both industry and government, which can be realized with the use of the artifacts available in the defect library at

TTC, include:

- Determining the reliability of inspections
- Improving safety through technology development
- Addressing industry needs in the areas of maintenance, inspection and damage tolerance
- Validating inspection technologies developed by government, academic and commercial organizations
- Developing validation models for probability of detection assessments
- Performing cost benefit analysis
- Promoting technology transfer

Baseline POD evaluation results show variability in NDE methods, procedures, and operators as demonstrated by Figures 68 and 69. Such variation is expected and is representative of the state of field inspections. Results differ from assumed capabilities predicted by some operators. The data now provides a common basis for analysis and communication. Radiography was not evaluated during this sequence but will be completed in further work and added as a supplement to this report.

A service life-cycle analysis should be performed to ascertain that the detection capabilities are consistent with design and life cycle management objectives. If objectives are not fully supported, an alternate management plan should be drafted. Additional operator assessments should be performed to expand the database. The specimens developed during POD evaluations should be used for operator training and qualification. The POD specimens need to be expanded to other areas requiring inspection as part of the HM 201 rulemaking.

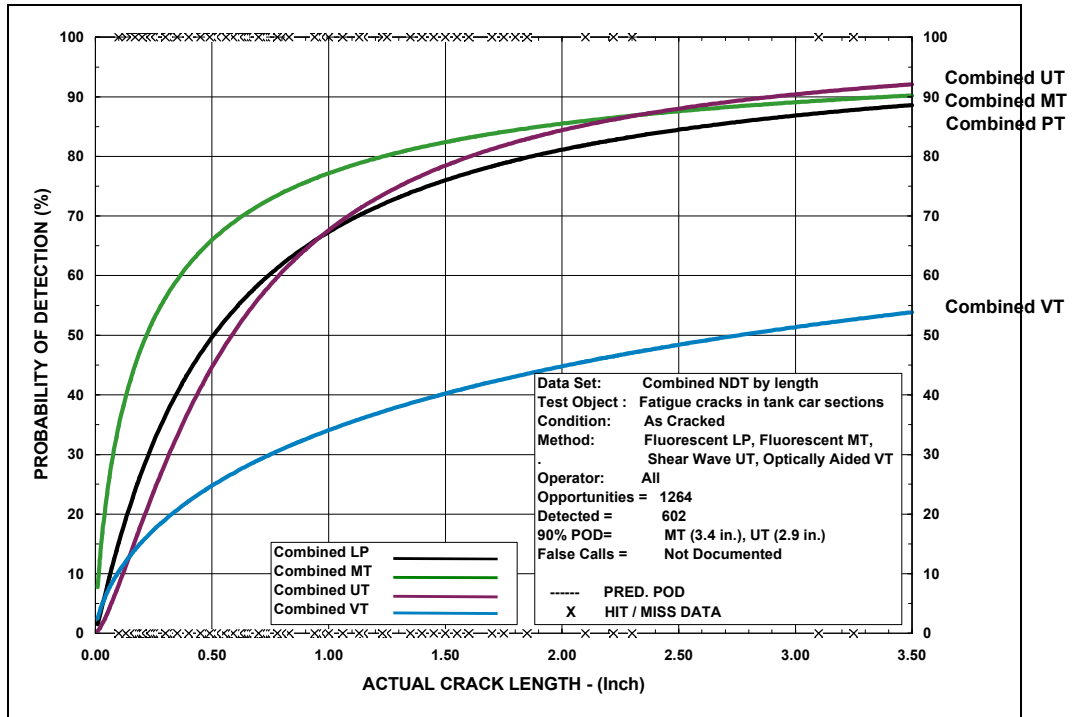

Figure 68. POD Curve Comparison of All Methods for All Operators Combined, Showing Variability Between NDE Test Methods

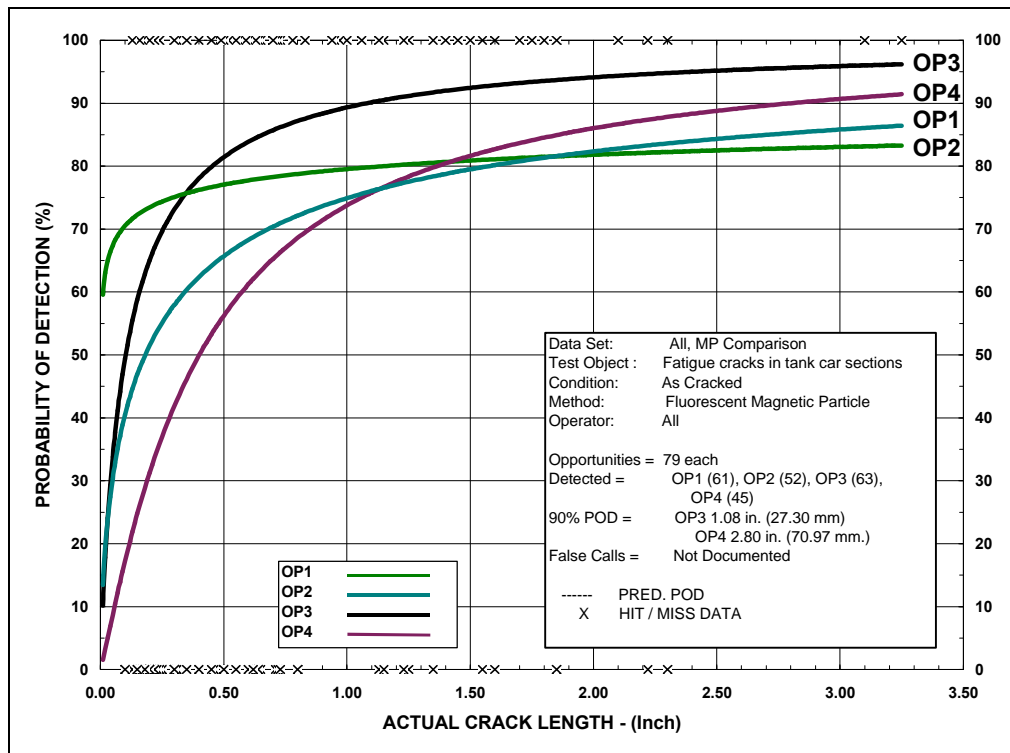

Figure 69. Fluorescent Magnetic Particle POD Curve Comparison for All Operators

References

1. J. H. Rader, "Qualification and Maintenance of Tank Cars," ASNT Chicago Section Nondestructive Testing of Railroad Tank Cars Technical Seminar Paper Summaries Book, May 1996.
2. Dr. W. W. Shurtleff, "FAA Airworthiness Assurance Nondestructive Inspection (NDI) Validation Center (AANC)," brochure, April 9, 1996.
3. "Requirements for Inspection and Test of Specification Tank Cars," Federal Register 49 CFR Section 180.509, June 1996.
4. Association of American Railroads, *Field Manual of the AAR*, "Interchange Rules," Rule 88 – Mechanical Requirements for Acceptance, Section B.2. Inspection and Repair, 1997.
5. Association of American Railroads, O&M Circular No. 1, Tank Car Stub Sill Inspection Program, July 17, 1997.
6. Department of Transportation, Federal Railroad Administration, FRA Emergency Order No. 17, Notice No. 1 (57 FR 41799), 9/11/92
7. A. Beattie, L. Dahlke, J. Gieske, B. Hansche, G. Phipps, D. Roach, R. Shagam, and K. Thompson, , "Emerging Nondestructive Inspection Methods for Aging Aircraft," DOT/FAA/CT-94/11, October 1994.
8. Association of American Railroads, *Manual of Standards and Recommended Practices*, Section C-Part III, Specifications for Tank Car Specification M-1002, January 1996.
9. American Society for Nondestructive Testing, *Nondestructive Testing Handbook* (Second Edition), Volume 10 – "Nondestructive Testing Overview," 1996.
10. Spencer F. W., "Visual Inspection Research Project Report on Benchmark Inspections," DOT/FAA/AR-96/65, October 1996.
11. Bobo, S. N. and Puckett, C. H., Visual Inspections for Aircraft, Draft Advisory Circular AC 43-XX, FAA Aging Aircraft Program, Federal Aviation Administration, Atlantic City International Airport, New Jersey.
12. Department of Transportation, DOT Hazardous Material Exemption, "AE Testing Exemption," DOT-E 10589, April 1991.
13. W. D. Rummel, P.E., D & W Enterprises Ltd., "Quantitative Nondestructive Evaluation Capabilities (Probability of Detection) In relation to HM-201 Rulemaking," July 1997.
14. Rummel W. D., P.E., Paul H. Todd Jr., Sandor A. Frecska, and Richard A. Rathke, "The Detection of Fatigue Cracks Nondestructive Testing Methods," NASA CR-2369, February 1974.
15. W. D. Rummel, P.E., D & W Enterprises Ltd., "Tank Car Nondestructive Evaluation – Analysis, Tutorial and Recommendations," Project Report No: DW97-801, August 1997.