



U.S. Department of
Transportation

Federal Railroad
Administration

Freeze-Thaw Performance Testing of Whole Concrete Railroad Ties

Office of Research
and Development
Washington, DC 20590

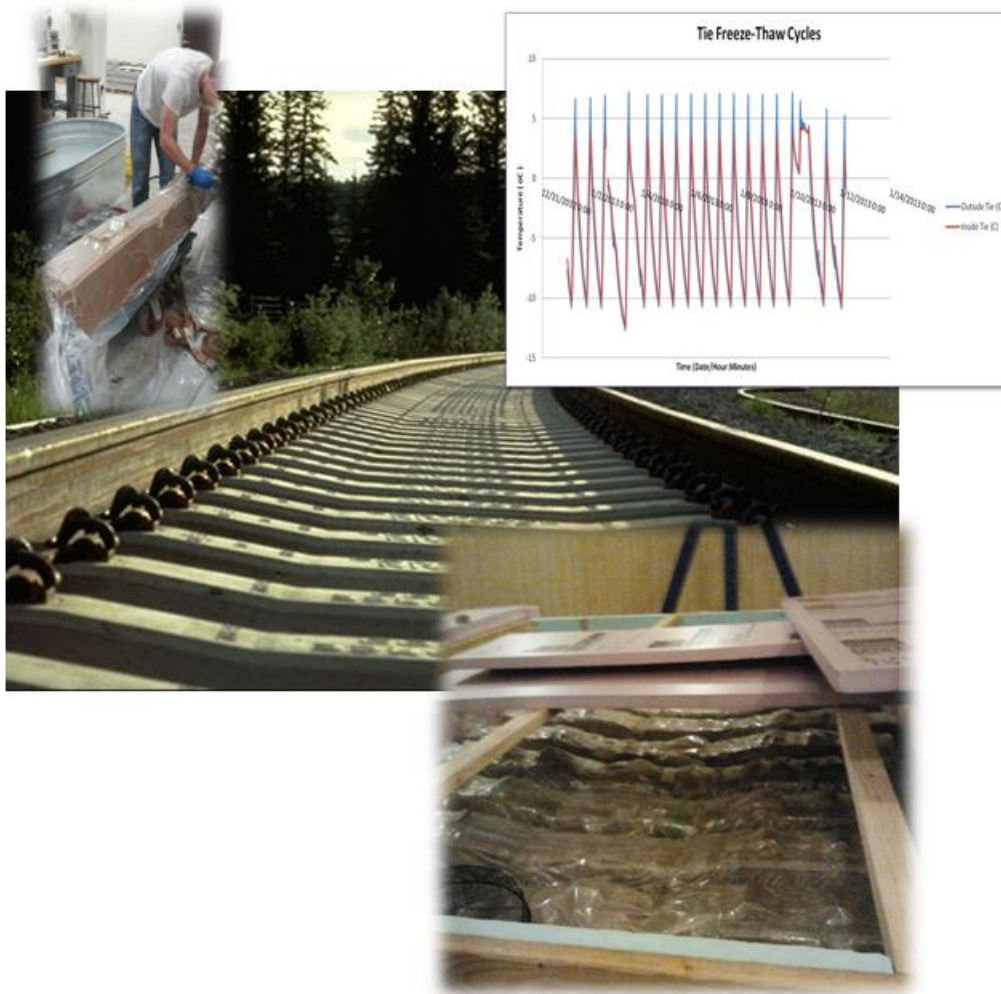

NOTICE

This document is disseminated under the sponsorship of the Department of Transportation in the interest of information exchange. The United States Government assumes no liability for its contents or use thereof. Any opinions, findings and conclusions, or recommendations expressed in this material do not necessarily reflect the views or policies of the United States Government, nor does mention of trade names, commercial products, or organizations imply endorsement by the United States Government. The United States Government assumes no liability for the content or use of the material contained in this document.

NOTICE

The United States Government does not endorse products or manufacturers. Trade or manufacturers' names appear herein solely because they are considered essential to the objective of this report.

REPORT DOCUMENTATION PAGE			<i>Form Approved</i> <i>OMB No. 0704-0188</i>	
Public reporting burden for this collection of information is estimated to average 1 hour per response, including the time for reviewing instructions, searching existing data sources, gathering and maintaining the data needed, and completing and reviewing the collection of information. Send comments regarding this burden estimate or any other aspect of this collection of information, including suggestions for reducing this burden, to Washington Headquarters Services, Directorate for Information Operations and Reports, 1215 Jefferson Davis Highway, Suite 1204, Arlington, VA 22202-4302, and to the Office of Management and Budget, Paperwork Reduction Project (0704-0188), Washington, DC 20503.				
1. AGENCY USE ONLY (Leave blank)		2. REPORT DATE October 2013		3. REPORT TYPE AND DATES COVERED Technical Report
4. TITLE AND SUBTITLE Freeze-Thaw Performance Testing of Whole Concrete Railroad Ties			5. FUNDING NUMBERS	
6. AUTHOR(S) Kyle Riding, Mohammed Albahtiti, Ahmad Ghadban, Cameron Stuart				
7. PERFORMING ORGANIZATION NAME(S) AND ADDRESS(ES) Kansas State University 2118 Fiedler Hall Manhattan, Kansas 66506-5000			8. PERFORMING ORGANIZATION REPORT NUMBER	
9. SPONSORING/MONITORING AGENCY NAME(S) AND ADDRESS(ES) U.S. Department of Transportation Federal Railroad Administration Office of Railroad Policy and Development Office of Research and Development Washington, DC 20590			10. SPONSORING/MONITORING AGENCY REPORT NUMBER DOT/FRA/ORD-13/39	
11. SUPPLEMENTARY NOTES COR: Cameron D. Stuart				
12a. DISTRIBUTION/AVAILABILITY STATEMENT This document is available to the public through the FRA Web site at http://www.fra.dot.gov .			12b. DISTRIBUTION CODE	
13. ABSTRACT (Maximum 200 words) Freezing and thawing durability tests of prestressed concrete ties are normally performed according to ASTM C666 specifications. Small specimens are cut from the shoulders of concrete ties and tested through 300 cycles of freezing and thawing. Saw-cutting these specimens may cause eccentricities in the prestressing, stress relief, and micro-cracking that may affect the results of the freeze-thaw durability tests, leading to false interpretation of the data. Conversely, testing an entire concrete tie rather than a sample may provide more consistent and accurate results by eliminating saw-cutting damage and sample variability. Seven whole prestressed concrete ties, supplied by the Illinois Department of Transportation (IDOT), were tested for freeze and thaw durability using ASTM C666 procedures that were modified slightly to accommodate the large test specimens. Deterioration over 300 cycles was measured by weight loss, length change, and impact resonance measurements. The test results revealed no significant deterioration in the test ties.				
14. SUBJECT TERMS Concrete freeze-thaw durability, concrete railroad ties, ASTM C666			15. NUMBER OF PAGES 50	
			16. PRICE CODE	
17. SECURITY CLASSIFICATION OF REPORT Unclassified	18. SECURITY CLASSIFICATION OF THIS PAGE Unclassified	19. SECURITY CLASSIFICATION OF ABSTRACT Unclassified	20. LIMITATION OF ABSTRACT	

METRIC/ENGLISH CONVERSION FACTORS

ENGLISH TO METRIC

LENGTH (APPROXIMATE)

- 1 inch (in) = 2.5 centimeters (cm)
- 1 foot (ft) = 30 centimeters (cm)
- 1 yard (yd) = 0.9 meter (m)
- 1 mile (mi) = 1.6 kilometers (km)

AREA (APPROXIMATE)

- 1 square inch (sq in, in²) = 6.5 square centimeters (cm²)
- 1 square foot (sq ft, ft²) = 0.09 square meter (m²)
- 1 square yard (sq yd, yd²) = 0.8 square meter (m²)
- 1 square mile (sq mi, mi²) = 2.6 square kilometers (km²)
- 1 acre = 0.4 hectare (he) = 4,000 square meters (m²)

MASS - WEIGHT (APPROXIMATE)

- 1 ounce (oz) = 28 grams (gm)
- 1 pound (lb) = 0.45 kilogram (kg)
- 1 short ton = 2,000 pounds (lb) = 0.9 tonne (t)

VOLUME (APPROXIMATE)

- 1 teaspoon (tsp) = 5 milliliters (ml)
- 1 tablespoon (tbsp) = 15 milliliters (ml)
- 1 fluid ounce (fl oz) = 30 milliliters (ml)
- 1 cup (c) = 0.24 liter (l)
- 1 pint (pt) = 0.47 liter (l)
- 1 quart (qt) = 0.96 liter (l)
- 1 gallon (gal) = 3.8 liters (l)
- 1 cubic foot (cu ft, ft³) = 0.03 cubic meter (m³)
- 1 cubic yard (cu yd, yd³) = 0.76 cubic meter (m³)

TEMPERATURE (EXACT)

$$[(x-32)(5/9)] \text{ } ^\circ\text{F} = y \text{ } ^\circ\text{C}$$

METRIC TO ENGLISH

LENGTH (APPROXIMATE)

- 1 millimeter (mm) = 0.04 inch (in)
- 1 centimeter (cm) = 0.4 inch (in)
- 1 meter (m) = 3.3 feet (ft)
- 1 meter (m) = 1.1 yards (yd)
- 1 kilometer (km) = 0.6 mile (mi)

AREA (APPROXIMATE)

- 1 square centimeter (cm²) = 0.16 square inch (sq in, in²)
- 1 square meter (m²) = 1.2 square yards (sq yd, yd²)
- 1 square kilometer (km²) = 0.4 square mile (sq mi, mi²)
- 10,000 square meters (m²) = 1 hectare (ha) = 2.5 acres

MASS - WEIGHT (APPROXIMATE)

- 1 gram (gm) = 0.036 ounce (oz)
- 1 kilogram (kg) = 2.2 pounds (lb)
- 1 tonne (t) = 1,000 kilograms (kg) = 1.1 short tons

VOLUME (APPROXIMATE)

- 1 milliliter (ml) = 0.03 fluid ounce (fl oz)
- 1 liter (l) = 2.1 pints (pt)
- 1 liter (l) = 1.06 quarts (qt)
- 1 liter (l) = 0.26 gallon (gal)
- 1 cubic meter (m³) = 36 cubic feet (cu ft, ft³)
- 1 cubic meter (m³) = 1.3 cubic yards (cu yd, yd³)

TEMPERATURE (EXACT)

$$[(9/5) y + 32] \text{ } ^\circ\text{C} = x \text{ } ^\circ\text{F}$$

QUICK INCH - CENTIMETER LENGTH CONVERSION

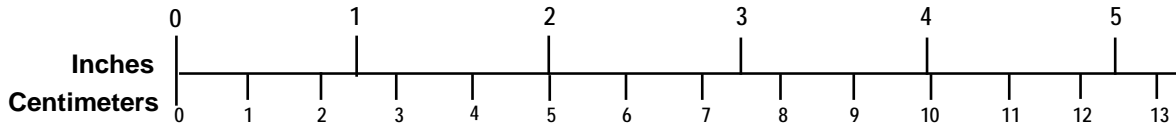

QUICK FAHRENHEIT - CELSIUS TEMPERATURE CONVERSION

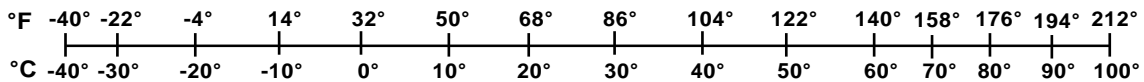

For more exact and or other conversion factors, see NIST Miscellaneous Publication 286, Units of Weights and Measures. Price \$2.50 SD Catalog No. C13 10286

Updated 6/17/98

Contents

- Executive Summary 1
- 1. Introduction 2
 - 1.1 Test Objective..... 2
- 2. Methodology..... 4
 - 2.1 Tie Preparation 8
 - 2.2 Freeze-Thaw Cycling 10
- 3. Results and Analysis..... 16
 - 3.1 Concrete Expansion..... 16
 - 3.2 Weight Change 17
 - 3.3 Resonant Frequency Results 19
 - 3.4 Visual Observations 24
- 4. Conclusion..... 27
- 5. References 28
- Appendix. Additional Data and Figures 29
- Abbreviations and Acronyms 42

Illustrations

Figure 1: Summary of whole tie freezing and thawing test procedures.	8
Figure 2: Railroad tie with Whittemore points on front (both ends have the same configuration) 9	9
Figure 3: Railroad tie immersed in lime water in two Behlen galvanized round end tanks	9
Figure 4: Railroad tie vacuum sealed and wrapped with packing tape.....	10
Figure 5: Chamber layout.	11
Figure 6: Railroad ties in the testing chamber.	11
Figure 7: Typical freeze-thaw cycle temperatures.....	12
Figure 8: Railroad ties unwrapping.....	13
Figure 9: Whittemore point length measurements.....	13
Figure 10: Resonant frequency measurements.	14
Figure 11: Names of resonant frequency reading locations.....	14
Figure 12: Geometrical locations for resonant frequency readings.	15
Figure 13: Impact and accelerometer locations on tie top surface.....	15
Figure 14: Length change in diagonal direction at the non-ID side.	17
Figure 15: Concrete tie weight.....	18
Figure 16: Concrete ties cumulative mass loss.	19
Figure 17: Pulse vibration for tie #2-05103-2 Plant C at the 258 th cycle.	20
Figure 18: Frequency domain for tie #2-05103-2 Plant C at the 258 th cycle.....	21
Figure 19: End impact frequency domain for Plant A ties at the 258 th cycle	21
Figure 20: End impact frequency domain for Plant B ties at the 258 th cycle	22
Figure 21: End impact frequency domain for Plant C ties at the 258 th cycle	22
Figure 22: Overall resonant frequency for all ties tested at different cycles	24
Figure 23: Tie #2-4386-B pop-outs and surface scaling.....	25
Figure 24: Tie #2-4386-B corner piece after fracture.	25
Figure 25: Tie #1-4397-F shallow cracking.....	26
Figure 26: Small pop-out/crack in tie #1-4397-F.	26
Figure A-1: Length change in diagonal direction at the ID side.....	29
Figure A-2: Length change in vertical direction at the ID side	29
Figure A-3: Length change in horizontal direction at the ID side	30
Figure A-4: Length change in horizontal direction at the opposite side to ID	30
Figure A-5: Length change in vertical direction at the opposite side to ID.....	31

Figure A-6: RDME values at the ID side for the top transverse direction of the tie	31
Figure A-7: RDME values at the ID side for the short top longitudinal direction of the tie	32
Figure A-8: RDME values at the ID side for the long top longitudinal direction of the tie	32
Figure A-9: RDME values at the ID side for the side transverse direction of the tie.....	33
Figure A-10: RDME values at the ID side for the side longitudinal direction of the tie.....	33
Figure A-11: RDME values at the other side for the short top longitudinal direction of the tie ..	34
Figure A-12: RDME values at the other side for the long top longitudinal direction of the tie ...	34
Figure A-13: RDME values at the other side for the side transverse direction of the tie.....	35
Figure A-14: RDME values at the other side for the transverse longitudinal direction of the tie	35
Figure A-15: RDME values at the middle for the top transverse direction of the tie.....	36
Figure A-16: RDME values at the middle for the top longitudinal direction of the tie.....	36
Figure A-17: RDME values at the middle for the side transverse direction of the tie	37
Figure A-18: RDME values at the middle for the side longitudinal direction of the tie	37
Figure A-19: Impact acceleration measurements for tie #2-05103-2 Plant C at the 258 th cycle ..	38
Figure A-20: Frequency domain for tie #2-05103-2 Plant C at the 258 th cycle after impact	38
Figure A-21: Tie end frequency domain for Plant B ties after the 277 th cycle after impact.....	39
Figure A-22: Tie end frequency domain for Plant C after the 277 th cycle after impact	39
Figure A-23: Tie end frequency domain for Plant A at the 277 th cycle after impact	40
Figure A-24: Tie #2-4386-B Plant A visual observations	40
Figure A-25: Tie #1-05009-3 Plant C visual observations	41
Figure A-26: Tie #2-05103-2 Plant C visual observations	41

Tables

Table 1: Tie sampling information. Shaded rows indicate ties tested in freeze-thaw conditions...	4
Table 2: Differences between ASTM C666 and K-State whole concrete tie testing.....	5
Table 3: Summary of experimental results at 300 cycles	16
Table 4: Resonant frequencies for all ties.....	23

Executive Summary

Under contract with the U.S. Department of Transportation (U.S. DOT), Federal Railroad Administration (FRA), researchers at Kansas State University (K-State) and the University of Illinois at Urbana-Champaign (UIUC) are studying the material and construction parameters that affect the freeze-thaw performance of concrete railroad crossties and the testing procedures used to estimate this performance. The initial project work package includes an experimental procedure to test the freeze-thaw performance of whole concrete ties using ASTM C666 test procedures. The objective of the test was to examine the capability of railroad ties to maintain their structural integrity during freezing and thawing cycles. This examination was carried out using procedures based on ASTM C666 specifications, modified as required to accommodate whole ties rather than small specimens.

Seven pre-stressed concrete ties were supplied by the Illinois Department of Transportation (IDOT) and tested at K-State. The ties were soaked in lime water for 2 days, wrapped in wet burlap, and sealed in plastic tubes to ensure the concrete surface remained uniformly wet during testing. The concrete ties were then exposed to 300 cycles of freezing and thawing in a specially built environmental chamber. The freezing and thawing cycles took longer than required by ASTM C666 because of the large thermal mass of the whole ties. One freezing and thawing cycle typically took 13 hours, as opposed to the 2 to 5 hours per cycle specified by ASTM C666. Length change, weight, and resonant frequency measurements were taken at least every 36 cycles as specified by ASTM C666.

The test results indicate that the ties did not experience significant degradation as a result of the 300-cycle freeze-thaw process. Length measurements revealed that no significant permanent localized change in length occurred. Weight measurements showed that the ties did not experience large losses in weight from freeze-thaw deterioration. The resonant frequency measurements taken between short distances in the ties were inconclusive regarding the durability performance of the ties. The impact resonance measurements for the whole tie indicated that no significant internal structural damage occurred in the ties. Visual inspection revealed that the ties suffered only surface damage represented by pop-outs and small, shallow surface cracking likely caused by pop-outs.

These results will be used to guide further research to identify test procedures required to ensure the freezing and thawing durability of concrete railroad ties that include the effects of concrete material properties and manufacturing process. The results will also help guide work to determine how manufacturing process affects the concrete material properties required for durability and how well test conditions simulate actual field exposure.

1. Introduction

This project was sponsored by U.S. DOT, FRA. The project objective is to determine material, manufacturing process, and quality control testing requirements required to reliably produce freeze-thaw durable concrete railroad ties.

Concrete freezing and thawing durability testing is typically performed according to ASTM C666 using small specimens saw-cut from railroad ties or cast from the same concrete mixture used in manufacturing ties, but not subjected to the same placement and consolidation processes. For this project, freeze-thaw testing was performed on whole concrete railroad ties instead of small saw-cut specimens in order to understand how sample size and preparation potentially affect test results.

Concrete railroad ties are commonly exposed to very severe environments in track. They are typically expected to last 50 years under harsh conditions that include extreme heat, cold, and wet conditions that can accelerate deterioration. Some of the most common failure mechanisms observed in track include cracking, rail seat deterioration, alkali-aggregate reaction, delayed ettringite formation, and freezing and thawing damage [1]. Concrete durability in freezing and thawing conditions has recently become a subject of interest to tie producers and track owners.

Repeated freezing and thawing of concrete railroad ties may lead to damage ranging from minor spalling to complete deterioration of the concrete. Freeze-thaw cycles can lead to a large decrease in compressive and tensile strength because of micro-cracking in the concrete matrix [2]. A common mode of concrete tie deterioration due to freeze and thaw cycles is flakes or chips of concrete spalling from the concrete surface [3]. Micro-cracking near the surface allows additional water into the concrete, increasing the severity of the freezing cycles and potentially accelerating freeze-thaw damage. Further deterioration may include structural cracking and total failure or crumbling of the ties. For concrete under freeze-thaw conditions, higher volume-to-surface area ratios have been found to lead to lower rates of concrete deterioration [3], possibly due to a change in the rate of freezing and strains generated from the temperature variations. Although concrete ties have a low volume-to-surface area ratio compared with most civil structures, they are much larger in size and volume-to-surface area ratio than the small prisms traditionally used for performance testing.

Damage symptoms from concrete freeze-thaw deterioration are surface scaling, mass loss, and concrete cracking. Concrete surface scaling can be described as the progressive loss of particles of cement or mortar, usually a few millimeters in thickness [4]. Pop-outs, usually conical and shallow in nature, refer to the rapid loss in concrete at the specimen's surface [5]. Pop-outs occur either when a saturated porous or weak aggregate splits in two as a result of frost action and exerts internal pressure inside the aggregate, or when that water is ejected from the aggregate due to the same pressure, causing mortar or paste cover to spall off of the concrete. Low-density particles such as chert or soft limestone are a typical cause of pop-outs. The presence of a small amount of these particles can be undesirable from an aesthetic point of view, but generally do not cause loss in structural integrity [6].

1.1 Test Objective

The goal of this research is to test whole concrete ties using procedures based on ASTM C666 [7] specifications to estimate their construction quality with respect to freeze-thaw durability.

ASTM C666 specifies how to test small concrete prisms to measure their ability to withstand freezing and thawing cycles. According to those specifications, specimens are subjected to 300 cycles of freezing and thawing, or until the dynamic modulus of elasticity is reduced to less than 60 percent of the original, whichever occurs first. This test method also allows for optional testing of the concrete expansion and mass loss. Some State departments of transportation use a length change measurement criteria instead of the dynamic modulus of elasticity, while others require that concrete be tested with both dynamic modulus of elasticity and length change measurements. When using the optional length change criteria, 0.1 percent expansion is often used as the end of test, although some agencies such as IDOT use an expansion threshold of 0.06 percent [8]. Concrete is typically said to fail the test when the concrete dynamic modulus of elasticity is lower than 60 percent of the original, or when the concrete reaches an expansion of 0.1 percent.

Concrete samples for testing resistance to freezing and thawing are usually saw-cut from the prestressed concrete tie. Saw-cutting prestressed concrete railroad ties may damage the samples, giving results that may not be representative of the whole tie. Potential damage could include (1) micro-cracking that would allow water to penetrate the sample faster and accelerate damage, (2) bursting stresses caused by the proximity of the steel to the surface, and (3) different stress states and micro-cracking caused by eccentricities from cutting pre-stressed concrete. When prestressing wires or strands are too close together to allow for a specimen without steel to be saw-cut, samples are cast from the same concrete but not subjected to the same consolidation and finishing operations as the ties, potentially making them nonrepresentative of the concrete tie behavior during freezing and thawing.

As part of this study, whole concrete railroad ties were tested using procedures based on ASTM C666. Testing whole railroad ties eliminates the potential saw-cutting problems previously mentioned and may give a more realistic evaluation of the concrete tie durability in the field, not just that of the original concrete material. Some modifications were made to the ASTM C666 test method to accommodate the larger sample size. First, the freezing and thawing cycling time was extended because of the larger thermal mass. Second, the concrete ties being tested were wrapped in burlap and sealed in plastic tubes instead of in water containers. (Rigid water containers can prevent the ice and concrete from expanding during freezing, causing damage that would not be representative of field concrete that is not restrained from expanding.) The methodology used in the whole tie testing is fully described in Section 2.

2. Methodology

Sixteen prestressed concrete railroad ties were sampled by IDOT and sent to K-State for freeze-thaw testing. Table 1 shows the ties' ID numbers, location of sampling, sampling dates, casting plant, and tie condition when sampled. Seven whole ties were tested in 300 cycles of freezing and thawing using a modified version of ASTM C666. Because of specimen size, a few modifications to the procedures were necessary and were made based on procedures used by a previous research study performed by CN [3].

Table 1: Tie Samples

Tie #	Mile Post of Tie Sampling	Date Tie Was Sampled	Tie ID #	Casting Plant	Tie Condition as Found	Tie Tested in Freezing and Thawing
1	217	10/4/2010	#2-042-C	Plant B	Good	X
2	202	10/21/2010	#1-092-B	Plant B	Good	
3	171	12/3/2010	#1-109-C	Plant B	Good	
4	114	6/4/2011	#2-134-A	Plant B	Good	
5	104	6/18/2011	#2-05103-2	Plant C	Good	X
6	96	6/23/2011	#2-034-B	Plant B	Good	
7	90	7/5/2011	#1-05075-3	Plant C	Good	
8	83	7/16/2011	#1-05009-3	Plant C	Good	X
9	73	7/21/2011	#1-05035-4	Plant C	Good	
10	273	8/7/2011	#1-06037-5	Plant C	Good	
11	269	8/17/2011	#1-053-C	Plant B	Good	X
12	266	8/19/2011	#2-05029-2	Plant C	Good	X
13	83	8/1/2012	#1-4397-F	Plant A	Missing 1 top plate	X
14	84	8/1/2012	#2-4386-B	Plant A	Good	X
15	247	4/21/2012	#1-F-4299	Plant A	Good	
16	242	5/1/2012	#2-4397-D	Plant A	Good	

The most common method used to measure concrete susceptibility to freeze-thaw deterioration is ASTM C666. With this test method, concrete specimens between 3 x 3 x 11 in (75 x 75 x 279 mm) and 5 x 5 x 16 in (125 x 125 x 405 mm) are saturated in a lime water bath for at least 2 days, then conditioned at 40 °F (4 °C). The concrete is then frozen to 0 °F (-18 °C) and thawed to 40 °F (4 °C) 300 times. The freezing is rapid, with up to 12 cycles performed per day. During testing, samples are either immersed in water, or frozen in air and thawed by flooding the

chamber containing the concrete samples with water [7]. Damage is monitored by dynamic modulus of elasticity, length change, and mass loss. Seven concrete railroad ties from a high-speed rail line were tested under freeze-thaw conditions to determine their expected freeze-thaw durability in track. The differences between the ASTM C666 test procedures and those used for this experiment [7] are presented in Table 2: Differences between ASTM C666 and K-State whole concrete tie testing below.

Table 2: Differences between ASTM C666 and K-State whole concrete tie testing.

	ASTM C666 [7]	Full Scale Ties Modifications
<i>Freezing-and-Thawing Apparatus</i>	The apparatus must be in compliance with the following: (1) For Procedure A, the specimen must be completely surrounded by not less than 1/32 in (1 mm) nor more than 1/8 in (3 mm) of water at all times. (2) For Procedure B, the specimen must be completely surrounded by air during the freezing period and by water during the thawing period.	Tie was kept wet by wrapping in wet burlap and vacuum sealed with plastic tubing.
	Rigid containers are not allowed.	None
	The temperature on the specimen or specimen container surface shall be uniform to within 6 °F (3 °C), except during the transition period between freezing and thawing.	None
<i>Temperature-Measuring Equipment</i>	The measuring device must be capable of measuring the temperature at several points within the chamber and at the centers of the control specimen to within 2 °F (1 °C).	Concrete temperature was monitored at the same depth from the concrete surface as specified by ASTM C666, or 1.5 in (38 mm) from the concrete surface.
<i>Scales</i>	The scale must have a capacity at least 50 percent greater than the mass of the specimens and accurate to at least 0.01 lb (5 gm) within the range of ± 10 percent of the specimen mass.	Used Scale Capacity 1,000 lb (454 kg) with 0.1 lb (0.05 kg) accuracy
<i>Freezing and Thawing Cycle</i>	The freezing and thawing cycle temperature shall be controlled by measurements of temperature from the control specimen.	None
	Changing the location of control specimen frequently to account for extremes of temperature variation	The control tie was kept in a fixed location because of limitations on wire access to the data logger.
<i>Freezing and Thawing Cycle</i>	The nominal freezing and thawing cycle for both method A and B	The cycles alternate from 40 °F (4 °C) to 12 °F (-11°C). The freeze

Sampling	requires lowering the temperature of the specimens from 40 to 0 °F (4 to -18 °C) and raising it from 0 to 40 °F (-18 to 4 °C) between 2 to 5 hours. The tolerance of the temperatures at the centers of the specimens shall be 0 ± 3 °F (-18 ± 2 °C) for the cooling period and 40 ± 3 °F (4 ± 2 °C) for the heating period.	cycle time is 11 hours. The thaw time is 2.8 hours. While the higher freezing temperature used in whole tie testing may be slightly less severe than ASTM, it is still below the freezing point of water in the tie and low enough for damage to be evident in poor quality concrete.
	The variation of temperature from the center of a specimen to its surface shall not exceed 50 °F (28 °C).	None
	The transition time between the freezing and thawing periods cannot exceed 10 min, except when specimens are being tested.	None
	Saw-cut samples from hardened concrete must be acquired according to ASTM C823.	The whole tie was tested.
Test Specimens	The specimens used must be prisms or cylinders made and cured according to ASTM C192/C192M and ASTM C490.	The whole tie has a nonuniform prismatic shape.
Test Specimens	Specimen width, depth, or diameter must be within 3 in (75 mm) and 5 in (125 mm), and specimen length must be within 11 in (275 mm) and 16 in (405 mm).	Ties tested in this program were 8.5 ft (2.6 m) long, with a trapezoidal cross section (9 in (230 mm) top, 11 in (280 mm) bottom, and 9.5 in (240 mm) height at its largest cross section).
	Control the temperature of the specimen immediately after the specified curing period. The temperature should be -2 °F and +4 °F (-1 °C and +2 °C) of the thaw temperature. Take readings of the fundamental transverse frequency, mass, average length, and cross section dimensions of the concrete specimen within the tolerance required in ASTM C215. Moisture loss should be prevented between the end of curing period and the initiation of freezing and thawing cycles.	Not applicable since ties were collected from the field.
	Test for fundamental transverse frequency, mass, and length (optional) change at least every 36 cycles.	None
	Keep the specimens moist when they are out of the freeze-thaw machine.	None

	<p>When returning the specimens, return them either to random positions or to predetermined positions according to a rotation arrangement that would ensure each specimen is subjected to all the different conditions in the freezing machine.</p>	
	<p>Freeze-thaw cycling continues for 300 cycles or until the concrete relative dynamic modulus of elasticity reaches 60 percent of the initial modulus, whichever happens first. An additional optional length change test can be used to end the test when the expansion reaches 0.10 percent of the original length.</p>	None
	<p>If a specimen is removed due to failure, a replacement “dummy specimen” must be added for the remainder of the test.</p>	None

Figure 1 represents the entire testing process following the modified ASTM C666 for whole concrete ties described in Table 2.

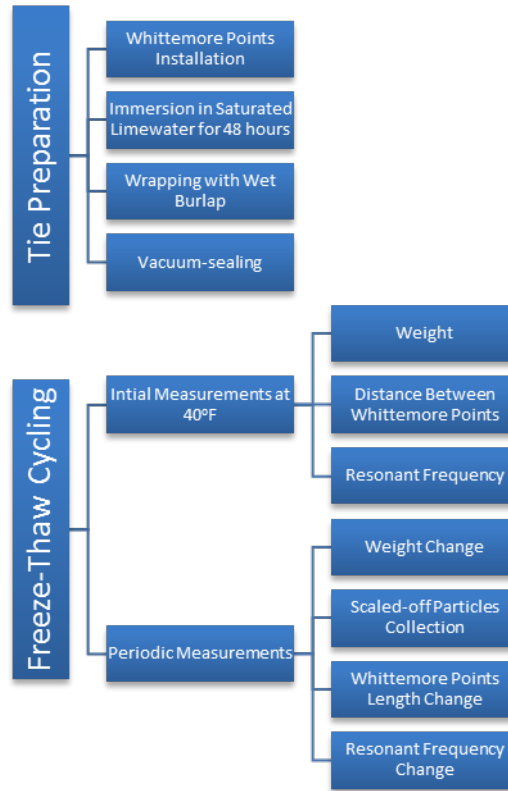

Figure 1: Summary of whole tie freezing and thawing test procedures.

2.1 Tie Preparation

In order to measure length change of the concrete ties, ten Whittemore mechanical strain gauge points were installed in four locations on two sides of the tie using Devcon Precision Brushable Ceramic Epoxy, as shown in Figure 2. A Whittemore mechanical strain gauge used these points as a reference to measure any length change in the concrete. In order to install these points at exact locations on different ties with eight in-between points on each side, as shown in Figure 2, triangular templates were used to control point location during attachment. The locations selected are shown in Figure 2. Although the length-change measurements are not on the whole tie, the strain measurements should match those seen in the overall tie. Any local differences in strain at other locations, such as geometrical transitions, would likely result in surface damage or pop outs and would be picked up in the visual observations.

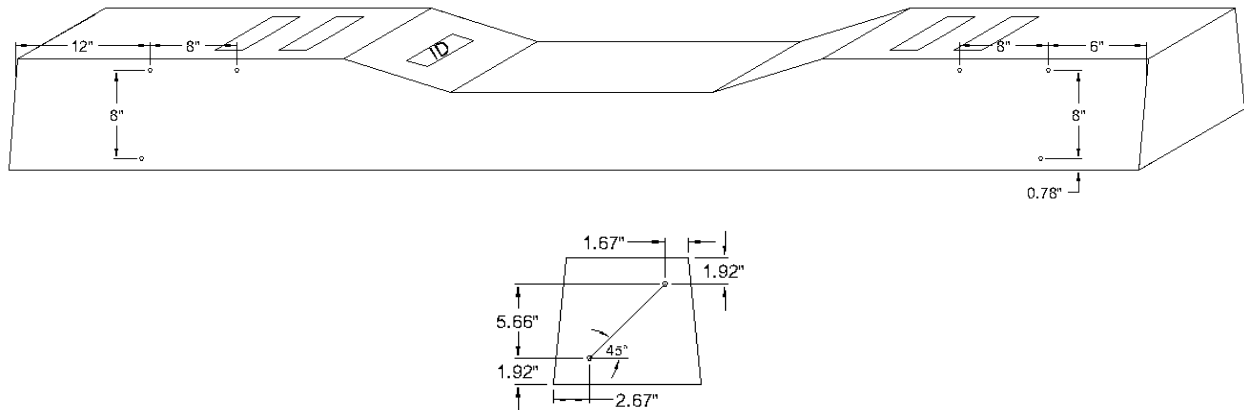

Figure 2: Railroad tie with Whittemore points on front (both ends have the same configuration).

To begin the freeze-thaw testing, concrete railroad ties were soaked in saturated limewater. The railroad ties were immersed at 73.4 ± 3 °F (23 ± 1.7 °C) for 48 hours. The ties were immersed in two large water tanks, with up to four ties stacked two deep per tank, as shown in Figure 3.



Figure 3: Railroad tie immersed in lime water in two Behlen galvanized round end tanks.

After the soaking period, the ties were removed from the lime water tanks and wrapped with wet burlap sheets. The wet burlap was placed around the tie to ensure that free water was present all around the tie for the duration of the test, instead of simply collecting underneath the tie. The wrapped ties were covered with plastic tubing with one end of the tubing sealed. A wet and dry vacuum was used to remove air from the tubing through the open end, as shown in Figure 4. After removing the air, the open end of the tube was sealed and the tie was wrapped with packing tape to ensure that the plastic tubing was held tightly around the tie. Wrapping the burlap and plastic close to the tie surface was intended to limit the insulating effects of the burlap and tubing.



Figure 4: Railroad tie vacuum sealed and wrapped with packing tape.

2.2 Freeze-Thaw Cycling

After the ties were prepared, eight of them were placed in the freeze-thaw chamber for 300 cycles of freezing and thawing. These eight ties included seven from Illinois and one dummy tie used to monitor and control the chamber temperature. Researchers were concerned that drilling into test specimens to insert thermocouples could cause micro-cracking of the ties or allow additional water into the ties. The use of a “dummy tie” allowed the concrete temperature to be measured without having to drill into test specimens to control the temperature. The dummy tie temperature was measured using thermocouples installed 1.5 in (38 mm) deep in the tie center; the thermocouples were installed by drilling a narrow hole into the tie, inserting them, and then filling the hole with epoxy. A thermocouple was also placed in the center of the tie using the same procedure. A schematic of the chamber built to house the ties during freeze-thaw testing is shown in Figure 5.

Figure 6 shows the ties in the assembled chamber. Locations of the ties in the chamber were rotated each time measurements were taken to prevent bias from tie location.

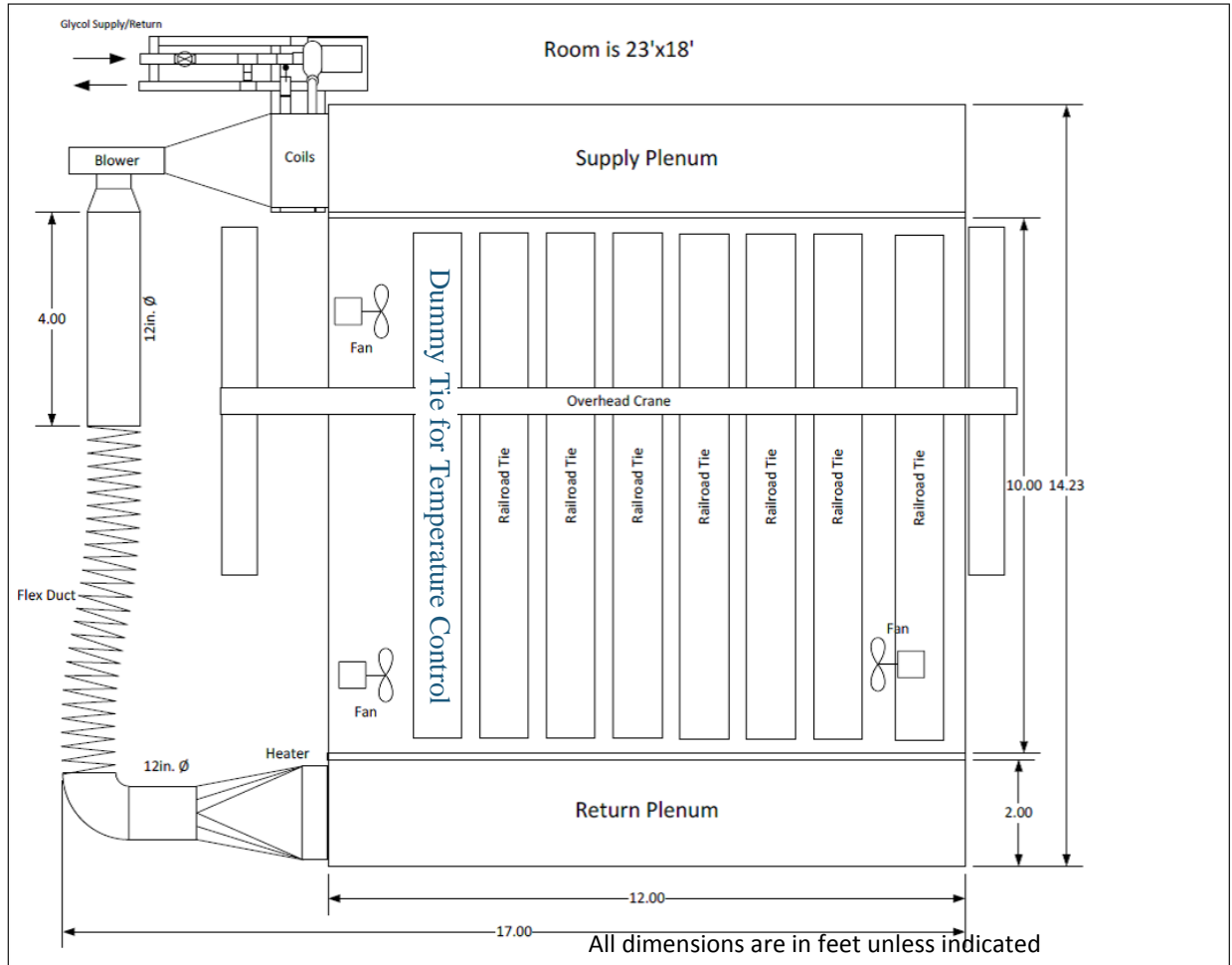

Figure 5: Chamber layout.



Figure 6: Railroad ties in the testing chamber.

A 2,000-gallon glycol tank attached to a chiller was used to freeze the chamber. The chamber temperature during cooling would reach 3 °F (-16 °C). The chamber was designed to hold eight ties and to perform freezing and thawing cycles from 12 °F (-11 °C) to 40 °F (4 °C) and maintain these temperatures at 1.5 in (38 mm) from the top surface of the ties. A depth of 1.5 in (38 mm) was selected to match the depth below the concrete surface used to monitor the concrete temperature, as specified in ASTM C666. A heater was placed in the supply plenum to increase the thawing rate during the thawing cycle. Fans were placed in the chamber to ensure uniform air temperatures and accelerate the cycling through increased convection at the tie surface. Figure 7 shows typical temperatures measured by the thermocouple inserted 1.5 in (38 mm) from the concrete dummy tie surface during freeze-thaw cycles.

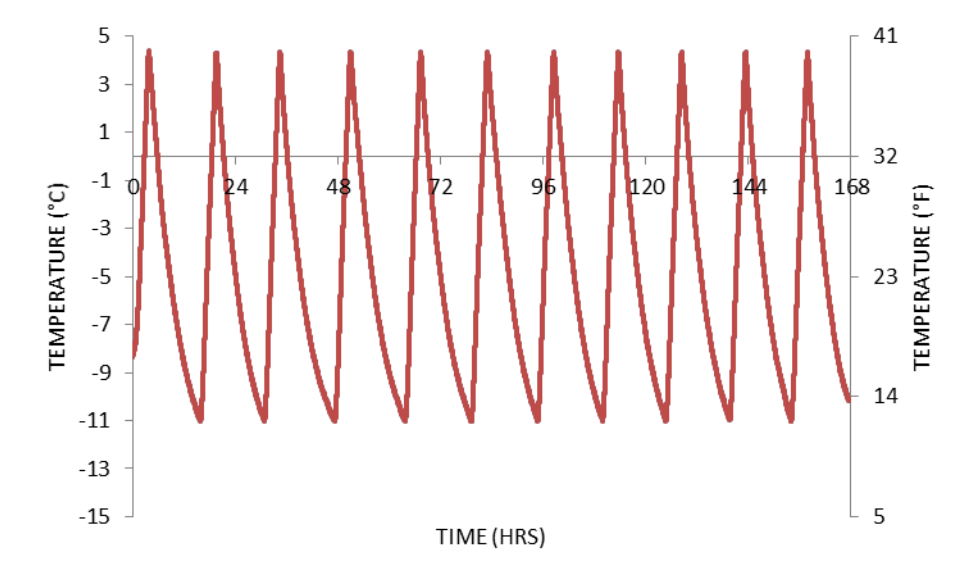

Figure 7: Typical freeze-thaw cycle temperatures measured 1.5 in (38 mm) from the concrete dummy tie surface.

2.2.1 Measurements

After placing the ties in the chamber, initial readings of the tie weight, distance between Whittemore points, and resonant frequency were taken after the ties reached 40 °F (4 °C) and before commencing the freeze-thaw cycles. Once the cycling commenced, length change, weight, and resonant frequency measurements were taken every 20 to 36 cycles. ASTM C666 specifies that measurements should be taken at least every 36 cycles, but more frequent measurements are permitted to accommodate standard Monday through Friday work schedules. To perform the testing, tubes were unsealed, as shown in Figure 8, and burlap was collected in separate bags to gather concrete particles stuck to the fabric in order to measure mass loss. After measurements were completed, the ties were wrapped in wet burlap and sealed in plastic for additional freeze-thaw cycling.



Figure 8: Railroad ties unwrapping.

The ties were weighed using a 1,000-pound (454 kg) crane scale with a resolution of 0.1 lb (0.05 kg). The crane scale was attached to a 2-ton gantry crane with a 14.5-foot (4.4 m) span. During the testing period, the ties were kept wet using a sponge. The concrete expansion was measured using a Whittemore mechanical strain gauge at four locations on the tie, as shown in Figure 9.



Figure 9: Whittemore point length measurements.

Concrete resonant frequency is measured to detect concrete deterioration from freezing and thawing cycles. Cracking and other forms of damage will slow down waves that travel through the concrete. These internal damages will not show up in visual observations but can be indicated by a decrease in the concrete resonant frequency. In this test program, the resonant frequency change in ties was measured using the impact resonance method shown in Figure 10. With this method, the concrete at one location is impacted with a light hammer. The waves transmitted through the concrete from the impact are detected using an accelerometer at another location. The resonant frequency of the concrete is then calculated from the measured waves. This was repeated for the points shown in Figures 11 and 12. Values equivalent to the relative

dynamic modulus of elasticity (RDME) were calculated at each resonant frequency location using Equation 1 [7]:

$$P_c = \left(\frac{n_c^2}{n^2} \right) \times 100 \quad \text{Equation 1}$$

Where P_c is the RDME after c cycles of freezing and thawing (%), n is the resonant frequency at 0 cycles of freezing and thawing, and n_c is the resonant frequency after c cycles of freezing and thawing.



Figure 10: Resonant frequency measurements.

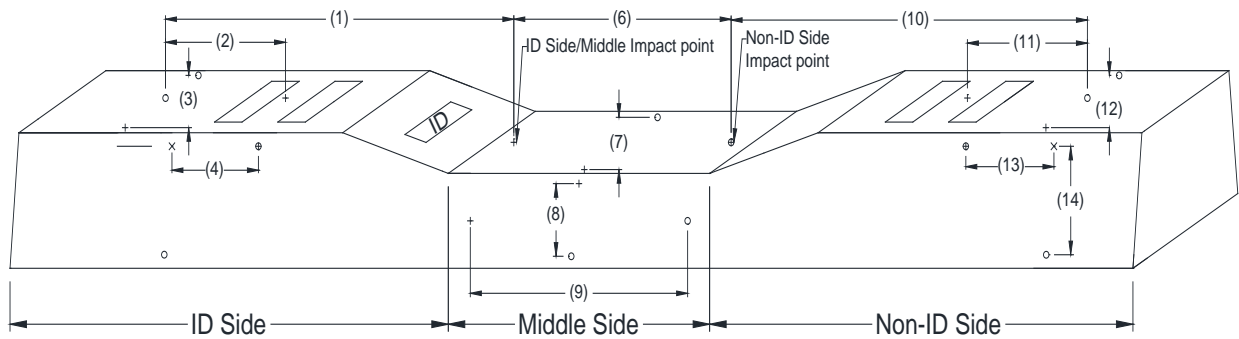

- + Impact Point
- o Accelerometer Point
- ⊕ Horizontal Impact / Accelerometer Point
- × Vertical Impact / Accelerometer Point

- | | |
|------------------------|-----------------------------|
| (1) ID Top/Long 2 | (8) Middle Side/Vertical |
| (2) ID Top/Long 1 | (9) Middle Side/Horizontal |
| (3) ID Top/Short | (10) Non-ID Top/Long 2 |
| (4) ID Side/Horizontal | (11) Non-ID Top/Long 1 |
| (5) ID Side/Vertical | (12) Non-ID Top/Short |
| (6) Middle Top/Long | (13) Non-ID Side/Horizontal |
| (7) Middle Top/Short | (14) Non-ID Side/Vertical |

Figure 11: Names of resonant frequency reading locations.

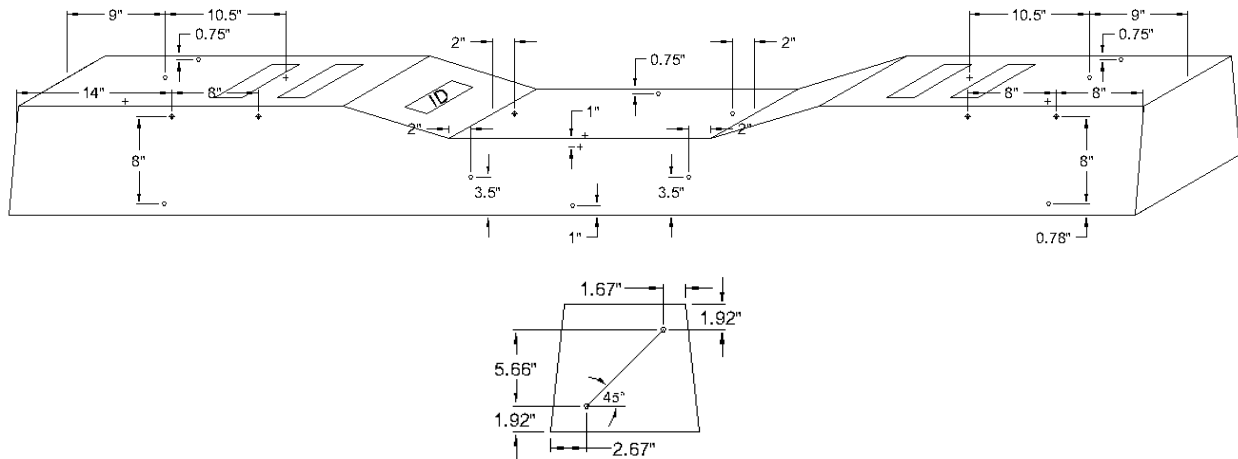

Figure 12: Geometrical locations for resonant frequency readings.

Whole tie resonant frequencies were induced with a hammer and recorded using an accelerometer in two locations on each tie, as shown in Figure 13. Time series data for each pulse were extracted from the accelerometer and converted to corresponding frequency domains using a Fast Fourier Transform (FFT) algorithm. Resonant frequencies were then obtained from the frequency domain. After completing these measurements, the ties were wrapped and vacuum sealed in the chamber.

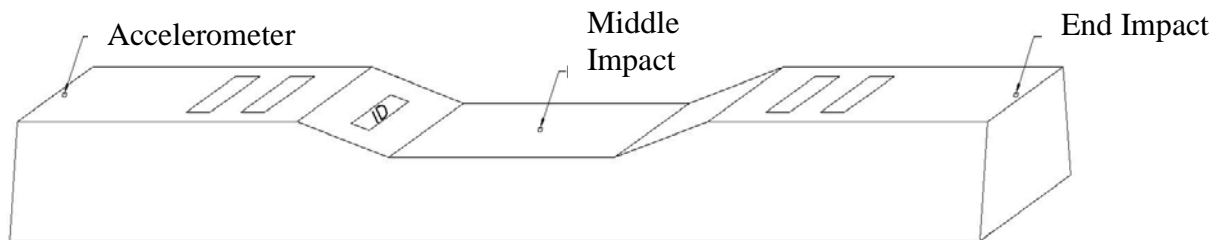

Figure 13: Impact and accelerometer locations on tie top surface.

3. Results and Analysis

Seven concrete ties were subjected to 300 cycles of freezing and thawing. Concrete tie expansion, weight change, and resonant frequency measurements were taken before, during, and after the freezing and thawing cycles. Table 3 summarizes the measurements after 300 cycles of freezing and thawing and typical failure criteria. The maximum length change at 300 cycles listed below is the greatest percent change in length measured on a given tie at 300 cycles. The RDME provided below is from the whole tie resonant frequency testing.

Table 3: Summary of experimental results at 300 cycles.

Tie #	Tie ID #	Maximum Length Change at 300 Cycles (%)	Particle Loss Weight (%)	RDME
Failure Criteria		0.1	-	60
1	2-042-C	0.041%	0.004%	100
5	2-05103-2	0.034%	0.009%	100
8	1-05009-3	0.016%	0.004%	109
11	1-053-C	0.016%	0.007%	97.5
12	2-05029-2	0.004%	0.005%	102
13	1-4397-F	-0.040%	0.008%	104.5
14	2-4386-B	-0.004%	0.019%	95.5

3.1 Concrete Expansion

Concrete that deteriorates during freezing and thawing cycles typically expands from the growth of internal micro-cracking. The concrete tie length change showed similar trends regardless of location. Figure 14 shows fluctuations of the percentage length change for all ties; however, the length change did not consistently increase beyond ± 0.05 percent throughout the testing period. This is significantly less than the commonly used failure criteria of 0.1 percent. Some brass points popped off the surface of the ties, possibly due to weakening of the epoxy-concrete bond caused by freezing and thawing cycles and different coefficients of thermal expansion for the epoxy and the concrete. Length change measurements from the other gauge locations are shown in Appendix A. The observed length changes remained below the 0.1 percent limit specified in ASTM C666 for the entire 300 cycles. This consistency indicates that the concrete ties did not experience significant amounts of internal cracking.

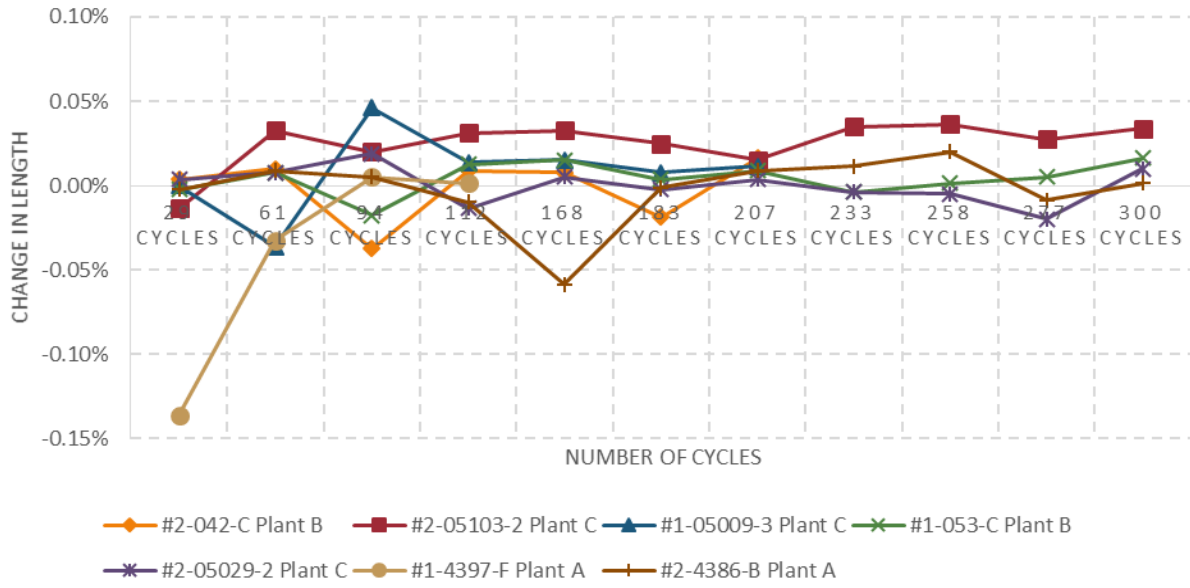

Figure 14: Length change in diagonal direction at the nonID side.

3.2 Weight Change

Concrete weight loss from scaling, pop-outs, or crumbling is a common result of freeze-thaw damage. There is no commonly accepted limit for weight loss since a lack of weight loss does not necessarily equal good performance. (The concrete can develop internal micro-cracking without losing any weight.). A large amount of weight loss, however, is an indicator of damage. Measurements of concrete weight throughout the testing period showed that concrete ties did not lose a significant amount of weight from freeze-thaw testing, as shown in Figure 15. Small fluctuations in weight values could be attributed to slight changes in water content on the surface of the specimens.

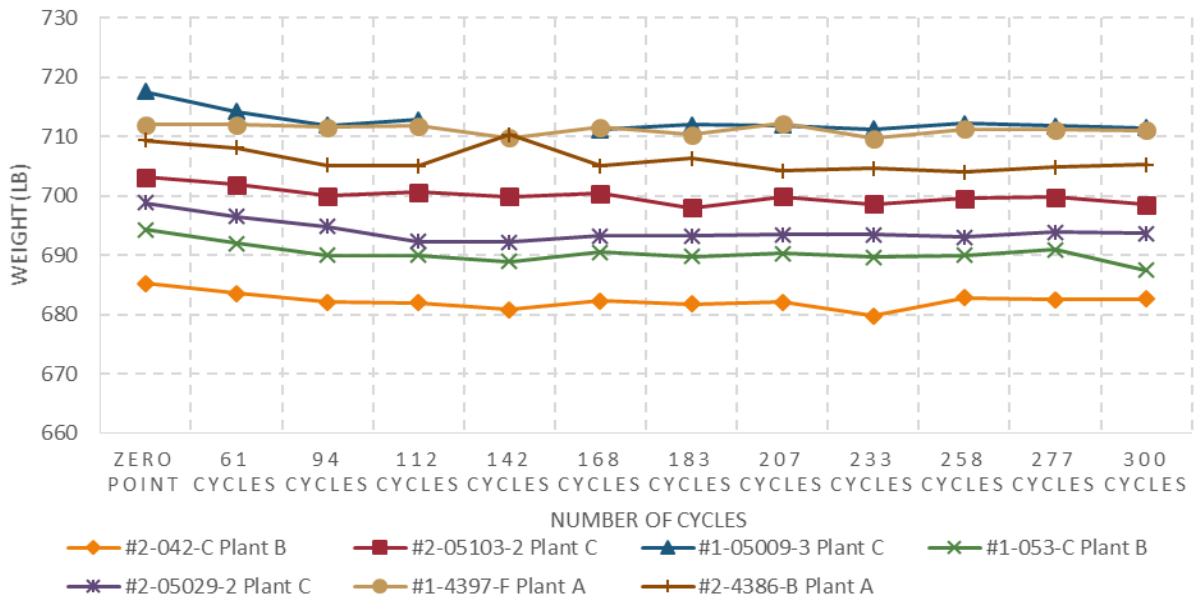

Figure 15: Concrete tie weight.

Measurements of the weights of scaled-off particles show a small amount of weight loss, although less than 0.1 percent. Most weight loss was caused by surface pop-outs or slight scaling. Figure 16 shows that the cumulative weight of scaled-off particles did not exceed 25 gm for most ties even after 300 cycles of freezing and thawing. Tie #2-4386-B experienced mass loss from a piece of concrete that came off one of its bottom corners (about 1.4 oz (40 gm)) after 168 cycles of freezing and thawing. Tie #1-4397-F developed some cracking between cycles 258 and 277 which developed into a section loss of 0.3 oz (9 gm). This small weight loss is considered minor. Surface problems would only be expected to cause problems if the entire region at the rail seat deteriorated, which was not seen in testing.

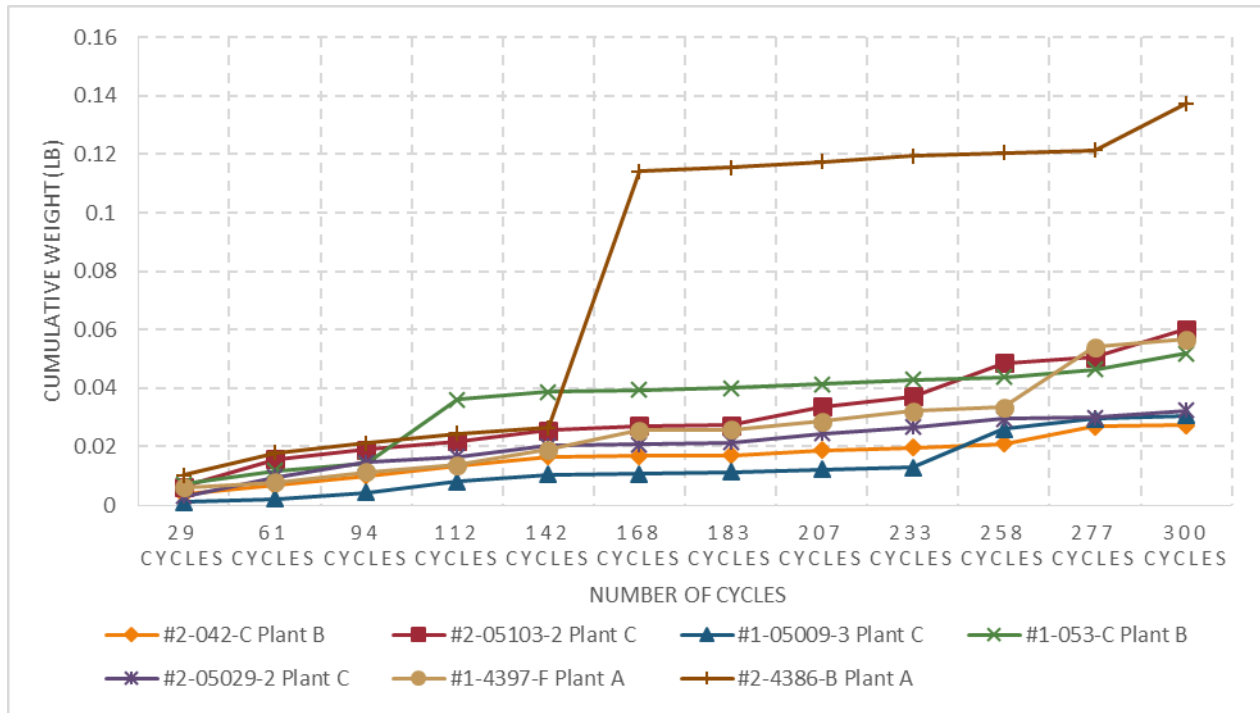

Figure 16: Concrete ties cumulative mass loss.

3.3 Resonant Frequency Results

Error! Reference source not found. shows the results for tie #1-05009-3 along the top longitudinal direction where the RDME stayed constant until cycle number 142. At cycle 207, the tie exhibited a large increase in the RDME followed by a large decrease in the RDME at cycle 277. This sudden increase or decrease in RDME values may be attributed to the fact that, unlike small specimens, whole ties are not supported along their entire length during testing. Rather, they are simply supported. As a result, changes in the locations of the simple supports may affect resonant frequency readings that are based on changes in wave energy dissipation. Since local RDME measurements did not provide consistent results, it is recommended that future tests take resonant frequency measurements over the length of the tie. Taking resonant frequency measurements over the length of the tie will ensure that the induced wave passes through the supports regardless of their locations. This guarantees more consistent results. If local resonant frequency measurements are desired, tie support jigs can be used to ensure consistent support locations.

The whole tie resonant frequency was measured at cycles 258, 277, and 300 to detect the presence of concrete deterioration and unseen internal micro-cracking in the ties. Resonant frequency measurements are based on the same physics as other nondestructive tests such as pulse velocity. The tests measure the wave speed in the concrete. They are both based on the principle that internal damage and micro-cracking in the concrete slow down waves transmitted through the concrete, decreasing the pulse velocity and resonant frequency. An increase in the resonant frequency is indicative of an increased concrete modulus from continued cement hydration and concrete strengthening during the testing period. Resonant frequency is commonly used on small prismatic concrete specimens, whereas pulse velocity is

commonly used on larger structural members with highly irregular geometries, not simply supported, nor connected to other structural members. The steel in the pre-stressed concrete tie should not change the ability of the resonant frequency test to detect internal damage because the pulse velocity through the steel does not change from freezing and thawing. Any differences seen in the resonant frequency would be from a change (likely from cracking) in the speed of the waves through the concrete.

The whole tie resonant frequency measurements gave consistent impact pulse measurements. Figure 17 shows time series data obtained from the accelerometer for one of the ties at the 258th cycle. The first impact pulse is the end pulse and the second one is for a pulse delivered in the middle of the tie. The frequency domain of the two pulses for the same tie is shown in Figure 18. The two pulses produced peaks at almost the same frequency. Figures 19 through 21 show the end pulse frequency domain at the 258th cycle for Plant A, Plant B, and Plant C ties plotted against the end pulse frequency for their corresponding control ties. Similar graphs for the 277th and 300th cycles are shown in the appendix. The range for the first resonant frequency of all ties was 105–120 Hz, indicating that the ties had similar internal states. Table 4 shows the first resonant frequency for the ties at the 258th, 277th, and 300th cycles. Since this test was not conducted at the 0 cycle, the control for this case was taken to be the companion ties not subjected to freeze- thaw damage. Differences seen in the whole tie resonant frequency testing were within expected experimental error. The nearly constant whole tie resonant frequency values indicate that the ties did not incur any internal structural damage during freezing and thawing cycles.

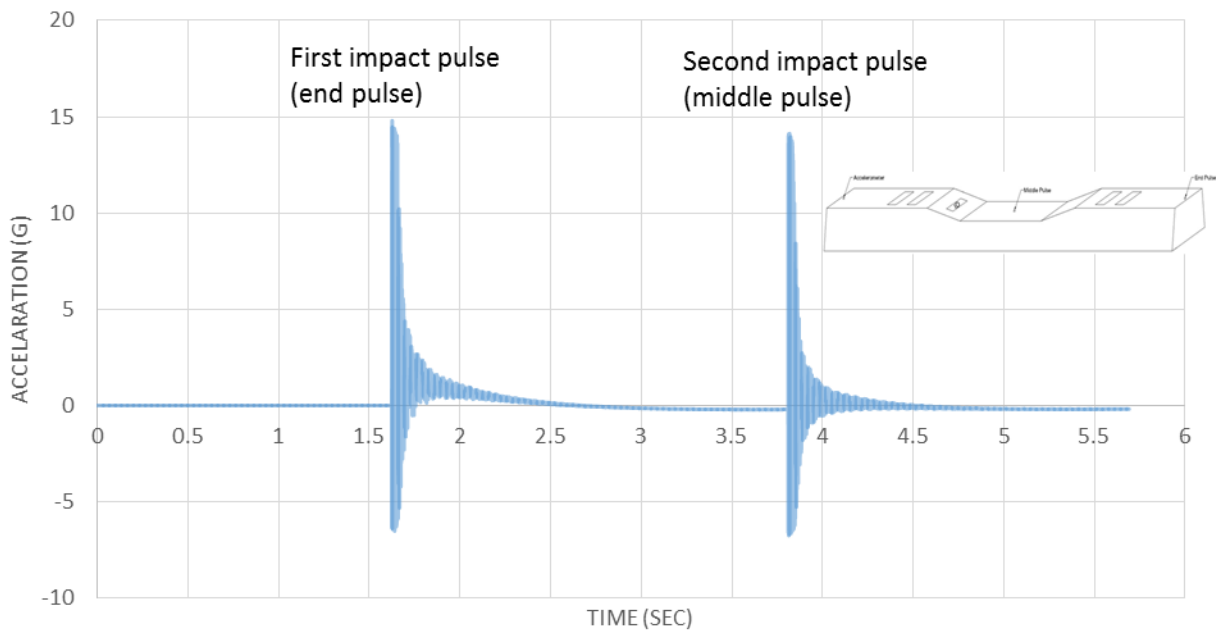

Figure 17: Pulse vibration for tie #2-05103-2 Plant C at the 258th cycle.

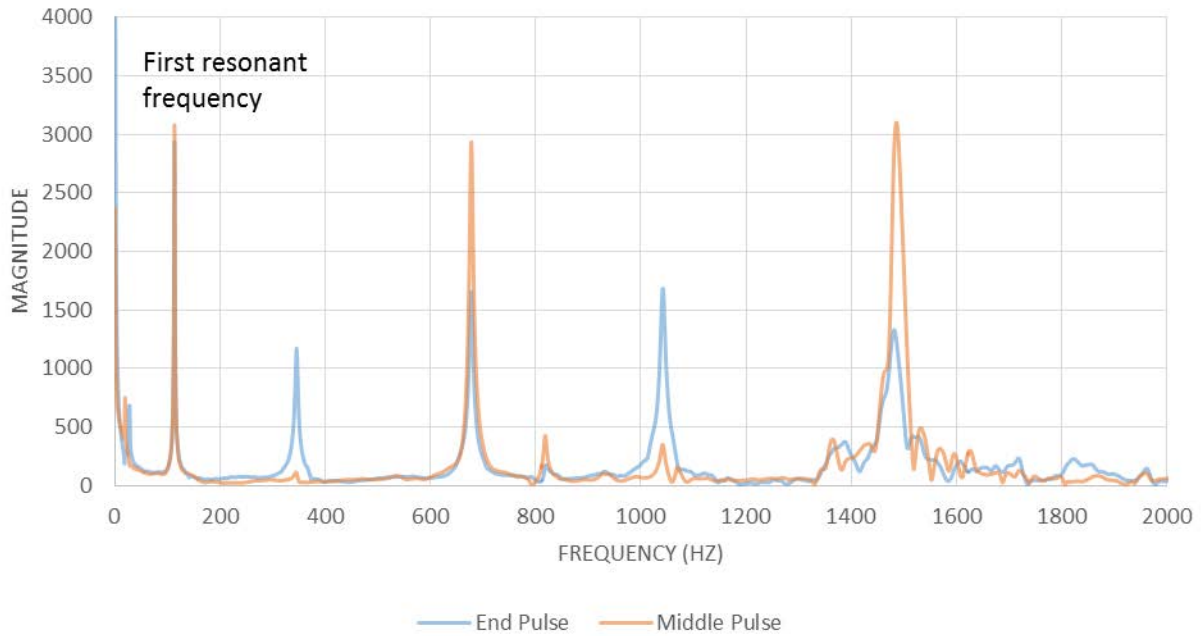

Figure 18: Frequency domain for tie #2-05103-2 Plant C at the 258th cycle.

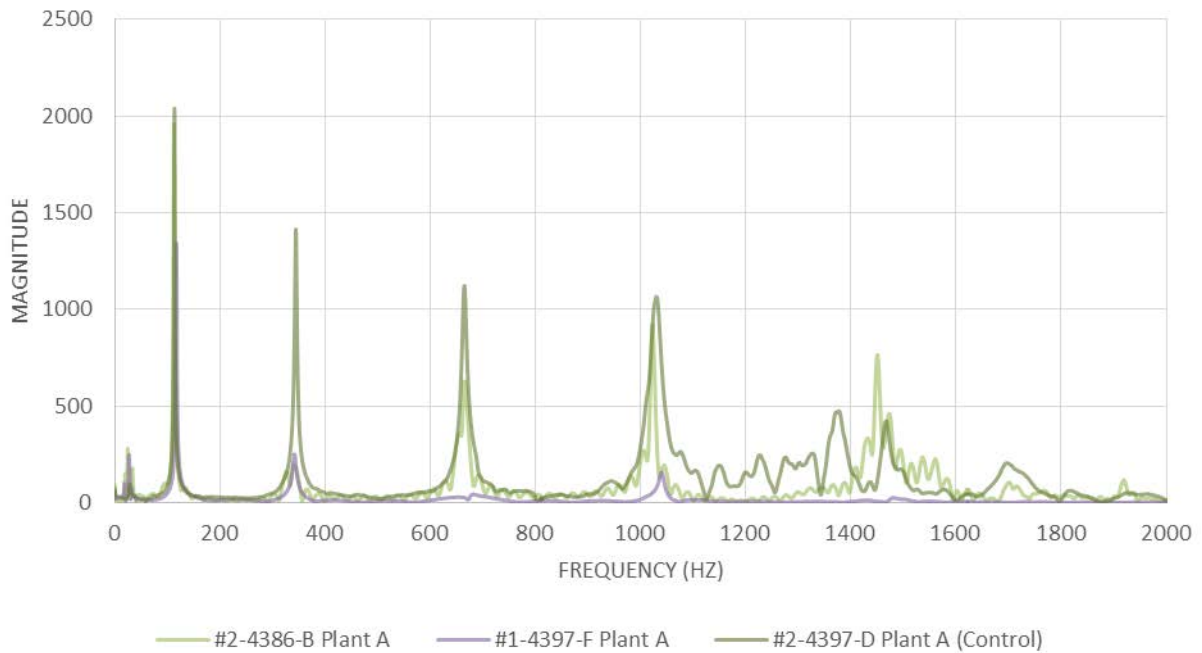

Figure 19: End impact frequency domain for Plant A ties at the 258th cycle.

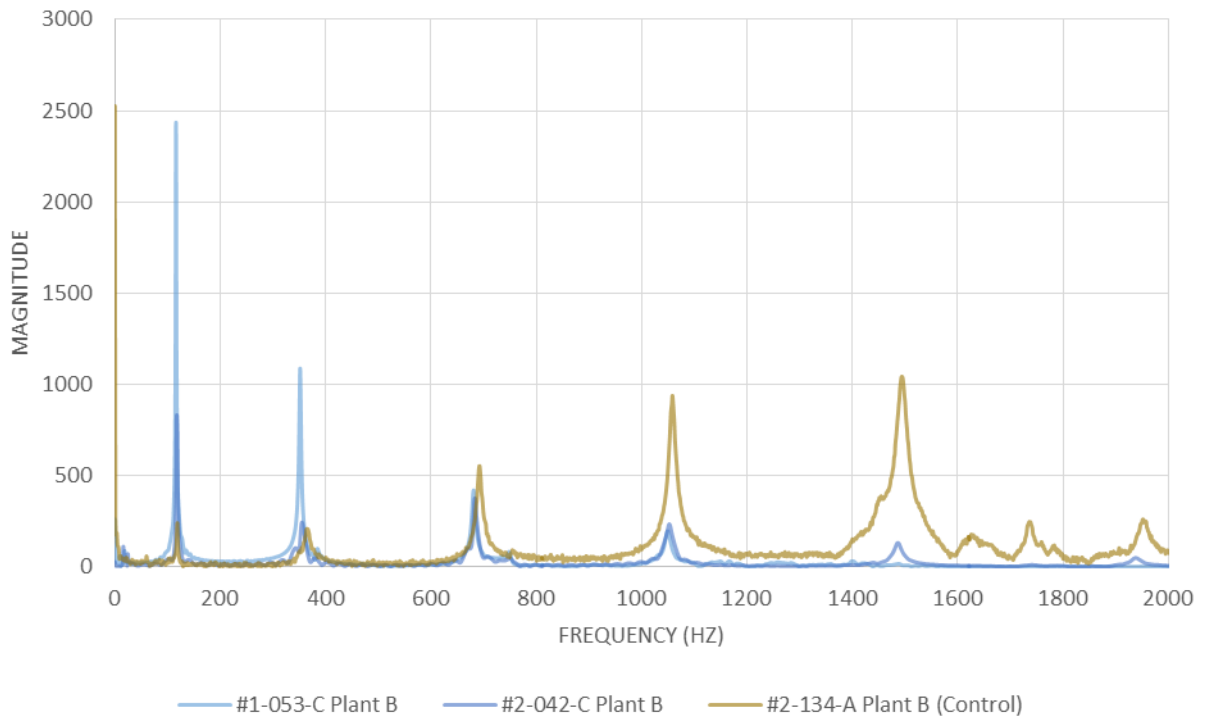

Figure 20: End impact frequency domain for Plant B ties at the 258th cycle.

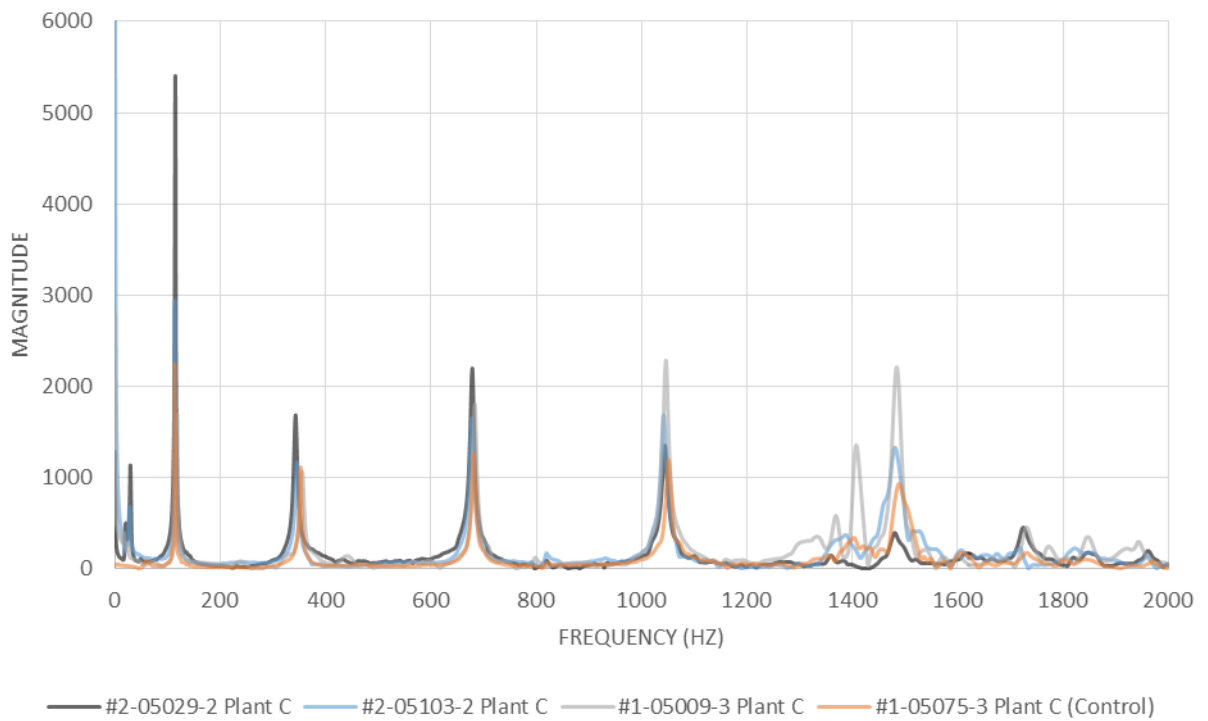

Figure 21: End impact frequency domain for Plant C ties at the 258th cycle.

Table 4: Resonant Frequencies for All Ties.

Type	Tie	First Resonant Frequency (Hz)		
		258 th Cycle	277 th Cycle	300 th Cycle
Freeze-Thaw	#1-053-C Plant B	116	117	117
	#2-05029-2 Plant C	114.5	112.5	114.5
	#2-4386-B Plant A	112.5	113.5	111
	#1-4397-F Plant A	117	117	116
	#2-042-C Plant B	117	118.5	118.5
	#2-05103-2 Plant C	113.5	113.5	113.5
	#1-05009-3 Plant C	118.5	118.5	118.5
Companion Control Ties	#1-05075-3 Plant C		113.5	
	#1-05035-4 Plant C		106	
	#2-4397-D Plant A		113.5	
	#1-F-4299 Plant A		113.5	
	#1-092-B Plant B		118.5	
	#1-109-C Plant B		118.5	
	#2-134-A Plant B		118.5	

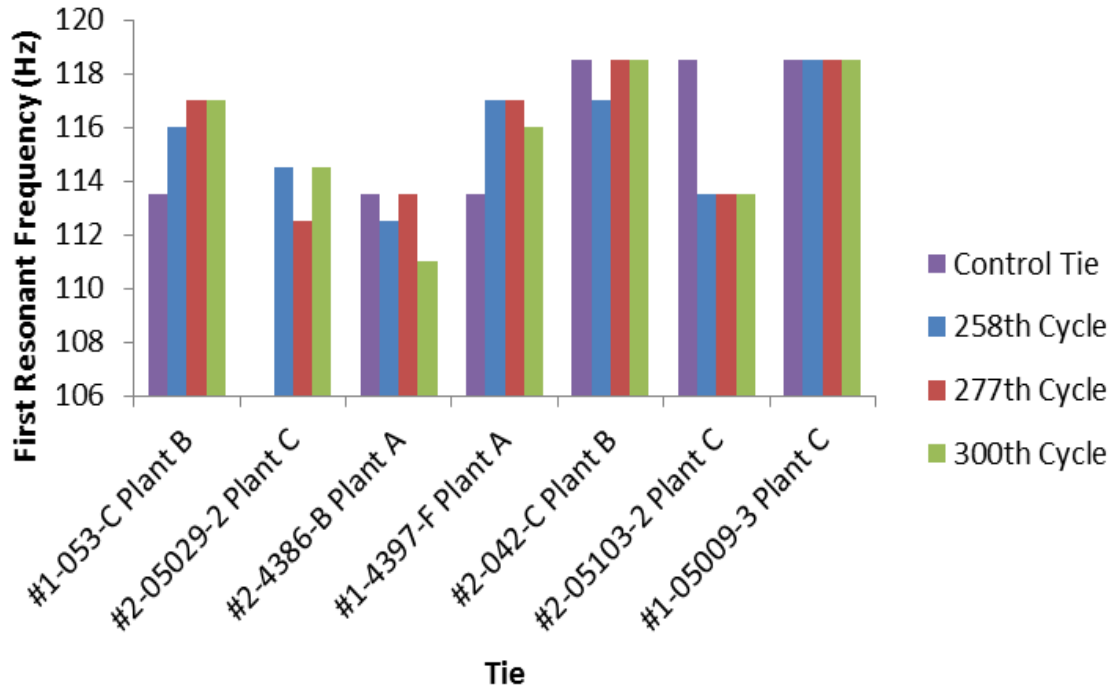

Figure 22: Overall resonant frequency for all ties tested at different cycles.

3.4 Visual Observations

The ties suffered some surface damage represented by pop-outs and small, shallow surface cracking, resulting, in some cases, in pop-outs. This shallow surface damage was typically not deeper than 0.25 in (6 mm) and did not affect the strength capacity of the ties. Tie #2-4386-B, which came from Plant A, suffered pop-outs and the loss of a piece of a corner weighing approximately 1.4 oz (40 gm), as shown in Figure 23 and Figure 24.



Figure 23: Tie #2-4386-B pop-outs and surface scaling.



Figure 24: Tie #2-4386-B corner piece after fracture.

Tie #1-4397-F experienced a shallow crack several inches in length between cycles 258 and 277. Figure 25 shows this crack that likely will eventually result in a pop-out. A smaller pop-out on top of the same tie is shown in Figure 26.



Figure 25: Tie #1-4397-F shallow cracking.

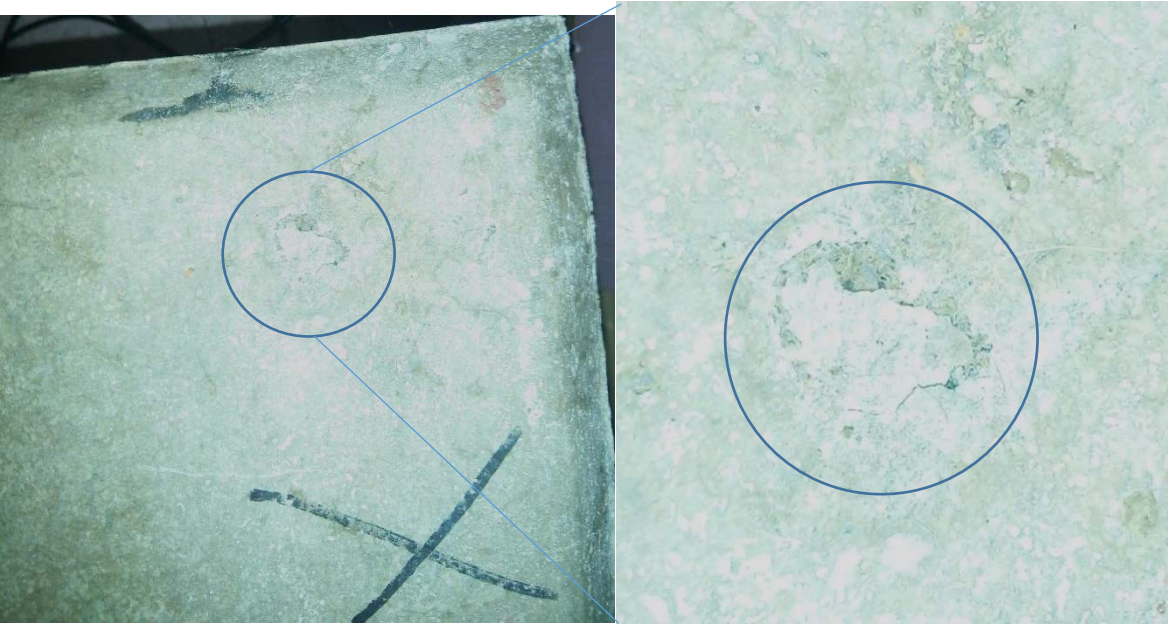

Figure 26: Small pop-out/crack in tie #1-4397-F.

4. Conclusion

Seven whole concrete railroad ties were subjected to 300 cycles of freezing and thawing in order to determine their performance against industry criteria specified by ASTM C666. Test procedures were modified slightly to account for the differences between small specimen and whole tie testing. The test results show that these concrete railroad ties did not experience significant deterioration as a result of the freeze-thaw testing.

The data presented in this report can be used in the future to compare with results from half-tie and small-specimen testing in order to assess the validity of ASTM C666 when it comes to judging the performance of whole ties in the field based on small-specimen testing. In the context of this K-State and UIUC project, the results of these whole tie freezing and thawing experiments will be used to guide further research into determining test procedures—that include the effects of concrete material properties and manufacturing process—required to ensure the freezing and thawing durability of concrete railroad ties. The results will also help guide work to determine how manufacturing process affects the concrete material properties required for durability and how well test conditions simulate actual field exposure.

5. References

- [1] J. C. Zeman, J. R. Edwards, D. A. Lange, and C. P. Barkan, "Investigating the Role of Moisture in Concrete Tie Rail Seat Deterioration," in *Proceedings of the 2009 AREMA Conference*, Chicago, IL, 2009.
- [2] H. Shang, Y. Song, and J. Ou, "Behavior of Air-Entrained Concrete After Freeze-Thaw Cycles," *Acta Mechanica Solida Sinica*, vol. 22, no. 3, June 2009.
- [3] C. R. Duggan, C. J. Dalton, and J. F. Scott, "Freeze-Thaw Tests on Concrete Ties," Montreal: CN Rail Research Centre, 1979.
- [4] M. Pigeon and R. Pleau, *Durability of Concrete in Cold Climates*, Taylor & Francis, 1995, p. 212.
- [5] American Concrete Institute, "ACI Concrete Terminology," 2013. [Online]. Available: <http://terminology.concrete.org>. [Accessed 9 April 2013].
- [6] Portland Cement Association, "Concrete Slab Surface Defects: Causes, Prevention, Repair," PCA, Skokie, IL, 2001.
- [7] ASTM C666, "Standard Test Method for Resistance of Concrete to Rapid Freezing and Thawing," ASTM International, West Conshohocken, PA, 2008.
- [8] Woodhouse, T., "Multi-State Coarse Aggregate Freeze-Thaw Comparison," Michigan Department of Transportation, Research Report R-1469, Lansing, MI, 2005.

Appendix. Additional Data and Figures

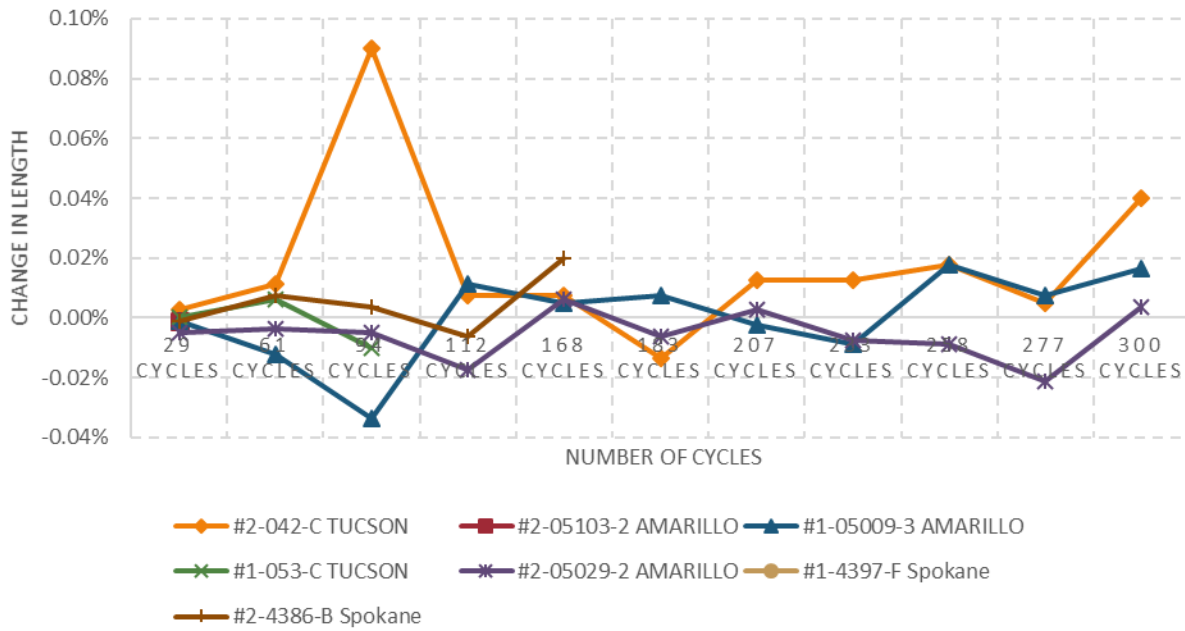

Figure A-1: Length change in diagonal direction at the ID side.

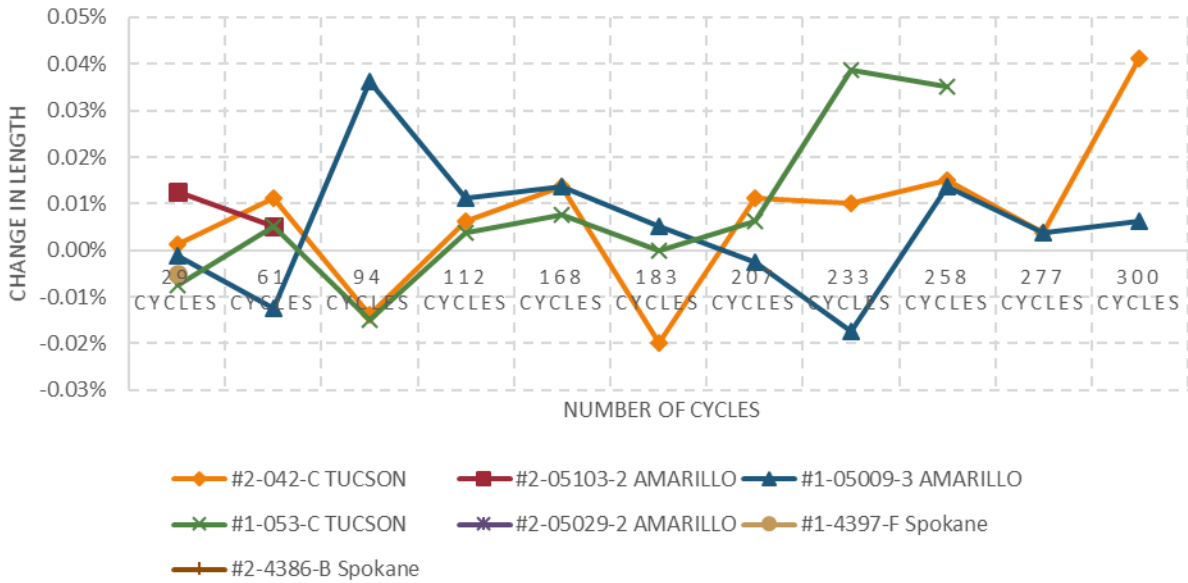

Figure A-2: Length change in vertical direction at the ID side.

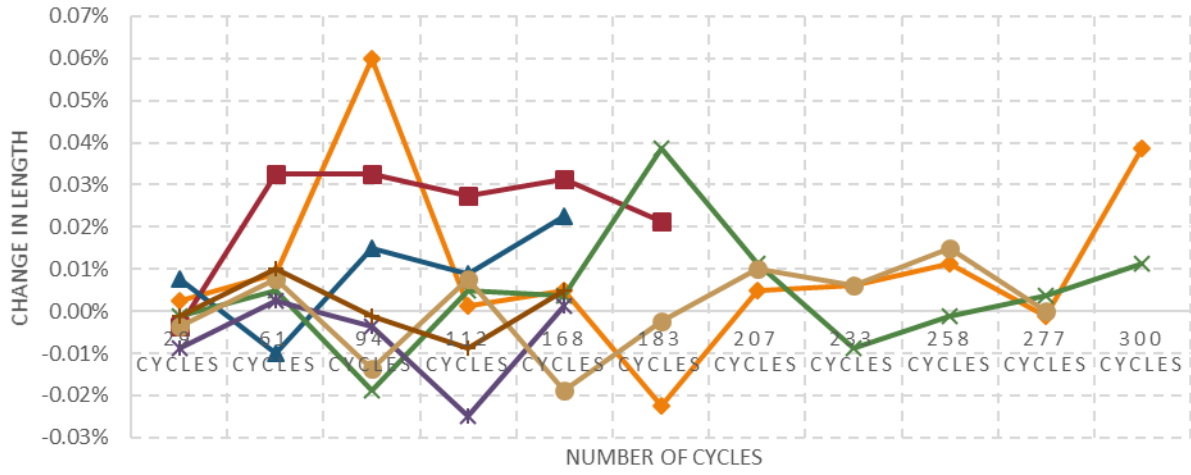

Figure A-3: Length change in horizontal direction at the ID side.

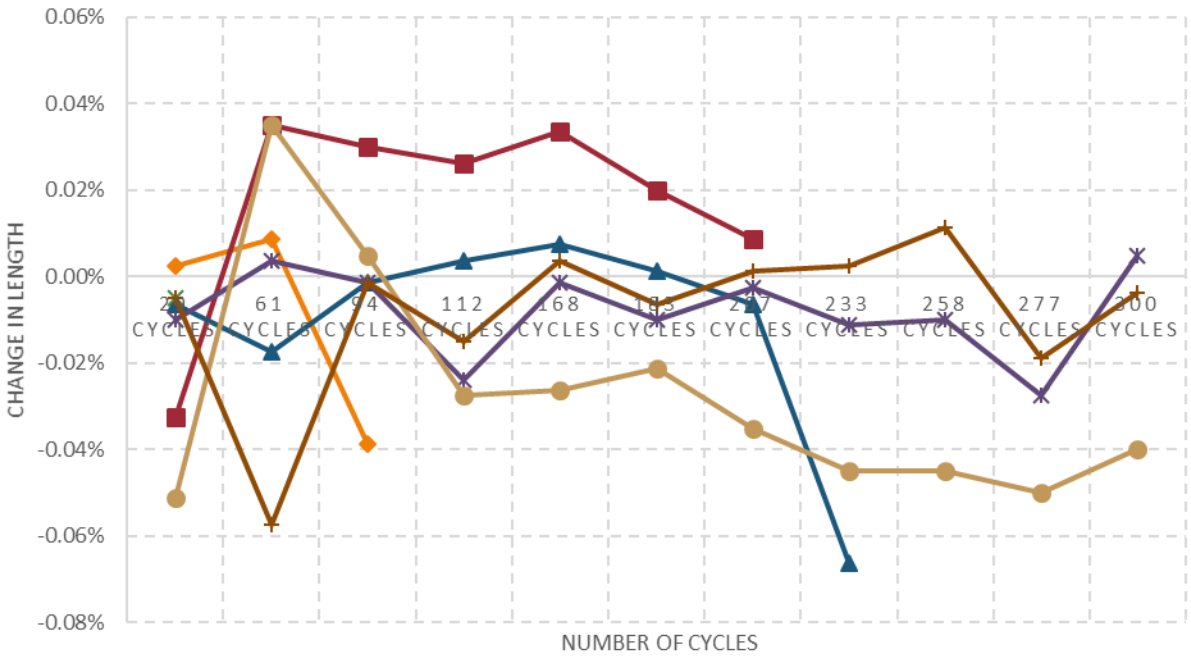

Figure A-4: Length change in horizontal direction at the opposite side to ID.

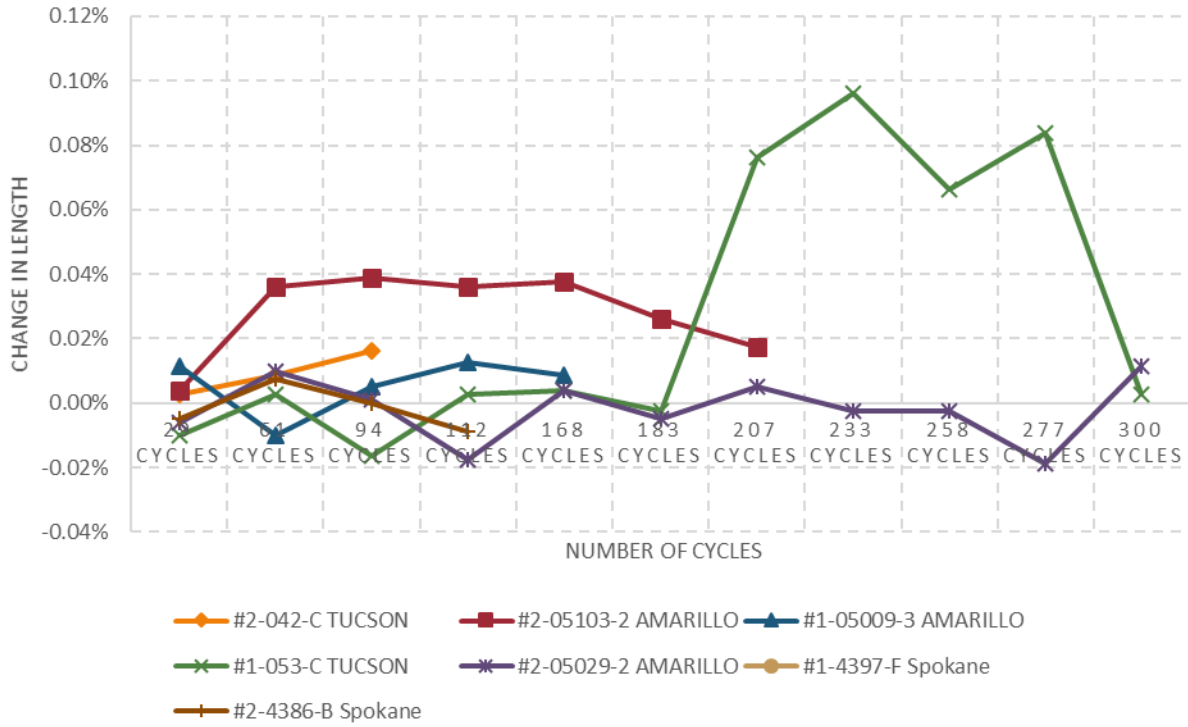

Figure A-5: Length change in vertical direction at the opposite side to ID.

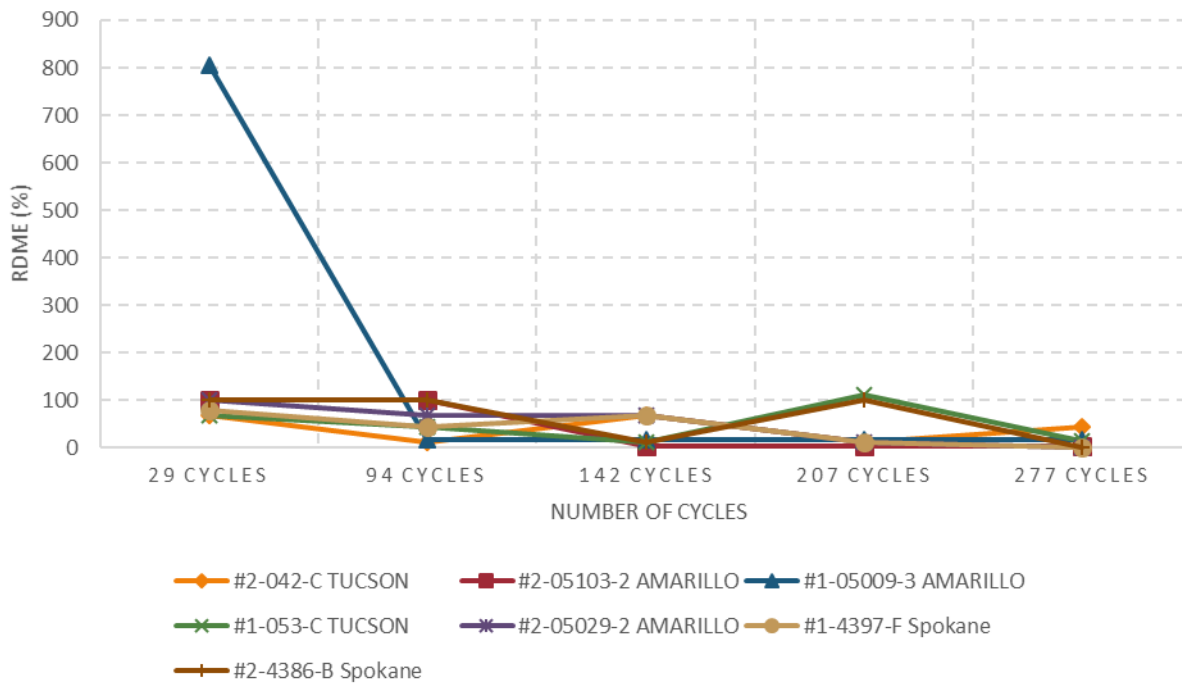

Figure A-6: RDME values at the ID side for the top transverse direction of the tie.

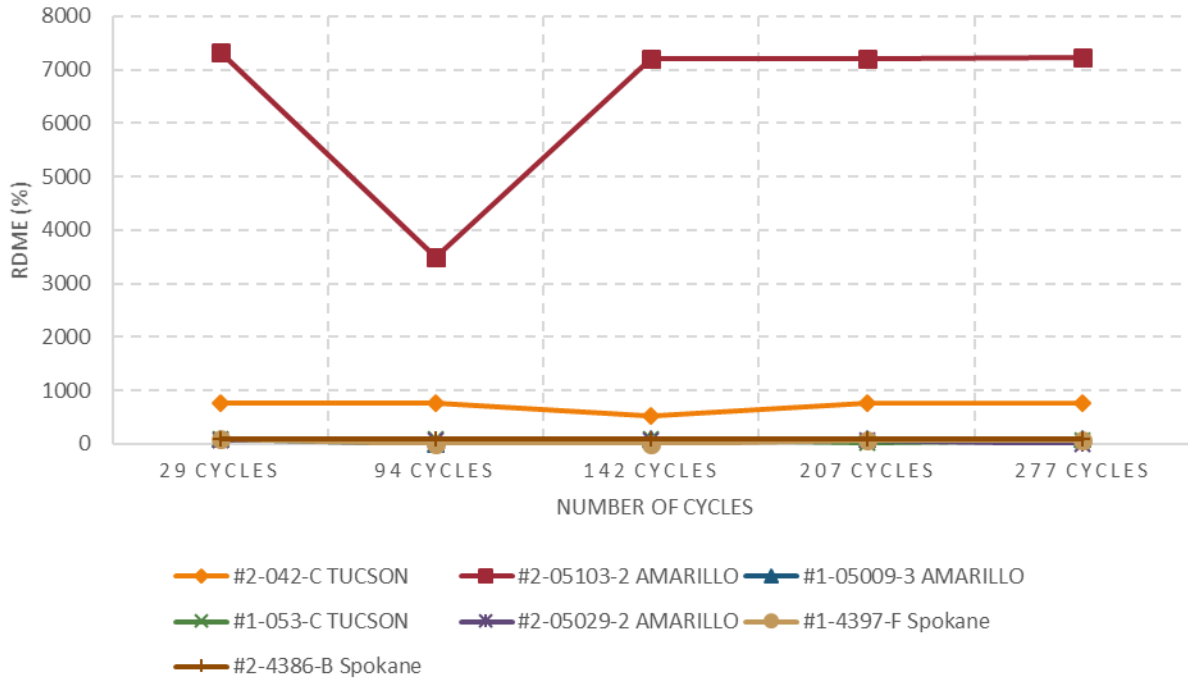

Figure A-7: RDME values at the ID side for the short top longitudinal direction of the tie.

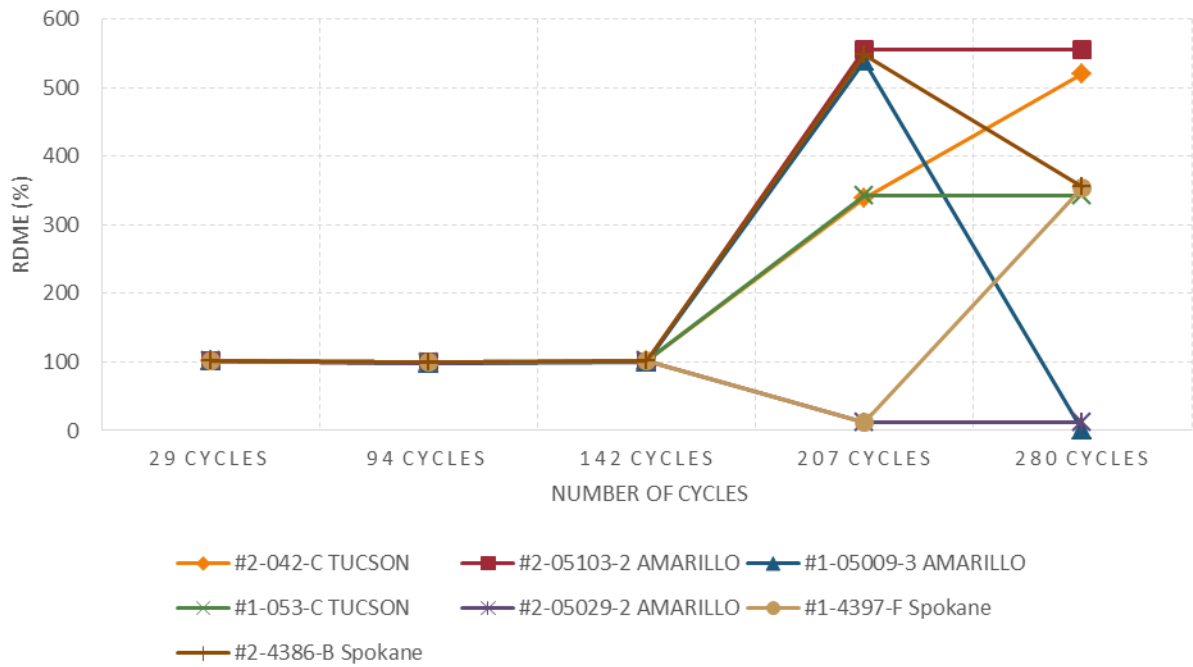

Figure A-8: RDME values at the ID side for the long top longitudinal direction of the tie.

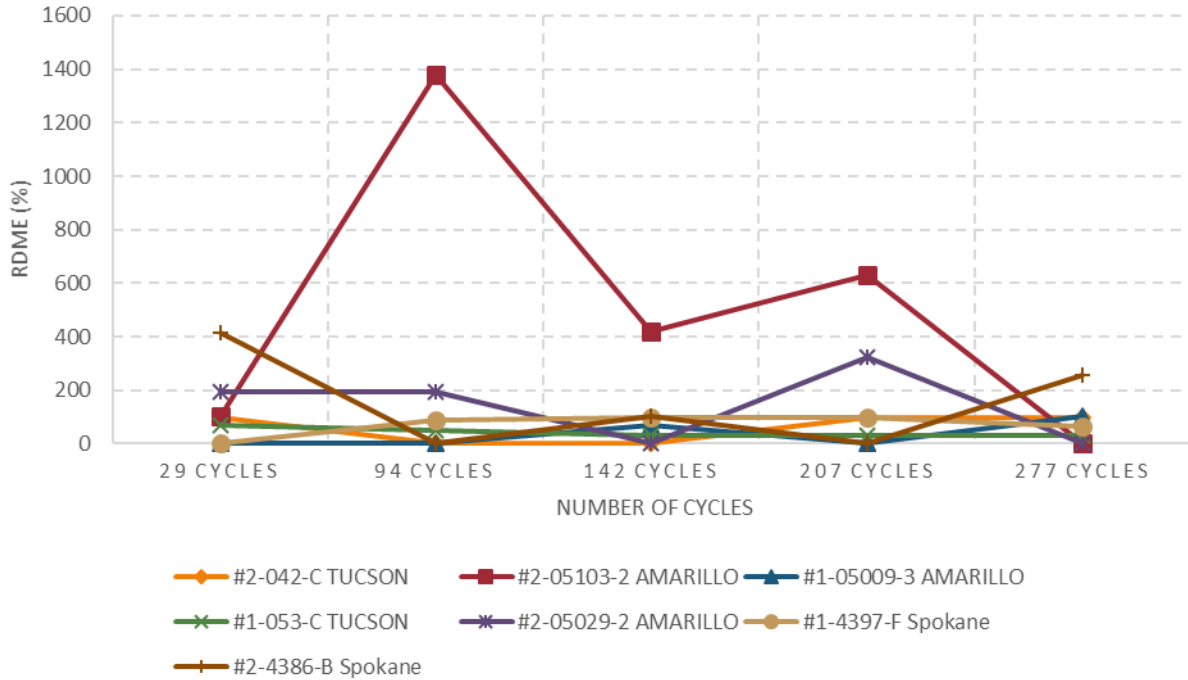

Figure A-9: RDME values at the ID side for the side transverse direction of the tie.

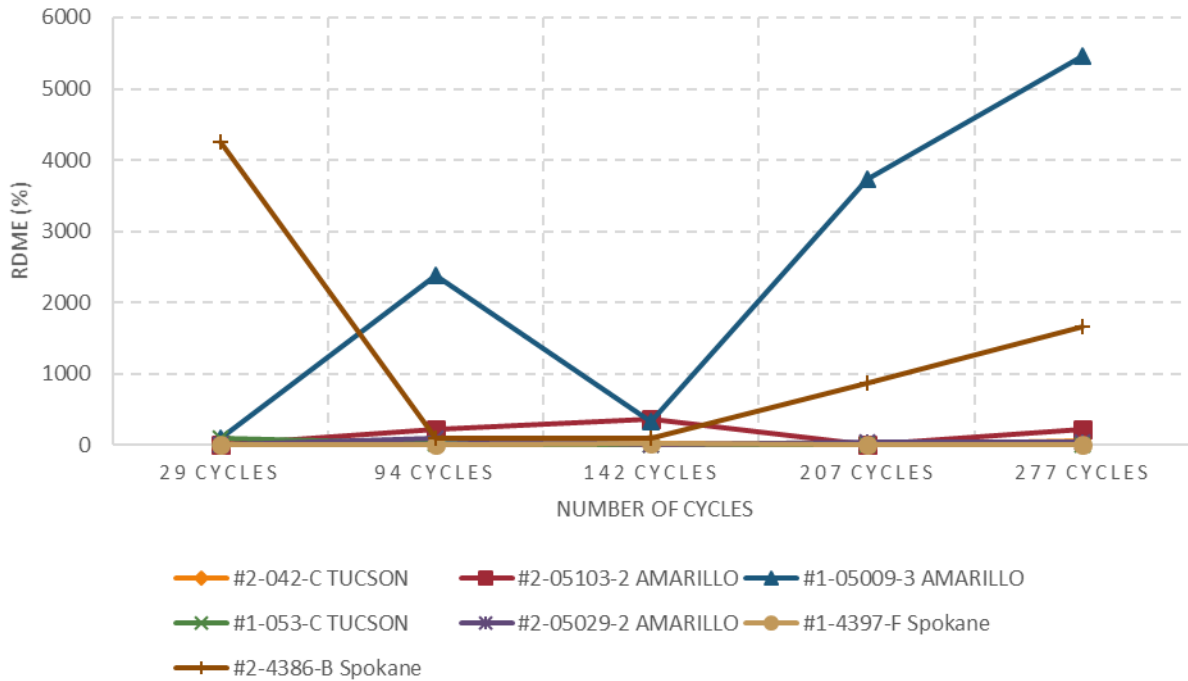

Figure A-10: RDME values at the ID side for the side longitudinal direction of the tie.

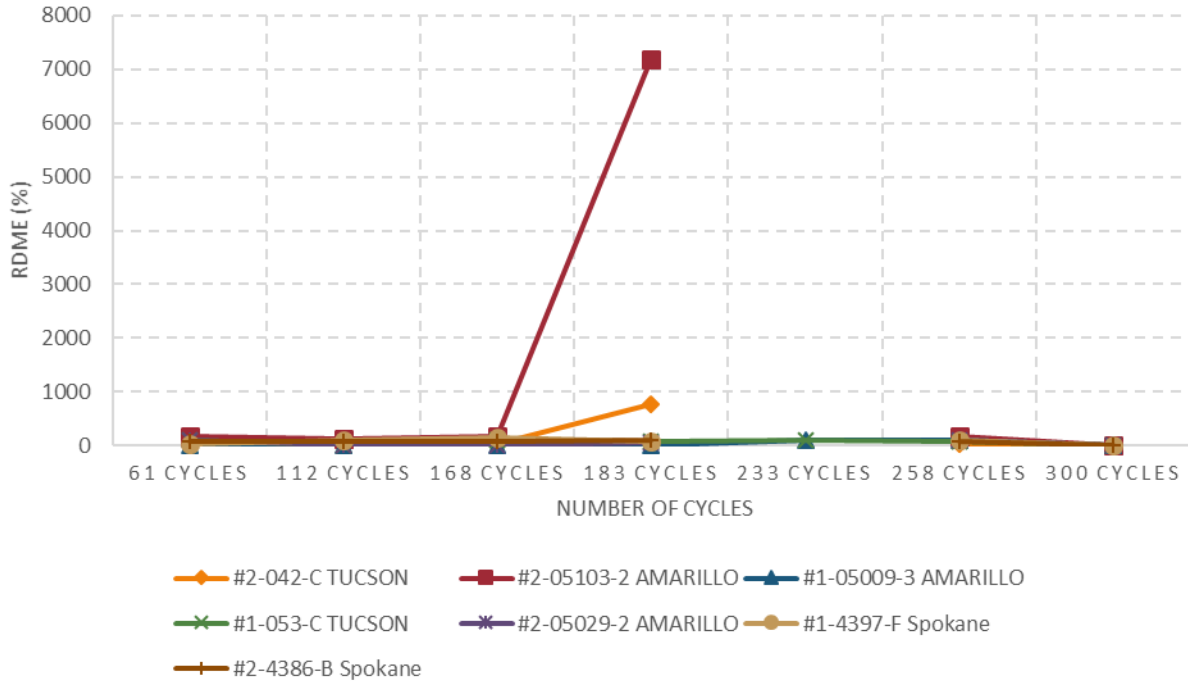

Figure A-11: RDME values at the other side for the short top longitudinal direction of the tie.

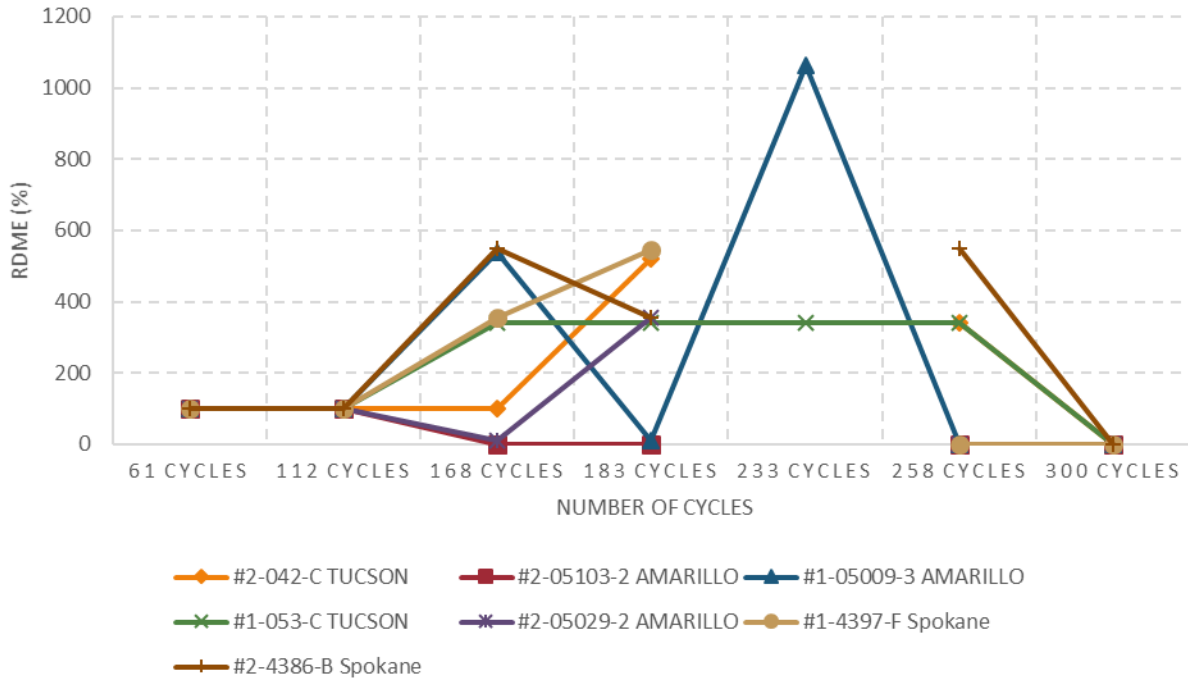

Figure A-12: RDME values at the other side for the long top longitudinal direction of the tie.

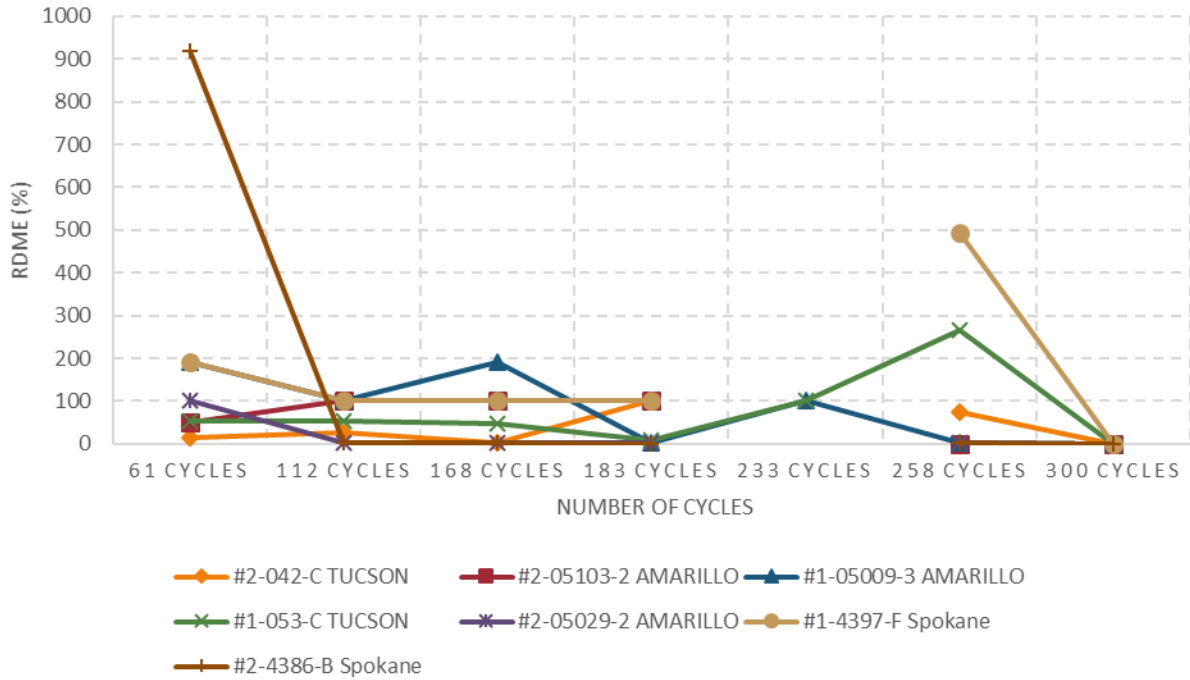

Figure A-13: RDME values at the other side for the side transverse direction of the tie.

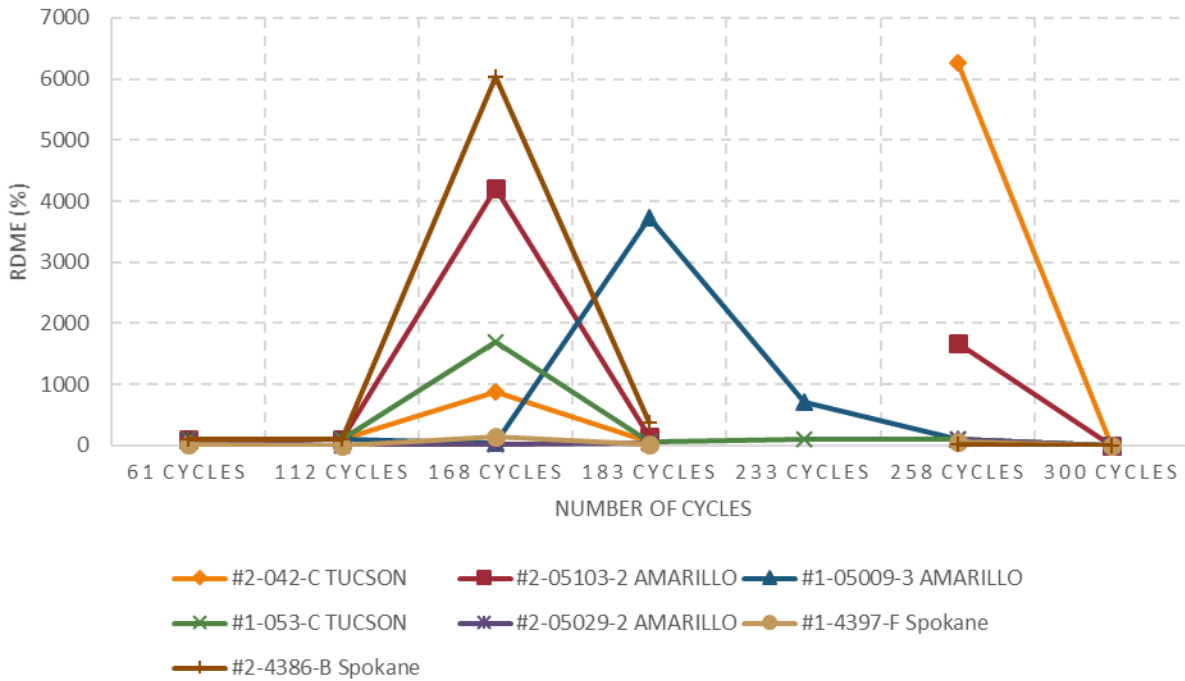

Figure A-14: RDME values at the other side for the transverse longitudinal direction of the tie.

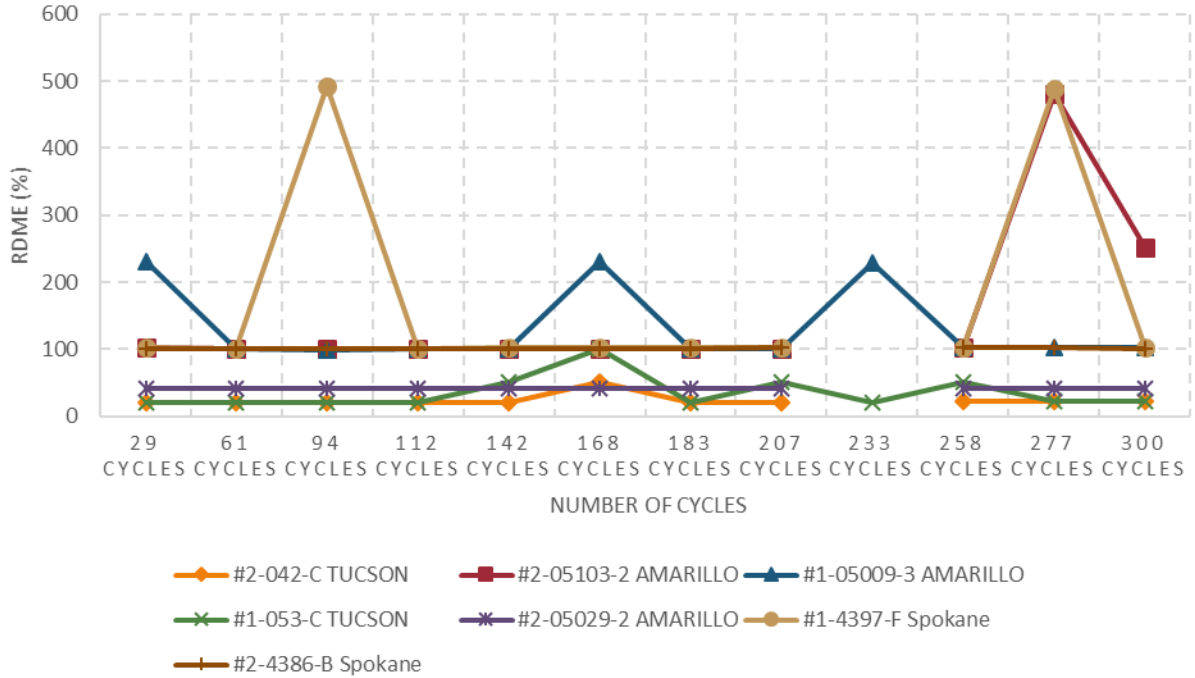

Figure A-15: RDME values at the middle for the top transverse direction of the tie.

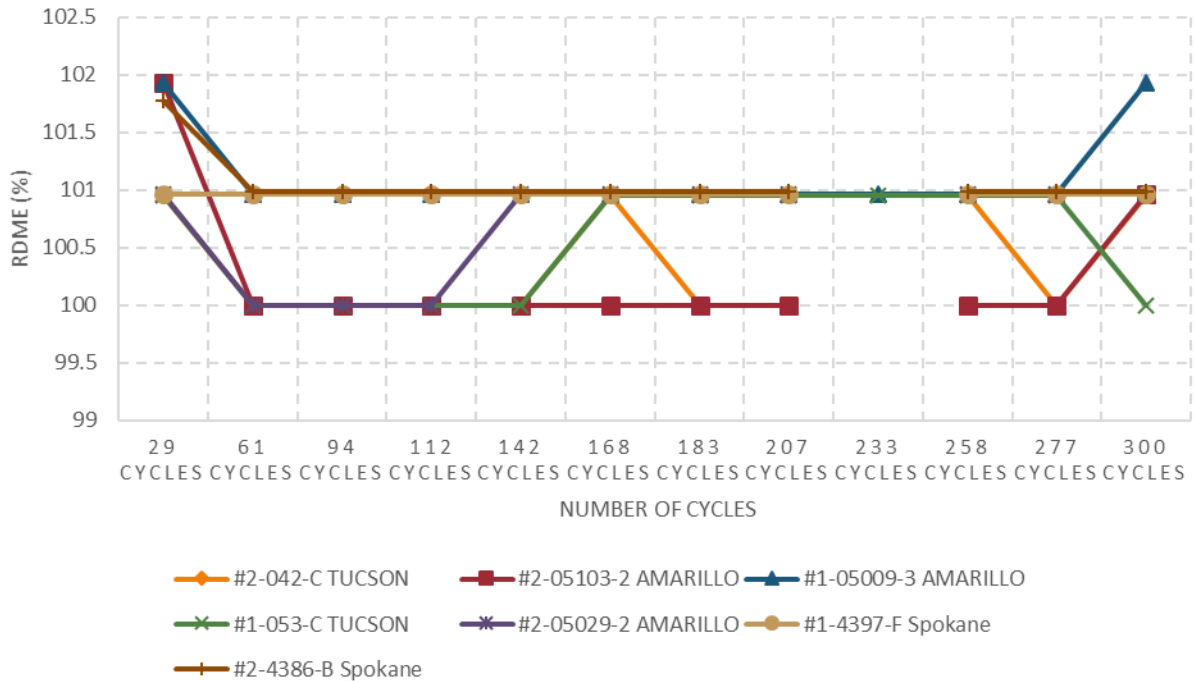

Figure A-16: RDME values at the middle for the top longitudinal direction of the tie.

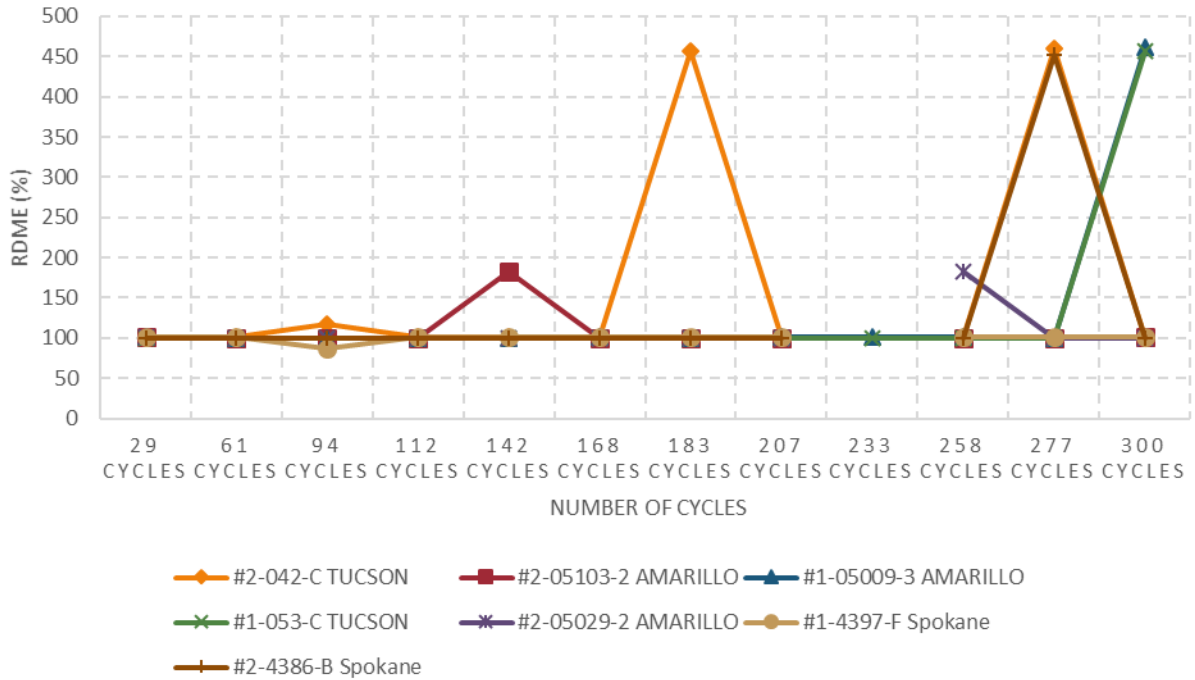

Figure A-17: RDME values at the middle for the side transverse direction of the tie.

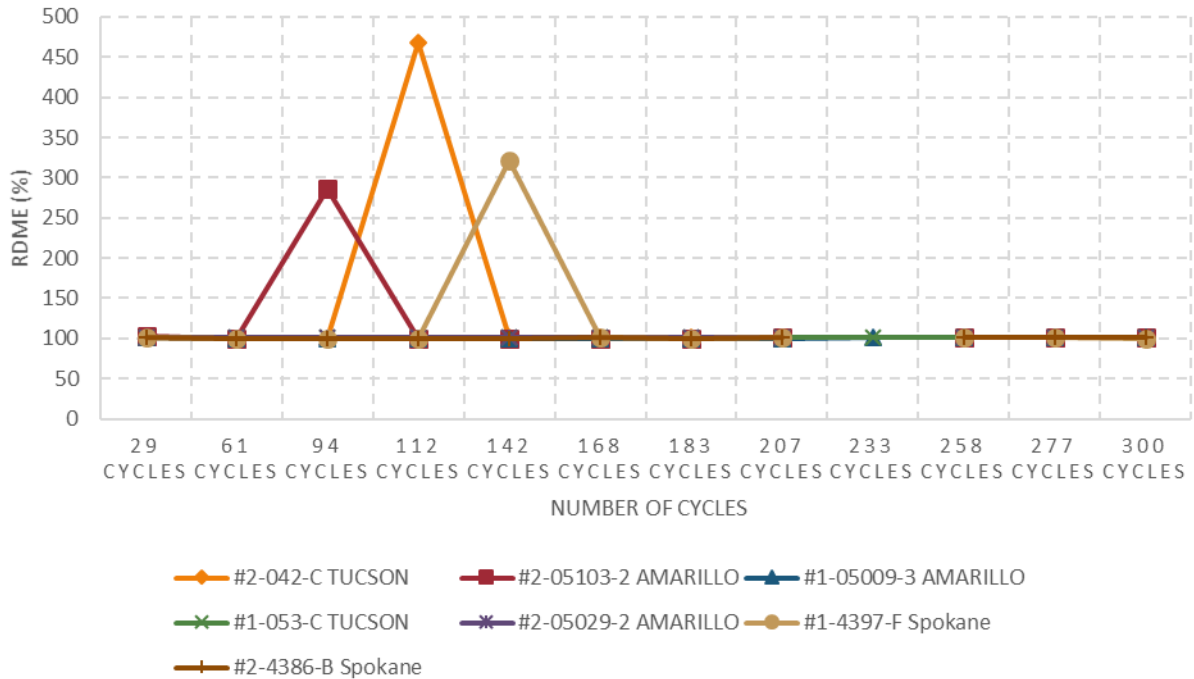

Figure A-18: RDME values at the middle for the side longitudinal direction of the tie.

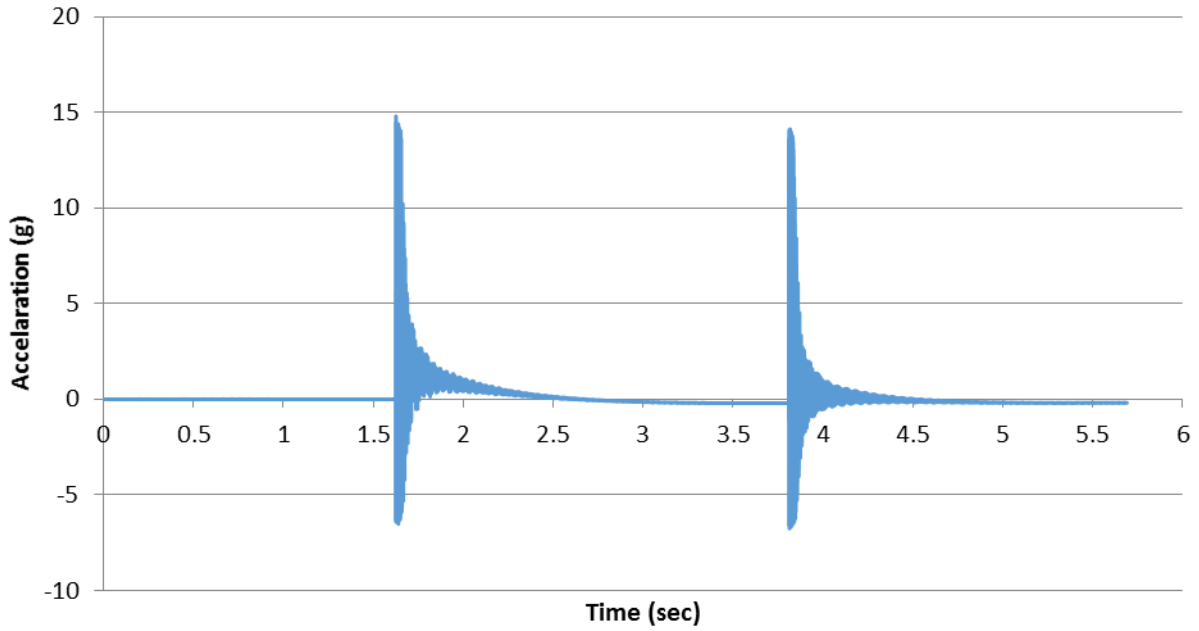

Figure A-19: Impact acceleration measurements for tie #2-05103-2 Plant C at the 258th cycle.

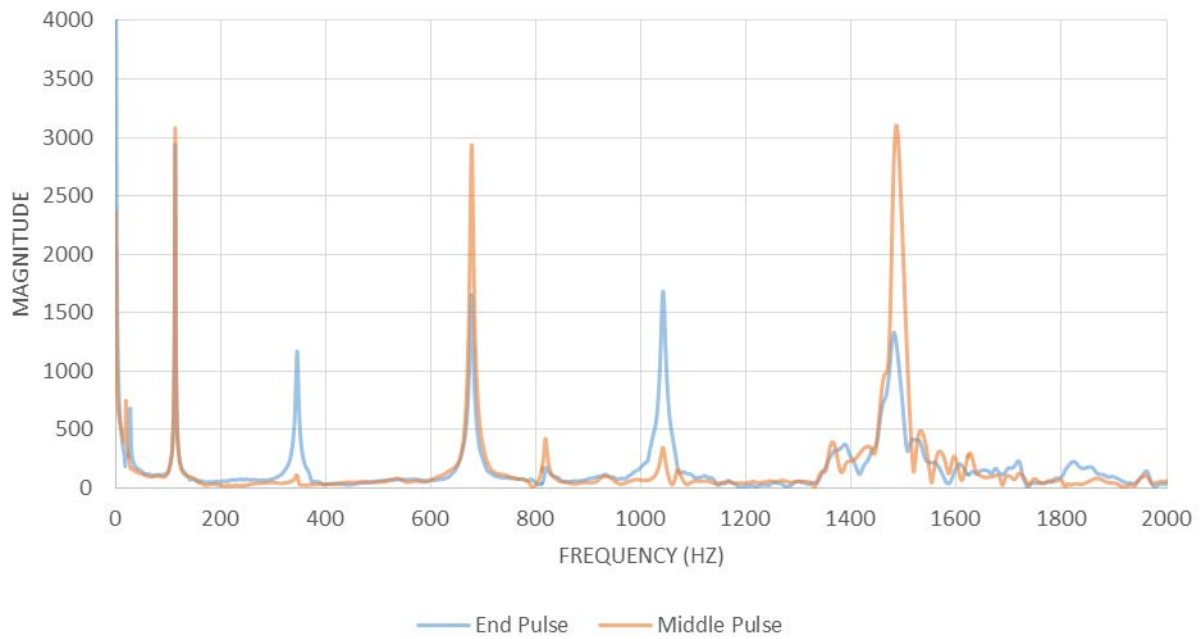

Figure A-20: Frequency domain for tie #2-05103-2 Plant C at the 258th cycle after impact.

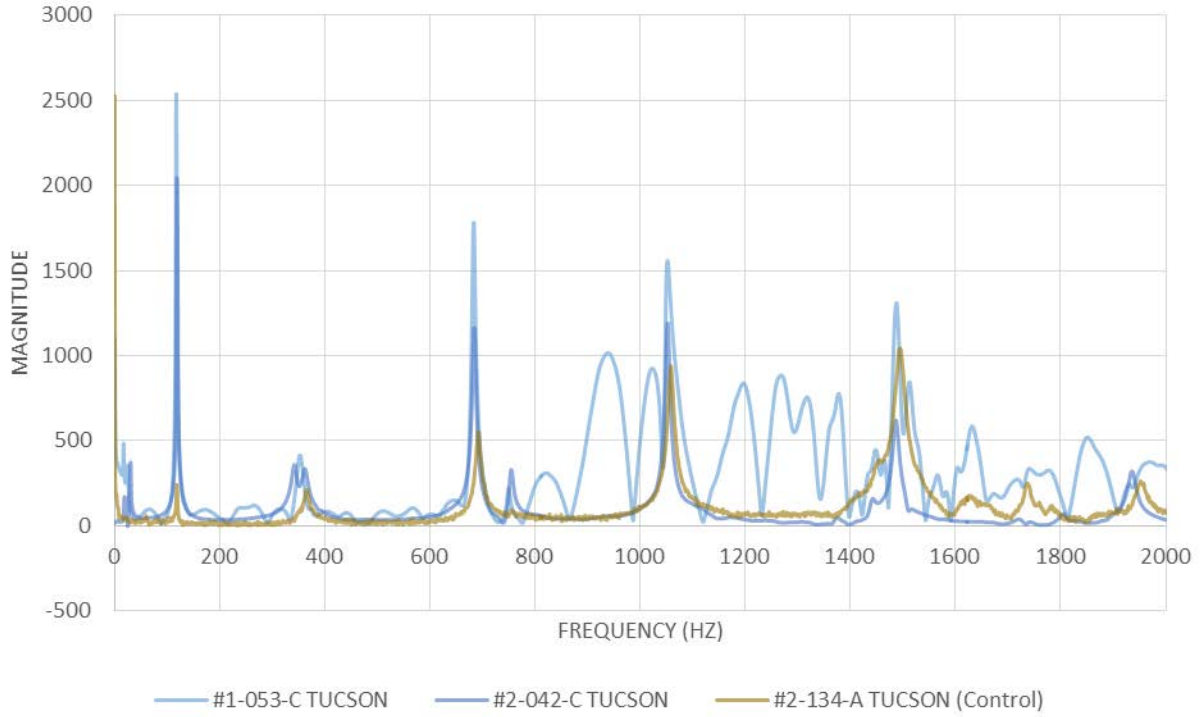

Figure A-21: Tie end frequency domain for Plant B ties after the 277th cycle after impact.

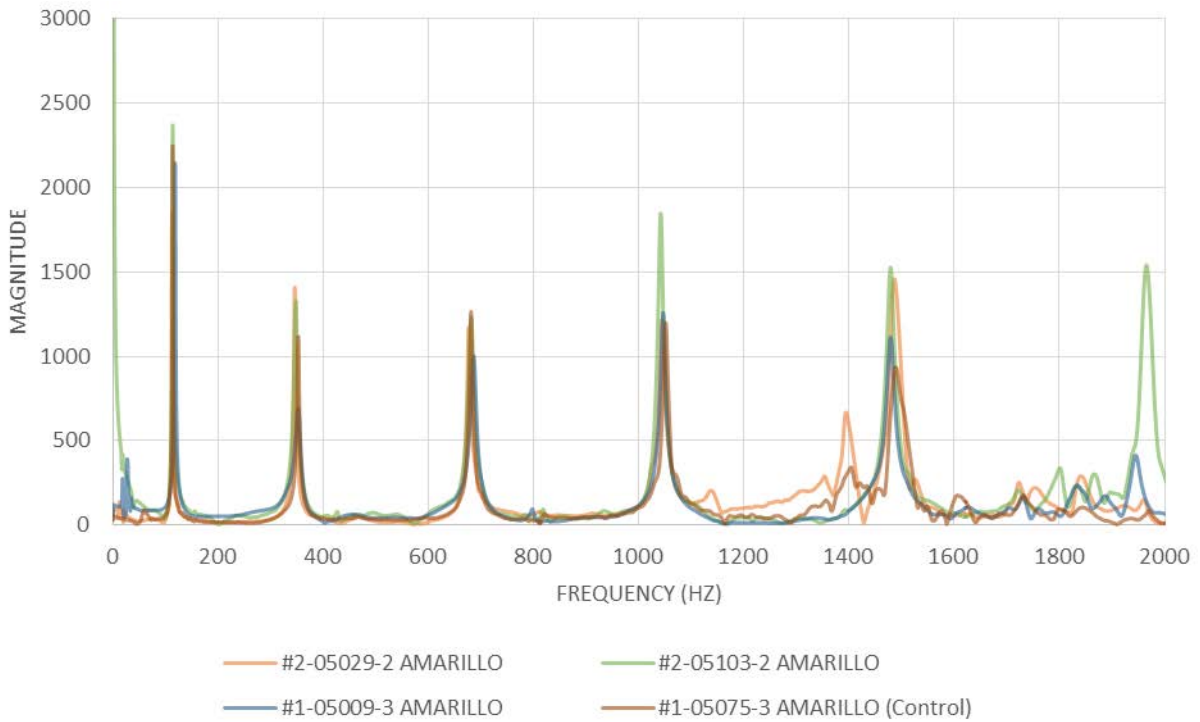

Figure A-22: Tie end frequency domain for Plant C after the 277th cycle after impact.

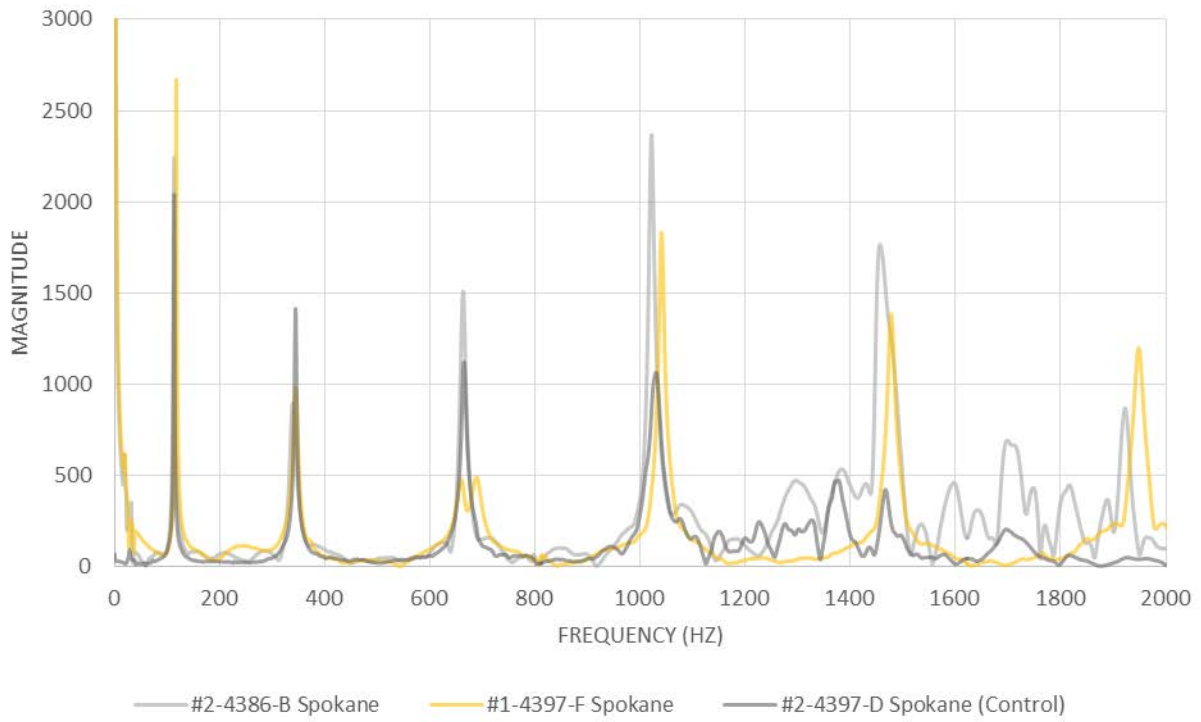

Figure A-23: Tie end frequency domain for Plant A at the 277th cycle after impact.

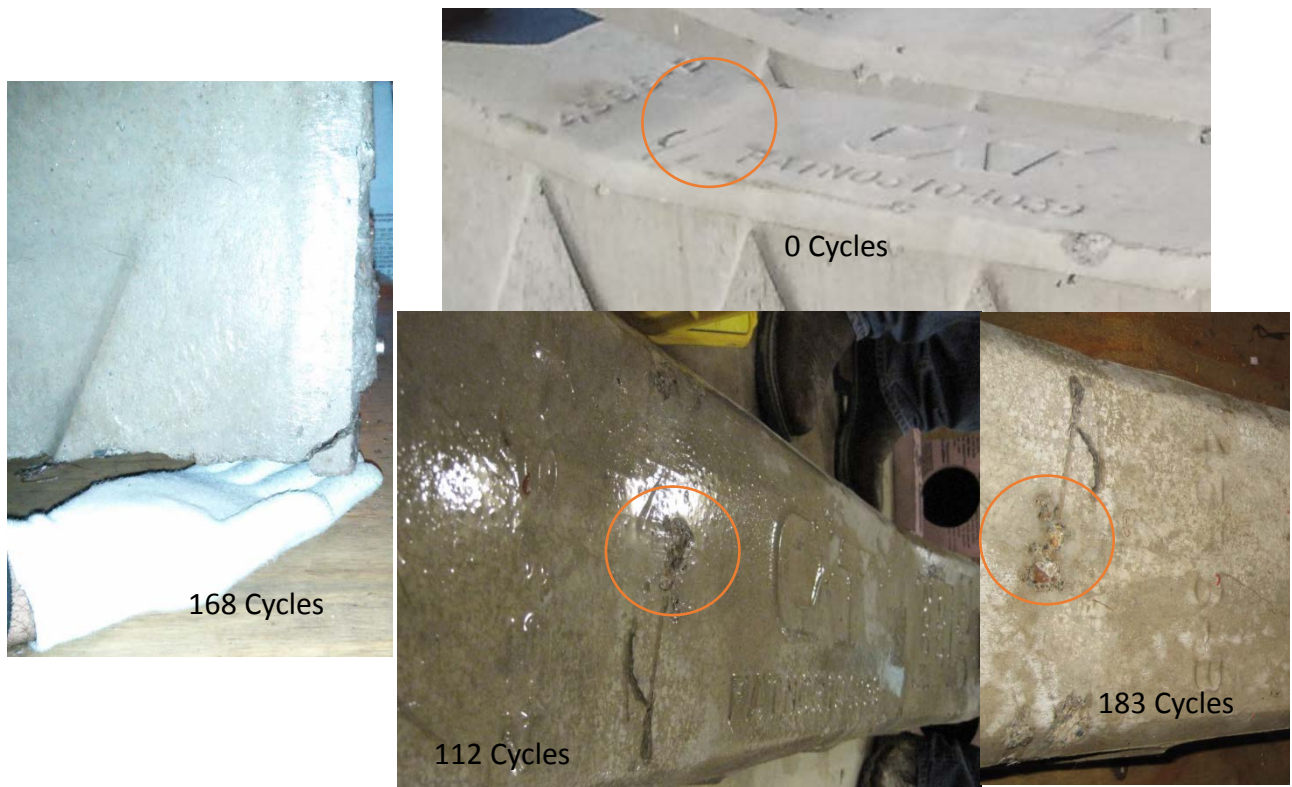

Figure A-24: Tie #2-4386-B Plant A visual observations.



Figure A-25: Tie #1-05009-3 Plant C visual observations.

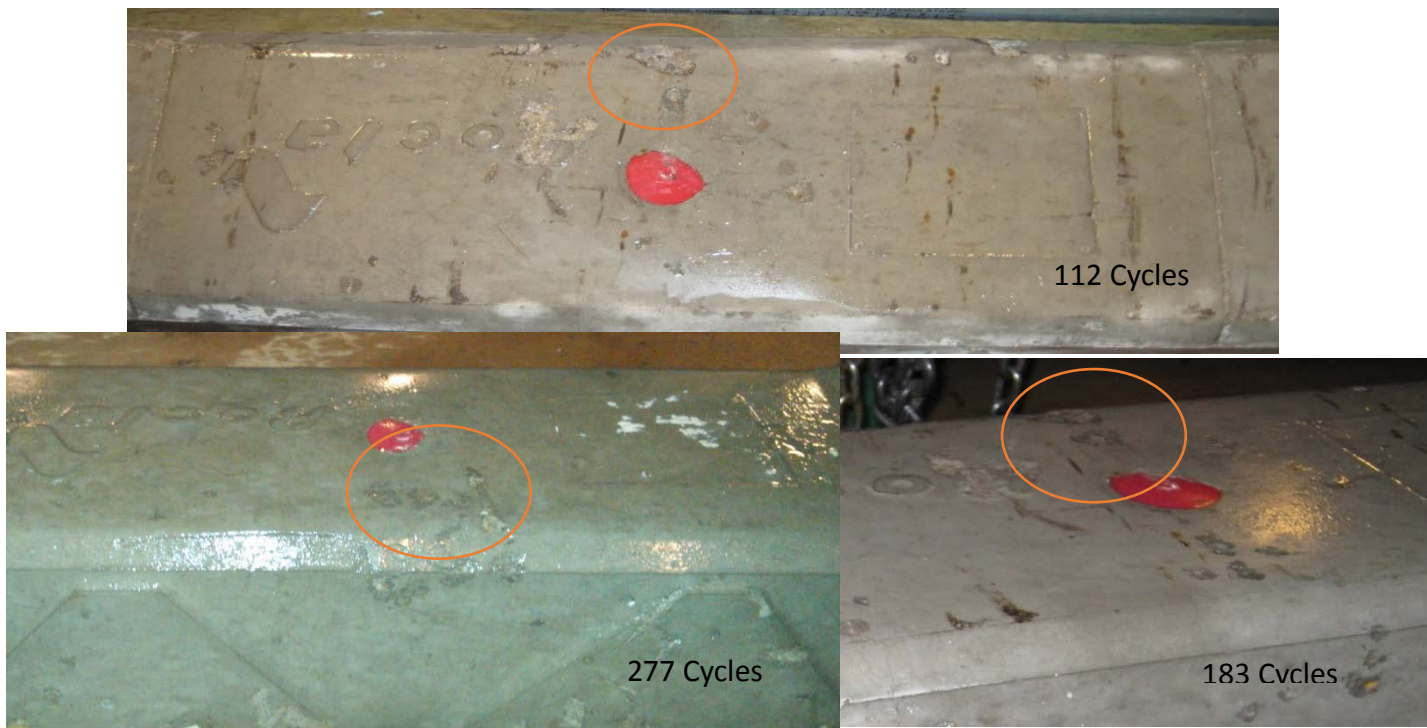

Figure A-26: Tie #2-05103-2 Plant C visual observations.

Abbreviations and Acronyms

ASTM	American Society for Testing and Materials
CN	Canadian National Railway Company
FFT	Fast Fourier Transform
IDOT	Illinois Department of Transportation
K-State	Kansas State University
RDME	Relative Dynamic Modulus of Elasticity
UIUC	University of Illinois at Urbana-Champaign