

NISTIR 6525

**Fire Safety of Passenger Trains; Phase II:
Application of Fire Hazard Analysis
Techniques**

Richard D. Peacock
Paul A. Reneke
Jason D. Averill
Richard W. Bukowski
John H. Klote

Fire Safety of Passenger Trains; Phase II: Application of Fire Hazard Analysis Techniques

Richard D. Peacock
Paul A. Reneke
Jason D. Averill
Richard W. Bukowski
John H. Klote

*Fire Research Division
Building and Fire Research Laboratory*

December 2002



U.S. Department of Commerce
Donald L. Evans, Secretary

Technology Administration
Phillip J. Bond, Under Secretary for Technology

National Institute of Standards and Technology
Arden L. Bement, Jr., Director

Certain commercial entities, equipment, or materials may be identified in this document in order to describe an experimental procedure or concept adequately. Such identification is not intended to imply recommendation or endorsement by the National Institute of Standards and Technology, nor is it intended to imply that the entities, materials, or equipment are necessarily the best available for the purpose.

**National Institute of Standards and Technology NISTIR 6525
NISTIR 6525, 185 pages (December 2002)**

Bibliographic Information

Abstract

A comprehensive multi-phase fire safety research program is being conducted by the National Institute of Standards and Technology to demonstrate the practicality and effectiveness of heat release rate-based test methods and hazard analysis techniques when applied to passenger train fire safety. The results of Phase II of the program which focused on the application of hazard analysis techniques using heat release rate data and computer modeling to evaluate passenger rail car fire performance is presented. In addition to materials, the impact of car geometry, detection and suppression systems, and egress time on the safety of passengers and crew for representative intercity passenger coach, dining, and sleeping rail car designs were evaluated.

For the three passenger rail car analyses conducted, passengers and crew are safe from unreasonable hazard of death or injury from interior fires involving materials or components exhibiting fire growth rates at or below a medium t-squared level, similar to the growth and HRR of a typical upholstered sofa. For all but the most severe ignition sources, conditions in all three passenger rail car designs studied remain tenable sufficiently long enough to allow safe passenger and crew egress, e.g., more than 10 minutes in some cases.

Keywords

Cone calorimeters; egress; fire hazards assessment; fire models; furniture calorimeters; heat release rate; railroad safety; test methods; transportation

PREFACE

On May 12, 1999, the Federal Railroad Administration (FRA), U.S. Department of Transportation (US DOT) issued regulations for passenger rail equipment safety standards that include fire tests and performance criteria to evaluate the flammability and smoke characteristics of interior materials used in intercity passenger and commuter rail cars. The FRA had originally issued those tests and criteria as guidelines in 1984; a revision was issued in 1989 to take into account the unique interior furnishings of intercity passenger rail cars. The results of this research program will assist the FRA in determining appropriate revisions to the fire safety requirements of the passenger equipment safety standards.

In 1993, the National Institute of Standards and Technology (NIST) completed a comprehensive evaluation of the U.S. and European approaches to passenger train fire safety, sponsored by the FRA, Office of Research and Development. The evaluation was directed by the John A. Volpe National Transportation Systems Center (Volpe Center), Research and Special Programs Administration, US DOT. A major conclusion of the NIST study was that the use of fire hazard and fire assessment techniques, based on mathematical modeling and supported by measurement methods using heat release rate (HRR), could provide a more credible and cost-effective means to predict the behavior of real-world passenger rail car materials.

The Volpe Center then developed a comprehensive three-phase passenger train fire safety research program to be conducted by NIST under the sponsorship of the FRA. This research program is directed at providing the scientific basis for using a systems approach to maintain and improve the level of passenger train fire safety. The focus is to demonstrate the practicality and effectiveness of HRR-based test methods and hazard analysis techniques when applied to passenger rail cars. The Cone Calorimeter test method (ASTM E 1354) provides small-scale data measurement of heat release rate, smoke emission, specimen mass loss, and combustion gases. This quantitative data can be used to evaluate the performance of individual component materials and assemblies and as inputs for fire modeling. Such modeling allows consideration of other factors in addition to material flammability, as well as fire-safety tradeoffs in design and performance for the entire system. This approach is also consistent with ongoing efforts to develop performance-based fire codes in the United States and Europe.

This document presents the results of Phase II of the program which focused on the application of hazard analysis techniques using HRR data and computer modeling to evaluate passenger rail car fire performance. In addition to materials, the impact of car geometry, detection and suppression systems, and egress time on the safety of passengers and crew for representative intercity passenger coach, dining, and sleeping rail car designs was evaluated. Although based on existing passenger rail car designs, the evaluation in this interim report represents only examples demonstrating the use of fire hazard analysis techniques, and does not represent an evaluation of any particular existing car configuration or actual hazard.

The Phase I report contains the results of an evaluation of rail car interior materials using the Cone Calorimeter test method.

The Phase III report contains the results of full-scale testing of an actual intercity passenger rail car to verify material fire performance and the fire hazard analysis based on the computer model.

ACKNOWLEDGMENTS

This project was sponsored by the Federal Railroad Administration, U. S. Department of Transportation, with technical oversight by the John A. Volpe National Transportation Systems Center (Volpe Center). Direction and technical review of the Phase II interim report were provided by Steven R. Ditmeyer, Director; Claire L. Orth, Chief, Equipment and Operating Practices Division; and Thomas N. Tsai, Senior Project Engineer; all of the Federal Railroad Administration, Office of Research & Development; and Robert M. Dorer, Chief, Railroad Systems Division, Volpe Center. Stephanie H. Markos, Volpe Center, provided overall project technical direction, specific oversight of Phase II task progress, and technical review of all Phase II work products.

Materials and assemblies for the real-scale heat release rate assembly tests conducted for this report were provided by Amtrak. The continued support of Amtrak and Douglas Karan, formerly Senior Industrial Designer for Amtrak, is greatly appreciated.

A Peer Review Committee was established to guide the development of this research program. Members of this committee who reviewed the Phase II interim report include: Douglas Karan, Amtrak; James P. Gourley, formerly of Amtrak; Thomas W. Fritz, Armstrong World Headquarters; Arthur F. Grand, Omega Point Laboratories; Gerald Hoefstader, Bombardier Corporation; William R. Segar, ADtranz ABB Daimler-Benz Transportation; James M. Surlless, Long Island Railroad; Vytenis Babrauskas, Fire Science and Technology, Inc.; John Devlin, Schirmer Engineering Company; John Gmelch, Bay State Marketing Consultants; William D. Kennedy, Parsons Brinckerhoff Quade & Douglas, Inc.; Steven Roman, LTK Engineering Group; Joseph B. Zicherman, Integrated Fire Technology/Fire Cause Analysis, Inc.; Nancy B. McAtee, National Transportation Safety Board; and Carl Ogburn, Chestnut Ridge Foam, Inc.; all of whom also provided important input during the progress of the Phase II tasks. Their scientific and practical knowledge, candid discussions relating to fire safety and rail car material selection, as well as their comments on the draft Phase II interim report, are gratefully acknowledged.

Finally, the authors extend thanks to Cassandra Oxley, Nathan Grace, and Barbara Siccone for editorial and typing support in preparing this report for publication.

CONTENTS

	Page
1 INTRODUCTION	1
1.1 FRA FIRE SAFETY REQUIREMENTS	2
1.2 OVERALL PROJECT OBJECTIVE	4
1.3 OVERALL PROJECT TECHNICAL APPROACH	4
1.4 PHASE I INTERIM REPORT	5
1.5 PHASE II INTERIM REPORT	5
1.5.1 Scope	5
1.5.2 Report Organization	6
2 ASSESSING PASSENGER RAIL CAR FIRE PERFORMANCE	9
2.1 HRR AND FIRE HAZARD ANALYSIS	9
2.2 OVERVIEW OF FIRE MODELING	10
2.2.1 Model Input	12
2.2.2 Model Output	12
2.2.3 Limitations of Zone Fire Models	13
2.3 QUANTITATIVE FIRE HAZARD ANALYSIS	13
2.4 APPLICATION OF FIRE HAZARD ANALYSIS TO PASSENGER RAIL CARS	16
2.4.1 Step 1: Define Passenger Rail Car Performance Objectives and Design ..	17
2.4.2 Step 2: Calculate Passenger Rail Car Fire Performance	17
2.4.3 Step 3: Evaluate Specific Passenger Rail Car Fire Scenarios	19
2.4.4 Step 4: Evaluate Suitability of Passenger Rail Car Design	20
2.5 RELATED U.S. FIRE SAFETY ANALYSIS STUDIES	20
2.5.1 1993 FRA U.S. and European Passenger Train Fire Safety Comparison ..	21
2.5.2 1996 NTSB-Sponsored Passenger Rail Car Material Fire Evaluation ...	21
2.5.3 1984 FRA/Amtrak Study	21
2.5.4 1990 NHTSA School Bus Study	22
2.6 RELATED EUROPEAN PASSENGER TRAIN STUDIES	22
2.7 SUMMARY	24
3 PASSENGER TRAIN DESIGN FIRES AND FIRE SCENARIOS	27
3.1 DESIGN FIRES	27
3.2 PASSENGER TRAIN FIRE SCENARIOS	30
3.2.1 Recent Major Passenger Train Fires	31
3.2.2 U.S. Passenger Train Fire Data	32
3.2.3 Interior Fire Scenarios	33
3.2.4 Exterior Fire Scenarios	35
3.2.5 Fire Scenario Development	35
3.3 COMBINING DESIGN AND SCENARIO FIRES	37

3.4 RAIL CAR MATERIAL ASSEMBLY TEST RESULTS	37
3.4.1 Test Results	37
3.4.2 Test Result Uncertainty	42
3.5 SUMMARY	42
4 BASELINE PASSENGER RAIL CAR FIRE HAZARD ANALYSES	45
4.1 STEP 1: DEFINE PASSENGER RAIL CAR PERFORMANCE OBJECTIVE AND DESIGN	45
4.1.1 Fire Performance Objective	46
4.1.2 Coach Car Design and Geometry	46
4.1.3 Important Materials	47
4.2 STEP 2: CALCULATE PASSENGER RAIL CAR FIRE PERFORMANCE	50
4.2.1 Minimum Acceptable Performance Criterion	50
4.2.2 Standard Design Fires	51
4.2.3 Design Fire Modeling	53
4.2.4 Fire Performance	55
4.3 STEP 3: EVALUATE SPECIFIC PASSENGER RAIL CAR FIRE SCENARIOS	56
4.3.1 The Role of Rail Car Contents in Specific Fire Scenarios	57
4.3.2 Modeling Specific Scenarios	58
4.3.3 Burning Behavior for Specific Scenarios	59
4.3.4 Composite Scenarios for Fire Modeling	60
4.4 STEP 4: EVALUATE SUITABILITY OF PASSENGER RAIL CAR DESIGN ..	63
4.4.1 Quantification of Uncertainty in the Fire Performance Graphs	64
4.4.2 Design Sensitivity, Design Margins, and Acceptability	65
4.5 DINING CAR ANALYSIS	65
4.5.1 Car Configuration	66
4.5.2 Important Materials	66
4.5.3 Results	68
4.6 SLEEPING CAR ANALYSIS	69
4.6.1 Car Configuration	70
4.6.2 Important Materials	71
4.6.3 Results	73
4.7 BASELINE FIRE HAZARD ANALYSES - KEY OBSERVATIONS	75
4.8 SUMMARY	77
5 QUANTIFYING THE IMPACT OF PASSENGER RAIL CAR	81
5.1 EFFECTS OF ALTERNATIVE MATERIALS AND CAR GEOMETRY	81
5.1.1 Changing Material Requirements	82
5.1.2 Changing Car Geometry	85
5.2 EFFECTS OF ALTERNATIVE FIRE PROTECTION SYSTEMS	86
5.2.1 Detection and Suppression Systems	86
5.2.2 Smoke Management	87
5.2.3 Automatic Suppression Systems	89
5.2.4 Summary of the Effects of Fire Protection Systems Relative to the Baseline Analysis	90
5.3 EFFECT OF REDUCING MINIMUM NECESSARY EGRESS TIME	91

5.4 EFFECT OF ALTERNATIVE TENABILITY CRITERIA	92
5.5 SUMMARY	94
6 SUMMARY	97
6.1 SUMMARY OF PHASE II RESULTS	97
6.1.1 Assembly Tests	97
6.1.2 Standard Design Fires	98
6.1.3 Baseline Fire Hazard Analyses	98
6.1.4 Impact of Passenger Rail Car System Changes on Fire Performance ...	101
6.2 APPLICATION TO PHASE III TASKS	103
6.2.1 Real-Scale Gas Burner Tests	103
6.2.2 Full-Scale Fire Growth and Spread Tests	104
APPENDIX A. PASSENGER RAIL CAR INTERIOR MATERIAL ASSEMBLY	
TESTS	A-1
A.1 HRR MEASUREMENT OVERVIEW	A-1
A.2 TEST APPROACH	A-2
A.2.1 HRR Measurement	A-2
A.2.2 Flux Meter Measurement	A-2
A.2.3 Ignition Sources	A-3
A.2.4 Test Time Periods	A-4
A.3 MATERIAL ASSEMBLIES INCLUDED IN THIS STUDY	A-5
A.4 DETAILS OF ASSEMBLY TEST CONFIGURATIONS	A-5
A.4.1 Amtrak Trash Bag Tests	A-7
A.4.2 Newspaper-Filled Trash Bag Tests	A-7
A.4.3 Coach Seat Tests	A-8
A.4.4 Sleeping Compartment Economy Bedroom Assembly Tests	A-11
A.4.5 Wall and Ceiling Carpet Tests	A-13
A.4.6 Window Drape and Door Privacy Curtain Tests	A-14
A.4.7 Wall Panel and Window Tests	A-17
A.5 TEST RESULTS	A-19
A.5.1 Amtrak Trash Bags	A-19
A.5.2 Newspaper-Filled Trash Bags	A-21
A.5.3 Coach Seats	A-23
A.5.4 Sleeping Compartment Economy Bedroom Assemblies	A-26
A.5.5 Wall and Ceiling Carpet	A-28
A.5.6 Window Drapes and Door Privacy Curtains	A-29
A.5.7 Wall Panel and Window	A-32
A.6 TEST RESULTS SUMMARY	A-33
APPENDIX B. PASSENGER RAIL CAR CONFIGURATION, VENTING DETAILS,	
AND FIRE MODELING INPUTS	B-1
B.1 COACH CAR	B-1
B.2 DINING CAR	B-5
B.3 SLEEPING CAR	B-10

FIGURES

	Page
Figure 1. Zone Model	11
Figure 2. Major Component Interrelationships in a Fire Hazard Model	14
Figure 3. An Idealized Compartment Fire Showing Fire Growth, Steady Burning, and Decay	27
Figure 4. T-Squared Fire Growth Curves Used to Approximate Fire Growth in Most Fuels ...	29
Figure 5. Fire Extinguishment Using Sprinklers Represented by HRR Exponential Decay ...	30
Figure 6. Trash Bag Test/Gas Sand Burner Ignition Source	38
Figure 7. Seat Assembly Test - TB-133 Ignition Source	38
Figure 8. Wall Carpet Assembly Test - Gas Sand Burner Ignition Source	39
Figure 9. Window Drape Assembly Test (Extended) - Gas Sand Burner Ignition Source ...	39
Figure 10. Wall and Window Assembly Test - Gas Sand Burner Ignition Source	40
Figure 11. Wall, Window, and Drape Assembly Test - Trash Bag/Gas Sand Burner Ignition Source	40
Figure 12. Floor Plan and Compartment Selection for Coach Car Fire Modeling	47
Figure 13. Typical Intercity Coach Car Interior Furnishings	48
Figure 14. Calculated Conditions for Coach Car Main Seating Area Exposed to a Medium T-Squared Fire Source	54
Figure 15. Calculated Fire Performance for Baseline Coach Car Fire Hazard Analysis	55
Figure 16. HRR for Several Composite Fire Scenarios Used to Model Coach Car Fires	61
Figure 17. Calculated Fire Performance for Baseline Fire Hazard Analysis of Coach Car Comparing Available Egress Time with Several Composite Fire Scenarios	63

Figure 18. Sensitivity of Calculated Fire Performance to a 5 Percent Change in Compartment Size and Vent Openings	64
Figure 19. Floor Plan and Compartment Selection for Dining Car Fire Modeling	66
Figure 20. Typical Dining Car Interior Furnishings	67
Figure 21. Calculated Fire Performance for Baseline Fire Hazard Analysis of Dining Car Comparing Available Egress Time with Several Composite Scenario Fires	69
Figure 22. Floor Plan and Compartment Selection for Sleeping Car Fire Modeling	70
Figure 23. Typical Sleeping Car Economy Bedroom Interior Furnishings	72
Figure 24. Calculated Fire Performance for Baseline Fire Hazard Analysis of Sleeping Car, Comparing Available Egress Time with Several Composite Fire Scenarios	74
Figure 25. Original and Adjusted Composite Fire Scenario HRR Curves	82
Figure 26. Percentage Change in HRR of Modified Composite Fire Compared to Baseline Composite Fire Scenario	83
Figure 27. Calculated Fire Performance for Fire Hazard Analysis of Coach Car Configuration Including Passive Smoke Vents	87
Figure 28. Calculated Fire Performance for Fire Hazard Analysis of Coach Car Configuration Including Exhaust Fans	88
Figure 29. Calculated Fire Performance for Fire Hazard Analysis of Coach Car Configuration Including a Suppression System	90
Figure 30. Calculated Fire Performance for Fire Hazard Analysis of Coach Car Configuration Including Alternative Tenability Criteria	94

TABLES

	Page
Table 1. Passenger Rail Car Fire Hazard Analysis Steps	18
Table 2. Peak HRR Measured During Furniture Calorimeter Assembly Tests	41
Table 3. Relative Contribution of Coach Car Material Components	49
Table 4. Calculated Egress Times for Coach Car	51
Table 5. Characteristic Fire Growth Rate for Several Coach Car Fire Scenarios	62
Table 6. Relative Fire Contribution of Dining Car Material Components	68
Table 7. Relative Contribution of Sleeping Car Material Components	72
Table 8. Effect of Material HRR on Overall Coach Car Fire Safety Performance	84
Table 9. Effect of Geometry Changes on Overall Coach Car Fire Safety Performance	85
Table 10. Predicted Activation of Heat and Smoke Detectors for Coach, Dining, and Sleeping Cars	86
Table 11. Effect of Active Fire Protection Systems on Overall Coach Car Fire Safety Performance	90

Fire Safety of Passenger Trains; Phase II: Application of Fire Hazard Analysis Techniques

Richard D. Peacock, Paul Reneke, Richard W. Bukowski,
Jason D. Averill, and John H. Klote

Building and Fire Research Laboratory
National Institute of Standards and Technology

1. INTRODUCTION

Fire safety is an area of particular interest for both conventional intercity passenger and commuter rail trains, and new, lightweight high-speed trains. A systems approach to fire safety can address passenger rail car design and materials, detection and suppression, passenger and train crew evacuation, and their interactions. The Federal Railroad Administration (FRA) is sponsoring a multi-phase research program directed at providing the scientific basis for using a systems approach to evaluate the level of passenger train fire safety already achieved through the current prescriptive material requirements. A recently published interim report documents the results of Phase I of the research program being conducted by the National Institute of Standards and Technology (NIST) [1]. That first phase focused on the evaluation of passenger rail car interior furnishing materials, using data from FRA-cited small-scale test methods and from an alternative test method using the Cone Calorimeter (American Society for Testing and Materials) [ASTM] E-1354 [2].

This interim report presents the results of Phase II. Heat release rate (HRR) and other measurements were used as an input to a computer fire model. Hazard analyses were conducted for three typical passenger rail car configurations to evaluate the contribution of selected materials to overall passenger train fire safety. These analyses used data from the Cone Calorimeter tests conducted in Phase I and data from representative passenger rail car interior component assembly tests using a large-scale Furniture Calorimeter.

Currently, the U.S. and European approaches to passenger train fire safety rely primarily on individual small-scale test methods to evaluate material fire performance. However, a 1993 FRA-sponsored study by NIST concluded that an alternative approach could provide a more credible and cost-effective means to predict the fire performance of passenger train materials [3].

This alternative approach employs fire hazard ¹ assessment techniques, using fire modeling based on test methods using HRR data. An extensive effort sponsored by the European Railway Research Institute (ERRI) is also underway to relate small-scale and real-scale fire performance, using HRR and fire modeling [4].

1.1 FRA FIRE SAFETY REQUIREMENTS

On May 12, 1999, the FRA issued a rule containing passenger rail equipment safety standards [5]. The standards contained in the Code of Federal Regulations (49 CFR), Part 238.103 require that materials used for passenger rail cars and locomotives meet certain fire safety performance criteria and that fire hazard analyses be conducted for all new and existing rail passenger equipment.

The new FRA rule made mandatory the use of certain flammability, smoke emission and fire endurance test methods, as well as specific performance criteria for passenger rail car and locomotive components and materials. The FRA had originally issued those tests and criteria as guidelines in 1984 [6]; a revision was issued in 1989 [7]. The rule applies to materials used in new construction, as well as materials used to refinish, refurbish, or overhaul existing rail passenger equipment.

In the Notice of Proposed Rulemaking (NPRM) [8], the FRA had initially planned to require the use of the same tests and performance criteria as in the 1989 guidelines. However, several parties expressed specific concerns to the FRA rule docket regarding perceived difficulties that would occur if the same 1989 FRA guideline tests and criteria were made mandatory. To address these concerns, the FRA considered the results of a John A. Volpe National Transportation Systems Center (Volpe Center)-organized workshop attended by participants representing passenger rail car designers and builders, material manufacturers, consultants, NIST, and test laboratories which was held in 1997, as well as the results to date of this FRA research study. The contents of the May 12, 1999 Appendix B rule requirements therefore represented a refinement of the NPRM [9]. Highlights include: table reorganization; seat assembly test alternative, and small part exemption. (Note: The original 1984 FRA tests and performance criteria were adapted from Urban Mass Transportation Administration [UMTA],

¹ Fire hazard: the seriousness of the exposure conditions that threatens the physical well being of the occupant. The hazard may come from various sources, for example, smoke inhalation, direct flame burn, injuries due to trauma (e.g., ceiling collapse), high temperatures, or the inability to escape due to lack of visibility, or the presence of irritant gases which may affect breathing and visibility.

now Federal Transit Administration [FTA] recommended practices for rail transit vehicles developed by the Volpe Center, also issued in 1984 [10]).

The FRA plans to issue a Federal Register Notice in mid 2002 that will contain additional revisions relating to Appendix B of the rule, in order to address comments from several parties to the rule docket and clarify the applicability of certain requirements.

Based primarily on small-scale test methods that demonstrate fire characteristics of individual materials, the FRA and other similar transportation vehicle requirements form a prescriptive set of design specifications which historically have been used to evaluate the fire performance of those materials. This approach provides a screening device to allow interested parties to eliminate the use of particularly hazardous materials and to select combinations of individual components (material suppliers can independently evaluate the fire safety performance of their own materials). However, in most ground transportation applications, end-use assemblies have not usually been tested.

Considerable advances in fire safety engineering have been made since the original development of the FRA material requirements. Much of the data obtained from the currently FRA-cited test methods provide a relative ranking of materials under the specified exposure conditions. However, those test methods do not provide quantitative data which can be used for computer fire modeling and fire hazard analysis. In addition, the 1993 NIST study and several other studies have concluded that the impact of material interactions and changes in real-scale passenger vehicle interior geometry are also critical factors in predicting actual fire behavior. These factors cannot be evaluated through the use of small-scale tests alone.

In addition to the material and floor endurance test requirements, the FRA rule requires that fire safety analyses be conducted by intercity passenger and commuter rail train operators for both new and existing rail cars (49 CFR, Part 238.103). The intent of the analyses is the evaluation of the overall rail car *system* in terms of fire safety performance to resolve potential fire hazards, rather than focusing solely on material fire safety characteristics. For new equipment, the rule provides guidance to assist railroads in performing an analysis and identifies important elements that should be considered, including equipment design, ventilation systems, overheating, detection, and manual or automatic fire extinguishers. The FRA rule also notes that for existing equipment, it may not be necessary to remove materials that do not comply with Appendix B of the rule depending on the ignition source, material location and quantity, and ability of passengers to evacuate a rail car.

In response to the FRA rule, the American Public Transportation Association (APTA) developed a recommended practice to guide passenger railroads in completing fire safety analyses for existing equipment [11]. That recommended practice is intended to provide a logical, systematic process that passenger railroads can use to perform the required fire safety analysis for existing equipment consistent with the FRA rule requirements.

To assess the feasibility of applying HRR test methods, fire modeling techniques, and hazard analysis to U.S. passenger rail cars, the Volpe Center is directing a comprehensive multi-phase fire safety research program being conducted by NIST. Included in this research program is a study directed at intercity passenger and commuter rail car applications using a computer model to perform fire hazard analyses for three different types of passenger rail cars: a single level coach car, and bi-level dining and sleeping cars. Other factors, such as wire and cable and floor structure fire performance that are also applicable to rail transit and bus applications, are not considered in this study.

1.2 OVERALL PROJECT OBJECTIVE

The overall project objective is to fully demonstrate the practicality and effectiveness of HRR-based test methods and fire hazard analysis methodology in quantifying the threat of catastrophic fire conditions in a passenger train environment. The results of this project are intended to provide: (1) the FRA with additional information to use in refining the fire safety provisions in 49 CFR, Part 238, and (2) car builders and passenger train system operators with design flexibility to employ a broader array of materials and designs in future passenger rail cars. The successful application of this alternative approach to complement material screening tests could provide a more credible and cost-effective way to evaluate the real-world fire performance of passenger rail cars while maintaining or improving the level of passenger train fire safety.

1.3 OVERALL PROJECT TECHNICAL APPROACH

To evaluate the applicability of fire modeling and hazard analysis when applied to passenger rail car design, appropriate HRR data must be obtained, fire modeling and hazard analysis conducted, and the results of the methodology tested against real-scale fire simulations designed to verify the predicted outcome. The research study consists of the following three phases:

- During Phase I, selected passenger rail car interior materials were evaluated using the Cone Calorimeter test method. The use of this test method and resulting HRR data

were reviewed with respect to current FRA-cited tests, performance criteria, and flammability and smoke emission data to compare the relative performance of current materials.

- During Phase II, the applicability of fire modeling and hazard analysis techniques to predict rail car fire hazards and mitigate those hazards was evaluated. Real-scale tests of assemblies, such as seats, were conducted to obtain component fire performance data. The evaluation included changes in passenger rail car design and materials, detection and suppression systems, and passenger evacuation, to assess the relative impact on fire safety for a range of design parameters. This interim report documents the results of the Phase II research tasks.
- During Phase III, selected full-scale tests of a passenger rail car, in actual end-use configuration, were performed to verify the predicted system performance against the small-scale and real-scale assembly tests and hazard analysis studies.

1.4 PHASE I INTERIM REPORT

The NIST Phase I interim report describes the results of Cone Calorimeter tests of representative interior materials used in a typical intercity passenger rail car [1]. Performance data included ignitability, HRR, and release rate for smoke, products of combustion, and toxic gases. The measurements were obtained under identical fire exposure conditions. In addition, a comparison was performed of the Cone Calorimeter test data and the current FRA-cited flammability and smoke emission test data and correlations were developed. The Phase I interim report also reviewed fire safety requirements and related research studies for U.S. and European rail passenger trains, and other transportation modes.

1.5 PHASE II INTERIM REPORT

This report describes the results of Phase II of the NIST work effort. Furniture Calorimeter tests of assemblies were conducted to provide further data input into a computer fire model. The computer fire model was used to establish baseline fire analyses for three types of rail passenger cars and evaluate the impact of car configuration and alternative system design on the level of fire hazard.

1.5.1 Scope

This Phase II report describes the results of the following major tasks:

- Measure the fire performance of selected real-scale assemblies representing interior furnishings that may become involved in passenger train fires using large-scale Furniture Calorimeter tests. These real-scale assemblies include actual seats, wall panels, bedding, and other components arranged in configurations that are representative of how they are actually used in passenger rail cars.
- Perform fire hazard analyses of a passenger rail single-level coach car, and bi-level dining and sleeping cars. Using the real-scale assembly test data documented in this interim report, as well as the Cone Calorimeter data from tests conducted in Phase I, the analyses consider rail car design and materials, detection and suppression systems, and emergency evacuation.
- Assess relative impact on overall fire hazard of alternative passenger rail car system changes in design and materials, detection and suppression systems, and emergency evacuation. By evaluating changes to the individual rail cars considered in the above task, the effects of a range of changes on the resulting fire hazard are quantified.

Although based on existing passenger rail car designs, the evaluation in this interim report represents only examples demonstrating the use of fire hazard analysis techniques, and does not represent an evaluation of any particular existing car configuration or actual hazard.

1.5.2 Report Organization

Chapter 2 provides an overview of fire modeling and hazard analysis. That chapter outlines the major steps and calculations which were applied for the passenger rail car fire hazard analyses.

Chapter 3 introduces the use of the general passenger rail car design fire for the fire hazard analyses. Specific scenarios and real-scale assembly test data applicable to passenger train fires are also reviewed.

Chapter 4 describes the fire hazard analysis process as applied to three types of passenger rail cars. Detailed results of the baseline fire hazard analysis performed for a passenger rail coach car are presented and discussed in detail. The results of the fire hazard analyses performed for bi-level dining and sleeping cars are also presented.

Chapter 5 discusses several design and other alternatives for the three passenger rail car configurations analyzed in Chapter 4 and quantifies the effects on the fire hazard resulting from these changes.

Chapter 6 presents a summary of accomplishments-to-date and summarizes the results of the fire hazard analyses conducted for this interim report. The implications of the results of Phase II on Phase III of the research program are also discussed.

Appendix A describes the details of the large-scale Furniture Calorimeter assembly tests conducted in support of Phase II. It includes an overview of the tests, descriptions of passenger rail car materials and assemblies, and the test results.

Appendix B provides additional information relating to the three passenger rail car configurations used in the fire hazard analyses described in this interim report. The coach, dining, and sleeping car dimensions, compartments and vents, as well as the fire modeling inputs are provided.

2. ASSESSING PASSENGER RAIL CAR FIRE PERFORMANCE

Small-scale tests have historically been used to evaluate individual passenger rail car component materials. These tests are useful as a screening procedure to prevent the use of hazardous materials, allow interested parties to select preferred combinations of components, and permit material suppliers to independently evaluate the fire safety performance of their own materials.

However, such a screening procedure does not fully address future designs that could make use of innovative materials and component assemblies for passenger rail car construction. The impact of material interactions and changes in real-scale passenger rail car interior geometry are also critical factors in predicting actual fire behavior. End-use assemblies have not been tested in most ground transportation applications.

Part 238.103 of the recently issued FRA fire safety rule requires that fire safety analyses be conducted for all existing and new rail passenger equipment. The intent of the analyses is to ensure that the overall rail car *system* (e.g., geometry, detection and suppression, and evacuation) to fire hazards is evaluated, as well as materials. HRR data and computer fire modeling can be used as an important input to the required FRA fire safety analysis. This section provides an overview of fire hazard analysis and fire modeling, and discusses the specific steps required. Previous U.S. and European research directed at ground transportation vehicle fire hazard analysis is also reviewed.

2.1 HRR AND FIRE HAZARD ANALYSIS

Better understanding of the underlying phenomena governing fire initiation and growth has led to the development of HRR test methods that can better predict the real-scale burning behavior of materials and assemblies than traditional methods [12]. HRR is considered to be a key indicator of fire performance and is the rate at which a material produces energy while burning. For a given confined space (e.g., passenger rail car interior), the air temperature is increased as the HRR increases. Even if passengers and crew do not come into direct contact with the fire, they could be injured by high temperatures, heat fluxes, and/or smoke and gases emitted by materials involved in the fire. Accordingly, the fire hazard to passengers and crew by these materials can be directly correlated to the HRR of a real-world fire.

HRR, smoke release rates, and other data measurements generated from the Cone Calorimeter can be used as an input to evaluate the extent of a material's overall contribution to the fire hazard in a particular application. In addition to Cone Calorimeter tests, large-scale Furniture Calorimeter tests can be used to determine how individual materials interact as assemblies in end-use. The data generated in large-scale calorimeter tests can be used as inputs for fire modeling as part of a hazard analysis. In addition to material flammability and smoke emission, fire modeling and hazard analysis techniques allow evaluation of a range of design parameters, including materials, geometry, fire detection and suppression, and evacuation, as well as design tradeoffs that may arise from combinations of several parameters.

Accordingly, there are many reasons to use fire hazard analysis to determine passenger train fire safety. However, further tests and assessment are considered necessary to evaluate the suitability of fire modeling and hazard analysis techniques for application to typical passenger train fire scenarios. Testing over a range of HRR will allow the evaluation of the ability of a predictive fire model to minimize but not eliminate the need for real-scale tests to assess overall passenger rail car fire performance. Limited real-scale tests may still be required to verify the accuracy of fire hazard analysis calculations, particularly when dramatically new designs or materials are incorporated into new passenger rail equipment.

2.2 OVERVIEW OF FIRE MODELING

Fire hazard analysis is in large part based on calculations of the fire environment using computer-based fire models. These models use computer programs which predict the environment in a structure that results from a specified fire in the structure. This section provides an overview of the theory behind the models, the inputs required by the models to perform the calculations, the typical results calculated by the models, and the limitations of the models.

Mitler, Jones, and Forney and Moss reviewed the underlying physics in several of the fire models in detail [13] [14] [15]. The models, they concluded, fall into two categories: those that start with the principles of conservation of mass, momentum, and energy; and those that utilize correlations from a particular experiment or series of experiments, used to understand the underlying relationships among a small set of parameters. In both cases, they found that errors arose when a mathematical shortcut was taken, a simplifying assumption made, or some important phenomenon was not included in a predictive model.

Once a mathematical representation of the underlying science has been developed, the conservation equations can be recast into predictive equations for temperature, smoke, and gas concentration, and are coded into a computer for solution. The environment in a fire consists of parameters that are constantly changing with time. Therefore, the equations are often in the form of differential equations. A complete set of equations can compute the conditions produced by the fire at a given time in a specified volume of air. Referred to as a control volume, the model assumes that the predicted conditions within this volume are uniform at any time. Thus, the control volume has one temperature, smoke density, gas concentration, etc.

Models divide a space into different numbers of control volumes depending on the desired level of detail. The most common fire model, known as a zone model, generally uses two control volumes to describe a compartment – an upper layer and a lower layer (Figure 1). In the room with the fire, additional control volumes for the fire plume or the ceiling jet may be included to improve the accuracy of the prediction. The fire source (e.g., a seat assembly) is simply a source of heat and combustion products to the plume.

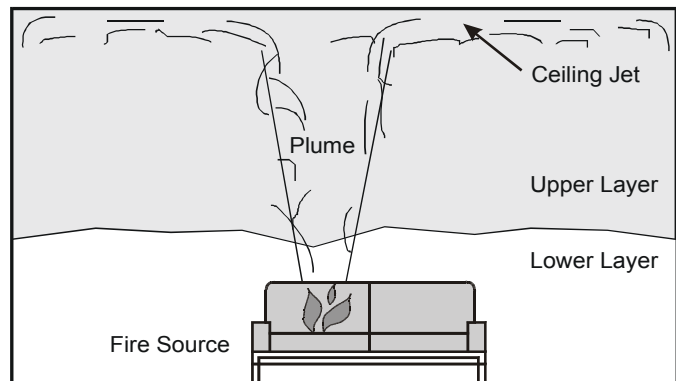

Figure 1. Zone Model

This two-layer approach has evolved from observation of such layering in real-scale fire experiments. Hot gases collect at the ceiling and fill the room from the top. While these experiments show some variation in conditions within the layer, they are small compared to the differences between the layers. Therefore, the zone model can produce a useful simulation under most conditions.

Other types of models include network models and computational fluid dynamics (CFD) models. The network models use one element per room and are used to predict conditions outside of the fire room, where temperatures are near ambient and layering does not occur. The CFD model goes to the other extreme, dividing the room into thousands or even hundreds of thousands of control volumes to provide detailed conditions within a compartment. These models have less dependence on experimental correlations than the simpler models and can provide detailed conditions throughout the compartments. However, they typically require far longer run times than zone models. They are used when highly detailed calculations are essential.

For the analyses in this study, the zone model, Consolidated Model of Fire and Smoke Transport (CFAST) was used [16]. This model, a newer version of the fire model used in HAZARD I, is widely used throughout the world, and has been subjected to extensive evaluations to study the accuracy of the model. The remainder of this section focuses on zone models in general and CFAST in particular.

2.2.1 Model Input

Zone models require three important inputs: 1) the geometry of the various compartments, 2) the size of the fire, and 3) the size of vents between each compartment. Compartment properties can subsequently affect the fire performance of a structure. Properties include wall, floor, and ceiling materials, combustible contents, and the subsequent performance characteristics of the materials and structural members upon exposure to a fire. Compartment geometry is generally limited to rectangular floor plans. More complex geometries are modeled as rectangular compartments with equivalent volume. While the number of compartments varies from model to model, simplifications by the model user can reduce the number of compartments analyzed. The fire is typically described by the burning rate (a HRR or pyrolysis rate) and heat of combustion. Often, the fire is specified as a simple t-squared design fire where the HRR is described as proportional to the square of the time from ignition. The specification of the vents is dependent upon the type of vent. If the vent is either a door or window, it requires input of the height of the bottom and top of the vent, the width of the opening, and whether or not there is a positive or negative wind exposure. Additionally, other parameters may be entered into the model such as species yields (CO, CO₂, soot, etc.), detection and suppression equipment locations, and exits.

2.2.2 Model Output

The specific output of a zone model varies between models. However, several important parameters summarize the fire environment and are common to most models. The HRR, species yields (including CO, CO₂, soot, etc.), and the pyrolysis rate all summarize the characteristics of the fire. The environment within each compartment includes the oxygen level, upper and lower layer temperatures, heat flux to various surfaces, optical density of the upper layer, calculation of detector and active suppression device operation, and tenability criteria.² A given geometry and fire combination will result in relative levels of

² A tenability criterion is an environmental condition deemed hazardous to human health such as elevated temperatures or toxic gases.

importance for differing criteria. Therefore, the measure of a parameter change can be readily ascertained by a zone model sensitivity analysis.

2.2.3 Limitations of Zone Fire Models

Fire modeling involves an interdisciplinary consideration of physics, chemistry, fluid mechanics, and heat transfer. In some areas, fundamental laws (conservation of mass, energy, and momentum) can be used, whereas empirical correlations or even “educated guesses” must be employed in others to bridge gaps in existing knowledge. The necessary approximations required by operational practicality result in the introduction of uncertainties in the results. The user should understand the inherent assumptions and limitations of the programs, and use these programs judiciously – including sensitivity analyses for the ranges of values for key parameters, in order to make estimates of these uncertainties. Limitations of zone fire models include:

- Zone fire models assume the environment in a compartment can be described by a small number (usually two) volumes or zones. Conditions are assumed to be uniform throughout each zone. Where detailed spatial information is required, the more detailed CFD models may be more appropriate. Limited mixing between layers is included in some zone models. For trains operating in a tunnel environment, this may be important [17].
- Nearly all zone fire models model the effects of a specified fire on the environment within a structure rather than the actual growth of a fire in the structure. Such a specified fire is usually based on small- or large-scale calorimetry tests of materials or assemblies. Additional phenomena, such as the interactions of hot compartment surfaces on the burning rates, are not modeled. For most materials, the consequences are small prior to the onset of flashover in a compartment. To account for the phenomenon not included, the HRR of the chosen scenario fire can be adjusted by the model user [18].
- Individual determinations can be made for various tenability criteria such as incapacitation and lethality from temperature and toxicity, or incapacitation from burns due to flux exposure. However, it is assumed that all of these effects are independent of one another.

2.3 QUANTITATIVE FIRE HAZARD ANALYSIS

Public fire safety is provided through a system of fire and construction codes and standards that are based on the judgment of experts in the field, and that incorporate test methods to measure the fire properties or performance of materials and products. For passenger train equipment,

these codes and standards prescribe the construction methods and materials considered acceptable. This system works to provide a reasonable level of safety to the public. However, prescriptive requirements may need revision as new materials or design and construction techniques are introduced. Quantitative tools for fire hazard analyses can provide ways of addressing such developments consistent with the intent of the requirements. The flexibility provided by these quantitative tools can help to enable the safe and rapid introduction of new technology by providing information on the likely impact on fire safety before a performance record is established through use. Similarly, these methods can be of value to material and component manufacturers in identifying the potential fire safety benefits of proposed design changes.

There are numerous highly interactive factors that must be considered in performing a quantitative fire hazard analysis. Figure 2 illustrates the elements and interactions that are considered in performing a quantitative fire hazard analysis. Experimental measurements of the burning behavior of materials of interest and details of the structure (e.g., a building or passenger rail car) in which they burn are needed to define the fire in terms of its release of energy and mass over time. The transport of this energy and mass through the structure is influenced by its geometry, the construction materials used, and the fire protection systems employed. The response of occupants and the consequences of the fire depend on when the occupants are notified, their physical capabilities, the evacuation occupant load, the decisions they make, and their susceptibility to the hazards to which they are exposed.

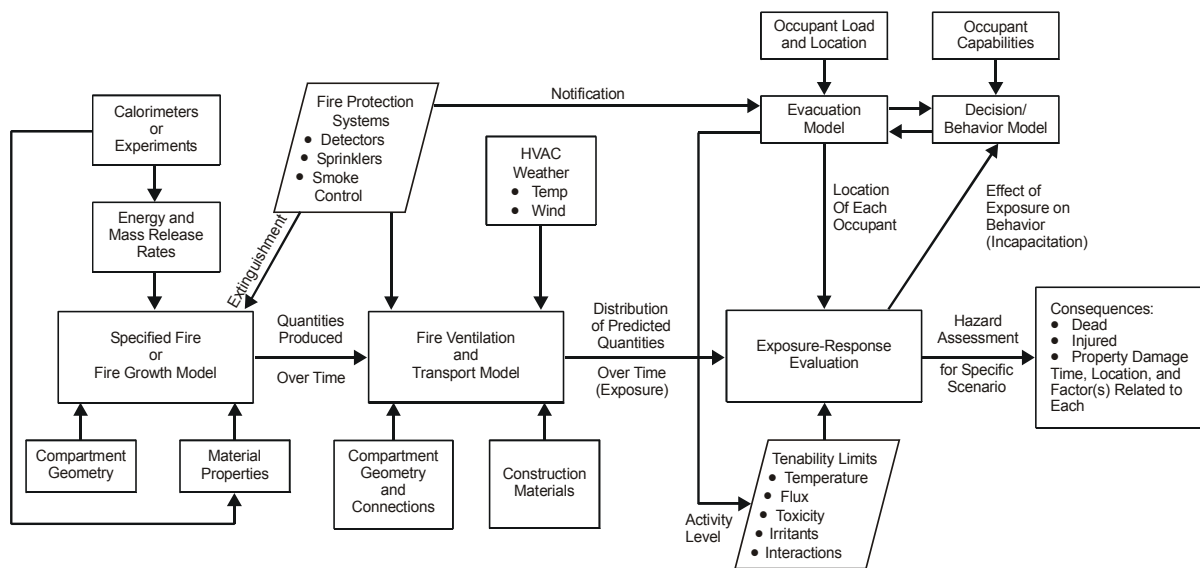

Figure 2. Major Component Interrelationships in a Fire Hazard Model

Tools for fire hazard analysis make it possible to evaluate material and component fire performance against a fire safety goal. For example, a goal of fire safety has always been to ensure the fire is contained until occupants can escape to a safe area. The problem is that it is difficult to keep the “smoke” contained. Quantitative hazard analysis allows the determination of the impact of smoke relative to the impact of other hazards of fire for a prescribed scenario. Having 3 minutes for safe escape when 10 minutes are needed would not meet the desired goal. Conversely, providing 30 minutes of protection when 10 are needed can lead to unacceptably high construction costs. A fire hazard analysis method can help prevent both types of problems from occurring. Quantitative fire hazard analysis techniques also have the potential of providing significant cost savings. Alternative protection strategies can be studied within the hazard analysis framework to give a benefit-cost relation for each. In addition, measures can be evaluated as a system with interactions, including the impact of both structure and contents. Providing these alternatives promotes the design flexibility that can reduce redundancies and cost without sacrificing safety. Quantitative hazard analysis can therefore be a complement to prescriptive codes and standards.

The occupancies and scenarios of interest to the user of a fire hazard assessment will depend on the purpose of the evaluation. For example, product manufacturers generally will not be concerned with a particular occupancy, but rather with the scenarios significantly involving their products in all the spaces in which they may be found. In practice, such an analysis may involve numerous individual evaluations for each scenario and space of interest. In contrast, the interest of fire investigators will be with a specific fire in a specific occupancy, since they are reconstructing an incident that has already occurred.

In 1989, NIST released the first version of the HAZARD Computer Model which implements this process [19]. HAZARD I is a complete methodology for assessing the hazard of unwanted fires in compartmented structures. The precedent of using a HAZARD I fire hazard analysis to establish a code requirement for a product has already been established. In 1990, the National Fire Protection Association (NFPA) Task Force on Contents and Furnishings adopted a change to the Life Safety Code chapter on hotels that limits HRR, based on the onset of flashover or other hazardous conditions [20]. Different HRR limits were required for sprinklered and non-sprinklered buildings, based on HAZARD I predictions for a typical hotel guest room.

NIST performed an example fire hazard analysis of a passenger rail car coach seat fire in 1997 [21]. That simple analysis concluded that a small ignition source (i.e., small trash bag with HRR of 50 kW) placed on a single seat did not lead to lethal conditions for 200 seconds since the

upper layer temperature was less than 38 °C (100 °F) and the door exits remained visible. To expand on that limited analysis, this study provides more detailed analyses for several fire scenarios using representative passenger rail car designs and interior materials.

For the analyses in this study, the CFAST zone model of the fire model HAZARD I was used. Since the egress model from HAZARD I is appropriate only for residential occupancies, other evacuation models were also considered. Tenability criteria taken from HAZARD I and the literature were combined with data from both the fire model and an appropriate egress model to evaluate egress time. While the baseline analyses used elevated temperature and smoke obscuration to determine time to untenable conditions, additional tenability criteria and their effect on the results of the baseline passenger rail coach car analysis are considered in Chapter 5.

2.4 APPLICATION OF FIRE HAZARD ANALYSIS TO PASSENGER RAIL CARS

The *Guide for Fire Hazard Assessment of Rail Transportation Vehicles (ASTM E-2061)* was recently published by ASTM [22]. That guide is intended to provide resources and references for the application of fire hazard analysis techniques to passenger rail cars, but does not provide a specific prescriptive standard or method. Part of the purpose of this study is to demonstrate the benefits and limitations of fire hazard analysis tools like HAZARD I and the ASTM guide when applied to specific passenger rail car designs.

Traditionally, fire hazard analysis techniques involve a four-step process for the evaluation of a material or components in a specific scenario: 1) define the context, 2) define the fire scenario, 3) calculate the hazard, and 4) evaluate the consequences [23]. For the analysis of passenger rail cars, this process limits the evaluation to the contribution of specific materials and components without providing an overall assessment of the fire performance of the entire system.

The procedure outlined above was therefore extended for this study to better reflect the minimum appropriate performance of the overall rail car system while maintaining the evaluation of a specific design compared against the required baseline. For such a systems-based analysis, the process is also conducted in four steps:

- Define passenger rail car performance objectives and design;
- Calculate passenger rail car fire performance;
- Evaluate specific passenger rail car fire scenarios; and
- Evaluate passenger car design suitability.

Steps 1 and 4 are largely subjective and depend on the expertise of the user. Step 2, the heart of fire hazard analysis, involves extensive use of computer software, and requires considerable expertise in fire safety practice. Step 2 uses a sequence of procedures implemented in computer software to calculate the development of hazardous conditions over time, calculate the time needed by occupants to escape under those conditions, and estimate the resulting effects on the rail car occupants, based on tenability criteria. In addition to evaluating the hazard resulting from specific products used in the design, the new procedure proposed in this interim report determines the worst-case fire which allows the overall passenger rail car system to meet chosen design criteria. Step 3 evaluates the specific fires that are likely to occur in the application. Step 4 compares the results of Steps 2 and 3 and evaluates the appropriateness of the calculations performed, as well as determines whether or not the proposed design meets the design goals established in Step 1. Table 1 shows each step in the hazard analysis process as tailored for passenger rail cars.

2.4.1 Step 1: Define Passenger Rail Car Performance Objectives and Design

Both the proposed performance objectives and passenger rail car design must be defined. Clear objectives must be specified for the minimum acceptable performance that must be met in the final design. This may be provided by the passenger railroad, authorities having jurisdiction, and by expert engineering judgment based upon the performance of the existing acceptable designs. For example, an objective may be to provide life safety for passengers and crew in the event of a fire or to minimize damage to property. Performance criteria are more specific and might include limits on temperature of materials, gas temperatures, smoke concentration or obscuration levels, concentration of toxic gases, or radiant heat flux levels.

The analysis requires a detailed understanding of the geometry (e.g., configuration) of the rail car system being considered. This will include the construction materials, sizes, and connections for all compartments, typical furnishings, and other design parameters that might impact the fire. Such parameters might include fire detection or suppression systems, ventilation systems, and emergency exits and procedures.

2.4.2 Step 2: Calculate Passenger Rail Car Fire Performance

The second step determines the response of the passenger rail car system to a range of chosen design fires. This response is expressed in the form of one or more fire performance graph(s) which present the calculated design criterion as a function of the size of the fire. In addition, the

Table 1. Passenger Rail Car Fire Hazard Analysis Steps

1. DEFINE PERFORMANCE OBJECTIVES AND PASSENGER RAIL CAR DESIGN

- Clearly define fire performance objectives.
- Determine the geometry of the application.
- Include other design parameters that might have an impact on a possible fire, such as a tunnel operating environment, material controls, fire detection and suppression, or other system procedures.

2. CALCULATE PASSENGER RAIL CAR FIRE PERFORMANCE

- Determine minimum acceptable performance criteria based on the rail car design.
- Establish standard design fires.
- Using predictive models and/or calculations, determine the fire performance of the proposed design for a range of design fires.
- Create a fire performance graph.

3. EVALUATE SPECIFIC PASSENGER RAIL CAR FIRE SCENARIOS

- Examine relevant fire incident experience with same/similar applications.
- Identify the likely role/involvement of application contents in fire.
- Ask which fires are most common / likely? most challenging?
- Quantify the burning behavior for chosen scenarios from available fire test data or appropriate small- and large-scale tests.

4. EVALUATE SUITABILITY OF PASSENGER RAIL CAR DESIGN

- Estimate through expert judgment, regulatory guidance and, when needed, complementary small- and large-scale tests the effects of unknowns not accounted for in the fire performance graphs.
 - Establish the sensitivity of the fire performance graph to known inputs.
 - Set appropriate design margins.
 - Determine the acceptability of the design.
-

minimum acceptable performance criteria are determined by calculation or specification. For example, a fire performance graph may show the available egress time as a function of the fire size in a rail car and the minimum acceptable performance criteria may be the time necessary for passengers and crew to safely evacuate the rail car. These criteria may be specified by the passenger railroad, authorities having jurisdiction, or by expert engineering judgment based upon the performance of the existing acceptable designs.

Once the detailed problem has been defined, this information is used as input to a computer fire model. The model predicts conditions within each compartment of the passenger rail car as a function of time. For this analysis, these conditions include temperature, hot gas layer position (typically termed “interface height”) and toxic gas concentrations, throughout the passenger rail

car. These conditions are used to calculate tenability within the car. Conditions are considered untenable when there is a threat to occupant life safety, evaluated as an elevated temperature, products of combustion exposure, or a combination of the two. The time at which conditions within the passenger rail car become untenable for each design fire are plotted as a function of the size of the design fire to produce a fire performance graph for each application.

The minimum acceptable performance criterion for the passenger rail car analysis is the time necessary for safe passenger and crew evacuation. This can be obtained from evacuation “fire drills” or calculated using techniques available in the literature. For the passenger rail car analysis, the egress time was calculated in three different ways:

- A network model developed by Hagiwara [24];
- The correlation contained within CFAST; and
- airEXODUS™ [25], a model incorporating occupant decisions during the evacuation.

The calculation of minimum necessary egress time, whether from a building or a passenger rail car, involves many assumptions. Three models were used in order to increase the confidence in the egress time calculation. It is important to remember that the calculated necessary egress time does not include panic, scattered luggage in a post-crash rail car, or bodily injury to persons prior to evacuation commencement. An appropriate design margin applied to the model time should account for such limitations. Typically, a safety factor of 2 is used as a design margin [26].

2.4.3 Step 3: Evaluate Specific Passenger Rail Car Fire Scenarios

Step 3 evaluates possible passenger rail car fire scenarios in order to place the fire performance curves in context and to allow the designer to adopt reasonable design margins in the final rail car design evaluation in Step 4. A significant amount of information relevant to scenario definition can be obtained from historical fire incident experience (see references [27] and [28]). Databases such as the National Fire Incident Reporting System (NFIRS) contain relevant passenger rail car data, normally segregated into specific categories [29].

Relevant data describing specific fires appropriate for the rail car application are defined and used as input to the same fire model used in Step 2. The results of these model calculations can be compared to the design fires used in Step 2 to define appropriate design margins for the analysis.

2.4.4 Step 4: Evaluate Suitability of Passenger Rail Car Design

Taking into account the results of the calculations, and using engineering judgment, experience, and requirements of regulatory authorities, an appropriate design margin is set and applied to the minimum acceptable criteria. If the worst-case passenger rail car fire scenarios are all less hazardous than the minimum criteria multiplied by the design safety factor, then the rail car design is said to be acceptable.

Finally, the results of any analysis should be challenged by the user's common sense and experience. Results that violate these should be questioned and resolved. Comparisons should be made to data from similar experiments or actual passenger train fires wherever possible. If such data are not available, it may be advisable to conduct verifying tests in situations where public safety is at risk.

Currently, passenger rail car fire performance is evaluated through prescriptive requirements based upon individual material tests. With the use of fire hazard analysis, it should be possible to ascertain the performance of rail car materials and components in the context of actual use. The results of such a hazard analysis should be a clear understanding of the role of materials, geometry, and other factors in the development of fire in the specific rail cars studied. By identifying when or if specific conditions are reached such that materials begin to contribute to the fire hazard, passenger railroads and rail car designers will have a better foundation on which to base appropriate rail car and system design. By showing the relative contribution of a particular design feature or material, it is possible to make a more realistic assessment of the necessity for specific rail car design requirements.

The outcome of the fire hazard analysis will be a statement of whether or not the passenger rail car design under consideration constitutes a threat above acceptable limits. Further analysis can ascertain whether or not compartmentalization, detection and suppression systems and/or other intervention strategies can further minimize the fire hazard.

2.5 RELATED U.S. FIRE SAFETY ANALYSIS STUDIES

In addition to the NIST Phase I interim report cited previously, several other related fire safety studies sponsored by the FRA, National Highway Traffic Safety Administration (NHTSA), and National Transportation Safety Board (NTSB) are summarized below. Selected assembly tests are discussed in more detail in Chapter 4 and Appendix A. The goal of the FRA-sponsored research program is to extend the research from these and other related rail car fire safety studies

[30] [31] [32] [33] [34] [35] [36] [37] [38] [39] which recommended the use of HRR-based test methods, incorporated with fire modeling and hazard analysis, to assess potential hazards under real fire conditions.

2.5.1 1993 FRA U.S. and European Passenger Train Fire Safety Comparison

The 1993 NIST study included a comprehensive evaluation of the U.S. and European approaches to passenger train fire safety [3]. French, German, British, and the International Union of Railways (UIC) fire performance requirements were reviewed to determine their comparability. In addition to material test methods, vehicle design, detection and suppression systems, and emergency egress were reviewed. Section 2.6 reviews the information available for the extensive European rail car fire testing and analysis research studies sponsored by the ERRI and others.

2.5.2 1996 NTSB-Sponsored Passenger Rail Car Material Fire Evaluation

Following the collision and fire involving an Amtrak intercity passenger train and a Maryland Area Rail Commuter train in 1996, the National Transportation Safety Board (NTSB) commissioned a study which evaluated the extent to which the rail car materials in those cars complied with the FRA guidelines for flammability and smoke emission [40]. Ceiling panel, window mask, seat cushion, and crash pad materials were tested according to the FRA-cited test methods and the Cone Calorimeter test method. The NTSB report for this accident questioned the usefulness of the FRA-cited tests in predicting the fire safety of the rail car interior since the criteria did not provide for the integrated use of the materials [41].

2.5.3 1984 FRA/Amtrak Study

The FRA funded an Amtrak fire safety study that was conducted in 1983 and published in 1984 [42]. That earlier study included a series of tests to assess the large-scale burning behavior of materials used for Amtrak passenger rail car interior furnishings. Small-scale tests and large-scale Furniture Calorimeter tests were conducted. The comparison of small-scale flammability and smoke emission test data with large-scale test data showed that the small-scale tests were able to adequately predict the effect of changes in materials within the same real-scale geometry. The relative fire performance of these materials (from lowest HRR to highest HRR) was consistent in mock-up tests (for a given geometry of the real-scale mock-up). However, when the geometry of the real-scale tests mock-up was changed, the chosen small-scale tests failed to

predict the effect of the changes. Cone Calorimeter, seat assembly, and real-scale mock-up test data were compared.

The Amtrak tests data represented the results of only a limited number of tests. The effects of changes in component materials, material interaction, and rail car geometry were identified as important issues requiring further study.

2.5.4 1990 NHTSA School Bus Study

In 1990, NHTSA sponsored an investigation of state-of-the-art seat materials that could be used for school buses [43] and to develop the data necessary for the agency's use in possible rulemaking actions to upgrade FMVSS 302 [44].

Small-scale tests (Cone Calorimeter, Lateral Ignition and Flame Spread Test [LIFT], and National Bureau of Standards (NBS) Toxicity Protocol) were performed on the materials. Real-scale assembly tests using a Furniture Calorimeter were conducted on single seat assemblies. Real-scale tests were performed using a simulated bus structure. Computer fire modeling was used in the school bus study to evaluate the development of hazardous conditions in a compartment.

The 1990 report concluded that small-scale tests alone were unable to provide a simple method for material selection that was consistent with all the real-scale test data. Like the 1984 Amtrak rail car study, small-scale and assembly tests of school bus seats could not account for the effects of varied geometries in actual bus interiors. A test protocol for seat assembly evaluation was proposed that combines enclosure fire testing (which provides measurement of HRR and gas concentrations) with a fire hazard analysis protocol to determine the time-to-untenable conditions in actual vehicle geometries. Under the proposed protocol, test seat assemblies would be rejected if untenable conditions developed in the test enclosure.

2.6 RELATED EUROPEAN PASSENGER TRAIN STUDIES

Several European countries have active programs to improve passenger train fire safety evaluation. A great deal of effort is being expended to relate small-scale and real-scale performance by the use of fire modeling. This work is being conducted by individual countries (France, Germany, Sweden, United Kingdom) and in coordinated activities under the sponsorship of the ERRI and the Commission for European Standardization (CEN).

The British Rail (BR) small-scale test program was targeted at developing a database of HRR data for all rail materials in current use [45]. BR's Cone Calorimeter work was supplemented by real-scale assembly tests in a Furniture Calorimeter and included seat assemblies, sidewall and ceiling panel assemblies, catering refuse bags and contents, plastic towel dispenser units, and vending machines. No other test method data are available for the materials. The Furniture Calorimeter testing uses the methods specified in the British Standards Institute (BSI) documents for the fire evaluation of mock-up upholstered furniture. These methods use small wood cribs as the ignition source. The British government's trend toward privatization of its rail industry has led to an increase in the rehabilitation of older equipment instead of the complete replacement of rolling stock. This has limited the availability of newer materials and assemblies available for testing.

BR has also conducted several real-scale test burns of existing coaches and sleeping cars. While much of this work has been performed for internal use, some tests have been performed in connection with the ERRI activities. All of these tests relate to rail car fires on open trackways.

Other real-scale fire tests of rail cars located in tunnels have been conducted as part of the Channel Tunnel safety work leading up to the operation of shuttle trains carrying passengers and motor vehicles between England and France [46].

In the process of testing representative materials using a Cone Calorimeter, the London Underground Limited (LUL) has selected an exposure of 50 kW/m² for 20 minutes as a suitable exposure for material evaluation consistent with testing exposures and fire experience in the United Kingdom [47].

In 1990, Göransson and Lundqvist studied seat flammability in buses and rail transit cars using material tests and real-scale tests [48]. All of the seats used high-resilient foam, covered with a variety of fabrics. Wall panels consisted of fabric-covered wood or metal panels. In the small-scale tests, the Cone Calorimeter was selected to provide ignition and HRR information. In real-scale tests, the maximum HRR of a seat assembly, about 200 kW, was not sufficient to ignite the panels or the ceiling "quickly" (unfortunately, "quickly" was not defined). However, ignition of adjacent seats was noted in real-scale mock-up tests.

In 1992, ERRI published a report that recommended supplementary studies be conducted to account for smoke opacity and toxicity hazards of materials [49]. Later in 1992, ERRI proposed

that computer model software be used to model half-scale and full-scale tests already carried out in order to compare computer results with actual results [50]. ERRI considered the use of the Cone Calorimeter to be the only small-scale apparatus suitable for providing useful data for computer modeling. A series of reports document the completion of ERRI rail coach tests [51] [52] [53] [54] [55] [56]. In a test application, ERRI used the HAZARD I model to simulate a fire in the British 3 m test cube and concluded that the use of the model to simulate fires in a railway vehicle was feasible. Additional Cone Calorimeter and Furniture Calorimeter tests were conducted and numerous model simulations of fires within passenger rail coaches were performed. The results of the simulations were primarily aimed at comparing the model prediction to full-scale experiments and evaluating the ability of the model to be used in a rail environment. Use of fire models to validate the design of a passenger rail car in terms of passenger evacuation was proposed.

Numerous international conferences have been held and a very large research project was conducted in Norway under the auspices of EUREKA (European Research Coordination Agency) by nine Western European nations [57]. A 1995 EUREKA test report reviewed 24 fire incidents over 20 years (1971-1991), and presented the results of a series of tests in a tunnel utilizing aluminum and steel-bodied German (DB) Inter-City and Inter-City Express rail cars. An extensive series of full-scale fire tests were conducted and HRR values were developed. Although the primary focus of these tests was the effect of a burning vehicle on the environment within the tunnel, the results provide guidance on the burning properties of passenger rail car materials appropriate for fire hazard analysis that can be compared to the data used for this interim report. In addition to HRR, information on gas concentrations and smoke emission are included for a range of European passenger rail and transit cars.

2.7 SUMMARY

Fire modeling and hazard analysis allow the evaluation of a range of fire safety design parameters, including material flammability, geometry, fire detection and suppression, evacuation, and tradeoffs in the design that may arise from combinations of the parameters. Fire hazard analysis is in large part based on calculations of the fire environment using computer-based fire models. These models use computer programs to quantitatively predict the environment in passenger rail car compartment zones that results from a specified fire in the car. Traditional fire hazard analysis procedures were extended for this study to better reflect the minimum appropriate baseline performance of the overall passenger rail car system while maintaining an evaluation of a specific design as compared to the baseline. To evaluate the fire

hazard of the baseline and alternative rail car designs, the analysis process is conducted in four steps:

- Define passenger rail car performance objectives and design;
- Calculate passenger rail car fire performance;
- Evaluate specific scenarios for passenger rail car designs; and
- Evaluate suitability of each passenger rail car design.

The analysis documented later in this report calculates the development of hazardous conditions over time, the time needed by occupants to evacuate a single level coach car, and bi-level dining and sleeping cars under those conditions, and estimates the resulting effects on the occupants, based on tenability criteria. In addition to evaluating the fire hazard resulting from specific materials used in the design, the procedure determines the worst-case passenger rail car fire which allows the overall system to meet chosen design criteria.

Application of this fire analysis approach to passenger rail cars is consistent with the results of ERFI and other European passenger rail car fire tests and analysis studies.

3. PASSENGER TRAIN DESIGN FIRES AND FIRE SCENARIOS

A design fire is a specific theoretical fire curve. The shape of the curve is generally realized by simple mathematical expressions to facilitate engineering analysis. For most engineering analyses, a simple design fire curve is sufficient, assuming that the general shape and magnitude of the design curve reasonably approximates the real fire expected in a given scenario. This section introduces the concept of the design fire curve and discusses potential fire scenarios in the context of passenger trains. Finally, HRR data from assembly tests of passenger rail car materials conducted for this study are discussed. Combining realistic test data and probable fire scenarios yields confidence that a chosen design fire will ultimately approximate reality in the subsequent engineering analysis.

3.1 DESIGN FIRES

An idealized fire curve is shown in Figure 3. It can be characterized in terms of four distinct regimes: initiation to sustained ignition, growth, steady burning, and decay.

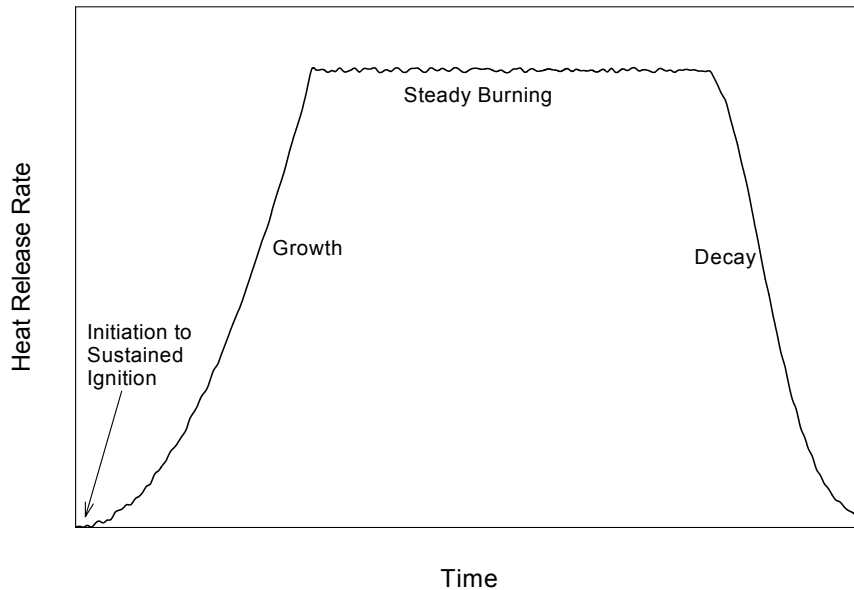

Figure 3. An Idealized Compartment Fire Showing Fire Growth, Steady Burning, and Decay

The first step in development of a growing fire is initiation. For design fires, the assumption is that a large enough ignition source exists to develop sustained burning. Upon achievement of sustained burning, the growth phase of the fire curve begins.

In 1972, Heskestad [58] proposed that, during the growth phase, fires grow according to a power law relation, expressed mathematically as:

$$\dot{q} = \alpha t^n$$

where \dot{q} is the heat release rate (kW), α is the fire intensity coefficient (kW/sⁿ), t is time (s), and n is a power chosen to best represent the chosen experimental data. Later, it was shown that for most flaming fires, n is equal to 2. This so-called “t-squared” growth rate was an excellent representation [59]. Three specific t-squared fires labeled slow, medium, and fast, with fire intensity coefficients (α), such that the respective fires reached 1 MW (1000 BTU/s) in 600 s, 300 s, and 150 s, were proposed for fire detection system design [60]. Later, these specific growth curves and a fourth called "Ultra-fast" [61] which reaches 1 MW in 75 seconds, gained favor in general fire protection applications.³ These four specific fire growth curves have been incorporated into design methods such as those used for fire detection system design (*National Fire Alarm Code* [62]). They are also referenced as appropriate design fires for performing alternative design analyses [63]. Figure 4 shows some typical fires in relation to the four fire growth curves.

During development, the fire eventually reaches a steady burning, or fully developed phase. This may be at a pre-flashover⁴ or a post-flashover level, and may be determined either by fuel or ventilation conditions. Finally, the burning rate declines as the fuel is exhausted. This decline is often assumed to occur at the point at which 20 percent of the original fuel is left. The decline is assumed to follow a t-squared decay. While these are assumptions, they are technically reasonable.

³ For historical reasons, fire growth rates are expressed in terms of the time to reach 1 MW, taken as 1055 kW = 1000 BTU/s HRR. As a ‘rule of thumb,’ a 1 MW fire is approximately equal to a small sofa fully involved in flames. For comparison, a small burning trash can results in approximately 40 kW.

⁴ Flashover is defined as the transition between the pre-flashover fire that burns as it would in the open but gradually becomes influenced by energy feedback from its surroundings. This increase in energy eventually leads to a rapid spread of fire to all combustibles in the compartment..

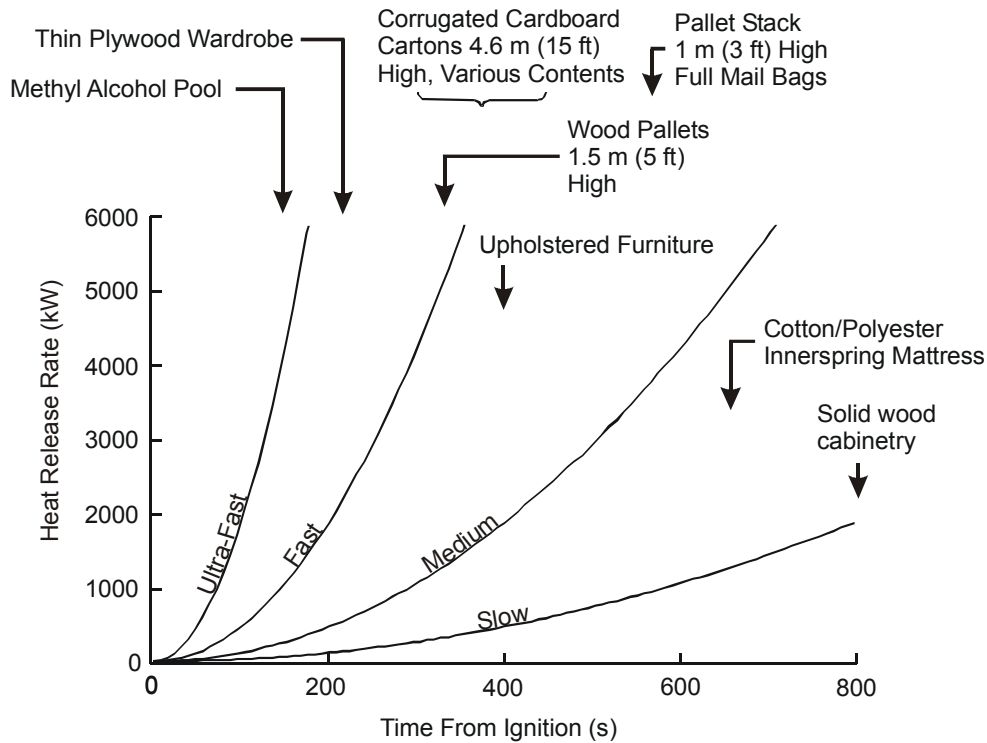

Figure 4. T-Squared Fire Growth Curves Used to Approximate Fire Growth in Most Fuels

Of course, if a suppression system is present, this decay will proceed as the fire is extinguished. A simple assumption is that the fire immediately goes out, but this is not conservative. A 1992 NIST study documents an exponential diminution in burning rate under the application of water from a sprinkler [64]. For all fires studied after sprinkler activation, the HRR can be represented as a worst-case by exponential decay, shown as the diagonal line on Figure 5. This decay model assumes that the fire is not large enough to overwhelm the sprinklers. Since the combustion efficiency is affected by the application of water, the use of soot and gas yield values that are appropriate for post-flashover burning would represent the conservative approach in the absence of experimental data.

Not all portions of an idealized fire are of interest. Selection of the critical criteria within the context of other input parameters often dictates the extent to which the fire curve must be developed. For example, if the primary concern is to prevent flashover, the curve must be developed for fire initiation and growth. Depending on the size of the compartment and the severity of the fire growth coefficient, the fire may or may not develop steady burning and decay phases prior to the room achieving flashover. A small compartment with a large fire may reach flashover during the growth phase, while a large compartment with a relatively small fire may

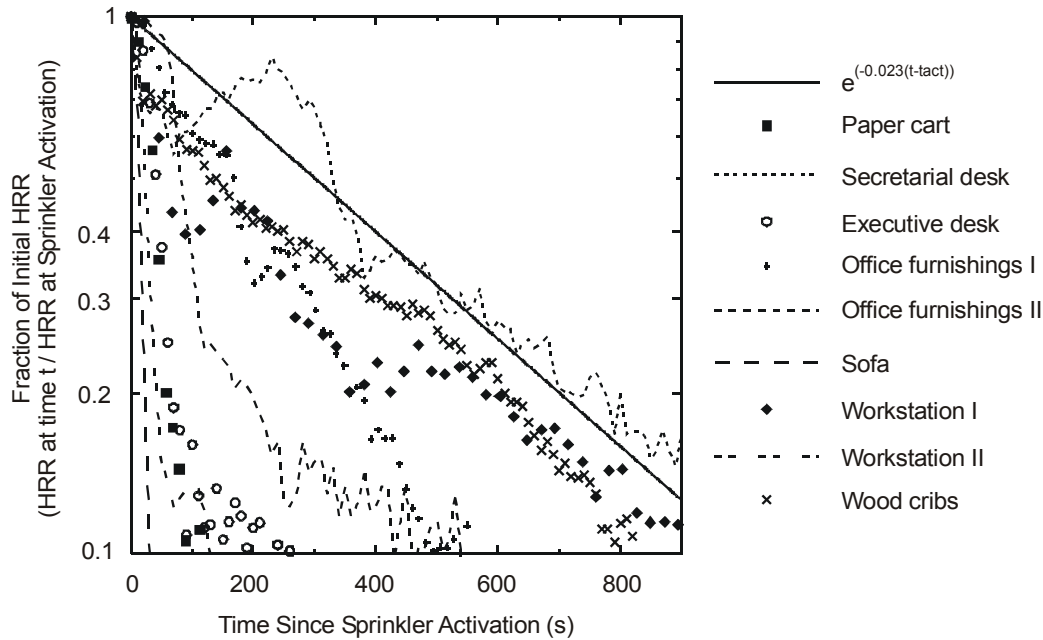

Figure 5. Fire Extinguishment Using Sprinklers Represented by HRR Exponential Decay

never reach flashover. The same process of fire curve development is true for other critical criteria, including tenability, structural collapse, or property protection.

It is important to note that fires may be described by shapes other than the t-squared fire. T-squared fires are most commonly used and fit the qualitative understanding of fire development most accurately. As a fire in the incipient stages propagates from a point source, the area involved in the fire increases with the square of the radius from the propagation front to the source. Again, this was observed experimentally by Heskestad. Since the primary focus of the passenger rail car fire hazard analyses is passenger and crew safety during evacuation, the early stages of fire growth are of most interest. T-squared fires provide an appropriate model for these early stages of the fire.

3.2 PASSENGER TRAIN FIRE SCENARIOS

This section describes fire scenarios applicable to passenger rail cars. The first step to scenario development is to examine passenger train fire historical data. The following section examines the cause and effect of recent fire-related accidents on passenger rail cars. Finally, the passenger rail cars scenarios germane to a fire hazard analysis will be characterized.

3.2.1 Recent Major Passenger Train Fires

U.S. passenger train accidents involving major fires occurred near Bourbonnais, Illinois in 1999 [65], Silver Spring, Maryland in 1996 [66], and Mobile, Alabama in 1993 [67]. The 1999 accident occurred when an Amtrak intercity train struck a truck at a grade crossing. Leaking fuel from one of the locomotives ignited and engulfed the center of a sleeping car where all 11 passenger deaths occurred. Autopsies showed that four of the victims died due to fire, one died from carbon monoxide poisoning, and six died from physical injuries. FRA, Volpe, and NIST staff later inspected the sleeping car and noted that the fire had not spread to the rear half of the car. In the 1996 accident, three train crew and nine passenger deaths were caused by fire when a Maryland Area Rail Commuter (MARC) train and an Amtrak train collided; 26 passengers were injured. The NTSB investigation noted that some MARC rail car interior materials did not meet minimum recommended performance levels for flammability and smoke emission. The 1993 accident occurred when an Amtrak train hit a misaligned bridge. Forty-two Amtrak passengers and five train crew died and 173 persons were injured; two crew members died of smoke inhalation.

A 1982 Amtrak train fire in Gibson, California led to two passenger deaths due to “fire and smoke” and two serious passenger injuries; numerous passengers and crew were also treated for smoke inhalation. The NTSB investigation determined that the probable cause of the fire was a discarded cigarette in a sleeping compartment seat cushion. Several areas of concern were identified by the NTSB, including materials, fire detection, interior arrangement (e.g., narrow hallways, door operation), intra-train communications equipment, crew training in ventilation control, emergency lighting, rescue personnel emergency access, and passenger evacuation [68].

Recently, two major passenger train collisions that occurred at Ladbroke Grove Junction, Great Britain on October 5, 1999, and Aasta, Norway on January 4, 2000 resulted in fires caused by ruptured fuel tanks [69][70]. However, only 3 of the 33 persons killed in the British accident died from the fire. While 19 persons were killed and 30 injured in the Norwegian accident, the number of fire-related casualties is not available.

Several other British Rail train fires have resulted in casualties. A 1995 passenger train fire resulted from a ruptured locomotive fuel tank near Maidenhead, England. One person was killed by a passing train when he exited the InterCity Express train to escape the fire. Five others were injured from smoke inhalation or other unrelated injuries. Recommendations were made to improve fuel tank integrity, toilet plumbing material fire resistance, communications, and

emergency equipment [71][72]. A 1983 British Rail train fire severely damaged two coach cars along half their length. The stated cause of the fire was a discarded cigarette in a "foam-type gangway unit," that spread along the roof line. Recommendations were made to redesign the car roofs and evacuation instructions [73]. Finally, a 1978 fire in a British sleeping car led to 11 passenger deaths and injuries. Ignition of soiled bed linens stored next to an electric heater resulted in the complete loss of one sleeping car and heavy smoke damage to a second. Emergency egress, smoke detection, material flammability, heater design, and crew training were identified as important issues in that fire [74].

In 1996, a "shuttle" train fire occurred in the Channel Tunnel between England and France. The train carried 200 trucks. Two train crew members, truck drivers, and other passengers were riding in a separate coach. Although everyone was evacuated uninjured, several rail shuttle and truck cars were destroyed and the tunnel was severely damaged. Among the issues identified as important in the investigation report were fire detection, communications, and emergency evacuation [75].

In 1994, a VIA Canada passenger train fire occurred in Brighton, Ontario that injured 46 people, most while they were evacuating the train. The fire, caused by the ignition of leaking locomotive fuel, destroyed the train club car and extensively damaged a coach. Fuel tank integrity and emergency evacuation were identified as safety concerns [76].

3.2.2 U.S. Passenger Train Fire Data

Railroads are required to report accidents and incidents to the FRA on a monthly basis. The type of accident or incident is determined by the first event of the incident. The FRA database for the time period from January 1985 through December 1998 was reviewed and indicated reports for 156 accidents/incidents listing a fire/violent rupture or explosion-detonation as the first event. The FRA data indicated that only three occurrences (2 percent) were caused by ignition sources in passenger compartments. However, only those fire/smoke-related events that were reported to FRA in a manner that identified such conditions are included in this total. It should be noted that when a fire occurs after or due to the first event, as it may following a collision or derailment, the type of accident/incident is listed as a collision or derailment and not a fire. Therefore, the FRA data may not include other fire or smoke-related incidents. Also, a number of fires that could have occurred are not included in the FRA database because they did not result in property damages that exceed \$6600. Accordingly, the FRA data were of limited value in constructing fire scenarios due to the lack of detail for individual passenger train fires.

A review of the previously-cited NFPA NFIRS data base revealed that an average of 71 fires per year involving U.S. passenger rail cars occurred from 1986 to 1997 [29]. Electrical wire and cable, seats, plastics, and fabrics or textiles were the materials first ignited in the majority of fires. Half of the fires were caused by some form of mechanical failure or malfunction.

NFPA data exist only for those fire-related accidents that were reported to fire departments. To the extent that certain fire-related accidents/incidents were managed successfully by rail personnel and/or passengers without having to notify fire departments, these events do not appear in the NFPA report. Although it is likely that the more significant passenger train fires required assistance from fire departments, it is also possible that smaller fires that resulted in injuries were controlled effectively and efficiently by onboard passenger and/or crew members using fire extinguishers. Therefore, NFPA data does not reflect the actual number of fires and related casualties that may have occurred. In addition, it is not usually possible to obtain specific local fire department reports. Therefore, while the NFIRS data do indicate trends, it is of limited use in constructing scenarios due to lack of detail for individual passenger train fires.

Fires involving passenger trains are relatively uncommon events. Thus, it would be inappropriate to select fire scenarios solely based upon the historical fire performance of passenger cars. It is the fire that has never occurred that is potentially the most dangerous. Still, some recurring events are evident in the fire incidents reviewed:

- Fires involving incidental materials in close proximity to interior furnishings have led to significant fires in passenger rail cars. Possible ignition sources in these fire incidents range from discarded cigarettes to hundreds of gallons of spilled diesel fuel.
- Passenger egress and emergency response have been identified as significant issues in several accidents. Thus, material fire performance is not the only issue that should be addressed for passenger rail car fire safety.

3.2.3 Interior Fire Scenarios

In addition to electrical-related fires, there are several possible locations for an interior ignition source in a passenger train. These include:

- on the floor;
- on the floor - beneath a seat, mattress, or table;

- on a seat, mattress, or table;
- in a trash container; or
- on a luggage rack.

In these locations, the first item ignited by the ignition source will be either the wall or ceiling, or the seat cushions or mattresses. Probable flame spread patterns can be postulated. If the ignition source is on the floor below the aisle seat or mattress, there are two possible modes of flame spread. One is along the floor covering and the other is along the cushion or mattress. Initial flame spread along the floor covering (of the type in current use) is not probable, based on considerable real-scale testing in transit vehicles [32][33][34], and actual fire incidents. This would be true even for moderate ignition sources (e.g., 0.5 kg [1.1 lb] of newsprint). Flame spread on typical seat cushions and mattresses would both require significant ignition sources. At this point, the fire could grow in intensity until the back of the seat, adjacent seats, the ceiling, or the wall liners were ignited. Without actual testing, it is not possible to determine if adjacent seat assemblies would ignite prior to the ignition of the wall and ceiling liners. The composition of both the seat assemblies (or sleeping car mattress), and the wall or ceiling lining affect the relative contribution of each component to the total fire growth. In subway vehicle interior tests, the design of seat assemblies and wall linings were important factors in fire growth [32][33][34]. In tests of Amtrak vehicle interiors, carpeted wall and luggage racks were key to the fire growth for certain interior combinations [42]. In school bus seat tests, the composition of the seat was the primary factor in fire growth [43].

For floor ignition sources near the wall, primary fire growth would still be due to the seat cushions or mattress. However, since the fire source is closer to the wall, the wall liner could ignite at an earlier stage of fire development and contribute to the total evolution of heat and smoke.

For fires originating on a seat, mattress, or luggage rack, critical fire stages could be reached sooner in comparison to floor fires. For seats, there may be nearly simultaneous involvement of back and seat cushions. For mattresses and luggage, the adjacent wall lining could become involved. At a given stage of fire growth, sufficient feedback energy could exist to permit the lateral spread of the fire to areas adjacent to the original ignition source. From this point on, the growth and spread of the fire would resemble a floor ignition.

3.2.4 Exterior Fire Scenarios

A common area for fires to begin in a rail environment is under the car. In commuter rail and transit systems these fires involve the third rail power, propulsion, and braking systems. In conventional rail, hot wheels caused by problems with brakes or bearings are the source of most exterior fires. In addition, sub-floor fires are the most difficult to control because detection could come late in the fire development and suppression can be difficult. Therefore, consideration must also be given to the probable results of sub-floor ignitions. Above-ground failures that stall a train do not represent the same degree of risk to passengers and train crew that similar failures in tunnel environments do. However, scenarios can be described for sub-floor failures and their consequences. Critical parameters are:

- the location of the train at the time of detection;
- the condition of the train as a result of the failure; and
- the intensity of the fire.

While the first two items determine the nature of the reaction that the passenger train system operator or emergency response personnel must initiate, the third determines the effective time available for evacuation and suppression. The fire endurance of the floor assembly becomes critical. If, at the time of detection, a sub-floor fire has spread over all areas of the floor assembly, the floor will fail sooner than if a fire is detected at a much earlier stage of development. It should be noted that the FRA requires floor assemblies to meet the fire endurance requirements of ASTM E-119 [77] for a minimum of at least 15 minutes and at twice the maximum time period it takes for the train to stop and then evacuate the passengers to a safe area.

Modeling of the exterior fire impact upon rail car passengers and train crew is beyond the capabilities of computer models or other computational methods. Therefore, the focus of the fire scenario development for this study is on interior fire scenarios.

3.2.5 Fire Scenario Development

The review of passenger train fire statistics and discussions with staff from passenger railroad operators, vehicle manufacturers, and material suppliers identified several representative interior fire scenarios. Each potential fire scenario includes an ignition source and a growth site. These include:

- an ignition under a coach seat by a small source (crumpled newspaper);
- fire in a trash bag placed on a coach seat or in a sleeping compartment;
- overheated equipment (motor, pump, battery failure) in a sleeping car; and
- a Sterno can igniting a tablecloth in a dining or lounge car.

These scenarios are consistent with past passenger train fires. Smaller ignition sources are evident in the data, but largely in older fire incidents. These scenarios are also consistent with those described in the ASTM rail assessment guide (ASTM E-2061) [22]. Like that guide, this study describes several specific fire scenarios that should be included in a fire hazard analysis, including the ignition of seats, trash fires, and sleeping car bedding fires. The use of the FRA-cited requirements by passenger railroads to evaluate rail car materials has been successful in preventing small ignition sources from causing major fires. However, “intermediate” fires could pose a significant and reasonable fire threat for passenger trains.

The ASTM rail assessment guide also includes additional scenarios for ignition outside the rail car, including spilled diesel fuel. Extremely large ignition sources such as fuel-fed pool fires are considered beyond the scope of this report. A 1996 report sponsored by the NTSB described the role of atomized diesel fuel in the MARC Silver Spring train derailment and fire [78]. An atomized diesel spray fire was investigated where large amounts of diesel fuel burned in the open air, pooled on super-saturated materials, as well as combined with the materials. The report estimated that the diesel fuel contribution to the total heat released in the fire was approximately 10 times the contribution of the train interior materials. Thus, with large amounts of excess fuel, the fuel controls the heat released in the fire.

NIST later conducted small-scale tests evaluating the relationship between train interior material, diesel fuel, and HRR [79]. NIST evaluated materials with a diesel exposure ranging from no diesel fuel present to an amount that would saturate the materials. The diesel fuel was not burned in a pooled or atomized manner. For the smaller fuel amounts relative to the material amounts, the test results indicated that material characteristics, such as the material’s ability to absorb the fuel, appear to determine the HRR behavior of the fuel/material combination. Still, the HRR of diesel fuel was found to be 1.5 to 8 times the HRR of the materials alone, reasonably consistent with the NTSB diesel fuel study.

3.3 COMBINING DESIGN AND SCENARIO FIRES

The challenge in a fire hazard analysis is to merge the computational ease of a design fire with the reality of the fire scenarios that have been developed. This is more easily achieved when examined in the context of the fire performance curve. This curve defines the range of design fires for a specific fire location in a given passenger rail car. The chosen fire scenario can then be incorporated into the fire performance curve in order to see where along the fire performance curve the scenario exists. This approach has several distinct advantages. First, the scenario can be viewed in a more global context than would otherwise be available by using a single data point. The location of the scenario with respect to the critical criteria can be examined. Secondly, the sensitivity of the fire scenario to input assumptions and varying parameters can be examined, particularly in the context of impact upon critical criteria. Finally, the fire scenario can be bounded by the choice of design fire. The design fire will demonstrate fires both more and less severe than the chosen scenario, which provides a more complete “picture” of the range of fires to which the passenger rail car may be exposed. Section 4.2 discusses the fire performance curve in more detail.

3.4 RAIL CAR MATERIAL ASSEMBLY TEST RESULTS

To aid in the development of realistic scenario fires for use in the fire hazard analysis conducted for this study, large-scale Furniture Calorimeter tests were conducted on real-scale assemblies of rail car materials currently used in intercity passenger train service. Like the small-scale Cone Calorimeter, the primary measurement from this large-scale test is the HRR of the burning assembly sample when exposed to an ignition source.

3.4.1 Test Results

Figures 6 through 11 illustrate representative real-scale tests which included seat, bed, wall, and ceiling carpet, window drape/privacy curtain, and window assemblies. Appendix A contains further test details relating to ignition sources used, test time periods, and resulting data. Table 2 summarizes the test results. Total peak HRR ranged from 30 kW to 920 kW (HRR data numbers in this chapter are rounded, see Appendix A for unrounded data), including any contribution from the ignition sources used. After subtracting the HRR of the ignition source, these values ranged from 15 kW to 800 kW. These data will be used along with the Phase I Cone Calorimeter results to provide specific scenario fires for the fire hazard analyses conducted for the coach, dining, and sleeping car designs (see Chapter 4).



(a) Before test



(b) During test



(c) After test

Figure 6. Trash Bag Test/Gas Sand Burner Ignition Source



(a) Before test



(b) During test



(c) After test

Figure 7. Seat Assembly Test - TB-133 Ignition Source

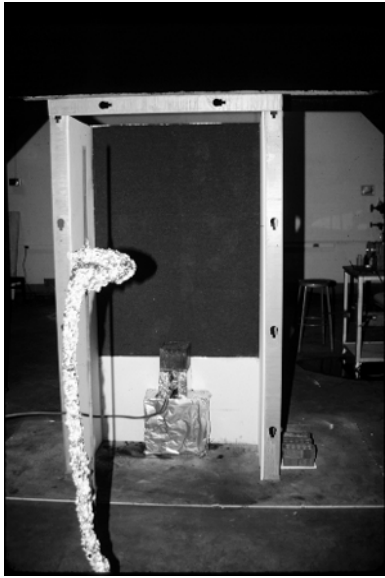

(a) Before test



(b) During test



(c) After test

Figure 8. Wall Carpet Assembly Test - Gas Sand Burner Ignition Source



(a) Before test



(b) During test



(c) After test

Figure 9. Window Drape Assembly Test (Extended) - Gas Sand Burner Ignition Source



(a) Before test



(b) During test



(c) After test

Figure 10. Wall and Window Assembly Test - Gas Sand Burner Ignition Source



(a) Before test



(b) During test



(c) After test

Figure 11. Window and Drrape Assembly Test - Trash Bag / Gas Sand Burner Ignition Source

Table 2. Peak HRR Measured During Furniture Calorimeter Assembly Tests

COMPONENT/MATERIAL TEST ASSEMBLY	IGNITION SOURCE (kW)	RANGE OF PEAK HRR* (kW)	NET PEAK HRR (kW)
Trash bags ranging in mass from 1.8 kg to 9.5 kg (4 lb to 21 lb)	25	55 – 285 **	30 – 260**
Coach seat assemblies (foam cushion, wool/nylon upholstery, PVC/acrylic seat shroud)	17 – 200	30 – 490	15 – 290
Lower bed with bedding and pillow	200	760 – 840	550– 640
Upper and lower beds with bedding and pillow	200	920	720
Wall carpet on a wall or a wall and ceiling, wool	50	330 – 850	290 – 800
Window drape/door privacy curtain assemblies, wool/nylon	25	70 – 200	40 – 170
Wall/window assemblies, FRP and polycarbonate	50 – 200	130 – 450	80 – 250

* Includes the contribution of the ignition source.

** Data is rounded. See Appendix A for unrounded data.

Trash bags taken from overnight, intercity train service were also characterized as a representative severe ignition source that could be present. The actual trash bag peak HRR from an Amtrak overnight train ranged from 55 to 285 kW. Heavier and more densely packed trash bags had lower HRR values than lighter bags since the dense packing prevents the heavier bags from burning completely. A newspaper-filled trash bag representative of the lighter trash-filled bags used as the ignition source for many of the assembly tests had a peak HRR of 200 ± 35 kW based on one standard deviation.

In the assembly tests, the HRR of seat, bed, wall, and ceiling carpet, window drape/privacy curtain, and window assemblies were characterized. Total peak HRR ranged from 30 kW for a seat assembly exposed to a 17 kW gas burner ignition source to 920 kW for a lower and upper bed assembly exposed to a newspaper-filled trash bag and gas burner ignition source.

All the assemblies tested were extremely resistant to ignition and required an initial fire source ranging from 17 to 200 kW to ignite. Materials and products that comply with the current FRA-cited fire tests and performance criteria are difficult to ignite, requiring ignition strengths of 2 to 10 times those used for similar materials and products found outside of the passenger rail car operating environment. Some of the materials do not contribute to the fire even with these ignition sources. Like the 1983 tests conducted on real-scale mock-ups of Amtrak coach cars, wall carpet and wall/window assemblies are seen as the most important materials for fire growth.

These assemblies are typical of intercity passenger rail cars. While commuter rail cars or rail transit vehicles may have different levels of furnishings, results for some of the assemblies (such as the seat assemblies) may be appropriate for these applications as well. Since the focus of this study is primarily passenger rail car interior design, all of these results apply to interior ignition scenarios. Exterior ignition sources, which may be important in some environments, particularly in the design of tunnel ventilation systems, were not considered. Such scenarios have been considered elsewhere [80].

3.4.2 Test Result Uncertainty

Uncertainty in real-scale fire test results come from several sources: random uncertainty in the actual measurements taken during the tests, random variation in the burning behavior of materials in the tests, and systematic variation in the tests due to measurement techniques, geometry, or other effects.

Gas burners provide a demonstration of the repeatability of real-scale fire tests with a known and controllable fire source. These provide a measure of the random uncertainty inherent in the measurements collected during the tests. For computer-controlled t-squared gas burner tests, variation in the burning behavior of materials in the test is small, averaging ± 15 kW for fire sizes up to 1 MW (2 percent). For the assembly tests, these uncertainties are harder to judge since replicate tests are usually impractical. From tests of the trash bag ignition source, measured uncertainty is approximately ± 35 kW expressed as one standard deviation for an average peak fire size of 200 kW (17 percent). It is expected that the uncertainty for the fire growth and spread tests is bounded by these two representative values of 2 percent to 17 percent.

3.5 SUMMARY

Since the primary focus of the rail car analyses is passenger and crew safety during evacuation, the early stages of fire growth are of most interest. T-squared fires (slow, medium, fast, and ultra-fast) provide an appropriate form for these early stages of the fire and will be used for development of fire performance curves for the analyses in this report.

From the brief review of past fire incidents included in this report, fires involving passenger trains are relatively uncommon events. Therefore, it is not sufficient to select fire scenarios based solely upon historical fire performance. Additional information based on engineering analysis or expert judgment can aid in selection of appropriate fire scenarios.

Several representative fire scenarios have been identified from a review of fire incidents and discussions with passenger railroad operators, vehicle manufacturers, and material suppliers. Component material assemblies currently in use in intercity passenger train service were tested in a large-scale Furniture Calorimeter. Like the small-scale Cone Calorimeter, the primary measurement in this test is the HRR of the burning assembly when exposed to an ignition source. Trash bags taken from overnight passenger train service were considered to represent a severe ignition source which may be present on trains.

The results of the assembly tests showed:

- The net peak HRR from actual trash bags from an Amtrak overnight train ranged from 30 to 260 kW. Heavier and more densely packed trash bags had lower peak HRR values than lighter bags.
- All the assemblies tested were extremely resistant to ignition. They required an ignition source ranging from 17 to 200 kW to ignite. Some of the materials did not contribute to the HRR of the fire even with the largest ignition source.
- For the assembly tests, the HRR of seat, bed, wall and ceiling carpet, window drape and door privacy curtains, and wall/window assemblies were quantified. Total peak HRR ranged from 30 kW for a seat assembly exposed to a 17 kW gas burner ignition source to 920 kW for a lower and upper bed assembly exposed to a newspaper-filled trash bag ignition source. Although difficult to ignite, the wall carpeting and window glazing produce high HRR values once ignited.
- For the sleeping compartment economy bedroom tests, the small enclosed geometry allowed a much larger HRR to develop than for the seat assembly tests, although the materials are similar.

As in the 1983 tests conducted on real-scale mock-ups of Amtrak coach cars, wall carpet and wall/window assemblies, although slow to ignite, are seen as the most important materials for fire growth once ignited. In addition, the effect of geometry also noted in the Amtrak report is confirmed by the sleeping car compartment bed tests.

4. BASELINE PASSENGER RAIL CAR FIRE HAZARD ANALYSES

This chapter describes a detailed series of fire hazard analyses for the following three passenger rail car design examples:

- Single-level coach car, which consists largely of upright passenger seats arranged in rows. The coach car provides the simplest geometry, but with a higher passenger density than the other designs;
- Bi-level dining car, which consists of booth-style seats and tables for passenger dining, as well as a galley and serving area. The bi-level dining car provides a relatively simple geometry on each level of the car, but includes the added complexity of the two occupied levels; and
- Bi-level sleeping car, which contains numerous, compartmented sleeping rooms containing beds and seats. The bi-level sleeping car provides the most complex geometry, having multiple compartments and corridors on two levels.

These analyses include descriptions of the selected rail car designs and fire scenarios, and the step-by-step details of the analysis conducted. This chapter describes the baseline fire hazard analysis for a coach car following the four steps described in section 2.4. Results of additional baseline fire hazard analyses for bi-level sleeping and dining cars are also presented. Although these analyses are based on existing passenger rail car designs, the analyses are simple examples demonstrating the use of fire hazard analysis and should not be interpreted as an accurate performance of any particular existing car configuration or actual fire hazard.

4.1 STEP 1: DEFINE PASSENGER RAIL CAR PERFORMANCE OBJECTIVE AND DESIGN

Step 1 defines the acceptable passenger rail car performance objective and the proposed design detailing the coach car geometry, materials, and other design parameters that may affect fire safety. Goals for Step 1 are to:

- Clearly define fire performance objective.
- Determine the geometry of the rail car.
- Include other design parameters that might have an impact on a possible fire, such as materials, fire detection and suppression, evacuation, or other system procedures.

Details for the coach car analysis are presented below. Results of the analysis for the dining and sleeping cars are included in sections 4.5 and 4.6.

4.1.1 Fire Performance Objective

For this analysis, the overall concern is passenger and crew life safety. Specifically, the fire performance objective is that the coach car is designed, constructed, and maintained to protect passengers and crew from the effects of the initial fire development for the time necessary to reach a point of safety. To ensure life safety, the criterion used to judge acceptable performance of the objective is that all passengers and crew can evacuate the rail car without injury from heat or smoke inhalation to an adjacent car not involved in the fire. For the example analysis, it is assumed that egress is available only at one end of the car. Egress to the outside of the train, structural collapse of the rail cars, or other concerns are not addressed for this simple analysis, although they could be required in an actual analysis by the passenger railroad, car designer, or an authority having jurisdiction.

4.1.2 Coach Car Design and Geometry

The single-level coach car is the simplest design of the three passenger rail cars analyzed. The outside dimensions of the car are approximately 25.9 m (85 ft) long by 2.8 m (9.2 ft) wide by 4.6 m (15 ft) high. The seating capacity of the coach car is 72 people, although the seat arrangement can be designed to accommodate fewer people. The floor plan is shown in Figure 12. The compartments of interest for the hazard analysis are the main seating compartment, and the two transfer areas at either end of the car. Two toilet areas and several small storage spaces are at the car ends. Egress while the train is moving is provided by doors at each end leading to the adjacent cars, while egress from a stopped train is from two sets of side doors at each end of the car, opening to the outside of the train.

The schematic floor plan view in Figure 12 is the layout as simplified for analysis with the zone model CFAST. The main seating compartment is Compartment 1. The toilet areas are Compartments 2 and 4. The transfer areas for boarding, disembarking, and transferring to other cars are Compartments 5 and 7. The narrow hallways at the end of the main seating area are treated as separate compartments. Modeling them separately as Compartments 3 and 6 allows the narrow area to be modeled more accurately. Additionally, connections between the compartments and doorways are input into CFAST. Details of the compartment and vent sizes and other modeling inputs are included in Appendix B.

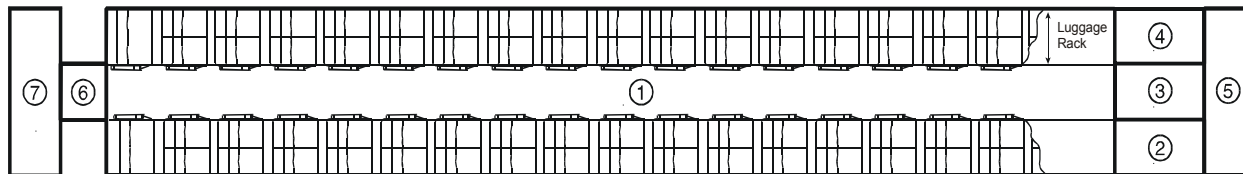

Figure 12. Floor Plan and Compartment Selection for Coach Car Fire Modeling

Initially, other design parameters such as the presence of active fire detection and suppression systems, passive fire protection design features, communication systems, or other system design features will not be considered part of this baseline analysis. Some of these features are considered in detail in section 5 as part of an analysis of the impact of possible design changes on overall system fire safety. Material controls as part of the overall fire safety design are considered in detail in the next section.

4.1.3 Important Materials

For the baseline analysis, it was assumed that all interior materials meet the 1989 FRA flammability and smoke emission requirements. Figure 13 illustrates typical intercity coach car interior furnishings. The materials that must be considered in this fire hazard analysis focus on the seating compartment. While the ignition source may vary, the method of flame spread and the relative importance of each material remain constant. The seat cushions and armrests are the most obvious component to consider as they represent the largest mass of combustible material. In the assembly tests described in section 3.4, the tray table dropped from the back of the seat in front of the fire, exposing a larger surface area to the growing fire. While the window is slow to ignite since most radiant energy from an exposure fire is transmitted through the material, it does have a fast growth rate once ignited and a significant peak HRR, one of the highest HRR of any material tested in the coach car. The wall carpet also exhibited delayed ignition and fast growth rates, attributable to melting of the adhesive that holds the wall lining to the wall surface. In addition, the wall carpet alone, without any backing pad or adhesive, has the highest HRR of any material in the coach car and represents a significant fuel load once ignited. Carpet is also used on the back of the seat assembly. When present, window drapes can be a source of vertical fire spread and could serve to increase the heat flux applied to the window and surrounding assemblies. The combination of the large combustible surface area and moderate HRR of the wall and ceiling linings represents a potentially serious contributor to a coach car fire.

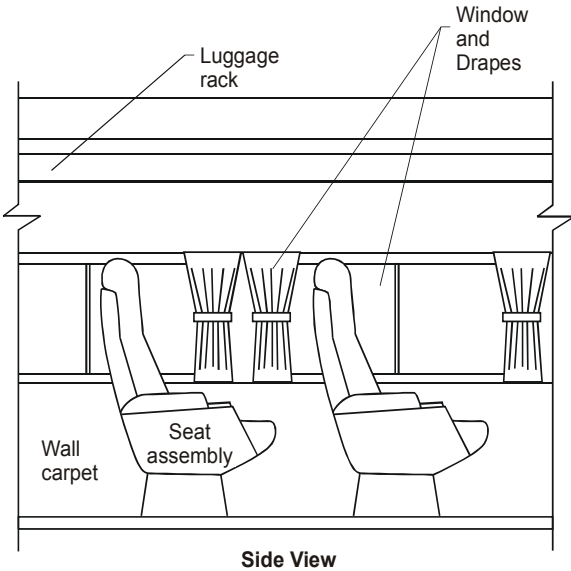

Figure 13. Typical Intercity Coach Car Interior Furnishings

Finally, the greatest unknown with respect to the materials in the coach car is baggage brought onto the train, presumably stored in either the overhead racks, underneath the seat in front of each passenger, or in the small luggage closet at one end of the car. Luggage can contain many materials, varying dramatically in composition, density, quantity, and flammability. Due to the high degree of variability and the lack of information to characterize luggage burning behavior, luggage was not considered in this analysis.

In order to quantify the potential contribution of the materials in the coach car, an approach similar to that included in NFPA 130 was utilized [81]. NFPA 130 includes a “hazard load analysis” method to provide a simplified and semi-quantitative analysis of the overall contribution to fire hazard of the materials used in interior furnishings. The hazard load analysis includes a “heat hazard load” based on HRR and a “smoke hazard load” based on smoke emission. The method recognizes HRR as the key variable in fire hazard and ties performance to real-scale testing results. However, summing peak HRR values for all exposed materials in a passenger rail car to obtain a hazard load assumes that every part of every material ignites and burns simultaneously. In reality, different propensities for ignition, flame spread, and HRR make this a highly conservative approach. Still, such an approach provides a relative ranking of materials for an initial screening.

Table 3 provides an example of how such a hazard load analysis would count component material contributions to a fire. For all materials in this analysis, 180 second average data values for both HRR and smoke extinction area (SEA) were derived from Cone Calorimeter tests conducted in Phase I of this research program [1]. Although the peak HRR values were used in the Phase I comparison to the FRA-cited test methods, the 180 second average values are more typically used when considering Cone Calorimeter values alone. They provide a representative assessment of average material performance. The heat hazard load is derived from multiplying the material in area (square meters) by the 180 second average HRR value; the smoke hazard load is derived from multiplying the heat hazard load by the 180 second average SEA value.

Table 3. Relative Contribution of Coach Car Material Components

COMPONENT MATERIAL	EXPOSED SURFACE AREA (m ² / ft ²)	180 SECOND AVERAGE HRR (kW/m ²)	HEAT HAZARD LOAD (kW)	180 SECOND AVERAGE SMOKE EXTINCTION AREA (SEA) (m ² /kg)	SMOKE HAZARD LOAD (kW/m ² •m ² /kg)
Wall Carpet, wool	40 / 431	395	15,800	510	8,058,000
Window, polycarbonate	60 / 646	250	15,000	1,000	15,000,000
Wall & Ceiling Lining, FRP/PVC	75 / 807	100	7,500	700	5,250,000
Seat Assembly, fabric cover, (foam cushion w/ inner liner)	144 / 1550	40	5,760	200	1,152,000
Tray Table, PVC/acrylic	60 / 646	95	5,700	200	2,793,000
Floor Carpet, nylon	50 / 538	95	4,750	350	1,662,500
Arm Rest, foam	10 / 108	430	4,300	780	3,354,000
Window Drape, wool/nylon	60 / 646	25	1,500	380	570,000

Table 3 shows that the most important materials to consider in the analysis are the wall carpet, windows, and wall and ceiling linings, which constitute nearly 65 percent of the heat hazard load and 75 percent of the smoke hazard load. The seat cushions and arm rests constitute nearly 20 percent of the heat hazard load and more than 10 percent of the smoke hazard load. The relative contribution of other materials is less than each of these materials. In general, materials which rank as important for heat hazard load also rank as important for smoke hazard load. However, as some materials may release large amounts of smoke at low temperatures, or vice-versa, smoke and HRR are only loosely correlated. It is important to note that while the material exposed surface area quantities are based on actual passenger rail car schematic plans, the values are only representative of the methodology and should not be interpreted as being an accurate representation of any particular existing coach car configuration or actual hazard load.

The heat and smoke hazard load calculations identify important materials to be included in the full analysis conducted in Steps 2 and 3. The material HRR and other properties are used in Step 3 to quantify the burning behavior of specific passenger rail car fire scenarios and place the fire performance curves developed in Step 2 in context.

4.2 STEP 2: CALCULATE PASSENGER RAIL CAR FIRE PERFORMANCE

For Step 2, the fire performance of the proposed design is determined by computer fire modeling of the coach car geometry using a range of standard design fires. Goals for Step 2 are to:

- Determine minimum acceptable performance criteria, based on the car design.
- Establish standard design fires.
- Use predictive models and/or calculations and determine the fire performance of the proposed design for a range of design fires.
- Create a fire performance graph.

Details of the analysis for the coach car are presented below in sections 4.2.1 through 4.2.4. Analysis results for the bi-level dining and sleeping cars are included in sections 4.5 and 4.6.

4.2.1 Minimum Acceptable Performance Criterion

For this analysis, the principal acceptance criterion is the minimum necessary egress time for a fully loaded passenger rail car assuming an orderly unimpaired evacuation. This minimum necessary egress time is compared to the available safe egress time during a fire. If the minimum necessary egress time is less than the time available for safe egress for all design fires, the design is considered acceptable.

The minimum necessary egress time is the time it takes for all persons to exit in the absence of a fire in the passenger rail car. The impact of the fire on the ability of passengers and crew to exit the car is ignored. Fire effects that may impact egress include elevated temperatures or smoke obscuration and can significantly extend egress time as persons perform activities, such as collecting belongings, investigating the fire, etc., other than simply exiting the car. For this analysis, the minimum necessary egress time is calculated three different ways: a network model developed by Hagiwara [24], the correlation contained within CFAST [16], and airEXODUS™, a model incorporating the decision making of the occupants [25]. Three models were used in order to increase the confidence in the egress time calculation. For each of the analyses, egress

was assumed to occur through one exit of an upright rail car. with coach seating for 72 persons, to an adjacent car not involved in the fire. For other analyses, egress outside the train could also be considered by calculating egress time from the end or side doors to the point of safety.

Table 4 shows the calculated minimum necessary egress time to exit the car of fire origin for the three methods. All three methods provide similar estimates of the necessary egress time, with an average of 88 ± 8 s, based on 1 standard deviation. The calculation of egress time, whether from a building or rail car, involves many assumptions.

Table 4. Calculated Egress Times for Coach Car

MODEL	CALCULATED EGRESS TIME (s)
Hagiwara	85
CFAST	97
airEXODUS™	82

It is important to note that this calculated necessary egress time does not include the rail car position (upright or overturned), impact of the fire on passengers and crew, panic, post-crash scattered luggage, or bodily injury to occupants prior to evacuation. The appropriate design safety factor applied to the model time should account for such limitations. Therefore, the calculated minimum necessary egress time should be considered the minimum time necessary for evacuation. Like the 90-second certification testing for aircraft, this minimum necessary egress time is simply a consistent point of comparison for different passenger rail car configurations and fire scenarios.

For each of the design fires, the available safe egress time, defined as a time that relates fire conditions to egress, is computed. This calculated available safe egress time is considered to be the time at which conditions at any point in the egress path reach values which would cause impaired egress (see sections 4.2.2.2 and 4.2.3).

4.2.2 Standard Design Fires

Chapter 3 discussed the concept of design fires in detail. In general, a design fire is a simple representation of fire growth from ignition, through growth, steady burning, and decay. Since the primary focus of the coach car analysis is passenger safety during evacuation, the early stages of fire growth are of most interest. T-squared fires provide an appropriate form for these early stages of the fire and will be used for this analysis.

4.2.2.1 T-Squared Design Fires

During the growth phase, fires can be reasonably represented by a power law relation, which is expressed as:

$$\dot{q} = \alpha t^n$$

where \dot{q} is the HRR (kW), α is the fire intensity coefficient (kW/sⁿ), t is time (s), and n is a power chosen to best represent the chosen experimental data. For most flaming fires, the so-called t-squared ($n = 2$) growth rate is an excellent representation. A set of specific t-squared fires labeled slow, medium, fast, and ultra-fast, with fire intensity coefficients (α), such that the fires reached 1 MW (1000 BTU/s) in 600 s, 300 s, 150 s, and 75 s, respectively are typically used. Chapter 3 includes additional discussion of t-squared fires. For use in hazard analysis calculations, these design fires must also include appropriately chosen gas species (e.g., smoke, etc.) release rates in addition to the HRR. For this study, the gas yields were obtained from Cone Calorimeter test results conducted as part of Phase I.

4.2.2.2 Impact of Acceptance Criteria on the Design Fires

There are at least two important criteria in the development of design fire scenarios that directly affect passenger rail car occupants. First, a “time to impaired evacuation” can be defined as the time at which occupants can no longer be assumed to be standing up and walking out of the rail car in an efficient manner because of conditions caused by the fire. This is because the upper layer is either too hot or optically dense and forces the occupant to bend over or crawl in order to exit the car. The criterion that dictates occupant behavior depends on the proximity to the fire. In the area of origin or in nearby compartments, heat may make the upper layer uncomfortable faster than smoke density affects visibility. At a location remote from the fire, optical density criteria will be more important than elevated temperature. Second, as conditions worsen, a “time to incapacitation” occurs when occupants cannot physically evacuate due to greater exposure to elevated temperature or toxic gases. The time at which untenable conditions either impair evacuation or occupants become incapacitated is determined by comparing selected criteria to the output of the CFAST fire model. For the analyses conducted in this study, the more conservative tenability criteria based on time to impaired evacuation were used:

- **Elevated temperature:** When a person is subjected to an upper layer (layer height less than or equal to 1.5 m (5 ft) and the average upper layer air temperature exceeds 65° C (150° F). These criteria are consistent with extensive literature [82]. Typically, temperature is most important in the compartment of fire origin [83].
- **Smoke obscuration:** Jin [84] suggests a reciprocal relationship between smoke and visibility distance, which follows:

$$k = 2/V$$

where k is the smoke extinction coefficient (m^{-1}) and V is the visibility distance (m). Purser [85] proposes a critical extinction coefficient of 1.2 m^{-1} , which corresponds to an optical density (OD) of 0.5 m^{-1} or a visibility distance of approximately 1.7 m (6 ft). The OD criteria is coupled with the interface height. An OD greater than or equal to 0.5 m^{-1} and an interface height less than or equal to 1 m (3.3 ft) was chosen. Typically, smoke and toxic gases are important in areas removed from the compartment of fire origin [84].

For each of the t-squared design fires evaluated, the CFAST model was used to calculate the time to untenable conditions based on elevated temperature and smoke obscuration for a range of design fires [86]. This model is an updated version of the fire model included in HAZARD I. Details of the inputs to the model are included in Appendix B. An available egress time longer than the minimum necessary egress time parameter for a design fire implies that all occupants would be able to evacuate from fires less than or equal to that design fire. Although the two simple criteria for tenability used in this study provide conservative values for the available safe egress time, other criteria are equally valid. Of course, it is appropriate to use the same criteria for multiple design analyses to ensure equivalent levels of safety for different designs. For this simple analysis, there was also no attempt to quantify impaired evacuation due to panic or other social or psychological effects. Section 5.4 discusses the impact of different tenability criteria based on convected heat and toxic gases in more detail.

4.2.3 Design Fire Modeling

To develop a fire performance graph for the coach rail car, the t-squared fires described earlier were used. Because life safety is the performance objective, the fires are allowed to grow until flashover or full compartment involvement was achieved. Since untenable conditions throughout the coach car would be reached prior to flashover, there is no need to calculate past flashover. For each fire, the time to impaired evacuation was determined. For this analysis, that time occurs when the temperature at a height of 1.5 m (5 ft) is greater than 65°C (150°F). For other cars or other applications with multiple compartments, additional calculations may be necessary. Untenable conditions may not be reached in a remote compartment until after the initial compartment has flashed over.

Figure 14 shows a sample of the output of the model showing the predicted conditions in the main passenger area of the coach car for a medium t-squared fire. The data presented in these graphs were used to calculate the fire performance graph for the coach car. For the model calculations, the criterion is an upper layer temperature of at least 65°C (150°F) at a layer height of less than 1.5 m (5 ft). Figure 14 shows that the upper layer temperature rises above 65°C (150°F) at 114 s. At this point, the layer height is below 1 m (3.3 ft). Since the smoke obscuration reaches a value of 0.5 m⁻¹ and a layer height of 1 m (3.3 ft) or less at a later time (184 s), the temperature criterion is used for the impaired evacuation time. Thus, the time to impaired evacuation, i.e., minimum available egress time, is estimated to be 114 s for the medium t-squared fire in the coach car. Other compartments in the simulation reach these criteria at a later time.

These calculations are repeated for the range of standard design fires to obtain the full fire performance graph for the chosen passenger rail car design geometry.

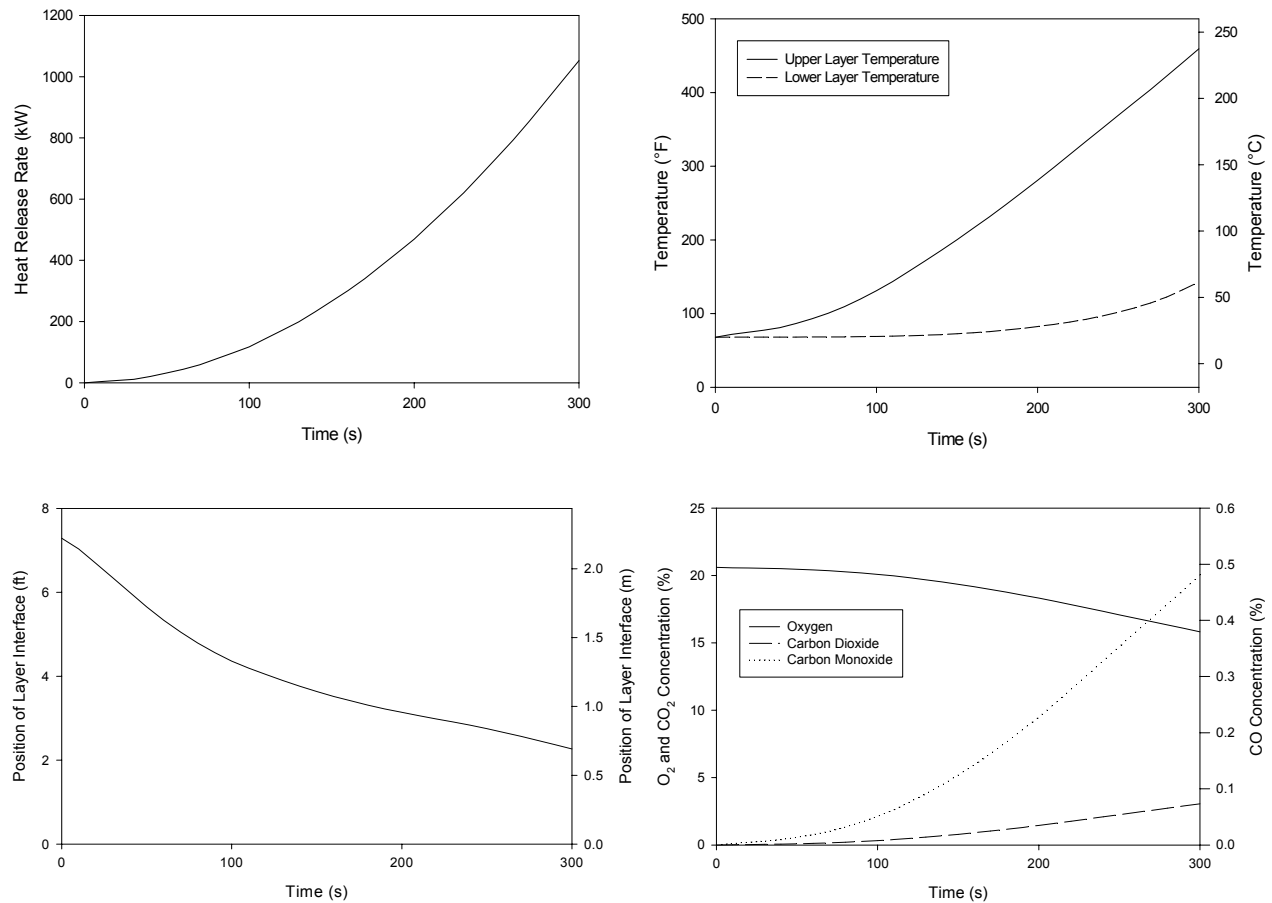

Figure 14. Calculated Conditions for Coach Car Main Seating Area Exposed to a Medium T-Squared Fire Source

4.2.4 Fire Performance

Figure 15 shows the full passenger rail coach car fire performance graph, calculated from numerous model simulations for the car geometry with a range of growth rate fires. This figure shows a measure of the size of the fire (time for the fire to reach a HRR of 1 MW (1000 BTU/s), plotted against a measure of the available egress time (time to untenable conditions, based on impaired occupant evacuation). It should be noted that slow, medium, fast, and ultra-fast fires reach 1 MW in 600 s, 300 s, 150 s, and 75 s, respectively. The calculated minimum necessary egress time is 88 ± 8 s for all 72 persons to evacuate through one end of the car to another car.

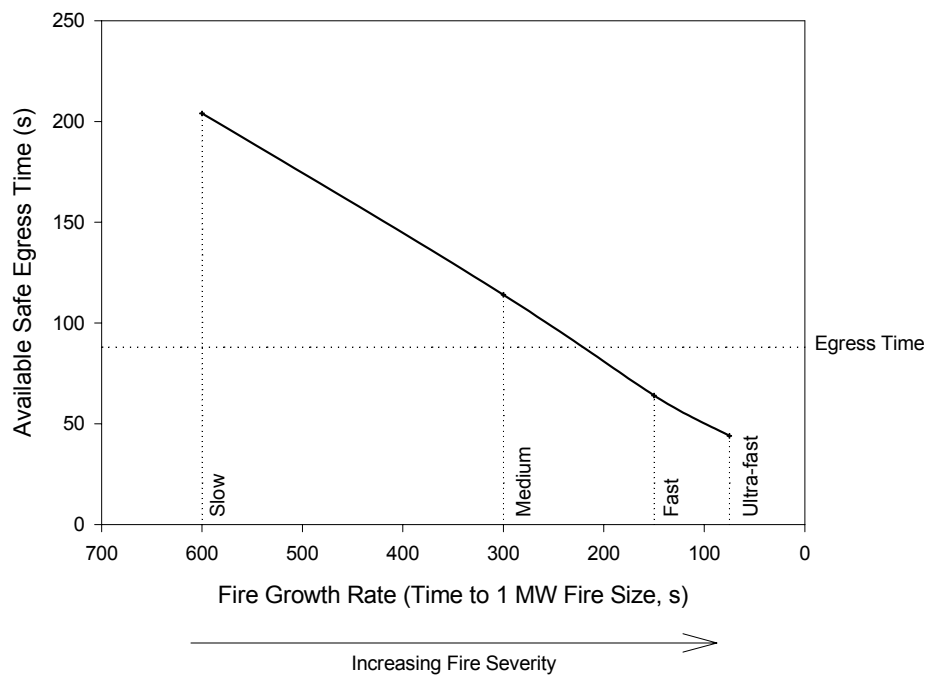

Figure 15. Calculated Fire Performance for Baseline Coach Car Fire Hazard Analysis

Several features of this fire performance graph should be noted to ease interpretation of the curve:

- The vertical axis shows the time available for egress for the given geometry calculated for a range of fire growth rates.
- The horizontal axis shows the fire growth rate for a range of chosen design fires. Values on this axis are displayed as a time to reach 1 MW for any given fire growth rate.

- One or more curves can be included on the graph to show the available egress time for a range of fire growth rates. Each curve shows the calculated available safe egress time for a specific chosen tenability criterion. Any point below a given curve represents an acceptable combination of available egress time and fire growth rate for the chosen tenability criterion. For example, for a medium t-squared fire (a time to 1 MW of 300 s), an available egress time of 114 s would be considered acceptable performance since the necessary egress time is 88 ± 8 s for the coach car calculations shown in Figure 15.

No judgment is made on the performance of the rail car design since information on the typical fire scenarios and the setting of appropriate design margins are still to be discussed in Steps 3 and 4 (see sections 4.3 and 4.4). For example, improving the fire performance of all the materials in the coach car to reduce the fire growth rate to that of a slow t-squared fire (doubling the time it takes a fire to reach 1 MW) could increase the available safe egress time by 90 s to 204 s.

4.3 STEP 3: EVALUATE SPECIFIC PASSENGER RAIL CAR FIRE SCENARIOS

Step 3 examines possible passenger rail car fire scenarios in order to place the fire performance curves in context and to allow the designer to adopt reasonable design safety factors in the final design evaluation in Step 4. Goals for Step 3 are to:

- Examine relevant fire incident experience, with similar/same application.
- Identify the likely role/involvement of rail car contents in fire.
- Determine which fires are most common/likely and/or most challenging.
- Quantify the burning behavior for chosen scenarios from available fire test data, or appropriate small- and large-scale tests.

Section 3.2 examined fire incidents involving passenger rail cars in the context of fire scenarios and assembly testing to provide background data for this analysis. The examination identified several representative fire scenarios. These include:

- an ignition under a coach seat by a small source (crumpled newspaper),
- fire in a trash bag placed on a coach seat or in a sleeping compartment,
- overheated equipment (motor, pump, battery failure) in a sleeping car, and
- a Sterno can igniting a tablecloth in a dining or lounge car.

These scenarios are consistent with past passenger train fires and the scenarios described in the ASTM E-2061 rail assessment guide [22]. The following sections describe the specific fire scenarios that were included in the fire hazard analysis conducted for this study, including the ignition of seats, trash fires, and sleeping compartment bedroom fires.

4.3.1 The Role of Rail Car Contents in Specific Fire Scenarios

There are two basic components to modeling a specific passenger rail car fire scenario. The first step is to identify the primary scenario(s) of interest. Scenario identification is performed in two main ways: historical analysis of previous passenger train fire scenarios and engineering analysis of likely or possible fire scenarios. As rail car fires are relatively rare, an historical analysis in isolation is rarely sufficient. Consideration must be given to many possible ignition sources, modes of fire spread, and consequences. Thus, it would be inappropriate to select fire scenarios solely based upon the historical fire performance of passenger rail cars.

The second step is to determine input for modeling the fire scenario. While it is desirable to be able to model the effect of specific properties of a given material or component, such as total exposed area, location in compartment, or measured fire performance, this is not practical using current technology. Rather, experimental data comprising multiple scales are often the most efficient manner of deriving model input. Important model parameters include such properties as ignition delay, HRR, toxic gas production rates, and flame spread rate. Section 4.1.3 discusses the fire performance of the major materials used in the construction of the passenger rail coach car. These materials are highlighted in part to provide one possible approach to addressing the impact of particular materials or assemblies on fire growth being modeled.

Overall consideration of such materials or assemblies is important for several reasons from general safety, cost benefit, and specification perspectives. Driving decisions in utilizing these components are cases where a given material (or identical assemblies composed of several materials) may be used in significant quantities in certain passenger rail cars – as a wall or ceiling lining, or seat assembly. As such, the impact that a given component can have on observed fire performance for a given scenario may not only be important, but that performance may be critical to occupant safety issues. In these cases, observed fire behavior will be a consequence of both the properties of the materials in question and the manner in which they are used (e.g., total quantity present, exposed area, location in compartment, or the scenario being evaluated).

This is especially relevant for a manufacturer who provides a specific material for passenger rail car use. Such applications may include use of significant quantities of the given material in a particular rail car. However, the fire performance of specific materials cannot be evaluated only from knowledge of the physical properties of the individual materials.

This deficiency of the available technology is a direct consequence of the manner in which fire models (such as the CFAST model used for this analysis) operate. In simplest terms, their output is largely determined by two variables:

- assumed or programmed heat and species release rates for a given fire scenario; and
- available ventilation/geometric and thermophysical properties of the bounding surfaces for the specific scenario.

As such, if a scenario being modeled in a given compartment contains a particular furnishing item or wall lining which releases heat very quickly, the modeler may specify an ultra-fast fire or a specific HRR in that range to account for that performance. Conversely, if such materials are less responsive or slower in contributing to a growing fire, a lower HRR may be assumed and utilized as is appropriate. In neither case is HRR data for a specific material or component used directly as input for a modeling run or scenario. By including a range of these generic fires in the development of a fire performance graph, the response of the overall system is calculated. Specific material properties are only included to place the fire performance graph in context of the specific design and material selection included in a final design.

The linkage between such material or component specific variables and their impact on fire performance is important. As such, this linkage has been considered because of its potential impact on both design assumptions and ultimate design decisions made (see sections 4.1.3, 4.5.1, and 4.6.1). In addition, the synergies created through use of differing materials or combinations of materials or assemblies can be taken into account using the methodology presented where any fire hazard analysis is part of a total passenger rail car systems analysis that also includes appropriate material screening tests for alternatives.

4.3.2 Modeling Specific Scenarios

Specific scenarios of interest include small ignition sources on or beneath a coach seat, and a severe, large ignition source, represented by a trash bag placed on a seat in a coach car. The

scenarios were chosen for this fire hazard analysis primarily because they have a reasonable likelihood of occurrence and are appropriate for assembly tests using the Furniture Calorimeter.

4.3.3 Burning Behavior for Specific Scenarios

Data for computer fire models require significant levels of experimentation. The following section summarizes previous experimental work and conclusions. Relevant results for small-scale tests and assembly scale tests related to passenger rail car materials are also presented.

The 1984 FRA-sponsored Amtrak report described the results of passenger train interior material small- and large-scale tests and analysis [42]. A significant recommendation included a protocol for evaluating interior materials:

- A small number of full-size tests to determine a set of acceptable materials for the geometry of the full vehicle.
- A series of small-scale tests to evaluate alternative materials that are equal to or better in all tests to those tested in the full-scale tests which could then be substituted without further full-scale testing.

The 1984 report also identified several materials that met the FRA performance criteria. Still, the window mask, some seat cushions, and a floor covering yielded high HRR values. Additionally, the luggage rack design and the padded armrests contributed significantly to the spread of fire.

A test protocol for testing the interior furnishing (e.g., seats) of school buses was developed as part of NHTSA-sponsored research [43]. The major conclusions of the NHTSA report include:

- Blocking layers and flame retardant foams can be effective against ignition and flame spread for the school bus materials studied. The effects of vandalism were not considered;
- Small-scale testing alone is insufficient due to geometry and flame spread effects; and
- Full-scale testing and hazard analysis are necessary in order to create safety regulations.

Finally, the results of tests conducted during Phase I and II for the current rail car study reveal several interesting findings. Clearly, the FRA-cited requirements have been largely successful in

preventing small ignition sources from causing major fires. The low total peak HRR of 30 kW (including ignition source), for a seat assembly test underscores this. The resistance to sustained ignition from small sources is also clear from the review of major passenger train fires. However, “intermediate” fires pose a significant and reasonable fire threat for passenger trains. For example, one ignition source fire used in the assembly tests was a newspaper-filled trash bag typical of those used in overnight service on Amtrak trains that produced a peak HRR of 200 ± 35 kW. Given an ignition of this magnitude, there is sufficient fuel, depending on the location, to create potentially untenable conditions. Specifically, the assembly test results indicate that, although the seat assembly is a primary location for ignition, the seat shroud, wall carpet, wall and ceiling lining, windows, and baggage rack, can all contribute to fire development with a sufficiently large initial ignition source.

4.3.4 Composite Scenarios for Fire Modeling

A composite fire scenario is created from a series of small- and assembly-scale tests and serves to place the fire performance curve in context by providing a comparison of the fire performance curve with one or more specific fire scenarios applicable to the chosen application. For the coach car analysis, three different composite fire scenarios were examined:

- a severe ignition source scenario represented by a newspaper-filled trash bag that ignites a seat assembly and nearby components simultaneously;
- an intermediate ignition source represented by a gas burner ignition on the front edge of a seat assembly or a single trash bag; and
- a smaller ignition source represented by the TB 133 gas burner ignition source [87] on the horizontal surface of a seat assembly.

The first step is to identify the ignition source. Second, the likely materials are combined to form a composite HRR. The composite HRR is intended to simulate a fire in an entire passenger rail car. As an example, consider the coach car scenario where a fire starts on or under a seat. The seat, wall panel, wall carpet, drape, window, and seat back and tray table of the seat in front may all ignite. A worst-case of this fire would be if the initial burning object is sufficiently large to ignite all the other components shortly thereafter. As input into the computer fire model, the HRR of such materials are taken from Furniture Calorimeter tests and species yields (see section 5.4) are taken from either the Cone or Furniture Calorimeter. For the purposes of occupant safety, such data from calorimeter tests are appropriate since the interaction between the burning item and its surroundings should be minimal well past a time when conditions become untenable.

Figure 16 shows the HRR curves used as fire scenarios for the coach car analysis. (Like the HRR curves, species yields were estimated as a combination of those measured for individual materials.) For the severe trash bag scenario analysis, a conservative assumption that all materials ignite simultaneously was used. Alternatively, ignition delays could be estimated for each material, based on its resistance to ignition. For the other scenarios, no additional materials beyond the seat assembly become involved in the fire.

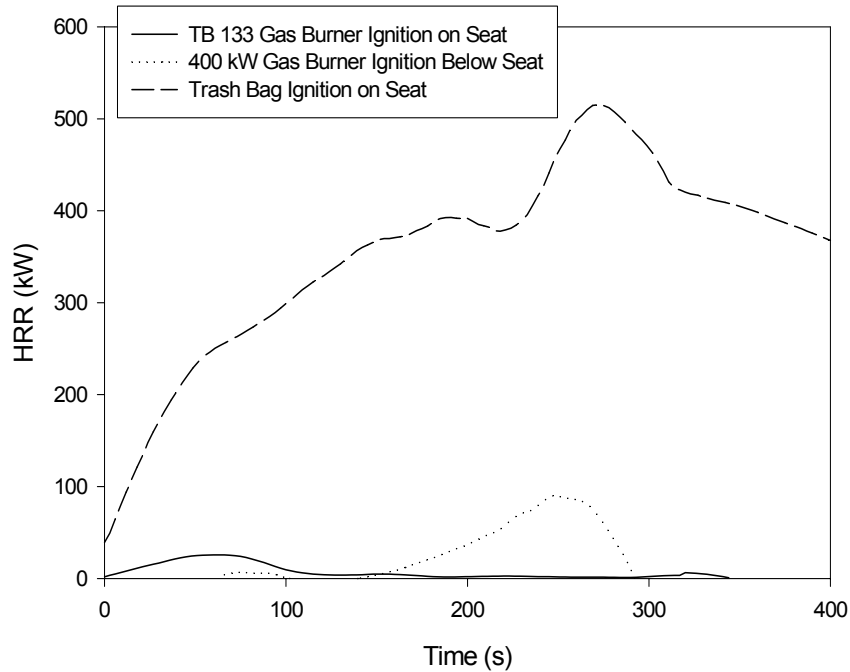

Figure 16. HRR for Several Composite Fire Scenarios Used to Model Coach Car Fires

To place the resulting fire scenarios in context on the fire performance graph, the intersection of the fire growth curves for the fire performance graph is compared to the fire growth curve for the chosen composite fire scenario. Since the fire performance graph is calculated from a set of ideal design fires, and the composite fire is unlikely to be exactly represented by a single ideal design fire, the design fires that bracket the composite fire scenario (those design fires that are less and more hazardous than the composite fire) can be determined. The selected design fires were

chosen as simple t-squared fires, where the HRR is simply proportional to the square of the time from ignition, or $\dot{q} = \alpha t^2$. Using t-squared fires, the design fires can be completely described by either the HRR at any chosen time, or by the total heat up to a chosen time. Both of these descriptions can provide a comparison of the fire scenario with the fire performance graph. For any functional form of the fire scenario, these two descriptions will bracket the characteristic fire

growth of the fire scenario on the fire performance graph. The more severe (faster fire growth) is then taken as the worst-case estimate of the fire growth rate of the scenario fire. Thus, for any time t , the characteristic fire growth rate of a composite fire scenario is determined from the maximum fire growth coefficient, calculated from:

$$\alpha(t)_{composite} = \frac{\dot{q}}{t^2}, \text{ calculated based on HRR, or}$$

$$\alpha(t)_{composite} = \frac{3 \int_0^t \dot{q} dt}{t^3}, \text{ calculated based on total heat.}$$

Which of these two calculations of fire growth rates is more severe depends on the actual functional form of the composite scenario fire. The following trends can be noted:

- If two growing fires in the same geometry have the same HRR at time t , the fire with the larger total heat released will be the more severe.
- If two growing fires in the same geometry have the same total energy released at time t , the fire with the larger HRR will be the more severe.

For each fire scenario, the above equations form a characteristic fire growth rate (time to reach 1 MW) that changes over time. The time to untenable conditions is simply the intersection of the characteristic fire growth rate with the fire performance curve for the chosen tenability criteria. For the composite fire scenarios used for the coach car analysis, the characteristic fire growth rate when conditions become untenable ranges from 113 s to 1 MW to more than 425 s to 1 MW (Table 5). For the smaller gas burner ignition sources, conditions do not become untenable.

Table 5. Characteristic Fire Growth Rate for Several Coach Car Fire Scenarios

SCENARIO	CHARACTERISTIC FIRE GROWTH RATE
TB 133 Ignition	> 600 s to 1 MW
Gas Burner Ignition	> 600 s to 1 MW
Trash Bag Alone	425 s to 1 MW
All Components Burning Simultaneously	113 s to 1 MW

4.4 STEP 4: EVALUATE SUITABILITY OF PASSENGER RAIL CAR DESIGN

In Step 4, the analysis is evaluated to assess the sensitivity of the analysis and suitability of the design. Goals for Step 4 are to:

- Estimate the effects of unknowns not accounted for in the fire performance graphs through expert judgment, regulatory guidance and, when needed, complementary small- and large-scale tests.
- Establish the sensitivity of the fire performance graph to known inputs.
- Set appropriate design margins.
- Determine the acceptability of the design.

Figure 17 shows the fire performance curve for the coach car with the composite fire scenarios included. Only the most severe scenario reaches untenable conditions before the calculated minimum necessary egress time of 88 ± 8 s. With all components burning simultaneously, the available egress time is 54 s. The effects of this scenario may be potentially mitigated by precluding any fire having a fire growth rate of faster than medium t-squared, or modifying the egress system.

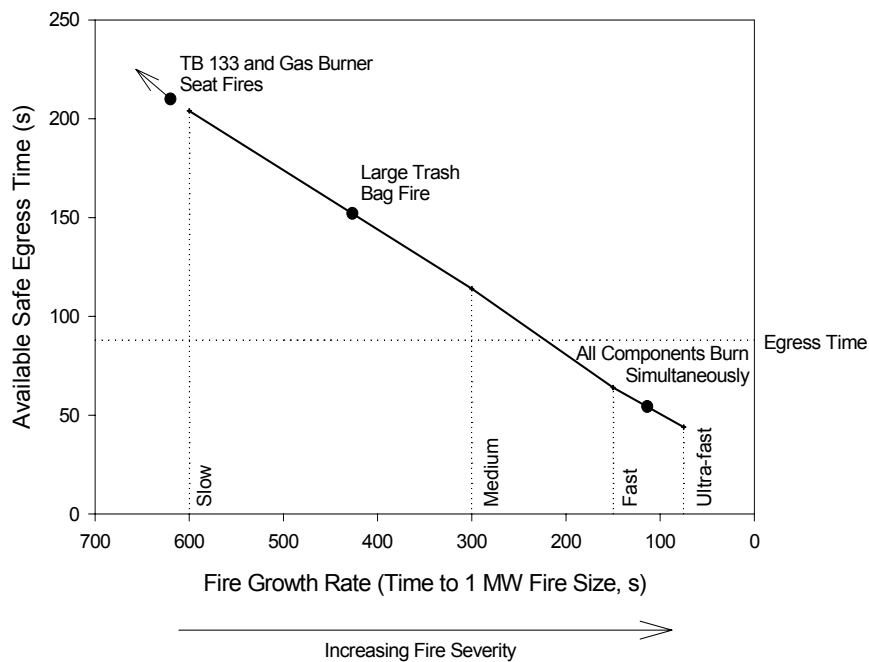

Figure 17. Calculated Fire Performance for Baseline Fire Hazard Analysis of Coach Car Comparing Available Egress Time with Several Composite Fire Scenarios

For example, this severe scenario and the trash bag fire have been addressed by Amtrak through a redesign of trash containers and modification of operational procedures to ensure that large accumulations of trash are frequently removed from the cars. The other fire scenarios do not lead to untenable conditions in the car.

4.4.1 Quantification of Uncertainty in the Fire Performance Graphs

Quantification of the uncertainty associated with the input parameters is very important in establishing confidence in the fire performance graph. Certain input parameters may have normal operating states that may vary significantly during the operational life of the passenger rail car. Figure 18 quantifies an example of geometry changes on the output of the fire performance graph to show the effect of an input parameter change. The dashed lines are the results of increasing and decreasing the size of the car compartment and vent openings by 5 percent. For all fire growth rates, where the variation in the available safe egress time for a 5 percent change in compartment size and vent opening is less than 10 s. The conclusion is that errors of 5 percent or less in estimating the geometry specifications will have little effect on the accuracy of the analysis.

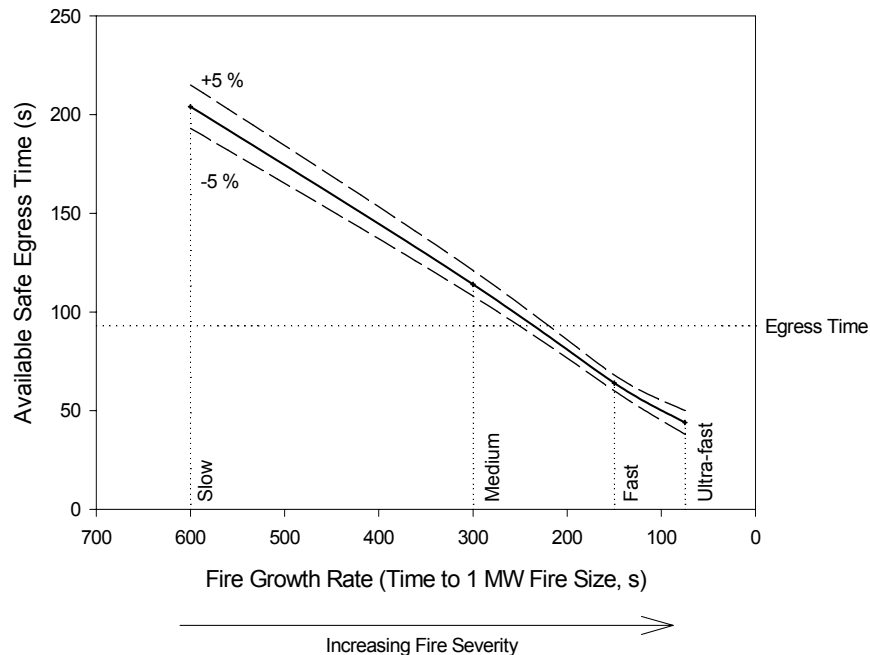

Figure 18. Sensitivity of Calculated Fire Performance to 5 Percent Change in Compartment Size and Vent Openings

4.4.2 Design Sensitivity, Design Margins, and Acceptability

The analysis sensitivities are presented on the fire performance graph itself (see figures 17 and 18). The slope of the fire performance curve at each point along the curve is the sensitivity of the curve at that point. For the coach car analysis, the curves are reasonably straight lines. A slope of 1 would indicate that changes of the same magnitude in available egress time and fire growth rate would have an equal effect upon the ultimate safety of the passenger rail car. A slope of greater than 1 would indicate that changes in the available egress time would have a greater effect than changes in the fire growth rate. Conversely, a slope of less than 1 would indicate that changes in the fire growth rate of materials would have a greater effect than changes in the available egress time. For the time to untenable conditions, the slope is 0.3 s/(s to 1 MW). Thus, a 10-second change in available egress time would result in a greater impact upon passenger rail car fire safety than a 10-second change in the fire growth rate of the materials. It is noted, however, that this analysis does not account for the costs of enacting these changes. The results of the analysis should be challenged by the user's judgment and experience. Results that violate these considerations should be questioned and resolved. Comparisons should be made to data from similar experiments or actual passenger train fires wherever possible. If such data are not available, it may be advisable to conduct verifying tests.

For the egress calculations, the assumptions for this example analysis are that: in a situation where passengers and crew are at risk, everyone responds immediately to the fire and starts to evacuate the coach car, no one is trying to carry luggage off the car, and there is no panic.

Because of these assumptions and other unforeseen factors, the actual acceptance parameter would not be the minimum necessary egress time calculated by the model. Rather, a design margin (2 is the safety factor typically used) to account for phenomena that may not be “very well understood” should be included [26]. For the coach car analysis, this could be a reduction in the minimum necessary egress time or reduction in the allowable characteristic fire growth rate. In either case, nearly all design fire scenarios are well within the design margin.

4.5 DINING CAR ANALYSIS

This section presents the results of the fire hazard analysis for the bi-level dining car. It should be noted that this section represents a summary analysis as compared to the more detailed coach car hazard analysis discussed in sections 4.1 to 4.4.

4.5.1 Car Configuration

Figure 19 shows a schematic floor plan view of the bi-level dining car. The capacity of the dining car is 82 people, the majority being 72 passengers who use the tables on the upper level while the staff occupy both the upper and lower levels. The three main compartments are the two dining areas on either end of the upper level and the kitchen compartment on the lower level.

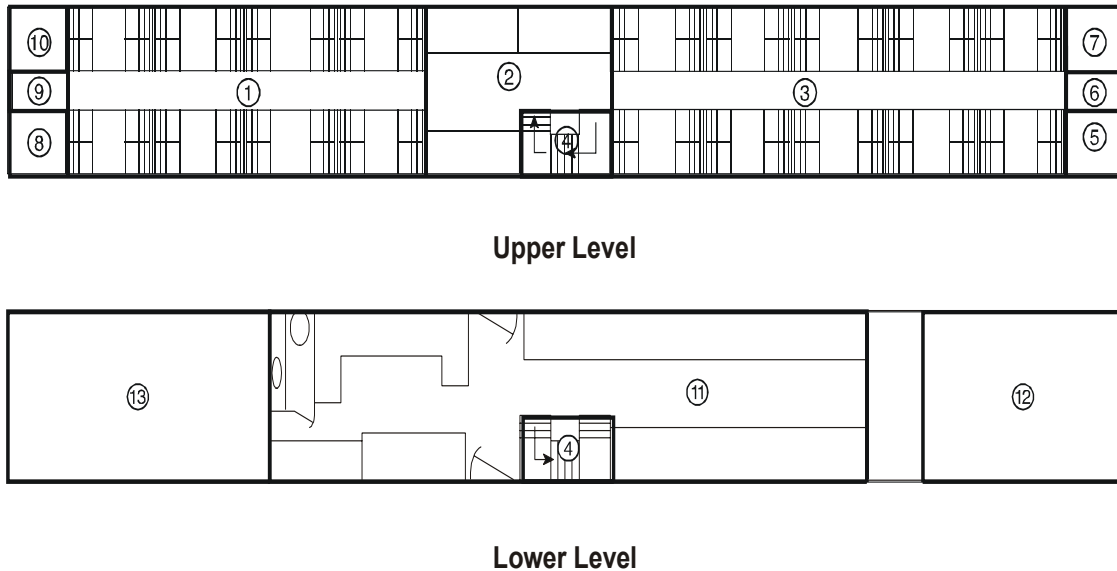

Figure 19. Floor Plan and Compartment Selection for Dining Car Fire Modeling

Compartment 4 is a stairway leading from the kitchen to the serving area on the upper level. The kitchen is the only compartment on the lower level that has occupants (Compartment 11). Compartments 12 and 13 are the spaces for the HVAC units for the car and are only connected with the other compartments by ventilation ducts, but not by any doors or other openings.

4.5.2 Important Materials

Figure 20 illustrates typical dining car upper level interior furnishings. Two important fire scenarios are considered in the bi-level dining car: a fire in the kitchen and a fire in a passenger dining area. While a fire in the kitchen is statistically more likely, the limited combustibles and the presence of both trained personnel and active suppression systems [88] make the risk relatively low. Important kitchen materials include grease, cooking oil, food packaging materials, and rubber floor mats. The bulk of the rest of the materials in the kitchen are non-combustible stainless steel materials.

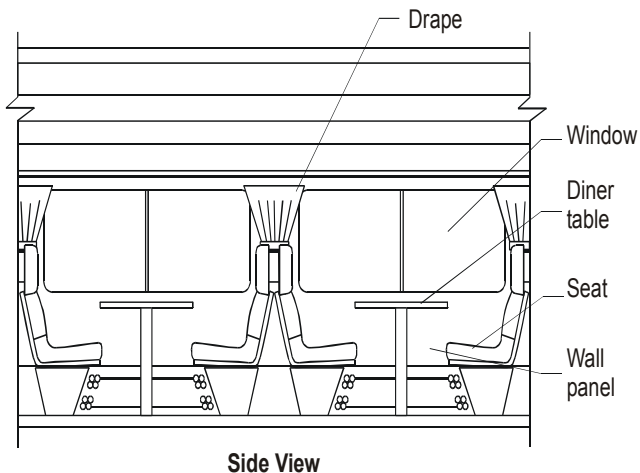

Figure 20. Typical Dining Car Interior Furnishings

The materials in the passenger dining area are similar to the materials in the coach car with some exceptions. The seat cushion assemblies in the dining car use only PVC vinyl covers. A dining table represents a unique material component (a phenolic/wood laminate). While difficult to ignite due to its high density (hence, high thermal inertia), the table could represent a major contributor to a well-developed fire.

Table 4-4 quantifies component material contributions to a fire in the dining car according to the hazard load analysis contained in NFPA 130 [81]. As noted in section 4.1.3, the NFPA 130 analysis method provides a simplified and semi-quantitative analysis of the overall contribution to fire hazard of the materials used in interior furnishings. The analysis includes a “heat hazard load” based on HRR and a “smoke hazard load” based on smoke emission.

Table 6 shows that the most important materials to consider in this dining car analysis are the windows, wall carpet, wall and ceiling linings, and seat cushion assemblies. Taken together, the windows, wall carpet, wall and ceiling linings, and windows constitute more than 70 percent of the heat hazard load and nearly 80 percent of the smoke hazard load while the seat cushion assemblies constitute more than 10 percent of the heat hazard load and 10 percent of the smoke hazard load. The relative contribution of other materials is significantly less than each of these components. It is important to note that while the exposed surface area material quantities are based on actual passenger rail car schematic plans, the values are only representative of the methodology and should not be interpreted as being an accurate representation of any particular existing dining car configuration or actual hazard load.

Table 6. Relative Fire Contribution of Dining Car Material Components

COMPONENT MATERIAL	EXPOSED SURFACE AREA (m ² / ft ²)	180 SECOND AVERAGE HRR (kW/m ²)	HEAT HAZARD LOAD (kW)	180 SECOND AVERAGE SMOKE EXTINCTION AREA (SEA) (m ² /kg)	SMOKE HAZARD LOAD (kW/m ² • m ² /kg)
Wall carpet, wool	60 / 646	395	23,700	510	12,087,000
Window, polycarbonate	60 / 646	250	15,000	1,000	15,000,000
Seat Assembly, PVC cover w/ foam cushion	144 / 1550	55	7,920	510	4,039,200
Wall & Ceiling Lining, FRP/PVC	60 / 646	100	6,000	700	4,200,000
Floor Carpet, nylon	50 / 538	95	4,750	350	1,662,500
Table, phenolic/wood	36 / 388	130	4,680	80	374,400
Window Drape, wool/nylon	60 / 646	25	1,500	380	570,000
Rubber Floor Mat, styrene butadiene	8 / 86	180	1,440	1,400	2,016,000

4.5.3 Results

Figure 21 shows the fire performance graph for the bi-level dining car. The most serious fire scenario to consider is one in the upper dining area, since egress is through doors on the upper level to adjacent cars while the train is moving. A fire in this upper level will more quickly make the upper level untenable. The calculated minimum necessary egress time for the dining car is approximately 85 s. This egress time is similar to the coach car since the majority of occupants of this car are on the upper level. The overall fire performance graph is somewhat different due to the larger volume of the two-level car. As shown in Figure 21, the dining car remains tenable and safe for egress longer than the coach car for the same severity of fires. Passenger evacuation time is relatively the same as for the coach car, but crew evacuation time from the lower level kitchen is several seconds longer, since they have to go from the lower level to the upper level via the stairway before moving to the adjacent car. This adds an estimated 20 s to the egress time for the kitchen crew. The fire scenarios used are the same as when a fire starts on a seat, or under the tables.

For the fire scenarios used for the dining car analysis, the characteristic fire growth rate when conditions become untenable ranges from 175 s to 1 MW to more than 600 s to 1 MW. For a medium t-squared fire (a time to 1 MW of 300 s), an available egress time of 127 s would be

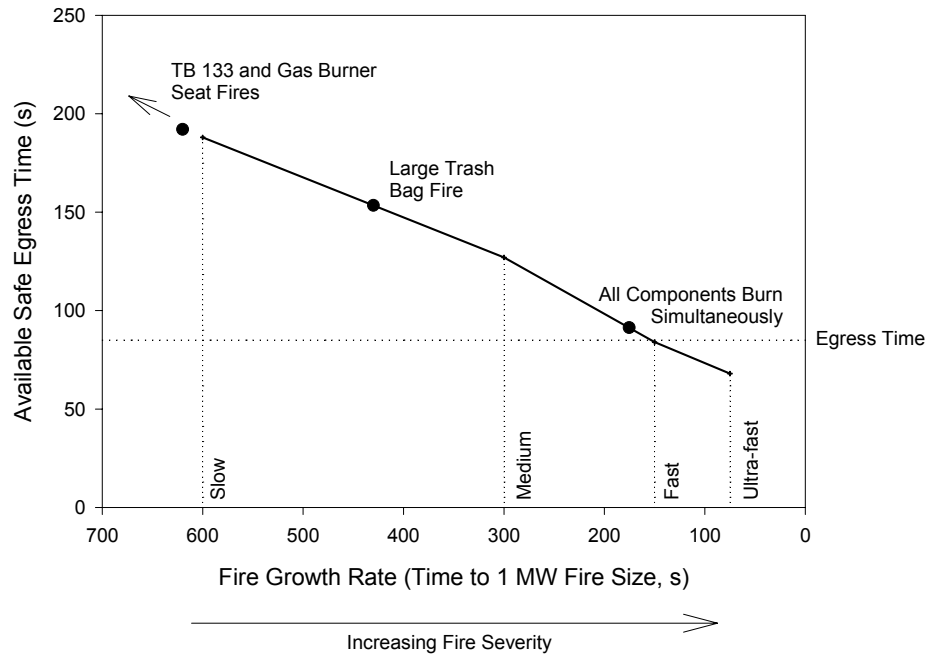

Figure 21. Calculated Fire Performance for Baseline Fire Hazard Analysis of Dining Car Comparing Available Egress Time with Several Composite Fire Scenarios

considered acceptable performance for the calculations shown in Figure 21. For this configuration, none of the scenario fires reaches untenable conditions prior to the calculated necessary egress time. Although many of the design uncertainties and sensitivities are similar to the coach car analysis, a higher design margin for the dining car analysis may be appropriate due to the bi-level design of the car.

4.6 SLEEPING CAR ANALYSIS

This section presents the results of the fire hazard analysis for the bi-level sleeping car. It should be noted that this section represents a summary analysis as compared to the more detailed coach car hazard analysis discussed in sections 4.1 to 4.4. The bi-level sleeping car is by far the most complicated analysis of the three rail car configurations due to the large number of compartments, whether or not the occupants are awake, as well as the fact that a special handicapped-accessible room exists on the lower level. While the outside dimensions of the sleeping car are similar to the other two cars, the interior reflects a higher degree of compartmentalization. Egress is through sliding end doors at both ends of the upper level if the train is in motion, or down a central stairway to the lower level which has sliding center doors on either side of the car, to the outside, once the train has stopped.

4.6.1 Car Configuration

Two types of sleeping compartments exist: deluxe and economy. The deluxe bedroom compartments are approximately 4.6 m² (50 ft²) in floor area and accommodate two to three persons. The economy bedroom compartments can accommodate one or two persons and are approximately 2.3 m² (25 ft²) in floor area. There are five deluxe bedrooms and 10 economy bedrooms on the upper level. A central stairwell connects the upper level hallway to the lower level hallway. The lower level contains four economy bedrooms, a sleeping compartment for a family of four, five unisex toilets, showers, and a handicapped-equipped bedroom for two people. The total normal capacity of the bi-level sleeping car is 45 people, including the car attendant. Figure 22 shows a schematic floor plan view of the sleeping car.

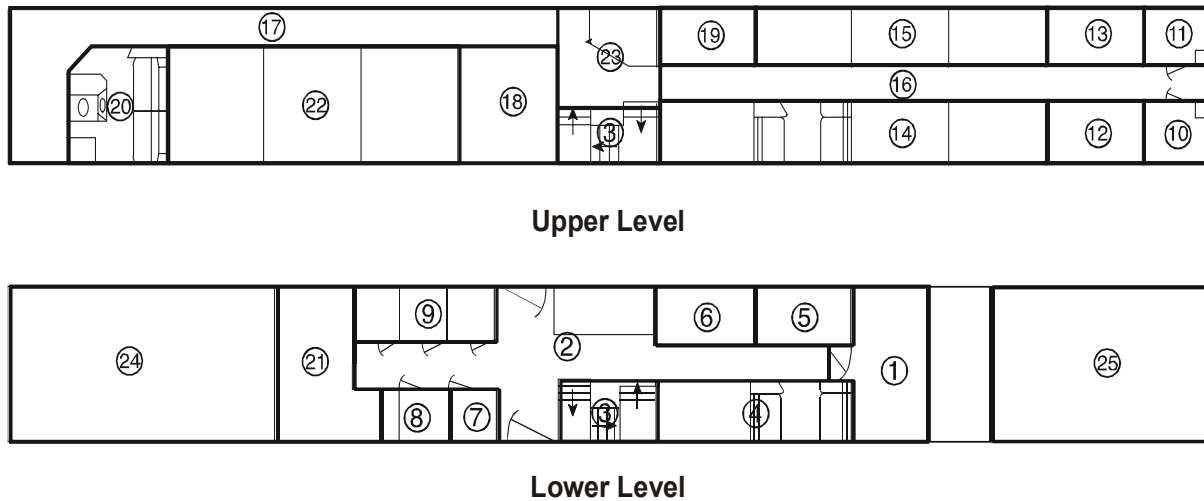

Figure 22. Floor Plan and Compartment Selection for Sleeping Car Fire Modeling

On the lower level, Compartment 1 is a large room reserved for families. The hallway (Compartment 2) connects all the adjoining compartments to the stairway. As in the dining car, the central stairway connecting the upper and lower levels and the stairway has been modeled as a single compartment (3) that connects the two levels. Compartments 5 and 6 are individual economy rooms located on the lower level.

Lower level toilet areas for the use of the economy bedroom passengers are Compartments 7 and 8. Compartment 21 is at the other end of the car from the family room and is reserved for elderly or disabled passengers. The single economy bedrooms on the upper level are Compartments 12, 13, and 19. Compartments 18 and 20 are each single deluxe bedrooms.

Because a number of the rooms are only important to the analysis as volumes to accumulate smoke, a number of bedrooms have been combined into a single compartment to simplify processing of the information. In the lower level of the sleeping car, some compartments had to also be consolidated in order to make the total number small enough to analyze. Compartment 4 is made up of two economy rooms and Compartment 9 is made up of three toilet areas. On the upper level, three of the deluxe rooms have been combined into one (Compartment 22). Also, Compartment 14 is made up of four economy bedrooms and Compartment 15 is made up of three economy bedrooms.

As in the dining car, the upper level of the sleeper has two mechanical rooms at one end of the car for the HVAC unit; these are Compartments 10 and 11. The upper level hallways are Compartments 16 and 17. Compartment 17 is an L-shaped room unlike the standard rectangular rooms modeled in a zone fire model. If the conditions in the small section of the hall near the exit were important for this analysis, then it would have been useful to divide Compartment 17 into two separate compartments. However, it is not necessary for this example analysis. Compartment 16 is the second hallway on the upper level. Compartment 23 is the attendant's station area connecting the two hallways with the stairs. Additionally, the sleeping car has mechanical compartments (Compartments 24 and 25) at either end of the lower level connected to the rest of the car by ventilation ducts. The ventilation system is modeled using the mechanical ventilation routine in CFAST by pushing air from Compartments 24 and 25 to the rest of the car through ventilation ducts.

4.6.2 Important Materials

Figure 23 shows an economy bedroom in a bi-level sleeping car. The typical economy room interior furnishings consist of two seats, upper and lower beds (with mattresses, sheets, blankets, and pillows), a large window, window drapes and a door privacy curtain, wall and ceiling linings, wall carpet, floor covering, and a sliding door leading to the corridor. The deluxe bedroom is a larger room that contains the same type of interior furnishings but consists of a full length couch and a chair for day seating, two sets of bedding, a closet, a toilet and shower room, and also a sliding door leading to the corridor. The quantity of combustibile materials present in the bi-level sleeping car is higher than the coach car. The luggage brought onto the sleeping cars will likely be in greater quantity than the luggage brought onto the coach cars since the latter are used by short-term riders for shorter trips. However, luggage is not considered in this analysis.

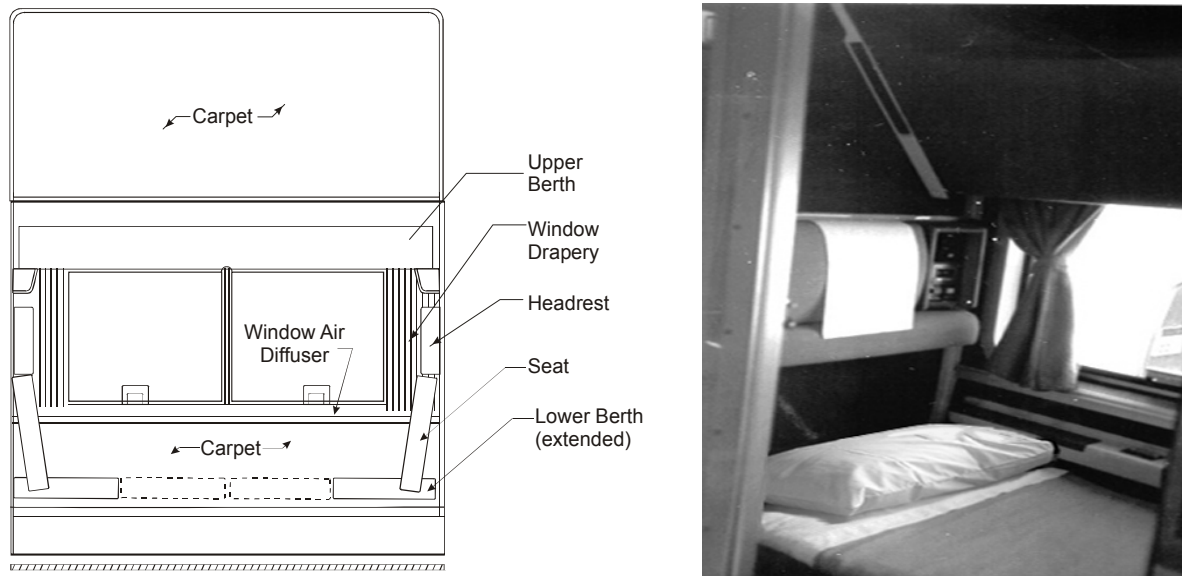

Figure 23. Typical Sleeping Car Economy Bedroom Interior Furnishings

Table 7 quantifies component material contributions to a composite fire in the sleeping car according to the procedure in NFPA 130 [81]. As noted in section 4.1.3, the NFPA 130 “hazard load analysis” method provides a simplified and semi-quantitative analysis of the overall contribution to fire hazard of the materials used in interior furnishings.

Table 7. Relative Contribution of Sleeping Car Material Components

COMPONENT MATERIAL	EXPOSED SURFACE AREA (m ² / ft ²)	180 SECOND AVERAGE HRR (kW/m ²)	HEAT HAZARD LOAD (kW)	180 SECOND AVERAGE SMOKE EXTINCTION AREA (SEA) (m ² /kg)	SMOKE HAZARD LOAD (kW m ² //kg)
Wall carpet, wool	60 / 646	395	23,700	510	12,087,000
Window, polycarbonate	60 / 646	250	15,000	1000	15,000,000
Wall & Ceiling Lining, FRP/PVC	75 / 807	100	7,500	700	5.250,000
Mattress (ticking, interliner, foam)	100 / 1076	50	5,000	35	175,000
Pillow, cotton/polyester	45 / 484	110	4,950	570	2,821,500
Floor Carpet, nylon	50 / 538	95	4,750	350	1,662,500
Drapes/Curtains, wool/nylon	60 / 646	25	1,500	380	570,000
Blanket, wool fabric	100 / 1076	10	1,000	560	560,000

Taken together, the wall carpet, window, and wall and ceiling lining materials constitute nearly 75 percent of the heat hazard load and 85 percent of the smoke hazard load in the sleeping car. The relative contribution of other material components is less than each of these components, with the exception of the bedding materials (pillow, mattress, and blanket) which constitute nearly 20 percent of the heat hazard load and nearly 10 percent of the smoke hazard load. It is important to note that while the material exposed surface area quantities are based on actual passenger rail car schematic plans, the values are merely representative of the methodology and should not be interpreted as being an accurate representation of any particular existing sleeping car configuration or actual hazard load.

4.6.3 Results

The sleeping car presents an example of the difficulties in conducting a fire hazard analysis. Although the car was modeled with 25 separate compartments, this is still a simplification since a number of compartments were combined. The basic scenario is that a fire starts in one of the bedrooms or hallways and from there the tenability of each compartment along all egress paths is evaluated. For this example, two fire sources were considered: a fire starting in a bedroom on the upper level, and a fire starting in the lower level corridor. As a minimum, to assess the egress times, the upper hallway and the top of the stairs (at the attendant's station) must be evaluated since these are the most restrictive egress paths. For this analysis, the sleeping car was modeled with doors to the bedroom compartments both open and closed. The resulting fire performance graphs show that the cases with all the doors closed always resulted in lower available egress times. At first, the reason that having the doors closed reduces the available egress time is not obvious. Because the sleeping rooms are designed for positive pressure ventilation, the hot gases in the fire room, which result in a positive pressure, are easily forced into the halls. Once in the halls and away from the fire, closed doors inhibit the gases from flowing into additional rooms. Without the extra volume of the additional open rooms, the layer height in the escape paths lowers more quickly with all doors closed than with all doors open.

The worst-case calculated minimum necessary egress time for the sleeping car is approximately 70 s, if occupants located in the lower level must move the upper level before exiting the car.

Available egress time is evaluated at two critical points in the egress path: the top of the stairs at the attendant's station and in the upper hallway. Figure 24 shows the fire performance curves for the sleeping car at both these locations. Like the coach and dining cars, the most severe scenario fire where all components are burning simultaneously leads to untenable conditions

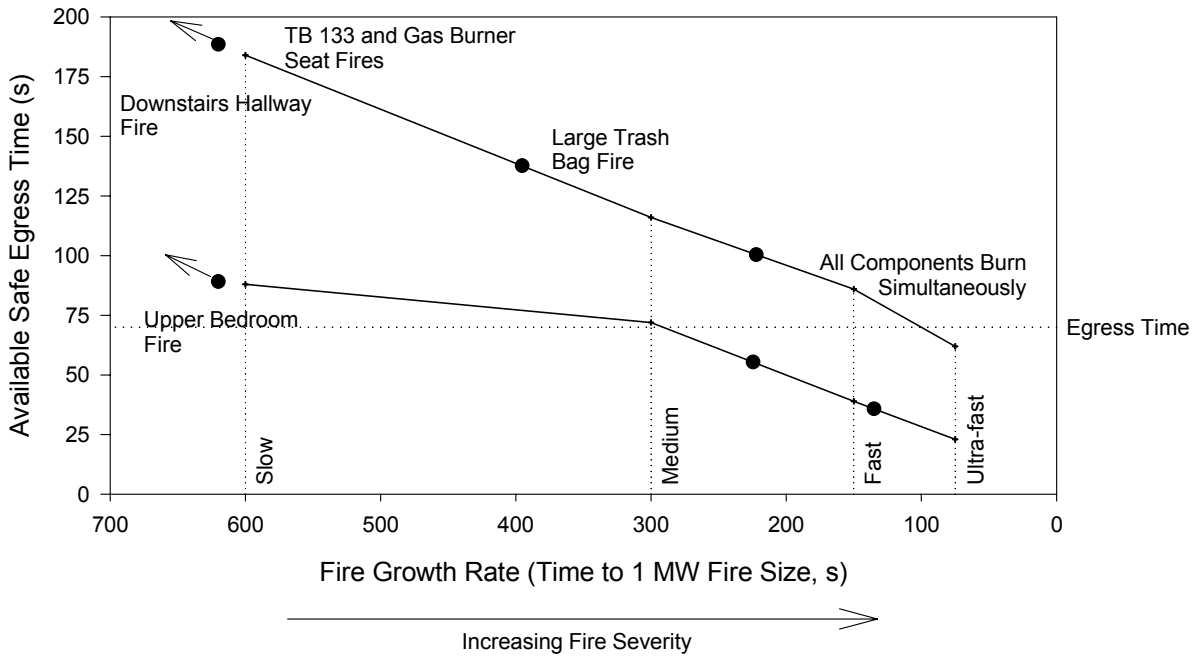

(a) Available Egress Time in Upper Hallway

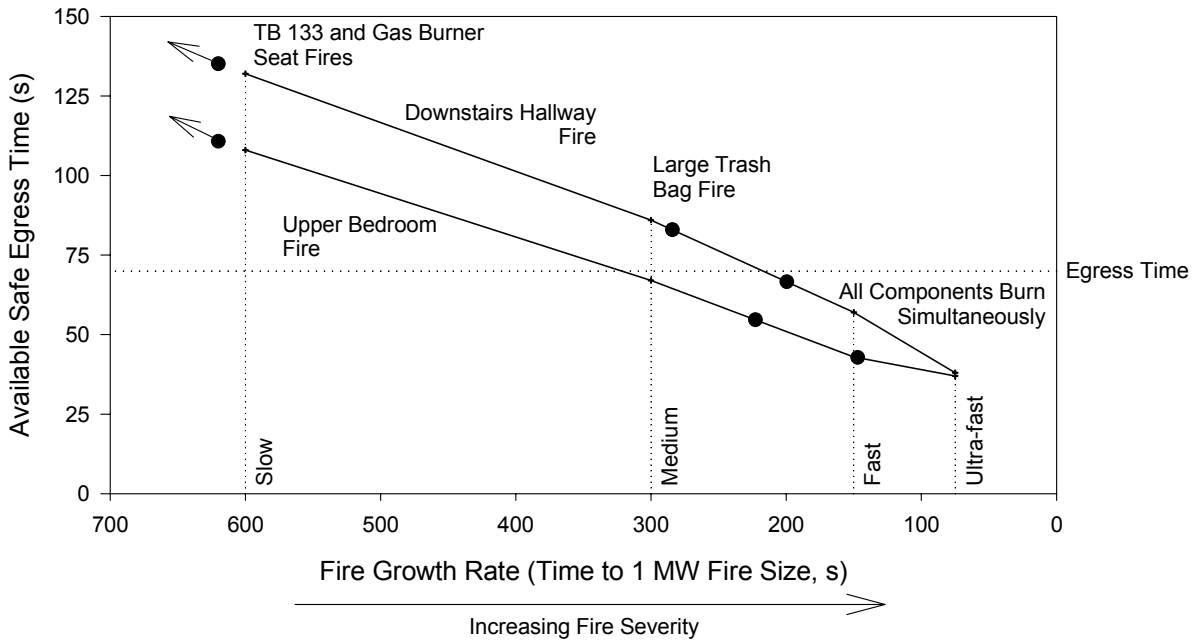

(b) Available Egress at Attendant's Station

Figure 24. Calculated Fire Performance for Baseline Fire Hazard Analysis of Sleeping Car, Comparing Available Egress Time with Several Composite Fire Scenarios

before all occupants may be able to evacuate. For a fire in the upper bedroom, the trash bag alone is sufficient to lead to untenable conditions. Again, smaller fires do not lead to untenable conditions in the car. For a medium t-squared fire (a time to 1 MW of 300 s), an available egress time of 67 s would be considered acceptable performance for the calculations shown in Figure 24. For the sleeping car, two fire performance curves are shown in each graph, one for a fire in the downstairs hallway and the other for a fire in an upper bedroom.

The third step in the analysis is to look at the fire scenarios. In this case, data from the large-scale Furniture Calorimeter tests for an economy bedroom mock-up (see Appendix A) can be used as the heat release curves for the analysis. Examination of the HRR curves for assembly tests conducted in the simulated economy bedroom shows that they are all fairly similar with the upper and lower berth assembly test having the highest peak HRR.

The last step is to combine the fire performance curves, including design margins, with the composite fire scenarios. For a fire in an upper level bedroom, the larger composite fire scenarios lead to untenable conditions prior to the calculated minimum necessary egress time of 70 s. For the lower level, fire scenarios in the hallways would require outside fuel sources to reach untenable conditions.

Although many of the design uncertainties and sensitivities are similar to the coach car analysis, a higher design margin for the sleeping car analysis may be appropriate. This is due to the unique design of the car (small sleeping room compartments and common hallways, and upper and lower levels), and because the occupants may be asleep and thus not detect or be aware of the fire before untenable conditions occur.

4.7 BASELINE FIRE HAZARD ANALYSES - KEY OBSERVATIONS

Fire hazard analysis can quantify the consequences of specific, interior fire scenarios on the safety of passengers and crew in typical intercity passenger coach, sleeping, and dining cars. Such an analysis can provide information on the following considerations:

- In addition to specific fire scenarios involving various ignition sources and assemblies developed from the Furniture Calorimeter test results, more general design fires can be used to test the fire performance of the overall system. Since the primary focus of the analyses in this study is passenger and crew safety during evacuation, the early stages of fire growth are of most interest.

- A set of specific design “t-squared fires,” labeled slow, medium, fast, and ultra-fast, such that the fires reached 1 MW (1000 BTU/s) in 600 s, 300 s, 150 s, and 75 s, respectively, were used for this study. These four fire growth rates span a wide range of representative fire types from slow growing solid wood fires to ultra-fast liquid fuel pool fires.
- The largest fire that still provides sufficient time to ensure that passengers and crew are safe from unreasonable risk of death or injury from interior fires can be determined. For example, materials or components exhibiting fire growth rates at or below a medium t-squared level would provide sufficient egress time for the design fires considered in this study.
- By comparing the largest design fire to specific fire scenarios involving materials used in the construction of passenger rail cars, the acceptability of the materials can be judged. For example, materials and components that comply with the current FRA requirements for fire performance exhibit fire growth rates below the medium t-squared level, and thus would be acceptable under the design criteria presented based on available safe egress time outside the car of fire origin.
- Design features important to fire safety can be identified. For example, fires in some locations can potentially block evacuation from the lower level of bi-level dining and sleeping cars to an adjacent car while the train is moving.

The baseline fire hazard analysis, through a general framework, examined the impact of design and materials on the safety of passengers and crew for specific intercity coach, dining, and sleeping car designs.

The Phase II assembly test results demonstrated that use of FRA-specified tests and performance criteria result in materials that resist ignition and fire growth from small fires. For example, the total peak HRR of the seat assembly (including the 17 kW TB-133 burner ignition source) was only 30 kW. (A small burning trash can results in a HRR of approximately 40 kW.)

For all but the most severe ignition sources, the baseline fire hazard analysis showed that conditions in all three passenger rail car designs studied remained tenable sufficiently long enough to allow safe passenger and crew egress, e.g., more than 10 minutes in some cases.

However, the Phase I and Phase II tests demonstrate that certain passenger rail car materials can represent significant sources of heat as secondary fuels. For example, the wall carpet and its adhesive, and the polycarbonate windows resist ignition, but can produce a high HRR when exposed to a large fire ignition source.

The effects of severe fire scenarios may be potentially mitigated by precluding any fire having a fire growth rate of faster than medium t-squared, or modifying the egress system. For example, the severe scenario where all components are ignited by a large trash bag has been addressed by Amtrak through a redesign of trash containers and modification of operational procedures to ensure that large accumulations of trash are removed from the cars.

It is important to also note that the calculated minimum necessary egress time does not include the rail car position (upright or overturned), impact of the fire on passengers and crew, panic, unique passenger rail car geometry and configuration of post-crash scattered luggage, or bodily injury to occupants prior to evacuation. Only a simple evacuation to an adjacent, upright car was considered. Recent research indicates that evacuation time from overturned passenger rail cars nearly doubles in the presence of smoke compared to similar egress conditions without smoke [89]. Any effects of more complex egress strategies to points of safety outside the train could have a significant impact on evacuation in an actual accident. However, those strategies were considered beyond the scope of the simple egress calculations conducted for this study.

The quantity, arrangement, and fire performance characteristics (ignitability and fire growth characteristics) of items brought aboard by passengers as baggage, and materials brought aboard as supplies such as packaging materials associated with food or cleaning supplies, could affect the analysis. The impact of items such as baggage was beyond the scope of this analysis but could be quantified in a more detailed analysis.

The appropriate design margin applied to the model time should account for the limitations posed by the position of the rail car, passenger panic or confusion or panic, etc.; 2 is the safety factor typically used. Additional research is recommended to address passenger and crew evacuation in the actual railroad operating environment.

4.8 SUMMARY

The baseline fire hazard analysis was used as a general framework to examine the impact of passenger rail car geometries and materials on the safety of passengers and crew for specific intercity coach, dining, and sleeping car designs.

The fire hazard analysis was conducted in four steps:

- Step 1 defines the performance objective and passenger rail car design.

For the example analyses, the performance objective was to ensure that the minimum time available for safe egress was greater than the minimum time necessary to evacuate all occupants out the end of the passenger rail car to an adjacent car. Coach, dining, and sleeping cars provided both single- and bi-level geometries, as well as varying numbers of occupants for analysis.

To provide an initial screening for important passenger rail car component materials, an analysis of the HRR and smoke emission “hazard loads” based on Cone Calorimeter test data was conducted for each of the three car configurations. For all configurations, the wall carpet, wall and ceiling linings, and windows constitute the majority of the hazard loads. With the exception of seat cushions and sleeping compartment bedding materials, the relative contribution of the remainder of the interior furnishings is significantly less important. The hazard load values are representative of the methodology and should not be interpreted as representative of any particular existing passenger rail car configuration or actual fire hazard.

The heat and smoke hazard load calculations identify important materials to be included in the full analysis conducted in Steps 2 and 3. The material HRR and other properties are used in Step 3 to quantify the burning behavior of specific passenger rail car fire scenarios and place the fire performance curves developed in Step 2 in context.

- Step 2 used the specific performance criterion of *minimum necessary egress time*. The passenger rail car fire performance was calculated in terms of available egress time and compared with that criterion. This calculation involves the creation of fire performance graphs for each rail car design.

The minimum time necessary for passenger and crew egress was estimated using an average time derived from three different simple evacuation models. For the coach, dining, and sleeping car designs, the minimum necessary egress time was estimated to be approximately 88 s, 85 s, and 70 s, respectively. For simplicity of the analyses, all of these estimates assume an upright car with unobstructed egress from one end to another adjacent car.

A simple, conservative tenability criterion for impaired occupant evacuation was used: when the upper level temperature exceeded 65°C (150°F) anywhere along the passenger rail car path of occupant egress, untenable conditions were assumed to have occurred.

Fire performance graphs were developed for the specific standard design fires to show the minimum time necessary for safe occupant egress and the time when the modeled space being

examined reaches untenable conditions. For the example analyses, the available safe egress time calculated for the three passenger rail car designs ranges from 67 s to 127 s, for a medium t-squared fire that grows to 1 MW in 300 s. For faster or slower growth rate fires, the calculated available egress time is naturally shorter or longer.

- Step 3 evaluates specific fire scenarios for each of the passenger rail car designs to determine representative HRRs.

The HRR curves for individual scenarios, determined from Cone Calorimeter and Furniture Calorimeter assembly tests were compared to the standard design fires to define composite fire scenarios. Untenable conditions are reached in a time faster than the medium t-squared design fire, only in the worst-case composite fire scenario where all interior materials are burning simultaneously. In most of the specific fire scenarios, untenable conditions were not reached. The fire performance graphs are representative of the methodology and should not be interpreted as representative of any particular existing passenger rail car configuration or actual fire hazard.

- Finally, Step 4 evaluates the suitability of each of the passenger rail car designs.

Passenger rail car materials and components that comply with the current FRA-cited fire tests and performance criteria exhibit fire growth rates below the medium t-squared level. For the three car analyses conducted, passengers and crew are safe from unreasonable hazard of death or injury from passenger rail car interior fires involving materials or components exhibiting fire growth rates at or below a medium t-squared level, similar to the growth and HRR of a typical upholstered sofa. For all but the most severe ignition sources, conditions in all three rail car designs studied remain tenable sufficiently long enough to allow safe occupant egress, e.g., more than 10 minutes in some cases. The exceptions are associated with the potential for fires in some locations that block evacuation from the lower level of the bi-level sleeping car to an adjacent car while the train is moving.

Although many of the design uncertainties and sensitivities are similar to the coach car analysis, a higher design margin for the dining car and sleeping car analyses may be appropriate due to the bi-level design of those cars. Moreover, the sleeping car analysis assumes that all persons detect or are aware of the fire which may not be true in actual train operation.

The appropriate design margin applied to the model time should account for such limitations; 2 is the safety factor typically used.

The fire hazard analysis calculations are based in part on a comparison of the calculated necessary egress time with available egress time for unimpaired occupant evacuation. For this study, three similar models were used to estimate the minimum necessary egress times for a single level coach car, and bi-level dining and sleeping cars. While one of these techniques (airExodus™) was developed specifically for transportation (i.e., aircraft), the accuracy of these estimates has not been studied for passenger rail cars.

Additional research is recommended to address passenger and crew evacuation in the actual railroad operating environment.

5. QUANTIFYING THE IMPACT OF PASSENGER RAIL CAR MATERIALS AND SYSTEM DESIGN ALTERNATIVES

The baseline fire hazard analyses presented in Chapter 4 establish the level of fire performance of current passenger rail car materials for a range of car configurations and fire scenarios. Further, the analyses identify those aspects of the current rail car system that most strongly influence this expected performance and therefore, where changes would produce the greatest benefits to improved fire safety. The purpose of this chapter is to demonstrate how the impact of changes to rail car design and other system alternatives can be quantified using the analytical methods introduced earlier.

Part 238.103 of the FRA passenger equipment rule requires operating railroads to conduct fire safety analyses of existing and new passenger rail equipment and to take appropriate action to allow for passenger evacuation in the event of a fire to reduce the risk of personal injury.

Several specific areas of the overall passenger rail car system design are important for a fire analysis to ensure sufficient evacuation time: materials, geometry, and fire detection and suppression systems. Each of these areas is discussed below, along with the effect of alternative design and other alternatives on overall system fire safety.

The intent of the FRA requirements is to prevent fire ignition and maximize the time available for evacuation in the event of a fire. Therefore, the primary factor assessed in this chapter to evaluate the effect of rail car design and other system alternatives is on the quantity of available safe egress time accorded by the changes. These changes may increase or decrease the available safe egress time resulting in either a positive or negative impact on the overall system fire safety.

The results of Chapter 4 underscore the need for a methodology consistent with the baseline fire hazard analyses that can evaluate the impact of changes made to the materials, design parameters, or system. The following sections demonstrate the use of such a methodology.

5.1 EFFECTS OF ALTERNATIVE MATERIALS AND CAR GEOMETRY

Available test data show that passenger rail car materials and components in current use generally produce a safe operating environment. This is demonstrated by the fire safety record of current passenger rail systems. However, a need exists to systematically evaluate new materials and designs as they are introduced to the passenger rail industry. This section

demonstrates the application of fire safety analysis to assess the impact of changing material performance and passenger rail car geometry.

5.1.1 Changing Material Requirements

Figure 25 shows the original composite fire scenario (with all materials burning simultaneously) used as the worst-case fire for the coach fire hazard analysis. To quantify the effect of changes in material requirements, this section examines how much a reduction to the composite fire would result from a reduction in the HRR from one or all of the individual component materials.

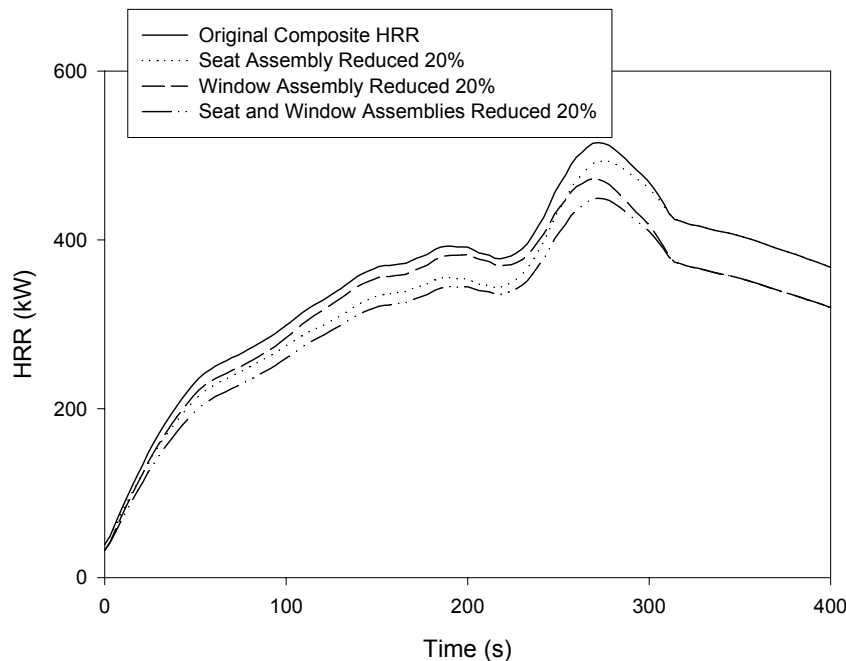

Figure 25. Original and Adjusted Composite Fire Scenario HRR Curves

For example, a seat assembly could uniformly produce 20 percent less heat. This is simple to quantify by multiplying the HRR of the seat assembly by 0.8 and then adding it to the full HRR of the trash bag and the window assembly tests. The same can be done to look at the effect of changes in the window assembly. Finally, the results of changes in both the window and seat assembly materials can be examined. The results of these three measures are shown in Figure 25 and do not significantly reduce the overall HRR of the composite fire. The reason is that a significant part of the HRR of the composite fire scenario is from material not covered by FRA requirements, in this case, a trash bag. But the HRR can also result from any significant fire source brought onto the passenger rail car by passengers or crew.

To place the results in perspective, a plot of the percentage change in the composite fire can be examined. A new plot can be calculated using the following simple equation:

$$\% \text{ Change} = \left| \frac{\dot{Q}_{adjusted} - \dot{Q}_{original}}{\dot{Q}_{original}} \right| * 100\%$$

where $\dot{Q}_{adjusted}$ is the HRR calculated by adjusting one or both of the tests and $\dot{Q}_{original}$ is the HRR of the original composite fire. Applying the results to the three curves calculated in Figure 25 shows that up until about 200 s (when the seat assembly starts to burn out), reducing the HRR for the seat has greater impact than reducing HRR for the window materials (Figure 26).

However, reducing the HRR for seat materials does not have a large impact on the overall size of the composite fire, lowering the peak HRR of the composite fire by only 20 kW out of 515 kW.

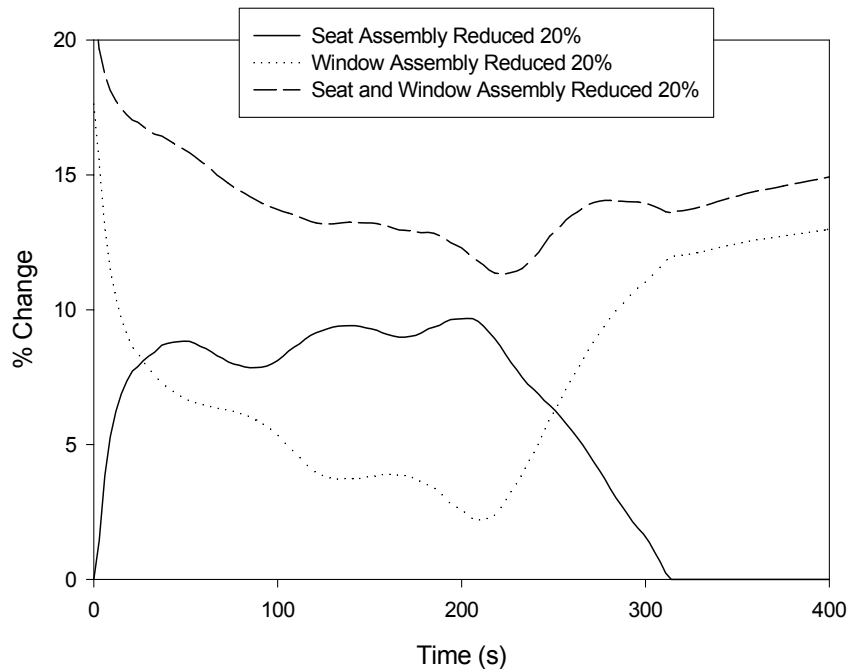

Figure 26. Percentage Change in HRR of Modified Composite Fire Compared to Baseline Composite Fire Scenario

The effect of changes in the HRR of important material assemblies on the available safe egress time for the coach car can be seen in Table 8. These egress times were calculated in the same manner as for the baseline composite fire scenario detailed in section 4.3.4. Table 8 shows that alternative seat or window assemblies result in a change of less than 10 s in available egress time for the coach car. Since much of this severe composite fire scenario HRR comes from the

Table 8. Effect of Material HRR on Overall Coach Car Fire Safety Performance

DESIGN ALTERNATIVE	EFFECTIVE T-SQUARED FIRE GROWTH RATE (Time to 1 MW fire in s)	CALCULATED AVAILABLE EGRESS TIME (s)
Baseline composite fire scenario	113	54
Seat assembly HRR reduced by 20 percent	124	57
Window assembly HRR reduced by 20 percent	120	56
Seat and window assembly HRR both reduced by 20 percent	132	59
Alternative seat materials	111 – 138	54 – 61
Alternative wall panel materials	109 – 132	53 – 59

trash bag ignition source which is not covered by the FRA requirements, the effect on available egress time, as indicated by time to untenable conditions, is minimal for changes in material HRR of up to 20 percent.

Table 8 also shows the overall impact of for actual alternative seat and wall materials proposed for use in passenger rail cars. For the seat tests, seat assemblies using the same upholstery but different foam cushions and construction were subjected to ignition from a TB 133 burner [90]. The maximum HRR for the tested seat assemblies (not including the ignition source) varied from 15 to 27 kW. For wall materials, Cone Calorimeter HRR data is available for alternate FRP wall panels [42] and for phenolic composite wall panels [91]. The maximum HRR for the alternate wall assemblies ranged from 68 kW for the phenolic material to 370 kW for the FRP material. Both alternate materials have long ignition times (140 s to 170 s).

Due to the high HRR of the trash bag ignition source, the alternative seat and wall assemblies have little effect on both the calculated available egress time and the effective fire growth rate for the composite baseline fire scenario, since they become involved in the fire well after untenable conditions occur in the coach car. With the less severe ignition sources, the alternative seat and wall panel assemblies would have longer available egress times and slower effective fire growth rates (longer times to 1 MW).

The overall impact of improved material performance requires more than an analysis of fire safety impact. The cost and benefits of stricter criteria should be weighed against the costs and

benefits of other methods of reducing the fire hazard. However, such cost data are often not available and a full cost-benefit analysis is beyond the scope of this study.

5.1.2 Changing Car Geometry

As an example of quantifying the effect of a change in an input parameter, figure 18 presented the effect of small changes in the passenger rail car geometry on the output of the fire performance graph. For a 5 percent change in the dimensions of all compartments in a car, the available egress time is nearly unchanged (Table 9).

Typically, large changes in the rail car geometry would be considered a change in design warranting a new fire hazard analysis. However, the impact of such changes on overall fire safety can be quantified by comparing the results of the new analysis with that of the original design. By comparing the available safe egress time for both designs, the impact of the design change can be quantified. For example, a coach car designed with the main passenger compartment divided into two smaller compartments separated by an open doorway could increase the available egress time (Table 9).

Table 9. Effect of Geometry Changes on Overall Coach Car Fire Safety Performance

DESIGN ALTERNATIVE	CALCULATED AVAILABLE EGRESS TIME FOR A MEDIUM T-SQUARED FIRE (s)
Coach Car Baseline Design	114
Compartment volumes increased by 5 percent	117
Main passenger compartment divided into two smaller compartments	110 – 142

The calculated effects for the divided coach car provide interesting insight into the impact of such design changes. In the fire compartment, the smaller volume results in a shorter available egress time, slightly reducing the calculated available egress time from 114 s to 110 s. In the other half of the car, the egress time is greater than the baseline case since it takes some time for the gases to flow from the fire compartment. If egress is limited to one end of the car, occupants in one of the smaller compartments may have to evacuate through the compartment of fire origin, creating additional exposure hazard. It is important to note that this calculation assumes that

there are no window exits available and that the geometry of the car has not been significantly altered by accident damage.

5.2 EFFECTS OF ALTERNATIVE FIRE PROTECTION SYSTEMS

Currently, the focus of passenger train fire safety, as well as the majority of other transportation applications, is primarily passive fire protection: material fire performance and compartmentalization. Modern fire safety techniques for buildings also rely heavily upon active systems: early detection, smoke management, and automatic suppression, which could be applied to passenger rail car fires. The FRA rule requires that the benefit provided by including fire and smoke detection systems in unoccupied train compartments be analyzed for new equipment. This section describes an example of such an analysis to quantify the potential contributions to passenger rail car fire safety of such active fire protection systems.

5.2.1 Detection and Suppression Systems

An Amtrak specification includes passenger car fire alarm system design requirements [92]. The FRA rule requires at least one fire extinguisher on all passenger rail cars [5]. NFPA 130 contains requirements for fire extinguishers on trains and for detection and suppression equipment in trainway power substations and stations [81]. These systems are typically required to protect critical systems and hazardous equipment which are capable of creating significant hazard to passengers. Table 10 shows predicted activation time for typical heat and smoke detectors and sprinklers for the range of fires and passenger rail car designs examined in this study.

Table 10. Predicted Activation of Heat and Smoke Detectors for Coach, Dining, and Sleeping Cars

BASILINE PASSENGER CAR DESIGN	FIXED TEMPERATURE HEAT DETECTOR OR SPRINKLER ACTIVATION (s)	SMOKE DETECTOR ACTIVATION (s)
Coach	32 – 288	9 – 114
Dining Car	27 – >600	6 – >600
Sleeping Car	24 – 439	5 – 231

This wide range of detector activation time is due both to the range of fire growth rates examined and to the placement of the detectors. The shortest activation times are always for detectors in the compartment of fire origin. For other compartments, longer times are expected. For example, with a fire in the upper level of the dining car, detectors located in the lower level do not respond by the end of the 600 s simulation.

5.2.2 Smoke Management

Smoke management (e.g., ventilation) may have beneficial effects on passenger train fire safety. Smoke management systems [93] have been implemented in building fire safety strategies for many years. The American Society of Heating, Refrigerating, and Air-Conditioning Engineers (ASHRAE) has published guidelines for the design of smoke control systems [94]. Significant increases in available safe egress time can be achieved with automatic smoke and heat venting in the compartment containing the fire.

Accordingly, two types of smoke management systems are considered. The first system provides semi-passive smoke venting because the vent simply opens upon automatic detection of a fire, or by manual activation, remaining open for the duration of the fire. The second system employs an active smoke exhaust fan because a fan physically pumps heat and smoke out of the car. Figure 27 shows the effect on the available safe egress time with passive smoke venting for the baseline coach car geometry.

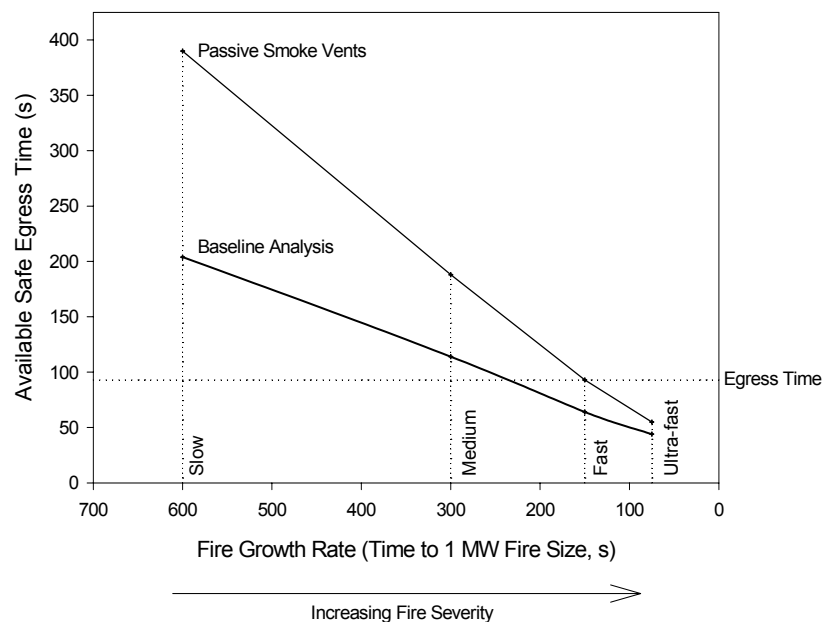

Figure 27. Calculated Fire Performance for Fire Hazard Analysis of Coach Car Configuration Including Passive Smoke Vents

For a medium t-squared fire growth rate, the available safe egress time increases from 114 s to 200 s. Thus, the occupants of the rail car will have more than twice as much time available for exiting from the rail car. By exhausting smoke and heat, the hot gas layer is smaller, providing relatively clean air for a longer period of time.

Figure 28 shows the effect of a smoke exhaust fan on tenability for the baseline coach car geometry. It should be noted that the increase in available egress time depends upon the growth rate of the fire. The increase in safe egress time is almost 100 percent for slow fires, but only about 10 percent for the ultra-fast fires. This is due to the capacity of the exhaust fans. The addition of a mechanical fan, however, dramatically reduces the ceiling penetration. In the roof venting option, the required area of the vent can be five or more times the area of an exhaust fan for the same performance, depending upon the flow rate of the fan. The assumed flow rate of the powered vent was the same as is produced by the HVAC system in the sleeping car, which is approximately 0.94 m³/s (2000 ft³/min).

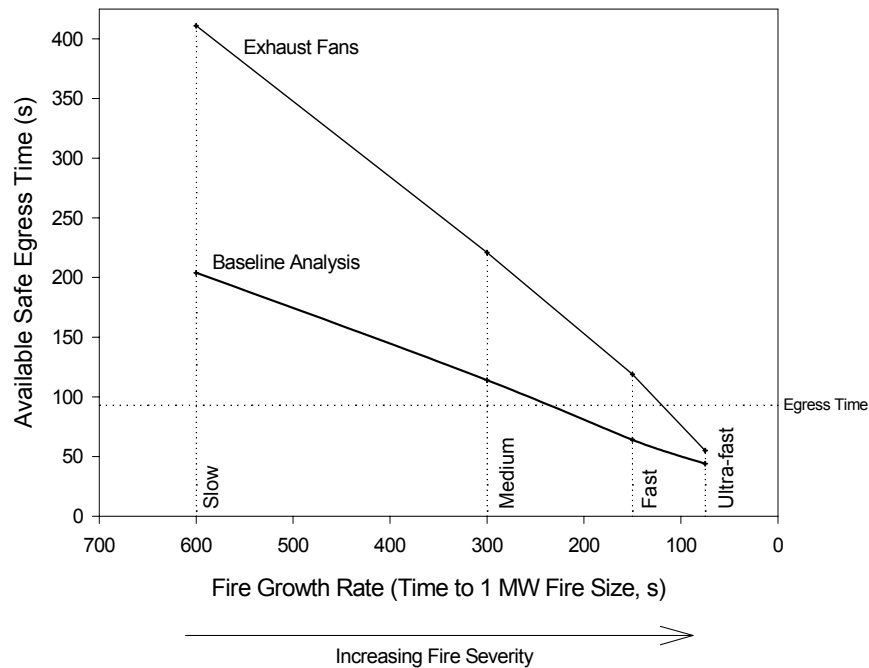

Figure 28. Calculated Fire Performance for Fire Hazard Analysis of Coach Car Configuration Including Exhaust Fans

5.2.3 Automatic Suppression Systems

Another design option that may have application to passenger rail cars is automatic suppression. In recent years, considerable research has been done on water mist systems. These use fine sprays of water to inhibit fire growth rather than to extinguish a fire. The Federal Aviation Administration [95], the U.S. Coast Guard [96], and the U.S. Navy [97] have performed significant tests for the feasibility of water mist systems in transportation vehicles. Such a system is a logical approach for mitigating a fire hazard with a minimum amount of water. A water mist system operates in a manner similar to a conventional sprinkler, where nozzles, activated by the melting of a temperature-sensitive fusible link, spray water on a fire. The quenching mechanism is different in a water mist system due to the small droplet size. The three main mechanisms are:

- cooling;
- oxygen displacement by water vapor; and
- radiant heat attenuation [98].

The most important effect relating to occupant evacuation is the cooling effect that the mist system has on the environment, lowering temperatures and increasing available egress time.

Several computer simulations were performed for the coach car to quantify the effect that a simple suppression system may have on passenger and crew safety. For these simulations, the basic modeling assumption is that the HRR of the fire is held constant upon activation of the sprinklers. With this assumption, the system is designed to control the fire rather than suppress the fire. Three activation temperatures were chosen: 15°C, 20°C, and 25°C (25°F, 35°F, and 45°F), above ambient. These low activation temperatures were chosen to assure system operation before the fire reaches a significant level. As shown in Figure 29, the lower the activation temperature of the sprinkler system, the greater the impact upon the available safe egress time. However, lower activation temperatures yield a greater likelihood of false activation. Therefore, the reduction in hazard must be weighed against the increased possibility of false activation.

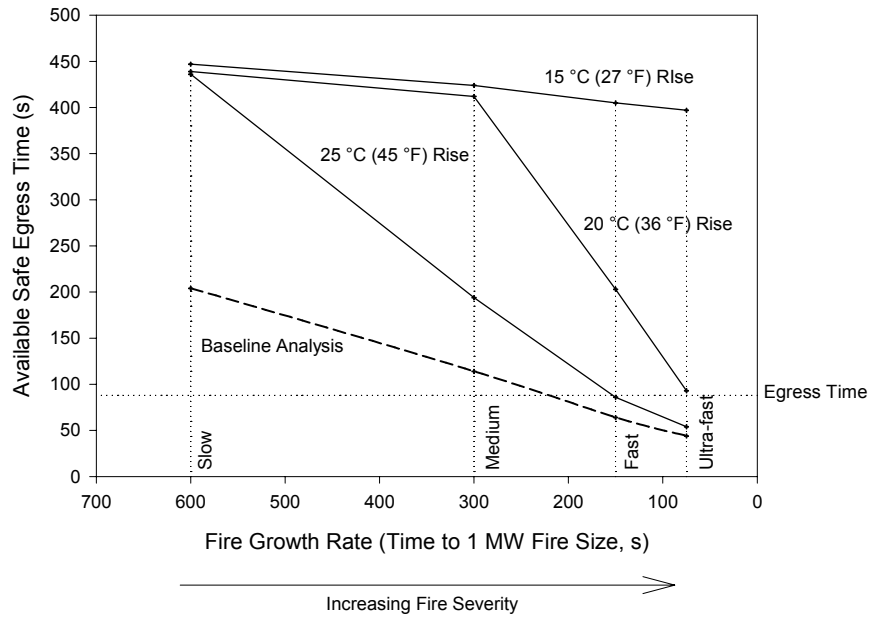

Figure 29. Calculated Fire Performance for Fire Hazard Analysis of Coach Car Configuration Including a Suppression System

5.2.4 Summary of the Effects of Fire Protection Systems Relative to the Baseline Analysis

Table 11 summarizes the impact of active fire protection systems relative to the baseline coach car analysis. While smoke and heat detectors do not directly impact upon the available safe egress time, they ensure that the occupants begin exiting the rail car in a timely fashion in the example cases calculated. Smoke venting and exhausting improve the available safe egress time from 114 s to more than 200 s. The effect of the suppression system in the cases calculated has a range from 194 s to more than 400 s, depending upon the activation temperature of the system.

Table 11. Effect of Active Fire Protection Systems on Overall Coach Car Fire Safety Performance

DESIGN ALTERNATIVE	CALCULATED AVAILABLE SAFE EGRESS TIME FOR A MEDIUM T-SQUARED FIRE (s)
Baseline Coach Car	114
Smoke and heat detectors	114
Passive smoke venting	188
Exhaust fans	221
Suppression system	194 - 424

5.3 EFFECT OF REDUCING MINIMUM NECESSARY EGRESS TIME

The minimum necessary egress time for the coach car baseline analysis as calculated in section 4.2.1 is 88 ± 8 s for 72 occupants. The calculation of egress time, whether from a building or passenger rail car, involves many assumptions. Therefore, the calculated minimum necessary egress time should only be considered the minimum time necessary for evacuation. Like the 90-second certification testing for aircraft, this egress time is simply a consistent point of comparison for different rail car configurations and fire scenarios. It is important to remember that this calculated egress time does not include impact of the fire on the train occupants, panic, scattered luggage in a post-crash rail car, or bodily injury to persons prior to evacuation. In addition, only a simple evacuation to an adjacent, upright rail car was considered. Any effects of more complex evacuation strategies to areas of safety outside the train were considered beyond the scope of the simple evacuation calculations. All of these effects could have a significant impact on the actual minimum necessary egress time in a real fire-related accident. For example, recent research indicates that egress time from overturned passenger rail cars nearly doubles in the presence of smoke compared to similar egress conditions without smoke [89]. Therefore, the appropriate design margin must be applied to the model time to account for such limitations; 2 is the safety factor typically used.

Several alternatives could significantly improve passenger rail car fire safety by reducing the time necessary for passengers and crew to evacuate a rail car. However, the impact of such alternatives is difficult to quantify, particularly for specific rail car designs.

Recent research by Proulx has shown that evacuation times can be significantly reduced by providing better, less ambiguous information [99][100]. Emergency exits of sufficient number and size that are clearly marked, adequate emergency lighting, low-location exit path marking, and public address systems can significantly reduce the time necessary for passengers and crew to evacuate the rail car. Fire extinguishers are required to be on board each passenger rail car. More extensive and clearer information to train crews about fire hazards and the best course of action to mitigate the effects of the particular fire situation are also desirable. The location of the train at the time of a fire incident can affect the fire hazard and significantly shorten or lengthen the time necessary for passenger and crew egress. For trains operating in a tunnel environment, evacuation to a point of safety outside the car must also be considered in any fire analysis.

Specific information about the fire incident should also be relayed to the appropriate dispatch centers so that local fire services know where to meet the train, how large the fire is, and how to

best handle it; all reducing response time and maximizing fire suppression and evacuation efforts.

Minimum requirements for the number and size of exits, marking and instructions, emergency lighting, and crew training are addressed in the FRA passenger equipment and emergency preparedness rules [5][101]. The FRA is sponsoring further research in this area.

For buildings, the quantitative prediction of the reaction and movement of people in fire and smoke conditions is well established [83]. Air Exodus™ is an emergency evacuation computer model for commercial aircraft that has been developed using similar techniques [25]. The model has been substantially modified over time due to the unique operating conditions based on the large database produced from the 90 second evacuation certification tests required by FAA. NIST has recently completed a sensitivity analysis of this aircraft evacuation model [102]. No such model or data resource exists for passenger trains. The adaptation of the aircraft evacuation model could provide a tool to more accurately calculate the actual rail car evacuation times for different car configurations under different fire scenario conditions.

5.4 EFFECT OF ALTERNATIVE TENABILITY CRITERIA

The choice of tenability criteria can have a significant effect on judging the effectiveness of a rail car design. This choice may be specified by the passenger railroad or other authorities having jurisdiction, or by expert engineering judgment based upon the performance of the existing acceptable designs. This section provides an example of the impact of using different tenability criteria on the calculated available safe egress time. All these criteria are based on extensive research in the effects of heat and toxic gases on persons exposed to a fire environment [83].

For the baseline analyses presented in Chapter 4, the following tenability criteria based on impaired occupant evacuation were used [84]:

- **Elevated temperature:** When a person is subjected to an upper layer (layer height less than or equal to 1.5 m [5 ft]) and the average upper layer air temperature exceeds 65°C (150°F); and
- **Smoke obscuration:** An optical density is greater than or equal to 0.5 and the interface height is less than or equal to 1 m (3.3 ft).

Two other widely used criteria were considered as alternatives to the baseline criteria:

Convected heat: Purser provides a tenability criterion for exposure of humans to elevated temperatures and high humidity. Based on data for hyperthermia (exposure to moderately elevated temperatures for longer periods of time) and skin burns (shorter exposure to higher temperatures), Purser recommends the following criterion:

$$F_{th} = \frac{1}{\exp(5.1849 - 0.0273T(^{\circ}C))}$$

where T is the gas temperature and the fractional incapacitating dose due to heat (F_{th}) reaches a value of 1.0 at incapacitation.

- **Toxic gases:** For exposure to elevated gas concentrations, Purser includes the effects of CO, HCN, reduced O₂, and CO₂ and expresses the resulting tenability criterion again as a fractional incapacitating dose due to narcotic gases, F_{IN} :

$$F_{IN} = \max\left(\left((F_{ICO} + F_{ICN}) \times VCO_2 + F_{IO}\right), F_{ICO_2}\right)$$

where the individual terms are calculated as integrated quantities over time, defined by Purser for each minute of exposure as:

$$\begin{aligned} F'_{ICO} &= (8.2925 \times 10^{-4} \times \text{ppm CO}^{1.036})/30 \\ F'_{ICN} &= 1/\exp(5.396 - 0.023 \times \text{ppm HCN}) \\ VCO_2 &= \exp(0.193 \times \%CO_2 + 2.004)/7.1 \\ F'_{IO} &= 1/\exp(8.13 - 0.54(20.9 - \%O_2)) \\ F'_{ICO_2} &= 1/\exp(6.1623 - 0.5189 \times \%CO_2) \end{aligned}$$

where the F'_i terms refer to the per minute exposure dose for CO, HCN, O₂, and CO₂, respectively; and parts per million (ppm) expresses the concentration in $\mu\text{L/L}$.

Figure 30 shows a fire performance graph for the coach car design using these four tenability criteria. For the same design fire, the calculated available safe egress time can vary by nearly a factor of four, depending on the chosen tenability criterion. For example, for a medium t-squared design fire (which reaches 1 MW in 300 s) the temperature and smoke obscuration criterion is exceeded at 114 s while the gas criterion is not exceeded until 364 s. In the simpler geometry of the coach car where the primary exposure is in or near the fire compartment, shorter times for temperature-based criteria compared to the gas-concentration-based criterion are typical [83]. In compartments remote from the fire, toxic effects become more important. Although the simpler criteria used in this report provide more conservative values for the available safe egress

time, other criteria are equally valid. Of course, it is appropriate to use the same criteria for multiple design analyses to ensure equivalent levels of safety for different designs.

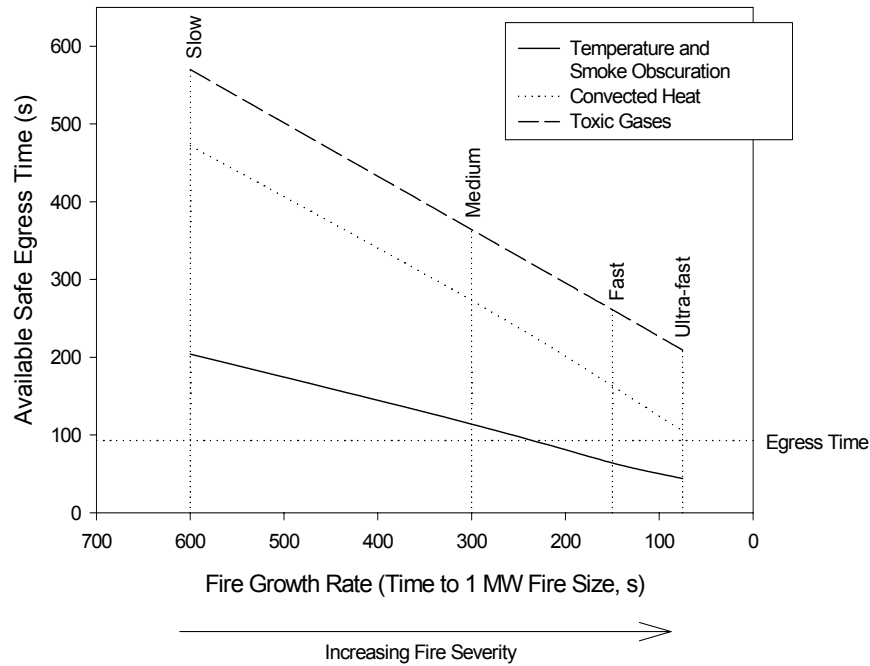

Figure 30. Calculated Fire Performance for Fire Hazard Analysis of Coach Car Configuration Including Alternative Tenability Criteria

5.5 SUMMARY

The intent of the FRA rule requirements is to prevent fire ignition and maximize the time available for passenger and crew evacuation in the event of a passenger train fire. Therefore, the primary factor that was assessed to evaluate the effect of design alternatives is the change in tenability and thus available safe egress time. The minimum necessary egress time for the coach car baseline analysis is 88 ± 8 s for 72 occupants. The calculation of egress time, whether from a building or passenger rail car, involves many assumptions. Therefore, the calculated minimum egress time should be considered only the minimum time necessary for evacuation. Like the 90-second certification testing for aircraft, this egress time is simply a consistent point of comparison for different rail car configurations and fire scenarios. It is important to remember that this calculated egress time does not include fire impact on the train occupants, panic, scattered luggage in a post-crash rail car, or bodily injury to persons prior to evacuation. The appropriate design margin applied to the model time should account for such limitations; 2 is the safety factor typically used.

Various design alternatives may increase or decrease the available safe egress time resulting in either a positive or negative impact on the overall system fire safety.

Available test data show that currently used passenger rail car materials and components generally produce a safe operating environment. This is affirmed by the current passenger railroad fire safety record. Design features, as well as materials, can have an impact on passenger and crew evacuation time and thus, the overall fire safety of the baseline coach rail car. Accordingly, rail car geometry, passive and active detection and suppression systems, and emergency egress systems were evaluated. In general, the design alternative examples show that automatic smoke venting and suppression systems in the rail car can have a greater impact on providing additional time for occupant evacuation (+200 s) than dramatic improvements in the already fire-hardened materials (+3-6 s). It should also be noted that the increase in available egress time depends upon the fire growth rate.

The other findings for the specific alternative changes to the baseline analysis are:

- The alternative seat, window, and wall material assemblies evaluated in this study have a small effect on the fire growth rate for the baseline composite fire.
- Small changes in the rail car geometry have a small effect on the fire hazard analysis. Larger changes in the geometry would be considered a change in the car design warranting a new fire hazard analysis.
- A wide range of detector activation time is due both to the range of fire growth rates and to the placement of detectors. The shortest activation times are always for detectors in the compartment of fire origin. For other compartments, longer times are expected.

Other factors such as clearly marked emergency exits of sufficient number and size, adequate emergency lighting, low-location exit path marking, and public address systems, as well as crew training and passenger awareness information could reduce the time necessary for occupants to evacuate rail cars, when it is necessary. However, the impact of such alternatives is difficult to quantify, particularly for passenger rail car designs. For passenger trains operating in a tunnel environment, evacuation to a safe area of refuge outside the rail car must be considered in any analysis.

It is also important to note that although alternative tenability criteria such as convected heat and toxic gases exist, elevated temperature and smoke obscuration are the most conservative criteria. For the same design fire, the calculated available egress time can vary by a factor of 4, using

different tenability criteria. For regulatory use, appropriate criteria should be specified for use in conducting the fire analysis.

The time needed for passengers and crew to evacuate the train and reach a point of safety requires the consideration of many variables besides the fire performance of rail car materials. The FRA passenger equipment and emergency preparedness rules provide minimum requirements for many of these variables, such as fire extinguishers, emergency exits, emergency lighting, crew training, and passenger information. In addition, the FRA is sponsoring an ongoing passenger train evacuation research program.

Although the prediction of the reaction and movement of people in fires is well established for building evacuation, no such model or data resource exists for passenger trains. The adaptation of the airExodusTM aircraft evacuation model coupled with the CFAST computer fire model could provide a tool to more accurately calculate the actual evacuation times for different passenger rail car configurations under different fire scenario conditions.

6. SUMMARY

Considerable advances in fire safety engineering have been made since the original development of the current FRA-cited fire safety requirements for passenger train material selection. Better understanding of the underlying phenomena governing fire initiation and growth has led to the development of advanced engineering fire analysis techniques using HRR and computer modeling. These techniques have gained worldwide credibility for the regulation of building fire safety, and have recently been examined for a range of transportation vehicles. This Phase II interim report documents the use of fire hazard analysis techniques applied to three passenger rail car designs. Using fire modeling, the relative importance of materials and other rail car system design parameters were quantified.

6.1 SUMMARY OF PHASE II RESULTS

Data from the Cone Calorimeter tests conducted in Phase I of this research program and from assembly tests conducted for Phase II were used as input for baseline fire hazard analyses conducted for a single level coach car, and bi-level dining and sleeping cars. The results of the analyses are summarized below for the assembly tests and the three different passenger rail car designs. Although based on existing passenger rail car designs, the baseline analyses are only examples demonstrating the use of fire hazard analysis techniques. They do not represent an evaluation of any particular existing car configuration or actual hazard.

6.1.1 Assembly Tests

Real-scale component material assemblies currently in use in intercity passenger train service were tested in a large-scale Furniture Calorimeter. Like the small-scale Cone Calorimeter, the primary measurement in this test is the HRR of the burning assembly when exposed to an ignition source. Trash bags taken from overnight service were characterized as a representative severe ignition source that may be present on passenger trains.

- The total peak HRR from actual trash bags from an Amtrak intercity overnight train ranged from 55 to 285 kW, including the ignition source, with an uncertainty of approximately ± 35 kW expressed as 1 standard deviation. Heavier and more densely packed trash bags had lower HRR values than lighter bags.
- All of the assemblies tested were extremely resistant to ignition. The tested assemblies required an initial ignition source ranging from 17 kW to 200 kW to

ignite. Some of the materials did not contribute to fire growth even with these ignition sources.

- In the assembly tests, the total peak HRR of seat, economy bedroom, wall and ceiling carpet, window drape/privacy curtain, and window assemblies were characterized. Total peak HRR ranged from 30 kW for a seat assembly, including a 17 kW gas burner ignition source, to 920 kW for a lower and upper bed assembly, including a newspaper-filled trash bag ignition source.

6.1.2 Standard Design Fires

In addition to specific composite fire scenarios involving various ignition sources and assemblies developed from the Furniture Calorimeter test results, “standard” design fires were developed to determine the fire performance of the overall passenger rail car system. A design fire is a specific theoretical fire curve. The shape of the curve is generally realized by simple mathematical expressions to facilitate engineering analysis. For most engineering analyses, a simple design fire curve is sufficient, assuming that the general shape and magnitude of the design curve reasonably approximates the real fire expected in a given scenario. In general, a design fire is a simple representation of fire growth from ignition, through growth, steady burning, and decay. Since the primary focus of the analyses in this interim report is passenger and crew safety during evacuation, the early stages of fire growth are of most interest. During this early growth phase, fires can be reasonably represented by a power law relation, which is expressed as:

$$\dot{q} = \alpha t^n$$

where \dot{q} is the HRR (kW), α is the fire intensity coefficient (kW/sⁿ), t is time (s), and n is a power chosen to best represent the chosen experimental data. For most flaming fires, the so-called t-squared ($n = 2$) growth rate is an excellent representation. A set of specific t-squared fires labeled slow, medium, fast, and ultra-fast, with fire intensity coefficients (α) such that the fires reached 1 MW (1000 BTU/s) in 600 s, 300 s, 150 s, and 75 s, respectively, were used for this analysis. These four fire growth rates span a wide range of representative fire types from slow growing solid wood fires to ultra-fast liquid fuel pool fires.

6.1.3 Baseline Fire Hazard Analyses

The baseline fire hazard analysis process was used as a general framework to examine the impact of materials and other fire performance design changes on the safety of passengers and crew for

specific intercity coach, and dining and sleeping car configurations. A detailed analysis has been presented for a specific coach rail car design while the dining and sleeping car analyses are presented in less extensive detail. The fire hazard analysis consists of four steps:

- Step 1 defines the performance objectives and passenger rail car design.

For the example analyses, the performance objective was to ensure that the available safe egress time was greater than the minimum time necessary to evacuate all persons out the end of the rail car to an adjacent car. Three passenger rail car designs, a coach, dining, and sleeping car, provided both single- and bi-level geometries and a varying number of occupants for analysis.

To provide an initial screening for important passenger rail car component materials, an analysis of the HRR and smoke emission “hazard loads” based on Cone Calorimeter test data was conducted for each of the three car configurations. For all configurations, the wall carpet, wall and ceiling linings, and windows constitute the majority of the hazard loads. With the exception of seat cushions and sleeping compartment bedding materials, the relative contribution of the remainder of the interior furnishings is significantly less important. The hazard load values are representative of the methodology and should not be interpreted as representative of any particular existing passenger rail car configuration or actual fire hazard.

The heat and smoke hazard load calculations identify important materials to be included in the full analysis conducted in Steps 2 and 3.

- Step 2 used the specific performance criterion of minimum necessary egress time. The passenger rail car fire performance was calculated in terms of available egress time and compared with that criterion. This calculation involves the creation of fire performance graphs for each rail car design.

For each of the analyses, egress was assumed to occur through one exit of an upright car to an adjacent car not involved in the fire. For other analyses, egress to a point of safety outside the train could also be considered by calculating egress time from the end or side doors.

The minimum necessary egress time was estimated using three different simple evacuation models. For the coach, dining, and sleeping car designs, the minimum time necessary for egress was estimated to be approximately 88 s, 85 s, and 70 s, respectively. All of these estimates assume an upright car with unobstructed egress.

A simple, conservative tenability criterion was used for this analysis: when the upper level temperature exceeded 65°C (150°F), at a height of 1.5 m (5 ft) anywhere along the passenger rail car path of egress, impaired occupant evacuation was assumed to have occurred.

It is important to note that although alternative tenability criteria such as convected heat and toxic gases exist, elevated temperature and smoke obscuration are the most conservative criteria. For the same design fire, the calculated available egress time can vary by a factor of 4, using different tenability criteria.

Fire performance graphs were developed for the specific standard design fires that show when the occupied compartment space examined reaches untenability, as well as the minimum time necessary for unimpaired occupant egress.

For the baseline analyses, the available safe egress time calculated for the three passenger rail car designs ranges from 67 s to 127 s, respectively, for a medium t-square fire that grows to 1 MW in 300 s. For faster or slower growth rate fires, the calculated available egress time is naturally shorter or longer.

- Step 3 evaluates specific composite fire scenarios for each of the passenger rail car designs to determine representative HRRs.

The HRR curves for individual composite fire scenarios, determined from Cone Calorimeter and Furniture Calorimeter assembly tests, was compared to the standard design fires to define composite fire scenarios. Untenable conditions are reached in a time faster than the medium t-squared design fire only in the worst-case composite scenario where all interior materials are burning simultaneously. In most of the specific fire scenarios, untenable conditions were never reached. The fire performance graphs are representative of the methodology and should not be interpreted as representative of any particular existing passenger rail car configuration or actual fire hazard.

- Finally, Step 4 evaluates the suitability of each the passenger rail car designs.

For the three passenger rail car analyses conducted, passengers and crew are safe from unreasonable hazard of death or injury from interior fires involving materials or components exhibiting fire growth rates at or below a medium t-squared level, similar to the growth and HRR of a typical upholstered sofa. For all but the most severe ignition sources, conditions in all three passenger rail car designs studied remain tenable sufficiently long enough to allow safe

passenger and crew egress, e.g., more than 10 minutes in some cases. The exceptions are associated with the potential for fires in some locations that block egress from the lower level of bi-level sleeping cars to an adjacent car while the train is moving. The sleeping car analysis also assumes that all persons are aware of the fire which may not be true in actual train operation.

The quantity, arrangement, and fire performance characteristics (ignitability and fire growth characteristics) of items brought aboard by passengers as baggage and materials brought aboard as supplies such as packaging materials associated with food or cleaning supplies could affect the analysis. The impact of items such as baggage could be quantified with additional testing and a more detailed analysis.

6.1.4 Impact of Passenger Rail Car System Changes on Fire Performance

The intent of the FRA rule requirements is to prevent fire ignition and maximize the time available for passenger and crew evacuation in the event of a passenger train fire. Materials and components that comply with the current FRA-cited fire tests and performance criteria exhibit fire growth rates below the medium t-squared level, and therefore do not represent an unreasonable hazard if ignited in the open.

The effects of severe fire scenarios may be potentially mitigated by either precluding any fire having a fire growth rate faster than medium t-squared, and/or modifying the egress system.

The severe fire scenario where all components are ignited by a large trash bag has been addressed by Amtrak through a redesign of trash containers as well as modification of operational procedures to ensure that large accumulations of trash are frequently removed from the cars.

The fire hazard analysis calculations described in this study provide a consistent point of comparison for three passenger rail car configurations and several fire scenarios. The minimum necessary egress times were estimated using three techniques, two of which were developed for buildings and one for aircraft. However, the accuracy of the estimates has not been studied for passenger rail cars. Moreover, only a simple evacuation to an adjacent, upright rail car was considered. For other analyses, egress outside the train could also be considered by calculating the minimum time necessary for passengers and crew to evacuate a specific rail car from the end or side doors to the point of safety.

The calculation of egress time, whether from a building or passenger rail car, involves many assumptions. Therefore, the calculated minimum necessary egress time should be considered only the minimum time necessary for actual evacuation. In addition, it is important to again note that this calculated minimum necessary egress time does not include impact of the fire on the train occupants, panic, the unique geometry and configuration of passenger rail cars, scattered luggage in a post-crash rail car, or bodily injury to persons prior to evacuation.

Any effects of more complex egress strategies to points of safety outside the train could have a significant impact on evacuation in an actual fire-related accident. However, those strategies were considered beyond the scope of the simple evacuation calculations conducted for this study. The appropriate design margin applied to the model time should account for such limitations; 2 is the safety factor typically used.

The primary factor that was assessed to evaluate the effect of passenger rail car design alternatives is the change in tenability and thus increased available safe egress time. Various design alternatives may increase or decrease the available safe egress time resulting in either a positive or negative impact on the overall system fire safety. Alternative analyses to the baseline analyses show that design features, such as fire detection and suppression systems, can have a greater influence than the use of more fire-retardant materials or small changes in geometry on the resulting fire safety performance of the overall passenger rail car design. For the example analysis, automatic smoke venting and suppression systems in the rail car compartment can have a greater impact on providing additional time for occupant evacuation (+200 s) than dramatic improvements in the already fire-retardant materials (+3-6 s). It should be noted that the increase in available egress time using any of the alternative designs depends on the growth rate of the actual fire. In addition, quantification of the impact of changes to the rail car emergency egress system itself is difficult as significant uncertainties exist regarding realistic egress times, particularly in a post-crash geometry.

Factors such as clearly marked emergency exits of sufficient number and size, adequate emergency lighting, low-location exit path marking, and public address systems, as well as crew training and passenger awareness information could reduce the time necessary for passengers and crew to evacuate passenger rail cars.

The FRA passenger equipment and emergency preparedness rules provide minimum requirements such as fire extinguishers, emergency exits, emergency lighting, crew training, and

passenger information. In addition, the FRA is sponsoring an ongoing passenger train evacuation research program.

For passenger trains operating in a potentially hazardous operating environment, such as a tunnel, evacuation outside the passenger train to a point of safety must be considered in any analysis.

While the prediction of the reaction and movement of people in fires is well established for buildings, no such model or data resource exists for passenger trains. If coupled to the CFAST fire model used in the baseline fire hazard analyses, the recently developed emergency evacuation computer model for commercial aircraft (airEXODUS™) could be used to determine actual occupant egress times for different passenger rail car configurations under different fire scenario conditions. Additional research is recommended to address passenger and crew evacuation times in the actual passenger railroad operating environment.

6.2 APPLICATION TO PHASE III TASKS

From the hazard analyses performed for this report, the obvious question that arises is “How good are the model predictions?” The only method of verifying the model predictions is to test them against actual controlled experiments. Phase III of this project involves full-scale experiments using an actual Amfleet I passenger rail coach car to examine the model predictions. As part of Phase III, two different types of tests were conducted in 1999 to evaluate the accuracy of the results of fire hazard analyses conducted in Phase II of the project: 1) a series of gas burner tests conducted to evaluate the accuracy of the fire performance curves for an actual rail car geometry, and 2) a series of tests to evaluate fire spread and growth for actual passenger rail car interior furnishings exposed to a range of initial fire sources. The results of these tests are documented in the Phase III interim report.

6.2.1 Real-Scale Gas Burner Tests

The fire performance curves described in this interim report show the predicted response of the selected rail coach car, dining, and sleeping car configuration to a range of typical fire growth rates. They also estimate the available safe egress time from a passenger rail car exposed to standard design fires. The calculations were compared to the minimum time necessary to evacuate occupants from the car to estimate the largest fire growth rate and size that are allowable for the chosen rail car configuration.

To evaluate the accuracy of the model calculations of the fire performance curves, a series of real-scale gas burner fires covering a range of fire sizes and growth rates were conducted in Phase III as part of the full-scale passenger rail coach car tests. The gas burner fires provide a carefully controlled and known HRR to match the slow, medium, fast, and ultra fast t-squared design fires used to develop the fire performance curves in Phase II.

A portion of the rail car was fitted with non-combustible surface linings, and the tests run only until selected tenability criteria were reached, to prevent major damage to the car during these tests. Prior to the tests, the rail car was characterized in terms of dimensions, interior materials, and leakage.

6.2.2 Full-Scale Fire Growth and Spread Tests

Several tests were conducted in Phase III to study the fire growth and flame spread patterns in a realistic fire scenario. The large-scale Furniture Calorimeter tests conducted during Phase II demonstrated that materials and products that comply with the current FRA fire performance requirements are difficult to ignite, requiring ignition source strengths of 2 to 10 times those used for similar materials and products found outside of the transportation environment. Still, it was also evident from the large-scale Furniture Calorimeter tests that significant fires can develop with sufficiently severe ignition sources. For the fire growth and spread tests, initial ignition sources ranging from the TB 133 gas burner to and including large trash bags, were used. These tests allow the comparison of the assembly tests conducted in the large-scale Furniture Calorimeter with actual fire growth inside the rail car where the HRR may change due to the effects of the car geometry and/or proximity of materials to each other.

The Phase III interim report contains a detailed description of the real-scale gas burner tests and the various full-scale ignition source tests conducted in an Amfleet I passenger rail coach car.

7. REFERENCES

1. Peacock, R. D. and E. Braun. *Fire Safety of Passenger Trains: Phase I Material Evaluation (Cone Calorimeter)*. Prepared for Federal Railroad Administration (FRA)/ U.S. Department of Transportation (USDOT). National Institute of Standards and Technology (NIST). Interim Report. Report No. DOT/FRA/ORD-99/01, January 1999. Also published by NIST, Report No. NISTIR 6132.
2. American Society for Testing and Materials (ASTM). *Standard Test Method for Heat and Visible Smoke Release Rates for Materials and Products Using an Oxygen Consumption Calorimeter*. ASTM E-1354. Annual Book of ASTM Standards. Volume 04.07, 1997.
3. Peacock, R. D., et al. *Fire Safety of Passenger Trains: A Review of U.S. and Foreign Approaches*. Prepared for FRA/USDOT. NIST. Final Report. Report No. DOT/FRA/ORD-93/23 and NIST Technical Note 1406, December 1993.
4. Barbu, G. "Fires in Railway Passenger Vehicles: The Feasibility of Computer Simulation." *European Railway Review*, pp 71-75, 1999.
5. FRA. 49 CFR, Transportation, Parts 216, 223, 229, 231, 232, and 238: "Passenger Equipment Safety Standards; Final Rule." *Federal Register*, Vol. 64, No. 91, May 12, 1999. 25540-25705. National Archives and Records Administration, Washington, DC.
6. FRA. "Rail Passenger Equipment; Guidelines for Selecting Materials to Improve Their Fire Safety Characteristics." *Federal Register*, Vol. 49, No. 162, August 20, 1984. Notices. 33076-33078. Reissued in *Federal Register*, Vol. 49, No. 217, November 7, 1984. 44082-44584. U.S. Department of Transportation (USDOT). National Archives and Records Administration, Washington, DC.
7. FRA. "Rail Passenger Equipment: Reissuance of Guidelines for Selecting Materials to Improve Their Fire Safety Characteristics." *Federal Register*, Vol. 54, No. 10, January 17, 1989. Notices. 1837-1840. National Archives and Records Administration, Washington, DC.
8. FRA. 49 CFR, Transportation, Parts 216, 223, 229, 231, 232, and 238: "Passenger Equipment Safety Standards, Notice of Proposed Rulemaking (NPRM)." *Federal Register*, Vol. 62, No.184, September 23, 1997. Proposed Rules. 49728-49824. USDOT. National Archives and Records Administration, Washington, DC.
9. Zicherman, J.B. and S.H. Markos. *DRAFT Recommendations for Revising the Fire Safety Requirements in Federal Railroad Administration Notice of Proposed Rulemaking (NPRM) for Passenger Equipment (September 23, 1997)*. Prepared for FRA/USDOT by Fire Cause Analysis and Volpe Center/USDOT. December 1998.
10. Urban Mass Transportation Administration (UMTA). Now Federal Transit Administration (FTA). "Recommended Fire Safety Practices for Rail Transit Materials

- Selection.” *Federal Register*, Vol. 49, No. 158, August 14, 1984. Notices. 32482-32486. National Archives and Records Administration, Washington, DC.
11. Recommended Practice for Fire Safety Analysis of Existing Passenger Rail Equipment, APTA RP-PS-005-01, American Public Transportation Association, Washington, DC. (Approved November 2, 2000, Authorized January 8, 2001)..
 12. Babrauskas, V. and S.J. Grayson, Eds. *Heat Release Rate in Fires*. New York: Elsevier Applied Science, 1992.
 13. Mitler, H.E. *Comparison of Several Compartment Fire Models: An Interim Report*. NBS. NBSIR 85-3233, 1985.
 14. Jones, W. W. “A Review of Compartment Fire Models.” NBS. Report No. NBSIR 83-2684, 1983.
 15. Forney, G. P. and W. F. Moss. “Analyzing and Exploiting Numerical Characteristics of Zone Fire Models,” *Fire Science and Technology*. Vol.14, Nos 1 & 2, pp 49-60. 1994.
 16. Peacock, R. D., G. P. Forney, et al. *CFAST, the Consolidated Model of Fire and Smoke Transport*. NIST. Technical Note 1299, 1993.
 17. Bechtel, Parsons Brinckerhoff. *Memorial Tunnel Fire Ventilation Test Program Test Report*. Massachusetts Highway Department, Commonwealth of Massachusetts, 1995.
 18. Babrauskas, V., J. R. Lawson, W. D. Walton, W. H. Twilley, *Upholstered Furniture Heat Release Rates Measured with a Furniture Calorimeter*. NBS. Report No. NBSIR 82-2604, 1982.
 19. Jones, W. W. and R. D. Peacock. *Technical Reference Guide for FAST Version 18*. NIST. Technical Note 1262, 1989.
 20. National Fire Protection Association (NFPA). *Code for Safety to Life from Fire in Buildings and Structures*, NFPA 101. Quincy, MA, 2000.
 21. Bukowski, R.H. and S.H. Markos. “Fire Safety of Passenger Trains: Fire Hazard Assessment,” *2nd Fire Risk and Hazard Assessment Research Application Symposium*. National Fire Protection Research Foundation. 25-27 June, 1997. San Francisco, CA.
 22. ASTM. *Guide for Fire Hazard Assessment of Rail Transportation Vehicles*. ASTM E-2061-00. West Conshohocken, PA, 2000.
 23. Bukowski, R. W., et al. “Fire Hazard Assessment Method,” *NIST Handbook 146*, 1989.
 24. Hagiwara, I. *Brief Notes on Egress Time Calculation Program*. NIST. *Internal Communication*. 1997.
 25. “EXODUS Model.” *Fire Engineers Journal*, Vol, 56, No. 183, p 26, July 1996.

26. Fleming, J.M. "Code Official's View of Performance-Based Codes." *Fire Suppression and Detection Research Application Symposium. Research and Practice: Bridging the Gap. Proceedings. NFPA Research Foundation. February 12-14, 1997, Orlando, FL*, pp. 234-251, 1997.
27. Gross, D. "The use of fire statistics in assessing the fire risk of products, in *Interflam 1985 Conference Workbook*. No. 26-28. Pp. 11-18, March 1985.
28. Karter, M. J., Jr. "Fire loss in the United States during 1984," *Fire Journal*. Vol. 79, No. 3: pp 67-70, 73, 75-76, September 1985.
29. Aherns, M. *Selections from U.S. Vehicle Fire Trends and Patterns for Rail Transport Vehicle Fires: U.S. Rail Passenger or Diner Car Fires 1986-1997*. Prepared for Volpe Center/US DOT. NFPA. Quincy, MA. 1999.
30. Smith, E.E. "Fire Safety Evaluation of Rapid Transit System." Phase I Report to the Transit Development Corporation, Washington, D.C., unpublished, 1976.
31. Smith, E.E. "Fire Safety Evaluation of Rapid Transit Systems." *Proceedings of the International Conference on Fire Safety, January 17 to 21, 1983*. San Francisco, CA, 1983.
32. Braun, E. *Fire Hazard Evaluation of the Interior of WMATA Metrorail Cars*. Prepared for Washington Metropolitan Area Transit Authority. NBS. NBSIR 75-971, December 1975.
33. Braun, E. *Fire Hazard Evaluation of BART Vehicles*. Prepared for UMTA/USDOT. NBS. NBSIR Report No. 78-1421, March 1978.
34. Hathaway, W.T. and I. Litant. *Assessment of BART Fire Hardening Program*. Prepared by Transportation Systems Center (TSC), USDOT for UMTA/USDOT. Final Report. Report No. UMTA-MA-06-0060-82-3, November 1982.
35. Hathaway, W.T., S.H. Markos, and J.B. Baker. *Review of BART "C" Car Fire Safety Characteristics*. Prepared by TSC, USDOT. Prepared for UMTA/USDOT. Final Report. Report No. UMTA-MA-06-0718-87-1, September 1987.
36. Barnett, J.R. *Development of Analytical Techniques for Risk Management Training*. Worcester Polytechnic Institute. Prepared for FTA/USDOT. University Research Final Report. Report No. DOT-MA-11-0050-92-1, October 1992.
37. Parker, A. "Fire Testing of Mass Transit Assemblies" *4th International Fire and Materials Conference*. Washington, D.C. November 15-16, 1995. Conference Proceedings. Interscience Communications, Ltd. London, 1995.
38. Schirmer Engineering Corporation. *Life Safety Study and Computer Modeling Analysis for New York City Railroad Tunnels and Pennsylvania Station*. Contract to the National Railroad Passenger Corporation, Sec No. 15-890-29-04-00. 1990.

39. Burdett, J.R.F., S.A. Ames, and P.J. Fardell. "Selection of Materials and Composites to Minimize Fire Hazard," in *King's Cross Underground Fire: Fire Dynamics and the Organization of Safety*. The Institution of Mechanical Engineers. London, 1989.
40. Gandhi, Sanjeev, R.T. Long, and J.G. Quintiere. *Fire Tests of Passenger Rail Car Interior Materials*. Submitted to National Transportation Safety Board (NTSB). University of Maryland. Contract No. NTSB12-96-SP-034. Final Report. September 26, 1996.
41. National Transportation Safety Board (NTSB). *Railroad Accident Report: Derailment and Collision of Maryland Rail Commuter MARC Train 286 with National Railroad Passenger Corporation Amtrak Train 29, near Silver Spring, Maryland, on February 16, 1996*. Adopted: July 3, 1997. Washington, DC. Report No. NTSB/RAR-97/02.
42. Peacock, R.D. and E. Braun. *Fire Tests of Amtrak Passenger Rail Vehicle Interiors*. Prepared for FRA/USDOT. NBS. Technical Note 1183, 1984.
43. Braun, E., S. Davis, J.C. Klote, B.C. Levin, and M. Paabo. *Assessment of the Fire Performance of School Bus Interior Components*. NIST. Report No. NISTIR 4347, 1990.
44. National Highway Traffic Safety Administration (NHTSA), *49 CFR, Transportation, Part 571, Federal Motor Vehicle Safety Standards, Subpart 571.302, Flammability of Interior Materials - Passenger Cars, Multi-Purpose Passenger Vehicles, Trucks, and Buses*. National Archives and Records Administration. Washington, DC. As of October 1, 2001.
45. Young, R. "Behaviour of Rail Vehicles Components in Fires." *Proceedings of Materials in Mass Transport*, May 26, 1988. Rapra Technology Limited, Shawbury, UK. 1988.
46. Malhotra, H.L. "Fire Protection in Channel Tunnel Car Carrying Shuttles." *Proceedings of Interflam '93, 6th International Fire Conference*. Interscience Communications, Ltd. London, 1993.
47. Young, Roy. "Development of Heat Release Techniques Within European Railways." *Proceedings of the Fire Safety by Design Conference*. University of Sunderland, UK. Volume 3, 1995.
48. Göransson, U. and A. Lundqvist. *Fires in Buses and Trains, Fire Test Methods*. Swedish National Testing and Research Institute, Sweden. SP Report No. 1990: 45, 1990.
49. ERRI. Working Party B 106.2. *Coaches; Reasons for Undertaking Supplementary Studies on Improvement of Protection of Coaches Against Fire*. ERRI B 106 RP 22. Utrecht, July 1992.
50. ERRI. Working Party B 106.2. *Coaches; Feasibility Study of Computer Modeling of Fires in Railway Vehicles with a View to Improving Passenger Safety*. ERRI B 106 RP

25. Utrecht, November 1992.
51. ERRI. Young, R. and S. Metral. Edited by A. Kaminski, ERRI Technical Advisor. *Improvement of the Protection Against Fire of Passenger Rolling Stock; Progress Report on the Tests Carried Out Using A Cone Calorimeter and the Calculations with HAZARD 1.1 Software Package.* ERRI C 204/RP 1. Utrecht, June 1994.
 52. ERRI. *Improvement of the Fire Protection of Passenger Rolling Stock; Progress Report on the Tests Carried Out Using A Cone Calorimeter and the Furniture Calorimeter and on the Calculation with the HAZARD 1.1 Software Package.* ERRI C 204/RP 2. Utrecht, 1995.
 53. ERRI. *Improvement of Fire Protection Against Fire of Passenger Rolling Stock; Final Report on the Feasibility Study into Computer Modeling of Fire in a Railway Vehicle.* ERRI C204.1/RP3. Utrecht, June 1997.
 54. ERRI. Metral, S., J. Wolinska, and G. Barbu. *Improvement of the Protection Against Fire of Passenger Rolling Stock; Results of Laboratory Tests using a Cone Calorimeter to Provide Data for Computation.* ERRI C204.1/DT301. Utrecht, 1994.
 55. ERRI. Young, R. Scientifics/British Railway Board. Edited by A. Kaminski, ERRI Technical Advisor. *Improvement of the Fire Protection of Passenger Rolling Stock; Results of Additional Cone Calorimeter Tests on Seat Materials and Furniture Calorimeter Tests on Mock-Up Seats.* ERRI C204.1/DT319. Utrecht, June 1995.
 56. ERRI. Metral, S., J. Wolinska, and G. Barbu. *Improvement of Fire Protection of Passenger Rolling Stock; Computer Simulation of the Fire Process Within Railway Passenger Coaches Using the HAZARD 1.2 Software.* ERRI C204.1/DT358. Utrecht, November 1997.
 57. *Fires in Transport Tunnels, Report on Full-Scale Tests, EUREKA Project 499: FIRETUN.* Editor Studiengesellschaft Stahlanwendung e.V., D-40213 Düsseldorf, Germany, November 1995.
 58. Heskestad, G. *Similarity Relations for the Initial Convective Flow Generated by Fire,* FM Report 72-WA/HT-17, Factory Mutual Research Corporation. Norwood, MA, 1972.
 59. Schifiliti, R. P. "Design of Detection Systems," Section 3/Chapter 1, *SFPE Handbook of Fire Protection Engineering*, First edition, Phillip J. DiNenno, P.E., editor-in-chief. Society of Fire Protection Engineers (SFPE). Boston, MA, 1988.
 60. Heskestad, G. and M. A. Delichatsios. *Environments of Fire Detectors - Phase I: Effect of Fire Size, Ceiling Height, and Material. Volume 2. Analysis.* NBS. NBS-GCR-77-95, 1977.
 61. Stroup, D.W. and D. D. Evans. "Use of Computer Models for Analyzing Thermal Detector Spacing," *Fire Safety Journal*. Vol. 14, pp 33-45, 1988.

62. NFPA. *National Fire Alarm Code*. Quincy, MA, 2000.
63. Bukowski, R.W. "A Review of International Fire Risk Prediction Methods," *Interflam '93. Fire Safety. 6th International Fire Conference March 30-April 1, 1993, Oxford England*. C.A. Franks, editor, Interscience Communications, Ltd., London, England, pp 437-466, 1993.
64. Madrzykowski, D. and R. L. Vettori. *Sprinkler Fire Suppression Algorithm for the GSA Engineering Fire Assessment System*. NIST. NISTIR 4833, 1992.
65. Washington Post, pp. A01-A03, Wednesday, March 17, 1999.
66. National Transportation Safety Board (NTSB). *Railroad Accident Report: Derailment and Collision of Maryland Rail Commuter MARC Train 286 with National Railroad Passenger Corporation Amtrak Train 29, near Silver Spring, Maryland, on February 16, 1996*. Adopted: July 3, 1997. Washington, DC. Report No. NTSB/RAR-97/02.
67. NTSB. *Railway Marine Accident Report: Derailment of Amtrak Train No. 2, on the CSXT Big Bayou Canot Bridge Near Mobile, Alabama, September 22, 1993*. Adopted: March 21, 1995. Washington, DC. Report No. NTSB/RAR-95/02.
68. NTSB. *Railroad Accident Report - Fire Onboard Amtrak Passenger Train No. 11, the Coast Starlight, Gibson, California, June 23, 1982*. Adopted: April 19, 1983. Washington, DC. Report No. NTSB/RAR-83/03.
69. Lord Cullen. *Ladbroke Grove Rail Inquiry Part 1 Report*. Health and Safety Commission. Great Britain. 2001.
70. Norwegian public report. *The Åsta accident, January 4th 2000*. NOU 2000:30.
71. "Investigation by HM Railway Inspectorate Into a Fire on a High Speed Train Near Maidenhead on Friday 8 September 1995." Press release. Maidenhead, UK, January 16, 1996.
72. Hellicar, J. "Lessons from the Maidenhead Train Fire." *Escape from Trains*. Seminar, Heathrow, UK. June 9-10, 1997. Independent Technical Conferences, Ltd. 1997.
73. "New Protection for Rolling Stock is to Follow Train Fire." *FIRE*, Volume 77, Number 950: p 11, August 1984.
74. Department of Transport. *Railway Accident: Report on the Fire that Occurred in a Sleeping-Car Train on 6th July 1978 at Taunton in the Western Region, British Railways*. Her Majesty's Stationery Office. London, November 15, 1979.
75. Channel Tunnel Safety Authority. *Inquiry into the Fire on Heavy Goods Vehicle Shuttle 7539 on 18 November 1996*. Her Majesty's Stationery Office. London, May 1997.
76. Transportation Safety Board of Canada. *VIA Rail Canada Inc. - Fire Onboard Amtrak Passenger Train No. 66 - Struck a Piece of Rail on the Track - Mile 242.07, - CN North*

- American Kingston Subdivision - Brighton, Ontario - 22 November 1994. Report No. R94TO357.*
77. ASTM. *Fire Tests of Building Construction and Materials*. ASTM E 119, Annual Book of ASTM Standards, Vol. 04.07, Part IV, 1997.
 78. Quintiere, J. *Interpretive Report: Flammability and Smoke Compliance and Fire Analysis*. Submitted to NTSB, Department of Fire Protection Engineering, University of Maryland. Final Report December 19, 1996.
 79. Bukowski, R.W. *Effect of Diesel Fuel on the Increase of Rail Car Interior HRR*. NIST. Letter Report. May 2001.
 80. Kennedy, W. D., R. E. Richard, and J. W. Guinan. "A Short History of Train Fire Heat Release Calculations," *1998 Annual American Society of Heating, Refrigeration, and Air-Conditioning Engineers Conference, Toronto, Canada, June 20 - 24, 1998*.
 81. NFPA. *Standard for Fixed Guideway Transit and Passenger Rail Systems, NFPA 130*, Quincy, MA. 2000.
 82. Bell, C. R. *Heat Hot Work, in Encyclopedia of Occupational Health and Safety, V. 1*. New York, NY, McGraw-Hill, 1972.
 83. Gann, R. G., V. Babrauskas, R. D. Peacock, J. R. Hall, Jr., "Fire Conditions for Smoke Toxicity Measurement." *Fire and Materials*, Vol. 18, No. 3, pp 193-199, 1994.
 84. Jin, R. "Visibility Through Fire Smoke in Main Reports on Production, Movement, and Control of Smoke in Buildings." *Japanese Association of Fire Science and Engineering*, pp. 100-153, 1974.
 85. Purser, D. A. "Toxicity Assessment of Combustion Products" in *Society of Fire Protection Engineers (SFPE) Handbook of Fire Protection Engineering*, 2nd Edition. Ed. by DiNunno, et. al. NFPA, Quincy, MA, pp. 2-85 - 2-146, 1995.
 86. Peacock, R. D., P. A. Reneke, et al. *A User's Guide for FAST: Engineering Tools for Estimating Fire Growth and Smoke Transport*, NIST. Special Publication 921, 1997.
 87. State of California Technical Bulletin (TB) 133, *Flammability Test Procedure for Seating Furniture for Use in Public Occupancies*. Department of Consumer Affairs, Bureau of Home Furnishings and Thermal Insulation. January 1981.
 88. Amtrak. *Specification for Dining Car Food Service Equipment, Specification 350*. National Railroad Passenger Corp., Philadelphia, PA. 1991.
 89. Galea, E. R. and S. Gwynne. *Evacuating an Overturned Smoke Filled Rail Carriage*, CMS Press. Report No. 00/IM/55, CMS Press, London, 2000.
 90. Zicherman, J. B. and S. H. Markos. *Passenger Rail Car Seat Fire Tests ASTM E 1537/CAL TB 133*. Prepared for FRA/USDOT by Fire Cause Analysis and Volpe Center,

- USDOT. Internal Project Memorandum, 1998.
91. Underwriters Laboratories, *Preliminary Flammability and Smoke Characteristics Tests*. Prepared for BP Chemicals. File Reference R14268. Personal communication with Mektech Composites, Inc. 1991.
 92. Amtrak. *Smoke Alarm System for Passenger Cars, Amtrak Specification 307*. National Railroad Passenger Corp., Philadelphia, PA. 1991.
 93. Hansell, G. "Smoke Control in the 21st Century." *Fire Engineers Journal*, Vol. 56, No. 182, pp 25-32, May 1996.
 94. Klote, J. H. and J. Milke. *Design of Smoke Management Systems*, published jointly by the American Society of Heating, Refrigerating, and Air-Conditioning Engineers (ASHRAE) and SFPE. Atlanta, ASHRAE 1992.
 95. Hill, R. G.; T. R. Marker, and C. P. Sarkos, "Evaluation and Optimization of an On-Board Water Spray Fire Suppression System in Aircraft." *Water Mist Fire Suppression Workshop. Proceedings. March 1-2, 1993, Gaithersburg, MD*. Notarianni, K. A.; Jason, N. H., Editors, pp. 93-103. NIST. 1993.
 96. Hansen, R. "USCG Full Scale Water Mist Testing Vertical and Horizontal Scaling." NIST and SFPE. *International Conference on Fire Research and Engineering. Proceedings. September 10-15, 1995, Orlando, FL*. SFPE, Lund, D., P. Angell, E. A., Editors, Boston, MA, pp 115-118, 1995.
 97. Back, G. G.; P. J. DiNenno, J. T. Leonard, and R. L. Darwin, "Full Scale Tests of Water Mist Fire Suppression Systems for Navy Shipboard Machinery Spaces. Parts 1 and 2 (Unobstructed and Obstructed Spaces)." NRL/MR/6180-96-7830; p March 8, 1996.
 98. Mawhinney, J. R. "Design of Water Mist Fire Suppression Systems for Shipboard Enclosures." In *Proceedings of the International Conference on Water Mist Fire Suppression Systems*." Swedish National Testing and Research Institute, SP Report 1994:03, Boras, Sweden, November 4-5, 1993, pp. 16-44.
 99. Proulx, G. "To Prevent 'Panic' in an Underground Emergency: Why Not Tell People the Truth?" *International Association for Fire Safety Science. Fire Safety Science. Proceedings. 3rd International Symposium. July 8-12, 1991*. Edinburgh, Scotland Cox, G. and Langford, B., Editors Elsevier Applied Science, New York., pp 843-852, 1991.
 100. Proulx, G. "Misconceptions About Human Behavior in Fire Emergencies." *Canadian Consulting Engineer*. NRCC 40691, 1997.
 101. FRA. 49 CFR, Transportation, Part 239 "Passenger Train Emergency Preparedness" *Federal Register*, Vol. 63, No.85, May 8, 1998. 24630-24683. USDOT. National Archives and Records Administration, Washington, DC.

102. Bukowski, R.W., R.D. Peacock, W.W. Jones. *Sensitivity Examination of airExodus Aircraft Evacuation Simulation Model*. NIST. 1998.

APPENDIX A. PASSENGER RAIL CAR INTERIOR MATERIAL ASSEMBLY TESTS

This appendix describes a series of tests conducted to measure the HRR of selected real-scale assemblies representing the important materials currently in use in U.S. intercity passenger trains. These tests were conducted to obtain appropriate inputs for the fire hazard analysis discussed in Chapter 4. Discussion is included for the specific materials tested, the results of the real-scale furniture calorimeter tests, and the use of the data as inputs for the fire hazard analysis.

A.1 HRR MEASUREMENT OVERVIEW

The measurement that has benefitted the most from the emergence of science in fire testing is the measurement of the HRR of a fire. With few exceptions [1][2], this is calculated by the use of the oxygen consumption principle, and has been applied in both small scale and large scale. If all the exhaust from a fire test is collected, measurement of temperature, velocity, and oxygen, carbon dioxide, carbon monoxide, and water vapor concentrations in the exhaust collection hood can be used to estimate the rate of energy production of the fire. With these measurements, the total rate of heat release from the fire can be determined [3]. Simplifications are available, with some loss of precision, if concentrations of some of the gas species are not measured. This technique has been used extensively in both small- and large-scale testing [4][5][6][7][8]. Phase I of this research project examined the HRR of passenger train car materials in small scale, using the Cone Calorimeter [9]. HRR, smoke emission, and gas species yields were determined for a wide range of passenger train car materials. These data provide burning characteristics per unit area of the materials and can be used for both input to fire hazard analysis as well as material screening. Methods to estimate the HRR of the large-scale fire from small-scale test results are necessary to be able to predict fire hazard from small-scale measurements. In some situations, the large-scale HRR of the fire (\dot{q}_{fs}), can be directly and simply correlated to the small-scale HRR. The small-scale HRR (\dot{q}_{bs}''), is measured on a small specimen of fixed face area. Thus, the correlation is simply:

$$(\dot{q}_{fs}) = (\dot{q}_{bs}'') \cdot A$$

For some simple geometries, calculational procedures are available to allow determination of the full-scale burning behavior directly from small-scale data. For most materials, determination of the burning area, A , must be done empirically by comparing small-scale data to large-scale data and may be a function of more than just the HRR.

Although larger in scale, instrumentation, data collection, and test measurements in a Furniture Calorimeter are similar to those used in the Cone Calorimeter. The Furniture Calorimeter test assesses the burning behavior of single or multiple burning items [10][11]. It is used to measure the HRR of the items in an end-use scale and configuration without the added effects of other materials or geometry that would be present in full-scale testing of an entire rail car. Several standards provide guidance on the design and instrumentation of large-scale calorimeters [12][13][14] each with details of sample preparation and ignition particular to the application. Like the small-scale Cone Calorimeter, the primary measurement obtained from the large-scale Furniture Calorimeter is the HRR of the burning sample. The ignition source is different between the standards, and thus is more dependent upon the particular purpose of a testing program. For the assembly tests reported in this study, both a gas burner (reference [13]) and a trash bag typical of those found in long-distance intercity passenger trains were used.

Babrauskas [6] has demonstrated the validity of the large-scale calorimeter measurements in a study of upholstered furniture fires. He provides comparisons between replicate tests in the open, and enclosed in a room. He notes precision to within 15 percent for fires of 2.5 MW, and consistent comparisons of HRR expected from mass loss measurements to those measured by oxygen consumption calorimetry.

A.2 TEST APPROACH

This section describes the test apparatus, instrumentation, ignition sources, and time periods used for the series of passenger rail car assembly tests.

A.2.1 HRR Measurement

Figure A-1 shows a schematic of the NIST large-scale Furniture Calorimeter used to measure the HRR of the rail car assemblies tested.

A.2.2 Flux Meter Measurement

In addition to HRR, heat flux from the burning assemblies was measured with a water-cooled heat flux meter located approximately 1 m (3.3 ft) away from the ignition source, with a view angle of 150°. The heat flux measurement provides an indication of the ability of a burning item to ignite other nearby materials.

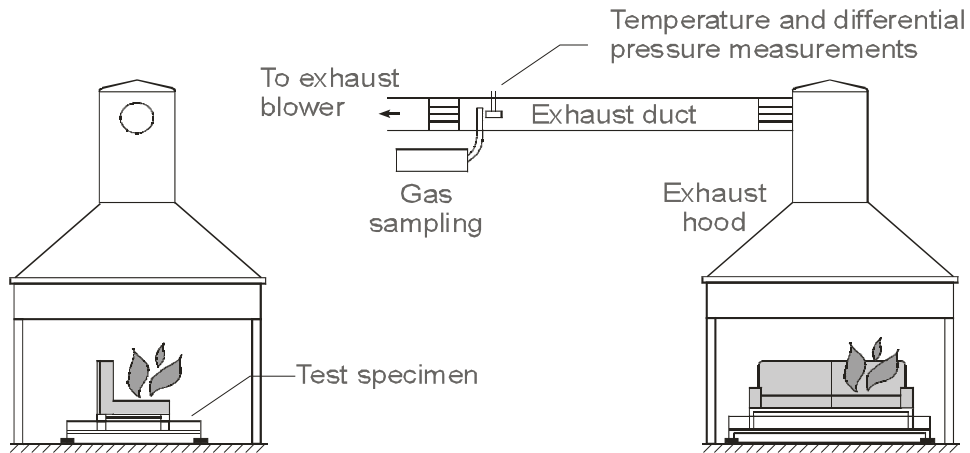

Figure A-1. NIST Large-Scale Furniture Calorimeter

A.2.3 Ignition Sources

Several different initial ignition sources were used in the assembly tests to represent a range of initial fire conditions that may occur in a passenger train fire. These included a square gas sand burner (for Tests 11, 12, and 14), the TB 133 gas burner (for Tests 11 and 12), and a round gas burner (for Test 14).

The TB 133 burner, developed for public occupancies such as nursing homes by Ohlemiller and Villa [15], is used in California for flammability testing of seat furniture [16]. This burner uses a 0.25 m (0.82 ft) square constructed of 0.5 in (13 mm) diameter tube with a series of holes for the flow of gas. It is designed to simulate ignition with several sheets of crumpled newspaper. Details of construction are provided in the TB 133 standard. For the TB 133 test, the burner uses propane at a flow rate of 13 L/min for 80 seconds, and the burner is located 25 mm (1 in) above the seat cushion and 2 in (50 mm) from the back cushion. The nominal HRR of this burner is 17 kW.

In the square burner (Figure A-2), the gas flow was diffused by traveling through a layer of gravel and sand. This type of burner, often called a “sand burner,” was used for HRRs of 25 kW and 50 kW. Both natural gas and propane were used in the sand burner. For all tests where the gas sand burner was used, it was ignited at the start of the test and continued to burn at a constant HRR throughout the experiment.

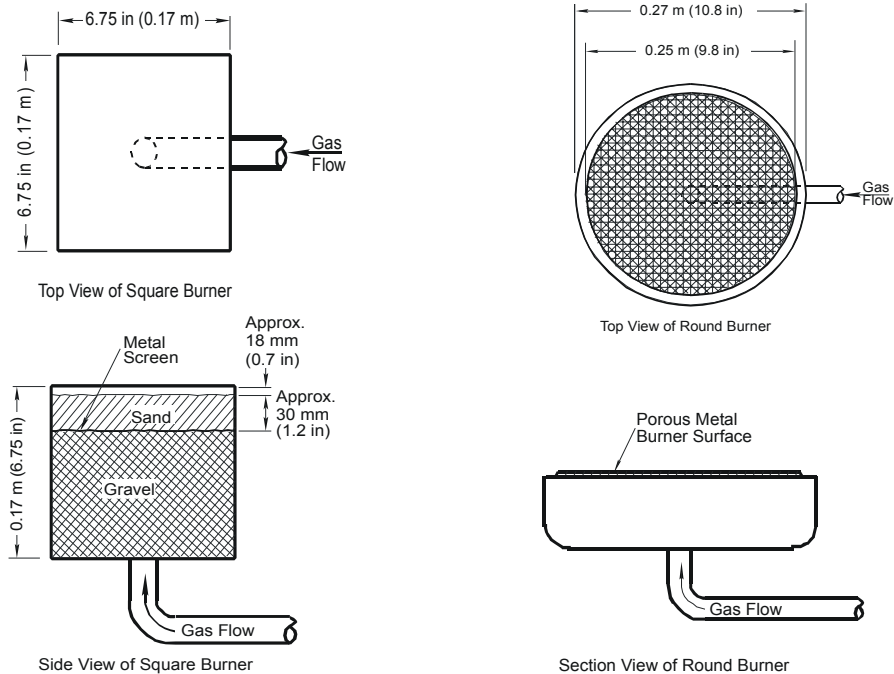

Figure A-2. Square and Round Burners Used as Ignition Sources For Passenger Car Material Assembly Tests

The gas burner for Test 14 was 0.27 m (10.8 in) in diameter (Figure A-2). Gas flow in this round burner is diffused by flowing through porous metal. Natural gas was used for this test. HRR for the test started at 280 kW and was increased to 400 kW approximately 300 s into the test. This test was conducted to study the effect of a larger gas burner ignition source.

For Tests 13, 15-17, and 29, a newspaper-filled trash bag served as the primary ignition source for the test assemblies. This trash bag was designed to simulate the burning characteristics of actual trash bags taken from an Amtrak overnight train and represents a severe ignition source which may be present on the trains.

A.2.4 Test Time Periods

The test time period for the tests ranged from 300 to 1300 s, depending on the assembly and ignition source (see sections A.3 and A.4). The test times for the Amtrak trash bags were 1300 s, while the newspaper-filled trash bag test times were 1260 s. The coach seat test times ranged from 600 to 1200 s. The sleeping compartment test times ranged from 600 to 1000 s. The carpet and window drape test times were 400 s. The door privacy curtain test times ranged from 300 to 500 s. Finally, the window assembly test times ranged from 300 to 700 s.

A.3 MATERIAL ASSEMBLIES INCLUDED IN THIS STUDY

Table A-1 lists the assembly tests conducted. These 29 tests represent a range of materials used in intercity passenger trains and are consistent with those tested in the Cone Calorimeter in Phase I of this project. The tests were arranged in six groups:

- Ten trash bag tests, with six taken from an actual Amtrak overnight train and four filled with newspaper to match the HRR of the trash-filled bags with a more repeatable filling. These newspaper-filled trash bags were used as an ignition source for certain seat, bedding and window assembly tests described below.
- Four coach seat assembly tests to study the burning behavior of entire seating assemblies to varying ignition sources. The assemblies were placed next to a wall surface representative of an Amtrak coach car.
- Three bedding assembly tests in a compartment sized to be representative of an economy sleeping compartment room on an overnight train. Although the construction materials for the bedding assemblies are similar to the seat assemblies, the geometry of the compartments is significantly different from that in a coach car.
- Four wall and ceiling carpet tests. In some configurations, wall and ceiling carpet comprise a significant fraction of the surface area in a car. The extent to which the carpeting supports the spread of fire is a controlling factor in fire spread from a seat assembly to the upper walls and/or luggage rack.
- Six window drape and privacy curtain tests. Like the carpet, drapes and curtains can be a path for fire spread to the upper walls and/or luggage rack.
- Two window assembly tests, including window glazing and window masks from Amtrak coach cars. The window assemblies comprise a significant fraction of the wall surface area in a car.

A.4 DETAILS OF ASSEMBLY TEST CONFIGURATIONS

For each of the assemblies tested, appropriate test configurations were utilized to simulate the passenger rail car environment for a coach car and an economy bedroom compartment. This section presents construction details for these configurations to fully describe the tests conducted using the Furniture Calorimeter.

Table A-1. Assemblies Tested in the Furniture Calorimeter

TEST	ASSEMBLY	IGNITION FIRE
1	Trash bag from Amtrak train, 1.8 kg (4 lb)	Gas sand burner ¹ at 25 kW
2	Trash bag from Amtrak train, 9.5 kg (21 lb)	Gas sand burner ¹ at 25 kW
3	Trash bag from Amtrak train, (5.4 kg (12 lb)	Gas sand burner ¹ at 25 kW
4	Trash bag from Amtrak train, 6.8 kg (15 lb)	Gas sand burner ¹ at 25 kW
5	Trash bag from Amtrak train, 7.3 kg (16 lb)	Gas sand burner ¹ at 25 kW
6	Trash bag from Amtrak train, 5.0 kg (11 lb)	Gas sand burner ¹ at 25 kW
7	Trash bag filled w/newspaper, 8.2 kg (18 lb)	Gas sand burner ¹ at 25 kW
8	Trash bag filled w/newspaper, 2.7 kg (6 lb)	Gas sand burner ¹ at 25 kW
9	Trash bag filled w/newspaper, 2.7 kg (6 lb)	Gas sand burner ¹ at 25 kW
10	Trash bag filled w/newspaper, 2.7 kg (6 lb)	Gas sand burner ¹ at 25 kW
11	Coach seat assembly	TB 133 burner ² at 17 kW
12	Coach seat assembly	TB 133 burner ² at 17 kW
13	Coach seat assembly	Trash bag-filled w/newspaper ^{3,4}
14	Coach seat assembly	Round gas burner ¹ at 280 and 400 kW
15	Lower bed w/bedding and pillow	Trash bag-filled w/newspaper ^{3,4}
16	Lower bed w/bedding and pillow	Trash bag-filled w/newspaper ^{3,4}
17	Upper & lower beds w/bedding, pillow, and window drapes	Trash bag-filled w/newspaper ^{3,4}
18	Wall carpet on wall	Gas sand burner at 50 kW
19	Wall carpet on wall	Gas sand burner at 50 kW
20	Wall carpet on wall and ceiling	Gas sand burner at 50 kW
21	Wall carpet on wall and ceiling	Gas sand burner at 50 kW
22	Window drape (Extended)	Gas sand burner at 25 kW
23	Window drape (Contracted)	Gas sand burner at 25 kW
24	Window drape (Contracted)	Gas sand burner at 25 kW
25	Privacy curtain (Extended)	Gas sand burner at 25 kW
26	Privacy curtain (Contracted)	Gas sand burner at 25 kW
27	Privacy curtain (Contracted)	Gas sand burner at 25 kW
28	Window w/ gaskets, frame, and mask	Gas sand burner at 50 kW
29	Window w/ gaskets, frame, mask, and drapes	Trash bag filled w/newspaper ^{1,4}

1 For these tests, natural gas was used.

2 For these tests, propane was used.

3 The newspaper-filled trash bags were ignited by a 25 kW flame from the sand burner using natural gas.

4 Each newspaper-filled trash bag weighed 2.7 kg (6 lb).

A.4.1 Amtrak Trash Bag Tests

Actual trash bags from an Amtrak overnight train were used in Tests 1 – 6 as illustrated in Figure A-3. The bags were ignited by a 25 kW flame from the sand burner. These trash bags were used to characterize a severe ignition source, representative of those that might be found on trains. The Amtrak trash bag consisted of a plastic bag liner inside a brown paper bag into which the train crew collects trash from receptacles at the ends of each car. The paper bag was 0.8 m (34 in) high, and was about 0.45 m (18 in) in diameter when filled.

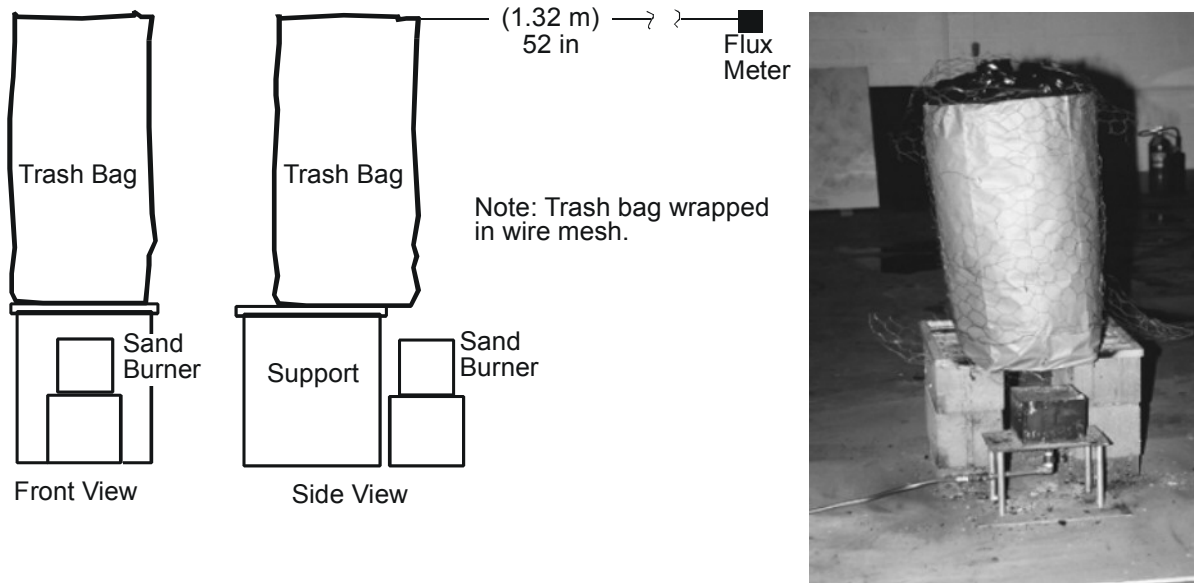

Figure A-3. Trash Bag Tests - Configuration

A.4.2 Newspaper-Filled Trash Bag Tests

Tests 7 – 10 were of newspaper-filled trash bags that used the same plastic bag liner and brown paper bag used for the earlier trash bag tests. These tests were conducted to develop a repeatable fire exposure with a HRR similar to the trash bags examined in Tests 1 – 6. The bag for Test 7 was made of six newspaper bundles and 60 crumpled sheets of newspaper. The bundles, consisting of 50 sheets, folded so that the bundle measured 0.3 m x 0.19 m x 0.038 m (12 in x 7.3 in x 1.5 in). The bundles were wrapped with wire to hold them together. A layer of 10 crumpled sheets was placed in the bag first with a bundle on top, and the following layers were put together in the same way. This bag weighed 8.2 kg (18 lb).

For Tests 8 – 10, the bag was filled with 110 sheets of crumpled newspaper without any newspaper bundles. The newspaper sheets were crumpled just tightly enough so that the bag

was filled to the top. This bag weighed 2.7 kg (6 lb). This same bag construction was used for the other experiments (Tests 13, 15, 17 and 29) that were ignited by a newspaper-filled trash bag fire.

A.4.3 Coach Seat Tests

The seat was an Amfleet double coach seat assembly, including two seat cushions and two back cushions in the configurations illustrated in Figure A-4. The seats were located next to a wall with a luggage rack similar to that of a coach car. These tests were conducted to characterize the burning behavior of entire seat assemblies exposed to varying ignition sources.

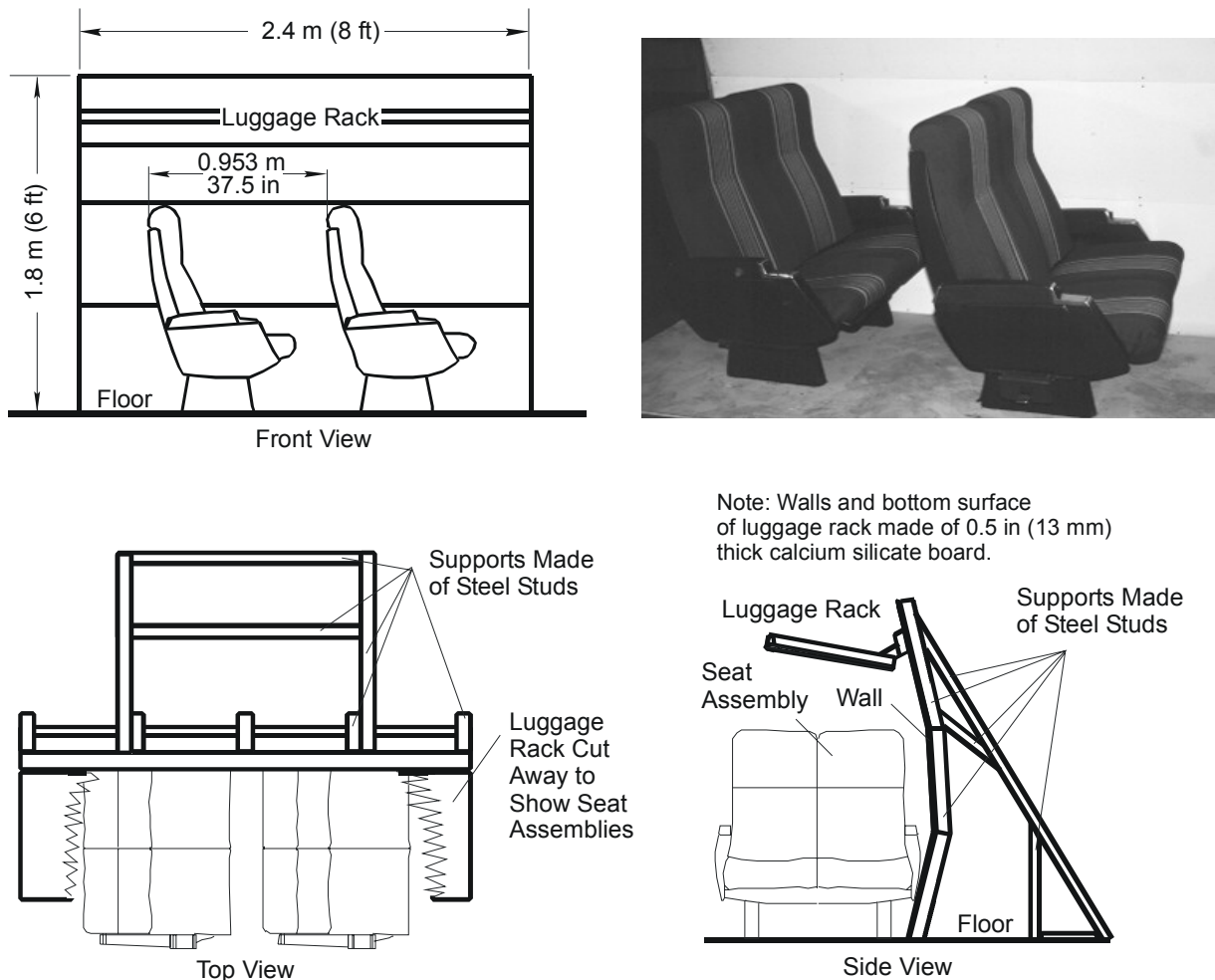

Figure A-4 . Coach Seat Assembly Tests - General Configuration

Tests 11 and 12 used the TB 133 burner as shown in Figure A-5. Test 13 used a newspaper-filled trash bag (Figure A-6), and Test 14 used the round burner (Figure A-7)

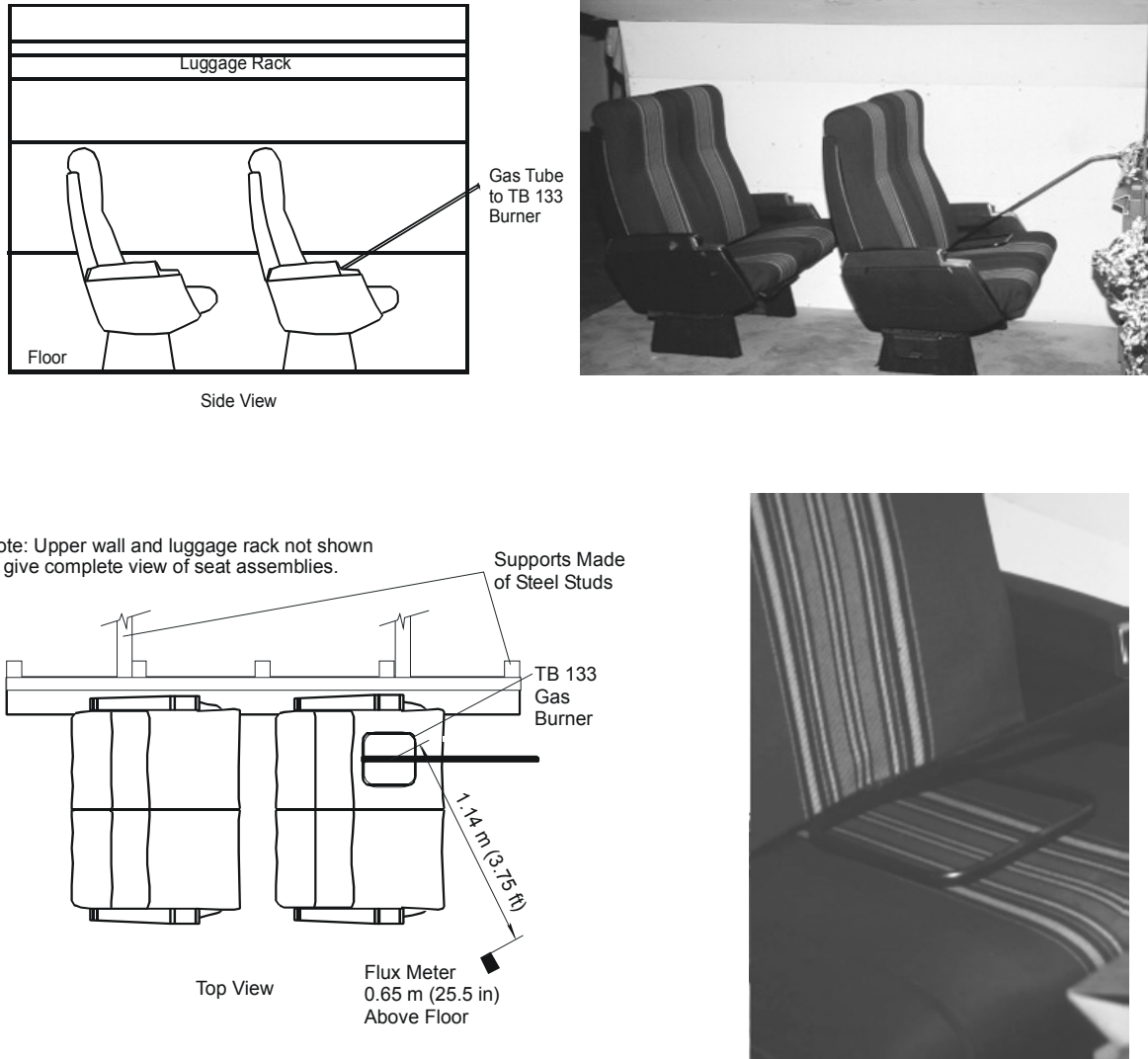
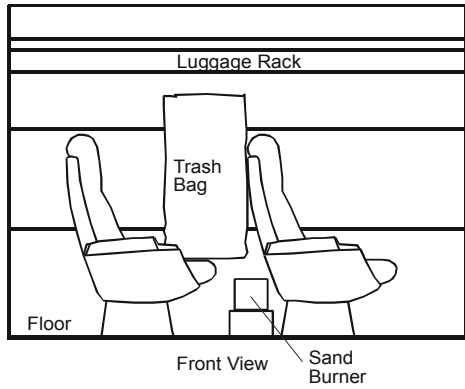

Figure A-5. Coach Seat Assembly Test - TB 133 Burner Ignition Source



Note: Upper wall and luggage rack not shown to give complete view of seat assemblies.

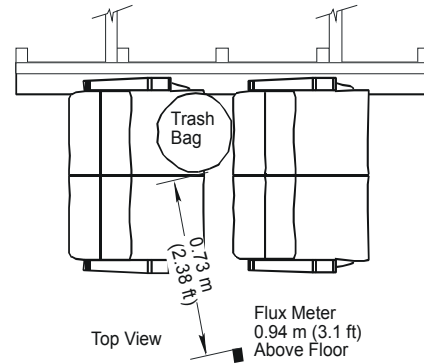
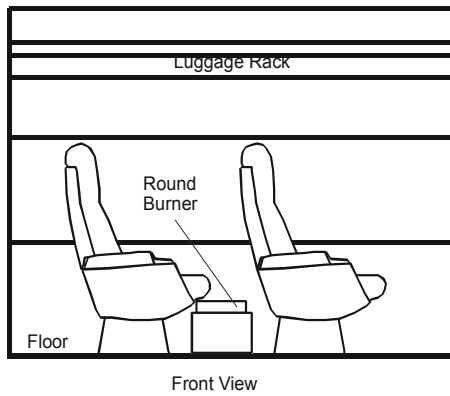

Figure A-6. Coach Seat Assembly Test - Trash Bag/Gas Sand Burner Ignition Source



Note: Upper wall and luggage rack not shown to give complete view of seat assemblies.

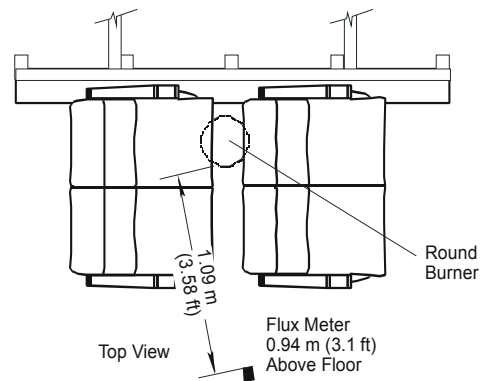

Figure A-7. Coach Seat Assembly Test - Round Gas Burner Ignition Source

A.4.4 Sleeping Compartment Economy Bedroom Assembly Tests

The bed configuration as shown in Figures A-8 a and 8 b was used for Tests 15-17. This configuration is an approximation of the shape of the Superliner II economy room with both upper and lower beds. These tests were conducted to characterize the burning behavior of complete bedding assemblies. Although the construction materials for the bedding assemblies are similar to the seating assemblies, the geometry of the compartments is significantly different from that of the coach car. A trash bag was placed on the lower berth and ignited using the gas sander burner for all three tests.

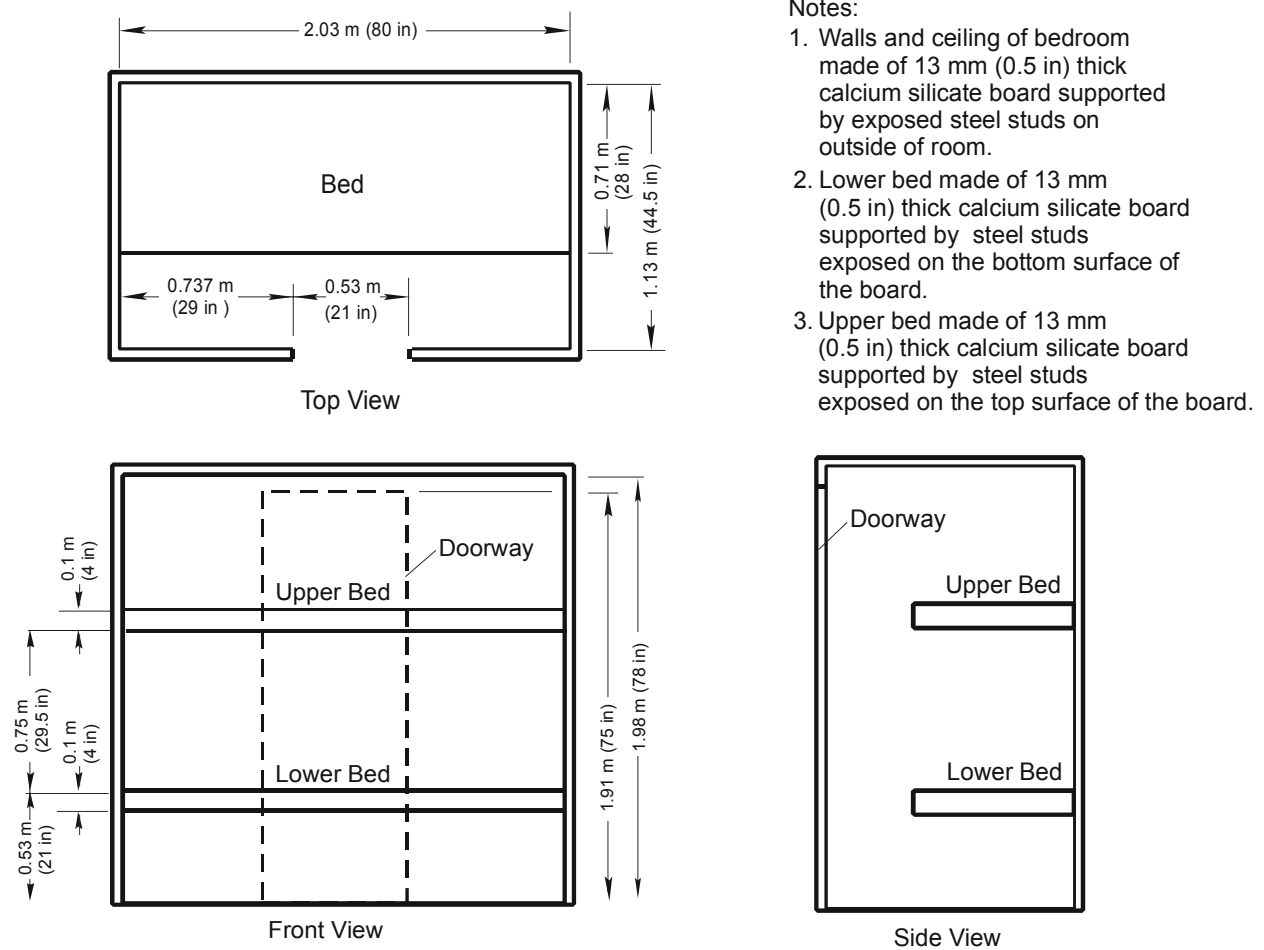

Figure A-8 a. Sleeping Compartment Economy Bed Assembly Tests - General Configuration



Figure A- 8 b. Sleeping Compartment Economy Bedroom Assembly Tests - General Configuration of Lower and Upper Berths

Tests 15 and 16 were lower bed tests. The lower bed had the same seat cushions, back cushions, mattress pad, sheets, blanket, pillow, and pillow case as the Superliner sleeper economy room. Cushions were also attached to the walls in the location of the upper back seat cushions (Figure A-9). These tests used a newspaper-filled trash bag. Test 17 was the upper and lower bed test; the upper berth had a mattress pad, sheets, blanket, pillow, and pillow case; window drapes were also extended along the back wall of the compartment (Figure A-10).

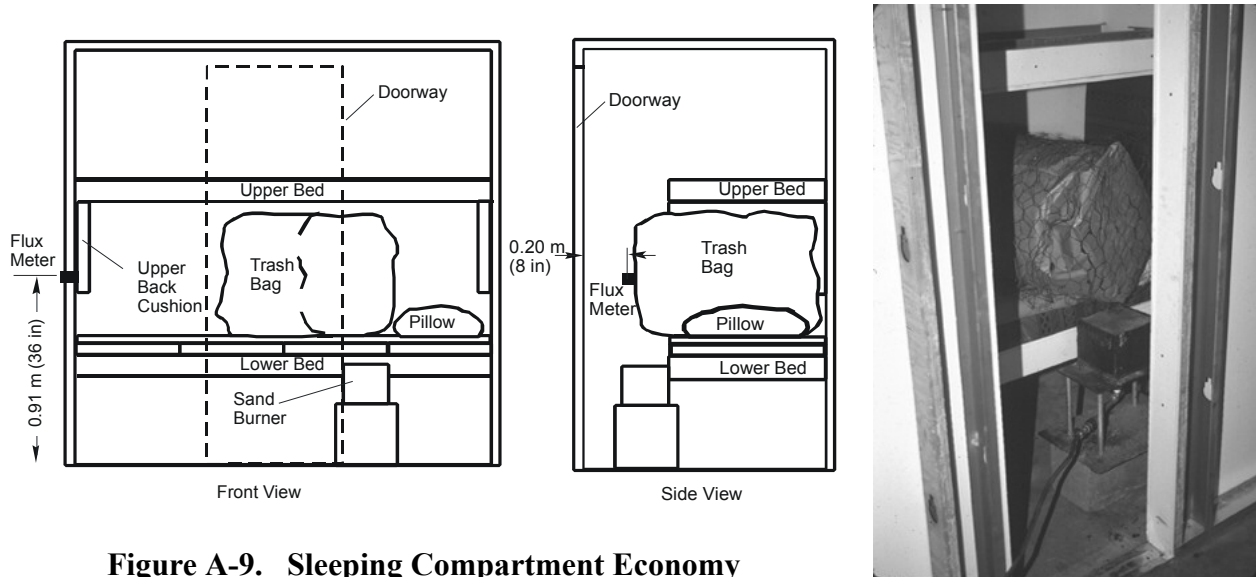

Figure A-9. Sleeping Compartment Economy Bedroom - Lower Berth with Trash Bag / Gas Sand Burner Ignition Sources

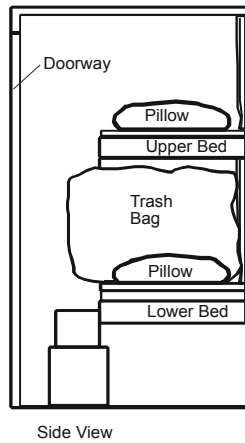
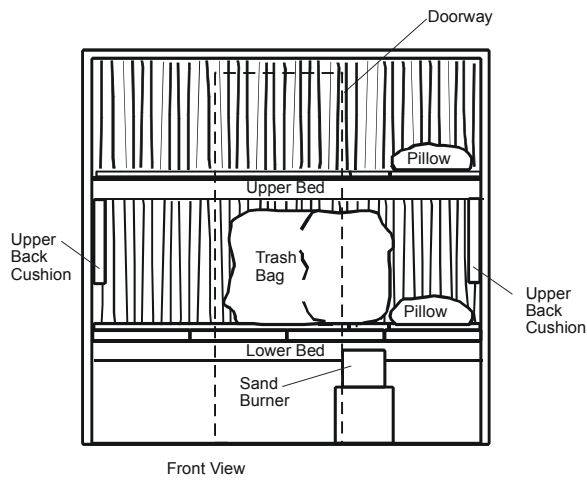

Figure A-10. Sleeping Compartment Economy Bedroom Assembly Tests - Upper and Lower Berths with Trash Bag/Gas Sand Burner Ignition Source

A.4.5 Wall and Ceiling Carpet Tests

The same configuration was used for both the wall and ceiling carpet (and the window drape/door privacy curtains) tests (Figure A-11).

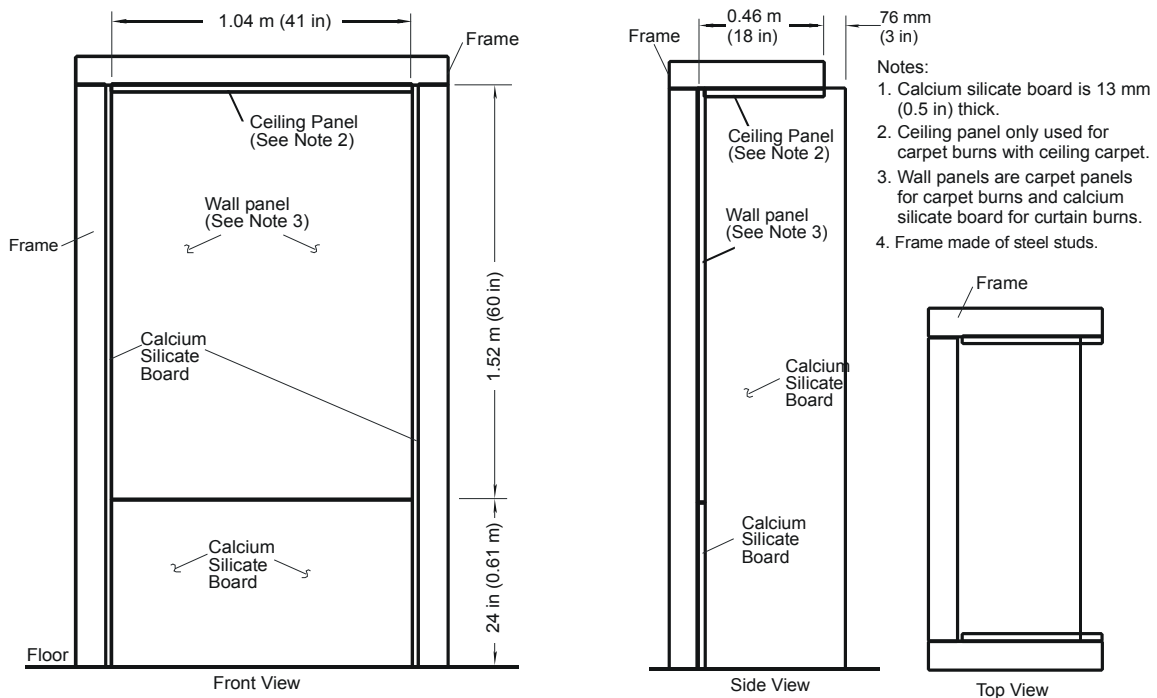

Figure A-11. General Configuration for Wall Carpet, Window Drape and Door Privacy Curtain Tests

Figure A-12 shows the configuration for the carpet tests. The test frame was designed so that wall and ceiling carpet panels could be replaced between tests. The wall carpet panels were 1.04 m (41 in) by 1.52 m (60 in), and the ceiling panels were 0.46 m (18 in) by 1.04 m (41 in). These panels were constructed of carpet attached to perforated aluminum sheet, duplicating the materials and assembly found in Amtrak trains. The aluminum sheet was 2.06 mm (0.081 in) thick with 4.76 mm (0.188 in) holes on staggered 7.94 mm (0.313 in) centers, and the carpet was attached with a rubber-based aerosol spray adhesive according to the manufacturer's instructions. This adhesive was the same brand that is used at Amtrak car refurbishing facilities. After the carpet panels were constructed, they were allowed to set for 5 days before they were burned. Foil-faced fiberglass insulation was placed in back of the carpet panels with the foil side adjacent aluminum sheet as is the practice in Amtrak cars.

Tests 18 and 19 were of wall carpet but without ceiling carpet. Without the ceiling panel in place, the top of the test frame was open to flow. Tests 20 and 21 included the ceiling carpet panels. For all the carpet tests, the carpet was exposed to a 50 kW flame from the sand burner.

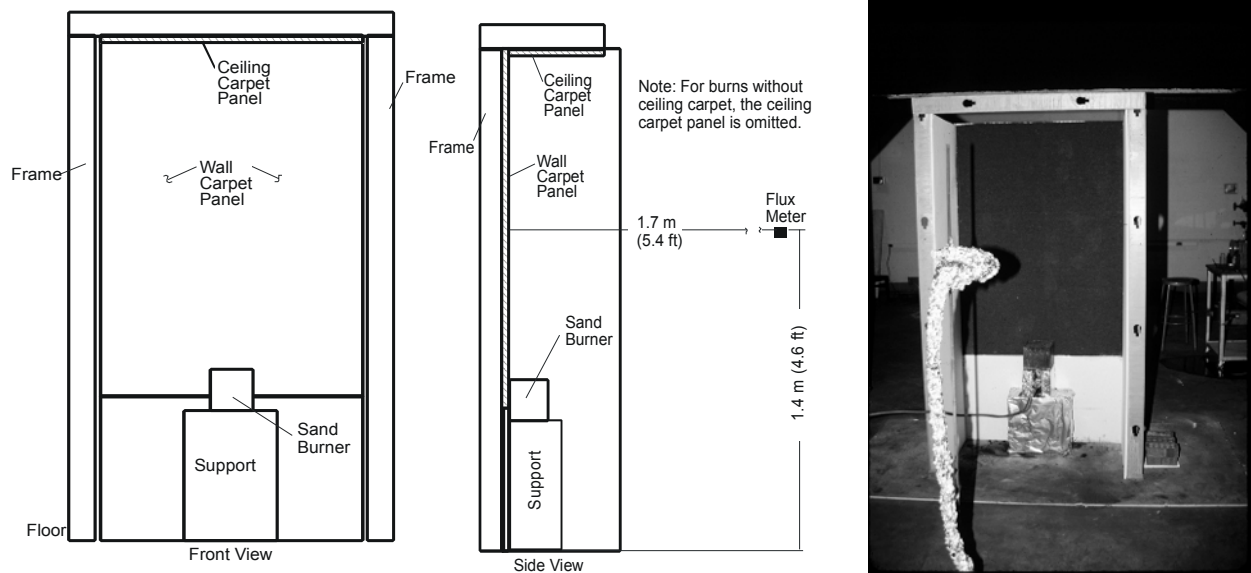

Figure A-12. Wall and Ceiling Carpet Assembly Tests - General Configuration with Gas Sand Burner Ignition Source

A.4.6 Window Drape and Door Privacy Curtain Tests

On Amtrak trains, drapes line the windows in coach and sleeping cars. For overnight service, sleeping compartments have drapes on the windows and privacy curtains on the inside of the

window wall to the hallway. Both window drapes and privacy curtains were burned. For all the drape/curtain tests, the samples were exposed to a 25 kW flame from the gas sand burner.

The configuration for the window drape tests is shown in Figure A-13. The curtains were attached with screws to the back wall test frame. The curtain was extended for Test 22, and the curtain was contracted for Tests 23 and 24. For these tests, the front of the curtain touched the side of the gas sand burner.

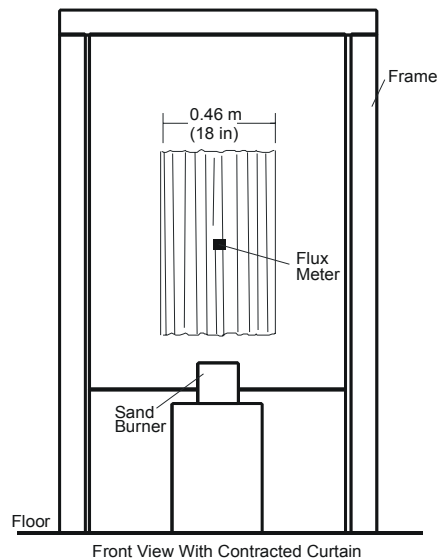
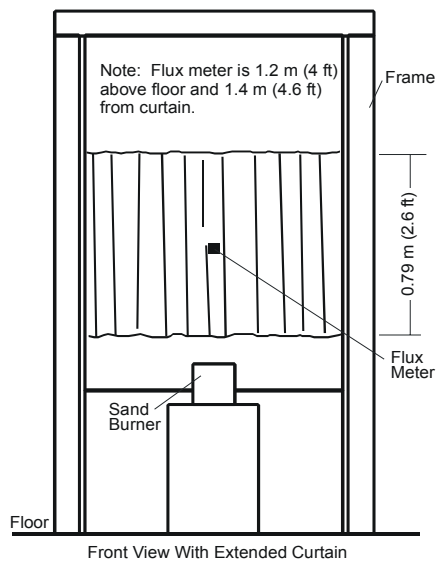

Figure A-13. Window Drape Assembly Tests (Extended and Contracted) - General Configuration with Gas Sand Burner Ignition Source

The configurations for the door privacy curtain tests are shown in Figure A-14 a and b. The curtains were hung from a rod near the front of the test frame [0.46 m (18 in) from the back wall]. The door privacy curtain was extended for Test 25, and the curtain was contracted for Tests 26 and 27. For Tests 25 and 26, the front of the door privacy curtain touched the side of the gas sand burner. In an attempt to improve the contact of the burner flame with the curtain, the door privacy curtain was draped over the burner for Test 27.

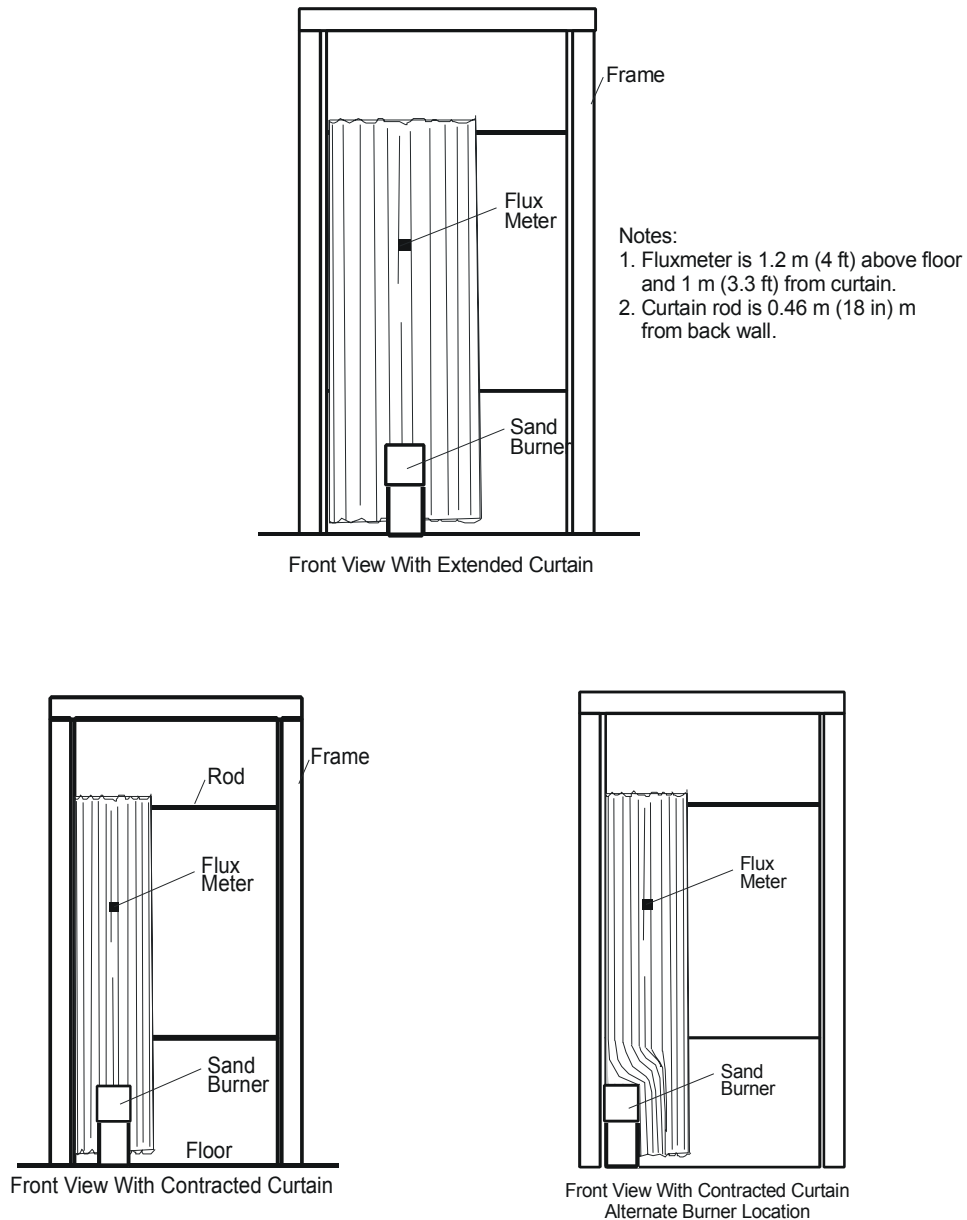

Figure A-14 a. Door Privacy Curtain Test Configuration - Gas Sand Burner Ignition Source (3 Locations)



Figure A-14 b. Door Privacy Curtain Test Configuration -Gas Sand Burner Ignition Source (3 Locations)

A.4.7 Wall Panel and Window Tests

An Amfleet window assembly was constructed of two polycarbonate window panels, window mask, aluminum frame, and gasket set (Figure A-15).

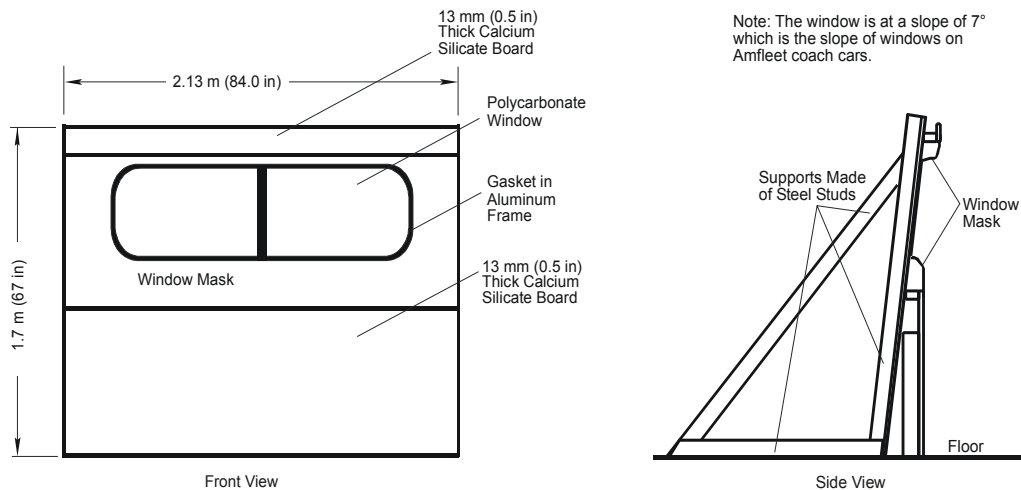

Figure A-15. Test Frame Configuration for Window Assembly Tests

For Test 28, the window assembly was exposed to a flame from the gas sand burner (Figure A-16). The right panel was exposed to the 50 kW flame from the burner with the side of the burner touching the window mask. The damage to the assembly from this test was limited to the right window panel. For Test 29, the window drapes were extended across the left side of the window assembly and a newspaper- filled trash bag was placed against the drapes (Figure A-17).

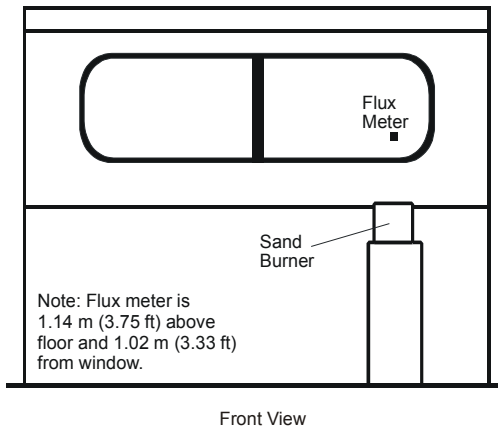

Figure A-16. Wall and Window Assembly Tests - General Configuration With Gas Sand Burner Ignition Source

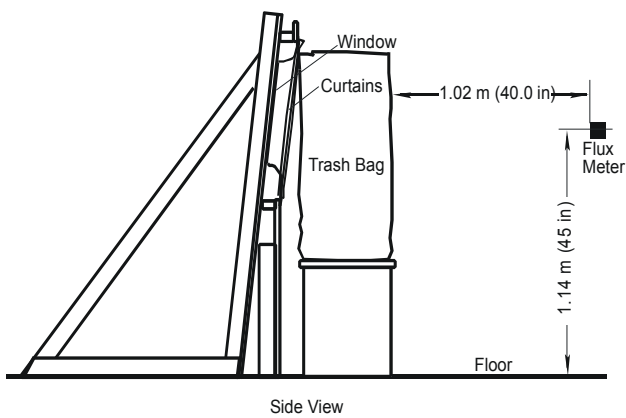
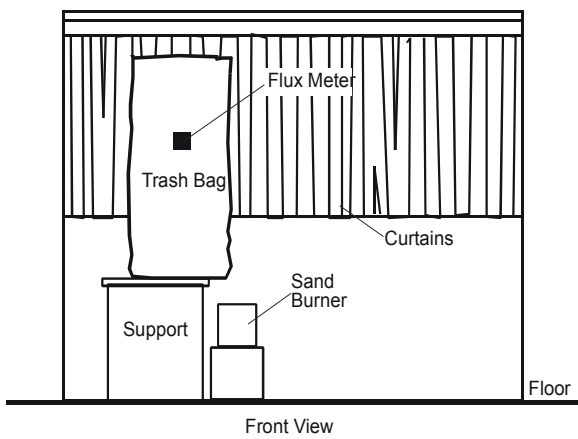

Figure A-17. Window and Drape Tests - Trash Bag/Gas Sand Burner Ignition Source

A.5 TEST RESULTS

Peak HRR values measured during each of the 29 tests conducted are shown in Table A-2, along with the ignition source used, and the nominal HRR of the ignition source. For the assemblies tested, the peak HRR ranged from 27 kW for a coach seat assembly (including the TB 133 burner) to 918 kW for a sleeping compartment assembly (including both lower and upper berths, bedding, window drapes, and a trash bag ignition source). Each of the assemblies is discussed in more detail below.

A.5.1 Amtrak Trash Bags

The HRR from actual trash-filled bags from an Amtrak overnight train was obtained to characterize a severe ignition source representative of those that might be found on intercity trains. The trash bags consist of a plastic bag liner inside a brown paper bag that the train crew collects from bins at the ends of each car. These tests were conducted to quantify the likely insult from possible severe ignition sources and ensure appropriate choice of scenarios for testing of the other assemblies. The paper bag was 0.9 m (26 in) high, and when filled, was about 0.46 m (18 in) in diameter. A total of six bags were tested, ranging from 1.8 kg (4 lb) to 9.5 kg (20.9 lb) in weight. The ignition source used for these tests was a 25 kW gas sand burner.

Figure A-18 shows a burning trash bag at approximately the time of peak burning and at the end of the test. Figure A-19 shows the HRR for the six Amtrak trash bags tested. For clarity, the data in Figure A-19 have been smoothed using a local least-squared technique to minimize fluctuations in the data while maintaining the time-varying characteristics in each curve. The smoothing technique makes the data more readable on



Figure A-18. Trash Bag Test - During and After Gas Sand Burner Ignition

the figure, but does lower peak values on the graphs somewhat. Peak values presented in the table used the unsmoothed data and may be higher than observed in the smoothed graphs.

Table A-2. Peak HRR Measured During Furniture Calorimeter Assembly Tests

TEST	ASSEMBLY	IGNITION SOURCE	IGNITION HRR (kW)	PEAK HRR ¹ (kW)	TIME TO PEAK HRR (s)
1	Trash bag from Amtrak train, 1.8 kg	Gas sand burner	25	284	60
2	Trash bag from Amtrak train, 9.5 kg	Gas sand burner	25	53	230
3	Trash bag from Amtrak train, 5.4 kg	Gas sand burner	25	149	220
4	Trash bag from Amtrak train, 6.8 kg	Gas sand burner	25	83 ²	360
5	Trash bag from Amtrak train, 7.3 kg	Gas sand burner	25	122 ²	290
6	Trash bag from Amtrak train, 5 kg	Gas sand burner	25	125	60
7	Trash bag filled w/newspaper, 8.2 kg	Gas sand burner	25	170	130
8	Trash bag filled w/newspaper, 2.7 kg	Gas sand burner	25	157	160
9	Trash bag filled w/newspaper, 2.7 kg	Gas sand burner	25	242	300
10	Trash bag filled w/newspaper, 2.7 kg	Gas sand burner	25	209	240
11	Coach seat assembly	TB 133 burner	17	27	50
12	Coach seat assembly	TB 133 burner	17	30 ²	70
13	Coach seat assembly	Trash bag	note 3	366	200
14	Coach seat assembly	Round gas	280/400	488	580
15	Lower bed w/bedding and pillow	Trash bag	note 3	840	220
16	Lower bed w/bedding and pillow	Trash bag	note 3	759	210
17	Upper and lower beds w/bedding, pillow, and window drapes	Trash bag	note 3	918	190
18	Wall carpet on wall	Gas sand burner	50	435	350
19	Wall carpet on wall	Gas sand burner	50	337	250
20	Wall carpet on wall and ceiling	Gas sand burner	50	851	210
21	Wall carpet on wall and ceiling	Gas sand burner	50	483	210
22	Window drape (extended)	Gas sand burner	25	79	170
23	Window drape (contracted)	Gas sand burner	25	138	120
24	Window drape (contracted)	Gas sand burner	25	67	100
25	Privacy curtain (extended)	Gas sand burner	25	152	180
26	Privacy curtain (contracted)	Gas sand burner	25	198	250
27	Privacy curtain (contracted)	Gas sand burner	25	186	200
28	Window w/ gaskets, frame, and mask	Gas sand burner	50	128	190
29	Window w/ gaskets, frame, mask, and drapes	Trash bag	note 3	451	290

1 Peak HRR includes the contribution of the ignition source.

2 HRR data for these tests approximated from stack gas temperature.

3 See section A.3.5 for details of HRR of trash bag ignition source

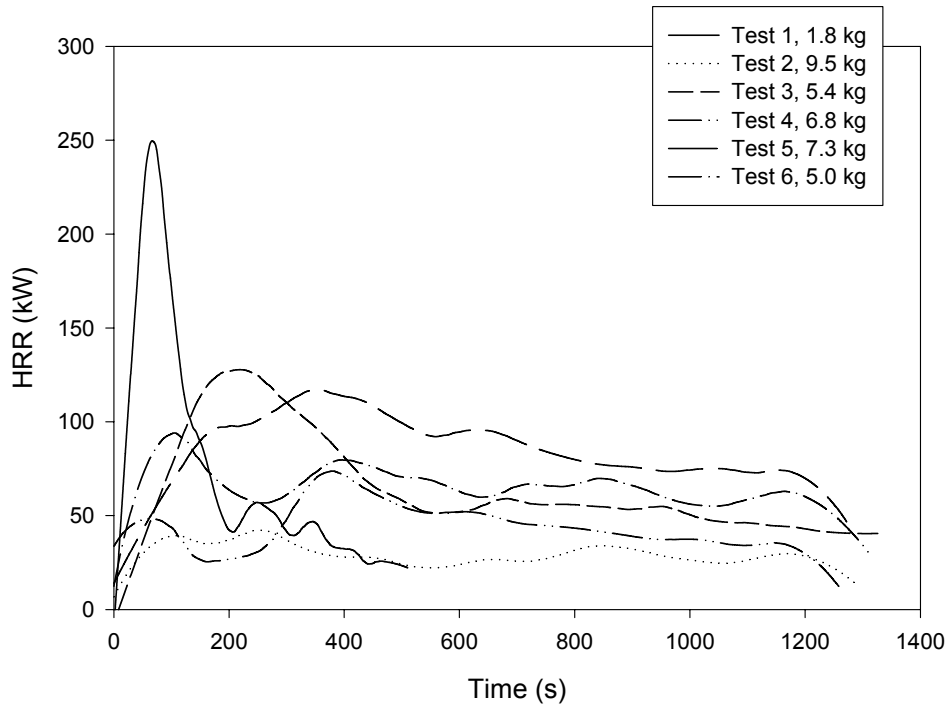

Figure A-19. HRR for Several Amtrak Trash Bags Measured in the Furniture Calorimeter

Peak HRR varies from 53 kW for the 9.5 kg (20.9 lb) bag to 284 kW for the 1.8 kg (4 lb) bag. Peak HRR was inversely proportional to the mass of the trash bag, with the lighter bag having the higher peak HRR and the heavier bag the lowest HRR. HRR values for the remaining bags were between these extremes. A straight line correlation of trash bag mass versus peak HRR results in a reasonably high correlation coefficient of 0.87. With the volume of the bags relatively constant, the lighter bags are less densely packed and thus provide better air circulation, which allows rapid fire development.

A.5.2 Newspaper-Filled Trash Bags

In order to develop a repeatable fire exposure with a HRR similar to the Amtrak trash bags examined in Tests 1–6, several tests were conducted with the same plastic-lined trash bags filled with newspaper. For Test 7, a total of 8.2 kg (18.1 lb) of bundled and crumpled newspaper was placed in the bag. For Tests 8–10, the bags were filled with 2.7 kg (6 lb) of crumpled newspaper. Like the Amtrak bag tests, the ignition source was a 25 kW gas sand burner.

Figure A-20 shows the HRR for the newspaper-filled trash bags. For clarity in the figure, the data have been smoothed using a local least-squared technique to minimize the fluctuations in the data while maintaining the time-varying characteristics in each curve.

As expected, the peak HRR for the newspaper-filled bags is more repeatable than for the Amtrak trash bags. As with the trash-filled bags, the heavier bag exhibited lower peak HRR values, with a peak value of 170 kW for the 8.2 kg (18.1 lb) bag. Peak HRR for the 2.7 kg (6 lb) bag averaged 203 ± 35 kW expressed as one standard deviation.

This lighter bag was used as the ignition source for a coach seat test (Test 13), the bedding tests (Tests 15-17), and a window test (Test 29). Figure A-20 shows the average HRR for the 2.7 kg (6 lb) newspaper-filled trash bag, along with all of the test data for the three tests of the bags. Measured uncertainty for the three replicates averages ± 24 kW (one standard deviation) over the entire duration of the experiments.

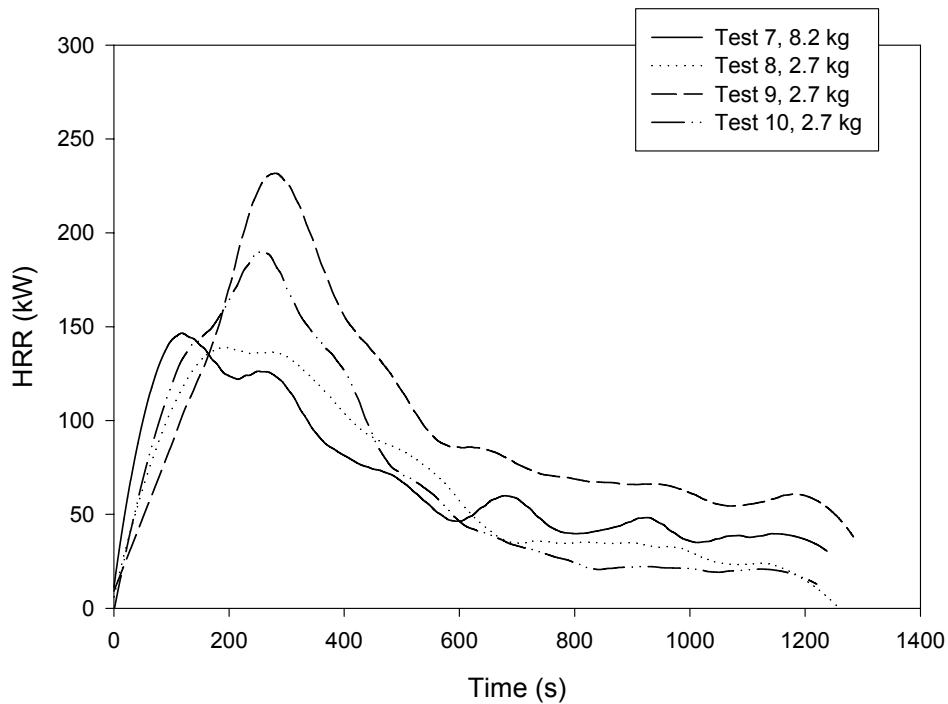

Figure A-20. HRR for Several Newspaper-Filled Trash Bags Measured in the Furniture Calorimeter

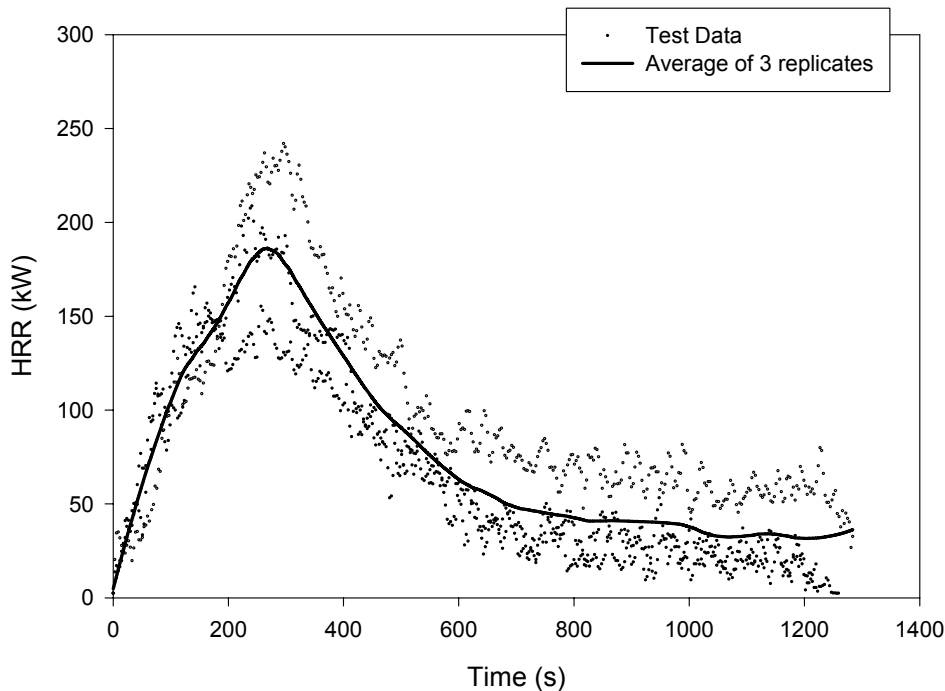

Figure A-21. Average HRR for Newspaper-filled Trash Bags Used as Ignition Source for Passenger Rail Car Material Assemblies

A.5.3 Coach Seats

Amfleet coach car seat assemblies were tested to characterize the burning behavior of complete seat assemblies exposed to varying ignition sources. Seat frames are steel with the shrouds, back shells, and food trays made of PVC/Acrylic. Seat cushions and leg rests consisting of fire-retardant foam are covered with a wool/nylon blend and vinyl combination over a muslin interliner. Seat support diaphragms of chloroprene or fabric provide flexible support for the seat bottom.

Foot rests of chloroprene over steel are included. For all of the tests, two rows of double seats were placed 37 in (0.95 m) apart (seat back to seat back spacing).

Three ignition sources were used in the seat assembly tests. For Tests 11 and 12, the TB 133 burner was used. This burner is the same burner used by Zicherman in tests of passenger train seats [17]. For Test 13, the newspaper-filled trash bag was used as the ignition source. For Test 14, a round gas burner was used to see if a burner could easily be substituted for the newspaper-filled trash bag ignition source.

Figure A-22 shows the seat assembly from Test 11 near the time of peak HRR. In Test 11, an armrest was ignited and continued to burn after the TB 133 burner was shut off at 80 s. However, the peak HRR of the armrest (not including the ignition source) was approximately 8 kW. In Test12, the armrest did not ignite. Still, the combined HRR of the seat cushions and armrest was less than 10 kW more than the TB 133 ignition source and



Figure A-22. Seat Assembly Test - During and After TB 133 Burner Ignition

insufficient to ignite additional nearby objects or to support significant continued burning once the burner was shut off. This is consistent with the low HRR in earlier tests conducted on similar seat cushion assemblies where the peak HRR of the assembly was 15 kW [17].

Figure A-23 shows the seat assembly from Test 13 at approximately the time of peak HRR and after the test.



Figure A-23. Seat Assembly Test - During and After Trash Bag/Gas Sand Burner Ignition

In Test 13, the newspaper-filled trash bag served as the ignition source. Peak HRR for this test was 366 kW, including the ignition source. Since at least 200 kW of this peak can be attributed to the newspaper-filled trash bag, the actual HRR of the seat assembly is far less. Most of the HRR for the seat assembly can be attributed to the carpeting and tray table on the seat

forward of the ignition location. During the test, the carpeting and tray table on the back of this seat assembly dropped, burned, and contributed to the HRR.

Figure A-24 shows the HRR for the seat assembly tests. For clarity in the figure, the data have been smoothed using a local least-squared technique to minimize the fluctuations in the data while maintaining the time-varying characteristics in each curve. For Tests 11 and 12, the small ignition source of the TB 133 burner resulted in the lowest peak HRR values of the seat assembly tests, averaging 29 ± 2 kW (one standard deviation). For the larger ignition sources in Tests 13 and 14, peak HRR values were higher, ranging from 366 to 488 kW on the seat.

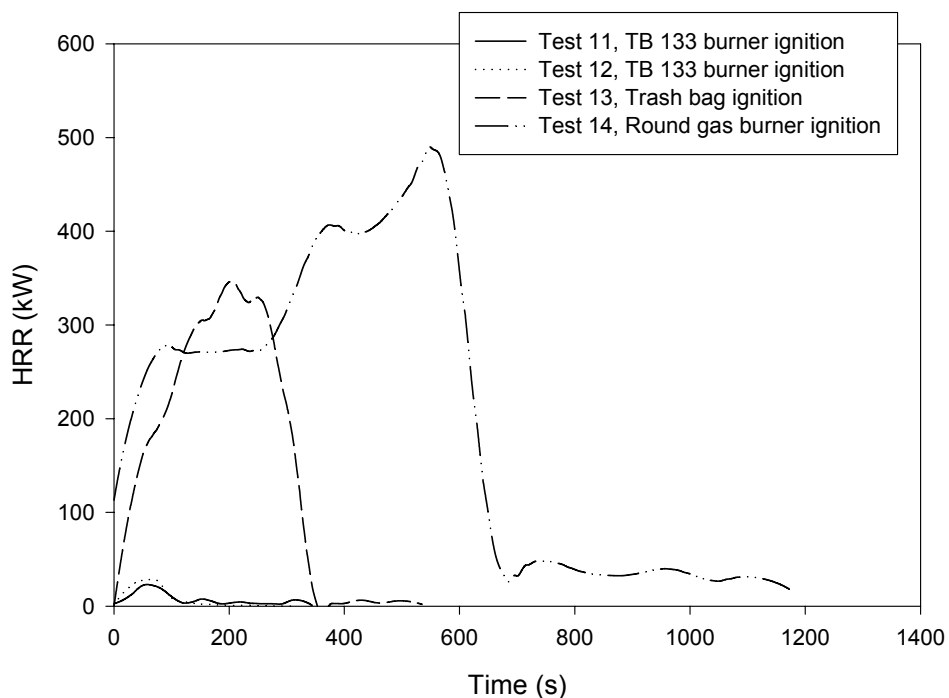

Figure A-24. HRR for Seat Assemblies Measured in the Furniture Calorimeter

For Test 14, most of the HRR is due to the round gas burner ignition source. For this test, the HRR of the gas burner was set at 280 kW for the first 300 s and increased to 480 kW thereafter. With a peak HRR, including the gas burner ignition source of 580 kW, approximately 100 kW can be attributed to the burning assembly. Like Test 13, much of this can be attributed to burning of the carpet on the back of the seat assembly forward of the ignition point. The burning of this carpet is consistent with earlier real-scale tests on Amtrak train car interiors conducted in 1983 and with the Cone Calorimeter tests from Phase I of this current research project. In the 1983 tests, wall carpeting was identified as a significant fire source in the vehicles [18]. In the

Cone Calorimeter testing, the peak HRR of the wall carpet was among the highest of the materials tested at 655 kW [10].

A.5.4 Sleeping Compartment Economy Bedroom Assemblies

Three tests of bed assemblies were conducted to characterize the burning behavior of the assemblies in a configuration approximating a Superliner II economy room with both upper and lower beds. Although the construction materials for the bed assemblies are similar to the seat assemblies, the geometry of the compartments is significantly different from that in a coach car. Typical bed linens used in overnight service were used for all three tests.

Tests 15 and 16 were lower bed tests. The lower bed had the same seat cushions, back cushions, mattress, pad, sheets, blanket, pillow and pillow case as the Superliner sleeper economy room. Cushions were also attached to the walls in the location of the upper back seat cushions. These tests used the newspaper-filled trash bag as the ignition source.

Figure A-25 shows Test 16 through the compartment door near the time of peak HRR and at the end of the test.



Figure A-25. Sleeping Compartment Economy Bedroom Lower Berth Test - During and After Trash Bag/Gas Sander Burner Ignition

Test 17 included both the lower and upper beds. The lower bed had the same cushions, mattress and bedding as Tests 15 and 16. The upper bed had the same mattress pad, sheets, blanket, pillow, and pillow case as was used on the lower beds. This test also included extended window drapes. As with the other bed tests, Test 17 used a newspaper-filled trash bag as the ignition source.

Figure A-26 shows the HRR for the bed tests. For clarity in the figure, the data have been smoothed using a local least-squared technique to minimize the fluctuations in the data while maintaining the time-varying characteristics in each curve. The tests are quite repeatable, with similar trends of an increasing growth rate followed by a decrease due to fuel burnout. Peak HRR averages approximately 800 kW, with peak times near 200 s in all three of the tests. Clearly, the severity of the newspaper-filled trash bag ignition source combined with the small volume of the sleeping compartment allowed a significant fire to develop. At peak burning rate, the fire would be large enough to block egress to the hallway outside the room or spread to other areas in the car.

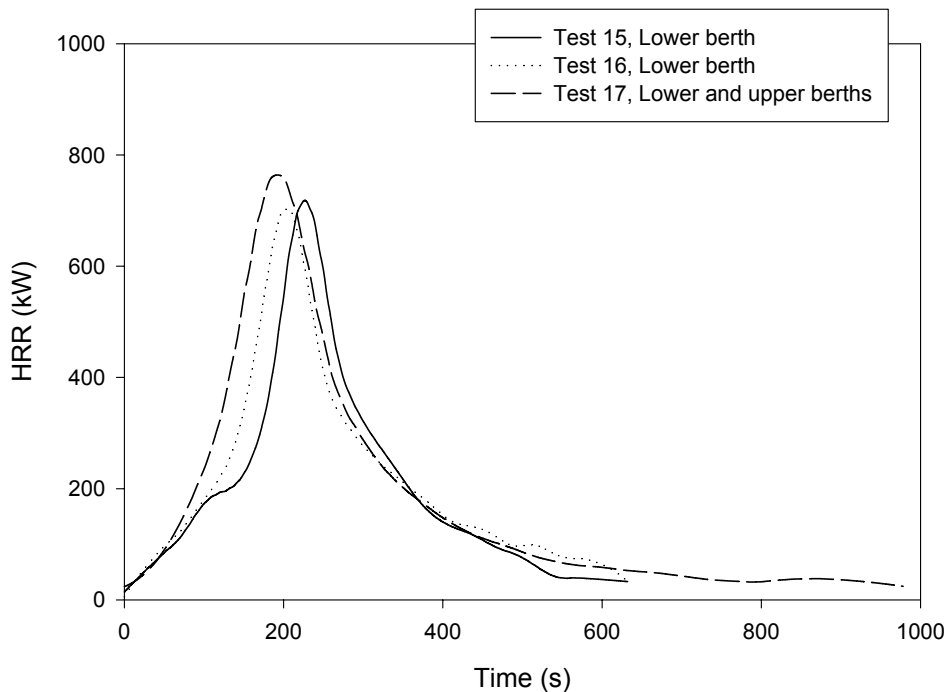

Figure A-26. HRR for Economy Bedroom Assemblies Measured in the Furniture Calorimeter

Inspection after the tests showed that much of the exposed material had been consumed. Exposed surfaces of the bed linens, pillows, ticking, foam, and upper back cushions were burned and charred. Although the newspaper-filled trash bag is an extremely severe ignition source, additional items not included in the test assemblies could add significantly to the fire growth in an actual car. For example, wall linings or passenger luggage were not included in these tests.

A.5.5 Wall and Ceiling Carpet

The same configuration was used for both the wall and ceiling carpet tests and the drape/curtain tests. Wall carpet panels and ceiling carpet panels were constructed of carpet attached to perforated aluminum sheet, duplicating the materials and assembly found in Amtrak trains. Tests 18 and 19 were of wall carpet but without ceiling carpet. Without the ceiling carpet panel in place, the top of the test frame was open to flow. Tests 20 and 21 included the ceiling carpet panels. For all the carpet tests, the carpet was exposed to a 50 kW flame from the gas sand burner.

Figure A-27 shows Test 21 near the time of peak HRR and at the end of the test. Figure A-28 shows the HRR from the carpet tests with and without ceiling carpet. For clarity in the figure, the data have been smoothed using a local least-squared technique to minimize the fluctuations in the data while maintaining the time-varying characteristics in each curve. Peak HRR ranged from 370 to 850 kW, including the 50 kW burner ignition source.

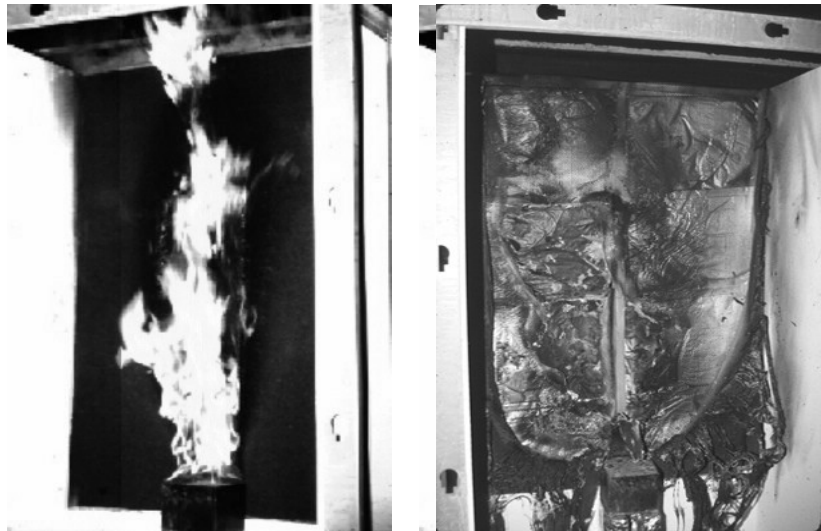

Figure A-27. Wall Carpet Assembly Test - During and After Gas Sand Burner Ignition

Initially, only the area of the carpet in direct contact with the gas burner flame was ignited. After 200 s to 300 s, vertical flame spread was sufficient to cause the carpet to become detached from the aluminum backing allowing both sides of the carpet to become involved. Rapid fire growth to the peak HRR followed. The additional fuel during the tests with ceiling carpet resulted in a higher HRR for these tests.

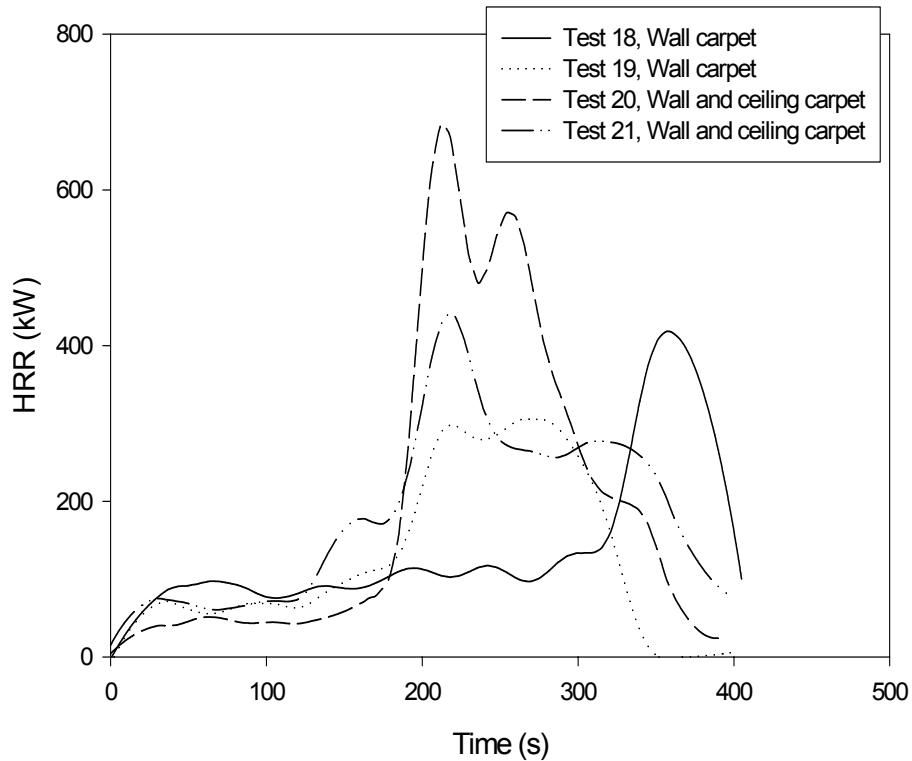

Figure A-28. HRR for Wall and Ceiling Carpet Measured in the Furniture Calorimeter

A.5.6 Window Drapes and Door Privacy Curtains

Window drapes are used in some coaches. Sleeping cars have window drapes and also privacy curtains on the inside of the door wall to the hallway. Both drapes and privacy curtains were tested. Tests 22 to 24 were of drapes and Tests 25 to 27 were of the longer privacy curtains. For all tests, a 25 kW gas sand burner was used. Figure A-29 shows Test 22 which had the drapes fully extended near the time of peak HR and at the end of the tests.



Figure A-29. Window Drape Assembly Test (Extended) - During and After Gas Sand Burner Ignition

Figure A-30 shows the HRR for Tests 22-24. For clarity in the figures, the data have been smoothed using a local least-squared technique to minimize the fluctuations in the data while maintaining the time-varying characteristics in each curve.

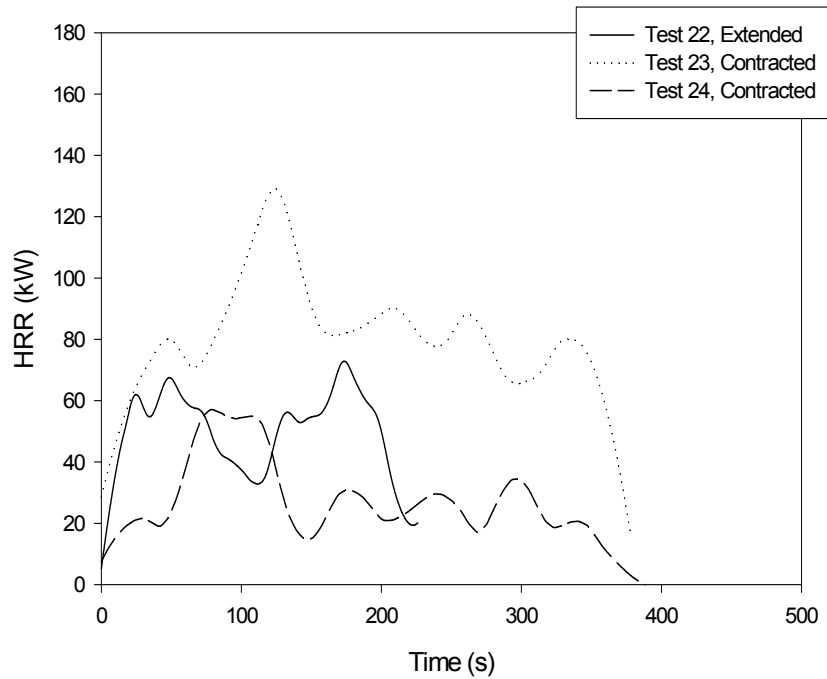

Figure A-30. HRR for Window Drape Assemblies Measured in the Furniture Calorimeter

Figure A-31 shows Test 26 with the privacy curtains contracted with the gas sand burner in the left bottom edge location near the time of peak HRR and at the end of the test.



Figure A-31. Door Privacy Curtain Assembly Test (Non-Extended) - During and After Gas Sand Burner Ignition

Figure A-32 shows the HRR for Tests 25 and 26. For clarity in the figures, the data have been smoothed using a local least-squared technique to minimize the fluctuations in the data while maintaining the time-varying characteristics in each curve.

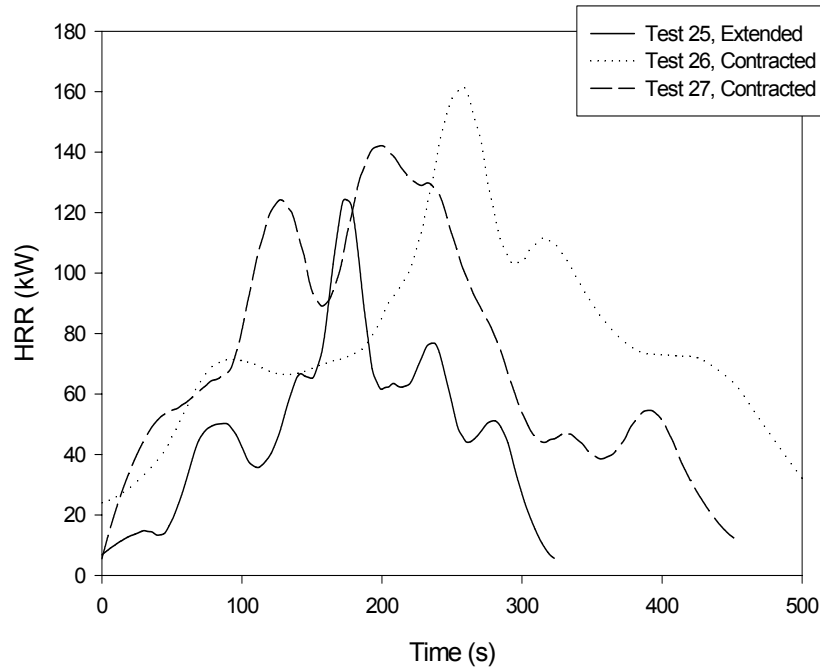

Figure A-32. HRR for Door Privacy Curtain Assemblies Measured in the Furniture Calorimeter

Peak HRR ranged from 67 to 198 kW , including the 25 kW ignition source.

For all of the tests, most of the burning takes place directly above the burner, with limited flame spread laterally away from the burner.

HRR for the door privacy curtains (179 ± 19 kW) is naturally higher than the window drapes (95 ± 31 kW) since more material is directly above the burner ignition source. Similarly, the contracted drapes and curtains have a somewhat higher HRR than the extended drapes and curtains because more of the material is directly exposed to the ignition source. The variability between replicate tests is naturally higher for the drapes and curtains than for other materials in this study since the flame impingement and exposure changes from test to test, and fabric is freely hanging at the bottom. during each test. Clearly, the drapery/curtains are highly resistant to ignition since flame spread is limited to the material directly above the ignition source. However, like the wall carpet, the drapery/curtains can contribute to an existing fire.

A.5.7 Wall Panel and Window

Tests 28 and 29 were conducted with a single window assembly taken from an Amfleet coach car. The assembly was constructed of a two-layer polycarbonate window panel (separated by a void space), window mask, aluminum frame, and gasketing.

For Test 28, the right half of the window assembly was exposed to a 50 kW flame from the sand

burner. Figure A-33 shows Test 28 near the time of peak HRR and at the end of the test. For Test 29, the newspaper-filled trash bag served as the ignition source for the left half of the undamaged window assembly, tested in Test 28.

(The gas sand burner ignited the trash bag.) The window drape that is typically in place in some coaches car was also

extended across the window (Figure A-34).

Figure A-35 shows the HRR for Tests 28 and 29. For clarity in the figure, the data have been smoothed using a local least-squared technique to minimize the fluctuations in the data while maintaining the time-varying characteristics in each curve.

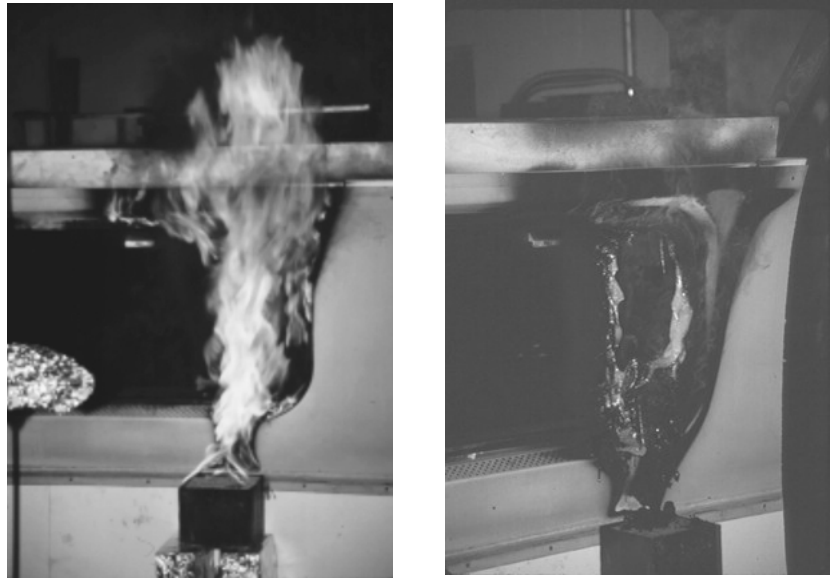

Figure A-33. Wall and Window Assembly Test - During and After Gas Sand Burner Ignition



Figure A-34. Window and Drape Assembly Tests - During and After Trash Bag / Gas Sand Burner Ignition

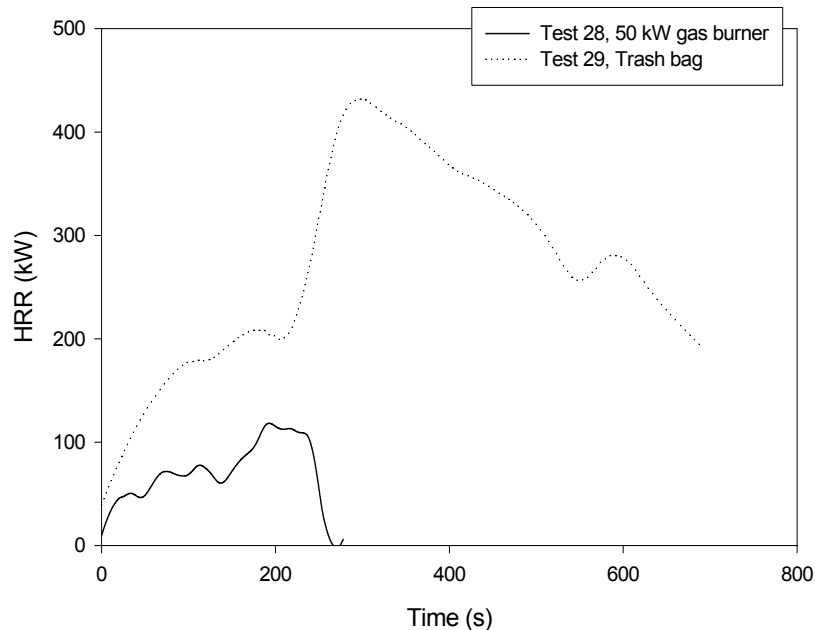

Figure A-35. HRR for Wall, Window, and Drape Assemblies Measured in the Furniture Calorimeter

For Test 28, the peak HRR was 128 kW at 190 s when it was extinguished to prevent further damage to the assembly.

Test 29 had a peak HRR of 451 kW at 290 s. As expected, the drupe near the trash bag was consumed early in the test. After about 250 s of exposure to the bag fire, the polycarbonate window ignited and the HRR jumped from about 200 to 450 kW. Both sheets of the polycarbonate window burned through so that there were flames flowing from the back side of the window. A hole in the polycarbonate sheet near the flame resulted.

In both tests, the wall and window assembly does not contribute early in the fire. Rather, it takes about 200 s of a severe ignition source for the wall and window assembly to ignite and sustain a fire. However, once ignited, a significant fire can result and the window can burn through, allowing additional oxygen to an existing fire.

A.6 TEST RESULTS SUMMARY

Trash bags were considered to be a credible large ignition source that could lead to fire growth and spread. The HRR from actual trash bags from an Amtrak overnight train ranged from 53 kW

to 284 kW. Heavier and more densely packed trash bags had lower HRR values than lighter bags. A newspaper-filled trash bag representative of the lighter trash-filled bags was used as the ignition source for many of the assembly tests. This bag had a peak HRR of 203 ± 35 kW.

All of the assemblies tested were exposed to an initial ignition source ranging from 17 kW to 200 kW. All of the assemblies tested were extremely resistant to ignition, requiring an initial fire source ranging from 25 kW to 200 kW to ignite. Peak HRR ranged from 27 kW for a seat assembly exposed to the 17 kW gas burner, to 918 kW for a lower and upper bed assembly with a newspaper-filled trash bag. Some of the materials did not contribute to the fire even with those ignition sources. For example, the seat cushions do not produce a significant HRR even with the severity of the 200 kW newspaper-filled trash bag ignition source. For the seat assemblies, the HRR results largely from burning of carpeting attached to the rear of the assemblies.

Conversely, if a severe ignition exists, some of the materials can contribute to further fire growth. The wall carpeting and window glazing, though difficult to ignite, produce high HRR values once ignited. This is consistent with earlier real-scale mock-up tests conducted on Amtrak coach interior materials. In these earlier tests, the wall covering (carpeting or window mask) adjacent to seats were seen as important to the growth of fire.

Also like the 1983 Amtrak material tests, the effect of geometry can be significant. The small enclosed geometry of the sleeping compartment bedroom resulted in a much larger HRR for the bed assembly tests than for the seat assembly tests, even though the materials are similar.

References

1. Smith, E. E. "Fire Safety Evaluation of Rapid Transit Systems," *Proceedings of the Eighth International Conference on Fire Safety*, Millbrae, CA, January 17-21, 1983, pp 85-94, 1983.
2. Kaufman, S., E. E. Smith, L J. Przybyla, and J. L. Williams, "Large Scale Fire Tests of Building Riser Cables," *Proceedings of the Eighth International Conference on Fire Safety, Millbrae, CA, January 17-21, 1983*, pp 105-112, 1983.
3. Janssens, M., "Measuring Rate of Heat Release by Oxygen Consumption," *Fire Technology*, Volume 27, Number 3, pp. 234-249, 1991.
4. Göransson, U., "Nordtest Full-scale Fire Tests," *Proceedings of the Flame Retardants '90 Conference*, London, UK, pp 34-42, January 1990.

5. Babrauskas, V., et al. *Fire Hazard Comparison of Fire-Retarded and Non-Fire-Retarded Products*, National Bureau of Standards (NBS) Special. Publication No. 749, 1988.
6. Babrauskas, V. "Upholstered furniture room fires -- Measurements, comparison with furniture calorimeter data, and flashover predictions," *Journal of Fire Science* Volume 4, January/ February 1984.
7. Babrauskas, V. "Development of the Cone Calorimeter -- A Bench Scale Heat Release Rate Apparatus Based on Oxygen Consumption," *Fire and Materials*. Volume 8, pp. 81-95, 1984.
8. Karlson, B. *Room Fires and Combustible Linings (Report SE-LUTVDG/TVBB-3050)*. Department of Fire Safety Engineering, Lund University, Lund, Sweden, 1989.
9. Peacock, R. D. and E. Braun. *Fire Safety of Passenger Trains: Phase I Material Evaluation (Cone Calorimeter)*. Prepared for Federal Railroad Administration (FRA), U.S. Department of Transportation (USDOT). National Institute of Standards and Technology (NIST). Interim Report. Report No. DOT/FRA/ORD-99/01, January 1999. Also published by NIST, Report No. NISTIR 6132,
10. Babrauskas, V. and J. F. Krasny. *Fire Behavior of Upholstered Furniture*, NBS, Monograph 173, 1985.
11. Babrauskas, V., et al. *Upholstered Furniture Heat Release Rate Measured with a Furniture Calorimeter*, NBS. Report No. NBSIR 82-2604, 1982.
12. American Society for Testing and Materials (ASTM). *Standard Test Method for Fire Testing of Real Scale Upholstered Furniture Items*, ASTM E 1537-96, 1997 Annual Book of ASTM Standards, 1997.
13. ASTM. *Standard Test Method for Fire Testing of Mattresses*, ASTM E 1590-96, Annual Book of ASTM Standards, 1997.
14. *Upholstered Furniture: Burning Behaviour – Full scale test*, (Nordtest Method NT FIRE 032, Edition 2). NORDTEST, Helsingfors, Finland, 1991.
15. Ohlemiller, T. J. and K. Villa, "Characterization of the California Technical Bulletin 133 Ignition Source and a Comparable Gas Burner," *Fire Safety Journal*, Volume 18, Number 4, pp 325-354, 1992.
16. *Flammability Test Procedure for Seating Furniture for Use in Public Occupancies*, TB 133, State of California, North Highlands, CA, 1991.
17. Zicherman, J. B., S. H. Markos. *ASTM E 1537-95a / CAL TB 133 Fire Testing of Rail Transportation Seating*, Report to Volpe Center/FRA,. Fire Cause Analysis, Inc., Internal Project Memorandum, 1998.

18. Peacock, R.D. and E. Braun. *Fire Tests of Amtrak Passenger Rail Vehicle Interiors*. Prepared for FRA/USDOT. NBS. Technical Note 1183, 1984.

APPENDIX B. PASSENGER RAIL CAR CONFIGURATION, VENTING DETAILS, AND FIRE MODELING INPUTS

This Appendix provides compartment vent sizes used in the fire modeling of the three passenger rail car configurations. For each rail car, a schematic floor plan is included and overlaid with the compartment layout used to model the car. A table of compartment and vent dimensions for each compartment details the sizes of each compartment and vent in the simulation. Finally, the baseline input to the CFAST fire model for a medium t-squared fire is included.

B.1 COACH CAR

The coach car is modeled with seven compartments:

- the main passenger area;
- two passenger toilets;
- two transfer areas between the main passenger compartment and the vestibules at each end of the car; and
- two vestibules at the ends of the car that provide access to adjacent cars and serve as exits from the car when the car is stationary.

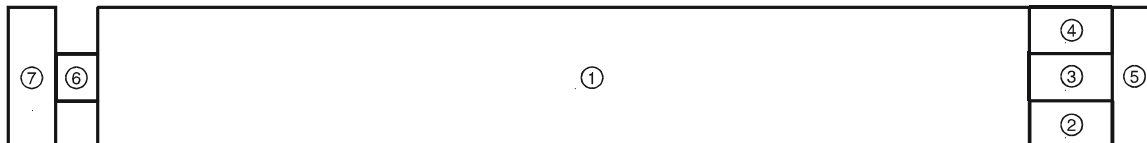
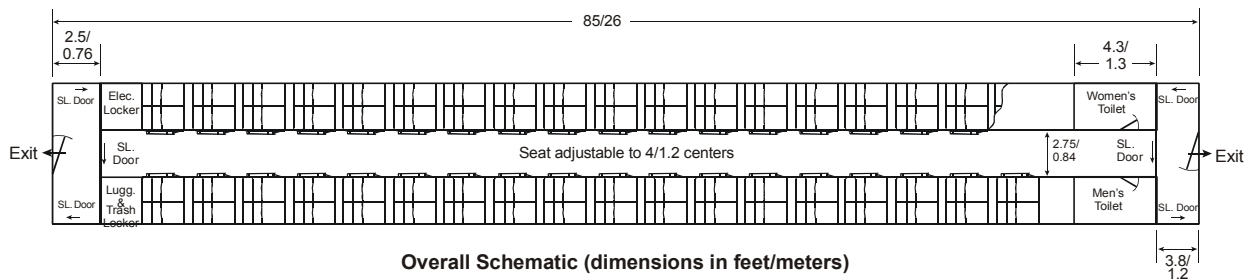

Compartment Outlines for Modeling

Figure B-1. Compartment Configuration for Coach Car Fire Modeling

Table B-1. Compartment and Vent Dimensions for Coach Car Fire Modeling

COMPARTMENT	DIMENSIONS (m)	VENT CONNECTIONS TO	DIMENSIONS (m)
1	20.46 x 2.84 x 2.22	3	0.84 x 2.22
		6	0.84 x 2.22
2	1.00 x 1.32 x 2.22	3	0.76 x 1.91
3	0.84 x 1.32 x 2.22	1	0.84 x 2.22
		2	0.76 x 1.91
		4	0.76 x 1.91
		5	0.76 x 1.91
4	1.00 x 1.32 x 2.22	3	0.76 x 1.91
5	2.84 x 1.17 x 2.22	3	0.76 x 1.91
		Outside	0.76 x 1.91
		Outside	0.76 x 1.91
		Outside	0.76 x 1.91
6	0.84 x 0.72 x 2.22	1	0.84 x 2.22
		7	0.76 x 1.91
7	2.84 x 0.98 x 2.22	6	0.76 x 1.91
		Outside	0.76 x 1.91
		Outside	0.76 x 1.91
		Outside	0.76 x 1.91

Model Input for Coach Car Baseline Analysis

```

VERSN      3User Defined Base Case
#VERSN 3 User Defined Base Case
TIMES      300 5 5 00 0
DUMPR MCOACH.HI
TAMB 293.15      101300. 0.00
EAMB 293.15      101300. 0.00
HI/F 0.0 0.0 0.0 0.0 0.0 0.0 0.0 0.0
WIDTH 20.4641 1.3208 1.3208 1.3208 1.1684 0.720725 0.98425
DEPTH 2.8448 1.0033 0.83820 1.0033 2.8448 0.83820 2.8448
HEIGH 2.2225 2.2225 2.2225 2.2225 2.2225 2.2225 2.2225
CEILI GYPSUM GYPSUM GYPSUM GYPSUM GYPSUM GYPSUM GYPSUM
WALLS GYPSUM GYPSUM GYPSUM GYPSUM GYPSUM GYPSUM GYPSUM
FLOOR PLYWOOD PLYWOOD PLYWOOD PLYWOOD PLYWOOD PLYWOOD PLYWOOD
#CEILI GYPSUM GYPSUM GYPSUM GYPSUM GYPSUM GYPSUM GYPSUM
#WALLS GYPSUM GYPSUM GYPSUM GYPSUM GYPSUM GYPSUM GYPSUM
#FLOOR PLYWOOD PLYWOOD PLYWOOD PLYWOOD PLYWOOD PLYWOOD PLYWOOD
HVENT 1 3 1 0.83820 2.2225 0.0 0.0 0.0 0.00
CVENT 1 3 1 1. 1. 1. 1. 1. 1. 1. 1. 1. 1. 1. 1. 1. 1. 1. 1.
1. 1.
HVENT 1 6 1 0.83820 2.2225 0.0 0.0 0.0 0.00
CVENT 1 6 1 1. 1. 1. 1. 1. 1. 1. 1. 1. 1. 1. 1. 1. 1. 1. 1.
1. 1.
HVENT 2 3 1 0.76200 1.9050 0.0 0.0 0.0 0.00
CVENT 2 3 1 1. 1. 1. 1. 1. 1. 1. 1. 1. 1. 1. 1. 1. 1. 1. 1.
1. 1.
HVENT 3 4 1 0.76200 1.9050 0.0 0.0 0.0 0.00
CVENT 3 4 1 1. 1. 1. 1. 1. 1. 1. 1. 1. 1. 1. 1. 1. 1. 1. 1.
1. 1.
HVENT 3 5 1 0.762000 1.90500 0.00 0.00 0.00 0.00
CVENT 3 5 1 1.0 1.0 1.0 1.0 1.0 1.0 1.0 1.0 1.0 1.0 1.0 1.0 1.0 1.0 1.0
1.0 1.0 1.0 1.0 1.0
HVENT 5 8 1 0.762000 1.90500 0.00 0.00 0.00 0.00
CVENT 5 8 1 1.0 1.0 1.0 1.0 1.0 1.0 1.0 1.0 1.0 1.0 1.0 1.0 1.0 1.0 1.0
1.0 1.0 1.0 1.0 1.0
HVENT 5 8 2 0.762000 1.90500 0.00 0.00 0.00 0.00
CVENT 5 8 2 1.0 1.0 1.0 1.0 1.0 1.0 1.0 1.0 1.0 1.0 1.0 1.0 1.0 1.0 1.0
1.0 1.0 1.0 1.0 1.0
HVENT 5 8 3 0.762000 1.90500 0.00 0.00 0.00 0.00
CVENT 5 8 3 1.0 1.0 1.0 1.0 1.0 1.0 1.0 1.0 1.0 1.0 1.0 1.0 1.0 1.0 1.0
1.0 1.0 1.0 1.0 1.0
HVENT 6 7 1 0.762000 1.90500 0.00 0.00 0.00 0.00
CVENT 6 7 1 1.0 1.0 1.0 1.0 1.0 1.0 1.0 1.0 1.0 1.0 1.0 1.0 1.0 1.0 1.0
1.0 1.0 1.0 1.0 1.0
HVENT 7 8 1 0.762000 1.90500 0.00 0.00 0.00 0.00
CVENT 7 8 1 1.0 1.0 1.0 1.0 1.0 1.0 1.0 1.0 1.0 1.0 1.0 1.0 1.0 1.0 1.0
1.0 1.0 1.0 1.0 1.0
HVENT 7 8 2 0.762000 1.90500 0.00 0.00 0.00 0.00
CVENT 7 8 2 1.0 1.0 1.0 1.0 1.0 1.0 1.0 1.0 1.0 1.0 1.0 1.0 1.0 1.0 1.0
1.0 1.0 1.0 1.0 1.0
HVENT 7 8 3 0.762000 1.90500 0.00 0.00 0.00 0.00
CVENT 7 8 3 1.0 1.0 1.0 1.0 1.0 1.0 1.0 1.0 1.0 1.0 1.0 1.0 1.0 1.0 1.0
1.0 1.0 1.0 1.0 1.0
CHEMI 16. 50. 10. 1.95000E+007 293.150 493.150 0.300
LFBO 1
LFBT 2
CJET ALL
FPOS -1.0 -1.0 0.00

```

Model Input for Coach Car Baseline Analysis (con't)

```

FTIME 33. 66. 99. 132.000 165.000 198.000 231.000 264.000 300.000 900.000 933.000
966.000 999.000 1032.00 1065.00 1098.00 1131.00 1164.00 1200.00
FMASS 0.00 0.000654518 0.00261807 0.00589067 0.0104723 0.0163629 0.0235626 0.0320713 0.0418891
0.0540923 0.0540923 0.0428465 0.0329097 0.0242821 0.0169633 0.0109537 0.00625308 0.00286148
0.000778928 0.00
FQDOT 0.00 12763.1 51052.3 114868. 204209. 319077. 459471. 625391. 816837. 1.05480E+006
1.05480E+006 835507. 641740. 473500. 330785. 213597. 121935. 55798.9 15189.1 0.00
HCR 0.080 0.080 0.080 0.080 0.080 0.080 0.080 0.080 0.080 0.080 0.080 0.080 0.080 0.080 0.080 0.080 0.080
0.080 0.080 0.0800
OD 0.090 0.090 0.090 0.090 0.090 0.090 0.090 0.090 0.090 0.090 0.090 0.090 0.090 0.090 0.090 0.090 0.090
0.090 0.090 0.0900
CO 0.10 0.10 0.10 0.10 0.10 0.10 0.10 0.10 0.10 0.10 0.10 0.10 0.10 0.10 0.10 0.10 0.10 0.10
0.10 0.10 0.100
STPMAX 0.1

SELECT 1 2 3
#GRAPHICS ON
DEVICE 1
WINDOW 0. 0. -100. 1280. 1024. 1100.
LABEL 1 970. 960. 0. 1231. 1005. 10. 15 00:00:00 0.00 0.00
GRAPH 1 100. 50. 0. 600. 475. 10. 3 TIME HEIGHT
GRAPH 2 100. 550. 0. 600. 940. 10. 3 TIME CELSIUS
GRAPH 3 720. 50. 0. 1250. 475. 10. 3 TIME FIRE_SIZE(kW)
GRAPH 4 720. 550. 0. 1250. 940. 10. 3 TIME O|D2|O()
HEAT 0 0 0 0 3 1 U
HEAT 0 0 0 0 3 2 U
HEAT 0 0 0 0 3 3 U
HEAT 0 0 0 0 3 4 U
HEAT 0 0 0 0 3 5 U
HEAT 0 0 0 0 3 6 U
HEAT 0 0 0 0 3 7 U
TEMPE 0 0 0 0 2 1 U
TEMPE 0 0 0 0 2 2 U
TEMPE 0 0 0 0 2 3 U
TEMPE 0 0 0 0 2 4 U
TEMPE 0 0 0 0 2 5 U
TEMPE 0 0 0 0 2 6 U
TEMPE 0 0 0 0 2 7 U
INTER 0 0 0 0 1 1 U
INTER 0 0 0 0 1 2 U
INTER 0 0 0 0 1 3 U
INTER 0 0 0 0 1 4 U
INTER 0 0 0 0 1 5 U
INTER 0 0 0 0 1 6 U
INTER 0 0 0 0 1 7 U
O2 0 0 0 0 4 1 U
O2 0 0 0 0 4 2 U
O2 0 0 0 0 4 3 U
O2 0 0 0 0 4 4 U
O2 0 0 0 0 4 5 U
O2 0 0 0 0 4 6 U
O2 0 0 0 0 4 7 U

```

B.2 DINING CAR

The dining car is modeled with 15 compartments on two levels.

On the upper level, there are:

- two main dining areas;
- a central serving area;
- two transfer areas between the main dining areas and other train cars;
- two large compartments that serve as connecting train cars; and
- four mechanical rooms for the A/C system.

On the lower level there are:

- a large single kitchen and food storage area; and
- two disconnected rooms housing the A/C units for the car.

Connecting the two levels is:

- a single central staircase.

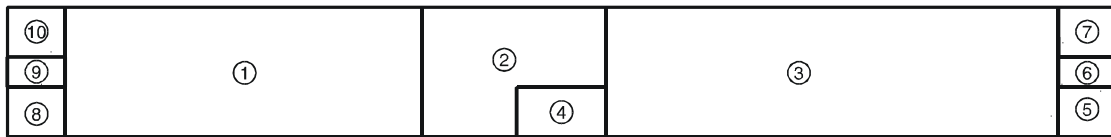
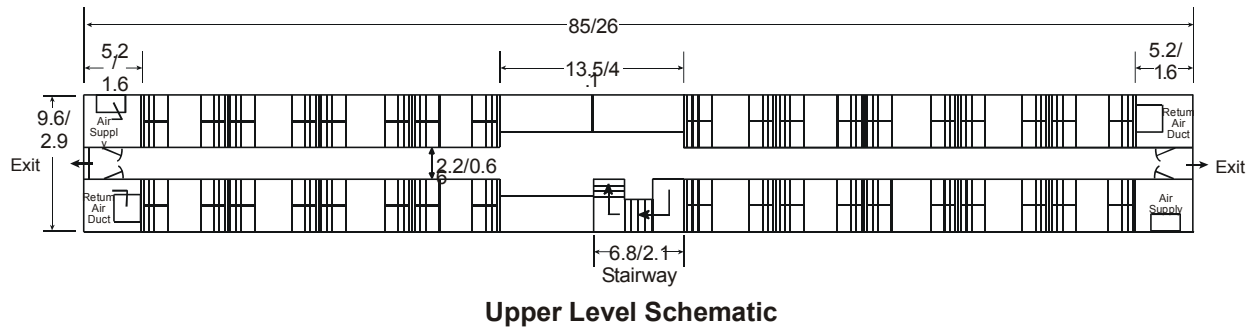

Upper Level Compartment Modeling Outlines

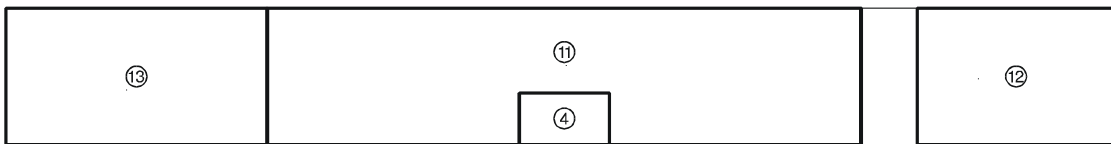
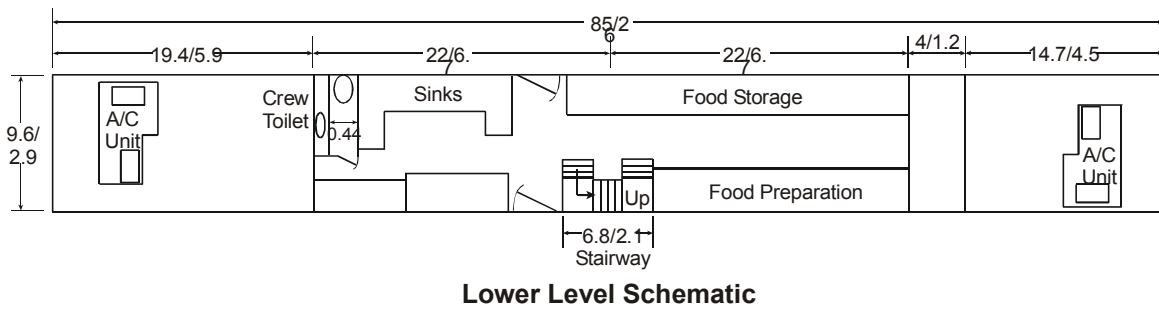

Compartment Outlines for Modeling

Figure B-2. Compartment Configuration for Dining Car Fire Modeling

Table B-2. Compartment and Vent Dimensions for Dining Car Fire Modeling

COMPARTMENT	DIMENSIONS (m)	VENT CONNECTIONS TO	DIMENSIONS (m)
1	11.34 x 2.92 x 1.98	2	0.91 x 1.98
		9	0.91 x 1.98
2	2.06 x 0.97 x 1.98	2	0.91 x 1.98
		3	0.91 x 1.98
		4	0.81 x 1.98
3	11.93 x 2.92 x 1.98	2	0.91 x 1.98
		6	0.91 x 1.98
4	1.03 x 1.02 x 3.96	2	0.81 x 1.98
		11	0.81 x 1.98
5	0.91 x 1.07 x 1.98	6	0.46 x 1.91
6	0.91 x 0.66 x 1.98	3	0.91 x 1.98
		5	0.46 x 1.91
		7	0.46 x 1.91
		14	0.69 x 1.91
7	0.91 x 1.07 x 1.98	6	0.46 x 1.91
8	0.91 x 1.07 x 1.98	9	0.46 x 1.91
9	0.91 x 0.66 x 1.98	1	0.91 x 1.98
		8	0.46 x 1.91
		10	0.46 x 1.91
		15	0.69 x 1.91
10	0.91 x 1.07 x 1.98	9	0.46 x 1.91
11	13.41 x 2.92 x 1.98	4	0.81 x 1.98
		Outside	0.66 x 0.013
12	5.92 x 2.92 x 1.98	No Vents	
13	5.92 x 2.92 x 1.98	No Vents	
14	25.91 x 2.92 x 1.98	6	0.69 x 1.91
		Outside	0.46 x 1.91
15	25.91 x 2.92 x 1.98	9	0.69 x 1.91
		Outside	0.46 x 1.91

Model Input for Dining Car Baseline Analysis

```

VERSN      3User Defined Base Case
#VERSN 3 User Defined Base Case
TIMES     1010 0 10 0 0
DUMPR     VMDINE.HI
STPMAX    0.100
TAMB      293.150    101300. 0.00
EAMB      293.150    101300. 0.00
HI/F      1.98120 1.98120 1.98120 0.00 1.98120 1.98120 1.98120 1.98120 1.98120 1.98120 0.00 0.00 0.00
1.98120 1.98120
WIDTH     11.3411 2.05740 11.9253 1.02870 0.914400 0.914400 0.914400 0.914400 0.914400 0.914400 13.4112
5.91820 5.91820 25.9080 25.9080
DEPTH     2.92100 0.965200 2.92100 1.01600 1.06680 0.660400 1.06680 1.06680 0.660400 1.06680 2.92100
2.92100 2.92100 2.92100 2.92100
HEIGHT    1.98120 1.98120 1.98120 3.96240 1.98120 1.98120 1.98120 1.98120 1.98120 1.98120 1.98120
1.98120 1.98120 1.98120 1.98120
CEILI     GYPSUM GYPSUM GYPSUM ALUM2064 DEFAULT DEFAULT DEFAULT DEFAULT DEFAULT DEFAULT GYPSUM
DEFAULT DEFAULT DEFAULT DEFAULT
WALLS     GYPSUM GYPSUM GYPSUM WC1_U305 DEFAULT DEFAULT DEFAULT DEFAULT DEFAULT DEFAULT GYPSUM
DEFAULT DEFAULT DEFAULT DEFAULT
FLOOR     PLYWOOD PLYWOOD PLYWOOD ALUM2064 DEFAULT DEFAULT DEFAULT DEFAULT DEFAULT DEFAULT PLYWOOD
DEFAULT DEFAULT DEFAULT DEFAULT
#CEILI    GYPSUM GYPSUM GYPSUM ALUM2064 DEFAULT DEFAULT DEFAULT DEFAULT DEFAULT DEFAULT GYPSUM
DEFAULT DEFAULT DEFAULT DEFAULT
#WALLS    GYPSUM GYPSUM GYPSUM WC1_U305 DEFAULT DEFAULT DEFAULT DEFAULT DEFAULT DEFAULT GYPSUM
DEFAULT DEFAULT DEFAULT DEFAULT
#FLOOR    PLYWOOD PLYWOOD PLYWOOD ALUM2064 DEFAULT DEFAULT DEFAULT DEFAULT DEFAULT DEFAULT PLYWOOD
DEFAULT DEFAULT DEFAULT DEFAULT
SHAFT     4
HVENT     1 2 1 0.914400 1.98120 0.00 0.00 0.00 0.00
CVENT     1 2 1 1.0 1.0 1.0 1.0 1.0 1.0 1.0 1.0 1.0 1.0 1.0 1.0 1.0 1.0
1.0 1.0 1.0 1.0 1.0
HVENT     1 9 1 0.914400 1.98120 0.00 0.00 0.00 0.00
CVENT     1 9 1 1.0 1.0 1.0 1.0 1.0 1.0 1.0 1.0 1.0 1.0 1.0 1.0 1.0 1.0
1.0 1.0 1.0 1.0 1.0
HVENT     2 3 1 0.914400 1.98120 0.00 0.00 0.00 0.00
CVENT     2 3 1 1.0 1.0 1.0 1.0 1.0 1.0 1.0 1.0 1.0 1.0 1.0 1.0 1.0 1.0
1.0 1.0 1.0 1.0 1.0
HVENT     2 4 1 0.812800 1.98120 0.00 0.00 0.00 0.00
CVENT     2 4 1 1.0 1.0 1.0 1.0 1.0 1.0 1.0 1.0 1.0 1.0 1.0 1.0 1.0 1.0
1.0 1.0 1.0 1.0 1.0
HVENT     3 6 1 0.914400 1.98120 0.00 0.00 0.00 0.00
CVENT     3 6 1 1.0 1.0 1.0 1.0 1.0 1.0 1.0 1.0 1.0 1.0 1.0 1.0 1.0 1.0
1.0 1.0 1.0 1.0 1.0
HVENT     4 11 1 0.812800 1.98120 0.00 0.00 0.00 0.00
CVENT     4 11 1 1.0 1.0 1.0 1.0 1.0 1.0 1.0 1.0 1.0 1.0 1.0 1.0 1.0 1.0
1.0 1.0 1.0 1.0 1.0
HVENT     5 6 1 0.457200 1.90500 0.00 0.00 0.00 0.00
CVENT     5 6 1 1.0 1.0 1.0 1.0 1.0 1.0 1.0 1.0 1.0 1.0 1.0 1.0 1.0 1.0
1.0 1.0 1.0 1.0 1.0
HVENT     6 7 1 0.457200 1.90500 0.00 0.00 0.00 0.00
CVENT     6 7 1 1.0 1.0 1.0 1.0 1.0 1.0 1.0 1.0 1.0 1.0 1.0 1.0 1.0 1.0
1.0 1.0 1.0 1.0 1.0
HVENT     6 14 1 0.685800 1.90500 0.00 0.00 0.00 0.00
CVENT     6 14 1 1.0 1.0 1.0 1.0 1.0 1.0 1.0 1.0 1.0 1.0 1.0 1.0 1.0 1.0
1.0 1.0 1.0 1.0 1.0
HVENT     8 9 1 0.457200 1.90500 0.00 0.00 0.00 0.00
CVENT     8 9 1 1.0 1.0 1.0 1.0 1.0 1.0 1.0 1.0 1.0 1.0 1.0 1.0 1.0 1.0
1.0 1.0 1.0 1.0 1.0

```

Model Input for Dining Car Baseline Analysis (con't)

```

HVENT 9 10 1 0.457200 1.90500 0.00 0.00 0.00 0.00
CVENT 9 10 1 1.0 1.0 1.0 1.0 1.0 1.0 1.0 1.0 1.0 1.0 1.0 1.0 1.0 1.0
1.0 1.0 1.0 1.0 1.0
HVENT 9 15 1 0.685800 1.90500 0.00 0.00 0.00 0.00
CVENT 9 15 1 1.0 1.0 1.0 1.0 1.0 1.0 1.0 1.0 1.0 1.0 1.0 1.0 1.0 1.0
1.0 1.0 1.0 1.0 1.0
HVENT 11 16 1 0.660400 0.0127000 0.00 0.00 0.00 0.00
CVENT 11 16 1 1.0 1.0 1.0 1.0 1.0 1.0 1.0 1.0 1.0 1.0 1.0 1.0 1.0 1.0
1.0 1.0 1.0 1.0 1.0
HVENT 14 16 1 0.457200 1.90500 0.00 0.00 0.00 0.00
CVENT 14 16 1 1.0 1.0 1.0 1.0 1.0 1.0 1.0 1.0 1.0 1.0 1.0 1.0 1.0 1.0
1.0 1.0 1.0 1.0 1.0
HVENT 15 16 1 0.457200 1.90500 0.00 0.00 0.00 0.00
CVENT 15 16 1 1.0 1.0 1.0 1.0 1.0 1.0 1.0 1.0 1.0 1.0 1.0 1.0 1.0 1.0
1.0 1.0 1.0 1.0 1.0
MVDCT 1 2 3.0 0.50 0.00 0.00 0.50 0.00 0.50 211 107
MVDCT 3 4 3.0 0.50 0.00 0.00 0.50 0.00 0.50 173 164
MVDCT 7 8 3.0 0.50 0.00 0.00 0.50 0.00 0.50 253 230
MVDCT 5 6 3.0 0.50 0.00 0.00 0.50 0.00 0.50 193 295
MVFAN 9 2 0.00 300.000 1.08548 0.00 0.00 0.00 0.00 137 102
MVFAN 10 8 0.00 300.000 1.08400 0.00 0.00 0.00 0.00 155 227
MVOPN 5 1 H 1.0 0.50 289 111 369 62
MVOPN 7 4 H 1.0 0.50 279 171 365 142
MVOPN 8 6 H 1.0 0.50 307 312 365 299
MVOPN 10 7 H 1.0 0.50 308 240 365 216
MVOPN 12 3 H 1.0 0.50 100 148 22 87
MVOPN 12 9 H 1.0 0.50 92 110 22 87
MVOPN 13 5 H 1.0 0.50 107 294 22 244
MVOPN 13 10 H 1.0 0.50 109 232 22 244
INELV 2 1.0 0 0
INELV 8 1.0 0 0
CHEMI 16. 50. 10. 1.95000E+007 293.150 493.150 0.300
LFBO 1
LFBT 2
CJET ALL
FPOS -1.0 -1.0 0.00
FTIME 33. 66. 99. 132.000 165.000 198.000 231.000 264.000 300.000 900.000 933.000
966.000 999.000 1032.00 1065.00 1098.00 1131.00 1164.00 1200.00
FMASS 0.00 0.000654518 0.00261807 0.00589067 0.0104723 0.0163629 0.0235626 0.0320713 0.0418891
0.0540923 0.0540923 0.0428465 0.0329097 0.0242821 0.0169633 0.0109537 0.00625308 0.00286148
0.000778928 0.00
FQDOT 0.00 12763.1 51052.3 114868. 204209. 319077. 459471. 625391. 816837. 1.05480E+006
1.05480E+006 835507. 641740. 473500. 330785. 213597. 121935. 55798.9 15189.1 0.00
HCR 0.080 0.080 0.080 0.080 0.080 0.080 0.080 0.080 0.080 0.080 0.080 0.080 0.080 0.080 0.080 0.080 0.080
0.080 0.080 0.0800
OD 0.090 0.090 0.090 0.090 0.090 0.090 0.090 0.090 0.090 0.090 0.090 0.090 0.090 0.090 0.090 0.090 0.090
0.090 0.090 0.0900
CO 0.10 0.10 0.10 0.10 0.10 0.10 0.10 0.10 0.10 0.10 0.10 0.10 0.10 0.10 0.10 0.10 0.10 0.10
0.10 0.10 0.100

```

B.3 SLEEPING CAR

The sleeping car is modeled as 23 compartments on 2 levels.

On the upper level, there are:

- two hallways;
- a porter's station in the center of the car;
- three economy bedrooms modeled as individual compartments;
- three economy bedrooms modeled as one compartment;
- two mechanical rooms for the HVAC system;
- three deluxe bedrooms modeled as one compartment; and
- two deluxe bedrooms modeled as individual compartments.

The lower level has:

- the hallway and luggage area as one compartment;
- a family bedroom compartment;
- three economy bedrooms modeled as three compartments;
- two bedroom compartments modeled as one compartment;
- two toilets modeled as two compartments;
- three toilets modeled as one compartment; and
- a bedroom for elderly and disabled persons.

The two levels are connected by:

- a single central staircase.

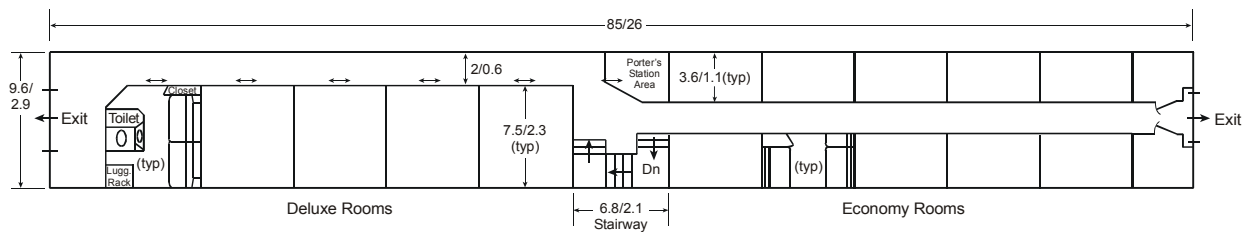

Upper Level Schematic

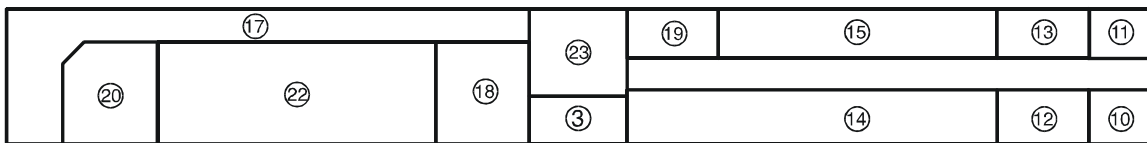

Upper Level Modeling Compartment Outlines

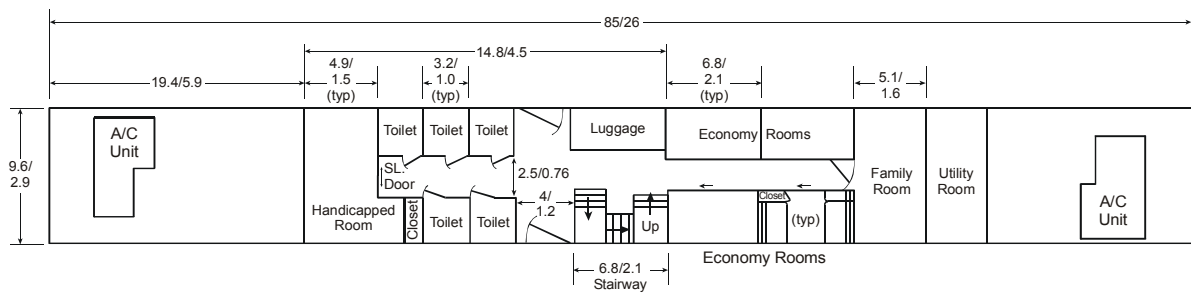

Lower Level Schematic

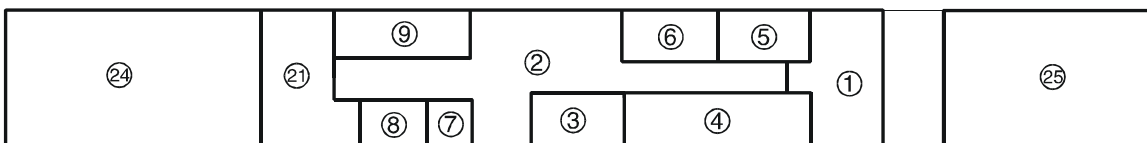

Lower Level Modeling Compartment Outlines

Figure B-3. Compartment Configuration for Sleeping Car Fire Modeling

Table B-3. Compartment and Vent Dimensions for Sleeping Car Fire Modeling

COMPARTMENT	DIMENSIONS (m)	VENT CONNECTIONS TO	DIMENSIONS (m)
1	1.56 x 2.90 x 1.98	2	0.51 x 1.93
		4	0.076 x 0.076
		5	0.076 x 0.076
2	9.80 x 1.24 x 1.98	1	0.51 x 1.93
		3	0.61 x 1.93
		4	0.58 x 1.93
		4	0.58 x 1.93
		5	0.58 x 1.93
		6	0.58 x 1.93
		7	0.48 x 1.93
		8	0.48 x 1.93
		9	1.45 x 1.93
		21	0.61 x 1.93
		Outside	0.01 x 0.50
3	2.06 x 1.14 x 3.96	2	0.61 x 1.93
		23	0.61 x 1.98
4	4.11 x 1.14 x 1.98	1	0.076 x 0.076
		2	0.61 x 1.93
		2	0.61 x 1.93
5	2.06 x 1.14 x 1.98	1	0.076 x 0.076
		2	0.58 x 1.93
		6	0.076 x 0.076
6	2.06 x 1.14 x 1.98	2	0.58 x 1.93
		5	0.076 x 0.076
7	0.99 x 1.07 x 1.98	2	0.48 x 1.93
		8	0.076 x 0.076

Table B-3. Compartment and Vent Dimensions for Sleeping Car Fire Modeling (cont.)

COMPARTMENT	DIMENSIONS (m)	VENT CONNECTIONS TO	DIMENSIONS (m)
8	1.42 x 1.07 x 1.98	2	0.48 x 1.93
		7	0.076 x 0.076
		21	0.076 x 0.076
9	2.97 x 1.07 x 1.98	2	1.45 x 1.93
		21	0.076 x 0.076
10	1.64 x 1.13 x 1.98	12	0.076 x 0.076
		16	0.48 x 1.93
11	1.64 x 1.13 x 1.98	13	0.076 x 0.076
		16	0.48 x 1.93
12	2.06 x 1.13 x 1.98	10	0.076 x 0.076
		14	0.076 x 0.076
		16	0.58 x 1.93
13	2.06 x 1.13 x 1.98	11	0.076 x 0.076
		15	0.076 x 0.076
		16	0.58 x 1.93
14	8.23 x 1.13 x 1.98	12	0.076 x 0.076
		16	2.29 x 1.93
15	6.17 x 1.13 x 1.98	13	0.076 x 0.076
		16	2.29 x 1.93
		19	0.076 x 0.076

Table B-3. Compartment and Vent Dimensions for Sleeping Car Modeling (cont.)

COMPARTMENT	DIMENSIONS (m)	VENT CONNECTIONS TO	DIMENSIONS (m)
16	11.31 x 0.61 x 1.98	10	0.48 x 1.93
		11	0.48 x 1.93
		12	0.58 x 1.93
		13	0.58 x 1.93
		14	2.29 x 1.93
		15	2.29 x 1.93
		19	0.58 x 1.93
		23	0.61 x 1.98
		Outside	0.005 x 0.50
17	11.93 x 0.92 x 1.98	18	0.58 x 1.93
		20	0.58 x 1.93
		22	1.73 x 1.93
		23	0.61 x 1.98
		Outside	0.005 x 0.50
18	2.06 x 2.27 x 1.98	17	0.58 x 1.93
		22	0.076 x 0.076
19	2.06 x 1.13 x 1.98	15	0.076 x 0.076
		16	0.58 x 1.93
20	2.06 x 2.27 x 1.98	17	0.58 x 1.93
		22	0.076 x 0.076
21	1.64 x 2.90 x 1.98	2	0.61 x 1.93
		8	0.076 x 0.076
		9	0.076 x 0.076
22	6.17 x 1.50 x 1.98	22	1.73 x 1.93
		22	0.076 x 0.076
23	2.06 x 1.77 1.98	3	0.61 x 1.98
		16	0.61 x 1.98
		17	0.61 x 1.98

Model Input for Sleeping Car Baseline Analysis

```

VERSN      3User Defined Base Case
#VERSN 3 User Defined Base Case
TIMES     1200 5 5 0 0
DUMPR 19MEDDO.HI
TAMB 293.150 101300. 0.00
EAMB 293.150 101300. 0.00
HI/F 0.00 0.00 0.00 0.00 0.00 0.00 0.00 0.00 0.00 0.00 1.98120 1.98120 1.98120 1.98120 1.98120 1.98120
1.98120 1.98120 1.98120 1.98120 1.98120 0.00 1.98120 1.98120
WIDTH 1.56210 9.79805 2.05740 4.11480 2.05740 2.05740 0.990600 1.41605 2.97180 1.63830 1.63830
2.05740 2.05740 8.22960 6.17220 11.3157 11.9253 2.05740 2.05740 2.05740 1.64084 6.17220 2.05740
DEPTH 2.89560 1.24460 1.14300 1.14300 1.14300 1.14300 1.06680 1.06680 1.06680 1.13030 1.13030
1.13030 1.13030 1.13030 1.13030 0.609600 0.922020 2.26695 1.13030 2.26695 2.89560 1.50495 1.76530
HEIGH 1.98120 1.98120 1.98120 3.96240 1.98120 1.98120 1.98120 1.98120 1.98120 1.98120 1.98120 1.98120
1.98120 1.98120 1.98120 1.98120 1.98120 1.98120 1.98120 1.98120 1.98120 1.98120 1.98120 1.98120
FLOOR PLYWOOD PLYWOOD PLYWOOD PLYWOOD PLYWOOD PLYWOOD PLYWOOD PLYWOOD PLYWOOD PLYWOOD PLYWOOD PLYWOOD
PLYWOOD PLYWOOD PLYWOOD PLYWOOD PLYWOOD PLYWOOD PLYWOOD PLYWOOD PLYWOOD PLYWOOD PLYWOOD OFF
#FLOOR PLYWOOD PLYWOOD PLYWOOD PLYWOOD PLYWOOD PLYWOOD PLYWOOD PLYWOOD PLYWOOD PLYWOOD PLYWOOD PLYWOOD
PLYWOOD PLYWOOD PLYWOOD PLYWOOD PLYWOOD PLYWOOD PLYWOOD PLYWOOD PLYWOOD PLYWOOD PLYWOOD PLYWOOD
SHAFT 3
HVENT 1 2 1 0.508000 1.93040 0.00 0.00 0.00 0.00
CVENT 1 2 1 1.0 1.0 1.0 1.0 1.0 1.0 1.0 1.0 1.0 1.0 1.0 1.0 1.0 1.0 1.0
1.0 1.0 1.0 1.0 1.0
HVENT 1 4 1 0.0762000 1.98120 1.90500 0.00 0.00 0.00
CVENT 1 4 1 1.0 1.0 1.0 1.0 1.0 1.0 1.0 1.0 1.0 1.0 1.0 1.0 1.0 1.0 1.0
1.0 1.0 1.0 1.0 1.0
HVENT 1 5 1 0.0762000 1.98120 1.90500 0.00 0.00 0.00
CVENT 1 5 1 1.0 1.0 1.0 1.0 1.0 1.0 1.0 1.0 1.0 1.0 1.0 1.0 1.0 1.0 1.0
1.0 1.0 1.0 1.0 1.0
HVENT 2 3 1 0.609600 1.93040 0.00 0.00 0.00 0.00
CVENT 2 3 1 1.0 1.0 1.0 1.0 1.0 1.0 1.0 1.0 1.0 1.0 1.0 1.0 1.0 1.0 1.0
1.0 1.0 1.0 1.0 1.0
HVENT 2 4 1 0.577850 1.93040 0.00 0.00 0.00 0.00
CVENT 2 4 1 1.0 1.0 1.0 1.0 1.0 1.0 1.0 1.0 1.0 1.0 1.0 1.0 1.0 1.0 1.0
1.0 1.0 1.0 1.0 1.0
HVENT 2 4 2 0.577850 1.93040 0.00 0.00 0.00 0.00
CVENT 2 4 2 1.0 1.0 1.0 1.0 1.0 1.0 1.0 1.0 1.0 1.0 1.0 1.0 1.0 1.0 1.0
1.0 1.0 1.0 1.0 1.0
HVENT 2 5 1 0.577850 1.93040 0.00 0.00 0.00 0.00
CVENT 2 5 1 1.0 1.0 1.0 1.0 1.0 1.0 1.0 1.0 1.0 1.0 1.0 1.0 1.0 1.0 1.0
1.0 1.0 1.0 1.0 1.0
HVENT 2 6 1 0.577850 1.93040 0.00 0.00 0.00 0.00
CVENT 2 6 1 1.0 1.0 1.0 1.0 1.0 1.0 1.0 1.0 1.0 1.0 1.0 1.0 1.0 1.0 1.0
1.0 1.0 1.0 1.0 1.0
HVENT 2 7 1 0.482600 1.93040 0.00 0.00 0.00 0.00
CVENT 2 7 1 1.0 1.0 1.0 1.0 1.0 1.0 1.0 1.0 1.0 1.0 1.0 1.0 1.0 1.0 1.0
1.0 1.0 1.0 1.0 1.0
HVENT 2 8 1 0.482600 1.93040 0.00 0.00 0.00 0.00
CVENT 2 8 1 1.0 1.0 1.0 1.0 1.0 1.0 1.0 1.0 1.0 1.0 1.0 1.0 1.0 1.0 1.0
1.0 1.0 1.0 1.0 1.0
HVENT 2 9 1 1.44780 1.93040 0.00 0.00 0.00 0.00
CVENT 2 9 1 1.0 1.0 1.0 1.0 1.0 1.0 1.0 1.0 1.0 1.0 1.0 1.0 1.0 1.0 1.0
1.0 1.0 1.0 1.0 1.0
HVENT 2 21 1 0.609600 1.93040 0.00 0.00 0.00 0.00
CVENT 2 21 1 1.0 1.0 1.0 1.0 1.0 1.0 1.0 1.0 1.0 1.0 1.0 1.0 1.0 1.0 1.0
1.0 1.0 1.0 1.0 1.0
HVENT 2 24 1 0.0100 0.50 0.00 0.00 0.00 0.00
CVENT 2 24 1 1.0 1.0 1.0 1.0 1.0 1.0 1.0 1.0 1.0 1.0 1.0 1.0 1.0 1.0 1.0
1.0 1.0 1.0 1.0 1.0

```

Model Input for Sleeping Car Baseline Analysis (con't)

HVENT	3	23	1	0.609600	3.96240	1.98120	0.00	0.00	0.00									
CVENT	3	23	1	1.0	1.0	1.0	1.0	1.0	1.0	1.0	1.0	1.0	1.0	1.0	1.0	1.0	1.0	1.0
	1.0	1.0	1.0	1.0	1.0													
HVENT	5	6	1	0.0762000	1.98120	1.90500	0.00	0.00	0.00									
CVENT	5	6	1	1.0	1.0	1.0	1.0	1.0	1.0	1.0	1.0	1.0	1.0	1.0	1.0	1.0	1.0	1.0
	1.0	1.0	1.0	1.0	1.0													
HVENT	7	8	1	0.0762000	1.98120	1.90500	0.00	0.00	0.00									
CVENT	7	8	1	1.0	1.0	1.0	1.0	1.0	1.0	1.0	1.0	1.0	1.0	1.0	1.0	1.0	1.0	1.0
	1.0	1.0	1.0	1.0	1.0													
HVENT	8	21	1	0.0762000	1.98120	1.90500	0.00	0.00	0.00									
CVENT	8	21	1	1.0	1.0	1.0	1.0	1.0	1.0	1.0	1.0	1.0	1.0	1.0	1.0	1.0	1.0	1.0
	1.0	1.0	1.0	1.0	1.0													
HVENT	9	21	1	0.0762000	1.98120	1.90500	0.00	0.00	0.00									
CVENT	9	21	1	1.0	1.0	1.0	1.0	1.0	1.0	1.0	1.0	1.0	1.0	1.0	1.0	1.0	1.0	1.0
	1.0	1.0	1.0	1.0	1.0													
HVENT	10	12	1	0.0762000	1.98120	1.90500	0.00	0.00	0.00									
CVENT	10	12	1	1.0	1.0	1.0	1.0	1.0	1.0	1.0	1.0	1.0	1.0	1.0	1.0	1.0	1.0	1.0
	1.0	1.0	1.0	1.0	1.0													
HVENT	10	16	1	0.482600	1.93040	0.00	0.00	0.00	0.00									
CVENT	10	16	1	1.0	1.0	1.0	1.0	1.0	1.0	1.0	1.0	1.0	1.0	1.0	1.0	1.0	1.0	1.0
	1.0	1.0	1.0	1.0	1.0													
HVENT	11	13	1	0.0762000	1.98120	1.90500	0.00	0.00	0.00									
CVENT	11	13	1	1.0	1.0	1.0	1.0	1.0	1.0	1.0	1.0	1.0	1.0	1.0	1.0	1.0	1.0	1.0
	1.0	1.0	1.0	1.0	1.0													
HVENT	11	16	1	0.482600	1.93040	0.00	0.00	0.00	0.00									
CVENT	11	16	1	1.0	1.0	1.0	1.0	1.0	1.0	1.0	1.0	1.0	1.0	1.0	1.0	1.0	1.0	1.0
	1.0	1.0	1.0	1.0	1.0													
HVENT	12	14	1	0.0762000	1.98120	1.90500	0.00	0.00	0.00									
CVENT	12	14	1	1.0	1.0	1.0	1.0	1.0	1.0	1.0	1.0	1.0	1.0	1.0	1.0	1.0	1.0	1.0
	1.0	1.0	1.0	1.0	1.0													
HVENT	12	16	1	0.577850	1.93040	0.00	0.00	0.00	0.00									
CVENT	12	16	1	1.0	1.0	1.0	1.0	1.0	1.0	1.0	1.0	1.0	1.0	1.0	1.0	1.0	1.0	1.0
	1.0	1.0	1.0	1.0	1.0													
HVENT	13	15	1	0.0762000	1.98120	1.90500	0.00	0.00	0.00									
CVENT	13	15	1	1.0	1.0	1.0	1.0	1.0	1.0	1.0	1.0	1.0	1.0	1.0	1.0	1.0	1.0	1.0
	1.0	1.0	1.0	1.0	1.0													
HVENT	13	16	1	0.577850	1.93040	0.00	0.00	0.00	0.00									
CVENT	13	16	1	1.0	1.0	1.0	1.0	1.0	1.0	1.0	1.0	1.0	1.0	1.0	1.0	1.0	1.0	1.0
	1.0	1.0	1.0	1.0	1.0													
HVENT	14	16	1	2.28600	1.93040	0.00	0.00	0.00	0.00									
CVENT	14	16	1	1.0	1.0	1.0	1.0	1.0	1.0	1.0	1.0	1.0	1.0	1.0	1.0	1.0	1.0	1.0
	1.0	1.0	1.0	1.0	1.0													
HVENT	15	16	1	2.28600	1.93040	0.00	0.00	0.00	0.00									
CVENT	15	16	1	1.0	1.0	1.0	1.0	1.0	1.0	1.0	1.0	1.0	1.0	1.0	1.0	1.0	1.0	1.0
	1.0	1.0	1.0	1.0	1.0													
HVENT	15	19	1	0.0762000	1.98120	1.90500	0.00	0.00	0.00									
CVENT	15	19	1	1.0	1.0	1.0	1.0	1.0	1.0	1.0	1.0	1.0	1.0	1.0	1.0	1.0	1.0	1.0
	1.0	1.0	1.0	1.0	1.0													
HVENT	16	19	1	0.577850	1.93040	0.00	0.00	0.00	0.00									
CVENT	16	19	1	1.0	1.0	1.0	1.0	1.0	1.0	1.0	1.0	1.0	1.0	1.0	1.0	1.0	1.0	1.0
	1.0	1.0	1.0	1.0	1.0													
HVENT	16	23	1	0.609600	1.98120	0.00	0.00	0.00	0.00									
CVENT	16	23	1	1.0	1.0	1.0	1.0	1.0	1.0	1.0	1.0	1.0	1.0	1.0	1.0	1.0	1.0	1.0
	1.0	1.0	1.0	1.0	1.0													
HVENT	16	24	1	0.0050	0.50	0.00	0.00	0.00	0.00									
CVENT	16	24	1	1.0	1.0	1.0	1.0	1.0	1.0	1.0	1.0	1.0	1.0	1.0	1.0	1.0	1.0	1.0
	1.0	1.0	1.0	1.0	1.0													
HVENT	17	18	1	0.577850	1.93040	0.00	0.00	0.00	0.00									

Model Input for Sleeping Car Baseline Analysis (con't)

```

CVENT 17 18 1 1.0 1.0 1.0 1.0 1.0 1.0 1.0 1.0 1.0 1.0 1.0 1.0 1.0 1.0
1.0 1.0 1.0 1.0 1.0
HVENT 17 20 1 0.577850 1.93040 0.00 0.00 0.00 0.00
CVENT 17 20 1 1.0 1.0 1.0 1.0 1.0 1.0 1.0 1.0 1.0 1.0 1.0 1.0 1.0 1.0
1.0 1.0 1.0 1.0 1.0
HVENT 17 22 1 1.73355 1.93040 0.00 0.00 0.00 0.00
CVENT 17 22 1 1.0 1.0 1.0 1.0 1.0 1.0 1.0 1.0 1.0 1.0 1.0 1.0 1.0 1.0
1.0 1.0 1.0 1.0 1.0
HVENT 17 23 1 0.609600 1.98120 0.00 0.00 0.00 0.00
CVENT 17 23 1 1.0 1.0 1.0 1.0 1.0 1.0 1.0 1.0 1.0 1.0 1.0 1.0 1.0 1.0
1.0 1.0 1.0 1.0 1.0
HVENT 17 24 1 0.0050 0.50 0.00 0.00 0.00 0.00
CVENT 17 24 1 1.0 1.0 1.0 1.0 1.0 1.0 1.0 1.0 1.0 1.0 1.0 1.0 1.0 1.0
1.0 1.0 1.0 1.0 1.0
HVENT 18 22 1 0.0762000 1.98120 1.90500 0.00 0.00 0.00
CVENT 18 22 1 1.0 1.0 1.0 1.0 1.0 1.0 1.0 1.0 1.0 1.0 1.0 1.0 1.0 1.0
1.0 1.0 1.0 1.0 1.0
HVENT 20 22 1 0.0762000 1.98120 1.90500 0.00 0.00 0.00
CVENT 20 22 1 1.0 1.0 1.0 1.0 1.0 1.0 1.0 1.0 1.0 1.0 1.0 1.0 1.0 1.0
1.0 1.0 1.0 1.0 1.0
CHEMI 16. 50. 10. 1.95000E+007 293.150 493.150 0.300
LFBO 19
LFBT 2
CJET ALL
FPOS -1.0 -1.0 0.00
FTIME 33. 66. 99. 132.000 165.000 198.000 231.000 264.000 300.000 900.000 933.000
966.000 999.000 1032.00 1065.00 1098.00 1131.00 1164.00 1200.00
FMASS 0.00 0.000654518 0.00261807 0.00589067 0.0104723 0.0163629 0.0235626 0.0320713 0.0418891
0.0540923 0.0540923 0.0428465 0.0329097 0.0242821 0.0169633 0.0109537 0.00625308 0.00286148
0.000778928 0.00
FQDOT 0.00 12763.1 51052.3 114868. 204209. 319077. 459471. 625391. 816837. 1.05480E+006
1.05480E+006 835507. 641740. 473500. 330785. 213597. 121935. 55798.9 15189.1 0.00
HCR 0.080 0.080 0.080 0.080 0.080 0.080 0.080 0.080 0.080 0.080 0.080 0.080 0.080 0.080 0.080 0.080
0.080 0.080 0.0800
OD 0.090 0.090 0.090 0.090 0.090 0.090 0.090 0.090 0.090 0.090 0.090 0.090 0.090 0.090 0.090 0.090
0.090 0.090 0.0900
CO 0.10 0.10 0.10 0.10 0.10 0.10 0.10 0.10 0.10 0.10 0.10 0.10 0.10 0.10 0.10 0.10 0.10
0.10 0.10 0.100
STFMAX 0.1

```