



U.S. Department
of Transportation

Federal Railroad
Administration

Cracking and Impact Performance Characteristics of Plastic Composite Ties

Office of Railroad
Policy and Development
Washington, DC 20590

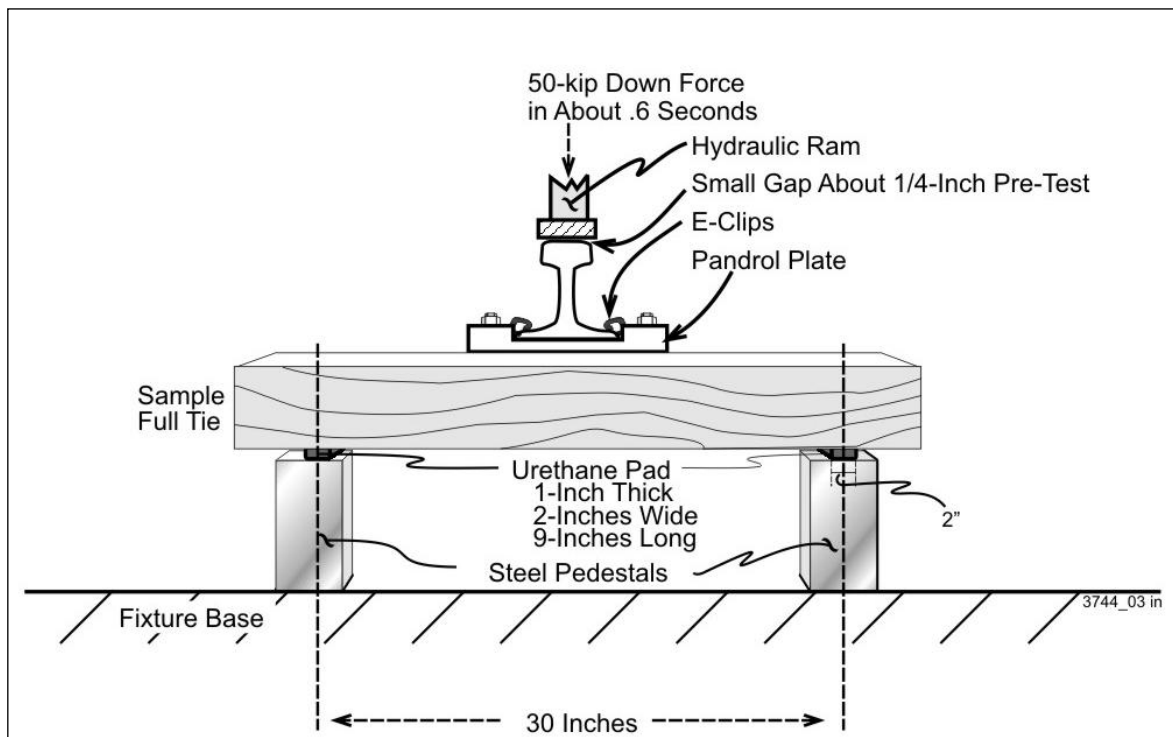

NOTICE

This document is disseminated under the sponsorship of the Department of Transportation in the interest of information exchange. The United States Government assumes no liability for its contents or use thereof. Any opinions, findings and conclusions, or recommendations expressed in this material do not necessarily reflect the views or policies of the United States Government, nor does mention of trade names, commercial products, or organizations imply endorsement by the United States Government. The United States Government assumes no liability for the content or use of the material contained in this document.

NOTICE

The United States Government does not endorse products or manufacturers. Trade or manufacturers' names appear herein solely because they are considered essential to the objective of this report.

REPORT DOCUMENTATION PAGE*Form approved
OMB No. 0704-0188*

Public reporting burden for this collection of information is estimated to average 1 hour per response, including the time for reviewing instructions, searching existing data sources, gathering and maintaining the data needed, and completing and reviewing the collection of information. Send comments regarding this burden estimate or any other aspect of this collection of information, including suggestions for reducing this burden to Washington Headquarters Services, Directorate for Information Operations and Reports, 1215 Jefferson Davis Highway, Suite 1204, Arlington, VA 22202-4302, and to the Office of Management and Budget, Paperwork Reduction Project (0702-0288), Washington, D.C. 20503

1. AGENCY USE ONLY (Leave blank)		2. REPORT DATE March 2012	3. REPORT TYPE AND DATES COVERED Technical Report	
4. TITLE AND SUBTITLE Cracking and Impact Performance Characteristics of Plastic Composite Ties			5. FUNDING NUMBERS	
6. AUTHOR(S) Richard Reiff and Carmen Trevizo				
7. PERFORMING ORGANIZATION NAME(S) AND ADDRESS(ES) Transportation Technology Center, Inc. P.O. Box 11130 Pueblo, CO 81001			8. PERFORMING ORGANIZATION REPORT NUMBERS DTFR53-00-C-00012 Task Order 227	
9. SPONSORING/MONITORING AGENCY NAME(S) AND ADDRESS(ES) U.S. Department of Transportation Federal Railroad Administration Office of Railroad Policy and Development, MS 20 1200 New Jersey Avenue, SE Washington, DC 20590			10. SPONSORING/MONITORING AGENCY REPORT NUMBER DOT/FRA/ORD-12/03	
11. SUPPLEMENTARY NOTES Program Manager: Mahmood Fateh				
12a. DISTRIBUTION/AVAILABILITY STATEMENT This document is available to the public on the FRA Web site at http://www.fra.dot.gov .			12b. DISTRIBUTION CODE	
13. ABSTRACT As followup to a workshop on Engineered Composite Ties sponsored by the American Railway Engineering and Maintenance-of-Way Association and the Federal Railroad Administration, the Transportation Technology Center, Inc., in Pueblo, CO, conducted a series of tests addressing material performance issues. A primary objective of the workshop was to identify performance concerns and potential areas of research by using input from the Class I railroad representatives. Class I railroads have installed plastic/composite ties in their tracks for several years for evaluation purposes. A panel of Class I railroad engineers attending the workshop noted tie cracking and fractures during handling, installation, and service as priority areas of concern.				
14. SUBJECT TERMS High-density polyethylene, modulus of elasticity, modulus of rupture, plastic composite ties			15. NUMBER OF PAGES 54	
			16. PRICE CODE	
17. SECURITY CLASSIFICATION OF REPORT UNCLASSIFIED	18. SECURITY CLASSIFICATION OF THIS PAGE UNCLASSIFIED	19. SECURITY CLASSIFICATION OF ABSTRACT UNCLASSIFIED	20. LIMITATION OF ABSTRACT	

NSN 7540-01-280-5500

Standard Form 298 (Rev. 2-89)
Prescribed by ANSI/NISO Std. Z39.18
298-102

METRIC/ENGLISH CONVERSION FACTORS

ENGLISH TO METRIC

METRIC TO ENGLISH

<p>LENGTH (APPROXIMATE)</p> <p>1 inch (in) = 2.5 centimeters (cm)</p> <p>1 foot (ft) = 30 centimeters (cm)</p> <p>1 yard (yd) = 0.9 meter (m)</p> <p>1 mile (mi) = 1.6 kilometers (km)</p>	<p>LENGTH (APPROXIMATE)</p> <p>1 millimeter (mm) = 0.04 inch (in)</p> <p>1 centimeter (cm) = 0.4 inch (in)</p> <p>1 meter (m) = 3.3 feet (ft)</p> <p>1 meter (m) = 1.1 yards (yd)</p> <p>1 kilometer (km) = 0.6 mile (mi)</p>
<p>AREA (APPROXIMATE)</p> <p>1 square inch (sq in, in²) = 6.5 square centimeters (cm²)</p> <p>1 square foot (sq ft, ft²) = 0.09 square meter (m²)</p> <p>1 square yard (sq yd, yd²) = 0.8 square meter (m²)</p> <p>1 square mile (sq mi, mi²) = 2.6 square kilometers (km²)</p> <p>1 acre = 0.4 hectare (he) = 4,000 square meters (m²)</p>	<p>AREA (APPROXIMATE)</p> <p>1 square centimeter (cm²) = 0.16 square inch (sq in, in²)</p> <p>1 square meter (m²) = 1.2 square yards (sq yd, yd²)</p> <p>1 square kilometer (km²) = 0.4 square mile (sq mi, mi²)</p> <p>10,000 square meters (m²) = 1 hectare (ha) = 2.5 acres</p>
<p>MASS - WEIGHT (APPROXIMATE)</p> <p>1 ounce (oz) = 28 grams (gm)</p> <p>1 pound (lb) = 0.45 kilogram (kg)</p> <p>1 short ton = 2,000 pounds (lb) = 0.9 tonne (t)</p>	<p>MASS - WEIGHT (APPROXIMATE)</p> <p>1 gram (gm) = 0.036 ounce (oz)</p> <p>1 kilogram (kg) = 2.2 pounds (lb)</p> <p>1 tonne (t) = 1,000 kilograms (kg) = 1.1 short tons</p>
<p>VOLUME (APPROXIMATE)</p> <p>1 teaspoon (tsp) = 5 milliliters (ml)</p> <p>1 tablespoon (tbsp) = 15 milliliters (ml)</p> <p>1 fluid ounce (fl oz) = 30 milliliters (ml)</p> <p>1 cup (c) = 0.24 liter (l)</p> <p>1 pint (pt) = 0.47 liter (l)</p> <p>1 quart (qt) = 0.96 liter (l)</p> <p>1 gallon (gal) = 3.8 liters (l)</p> <p>1 cubic foot (cu ft, ft³) = 0.03 cubic meter (m³)</p> <p>1 cubic yard (cu yd, yd³) = 0.76 cubic meter (m³)</p>	<p>VOLUME (APPROXIMATE)</p> <p>1 milliliter (ml) = 0.03 fluid ounce (fl oz)</p> <p>1 liter (l) = 2.1 pints (pt)</p> <p>1 liter (l) = 1.06 quarts (qt)</p> <p>1 liter (l) = 0.26 gallon (gal)</p> <p>1 cubic meter (m³) = 36 cubic feet (cu ft, ft³)</p> <p>1 cubic meter (m³) = 1.3 cubic yards (cu yd, yd³)</p>
<p>TEMPERATURE (EXACT)</p> <p>$[(x-32)(5/9)]\text{ }^\circ\text{F} = y\text{ }^\circ\text{C}$</p>	<p>TEMPERATURE (EXACT)</p> <p>$[(9/5)y + 32]\text{ }^\circ\text{C} = x\text{ }^\circ\text{F}$</p>

QUICK INCH - CENTIMETER LENGTH CONVERSION

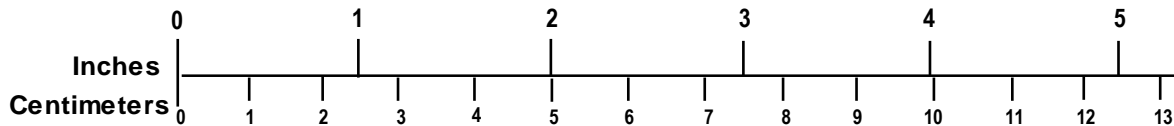

QUICK FAHRENHEIT - CELSIUS TEMPERATURE CONVERSION

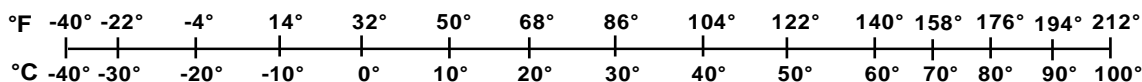

For more exact and or other conversion factors, see NIST Miscellaneous Publication 286, Units of Weights and Measures. Price \$2.50 SD Catalog No. C13 10286

Updated 6/17/98

Acknowledgments

A test of this scope required the cooperative effort of several individuals and companies. The Federal Railroad Administration, through Mahmood Fateh of the Office of Railroad Policy and Development, provided the funding and technical direction for this project. Mr. Richard Lampo of the U.S. Army Corps of Engineers, Engineer Research and Development Center, Construction Engineering Research Laboratory at Champaign, IL, provided direct technical assistance. Transportation Technology Center, Inc., support was provided by Rafael Jimenez and James Rzonca. BNSF Railway provided ties and outside technical assistance through John Bosshart and Henry Sullivan of TieTek. Without the generous support and cooperation from these individuals and their employers, this program could not have been conducted.

Contents

Executive Summary	1
1 Introduction	2
2 Objectives and Findings	3
3 Approach	4
4 Methodology.....	5
5 Ties Evaluated	6
6 Test Matrix	7
6.1 RS Tests—Bending	7
6.2 RS Tests—Impact Loading	7
6.3 Center Bending Tests	8
7 Results	9
7.1 RS Stiffness: Half-Length Tie Samples, No Fastener System Attached.....	9
7.2 RSP: Half-Length Tie Samples with Holes Predrilled for SS Plates, No Fastener System Attached.....	10
7.3 RSP: Half-Length Tie Samples with SS Fastening System Plate Installed	11
7.4 RSP: Half-Length Tie Samples, with Overdriven SS Fastener System Attached	13
7.5 RSP: Half-Length Tie Samples with CS Fastener System Attached	14
7.6 RSN: Half-Length Tie Samples with CS Fastener System Attached.....	14
7.7 RSN: Half-Length Tie Samples with SS Fastener System Attached	16
7.8 RSN Tests by Tie Type	17
7.9 Impact Tests: RSP, Half-Length Tie Samples	18
7.10 Overall Impact Testing Results	24
7.11 Full-Length Tie Center Bending—MOE	24
7.12 Full-Length Tie Center Bending—MOR	25
8 Addendum to Test Matrix	27
8.1 Overview of Additional Testing for Repeatability.....	27
8.2 Results Separated by Tie Manufacturer	29
8.3 Summary of Observations: Effects from Tie Aging and Retesting after Outside Storage	34
8.4 Testing Procedures	34
8.5 Tie Samples Required to Obtain Statistically Sound Average.....	35

9	Discussion of Results and Recommendations	36
9.1	Items to Consider for Further Testing	36
9.2	Recommendations for Future Testing	37
	Appendix A. Test Matrix and Codes	38
	Abbreviations and Acronyms.....	44

Illustrations

Figure 1. Test Setup for RS Stiffness Testing; Supports Are 30 in Apart	9
Figure 2. RS Bending Stiffness, No Fastening System or Drilled Holes.....	10
Figure 3. RSP, Holes Only (New) and Holes from Overdriven SSs, -25°F, No Fastener	11
Figure 4. RSP, Half-Length Tie Test Fixture Setup for SSs Tie Plate System Fitted to the RS.....	12
Figure 5. RSP Results from Evaluating a SS System on All New Ties.....	12
Figure 6. RSP Stiffness Using an Overdriven SS Fastening System Attached	13
Figure 7. RSP Stiffness Using Standard CSs/Tie Plate System with No Predrilling of Holes on New Ties	14
Figure 8. RSN Bending Load Fixture and Setup	15
Figure 9. RSN Bending Test Results, All New Ties, CS Fastening System	15
Figure 10. RSN Bending Results, All New Ties, SS Fastening System.....	16
Figure 11. RSN Bending Results, All Ties, Overdriven SS Fastening System	16
Figure 12. RSN Results, All Fastening Systems, for Type A Only	17
Figure 13. RSN Results, All Fastening Systems, for Type B Only	17
Figure 14. RSN Results, All Fastening Systems, for Type C Only	18
Figure 15. Impact Loading Test Fixture and Configuration	19
Figure 16. RSP, Type A—Standard SS Plate, Fully Applied with Normal Holes, No Plate, New Ties.....	20
Figure 17. RSP, Type A—SS Plate Overdriven, Fully Applied with Overdriven Holes Only, No Plate.....	20
Figure 18. RSP, Impact Type A—Overdriven, Standard SS Plate Fully Applied and with Normal Holes, No Plate	21
Figure 19. RSP, Impact Type C—SS Fastening System Fully Applied with Overdriven Holes Only, No Tie Plate	22
Figure 20. RSP, New Type B—Standard SS Plate Fully Applied with Normal Holes, No Plate	23
Figure 21. RSP, Type B—SS Plate Overdriven Fully Applied with Overdriven Holes Only, No Plate	23
Figure 22. Tie Test Center Bending Load Fixture Setup.....	24
Figure 23. RS Bending Test Results, Average Stiffness for All Tests Conducted May 2007.....	28
Figure 24. Standard Deviation of Bending Test Results Shown in Figure 23	28

Figure 25. Results from Single and Multiple Tests Conducted on Type A Tie
Samples 30

Figure 26. Results from Single and Multiple Tests Conducted on Type B Tie
Samples 31

Figure 27. Results from Single and Multiple Tests Conducted on Type C Tie
Samples 33

Tables

Table 1. Summary of Load/Deflection Results—Center Bending 25

Table 2. MOR Test Results..... 26

Table 3. MOR Summarized Results 26

Executive Summary

As followup to a workshop on Engineered Composite Ties sponsored by the American Railway Engineering and Maintenance-of-Way Association (AREMA), the Federal Railroad Administration (FRA), and the Transportation Technology Center, Inc. (TTCI), in Pueblo, CO, conducted a series of tests addressing material performance issues. The workshop's primary objective was to identify performance concerns and potential areas of research by using input from Class I railroad representatives. Class I railroads have installed plastic/composite ties in their tracks for several years for evaluation purposes with respect to both performance and economy. A panel of Class I railroad engineers attending the workshop noted tie cracking and fractures during handling, installation, and service as priority areas of concern.

Selecting a laboratory test to screen the performance of plastic/composite ties before their use in service may depend on specific material characteristics or proprietary differences between ties. Overall, most bending tests of half-length and full-length tie samples that were provided for testing suggest the biggest differences were noted when tests were conducted with cold materials (-25°F). During these controlled temperatures, overall stiffness increased significantly more than tests conducted at ambient and elevated temperatures. The addition of holes (from cut spikes (CSs) or screw spikes (SSs)) did not significantly change performance results.

The laboratory test procedures followed by TTCI were not able to re-create cracks in the tie samples. For this reason, the influence of pre-existing cracks could not be evaluated as originally planned. Numerous attempts to produce cracks by improperly installing fasteners did not produce failures as reported from railroad field sites. This suggests that a full understanding of what causes crack initiation upon fastener insertion does not yet exist. Therefore, additional effort is needed to develop a procedure that can screen ties prone to cracking during the fastener installation process.

When SS fastening systems were installed and the SSs were purposely overdriven ("overdriven" meaning using an undersized predrill to see if it was the cause in the failed attempt to produce cracks), the result increased rail seat (RS) bending stiffness, except at elevated temperatures. The combination of a plate held down with overdriven SSs appeared to reinforce the tie in bending, suggesting that ties should be tested with no fastener system to ensure that results are not influenced by improperly installed plates. Elevated temperatures tended to reduce bending stiffness even when the fastening systems were installed on the ties.

Most results for tie bending stiffness varied the same by manufacturer regardless of whether the test was conducted for RS positive (RSP), RS negative (RSN), or full-length center bending.

The largest difference in performance between manufacturers was shown during impact tests, all of which were conducted with ties at -25°F. All ties survived 10 repeated impacts of 50,000 pounds (lb) of force with the fastening system installed on the ties (and impact load applied to the tie plate); however, two of the three tie types failed the impact tests when the load was applied directly to the RS area of the ties. This suggests that the fastening system offers a significant attenuation and reduction of impact load applied to the tie.

1. Introduction

As followup to a workshop on Engineered Composite Ties sponsored by AREMA and FRA, during April 29–30, 2004, TTCI conducted a series of tests addressing material performance issues. The workshop's primary objective was to identify performance concerns and potential areas of research by using input from Class I railroad representatives. Class I railroads have installed plastic/composite ties in their tracks for several years for evaluation purposes. A panel of Class I railroad engineers attending the workshop noted tie cracking and fractures during handling, installation, and service as priority areas of concern.

Concerns voiced by the panel of Class I railroad engineers at the workshop and TTCI's experience suggest that some performance characteristics of plastic/composite ties need further evaluation to allow laboratory-based screening of ties before selection and installation. To address these concerns, FRA has sponsored a series of laboratory evaluations to identify improved specifications for selecting plastic/composite ties to ensure long-term safety when installed in track.

2. Objectives and Findings

Many issues related to plastic/composite tie performance were raised at the Engineered Composite Ties workshop. AREMA Committee 30 used the workshop results to propose future updates to Chapter 30, Part 5, of the AREMA Railway Engineering Manual. Questions regarding major issues with plastic/composite tie performance addressed at the workshop and that were evaluated in this FRA-sponsored project include the following:

- Do the stress risers created by the SS threads as they cut into the plastic/composite tie material weaken the RS area?
- Does the reduction of cross-sectional area (approximately 10 percent), caused by predrilling for SSs, reduce the bending strength of the RS area with the fastening system (four SSs and tie plate) in place?
- Does a plastic/composite tie that is cracked as a result of SS installation provide less bending strength in the RS area with the fastening system (four SSs and tie plate) in place?
- What is the bending strength in the RS area with the SSs and tie plate removed when cracks are present and without cracks?
- Because of the wide range of tie plate hole patterns, some railroads prefer to install CSs without first predrilling a pilot hole. What effect does the wedging force created when CSs are pressed into the plastic/composite ties have on weakening the RS area?
- In a simulated center-bound tie condition (three-point bending), how much center-bending load will result in 1-inch track gage widening? When the load is released, will the tie be permanently deformed?
- The load environment under heavy axle load (HAL) traffic can be quite severe. How do plastic/composite ties perform under simulated impact forces?
- What is the effect of ambient temperature on:
 - Modulus of elasticity (MOE)?
 - Modulus of rupture (MOR)?
 - Permanent deformation after bending at the tie center?

3. Approach

Plastic/composite ties from three different manufacturers are beginning to see more widespread use in Class I railroad applications. Examples of these ties were selected to obtain performance data on designs with known performance history. These same three tie types have also been in service successfully under 39-ton HAL traffic on the High Tonnage Loop (HTL) at the Facility for Accelerated Service Testing (FAST) for at least 400 million gross tons (MGT); a few of the initial plastic/composite ties installed in the HTL have seen 1,000 MGT.

Since the initiation of this test program, two of the three manufacturers have ceased producing plastic/composite ties. Through cooperative efforts from Association of American Railroads (AAR) member railroads (along with purchases from excess stock), TTCI was able to obtain 25 new, unused, and properly stored tie samples from three designs. All tie designs tested met the following criteria:

- Tie samples passed all existing, current AREMA Chapter 30 requirements for plastic/composite ties.
- A minimum of 10 tie samples had survived in revenue service or at FAST, demonstrating that they can survive under freight railroad operating conditions.

The FRA Contract Officer Technical Representative approved tie designs selected for testing.

4. Methodology

The Test Implementation Plan generated for this project focused on three areas of interest:

1. *RS Bending*

- In the RS area with each fastening system (CSs, SSs, and their corresponding tie plates) in place—no cracks in the tie
- In the RS area with SS system in place when cracks are present in the tie
- In the RS area with the SSs removed—vacant holes—no cracks in the tie
- In the RS area with the SSs removed—vacant holes with cracks in the tie
- Calculated MOR
- Compared with a plastic/composite tie, virgin RS area—never predrilled, never fastened
- Compared with an oak tie with SSs and tie plate in place

2. *RS Impact Loading*

- In the RS area with SS system in place with no cracks in the tie
- In the RS area with SS system in place when cracks are present in the tie
- In the RS area with the SSs removed—vacant holes—no cracks in the tie
- In the RS area with the SSs removed—vacant holes with cracks in the tie
- Accessed RS condition

3. *Tie Center Bending*

- At the center of the tie—MOE, MOR, and permanent deformation at 1-inch gage widening
- Compared with published MOE and MOR test results

The tests were performed to produce three-point positive and three-point negative bending moments by using a Material Testing System (MTS) machine. Vertical deflection at the neutral axis, center of each span, was measured using a string potentiometer. A load cell on the MTS machine was used to measure the applied loads.

The tests were repeated using CSs and SSs at tie-center temperatures of $-25^{\circ}\text{F} (\pm 5)$, 80°F (ambient) (± 5) and at $120^{\circ}\text{F} (\pm 5)$. The low-temperature requirement was achieved by storing the test tie samples in a cold storage room at Transportation Technology Center (TTC), in Pueblo, CO. Heat lamps were used to raise the test tie samples to the high-temperature requirement. A thermocouple was embedded near the center of the test tie samples at the neutral axis to monitor temperature.

All load and deflection data was collected using TTCI's electronic data acquisition system. Each sample tie was used for one test only.

5. Ties Evaluated

Most current plastic composite ties use high-density polyethylene (HDPE) as the primary manufacturing component. Other materials are added to the basic tie mix for several reasons—one of which is to act as reinforcing material to improve specific physical properties. Ties made from 100-percent HDPE would be too flexible to hold gage under load or meet the AREMA minimum-bending modulus. Each manufacturer has its own proprietary mix of ingredients and production process. Ties from three manufacturers used in this study have the following generic descriptions:

- *Type A:* Two different thermoplastics are mixed in this formula. Polystyrene plastic is added to HDPE as reinforcement.
- *Type B:* HDPE with crystalline mineral fillers added to increase compression strength and abrasion resistance. Reinforcing fibers are added to increase bending modulus.
- *Type C:* Glass fibers are added to HDPE to increase bending modulus and abrasion resistance.
- *Type D:* Wood (oak) is used as a control.

6. Test Matrix

The Appendix shows a matrix of all ties tested. Each test summary section shows details of the setup. The following provides an overview of the tests.

6.1 RS Tests—Bending

The RS tests were performed on half-length tie samples as follows:

- CSs: 14-inch tie plate with five CSs—two diagonally opposed anchor spikes, two gage-side rail spikes, and one field-side rail spike—no pilot holes.
- The CSd test tie samples were loaded in the center of a 28-inch span.
- SSs: 16-inch tie plate with four standard 15/16-inch SSs—11/16-inch diameter by 5-inch-deep pilot holes.
- Cracked RS tests: RS cracks were intended for 21 ties by inserting SSs into small-diameter pilot holes. Although this occurs in TTCI's field tests, laboratory simulations produced no cracks in ties.
- The SSd test tie samples were loaded in the center of a 30-inch span.
- The RSs were loaded to a maximum 20-kilopound (kip) vertical load or failure at a rate of 5 kip per minute (min).
- Positive moment loads were applied directly onto the tie plates. Negative moment loads were applied to a $5\frac{1}{2} \times 9 \times 1$ -inch-thick rubber support (50 durometer, A scale) on the bottom of the test tie sample directly under the RS. In both cases, a $2 \times 9 \times 1$ -inch-thick rubber support (50 durometer, A scale) was used at each reaction point.

6.2 RS Tests—Impact Loading

The RS tests were performed on half-length tie samples as follows:

- Fastening system: 16-inch tie plate with four standard 15/16-inch SSs, 11/16-inch diameter by 5-inch deep pilot holes, and two e-clip rail fasteners.
- Cracked RS tests: RS cracks were intended to be created in six ties by inserting SSs into small-diameter pilot holes. Although this created cracks in TTCI's field tests, the laboratory simulations did not produce cracks.
- The SSd test tie samples were loaded in the center of a 30-inch span.
- An impact load, to simulate those caused by wheel flats and special trackwork, was applied to a short rail section fastened to the tie sample.
- A pretest trial was performed to verify that the impact pulse and duration (delta time) is within the range seen in track.
- Each test configuration was subjected to 10 impacts.

6.3 Center Bending Tests

The center bending tests were performed on full-length ties as follows:

- *MOE and Permanent Deformation:*
 - The test ties were loaded at the center of a 60-inch span using a $5\frac{1}{2} \times 9 \times 1$ -inch-thick rubber support. A $2 \times 9 \times 1$ -inch-thick rubber support (50 durometer, A scale) was used at each reaction point.
 - The vertical load was applied at a crosshead speed of 1 in/min until the tie-center deflection measured at the neutral axis reached 2.5 in.
 - The 2.5-inch tie-center deflection was held for 30 min at ambient temperature and then unloaded.
 - Residual tie-center deflection were measured once the load is released and again after 24 hours.
 - MOE was calculated as tangent modulus (from 0 to 400 pounds per square inch (psi)) per American Society for Testing and Materials (ASTM) Standards test method D6109.
- *MOR:*
 - The test ties were loaded at the center of a 60-inch span.
 - The vertical load was applied at a crosshead speed of 1 in/min to a maximum tie-center deflection of 5 in or failure.
 - MOR was calculated as per ASTM test method D6109.

7. Results

Sections 7.1 through 7.12 summarize results from testing each configuration. Tie samples from all three tie manufacturers were evaluated at the three specified temperatures for each configuration. As much as feasible, tie temperatures during all tests were controlled to $\pm 5^\circ\text{F}$:

- Low (-25°F)
- Ambient (80°F)
- Elevated (120°F)

Test fixture layout and tie size/support are changed for each configuration as specified in the test plan. A sketch showing the overall layout, load path, and support conditions is shown for each configuration.

Data was collected for load and deflection, recorded, and summarized for posttest analysis. The data shown is the summary and end-of-test, data for load/deflection and converted to stiffness values. Temperatures represent the average for all tie samples tested.

7.1 RS Stiffness: Half-Length Tie Samples, No Fastener System Attached

The RS stiffness test was conducted to evaluate the bending strength of the RS area of an unmodified, bare, half-length tie sample. As no fasteners or holes were attached or drilled, this is an evaluation of the tie's pure material/shape strength characteristics.

A total of nine tests were conducted. Figure 1 shows the test setup.

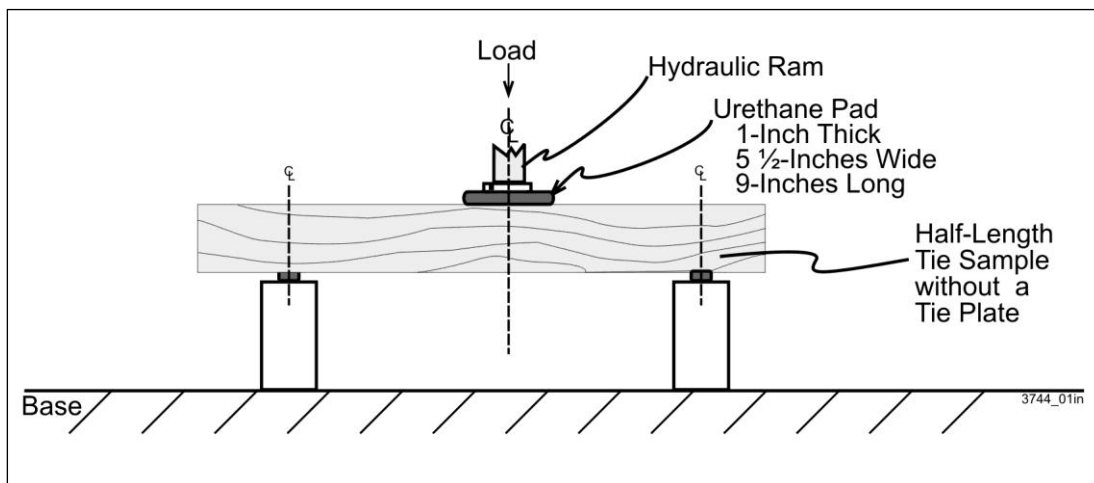

Figure 1. Test Setup for RS Stiffness Testing. Supports Are 30 in Apart

Examination of Figure 2 shows that the bending stiffness of all the ties tested increased as the temperature was lowered from 120 to -25°F . The material and configuration used in the Type C design produced greater stiffness values than the other two tie types.

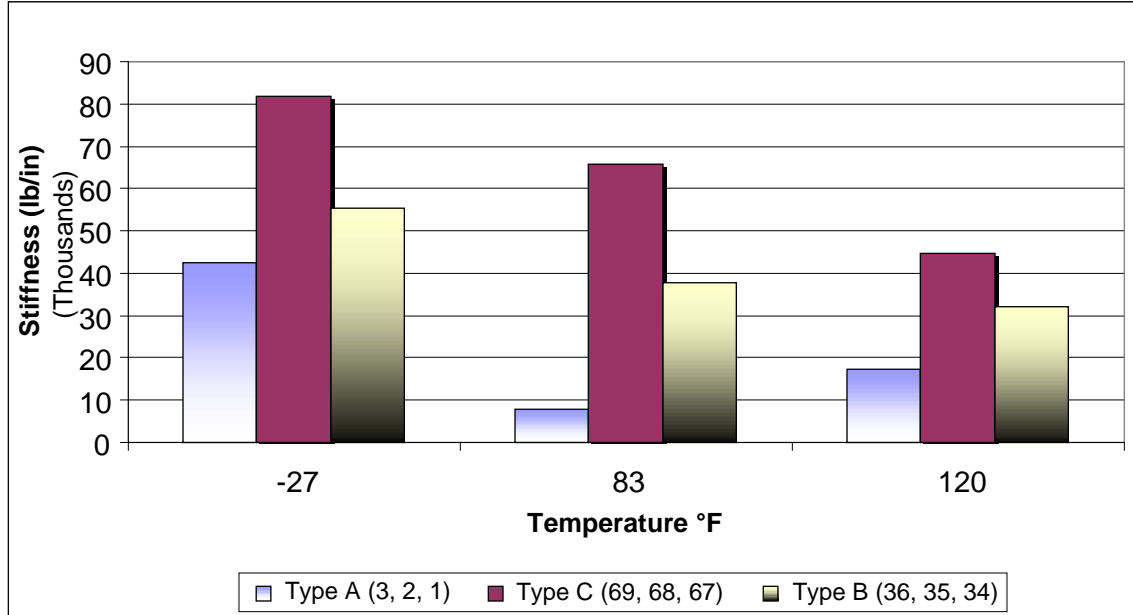

Figure 2. RS Bending Stiffness, No Fastening System or Drilled Holes

As this test only evaluates bending stiffness of the tie material, it does not show the effect (increase or decrease) on bending stiffness that may result from the addition of holes, tie plates, or fasteners. Other tests, as outlined in Sections 7.2 through 7.9, repeat these basic evaluations of RS bending but with the addition of various fastening systems.

No ties failed or broke during these RSP tests.

7.2 RSP: Half-Length Tie Samples with Holes Predrilled for SS Plates, No Fastener System Attached

The RSP bending test was conducted to evaluate the effect of drilling a set of holes into the ties to hold a SS tie plate on the bending strength of the RS area of a half-length tie sample. This series used a total of six tie samples, two from each of the three manufacturers. None of the ties had a specific side identified as the top or bottom of the tie; therefore, TTCI arbitrarily selected the top of the tie for the purpose of installing the fastening system.

One set of three ties used four holes drilled to the specified size (11/16-inch diameter), whereas the second set of three ties used overdriven SSs into undersized (7/16-inch diameter) holes.

Overdriven SSs were used to simulate ties with pre-existing cracks. The intent, based on the test plan, was to create ties that had holes with cracks because of improper installation procedures. To obtain such cracks in a repeatable fashion, 5-inch-deep undersized holes of 7/16 in with a 5/8 × 1-inch deep counter bore were first drilled in a pattern to hold a SS tie plate (four holes); SSs were then force driven into the holes in an attempt to create cracks initiating from and around the hole. The counter bore was needed to allow the SS to start. Such cracks have been noted in field installations of plastic/composite ties when improper (too small) holes were drilled for SSs. Although TTCI evaluated a number of hole patterns and sizes during pretest trials, none

of them produced visible cracking on the tie samples tested. This suggests that other factors may have been encountered at some field installations where such cracks occurred with some regularity.

For purposes of this project, ties intended to be tested with cracks in the hole area are identified as overdriven rather than precracked because no visible cracks were produced.

It was assumed that ties with cracked/overdriven SSs would be most susceptible to increased failure when brittle, thus susceptible to failure at lower temperatures. For this comparison, ties with pre-drilled and overdriven SSs were limited to tie samples tested at -25°F.

Figure 1 shows that the test setup used for these tests was the same but with ties with predrilled holes. Figure 3 shows the test results. As a reminder, these tie samples had no fastening system or plate installed during the tests and contained pilot holes only.

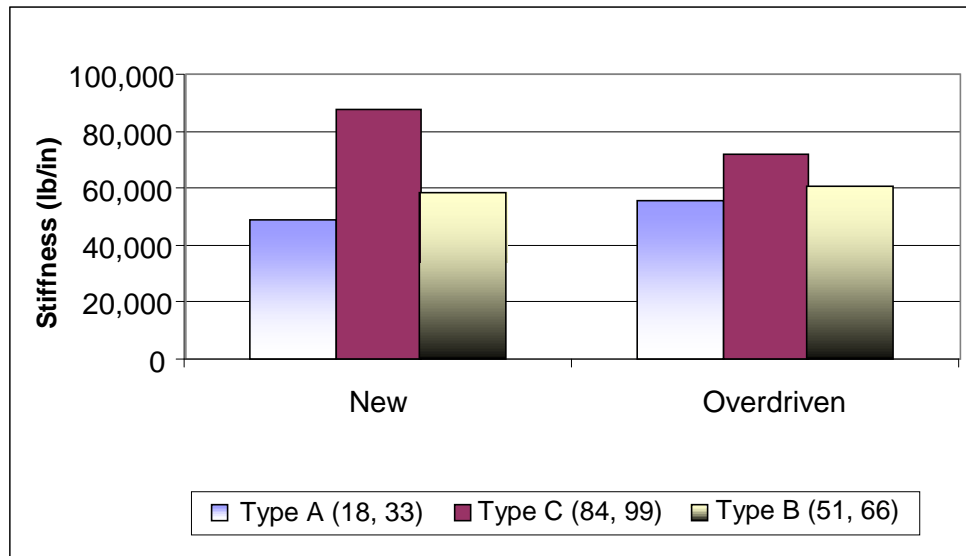

Figure 3. RSP, Holes Only (New) and Holes from Overdriven SSs, -25°F, No Fastener

Figure 3 shows that the addition of holes for SSs had little effect when compared with ties with no holes (Figure 2), as values produced by standard holes (new) were slightly higher than the baseline test results.

Comparing the test results for standard holes and holes created by overdriven SSs shows that, with the exception of the Type C tie, the holes created by overdriven SSs produced about the same or slightly higher stiffness values.

Within expected repeatability, no differences among ties without holes, ties drilled with standard holes, or ties with holes created by overdriven SSs were noted.

7.3 RSP: Half-Length Tie Samples with SS Fastening System Plate Installed

The RSP bending test was conducted to evaluate the effect of a SS fastening system fully attached to the RS area with four SSs on the bending strength of the RS area of a half-length tie

sample. SS holes of proper size were predrilled, and SSs were firmly driven into the ties using pneumatic air drivers.

This series of tests, when compared with the basic results presented in Section 7.1, show the effect of a SS fastening system properly attached to the RS on RSP stiffness. Figure 4 shows the test fixture setup used for this test. Figure 5 shows the test results. For this test sequence, the performance of a standard oak tie with the same SS fastening system attached is shown for reference.

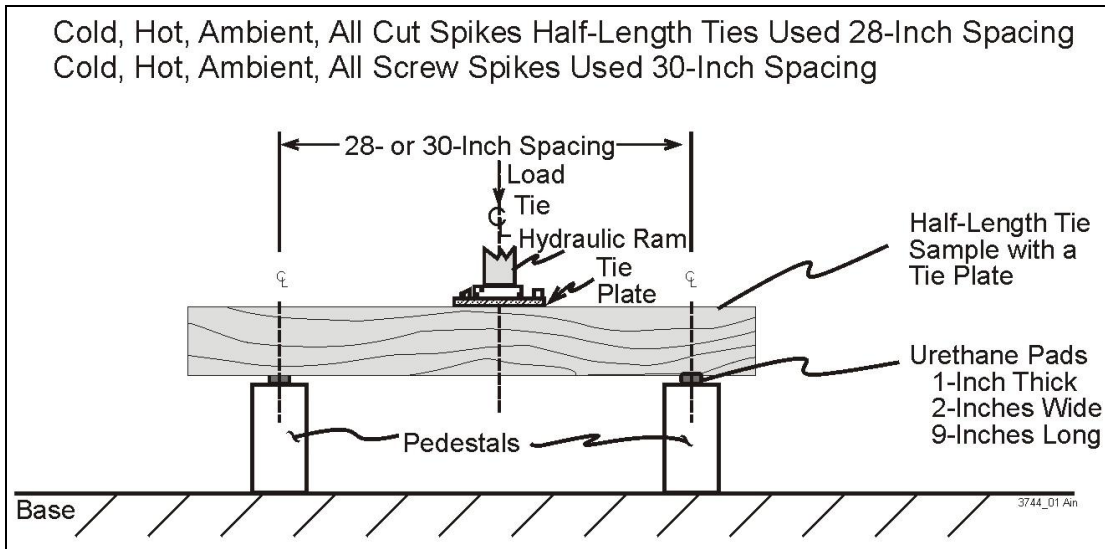

Figure 4. RSP, Half-Length Tie Test Fixture Setup for SSs Tie Plate System Fitted to the RS

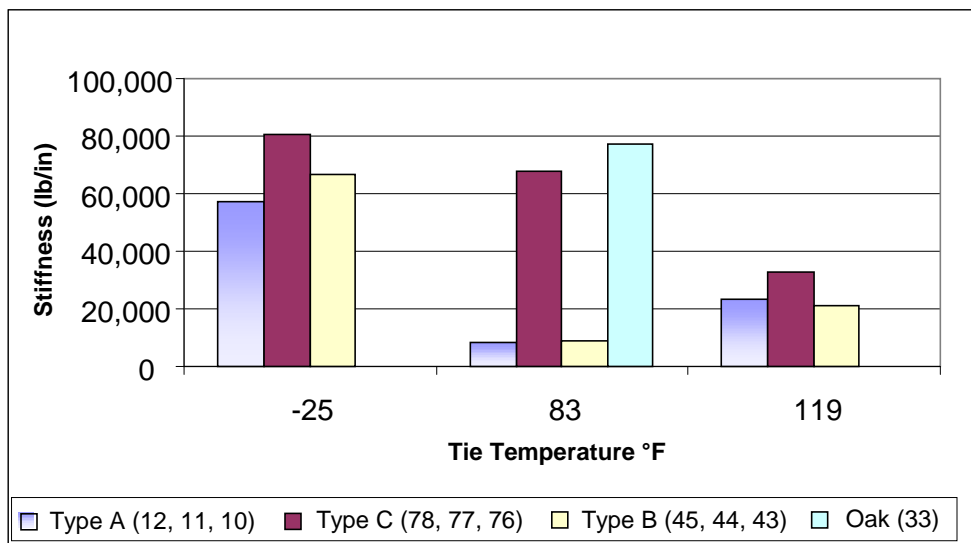

Figure 5. RSP Results from Evaluating a SS System on All New Ties

When compared with the data in Figure 2, results suggest a similar trend between elevated and low temperatures for all ties. Both the Type A and Type B ties exhibited a reduction in stiffness at ambient temperature (compared with elevated temperatures) with the SS fastening system attached. With no fastening system, this trend was noticeable only with the Type C tie.

When overall bending stiffness values are compared, the addition of the SS fastening system increased stiffness, especially in the tests conducted at low temperature. This increase in bending stiffness as a result of the installation of the fastening system was not consistently obtained at other temperature conditions, suggesting the actual force and seating of the tie plate may not have been uniform in all cases.

Overall, the addition of a SS fastening system fully attached to the RS increased the stiffness at -25°F, whereas for other temperatures some tie samples exhibited a reduction in stiffness.

7.4 RSP: Half-Length Tie Samples, with Overdriven SS Fastener System Attached

The RSP bending test was conducted to evaluate the effect of a SS fastening system fully attached to the RS area with four overdriven SSs on the bending strength of the RS area of a half-length tie sample. Undersized holes were predrilled, and SSs were firmly driven into the ties using pneumatic air drivers.

These series of tests, when compared with the results presented in Section 7.3, show the effect of a SS fastening system improperly attached to the RS on RSP bending stiffness.

The test fixture setup used for this test was the same as shown in Figure 4. Figure 6 shows the results obtained in this series of tests.

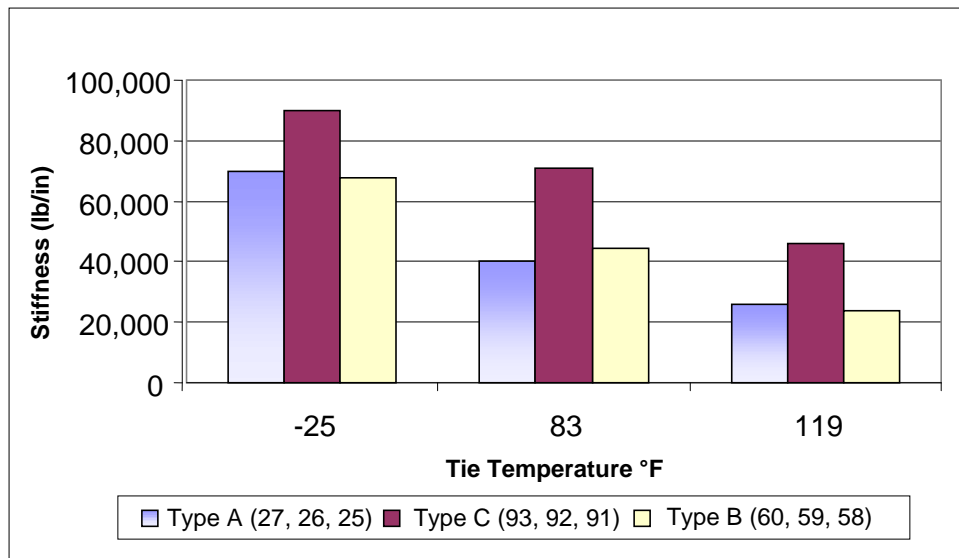

Figure 6. RSP Stiffness Using an Overdriven SS Fastening System Attached

The test results demonstrate that the application of the fastening system using overdriven SSs increased the bending stiffness of the ties in all cases compared with the same setup without

overdriven SSs (Figure 5). The largest increase was noted in the low temperature test, whereas elevated temperature testing indicated the least increase in bending stiffness.

7.5 RSP: Half-Length Tie Samples with CS Fastener System Attached

This RSP bending test was conducted to evaluate the effect of a standard CS/tie plate system. This system was fully attached to the RS area with four CSs driven without predrilling the tie on the bending strength of the RS area of a half-length tie sample. Although some railroads and manufacturers specify that CSs should be driven only in predrilled holes, many field installations are conducted without the benefit of predrilling the ties. For this reason, and to establish a worst-case condition, CS fasteners were evaluated without predrilling the ties.

The test fixture setup used for this test was the same as shown in Figure 5. Figure 7 shows the results obtained in this series of tests.

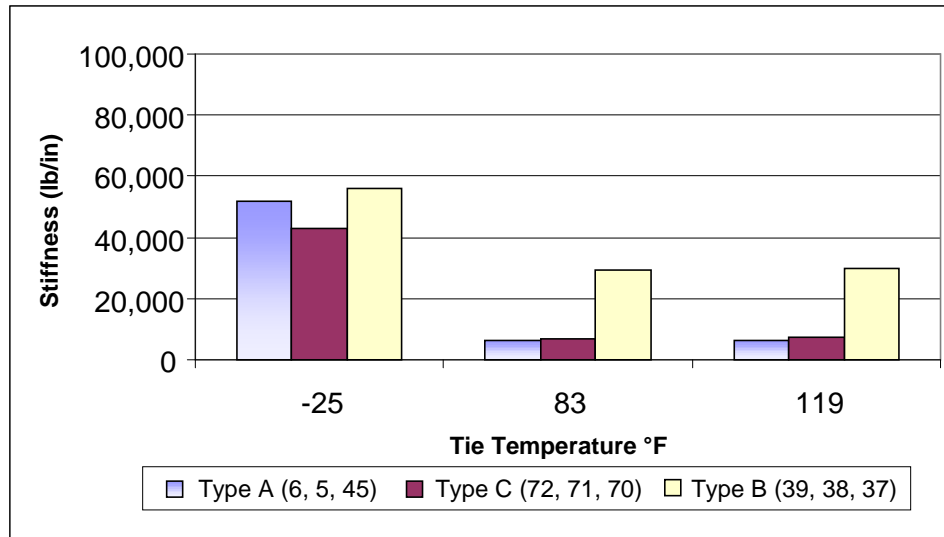

Figure 7. RSP Stiffness Using Standard CSs/Tie Plate System with No Predrilling of Holes on New Ties

The test results demonstrate that the standard CS fastening system does not increase the bending stiffness of the ties to the same degree as the SS fastening system (Figure 5).

Data in Figures 2 and 7 suggests that the addition of a standard CS fastening system has little effect on the bending stiffness of the ties.

7.6 RSN: Half-Length Tie Samples with CS Fastener System Attached

The RSN bending test is similar to that of the RSP bending test; however, the tie and fastening system is inverted in the loading fixture. Load is applied to the bottom of the tie, reversing the bending pattern. Figure 8 shows the load fixture and setup used for all negative bending tests.

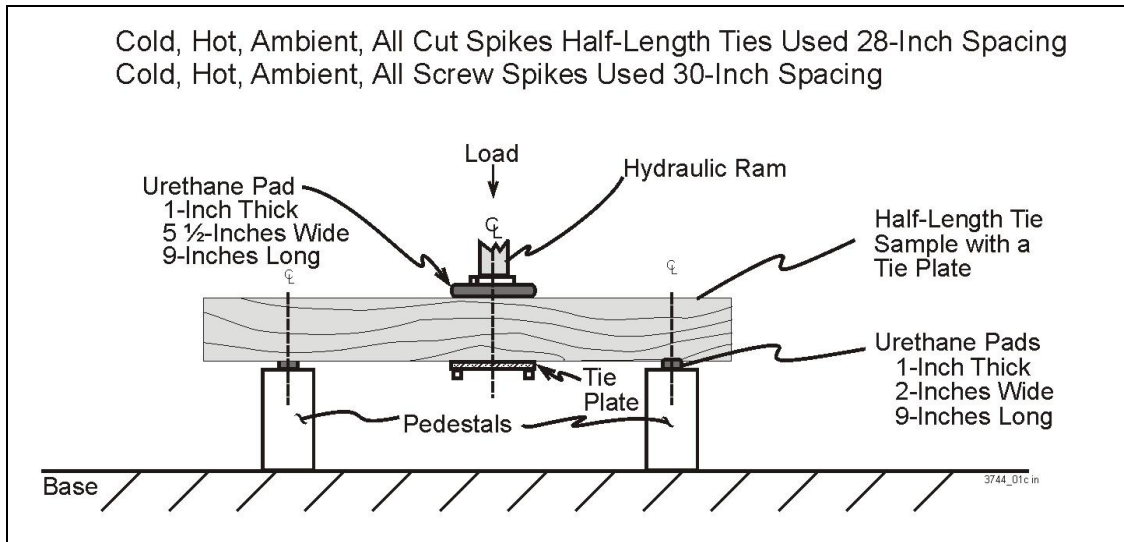

Figure 8. RSN Bending Load Fixture and Setup

The RSN bending test was conducted to determine whether the application of reverse loading with the holes/fastening system attached to the ties leads to premature breakage or reduced stiffness.

Figure 9 shows the results for the ties equipped with a CS fastening system.

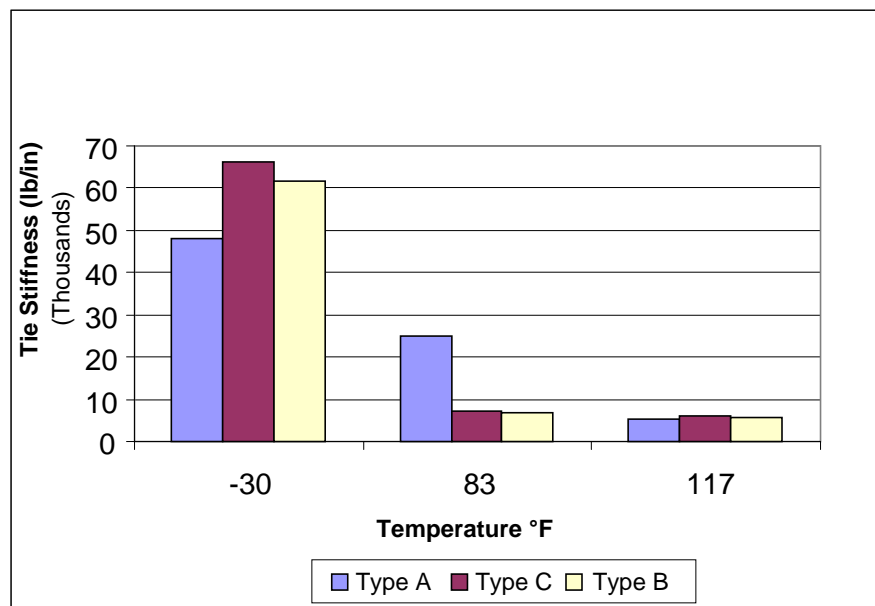

Figure 9. RSN Bending Test Results, All New Ties, CS Fastening System

Results of RSN bending tests, when compared with those obtained in the RSP bending tests (Section 7.5), show mixed effects. At the low temperature, only the Type A tie exhibited any reduced stiffness (slight) under negative bending, whereas at ambient temperature, it was substantially higher. The Type B tie exhibited greater stiffness under positive bending at room and elevated temperatures.

7.7 RSN: Half-Length Tie Samples with SS Fastener System Attached

RSN bending tests were also conducted using a SS fastening system. Two versions of SS attachments were evaluated. The normal application is with SSs firmly driven using standard predrilled holes and SSs overdriven into smaller-than-specified holes. Figures 10 and 11 show data from these tests.

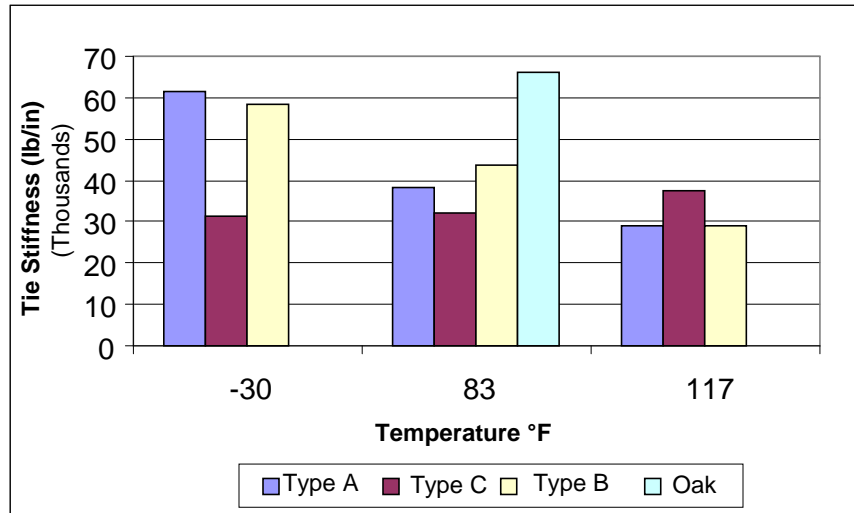

Figure 10. RSN Bending Results, All New Ties, SS Fastening System

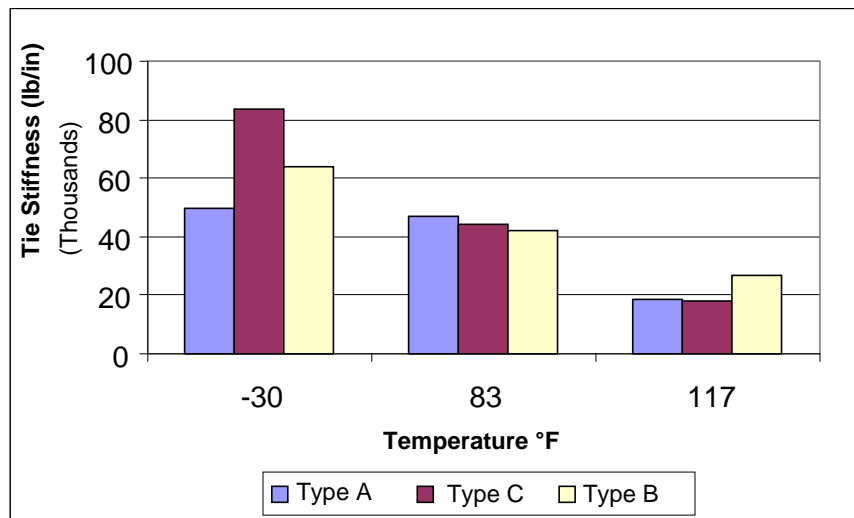

Figure 11. RSN Bending Results, All Ties, Overdriven SS Fastening System

Figure 10 (which also includes oak tie performance), when compared with the positive bending test results (Figure 5), suggests that Type C ties exhibit the same stiffness regardless of temperature under negative bending, whereas the other two tie types have increased stiffness with decreasing temperature as in all other tests.

In most instances, the stiffness of the ties when equipped with a SS fastening system was generally lower in positive bending than negative bending mode.

Overdriving the SSs (Section 7.4) had the effect of reducing stiffness at elevated temperature, less of an influence at ambient temperature, and mixed results at the low temperature.

7.8 RSN Tests by Tie Type

The RSN bending test results varied considerably by tie manufacturer. Figures 12–14 show the test results for each tie separately.

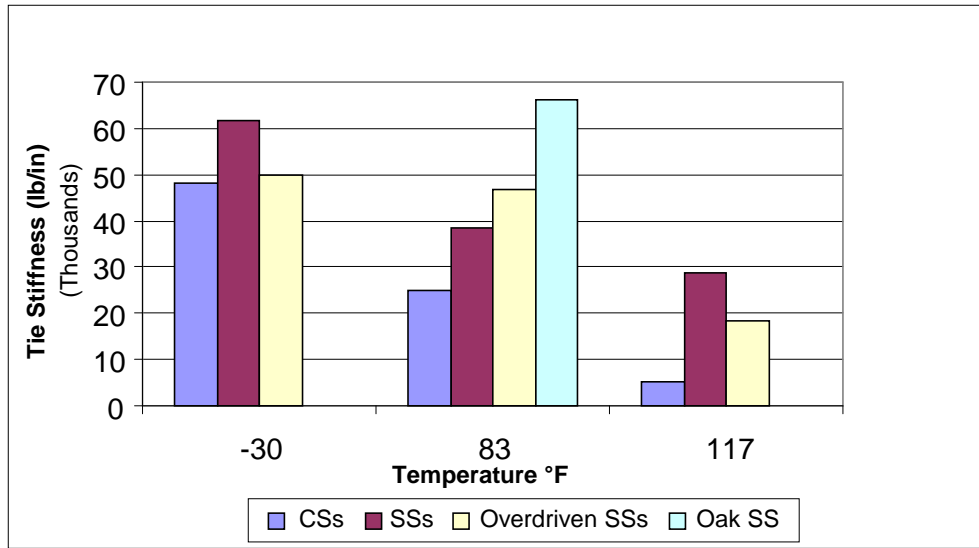

Figure 12. RSN Results, All Fastening Systems, for Type A Only

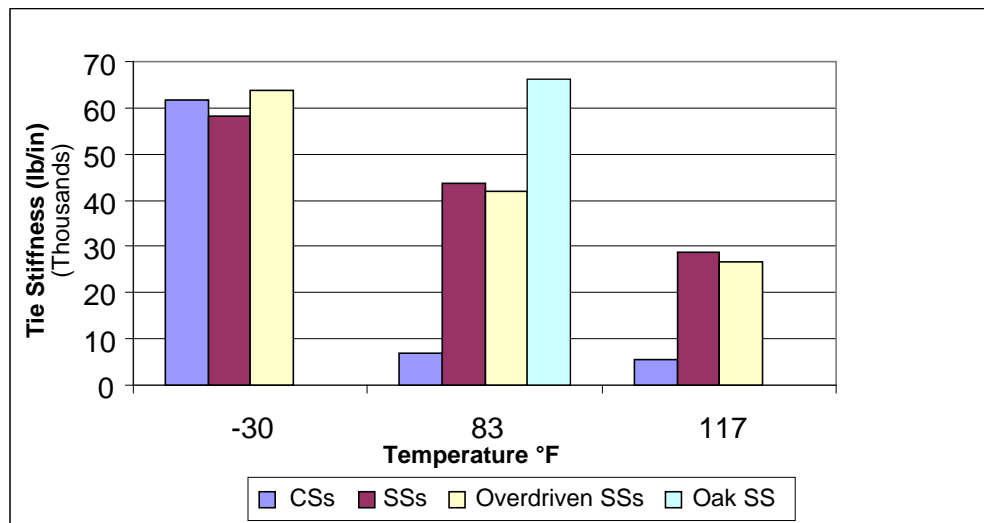

Figure 13. RSN Results, All Fastening Systems, for Type B Only

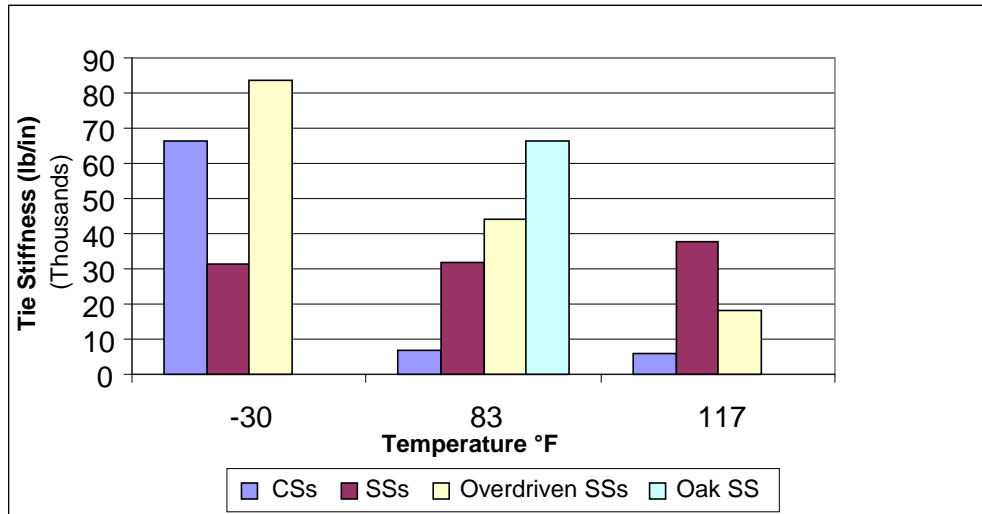

Figure 14. RSN Results, All Fastening Systems, for Type C Only

Figures 12–14 suggest the following:

- All tie types show increased negative bending stiffness with decreased temperatures.
- None of the plastic/composite ties shows as high a stiffness as the oak tie at ambient temperature.
- With one exception, Type B at the low temperature, oak exhibits the highest stiffness for all temperature ranges.
- CSs are generally associated with the lowest stiffness for any given temperature (exceptions are Type C and possibly Type B at the low temperature).
- The influence of overdriven SSs is mixed.

7.9 Impact Tests: RSP, Half-Length Tie Samples

The tie bending tests are quasi-static in nature, with the load applied relatively slowly as it is incrementally increased to the test target value. High-impact wheel loads are occasionally encountered in the operating railroad environment. To simulate the higher than average load experienced under those conditions, impact loading tests were conducted.

Figure 15 shows the loading fixture used to conduct the impact tests. The load was applied using a hydraulic ram, which applied a 50,000-pound impact load for 0.6 seconds.

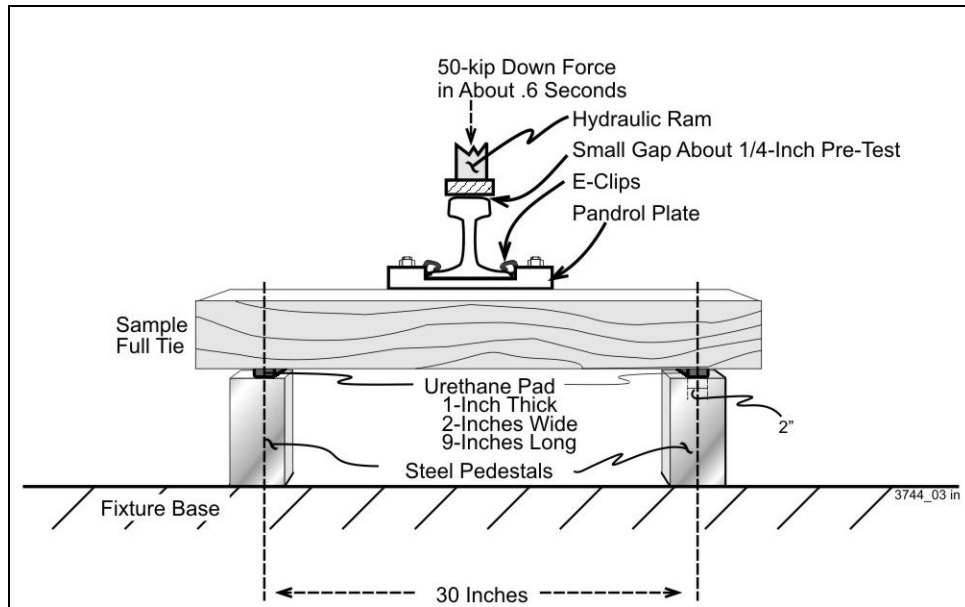

Figure 15. Impact Loading Test Fixture and Configuration

The load applied was based on current and future AAR interchange condemning criteria for high-impact wheels. The current interchange limit of 90,000 lb will gradually be reduced to 78,000 lb. If a typical 110-ton car (286,000-pound gross load) is used, the resulting wheel load is 36,000 lb. Applying a dynamic factor of 2, the resulting impact force on the top running surface of the rail is 72,000 lb.

A worst-case condition was considered when 65 percent of the vertical load applied at the top of rail head is transmitted to the base and tie (with the remaining split to adjacent ties). For the planned condemning limit for high-impact wheels (78,000 lb), this results in an impact load into the tie plate of 50,700 lb, which is likely to be seen only for the most severe high-impact wheels.

One test series was conducted with ties having normal sized holes with and without a SS fastening system installed on the tie. A second series of tests was conducted with undersized holes, again with and without SS fastening systems installed on the tie.

Figures 16 through 24 summarize the test results by tie type and for various fastening system configurations.

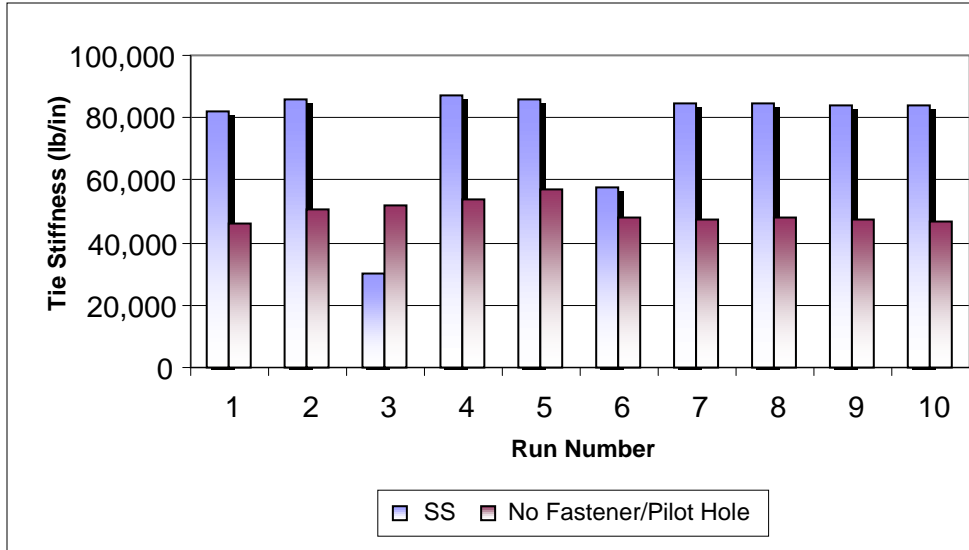

Figure 16. RSP, Type A—Standard SS Plate, Fully Applied with Normal Holes, No Plate, New Ties

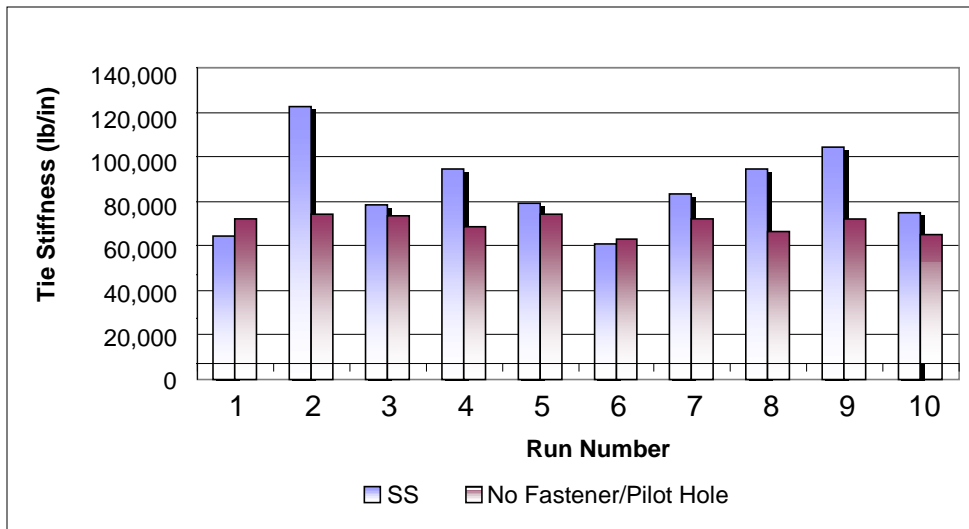

Figure 17. RSP, Type A—SS Plate Overdriven, Fully Applied with Overdriven Holes Only, No Plate

All ties were tested at -25°F. In each case, new half-length tie sections were used for each series of 10 impacts. The tie was positioned in the test fixture; then, 10 repeated impacts of 50,000 lb each were applied while measuring the deflection of the tie. The stiffness value for each impact is shown for run numbers 1 through 10. All ties survived 10 impacts when the SS system was applied, as shown in blue. The no fastener/pilot hole bars represent the 10 impacts when no fastening system was installed on the tie.

The Type A tie survived 10 impacts when both normally installed and overdriven SS systems were firmly bolted to the tie. Figure 18 shows the results for tests conducted with drilled holes only. The Type A tie failed after five impacts with holes produced by overdriving the SSs into smaller-than-specified holes. The average of all impact stiffness values with the fastening system attached to the tie was higher than the average value obtained with no fastening system attached to the tie, and the average stiffness with fastening systems having overdriven SSs was less than that with normally applied fastening systems.

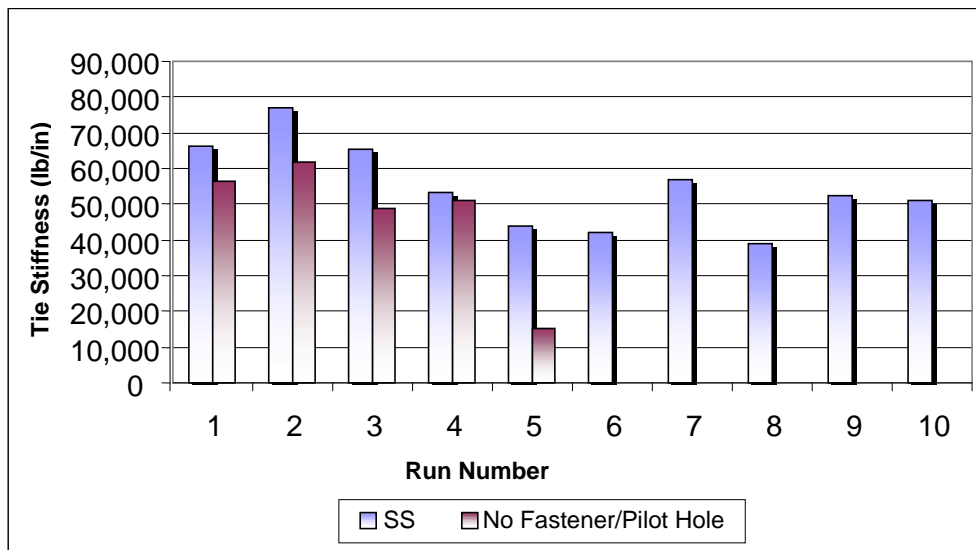

Figure 18. RSP, Impact Type A—Overdriven, Standard SS Plate Fully Applied and with Normal Holes, No Plate

Type C ties survived 10 impacts under all configurations tested, with and without plates and with normal and overdriven SSs holes. The average stiffness measured without plates was less than when a plate was fastened, and little difference existed in stiffness between overdriven and normal-driven conditions. Figure 19 shows tests conducted with RSP impact for the Type C tie overdriven SS plate.

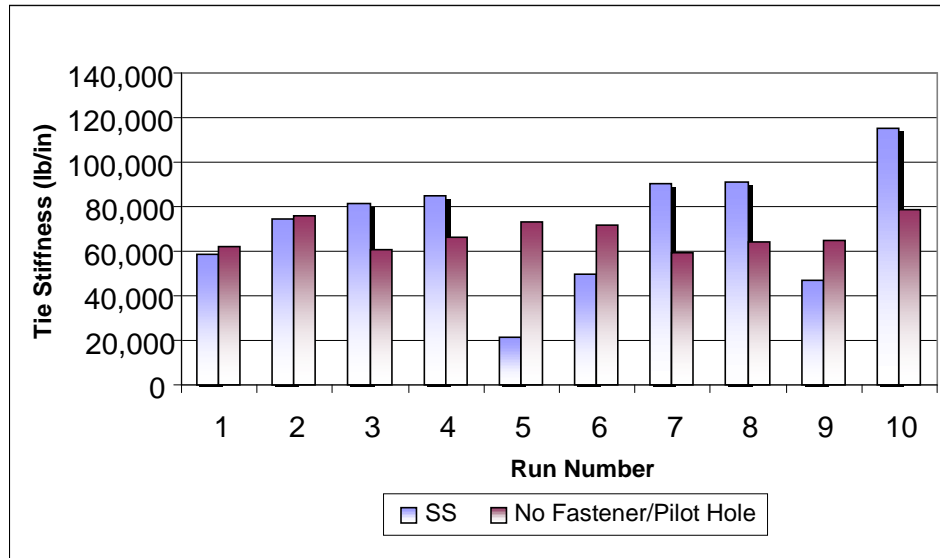

Figure 19. RSP, Impact Type C—SS Fastening System Fully Applied with Overdriven Holes Only, No Tie Plate

Results from the Type B tie indicate that the ties failed after one impact when no fastening system was attached to the tie, with normally formed predrilled holes, and with holes formed by overdriving the SSs into smaller-than-specified holes. The average impact stiffness for overdriven fasteners was less than that with normally driven; however, 1 of the 10 tests indicated a much higher stiffness than the others. Figures 20 and 21 show RSP impact test results for the Type B ties with overdriven holes only, no plate.

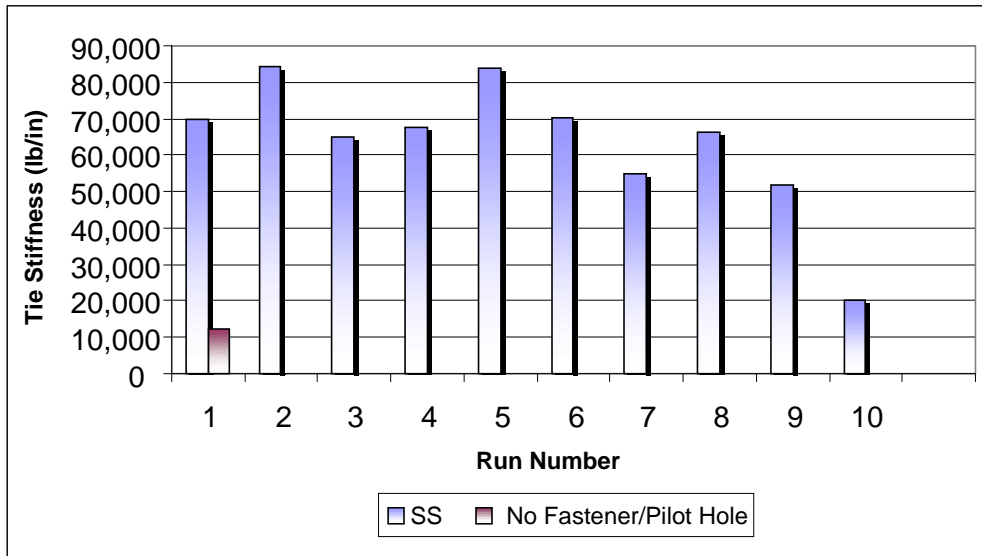

Figure 20. RSP, New Type B—Standard SS Plate Fully Applied with Normal Holes, No Plate

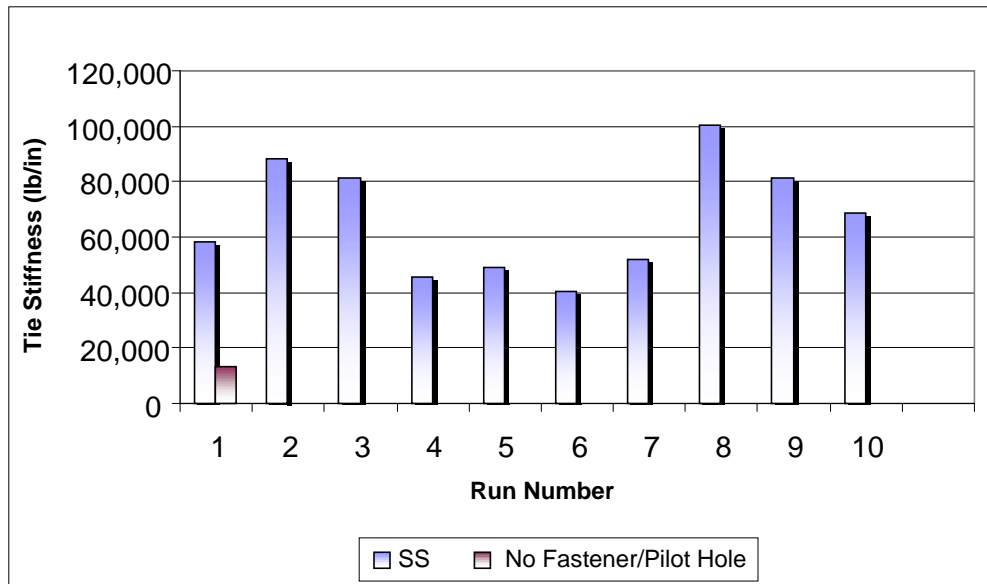

Figure 21. RSP, Type B—SS Plate Overdriven Fully Applied with Overdriven Holes Only, No Plate

7.10 Overall Impact Testing Results

Impact test results indicate that no ties failed when the fastening system was firmly attached to the ties, but two of the three tie types failed before 10 impacts when no fastening system was attached.

This suggests that ties in the field with loose or worn fastening systems may become more susceptible to fracture from exposure to impact loads.

7.11 Full-Length Tie Center Bending—MOE

For this test series, full-length tie samples were supported, as Figure 22 shows, and tested with no fastening systems or predrilled holes.

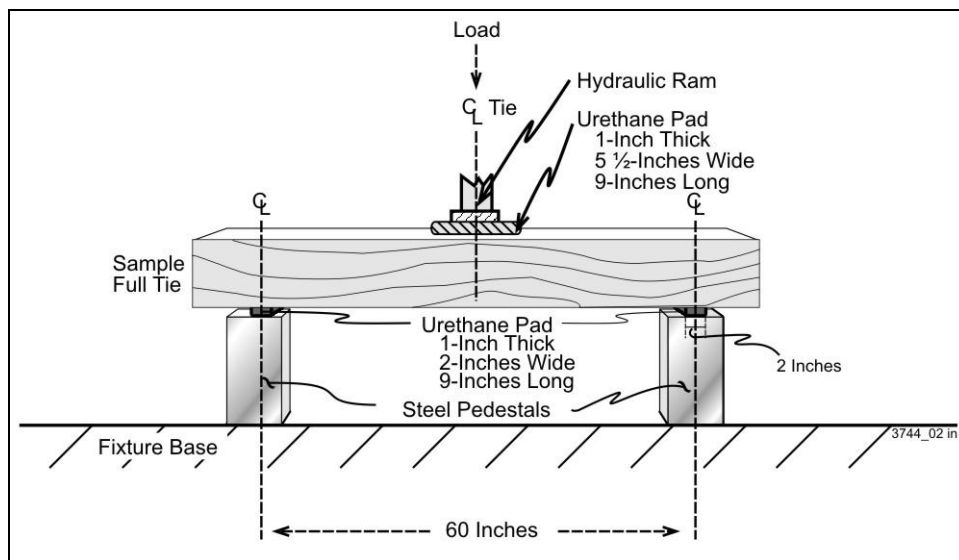

Figure 22. Tie Test Center Bending Load Fixture Setup

Ties were loaded to produce 1-inch center deflection per minute until a center deflection of 2.5 in was obtained. The load was then held for 30 min, after which, the tie was unloaded. The center deflection was then measured, the tie was stored for 24 hours (in the case of cold ties, the ties were stored in the cold room), and the center deflection was remeasured. Table 1 summarizes the data from the center bending tests.

Table 1. Summary of Load/Deflection Results—Center Bending

Pass/ Fail			Loading		Deflection						Temperature			
			Pre-	Post-	Delta						Core		Skin	
Pass	Run No.	Tie Type				Min.	Max.	Delta	Post-	After 24-Hours	Pre-	Post-	Pre-	Post-
Fail	21	New Type A	-15	25449	25464	3.422	5.202	1.78	178	Failed	-31	-31	19	24
Pass	20	New Type A	17	18520	18503	0.226	2.814	2.588	2.121	1.693	72			
Pass	19	New Type A	-10	12485	12495	0		2.5	2.535	2.185	117			
Fail	54	New Type B	-20	24846	24866	3.085	4.418	1.333	1.78	Failed	-25	-28	13	17
Fail	53	New Type B	-0.005	13.684	13.689	0.07	2.009	1.939		Failed	80			
Pass	52	New Type B	2	11203	11201	0.024	2.608	2.584	2.69	2.252	121			
Fail	87	New Type C	-27	42404	42431	3.539	4.886	1.347	1.347	Failed	-28	-30	20	24
Fail	86	New Type C	-10	26362	26372	0.437	1.922	1.485		Failed	79			
Fail	85	New Type C	-20	18608	18628	0.38	2.411	2.031		Failed	122			

Table 1 shows that most ties failed (fractured) before a 2.5-inch center deflection could be obtained.

7.12 Full-Length Tie Center Bending—MOR

The test setup used to conduct the full-length tie center bending test to determine MOR was similar to that of MOE, with the exception of the loading that was applied at a rate to produce a 1-inch center deflection per minute to a maximum of 5 in or failure (tie rupture). These tests were also conducted with no fastening system or predrilled holes in any tie. Table 2 shows the results obtained in this series of tests.

Table 2. MOR Test Results

Pass/Fail			Loading			Deflection			Temperature			
	Run No.	Tie Type	Min.	Max.	Delta	Min.	Max.	Delta	Core	Skin		
Pass	24	New Type A	-47	22534	22581	3.463	5.008	1.545	-32	-29	13	23
Fail	23	New Type A	-18	18732	18750	0.285	3.72	3.435	81			
Pass	22	New Type A	-13	16281	16294	0.274	5.348	5.074	121			
Pass	57	New Type B	-27	19279	19306	2.157	3.214	1.057	-29	-30	27	18
Pass	56	New Type B	-13	14379	14392	0.121	2.412	2.291	80			
Fail	55	New Type B	-15	10534	10549	0.087	3.028	2.941	121			
Pass	90	New Type C	-44	42329	42373	3.657	5.272	1.615	-29	-31	13	-23
Fail	89	New Type C	-13	24057	24070	0.364	2.147	1.783	79			
Fail	88	New Type C	-13	21308	21321	0.484	3.933	3.449	120			

Only the Type A tie, when tested at 121°F, did not fail before a 5-inch center deflection was reached. Most ties failed before reaching a 3-inch center deflection. Ties tested at the low temperature failed well before a 2-inch center deflection was reached, which was similar to that achieved in the previous MOE tests.

With the formula suggested by AREMA Committee 30 for bending stress, the stress (S) at fracture (rupture) was computed using $S = 0.204 P$, where P is the load in pounds. Table 3 shows summarized MOR test results.

Table 3. MOR Summarized Results

Test Run	Tie Type	Temperature °F	MOR (psi)
24	Type A	-32	4,607
23	Type A	81	3,825
22	Type A	121	**
57	Type B	-29	3,938
56	Type B	80	2,936
55	Type B	121	2,152
90	Type C	129	8,644
89	Type C	79	4,910
88	Type C	120	4,350

*** Note: Type A tie at the elevated temperature did not fracture. Testing stopped at 5.074 inches of center deflection with a load at 16,294 lb.*

8. Addendum to Test Matrix

After assessing results from over 130 tests (all of which were single tests on individual tie samples), reviewers raised a concern regarding variability within materials and statistical significance of the data. To stay within the budget limitation of the statement of work, which directed the test plan, only the numbers of tests called for in the statement of work were conducted. This resulted in one tie sample per test for each variation of temperature and tie plate/fastening system. These results, from 130 variations, have been evaluated and reported as per the deliverable requirements.

During the tie acquisition process, extra tie samples were obtained as a contingency in case of damage during testing; thus, an opportunity to conduct additional testing on the remaining tie sample existed. A critical review of test results indicated some variations that did not follow expected trends. From this list of questionable results and the inventory of available half-length tie samples, a matrix for testing remaining tie samples within the remaining budget was prepared. To conduct the additional tests, approval was received to address the questionable results and to improve overall statistical soundness of some key data.

Specifically, additional tests were conducted to:

- Determine variability in RS bending for several nearly identical tie samples from the same manufacturer or two half-lengths of the same tie.
- Determine variability of repeated tests on the same tie sample.
- Confirm the influence, if any, of CS tie plates in their ability to increase bending stiffness.
- Confirm the influence, if any, of SS tie plates to increase bending stiffness.

8.1 Overview of Additional Testing for Repeatability

Average bending stiffness of multiple tie samples was determined using the remaining tie samples as follows:

- Tie-only (half-length tie, no holes or fasteners) tie samples from all three manufacturers were evaluated to determine RS stiffness. These RS stiffness tests were performed on new ties and are shown as RS/New.
- After RS stiffness testing, these same tie samples had tie plates attached with CSs and RSP bending tests conducted. Figures 23 and 24 show the data plots as RSP/Used/CS.
- Sufficient, new (untested) ties from Type C were available for RSP testing and were prepared with tie plates attached with CSs. Figures 23 and 24 show these results as RSP/New/CS.
- Sufficient, new (untested) ties from Type B were available for RSP testing and were prepared with SSs and tie plates. Figures 23 and 24 show these results as RSP/New/SS.

Figure 23 shows the results of RS bending. Figure 24 shows the corresponding standard deviation for these results.

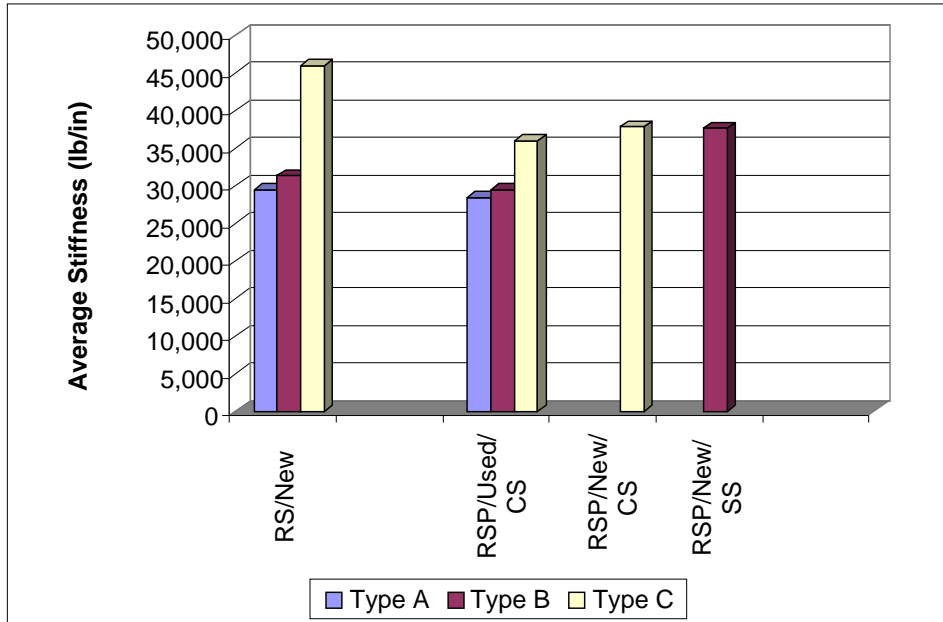

Figure 23. RS Bending Test Results, Average Stiffness for All Tests Conducted May 2007

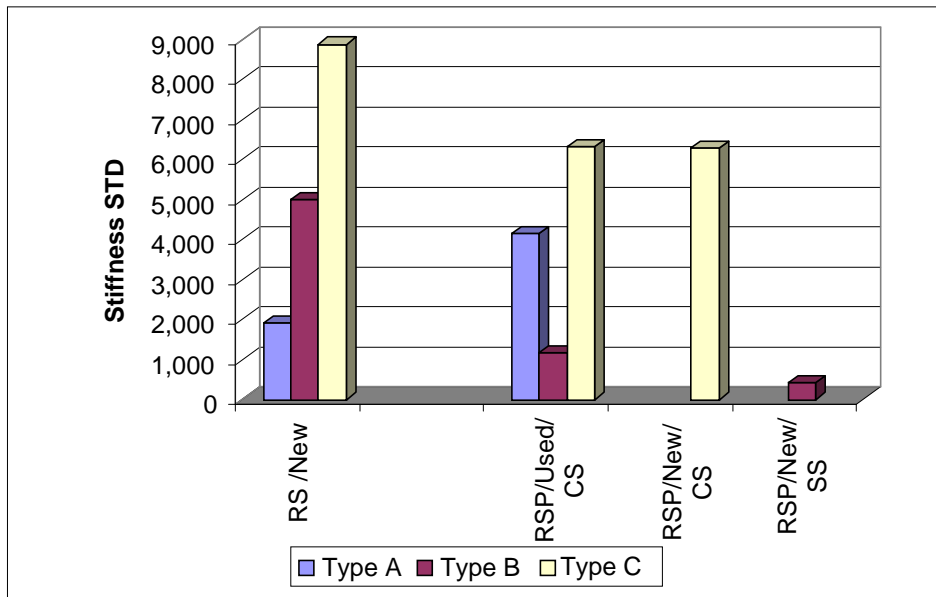

Figure 24. Standard Deviation of Bending Test Results Shown in Figure 23

Results of RS area bending tests performed on ties with and without fastening systems (Figure 23) suggest the following:

- *CS Fasteners:* Results show that the addition of tie plates with CSs resulted in a very slight reduction of measured stiffness (approximately 10 percent) for Type A and Type B ties. The same stiffness tests conducted on the Type C material show that the addition of tie plates with CSs on used and new ties resulted in a significant lower stiffness compared with a bare tie (approximately a 22-percent reduction).

Therefore, although conventional wisdom suggests the addition of a tie plate should stiffen the RS area, results of these multiple tests suggest that this was not the case. For the ties evaluated, the addition of tie plates with cuts spikes actually lowered the measured stiffness.

- *SS Fasteners:* Results conducted on the Type B ties, where sufficient tie samples were available to conduct multiple tests, show an increase in stiffness compared to bare ties (approximately a 19-percent increased stiffness). In addition, ties with SSs produced higher stiffness than ties with CSs from that same manufacturer (approximately a 40-percent increase).
- *Variability:* The standard deviation (Figure 24) for the Type A and Type B test results was relatively low compared with the results for Type C ties, which exhibited a much higher variation. This suggests a higher variation in material properties from tie to tie with Type C ties. The number of repeated runs for each test configuration was still relatively low (approximately five) because of the limited tie samples available. Results suggest that more testing of multiple tie samples from a range of ties in each batch is needed to ensure that viable values are being obtained.

8.2 Results Separated by Tie Manufacturer

Figures 25, 26, and 27 show the results by manufacturer (Type A, Type B, and Type C, respectively).

8.2.1 Type A Tie Samples Results

Figure 25, results for Type A, includes the following notes:

- The first entry pair, shown as 06 and marked as tie samples 2 and 5, is the result from the original matrix (conducted December 2006). The second entry pair marked 07 is the result from testing conducted in May 2007 on the same tie samples tested in December 2006.
- All other entries (P1-A and P1-B through P3-B/4) were tested in May 2007.
 - P1, P2, P3, and P4 indicate a number of full-length ties for inventory control.
 - P1-A and P1-B indicate the two half-length tie samples from the same tie (P1). The same marking procedure holds for P2-A, P2-B, P3-A, and P3-B.
 - Four example tests on tie samples P3-B are as follows: first, P3-B1; second, P3-B2; third, P3-B3; and fourth, P3-B4.

- Tie sample P1-B shows no data for a test conducted for RSP/Used/CS. This tie sample was tested first new for RS, but during the spiking operation in preparation for RSP testing, however, the tie fractured. No RSP was performed.

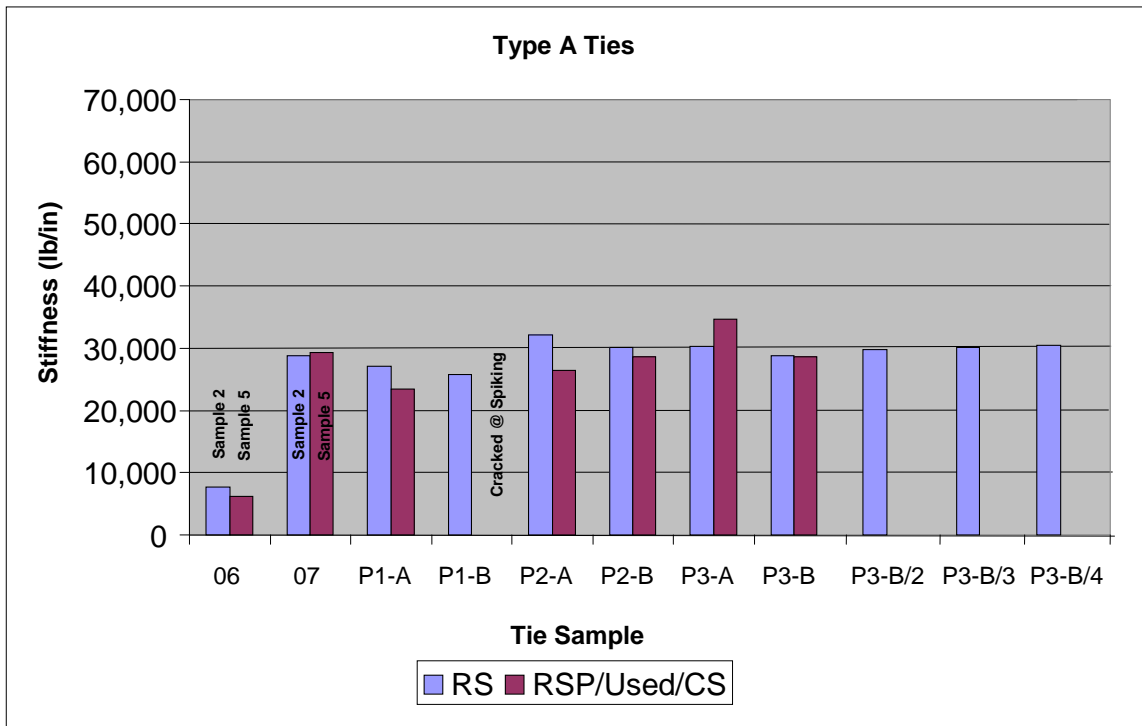

Figure 25. Results from Single and Multiple Tests Conducted on Type A Tie Samples

Results for the Type A tie samples indicate and suggest the following:

- Tie samples 2 and 5 exhibited very large (250 percent) increases in stiffness from the December 2006 to May 2007 tests. It is not certain at this time if aging (from outside storage of this tie sample), any potential differences in test setup, or differences in the temperature between December 2006 and May 2007 tests could explain this large discrepancy between results.
- Four multiple repeated tests conducted at the same time (P3-B to P3-B/4) produced virtually identical results. No degradation or change in stiffness was noted over four repeated tests.
- This suggests that the test results are repeatable within a given tie sample.
- The May 2007 test results suggest little variation between the different ties tested.
- The addition of CSs had little effect on stiffness when compared with a bare tie.
- Tie sample P1-B was the only tie sample that cracked during spiking operations for testing conducted in December 2006 and May 2007.

8.2.2 Type B Tie Samples Results

Figure 26, results for Type B, includes the following notes:

- The first entry pair, shown as 06 and marked as tie samples 35 and 38, are the results from the original matrix (conducted December 2006); the second entry pair marked 07 are the results from testing conducted in May 2007 on the same tie samples tested in December 2006.
- All other tie sample entries (T1-A to T5-A) were tested in May 2007.
- Tie samples marked T1-A and T1-B are two half-length tie segments from the same full-length tie (tie sample T1). The full-length ties T2, T3, and T4, where A and B are from the same tie, are also tie segments from the same full-length tie.
 - The half-length tie samples T1-A to T3-B were first tested bare; a CS was then applied and tested.
 - Three half-length tie samples T4 and T5 from new full-length ties were tested only with SSd plates.
- Entries T3-A, T3-A/2, and T3-A/3 were repeated RS tests on the same tie sample.
- No data are shown for tie sample T2-A. Tie sample T2-A fractured during RS tests at approximately 18,500-pound load and 0.8-inch deflection.
- The figure does not show a tie sample that fractured during the preparation process during spiking while it was being prepared for an RSP/New/CS test. This tie sample was being prepared to compare with used tie CS tests.

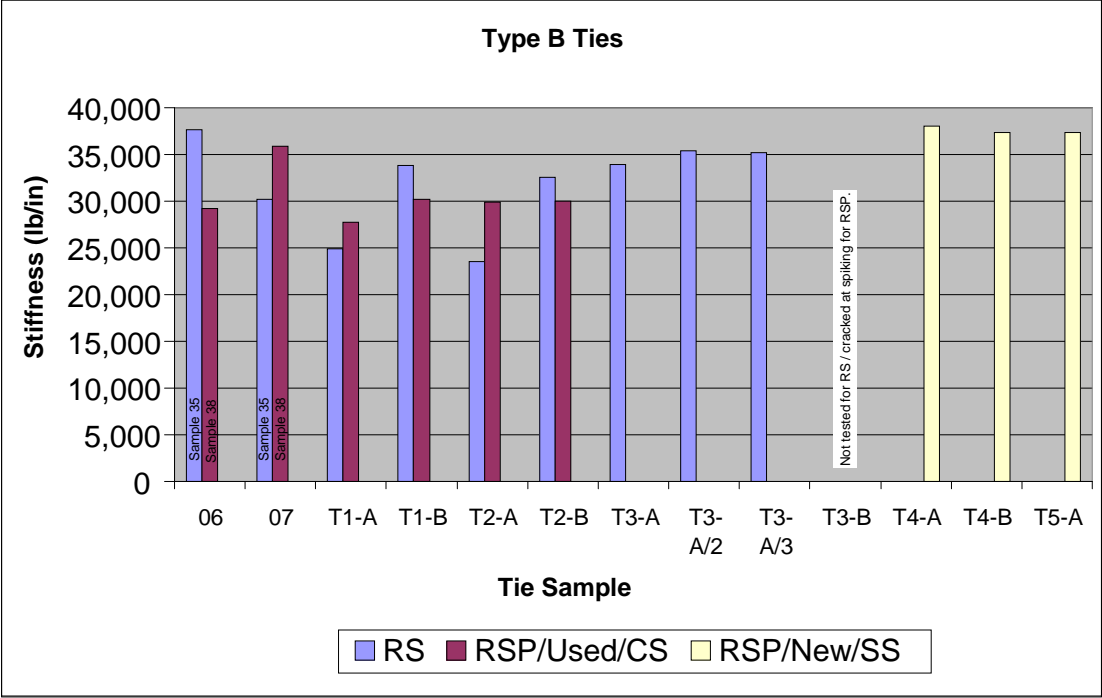

Figure 26. Results from Single and Multiple Tests Conducted on Type B Tie Samples

Results for the Type B tie samples indicate and suggest the following:

- Potential differences in test setup or differences in ambient temperature between testing in December 2006 may have influenced the change in stiffness for the same tie sample tested in May 2007.
 - Bare tie sample 35 exhibited a stiffness decrease of 20 percent between results from December 2006 to May 2007.
 - The tie sample with a CSd plate (tie sample 38) exhibited an increase in stiffness of approximately 25 percent between results from December 2006 to May 2007.
- Three multiple, repeated tests conducted at the same time (tie sample T3-A to T-3A/3) produced virtually identical results. No degradation or change in stiffness was noted on the same tie sample for three repeated tests.
- The addition of tie plates held by CSs reduced the stiffness by a small amount in three of the four tie samples tested.
- The addition of tie plates held by SSs generally increased stiffness by a small amount over that of bare ties (tie samples T4-A to T5-A).
- The tie sample that failed during RS testing (tie sample T2-A) had a lower measured stiffness value (23,125 lb/in)) at the point of failure than the average value for the other ties tested that did not break.

8.2.3 Type C Tie Samples Results

Figure 27, results for Type C, include the following notes:

- The first entry pair, shown as 06 and marked as tie samples 68 and 71, is the result from the original matrix (conducted December 2006). The second entry pair marked 07 is the result from testing conducted in May 2007 on the same tie samples tested in December 2006.
- All other tie sample entries (U1-A to U6-A) were tested in May 2007.
- Tie samples marked U1-A, U1-B, U2-A, U2-B to U6-A, and U6-B were the two half-length tie segments from the same full-length tie. Two test tie samples were obtained from each of the six following full-length ties: U1, U2, U3, U4, U5, and U6.
 - One of each of the six new half-length tie samples was RS tested—no plates (RS results marked as Ux-A).
 - From this group, five of the six ties then had a tie plate with CSs applied and retested for RSP bending (RSP/Used/CS results marked as Ux-A).
 - Five of the remaining six untested half-length tie samples had a tie plate with CSs applied and tested for RSP bending (RSP/New/CS marked as Ux-B).
 - For each full-length tie, two identical half-length tie samples were generated. An RS test was performed on one half-length tie sample from each tie. After the test's completion, a tie plate with CSs was installed on each one of these tie samples, and a

RSP bending test was performed. The other untested half-length tie sample of this group of ties was only tested after the installation of the tie plate with CSs.

- RS testing was repeated three times on tie sample U6-A. Repetitions are noted as U6-A, U6-A/2, and U6-A/3.

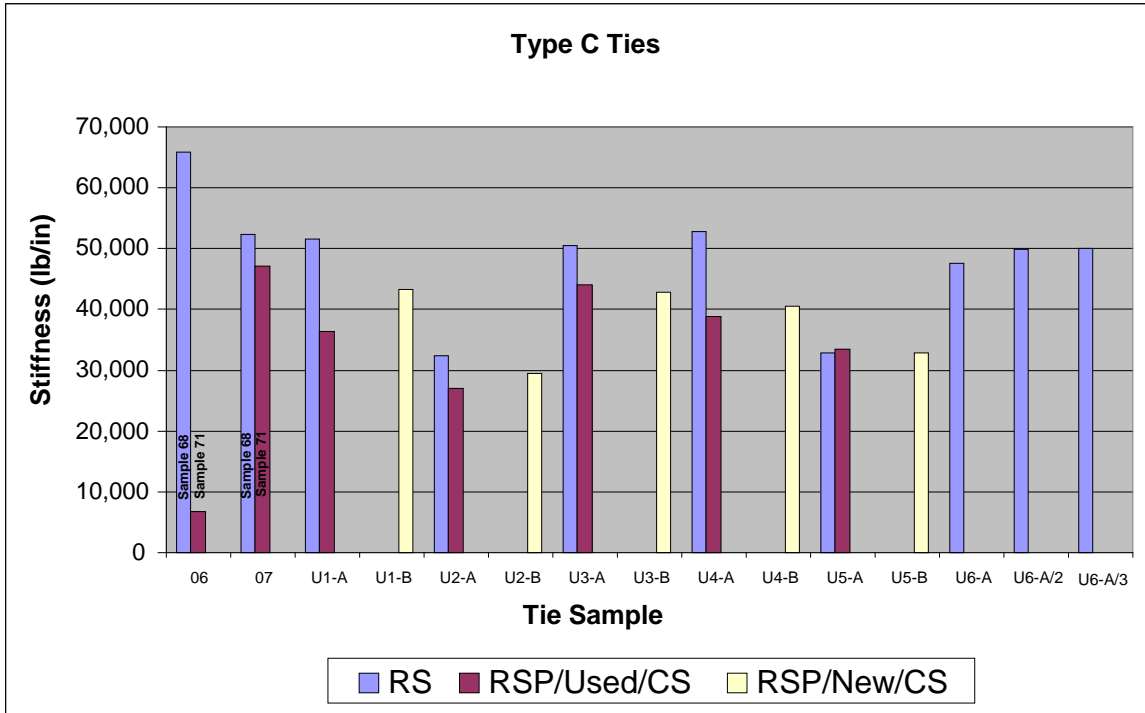

Figure 27. Results from Single and Multiple Tests Conducted on Type C Tie Samples

Results for the Type C tie samples indicate and suggest the following:

- Potential differences in test setup or differences in ambient temperature between December 2006 and May 2007 tests may have influenced the change in stiffness for the same tie sample tested in December 2006 and May 2007. The large increase in results with the tie plate attached (tie sample 71) may be an anomaly from the December 2006 tests.
 - Tie sample 68 (RS) exhibited a 21-percent decrease in stiffness.
 - Tie sample 71 (used tie sample with tie plate/CS) exhibited a 660-percent increase.
- Repeated RS on the half-length tie samples of U6 produced similar results between measurements.
- Other RS (tie only) results between different half-length tie samples exhibited a wide range of values (32,000–52,000 lb/in). Two of the six half-length tie samples produced significantly lower stiffness values than the others.
- The addition of tie plates held by CSs generally reduced the stiffness on four of the five ties tested, with the exception of tie sample U5-A, which indicated no change.

- The addition of plates held with CSs on new, previously untested ties, when compared with the bare tie tests from the other half-length of the same tie, generally reduced stiffness with one exception—tie sample U5-B, which indicated no change. The trend of higher or lower stiffness, when compared with each pair of half-length tie samples, was generally the same for both halves of the same tie. This suggests that individual tie stiffness varied considerably from tie to tie but was uniform within a tie.

8.3 Summary of Observations: Effects from Tie Aging and Retesting after Outside Storage

All tie samples tested in December 2006 were subsequently stored outside. The retesting of limited tie samples, for the most part, did not exhibit the same stiffness as the original tests. The six tie samples selected for repeated evaluations results show the following:

- Three ties exhibited a significant increase in stiffness during the second test type.
- One tie exhibited a slight increase in stiffness during the second test type.
- Two ties exhibited a slight decrease in stiffness during the second test type.

Reasons for such variations may include:

- Change in tie performance because of weathering from outside storage.
- Variable test fixture setup and conduct—although the same equipment, process, and operator was used for the tests performed in December 2006 and May 2007.
- Variation in internal temperature of ties stored before the test.
- Seating or other changes in fastener system hold-down performance.

Field data from FAST and revenue service is generally from monitoring gage widening performance and not RS bending. To date, although plastic ties being monitored in track have exhibited some change in gage restraint with time, these changes do not approach the differences in RS bending noted in the laboratory tests repeated between December 2006 and May 2007. Most plastic tie failures are related to cracking and breakage after some time in track; thus, RS bending tests over time may be a means of assessing such changes in strength.

8.4 Testing Procedures

Multiple consecutive tests on the same tie sample usually produced nearly identical results. With the exception of one manufacturer, bare tie RS stiffness tests produced similar results for all runs. This suggests that the test procedure was reasonably repeatable.

8.5 Tie Samples Required to Obtain Statistically Sound Average

One manufacturer's ties exhibited a higher range of results than the two others. This suggests that production variations produced a wider range of tie stiffness for this batch of ties. For ties exhibiting low standard deviation, the testing of five ties appears to provide a sufficiently low variability needed to determine average strength, whereas those that show a large standard deviation after testing five tie samples will require additional samples to be obtained and tested. The number of ties will depend on expected production variability, source material control, and variations from storage.

Ties with tie plates/CSs exhibited more variation between tests than bare tie or ties with SSs/plates.

9. Discussion of Results and Recommendations

The following experiment design limitations must be taken into consideration when assessing the results obtained in this test program:

- Data were based on one tie sample and one test per variable—this limitation was recognized from the beginning. Budget constraints did not enable test design that would give a high degree of confidence. The experimental test matrix was developed to show trends with the results suggesting future experimental focus.
- Fastener systems were manually installed.
- Variability between fastener plates was not accounted for in the experiment design.
- Variability between CSs was not accounted for in the experiment design.

The following observations can be made based on the test results:

- The tests performed at low temperatures produced the most consistent results.
- For the tie seat bending tests, low temperatures produced the highest tie stiffness values.
- For the tie seat bending tests, elevated temperatures produced the lowest tie stiffness values.
- For the tie impact tests, low temperatures produced the most tie failures.
- For the modulus tests, low temperatures produced the most tie failures.

For the most part, the above results are consistent with prior expectations.

9.1 Items to Consider for Further Testing

- Data and results should be shared with AREMA Committee 30 for use in upgrading laboratory screening tests of plastic/composite ties.
- The research team should determine which laboratory tests are most likely to identify poor performing ties. A comparison of known field failures or inadequate performance with laboratory results should be conducted to determine whether a correlation with early failure of a tie and laboratory test results exists.
- The experiment design needs to incorporate repeatability and reproducibility.

Other areas to investigate to improve the statistical robustness of results include the following:

- Experiment design should be modified to include testing more than one tie sample per test variable to generate statistically valid test results.
- Tie samples that produce unexpected test results should be further evaluated to determine the cause of the unexpected behavior. This could include conducting nondestructive and destructive testing to better characterize the tie.

- Repeat tests with existing tie samples should be conducted while mixing previously assigned temperatures (e.g., if tie sample previously was tested at the low temperature). The tests should also be repeated using the elevated temperature to document variation in tie bending stiffness and impact resistance as a result of changes in tie temperature.
- Researchers should obtain additional tie samples and repeat tests using the revised experiment design to produce statistically valid results.

9.2 Recommendations for Future Testing

The major objective of the added tests was to use remaining tie samples to investigate statistical repeatability/variability in the results reported from the evaluation of 130 single tie samples. Results show that variability is dependent on several sources:

- Some manufacturers' products exhibited higher variation than others.
- Weathering, storing, or aging appeared to alter stiffness of some ties.
- At least five test tie samples are needed to ensure that a viable average is obtained.

Additional testing is needed to address the potential influence of weathering and tonnage on bending strength. Changes due to aging can come from exposure to weathering or storage, as well as combined weathering and in-track loads. This will require for selected tie samples to be removed from track (after exposure to tonnage) and from tie samples stored outside. Results must be compared with baseline data from the same batch of ties tested before installation. A matrix of tests covering ties to be measured before installation and after specified intervals of tonnage and weathering cycles would need to be developed.

As several tie samples from each manufacturer were tested multiple times during May 2007, which generally indicated much lower variation than in comparing the December 2006 to May 2007 tests, it is suggested that future evaluations consider the following:

- Conduct each bending test several times to ensure that data results are repeatable.
- Conduct tests from several tie samples from the same batch.
- Consider testing without fastening systems to evaluate material and manufacturing consistency.

It is suggested that additional RS (bare tie) tests should be repeated with a larger number of tie samples from a variety of manufacturers to obtain a better value for nominal stiffness and standard deviation. This information will be useful in determining a minimum number of tie samples needed to benchmark new designs and material makeup, as well as establishing minimum and maximum recommended values.

Appendix A. Test Matrix and Codes

Bending Strength and Impact Tests on Plastic/Composite Ties Test Matrix

Test Number	Tie Type	Test	Number of Test Ties Required	Fastener (Pilot Hole)	Tie-Center Temperature ($\pm 5^{\circ}\text{F}$)
1	Type A New	RS	1/2	None	120
2	Type A New	RS	1/2	None	70 (Ambient)
3	Type A New	RS	1/2	None	-25
4	Type A New	RSP	1/2	CS (No Pilot Hole)	120
5	Type A New	RSP	1/2	CS (No Pilot Hole)	70 (Ambient)
6	Type A New	RSP	1/2	CS (No Pilot Hole)	-25
7	Type A New	RSN	1/2	CS (No Pilot Hole)	120
8	Type A New	RSN	1/2	CS (No Pilot Hole)	70 (Ambient)
9	Type A New	RSN	1/2	CS (No Pilot Hole)	-25
10	Type A New	RSP	1/2	SSs (11/16" \times 5")	120
11	Type A New	RSP	1/2	SSs (11/16" \times 5")	70 (Ambient)
12	Type A New	RSP	1/2	SSs (11/16" \times 5")	-25
13	Type A New	RSN	1/2	SSs (11/16" \times 5")	120
14	Type A New	RSN	1/2	SSs (11/16" \times 5")	70 (Ambient)
15	Type A New	RSN	1/2	SSs (11/16" \times 5")	-25
16	Type A New	RSP—Impact	1/2	SSs (11/16" \times 5")	-25
17	Type A New	RSP—Impact	1/2	No Fasteners (11/16" \times 5" Pilot Hole)	-25
18	Type A New	RSP	1/2	No Fasteners (11/16" \times 5" Pilot Hole)	-25
19	Type A New	Center—Bending (MOE & Deformation)	1	N/A	120
20	Type A New	Center—Bending (MOE & Deformation)	1	N/A	70 (Ambient)
21	Type A New	Center—Bending (MOE & Deformation)	1	N/A	-25
22	Type A New	Center—Bending (MOR)	1	N/A	120

Test Number	Tie Type	Test	Number of Test Ties Required	Fastener (Pilot Hole)	Tie-Center Temperature ($\pm 5^{\circ}\text{F}$)
23	Type A New	Center—Bending (MOR)	1	N/A	70 (Ambient)
24	Type A New	Center—Bending (MOR)	1	N/A	-25
25	Type A Cracked	RSP	1/2	SSs	120
26	Type A Cracked	RSP	1/2	SSs	70 (Ambient)
27	Type A Cracked	RSP	1/2	SSs	-25
28	Type A Cracked	RSN	1/2	SSs	120
29	Type A Cracked	RSN	1/2	SSs	70 (Ambient)
30	Type A Cracked	RSN	1/2	SSs	-25
31	Type A Cracked	RSP—Impact	1/2	SSs	-25
32	Type A Cracked	RSP—Impact	1/2	No Fasteners	-25
33	Type A Cracked	RSP	1/2	No Fasteners	-25
34	Type B New	RS	1/2	None	120
35	Type B New	RS	1/2	None	70 (Ambient)
36	Type B New	RS	1/2	None	-25
37	Type B New	RSP	1/2	CS (No Pilot Hole)	120
38	Type B New	RSP	1/2	CS (No Pilot Hole)	70 (Ambient)
39	Type B New	RSP	1/2	CS (No Pilot Hole)	-25
40	Type B New	RSN	1/2	CS (No Pilot Hole)	120
41	Type B New	RSN	1/2	CS (No Pilot Hole)	70 (Ambient)
42	Type B New	RSN	1/2	CS (No Pilot Hole)	-25
43	Type B New	RSP	1/2	SSs (11/16" \times 5")	120
44	Type B New	RSP	1/2	SSs (11/16" \times 5")	70 (Ambient)
45	Type B New	RSP	1/2	SSs (11/16" \times 5")	-25
46	Type B New	RSN	1/2	SSs (11/16" \times 5")	120
47	Type B New	RSN	1/2	SSs (11/16" \times 5")	70 (Ambient)
48	Type B New	RSN	1/2	SSs (11/16" \times 5")	-25
49	Type B New	RSP—Impact	1/2	SSs (11/16" \times 5")	-25
50	Type B New	RSP—Impact	1/2	No Fasteners (11/16" \times 5" Pilot Hole)	-25
51	Type B New	RSP	1/2	No Fasteners (11/16" \times 5" Pilot Hole)	-25
52	Type B New	Center—Bending (MOE & Deformation)	1	N/A	120

Test Number	Tie Type	Test	Number of Test Ties Required	Fastener (Pilot Hole)	Tie-Center Temperature ($\pm 5^{\circ}\text{F}$)
53	Type B New	Center—Bending (MOE & Deformation)	1	N/A	70 (Ambient)
54	Type B New	Center—Bending (MOE & Deformation)	1	N/A	-25
55	Type B New	Center—Bending (MOR)	1	N/A	120
56	Type B New	Center—Bending (MOR)	1	N/A	70 (Ambient)
57	Type B New	Center—Bending (MOR)	1	N/A	-25
58	Type B Cracked	RSP	1/2	SSs	120
59	Type B Cracked	RSP	1/2	SSs	70 (Ambient)
60	Type B Cracked	RSP	1/2	SSs	-25
61	Type B Cracked	RSN	1/2	SSs	120
62	Type B Cracked	RSN	1/2	SSs	70 (Ambient)
63	Type B Cracked	RSN	1/2	SSs	-25
64	Type B Cracked	RSP—Impact	1/2	SSs	-25
65	Type B Cracked	RSP—Impact	1/2	No Fasteners	-25
66	Type B Cracked	RSP	1/2	No Fasteners	-25
67	Type A New	RS	1/2	None	120
68	Type A New	RS	1/2	None	70 (Ambient)
69	Type A New	RS	1/2	None	-25
70	Type A New	RSP	1/2	CS (No Pilot Hole)	120
71	Type A New	RSP	1/2	CS (No Pilot Hole)	70 (Ambient)
72	Type A New	RSP	1/2	CS (No Pilot Hole)	-25
73	Type A New	RSN	1/2	CS (No Pilot Hole)	120
74	Type A New	RSN	1/2	CS (No Pilot Hole)	70 (Ambient)
75	Type A New	RSN	1/2	CS (No Pilot Hole)	-25
76	Type A New	RSP	1/2	SSs (11/16" \times 5")	120
77	Type A New	RSP	1/2	SSs (11/16" \times 5")	70 (Ambient)
78	Type A New	RSP	1/2	SSs (11/16" \times 5")	-25
79	Type A New	RSN	1/2	SSs (11/16" \times 5")	120
80	Type A New	RSN	1/2	SSs (11/16" \times 5")	70 (Ambient)
81	Type A New	RSN	1/2	SSs (11/16" \times 5")	-25

Test Number	Tie Type	Test	Number of Test Ties Required	Fastener (Pilot Hole)	Tie-Center Temperature ($\pm 5^{\circ}\text{F}$)
82	Type A New	RSP—Impact	1/2	SSs (11/16" \times 5")	-25
83	Type A New	RSP—Impact	1/2	No Fasteners (11/16" \times 5" Pilot Hole)	-25
84	Type A New	RSP	1/2	No Fasteners (11/16" \times 5" Pilot Hole)	-25
85	Type A New	Center—Bending (MOE & Deformation)	1	NA	120
86	Type A New	Center—Bending (MOE & Deformation)	1	N/A	70 (Ambient)
87	Type A New	Center—Bending (MOE & Deformation)	1	N/A	-25
88	Type A New	Center—Bending (MOR)	1	N/A	120
89	Type A New	Center—Bending (MOR)	1	N/A	70 (Ambient)
90	Type A New	Center—Bending (MOR)	1	N/A	-25
91	Type A Cracked	RSP	1/2	SSs	120
92	Type A Cracked	RSP	1/2	SSs	70 (Ambient)
93	Type A Cracked	RSP	1/2	SSs	-25
94	Type A Cracked	RSN	1/2	SSs	120
95	Type A Cracked	RSN	1/2	SSs	70 (Ambient)
96	Type A Cracked	RSN	1/2	SSs	-25
97	Type A Cracked	RSP—Impact	1/2	SSs	-25
98	Type A Cracked	RSP—Impact	1/2	No Fasteners	-25
99	Type A Cracked	RSP	1/2	No Fasteners	-25
100	Type D New	RS	1/2	None	120
101	Type D New	RS	1/2	None	70 (Ambient)
102	Type D New	RS	1/2	None	-25
103	Type D New	RSP	1/2	CS (No Pilot Hole)	120
104	Type D New	RSP	1/2	CS (No Pilot Hole)	70 (Ambient)
105	Type D New	RSP	1/2	CS (No Pilot Hole)	-25
106	Type D New	RSN	1/2	CS (No Pilot Hole)	120
107	Type D New	RSN	1/2	CS (No Pilot Hole)	70 (Ambient)
108	Type D New	RSN	1/2	CS (No Pilot Hole)	-25

Test Number	Tie Type	Test	Number of Test Ties Required	Fastener (Pilot Hole)	Tie-Center Temperature ($\pm 5^{\circ}\text{F}$)
109	Type D New	RSP	1/2	SSs (11/16" \times 5")	120
110	Type D New	RSP	1/2	SSs (11/16" \times 5")	70 (Ambient)
111	Type D New	RSP	1/2	SSs (11/16" \times 5")	-25
112	Type D New	RSN	1/2	SSs (11/16" \times 5")	120
113	Type D New	RSN	1/2	SSs (11/16" \times 5")	70 (Ambient)
114	Type D New	RSN	1/2	SSs (11/16" \times 5")	-25
115	Type D New	RSP—Impact	1/2	SSs (11/16" \times 5")	-25
116	Type D New	RSP—Impact	1/2	No Fasteners (11/16" \times 5" Pilot Hole)	-25
117	Type D New	RSP	1/2	No Fasteners (11/16" \times 5" Pilot Hole)	-25
118	Type D New	Center—Bending (MOE & Deformation)	1	N/A	120
119	Type D New	Center—Bending (MOE & Deformation)	1	N/A	70 (Ambient)
120	Type D New	Center—Bending (MOE & Deformation)	1	N/A	-25
121	Type D New	Center—Bending (MOR)	1	N/A	120
122	Type D New	Center—Bending (MOR)	1	N/A	70 (Ambient)
123	Type D New	Center—Bending (MOR)	1	N/A	-25
124	Type D Cracked	RSP	1/2	SSs	120
125	Type D Cracked	RSP	1/2	SSs	70 (Ambient)
126	Type D Cracked	RSP	1/2	SSs	-25
127	Type D Cracked	RSN	1/2	SSs	120
128	Type D Cracked	RSN	1/2	SSs	70 (Ambient)
129	Type D Cracked	RSN	1/2	SSs	-25
130	Type D Cracked	RSP—Impact	1/2	SSs	-25
131	Type D Cracked	RSP—Impact	1/2	No Fasteners	-25
132	Type D Cracked	RSP	1/2	No Fasteners	-25
133	New Oak (Control)	RSP	1/2	SSs (11/16" \times 5")	70 (Ambient)
134	New Oak (Control)	RSN	1/2	SSs (11/16" \times 5")	70 (Ambient)

Test Number	Tie Type	Test	Number of Test Ties Required	Fastener (Pilot Hole)	Tie-Center Temperature (±5°F)
135	New Oak (Comparison)	Center—Bending (Published MOE & MOR)	N/A	N/A	70 (Ambient)
136	New Oak (Control)	RSP	1/2	SSs (11/16" × 5")	70 (Ambient)
137	New Oak (Control)	RSN	1/2	SSs (11/16" × 5")	70 (Ambient)
138	New Oak (Comparison)	Center—Bending (Published MOE & MOR)	N/A	N/A	70 (Ambient)

Abbreviations and Acronyms

AAR	Association of American Railroads
AREMA	American Railway Engineering and Maintenance of Way Association
ASTM	American Society for Testing and Materials
CS	cut spike
FAST	Facility for Accelerated Service Testing
FRA	Federal Railroad Administration
HAL	heavy axle load
HDPE	high density polyethylene
HTL	High Tonnage Loop
MGT	million gross tons
MOE	modulus of elasticity
MOR	modulus of rupture
MTS	Material Testing System
PSI	pounds per square inch
RS	rail seat
RSP	rail seat positive
RSN	rail seat negative
S	stress
SS	screw spike
TTC	Transportation Technology Center (the site)
TTCI	Transportation Technology Center, Inc. (the company)