



U.S. Department  
of Transportation  
**Federal Railroad  
Administration**

## **Technical Criteria and Procedures for Evaluating the Crashworthiness and Occupant Protection Performance of Alternatively Designed Passenger Rail Equipment for Use in Tier I Service**

---

Office of Railroad  
Policy and Development  
Office of Safety  
Washington, DC 20005



**Notice**

This document is disseminated under the sponsorship of the Department of Transportation in the interest of information exchange. The United States Government assumes no liability for its contents or use thereof. Any opinions, findings and conclusions, or recommendations expressed in this material do not necessarily reflect the views or policies of the United States Government, nor does mention of trade names, commercial products, or organizations imply endorsement by the United States Government. The United States Government assumes no liability for the content or use of the material contained in this document.

**Notice**

The United States Government does not endorse products or manufacturers. Trade or manufacturers' names appear herein solely because they are considered essential to the objective of this report.

<b>REPORT DOCUMENTATION PAGE</b>			<i>Form approved</i> <i>OMB No. 0704-0188</i>	
Public reporting burden for this collection of information is estimated to average 1 hour per response, including the time for reviewing instructions, searching existing data sources, gathering and maintaining the data needed, and completing and reviewing the collection of information. Send comments regarding this burden estimate or any other aspect of this collection of information, including suggestions for reducing this burden to Washington Headquarters Services, Directorate for Information Operations and Reports, 1215 Jefferson Davis Highway, Suite 1204, Arlington, VA 22202-4302, and to the Office of Management and Budget, Paperwork Reduction Project (0702-0288), Washington, D.C. 20503				
<b>1. AGENCY USE ONLY (Leave blank)</b>		<b>2. REPORT DATE</b>	<b>3. REPORT TYPE AND DATES COVERED</b>	
		October 2011	Technical Report	
<b>4. TITLE AND SUBTITLE</b>			<b>5. FUNDING NUMBERS</b>	
Technical Criteria and Procedures for Evaluating the Crashworthiness and Occupant Protection Performance of Alternatively Designed Passenger Rail Equipment for Use in Tier I Service				
<b>6. AUTHOR(S)</b>				
Compiled by Michael Carolan, Karina Jacobsen, Patricia Llana, Kristine Severson, Benjamin Perlman, and David Tyrell				
<b>7. PERFORMING ORGANIZATION NAME(S) AND ADDRESS(ES)</b>			<b>8. PERFORMING ORGANIZATION REPORT NUMBERS</b>	
U.S. Department of Transportation Research and Innovative Technology Administration John A. Volpe National Transportation Systems Center 55 Broadway Cambridge, MA 02142-1093  U.S. Department of Transportation Federal Railroad Administration Office of Railroad Policy and Development Office of Safety 1200 New Jersey Avenue, SE Washington, DC 20590				
<b>9. SPONSORING/MONITORING AGENCY NAME(S) AND ADDRESS(ES)</b>			<b>10. SPONSORING/MONITORING AGENCY REPORT NUMBER</b>	
U.S. Department of Transportation Federal Railroad Administration Office of Railroad Policy and Development 1200 New Jersey Avenue, SE Washington, DC 20590			DOT/FRA/ORD-11/22	
<b>11. SUPPLEMENTARY NOTES</b>				
Program Manager: Melissa Shurland				
<b>12a. DISTRIBUTION/AVAILABILITY STATEMENT</b>			<b>12b. DISTRIBUTION CODE</b>	
This document is available to the public on the FRA Web site at <a href="http://www.fra.dot.gov">http://www.fra.dot.gov</a> .				
<b>13. ABSTRACT</b>				
Criteria and procedures have been developed for assessing crashworthiness and occupant protection performance of alternatively designed trainsets to be used in Tier I (not exceeding 125 mph) passenger service. These criteria and procedures take advantage of the latest technology in rail equipment crashworthiness and include aspects that are fundamentally different from current regulations, such as the scenario-based train-level requirements, which have no counterpart in FRA's current Tier I regulations. Numerical values of the pass/fail criteria have been selected to provide an equivalent level of crashworthiness as the current Tier I regulations. For example, while the occupied volume integrity requirements have been relaxed from the current regulations, the criteria for preservation of the occupied volume for a collision with a locomotive-led train have been added to compensate. In other cases, such as roof integrity, the existing regulations can be applied to alternative equipment.				
<b>14. SUBJECT TERMS</b>			<b>15. NUMBER OF PAGES</b>	
RSAC, crashworthiness, waiver application, Tier I, standards, passenger equipment			177	
			<b>16. PRICE CODE</b>	
<b>17. SECURITY CLASSIFICATION</b>	<b>18. SECURITY CLASSIFICATION OF THIS PAGE</b>	<b>19. SECURITY CLASSIFICATION OF ABSTRACT</b>	<b>20. LIMITATION OF ABSTRACT</b>	
Unclassified	Unclassified	Unclassified	Unlimited	

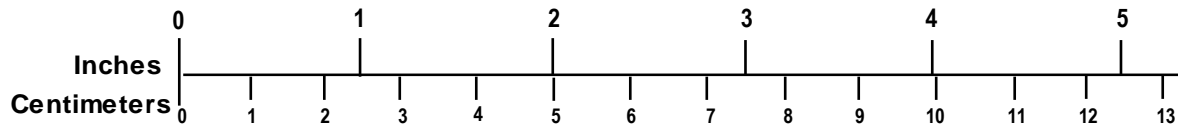
# METRIC/ENGLISH CONVERSION FACTORS

## ENGLISH TO METRIC

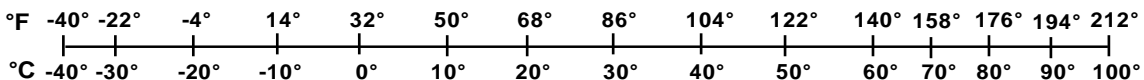
## METRIC TO ENGLISH

<b>LENGTH (APPROXIMATE)</b>	<b>LENGTH (APPROXIMATE)</b>
1 inch (in) = 2.5 centimeters (cm)	1 millimeter (mm) = 0.04 inch (in)
1 foot (ft) = 30 centimeters (cm)	1 centimeter (cm) = 0.4 inch (in)
1 yard (yd) = 0.9 meter (m)	1 meter (m) = 3.3 feet (ft)
1 mile (mi) = 1.6 kilometers (km)	1 meter (m) = 1.1 yards (yd)
	1 kilometer (km) = 0.6 mile (mi)
<b>AREA (APPROXIMATE)</b>	<b>AREA (APPROXIMATE)</b>
1 square inch (sq in, in <sup>2</sup> ) = 6.5 square centimeters (cm <sup>2</sup> )	1 square centimeter (cm <sup>2</sup> ) = 0.16 square inch (sq in, in <sup>2</sup> )
1 square foot (sq ft, ft <sup>2</sup> ) = 0.09 square meter (m <sup>2</sup> )	1 square meter (m <sup>2</sup> ) = 1.2 square yards (sq yd, yd <sup>2</sup> )
1 square yard (sq yd, yd <sup>2</sup> ) = 0.8 square meter (m <sup>2</sup> )	1 square kilometer (km <sup>2</sup> ) = 0.4 square mile (sq mi, mi <sup>2</sup> )
1 square mile (sq mi, mi <sup>2</sup> ) = 2.6 square kilometers (km <sup>2</sup> )	10,000 square meters (m <sup>2</sup> ) = 1 hectare (ha) = 2.5 acres
1 acre = 0.4 hectare (he) = 4,000 square meters (m <sup>2</sup> )	
<b>MASS - WEIGHT (APPROXIMATE)</b>	<b>MASS - WEIGHT (APPROXIMATE)</b>
1 ounce (oz) = 28 grams (gm)	1 gram (gm) = 0.036 ounce (oz)
1 pound (lb) = 0.45 kilogram (kg)	1 kilogram (kg) = 2.2 pounds (lb)
1 short ton = 2,000 pounds (lb) = 0.9 tonne (t)	1 tonne (t) = 1,000 kilograms (kg)
	= 1.1 short tons
<b>VOLUME (APPROXIMATE)</b>	<b>VOLUME (APPROXIMATE)</b>
1 teaspoon (tsp) = 5 milliliters (ml)	1 milliliter (ml) = 0.03 fluid ounce (fl oz)
1 tablespoon (tbsp) = 15 milliliters (ml)	1 liter (l) = 2.1 pints (pt)
1 fluid ounce (fl oz) = 30 milliliters (ml)	1 liter (l) = 1.06 quarts (qt)
1 cup (c) = 0.24 liter (l)	1 liter (l) = 0.26 gallon (gal)
1 pint (pt) = 0.47 liter (l)	
1 quart (qt) = 0.96 liter (l)	1 cubic meter (m <sup>3</sup> ) = 36 cubic feet (cu ft, ft <sup>3</sup> )
1 gallon (gal) = 3.8 liters (l)	1 cubic meter (m <sup>3</sup> ) = 1.3 cubic yards (cu yd, yd <sup>3</sup> )
1 cubic foot (cu ft, ft <sup>3</sup> ) = 0.03 cubic meter (m <sup>3</sup> )	
1 cubic yard (cu yd, yd <sup>3</sup> ) = 0.76 cubic meter (m <sup>3</sup> )	
<b>TEMPERATURE (EXACT)</b>	<b>TEMPERATURE (EXACT)</b>
$[(x-32)(5/9)]\text{ }^{\circ}\text{F} = y\text{ }^{\circ}\text{C}$	$[(9/5)y + 32]\text{ }^{\circ}\text{C} = x\text{ }^{\circ}\text{F}$

## QUICK INCH - CENTIMETER LENGTH CONVERSION



## QUICK FAHRENHEIT - CELSIUS TEMPERATURE CONVERSION



For more exact and or other conversion factors, see NIST Miscellaneous Publication 286, Units of Weights and Measures.  
Price \$2.50 SD Catalog No. C13 10286

Updated 6/17/98

## **Preface**

---

### **Engineering Task Force Organization**

The Engineering Task Force (ETF) reports to the Passenger Safety Working Group of the Railroad Safety Advisory Committee (RSAC).

### **Mission**

The mission of the task force was to produce a set of technical criteria and procedures for evaluating passenger rail trainsets built to alternative designs. The technical evaluation criteria and procedures would provide a means of establishing whether equipment of an alternative design would result in at least equivalent performance to that of equipment designed in accordance with the structural standards in the Passenger Equipment Safety Standards (49 CFR Part 238). The criteria and procedures described in this document are specifically intended to apply to trainsets operated at speeds up to 125 mph that may need a waiver from (or, as appropriate under § 238.201(b), approval of alternative compliance with) one or more of the Passenger Equipment Safety Standards. The initial focus of this effort was on Tier I crashworthiness and occupant protection standards. This report is the product of this effort.

The criteria and procedures contained within this report provide a technical framework for presenting evidence to the Federal Railroad Administration (FRA) in support of a request for waiver of the Tier I crashworthiness and occupant protection standards, including the compressive (buff) strength requirements set forth in 49 CFR § 238.203. *See*, Rules of Practice (49 CFR Part 211) for rules on waiver petitions. In addition, these guidelines form a technical basis for making determinations concerning alternative compliance with the Tier I crashworthiness and occupant protection standards, as set forth in §238.201(b). The criteria and procedures contained in this report may be incorporated into the Passenger Equipment Safety Standards at a later date, after notice and opportunity for public comment.

### **Approach**

In evaluating requests for waivers and other approvals for the use of passenger equipment not compliant with FRA's structural standards, FRA, with support from the John A. Volpe National Transportation Systems Center, has been reviewing and comparing the performance of domestic, conventional equipment with equipment designed to international standards. Based in part on knowledge gained from these reviews and similar evaluations conducted for more than a decade since Part 238 was promulgated, FRA presented a strawman technical proposal as a starting point for the task force. This initial strawman was heavily influenced by current state-of-the-art research results as well as established, international performance standards. The task force worked to modify each of the technical and the design verification requirements proposed in the strawman to better meet the goals outlined below.

### **Goals**

The Task Force set out to meet the following goals:

- Use the collective “best” thinking in the passenger rail industry;

- Produce clear, realistic technical criteria and procedures for demonstrating equivalent performance;
- Define the analysis and testing necessary to demonstrate the integrity of any specific design;
- Provide clear pass/fail analysis and testing criteria; and
- Work expeditiously so that the technical criteria and procedures are available to sponsors of potential passenger rail service.

The task force did not attempt to identify every possible means of determining the performance of alternative designs, and FRA did not anticipate that the availability of technical criteria and procedures would replace sound engineering judgment in reviewing requests for waivers and other approvals. However, it was anticipated that the availability of technical criteria and procedures could substantially reduce the uncertainty associated with demonstrating equivalent safety or alternative compliance.

### **Task Force Membership**

Task force membership was open to designated representatives of RSAC member organizations participating in the Passenger Safety Working Group. FRA encouraged participation through one of those organizations by:

- Any car builder with capability to produce vehicles that will meet the proposed criteria, including those builders that can meet the current standards and any railroad or public authority that may procure new, alternatively designed equipment;
- Any consultant with extensive passenger rail car structural design experience; and
- Others who are valuable to the success of the Task Force, specifically including rail labor representatives.

The focus of this effort was the derivation of technical criteria suitable for determinations of equivalent safety with the existing standards. Accordingly, task force members were expected to continue to apply engineering principles neutrally and professionally.

# Contents

---

<b>Executive Summary</b> .....	<b>1</b>
<b>1 Introduction</b> .....	<b>3</b>
1.1 Background .....	3
1.2 Objective .....	4
1.3 Scope.....	5
1.4 Overview of Development.....	6
1.5 Document Organization.....	6
1.1 1.6 Guidance Summary.....	8
<b>2 Technical Basis</b> .....	<b>9</b>
2.1 Background .....	9
2.2 Rail Equipment Crashworthiness Technology.....	10
2.2.1 <i>Occupied Volume Integrity</i> .....	10
2.2.2 <i>Crash Energy Management</i> .....	12
2.2.3 <i>Occupant Protection</i> .....	15
2.3 Technical Basis for Criteria .....	22
2.3.1 <i>Train-Level</i> .....	25
2.3.2 <i>Car-Level</i> .....	40
2.3.3 <i>Interior Occupant Protection</i> .....	46
<b>3 Criteria</b> .....	<b>48</b>
3.1 Requirement: Collision with Conventional Equipment.....	48
3.2 Requirement: Occupied Volume Integrity.....	50
3.3 Requirement: Colliding Equipment Override.....	51
3.4 Requirement: Connected Equipment Override.....	52
3.5 Requirement: Fluid Entry Inhibition.....	54
3.6 Requirement: End Structure Integrity of Cab End.....	55
3.7 Requirement: End Structure Integrity of Noncab End.....	56
3.8 Requirement: Roof Integrity .....	57
3.9 Requirement: Side Structure Integrity .....	58
3.10 Requirement: Truck Attachment.....	59
3.11 Requirement: Interior Fixture Attachment.....	60
3.12 Requirement: Occupant Protection Features .....	61
<b>4 Example Procedures</b> .....	<b>62</b>
4.1 Introduction.....	62
4.2 Guidance Summary.....	63
4.3 Requirement: Collision with Conventional Equipment.....	64
4.3.1 <i>Criteria</i> .....	64
4.3.2 <i>Example Procedures</i> .....	65
4.3.3 <i>Example Key Results</i> .....	71
4.4 Requirement: Occupied Vehicle Integrity .....	81
4.4.1 <i>Criteria</i> .....	81

4.4.2	<i>Example Procedure</i> .....	82
4.5	Requirement: Colliding Equipment Override .....	89
4.5.1	<i>Criteria</i> .....	89
4.5.2	<i>Example Procedure</i> .....	90
4.5.3	<i>Example Key Results</i> .....	90
4.6	Requirement: Connected Equipment Override .....	92
4.6.1	<i>Criteria</i> .....	92
4.6.2	<i>Example Procedure</i> .....	93
4.6.3	<i>Example Key Results</i> .....	94
4.7	Requirement – End Structure Integrity of Cab End.....	96
4.7.1	<i>Criteria</i> .....	96
4.7.2	<i>Example Procedures</i> .....	97
4.8	Requirement – End Structure Integrity of Noncab End.....	105
4.8.1	<i>Criteria</i> .....	105
4.8.2	<i>Example Procedures</i> .....	106
4.9	Requirement: Truck Attachment.....	110
4.9.1	<i>Criteria</i> .....	110
4.9.2	<i>Example Procedure</i> .....	110
4.9.3	<i>Example Results</i> .....	111
4.10	Summary and Next Steps.....	113
<b>5</b>	<b>References</b> .....	<b>114</b>
	<b>Appendix A. Selected Train Incidents</b> .....	<b>118</b>
	<b>Appendix B. Selected CFR References</b> .....	<b>127</b>
	<b>Appendix C. Locomotive and Passenger Car Input Data</b> .....	<b>148</b>
	<b>Appendix D. Railroad Safety Advisory Committee Passenger Safety Working Group</b> <b>Engineering Task Force</b> .....	<b>158</b>
	<b>Definitions</b> .....	<b>163</b>
	<b>Abbreviations and Acronyms</b> .....	<b>164</b>



## Illustrations

---

Figure 1. 800,000 lb on Line of Draft.....	11
Figure 2. Schematic Illustration of Crush Zone Locations in Commuter Rail Passenger Train ..	12
Figure 3. Cab Car Crush Zone .....	13
Figure 4. Frames from High-Speed Movies of Conventional (top) and CEM (bottom) Train-to-Train Tests .....	14
Figure 5. Example of Uncontrolled Car-to-Car Interactions .....	14
Figure 6. Examples of Controlled Car-to-Car Interactions.....	15
Figure 7. Computer Simulation Illustrating Occupant Kinematics .....	16
Figure 8. Representative SIV Plot Corresponding to Various Seating Configurations .....	17
Figure 9. Example SIV Plot with Injury Interpretation .....	18
Figure 10. Design of an Improved Workstation Table .....	19
Figure 11. Pre- and Posttest Photos of Table Test .....	20
Figure 12. Schematic of Prototype Commuter Seat.....	21
Figure 13. Pre- and Posttest Photos of Forward-Facing 8g Sled Test .....	22
Figure 14. Pre- and Posttest Photos of Rear-Facing 12g Sled Test .....	22
Figure 15. Schematic of Collision Scenario .....	25
Figure 16. Aerial Photograph of Placentia Accident [27].....	26
Figure 17. Estimated Force-Crush Characteristics for Tier I-Compliant (blue) and EN-Compliant (red) Equipment.....	27
Figure 18. Distribution of Crush in the EN-Compliant Train in Prescribed Scenario, Closing Speeds of 15 and 20 mph .....	28
Figure 19. SIV Plot for EN-Compliant Equipment .....	28
Figure 20. Illustration of Offset Conditions for Colliding Equipment .....	29
Figure 21. Location of Offsets in Moving Consist: First Connected Interface .....	30
Figure 22. Illustration of Offsets for Coupled Cars .....	30
Figure 23. Illustration of Offsets for Articulated Cars.....	30
Figure 24. Cab Car Interaction with Conventional Locomotive in a Collision .....	31
Figure 25. CEM Cab Car Interaction with Conventional Locomotive in a Collision .....	32
Figure 26. Non-CEM-Connected Equipment Interaction in a Collision .....	33
Figure 27. CEM Connected Equipment Interaction in a Collision.....	34
Figure 28. Illustration of Principal Sources of Vertical Offset between Cars .....	35
Figure 29. Illustration of Principal Sources of Lateral Offset between Cars .....	35

Figure 30. Accident Conditions in Which Trucks Have Remained Attached .....	37
Figure 31. Accident Conditions in Which Trucks Have Become Detached.....	37
Figure 32. Illustration of the Influence of Longitudinal Suspension on Suspension Stop Loading.....	38
Figure 33. Example Load-Displacement Characteristic Indicating Crippling Load .....	41
Figure 34. Lead Cab Car after Striking Truck at Highway-Rail Grade Crossing (Portage, IN – 1998) .....	42
Figure 35. Corner and Side Damage to Trailing Coach (Gary, IN – 1997).....	43
Figure 36. MU Side Structure Damage after Striking Construction Equipment (Hewlett, NY – 2001) .....	44
Figure 37. Derailed Car Supported by its Roof and Side Structures (Nodaway, IA – 2001) .....	45
Figure 38. Collision Scenario .....	48
Figure 39. Engineer’s Seat with Survival Space Indicated.....	49
Figure 40. Location of Offsets in Moving Consist .....	52
Figure 41. Illustration of Offsets for Coupled Cars .....	52
Figure 42. Illustration of Offsets for Articulated Cars.....	53
Figure 43. Collision Scenario .....	64
Figure 44. Engineer’s Seat with Survival Space Indicated.....	65
Figure 45. Flowchart of Evaluation Procedure .....	66
Figure 46. Relationship between Car/Locomotive Crush Evaluation and Train Collision Dynamics Evaluation .....	67
Figure 47. Key Inputs and Outputs for Car Crush Analysis .....	68
Figure 48. Key Inputs and Outputs for Collision Dynamics Evaluation .....	68
Figure 49. Schematic of a Lumped-Parameter Model for a Train-to-Train Collision Scenario...	69
Figure 50. Schematic of a Finite Element Model for a Train-to-Train Collision Scenario .....	69
Figure 51. Example Idealized Force-Crush Characteristics .....	71
Figure 52. Verification of Force-Crush Characteristic through a Series of Full-Scale Structural Component Tests.....	73
Figure 53. Rigid and Deformable Geometry of an F40PHM-Based Locomotive.....	74
Figure 54. Cab-End Model of FRA-Prototype CEM Cab Car.....	74
Figure 55. Cab Car Ideal Dynamic Crush Analysis.....	75
Figure 56. Example Kinematic Sequence of Events from Car-Level Crush Analysis .....	76
Figure 57. Example Car-Level Crush Analysis Measured Force-Crush Characteristic .....	77
Figure 58. Flowchart Showing Procedure for Calculating Intrusion into Occupied Volume .....	78

Figure 59. Example Crush Results from One-Dimensional Lumped Mass Model: Crush Distribution for Each Car End in the Consist .....	79
Figure 60. Flowchart Showing Procedure for Calculating SIV Estimates .....	80
Figure 61. Relative Displacement and Relative Velocity Plots for Moving Consist.....	80
Figure 62. Example SIV Characteristics.....	81
Figure 63. Example of Load-Displacement Characteristic Indicating Crippling .....	82
Figure 64. Example Load-Displacement Characteristics at Front and Back End with 5 Percent Envelope .....	84
Figure 65. Example Ratio of Kinetic Energy to Strain Energy for Analysis.....	85
Figure 66. Example Load-Displacement Characteristic Showing Crippling Load Exceeds 1,200,000 lb .....	88
Figure 67. Dynamic Crush Analysis with Lateral and Vertical Offsets .....	90
Figure 68. Displacement Results from Dynamic Crush Analysis: Ideal Impact Conditions.....	91
Figure 69. Displacement Results from Dynamic Crush Analysis: Offset Impact Conditions.....	91
Figure 70. Location of Offsets in Moving Consist .....	92
Figure 71. Illustration of Offset for Coupled Cars.....	92
Figure 72. Illustration of Offset for Articulated Cars .....	93
Figure 73. Dynamic Crush Analysis: Ideal Impact Conditions (Courtesy of Alstom).....	93
Figure 74. Deformation in Coupled Car Dynamic Crush Analysis: Ideal Impact Conditions (Courtesy of Alstom) .....	94
Figure 75. Relative Vertical Displacement of the Underframes of Two Coupled Cars (Courtesy of Alstom) .....	94
Figure 76. Vertical Displacement of Four Wheels (Courtesy Alstom) .....	95
Figure 77. Still Photographs from High-Speed Video, Collision Post Test .....	98
Figure 78. Contours of Equivalent Plastic Strain for the Quasi-Static Collision Post Load Case.....	99
Figure 79. Contours of Equivalent Plastic Strain for the Quasi-Static Corner Post Load Case ...	99
Figure 80. Test Component Approximation for Component Test.....	100
Figure 81. Example Analysis Results of Car with Deformable Energy Absorbers.....	102
Figure 82. Example of a Dynamic Drop Tower Test of a CEM Component .....	103
Figure 83. Example of a Quasi-Static Test of a CEM Component.....	103
Figure 84. Side View of Car Showing 150-Kilopound Load .....	106
Figure 85. Side View of Car Showing 20-Kilopound Load .....	107
Figure 86. Side View of Car Showing 30-Kilopound Load .....	108

Figure 87. Finite Element Model Showing Side Structure Load and Boundary Conditions..... 109

Figure 88. Cab Car Deceleration-Time History (Courtesy of Alstom) ..... 111

Figure 89. Cab Car Lead Truck Deceleration-time History (Courtesy of Alstom) ..... 112

## Tables

---

Table 1. Guidance Summary for Criteria and Evaluation.....	8
Table 2. Summary of CFR Requirements and Criteria for Truck Attachment.....	39
Table 3. Guidance Summary for Criteria and Evaluation.....	63
Table 4. Example of Key Inputs for Collision Dynamics Analysis.....	70
Table 5. Example Matrix of Component Testing and Analysis.....	72
Table 6. Example Matrix of Component Testing and Analyses .....	104

## **Executive Summary**

---

The passenger rail industry is on the cusp of tremendous growth due, in part, to the increasing effects of congestion on highway systems, carbon emission concerns, and the price of gasoline. A recent U.S. Department of Transportation study suggests the potential for up to 100 new rail authorities in the next 20 years, depending on available State and Federal funding. With the proliferation of planned passenger rail systems around the country, more States and operating authorities desire to use passenger equipment designed to meet alternative standards, which have been proven in foreign operating conditions but not under the more stringent regulations in the United States.

The Federal Railroad Administration's (FRA) primary mission is to provide for the safety of the Nation's railroads by administering the railroad safety laws and regulations. Railroads and operating authorities can petition FRA to waive regulations, including the crashworthiness regulations that apply to rail passenger equipment. Each petition for waiver is expected to contain sufficient information to support the action sought, including an evaluation of anticipated impacts. To provide for safety while making best use of its resources and to facilitate passenger rail industry growth, FRA has decided to develop, in consultation with the rail industry, alternative criteria and procedures for assessing the crashworthiness of rail passenger trainsets that are applicable to a wide range of equipment designs. These criteria and procedures are intended to be used by the rail industry in developing information to support waiver petitions and by FRA in evaluating waiver petitions. The criteria and procedures described in this document are specifically intended to apply to trainsets operated at speeds up to 125 miles per hour (mph). The criteria and procedures may also be incorporated into the Passenger Equipment Safety Standards at a later date, after notice and opportunity for public comment.

Consultation with the industry was accomplished through the Engineering Task Force (ETF). This task force reports to the Passenger Safety Working Group of the Railroad Safety Advisory Committee (RSAC). The Task Force set out to meet the following goals:

- produce clear, realistic technical requirements, benefiting from the collective "best" thinking in the passenger rail industry;
- define the analysis and testing required to demonstrate compliance with the technical requirements;
- provide clear pass/fail criteria for the analyses and tests; and
- work expeditiously so that sponsors of potential passenger service recognize available equipment options.

Task force membership was open to designated representatives of RSAC member organizations participating in the Passenger Safety Working Group. FRA encouraged participation through one of those organizations by:

- any railroad or public authority that may procure new equipment;
- any car builder with capability to produce vehicles for rail passenger service, including those builders that can meet the current standards;
- any consultant with extensive passenger rail car structural design experience; and

- others who are valuable to the success of the task force, specifically including rail labor representatives.

The objective of this effort was to develop criteria and procedures for assessing the crashworthiness and occupant protection performance of alternatively designed equipment to be used in Tier I service. Alternative designs include trainsets originally intended for operation outside the United States that may not be compliant with current FRA Tier I crashworthiness regulations. As defined in Part 238, Tier I service includes any passenger rail service operating at speeds up to 125 mph. Criteria are defined by the conditions that will be evaluated and the critical results from the evaluation. Procedures are defined as the analysis and test techniques applied to demonstrate compliance with the criteria. The criteria and procedures that have been developed take advantage of the latest technology in rail equipment crashworthiness.

The criteria and procedures include aspects that are fundamentally different from current regulations, such as the scenario-based train-level requirements. No such requirements exist in FRA's current Tier I regulations. Numerical values of the pass/fail criteria have been selected to provide an equivalent level of crashworthiness as the current Tier I regulations. For example, the occupied volume integrity (OVI) requirements have been relaxed from the current regulations, and criteria for preservation of the occupied volume for a collision with a locomotive-led train have been added to compensate. In other cases, such as roof integrity, the existing regulations can be applied to alternative equipment. Examples of analysis and test procedures that have been used to evaluate the performance of equipment are included in this document.

# **1. Introduction**

---

## **1.1 Background**

The passenger rail industry is on the cusp of tremendous growth due, in part, to the increasing effects of congestion on highway systems, carbon emission concerns, and the price of gasoline. A recent U.S. Department of Transportation study suggests the potential for up to 100 new rail authorities in the next 20 years, depending on available State and Federal funding. With the proliferation of planned passenger rail systems around the country, more States and operating authorities desire to use passenger equipment designed to meet alternative standards. These standards have been proven in foreign operating conditions but not under the more severe regulations in the United States.

In general, requests to FRA for use of alternative designs have been handled through the waiver process. When a waiver request is initially proffered, the entirety of the information needed to be evaluated under the waiver request, and the potential impact of the waiver determination on the planned operation can be difficult to foresee. The waiver process also increases the workload for FRA, since the details of each operation must be collected, studied, and reviewed prior to making a determination on each waiver petition. The crashworthiness aspects have often required the most effort to address, with FRA typically asking the petitioner for additional information to supplement its original submission.

Since the Passenger Equipment Safety Standards were issued in 1999, advances have been made in rail car construction and crashworthiness. For instance, Crash Energy Management (CEM) technology, a means of absorbing energy to reduce the severity of a collision, has matured around the world. Although it can be, and has been, overlaid on rail equipment designed to be compliant with FRA's structural standards (compliant designs, as used herein), it is more commonly available on equipment designed to meet alternative standards. Under FRA sponsorship, the John A. Volpe National Transportation Systems Center (Volpe Center) has completed significant research into the effectiveness of CEM technology.

Through that research program, methodologies for accurately evaluating the crashworthiness of rail equipment with a high level of confidence have been developed and refined. Additionally, sophisticated analysis techniques for evaluating car crush behavior, train collision dynamics, and occupant dynamic response have been developed through research. Test techniques for measuring structural impact response, including component and substructure testing, and for measuring occupant kinematics and the likelihood of injury have also been developed. The results of these studies can be applied to evaluate the crashworthiness of a wide range of equipment designs.

With the potential for tremendous growth of the passenger rail industry, the safety of the train-riding public and the crews who transport the public becomes an ever greater priority. FRA recognizes that safety regulations appropriate for a wider variety of passenger rail operations are necessary for the passenger rail industry to efficiently and safely grow. To provide for safety while making best use of its resources and to facilitate passenger rail industry growth, FRA has decided to develop, in consultation with the rail industry, alternative criteria and procedures for



assessing the crashworthiness of rail passenger equipment, applicable to a wide range of equipment designs.

## **1.2 Objective**

This research was conducted to develop criteria and procedures for assessing the crashworthiness and occupant protection performance of alternatively designed trainsets to be used in Tier I service. Alternative designs include trainsets originally intended for operation in foreign countries that may not be compliant with current FRA Tier I crashworthiness regulations. As defined in Part 238, Tier I service includes intercity passenger and commuter rail service operating at speeds up to 125 mph. FRA notes that as part of its High-Speed Passenger Rail Safety Strategy, FRA intends to utilize appropriate safety standards and apply system safety program techniques to enhance safety while meeting transportation objectives. The strategy is available on FRA's Web site at <http://www.fra.dot.gov/downloads/safety/HSRSafetyStrategy110609.pdf>. In implementing this safety strategy, FRA has retasked the ETF to develop recommendations for engineering standards related to the safe operation of high-speed rail equipment at speed up to 220 mph. This effort may separately lead to the development of such alternative criteria and procedures for assessing the crashworthiness and occupant protection performance of rail passenger equipment intended for operation at speeds above 125 mph.

Criteria are defined by the conditions to be evaluated and the critical results from the evaluation. A classic example in the rail industry is the 800-kilopound (kip) buff strength requirement. The condition is an 800-kilopound load applied to the buff stops. Buff stops are design elements that support compressive loads into the carbody from the coupler components. The critical result is the deformation of the carbody, which must not be permanent. In other words, the carbody must return to its original shape when the load is removed. The conditions and critical results make up the criteria.

Procedures are defined as the analysis and test techniques applied to demonstrate compliance with the criteria. Continuing with the above example, compliance with the 800-kilopound buff strength requirement is typically demonstrated with a test. The coupler hardware is removed for the test, which allows access to the buff stops. During the test, the load is applied to the buff stops and incrementally increased until the total load reaches 800 kip. After the test, the load is removed, and the instrumentation is checked for indications of permanent deformation. The car is also visually inspected to verify that there is indeed no permanent deformation. The requirements and implementation of the test or analysis constitute the procedure.

The criteria and procedures are intended to provide an engineering-based methodology for comparing the crashworthiness and occupant protection performance of alternatively designed equipment with that of compliant designs. Examples of analysis and test procedures that have been used to evaluate the performance of equipment are included in this document. The results of evaluations of alternatively designed equipment, applying such techniques, can be compared with the criteria values supplied in this document for compliant designs. In this manner, the performance of alternatively designed equipment can be assessed relative to the performance of compliant designs.

FRA's primary mission is to provide for the safety of Nation's railroads by administering the railroad safety laws and regulations. The rules of process for requesting waivers from these regulations are prescribed in 49 CFR 211. Railroads and operating authorities can petition FRA to waive regulations, including the crashworthiness regulations that apply to rail passenger equipment. As described in 49 CFR 211.9(c), each petition for waiver must contain sufficient information to support the action sought, including an evaluation of anticipated impacts. In this regard, the ETF's efforts have resulted in this report's guidance to the rail industry on what information FRA needs to make collision safety determinations on Tier I passenger equipment waiver requests.

FRA notes that, for purposes of obtaining a waiver, it is not necessary that every aspect of the crashworthiness and occupant protection performance for alternatively designed equipment be equal to or exceed that of compliant designs. If there are shortcomings in the performance of the equipment, other safety measures can be taken into account by FRA in making a waiver determination. For example, temporal separation has been used on the New Jersey Transit River Line—primarily to address the lower OVI (buff strength) of the equipment. With temporal separation, the likelihood is significantly reduced of a collision between a passenger train made up of noncompliant equipment and one made up of compliant equipment, or even a freight train. This is just one example. Additional measures to avoid or mitigate hazards can be used to provide for the overall level of system safety supporting a waiver request.

### **1.3 Scope**

The criteria and procedures described in this document are specifically intended to apply to trainsets operated at speeds up to 125 mph that may need a waiver from (or, as appropriate under § 238.201(b), approval of alternative compliance with) one or more of the following regulations:

- § 238.203 Static end strength.
- § 238.205 Anticlimbing mechanism.
- § 238.207 Link between coupling mechanism and carbody.
- § 238.209 Forward end structure of locomotives, including cab cars and MU locomotives.
- § 238.211 Collision posts.
- § 238.213 Corner posts.
- § 238.215 Rollover strength.
- § 238.217 Side structure.
- § 238.219 Truck-to-car-body attachment.
- § 238.233 Interior fittings and surfaces.

In accordance with requirements in § 238.111, the equipment is subject to the prerevenue service acceptance testing. Pursuant to that section, a test plan is required for passenger equipment that has not been used in revenue service in the United States. Although the criteria and procedures are generally applied to the applicable individual structures of the trainset undergoing analysis, the overall intent of § 238.111 is to result in a cohesive design in which all parts function appropriately together. FRA notes that with respect to a trainset utilizing a CEM design, testing of the components incorporated with any CEM system may also be performed as part of a prerevenue service acceptance testing program.

These trainsets may require similar treatment under American Public Transportation Association (APTA) standards, such as APTA SS-C&S-016-99, Rev. 1 (updated 3/2004), Standard for Row-to-Row Seating in Commuter Rail Cars, and this document addresses these standards where appropriate.

#### **1.4 Overview of Development**

RSAC's advice and guidance have been integrated into these criteria and procedures. FRA established ETF of RSAC's Passenger Safety Working Group for this purpose. This task force is made up of members from the rail industry and FRA, with support from the Volpe Center. Industry representatives include railroads, labor organizations, suppliers, and their engineering consultants. FRA representatives include policy, legal, economic, and technical specialists.

The railroads have helped to determine that the information requested for demonstrating compliance with the alternative safety criteria is reasonably obtainable for submission to FRA. The labor organizations have helped to ensure that the resulting criteria and procedures are suitable for providing sufficient crashworthiness and occupant protection performance. The suppliers have helped to ensure that the assessment criteria are clear, that the procedures are practicable, and that the final criteria and procedures are design independent. As appropriate, the engineering consultants have helped with all of these goals. APTA has assisted with coordinating the participation of the railroads, suppliers, and engineering consultants.

#### **1.5 Document Organization**

This document is organized into five principal sections:

##### Section 1 – Introduction

- 1.1 Background
- 1.2 Objective
- 1.3 Scope
- 1.4 Overview of Development
- 1.5 Document Organization
- 1.6 Guidance Summary

##### Section 2 – Technical Basis

- 2.1 Background
- 2.2 Rail Equipment Crashworthiness Technology
- 2.3 Technical Basis for Criteria

##### Section 3 – Criteria

- 3.1 Requirement: Collision with Conventional Equipment
- 3.2 Requirement: Occupied Volume Integrity
- 3.3 Requirement: Colliding Equipment Override
- 3.4 Requirement: Connected Equipment Override
- 3.5 Requirement: Fluid Entry Inhibition
- 3.6 Requirement: End Structure Integrity of Cab End
- 3.7 Requirement: End Structure Integrity of Noncab End
- 3.8 Requirement: Roof Integrity
- 3.9 Requirement: Side Structure Integrity
- 3.10 Requirement: Truck Attachment

- 3.11 Requirement: Interior Fixture Attachment
- 3.12 Requirement: Occupant Protection Features
- Section 4 – Example Procedures
  - 4.1 Introduction
  - 4.2 Guidance Summary
  - 4.3 Requirement: Collision with Conventional Equipment
  - 4.4 Requirement: Occupied Volume Integrity
  - 4.5 Requirement: Colliding Equipment Override
  - 4.6 Requirement: Connected Equipment Override
  - 4.7 Requirement: End Structure Integrity of Cab End
  - 4.8 Requirement: End Structure Integrity of Noncab End
  - 4.9 Requirement: Truck Attachment
  - 4.10 Summary and Next Steps
- Section 5 – References

## 1.1 1.6 Guidance Summary

Table 1 contains a summary of the requirements, load cases, and criteria presented in this report. It is meant only as a summary of those requirements addressed in this report and is not meant to include all applicable requirements for passenger equipment.

**Table 1. Guidance Summary for Criteria and Evaluation**

Requirement	Summary of Load Case	Summary of Criteria
Collision with conventional equipment	Alternatively designed train in collision with conventional locomotive-led train: (a) 20 mph, cab car- or MU locomotive-led; or (b) 25 mph, conventional locomotive-led.	Preserve occupied volume for passengers Preserve survival space in operating cab
OVI	On the intended collision load path: (a) 800 kip; (b) 1,000 kip; and (c) 1,200 kip	(a) No permanent deformation (b) Limited permanent deformation (c) Without crippling
Colliding equipment override	Alternatively designed equipment collision with conventional locomotive: (a) all equipment aligned; and (b) consists offset 3 inches (in) vertical and laterally.	No override and wheel lift minimized
Connected equipment override	Alternatively designed equipment in collision with conventional locomotive, with 2-inch-vertical/2-inch-lateral offsets of first car-to-car connection	No override and wheel lift minimized.
Fluid entry inhibition	Based on design review	(a) Equivalent to 0.5-inch steel plate with 25,000 pounds per square inch (psi) yield strength; (b) Designed to inhibit the entry of fluids into the occupied area; and (c) Affixed to structural members.
End structure integrity of cab end	(a) Absorb minimum of 135 ft-kip of energy for impact offset 19 in from longitudinal centerline; (b) Absorb minimum 120 ft-kip of energy for impact aligned with sidewall.	No more than 10 in of longitudinal, permanent deformation
End (corner) structure integrity of noncab end	(a) 150 kip at floor height; (b) 30 kip 18 in above floor; (c) 20 kip at ceiling height.	(a) Without failure; (b) Without permanent deformation; and (c) Without failure.
Roof integrity	Equipment upside down, supported by roof	(a) No occupied volume intrusion; and (b) No more than 1/2 yield or buckling
Side structure integrity	Design requirements on sidewall stiffness and material properties	Vertical modulus (in <sup>3</sup> ) ≥ 0.3 × L Horizontal modulus (in <sup>3</sup> ) ≥ 0.2 × L
Truck attachment	Scenario 3.1 plus either: (a) 3g vertical, 1g lateral, 5g longitudinal; or (b) 3g vertical, 1g lateral.	Static analyses: Without yielding; and (a) Scenario 3.1: Avg. acc. ≤ 5g and Max. acc. ≤ 10g; or (b) Scenario 3.1: Trucks remain attached
Interior fixture attachment	Fixtures: 8/4/4g Longitudinal/lateral/vertical quasi-static load; and Seats: 8g longitudinal dynamic pulse	Fixtures and seats remain attached
Seats	8g sled test with instrumented HIII ATDs per Rev. 2 of APTA-SS-C&S-016-99	Seats must meet requirements in Rev. 2 of APTA-SS-C&S-016-99, including injury criteria

*Note: Table for use as a summary only for the requirements noted.*

## **2. Technical Basis**

---

### **2.1 Background**

This section describes the technical basis for how the selected criteria provide a comparable level of crashworthiness to the existing regulations.

Crashworthiness regulations and specifications are intended to result in equipment features that increase survivability in accidents. The traditional approach to rail equipment crashworthiness specifications is essentially car oriented, prescribing such things as the strength of the carbody and the strength of the attachment of the trucks. These features are intended to be effective for all of the accident conditions that the equipment may be subjected to in service. The modern approach to rail equipment crashworthiness adds train-oriented specifications and typically includes minimum survivability requirements for prescribed scenarios [1, 2, 3]. These scenarios are intended to bound the range of accidents that may occur in service. The modern approach to rail equipment crashworthiness does not replace the traditional approach; the modern approach extends from and modifies the traditional approach.

Modern specifications generally describe the crashworthiness performance desired of equipment with CEM features. Much research has been conducted on CEM [4, 5, 6]. CEM improves crashworthiness with crush zones at the ends of the cars. These zones are designed to collapse in a controlled fashion during a collision, distributing the crush among the unoccupied ends of the cars of the train. This occupant protection strategy preserves the occupied spaces in the train and limits the decelerations of the occupied volumes. CEM equipment has been demonstrated to protect all of the occupants in a train-to-train collision scenario for more than twice the closing speed of conventional equipment, when the CEM equipment has the same level of occupied volume strength as the conventional equipment [4, 7].

FRA Tier I crashworthiness regulations are largely traditional. Most of them apply to individual cars and their components. FRA is in the process of updating these regulations to better reflect modern technology. For over a decade, FRA, with the assistance of the Volpe Center, has conducted significant research on rail equipment crashworthiness [4, 7, 8, 9, 10] to establish a base of information from which to evaluate, amend, and develop regulations, specifically more performance-based regulations to respond to the needs of the industry. This research was used in developing the final rule prescribing minimum levels of energy absorption in highway-rail grade crossing scenario impacts, published on January 8, 2010 (see 75 Fed. Reg. 1180). Recognizing that railroads would like to use equipment designed to more performance-based, modern standards, FRA is accelerating its efforts to keep its crashworthiness regulations consistent with current safety technology.

Because the traditional and more modern approaches to crashworthiness are different, judgment is needed to make comparisons of the crashworthiness of equipment compliant with traditional requirements and equipment compliant with more modern requirements. In some cases, such as for OVI, it is possible to maintain essentially the same level of crashworthiness while reducing the traditional strength requirement. CEM crush zones can mitigate the reduction in occupied volume strength. In other cases, as in override prevention, the modern approach of controlling the shape of carbody crush supersedes the traditional approach of prescribing a static load that

the carbody must be able to support. In the development of the criteria and procedures, the goal has been to maintain the level of crashworthiness provided by the Tier I regulations in a manner that is as independent as practical from the detailed design features of the equipment.

## **2.2 Rail Equipment Crashworthiness Technology**

In the design for crashworthiness, the first objective is to preserve a sufficient volume for the occupants to ride out the collision without being crushed. Excessive forces and decelerations also present a potential for injury to the occupants. Relatively large forces and decelerations can occur when an unrestrained occupant strikes an interior surface. Occupant impacts with the interior or collisions between occupants and loose objects thrown about during the collision are usually termed secondary collisions. The second objective of crashworthiness is to limit these secondary collision forces and decelerations to tolerable levels.

Preserving occupied volume is accomplished primarily with strength of the structure. If the occupant compartment is sufficiently strong, there will be sufficient, survivable space for the occupants. Secondary impacts are limited through a combination of structural crashworthiness and occupant protection measures. Allowing portions of the vehicle to crush in a predetermined manner can limit the forces applied to the structure surrounding the occupied volume and control the decelerations of the cars. Conventional practice is oriented toward making the individual cars uniformly strong and principally attempts to control the behavior of individual cars during a collision. The CEM approach is train-oriented, controlling the load into the occupied volume and apportioning the structural crushing to unoccupied areas throughout the train.

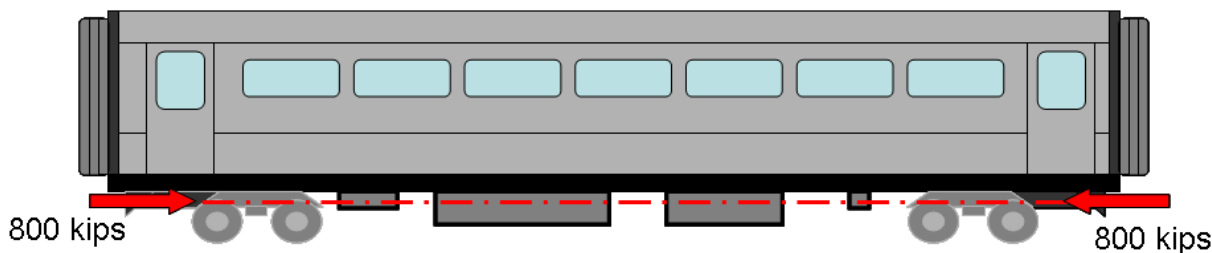
Occupant protection measures include specifying attachment strength requirements for interior fittings and strategies such as compartmentalization to literally contain the occupants within safe areas [11, 12, 13]. How hard the occupant strikes an interior surface during the collision depends on the deceleration of the train itself and the degree of “friendliness” of that surface. There is a tradeoff between increased carbody crush strength and how fast an occupant strikes an interior surface. If a single car has a uniform crush strength, increasing the crush strength increases the deceleration rate of a colliding car. This, in turn, increases the speed at which an occupant impacts an interior surface in the decelerating car. For a consist of cars in a train, the issue is more complex. The deceleration of any particular car within a train is affected by the cushioning of the car ahead of it as well as the deceleration of the car behind it. In general, any crashworthiness strategy that better preserves the occupied volume, such as CEM, will make the secondary impacts more severe for the occupants in the interior. To maximize survivability, interior occupant protection strategies need to be designed to work in concert with structural crashworthiness strategies.

This section includes descriptions of technologies for providing OVI, providing CEM, and providing occupant protection.

### **2.2.1 Occupied Volume Integrity**

In the conventional approach to passenger vehicle crashworthiness in the United States, the underframe of the car must maintain its integrity when subjected to a large compressive load at the coupler locations at either end of the car. The present strength requirement is for a car to remain elastic when subjected to 800,000 pounds (lb) of force loaded along the line of draft (the

imaginary line running from the coupler at one end of the car to the other). This load is shown schematically in Figure 1.



**Figure 1. 800,000 lb on Line of Draft**

The practice of applying a large compressive load to the underframe of the car as a measure of occupant protection stretches back to the early 20th century. At that time, the U.S. Post Office began using baggage cars as railway post office (RPO) cars furnished with tables, chairs, and lighting installed so that postal clerks could sort mail while a train was en route. Unfortunately, in many railroad accidents of the day, these baggage cars offered little protection to the clerks inside, resulting in serious injuries and fatalities. To increase occupant protection, the *Railway Mail Service (RMS) Specification* was published in 1912. One requirement in this specification was for RPO cars to be capable of resisting 400,000 lb applied compressively along the line of draft without experiencing permanent deformation. In future versions of this specification, a factor of safety of 2 was included, bringing the effective load up to 800,000 lb [14].

In response to a number of fatal accidents involving compromised occupied volumes, the Association of American Railroads (AAR) issued a Recommended Practice in 1939 to address carbody structure. This Recommended Practice adopted a number of requirements of the RMS Specification, including the compressive strength of the carbody. In 1945, this recommendation was adopted into Standard S-034, "Specifications for the Construction of New Passenger Equipment Cars." Federal law has applied this requirement to all multiple-unit (MU) locomotives built new after April 1, 1956, and operated in trains having a total empty weight of 600,000 lb or more. See 49 CFR 229.141(a)(1). It was not until 1999, however, that 49 CFR 238.203 expanded this 800,000-pound static strength requirement as a Federal regulation applicable to all intercity passenger and commuter rail equipment.

This line of draft strength requirement has remained the cornerstone of OVI evaluation for nearly a century for several reasons. The pass/fail criterion of no permanent deformation anywhere in the car is straightforward to implement and can be readily examined visually and measured with strain gages. If the test is conducted properly and successfully, the vehicle remains in its original condition and can therefore enter service following the test. The nondestructive nature of the test makes it an economical test to perform as the first manufactured vehicle serves both as test article and proven, deliverable product.

In addition, the proof strength approach to crashworthiness provides additional crashworthiness benefits. Although the original intent of this approach was to maintain some level of protection from loss of occupied volume, this requirement has increased in its importance as other crashworthiness features have been incorporated within the car. For example, standards and regulations also specify the minimum strength of the corner and collision posts on a passenger

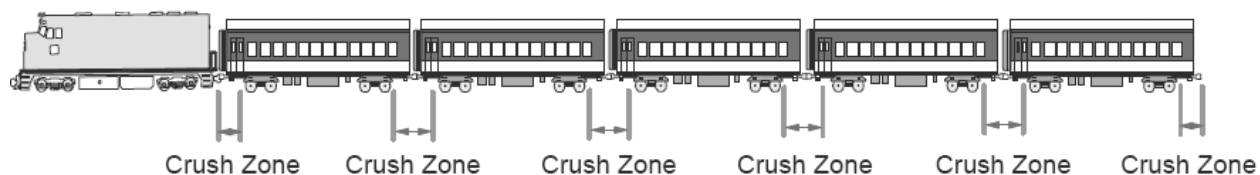


vehicle. For an end frame to be successful in preventing intrusion from impacts above the floor, the structure supporting the end frame must itself be sufficiently strong. A strong end frame that is at the end of a weak occupied volume may prevent intrusion at the end of the car but cause loss of occupied volume elsewhere in the vehicle as collision loads travel through the occupied volume.

### **2.2.2 Crash Energy Management**

Passenger rail equipment crashworthiness can be significantly increased if the force-crush behavior of the equipment is engineered to take place in a controlled manner. Sacrificial crush zones can be designed into unoccupied locations in cars, such as brake and electrical service closets and bicycle storage areas, as well lightly occupied areas without passenger seating, such as vestibules and stairwells. These zones are designed to crush gracefully, with a lower initial force and increased average force. With such crush zones, multiple cars are designed to share energy absorption during a collision, consequently preserving the integrity of the occupied areas by managing the collision energy. The approach of including crush zones is termed CEM.

Figure 2 is a schematic of the concept of CEM, with crush zones at the ends of all of the train's cars.

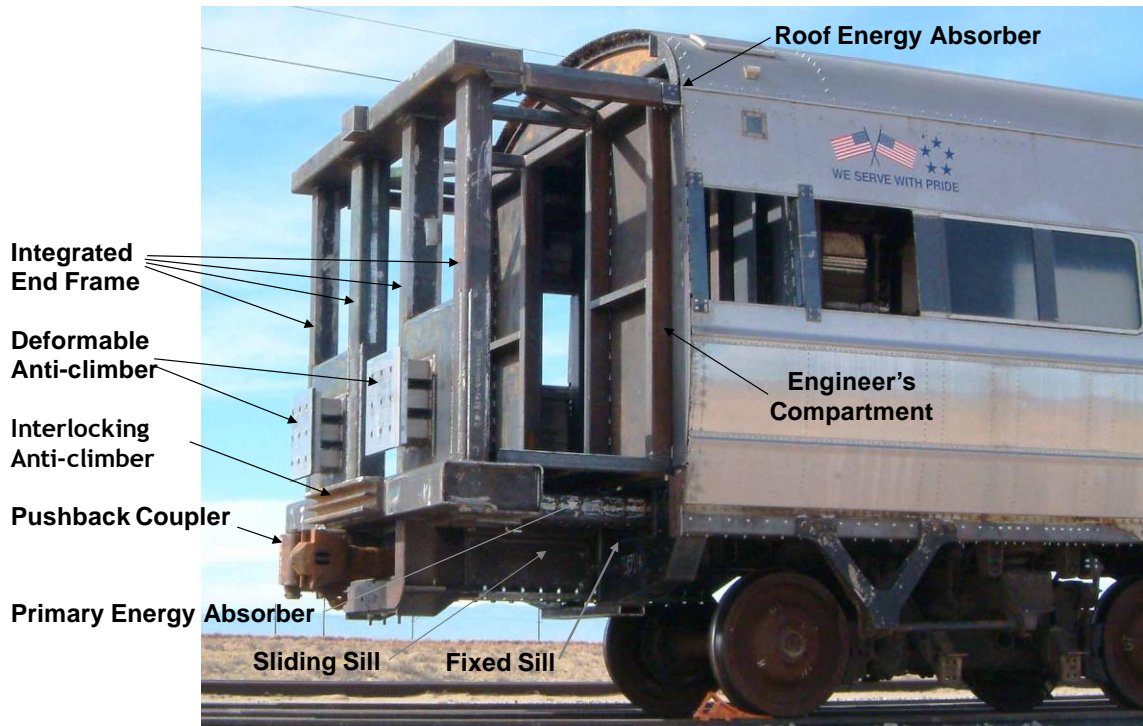


**Figure 2. Schematic Illustration of Crush Zone Locations in Commuter Rail Passenger Train**

CEM extends from conventional crashworthiness design practice. The car's occupied volume must have sufficient strength to support the crush zones designed into it without collapsing. Greater occupied volume strength allows greater crushing forces to be supported; in turn, greater amounts of energy can be absorbed for a given crush distance.

Figure 3 shows the prototype cab end crush zone design that was developed as part of FRA research. The cab car crush zone includes four key elements:

- A pushback coupler mechanism
- A deformable anticlimber arrangement
- An integrated end frame, which incorporates an engineer's compartment
- Roof and primary energy-absorbing elements



**Figure 3. Cab Car Crush Zone**

Each component is designed to operate in sequence during an impact. The pushback coupler accommodates the coupler of the impacting equipment such that the anticlimber and integrated end frame engage the vehicle. As the anticlimber deforms, it conforms to the impacting equipment and distributes the load over the integrated end frame. The integrated end frame transmits the impact load to the energy absorbers. The engineer's compartment can be pushed straight back into unoccupied space designated for service closets.

Superior crashworthiness performance of CEM equipment has been demonstrated with full-scale impact tests. In the train-to-train test of conventional equipment, the colliding cab car was crushed by approximately 22 feet (ft) and overrode the locomotive, eliminating the space for the engineer's seat and for approximately 47 passenger seats [15]. During the train-to-train test of CEM equipment, the front of the cab car was crushed by approximately 3 ft, and the crush was propagated back to all of the unoccupied ends of the trailing passenger cars. The controlled deformation of the cab car prevented override. All of the space for the passengers and crew remained intact [16]. The impact speed for both train-to-train tests was 30 mph. Figure 4 includes frames from high-speed movies showing the colliding equipment interactions.

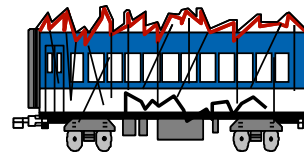


**Figure 4. Frames from High-Speed Movies of Conventional (top) and CEM (bottom) Train-to-Train Tests**

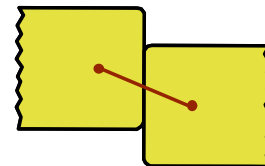
Compared with CEM-designed equipment, the interactions of impacting conventional North American passenger rail equipment are more likely to be uncontrolled, because of more haphazard structural damage (crush), override, or buckling between cars. Structural damage tends to be focused on the colliding equipment and those cars that are immediately trailing. When passengers are in a leading cab car, structural damage can intrude into the occupied volume, resulting in a loss of survival space. Override is often associated with substantial loss of occupied volume and consequent fatality. The coupling arrangement between cars can lead to lateral buckling of the trainset. Examples of uncontrolled car-to-car interactions are shown in Figure 5.



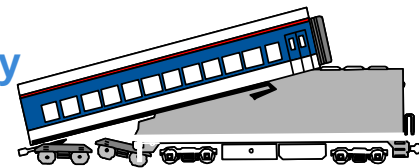
**Uncontrolled Crush:  
Focused on One Car**



**Uncontrolled Load  
Path: Derailment  
Lateral Buckling**



**Override: Carbody  
Overwhelmed**

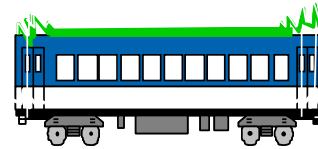


**Figure 5. Example of Uncontrolled Car-to-Car Interactions**

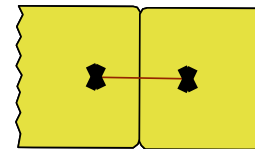
Although there are limitations to the amounts of energy CEM can safely handle, CEM helps to minimize these risks by using equipment structures that are designed to gracefully deform when overloaded. Within the capabilities of the CEM design, graceful deformation of the equipment structures allows override to be prevented, keeps the trailing equipment from buckling laterally, and distributes structural damage to the unoccupied areas of the train. Management of the impact interface is essential to preventing override. Such management can be effectively accomplished with a pushback coupler mechanism, a deformable anticlimber arrangement, an integrated end frame, and energy-absorbing elements. Pushback coupler mechanisms are effective in preventing lateral buckling of coupled equipment. Deformable anticlimber arrangements promote the engagement of vehicle ends, preventing override. Integrated end frames and energy-absorbing elements are essential to distributing crush to the unoccupied areas. Examples of controlled car-to-car interactions are shown in Figure 6.



**Controlled crush:  
Distribute crush  
through train**



**Control load path:  
Prevent lateral  
buckling**



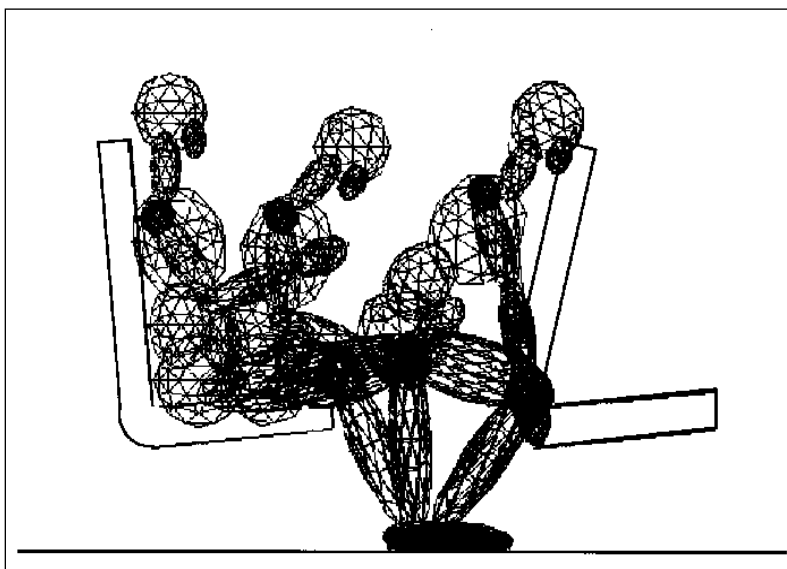
**Engagement:  
Prevent  
override**



**Figure 6. Examples of Controlled Car-to-Car Interactions**

### **2.2.3 Occupant Protection**

A primary collision is a collision that occurs when a moving train impacts another object. When this happens, the train occupants continue moving at the train’s initial speed while the train rapidly decelerates. A secondary impact occurs when an occupant collides with an interior surface, such as the seatback in the row ahead, as shown in Figure 7. An occupant may survive a collision with an interior surface (e.g., seat back, wall, or table) during an accident if the forces and accelerations are within acceptable human tolerance levels.



**Figure 7. Computer Simulation Illustrating Occupant Kinematics**

The methods of protecting occupants and minimizing the forces and accelerations they experience include controlling the deceleration of the vehicle, compartmentalizing the occupants, providing compliant impact surfaces, and using passenger restraints such as lap and shoulder belts. Vehicle deceleration is a function of the structural design of the carbody. The gentler the initial deceleration of the vehicle, the lower the speed at which the occupant will strike the interior. (**Section 3** discusses structural crashworthiness and occupant protection measures in detail, including strategies for controlling the initial deceleration of the cars in a train during a collision.)

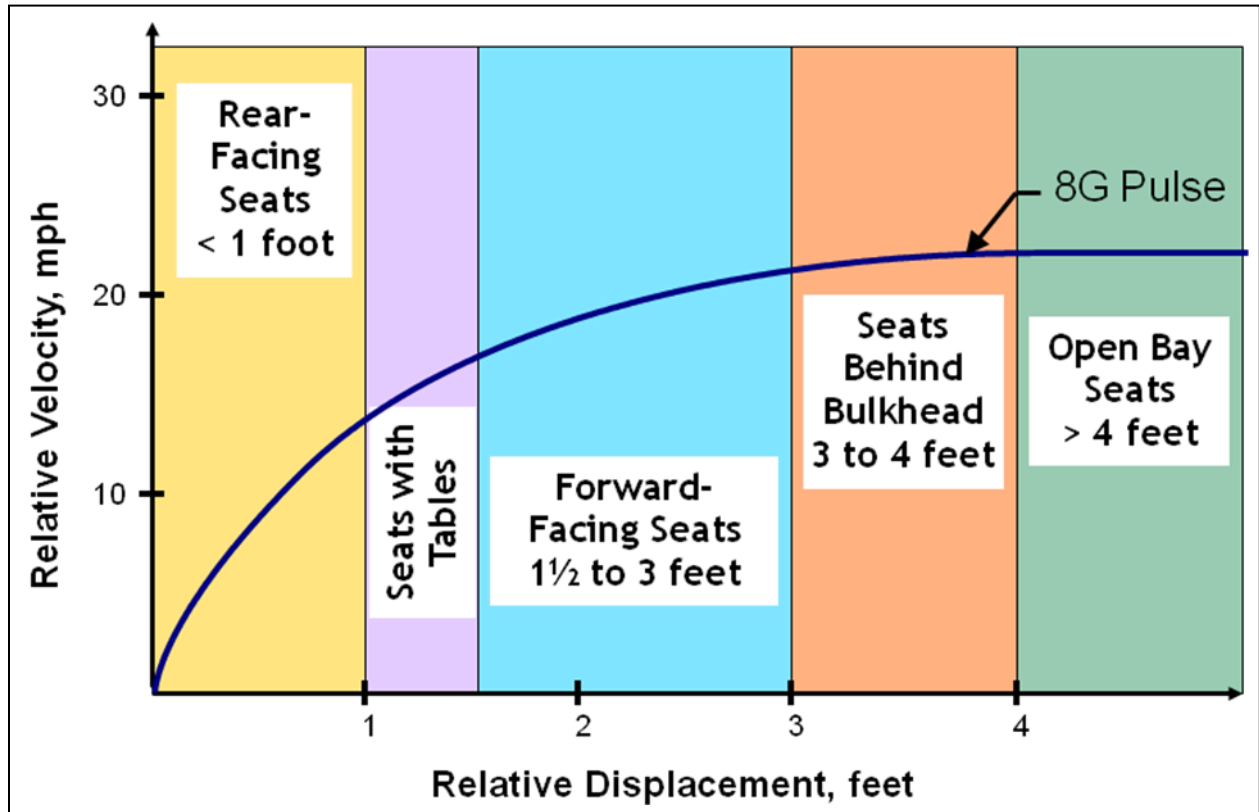
Compartmentalization is a strategy for providing occupant protection during a collision by limiting the occupant's range of motion. If the distance an occupant can travel in free-flight is limited, the occupant's speed relative to the interior can be limited, resulting in a more benign secondary impact. Compliant impact surfaces are those that are sufficiently soft and/or deformable, which can absorb energy and limit forces imparted to the occupant during the secondary collision. If the interior surfaces are made sufficiently compliant, the maximum forces and decelerations experienced by the occupant can be limited to human tolerance levels. Occupant restraints act to prevent or minimize the severity of secondary impacts with the interior and to secure the occupant to the mass of the car. Once the motion of the occupant is constrained, occupant impacts with interior surfaces can be avoided or limited to particular surfaces, which can be specifically designed to provide a less hostile impact.

The severity of the secondary impact is governed principally by two factors: the secondary impact velocity (SIV) and the force-deflection behavior of the impact surface. As described above, the SIV is generally a function of distance traveled, which is related to seating configuration. Figure 8 shows an SIV plot that corresponds to an 8g, 250-millisecond acceleration pulse.<sup>1</sup> The figure correlates SIV with the approximate travel distance associated

---

<sup>1</sup> The 8g crash pulse is specified for seat testing requirements in 49 CFR 238.233, Interior Fittings and Surfaces, and in APTA-SS-C&S-016, Revision 2, Standard for Passenger Seats in Passenger Rail Cars.

with various seating configurations. Typically, a shorter travel distance correlates to a lower SIV, because relative velocity generally increases with distance traveled.



**Figure 8. Representative SIV Plot Corresponding to Various Seating Configurations**

SIV can be used to assess the crashworthiness and occupant protection performance of different interior configurations. The plot in Figure 9 identifies SIV severity ranges and possible measures for minimizing the risk of injury. SIVs of less than 10 mph are generally survivable with conventional interior equipment. For SIVs between 10 and 25 mph, the interior environment is deemed survivable if compartmentalization is ensured, and passive safety modifications are provided in the seat and table designs. Above 25 mph, active protection features (i.e., air bags, inflatable structures, lap and shoulder belts, etc.) are necessary to mitigate the risk of injury.

FRA-sponsored occupant protection research has mostly focused on strategies of compartmentalization to reduce injury risk. SIV has been used during the research process to develop energy-absorbing seats and tables that would limit injury indices to within human tolerance levels during full-scale testing. Prior to testing, the longitudinal acceleration-time history, or crash pulse, of each car was predicted using a collision dynamics model. The crash pulse was integrated to calculate velocity and displacement, which were then cross-plotted to evaluate the SIV in each car for different seating configurations. The necessary force-deformation behavior of the seats and tables could then be calculated based on the estimated SIV.

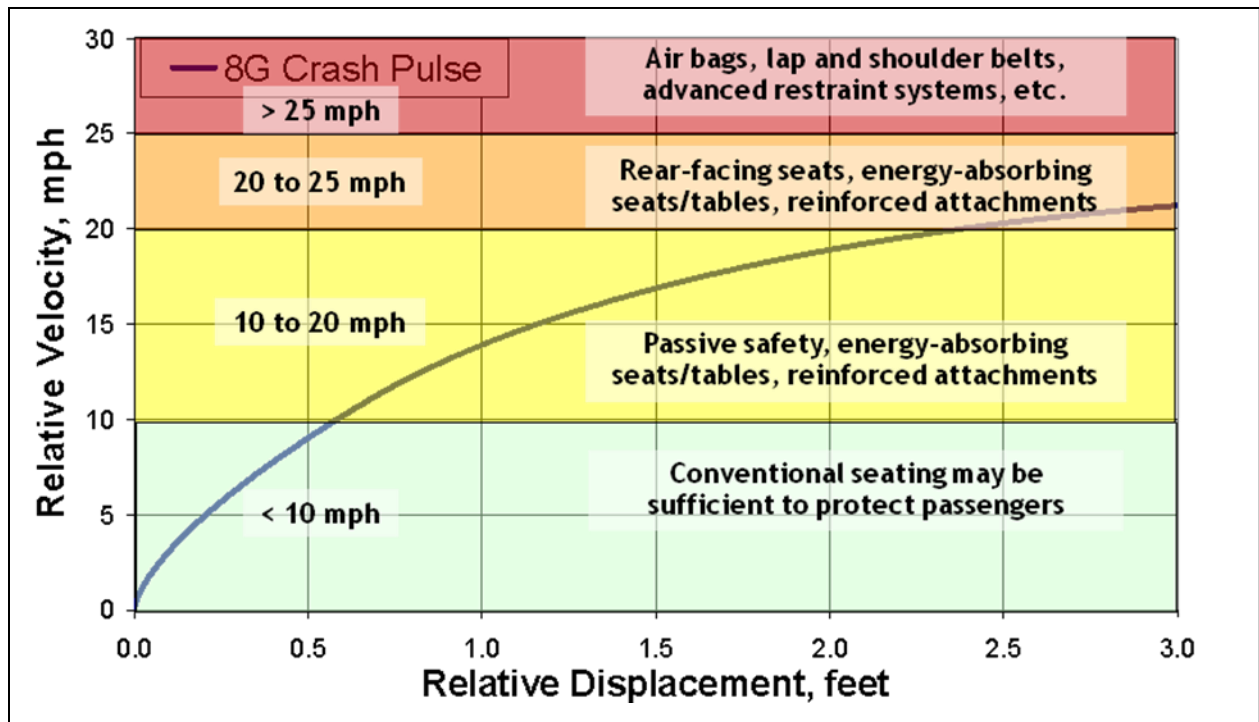
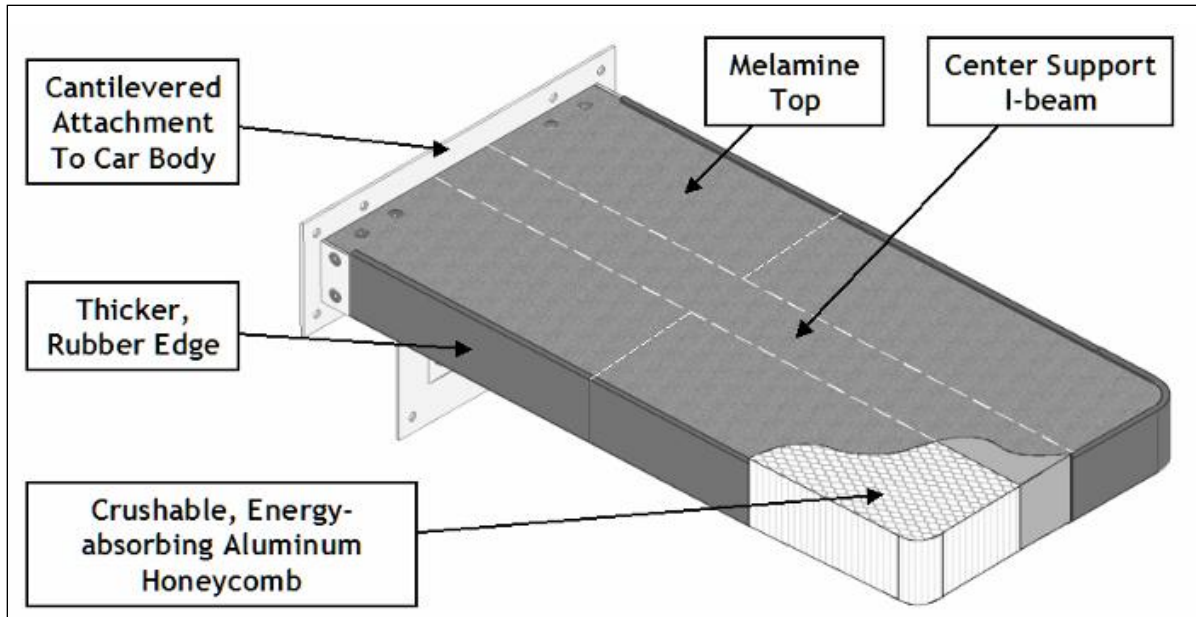


Figure 9. Example SIV Plot with Injury Interpretation

### Improved Workstation Tables

Strategies to mitigate the potential for injury due to impacts with workstation tables have been developed through a cooperative agreement between FRA and the Rail Safety and Standards Board (RSSB) of the United Kingdom [18]. RSSB and FRA have shared the results of ongoing work to improve the safety of passengers seated at tables. RSSB has loaned FRA its anthropomorphic test dummy (ATD), the H3RS. This test dummy includes abdominal sensors to measure the loads imparted by workstation tables under collision conditions. This test dummy has been used to measure the performance of a baseline table and an improved table during full-scale impact tests of CEM equipment.

The improved workstation table was designed to meet crashworthiness and occupant protection performance, functionality, and geometry requirements [18]. Several tables were fabricated and tested both quasi-statically and dynamically, including two occupant experiments on the full-scale train-to-train impact test of CEM equipment. Figure 10 shows a sketch of the table design.



**Figure 10. Design of an Improved Workstation Table**

This design builds from a center support I-beam, which is cantilevered from the car wall, and extends laterally from the wall to the aisle. The center support I-beam is designed to remain attached under the impact loads from two occupants during a collision to help ensure that the occupants remain compartmentalized. It also supports the table under service loads. The tabletop is constructed of a crushable, energy-absorbing aluminum honeycomb, oriented so that cells are aligned in the vertical direction. This allows for the table edge to achieve the target longitudinal force-crush characteristic while remaining stiff enough to meet the service load requirements. The melamine tabletop provides a rigid surface to preserve the functionality of the table. During impact, the melamine top is designed to separate from the honeycomb in such a manner that it will not adversely affect the force-crush characteristic. The rubber edge distributes the load from the melamine top and the aluminum honeycomb to provide a more benign impact surface to the occupants during a collision.

The workstation table was tested onboard the cab car in the CEM train-to-train test [17]—the test shown in the lower portion of Figure 4. The objective of the table experiments was to demonstrate the performance of this improved table design. The primary crashworthiness and occupant protection requirement is that the occupant is compartmentalized. A secondary objective was to evaluate the table against the crashworthiness and occupant protection design requirements. These requirements, determined during the development of the improved table, were designed to help ensure that the upper abdominal injury risk to the occupant is reduced without introducing other injury risks. The test dummy was outfitted with instruments to make the measurements needed to evaluate the potential for injury. A pretest MADYMO [18] computer model was used to simulate the occupant response for each table experiment using the predicted crash pulse from the pretest collision dynamics model [19]. All of the predicted measurements were below the maximum acceptable injury criteria values.

Figure 11 shows pre- and posttest photographs of a table test conducted as part of the CEM train-to-train test. The table remained attached to the car structure and compartmentalized the



occupants. The table edge performed as intended. The melamine top separated from the aluminum honeycomb and folded along the scored edges. The aluminum honeycomb crushed between 5 and 6 in, with a peak force of roughly 2,000 lb. This is a significant reduction from the peak load measured in the baseline table test. All of the computed injury criteria values were within accepted limits [18].



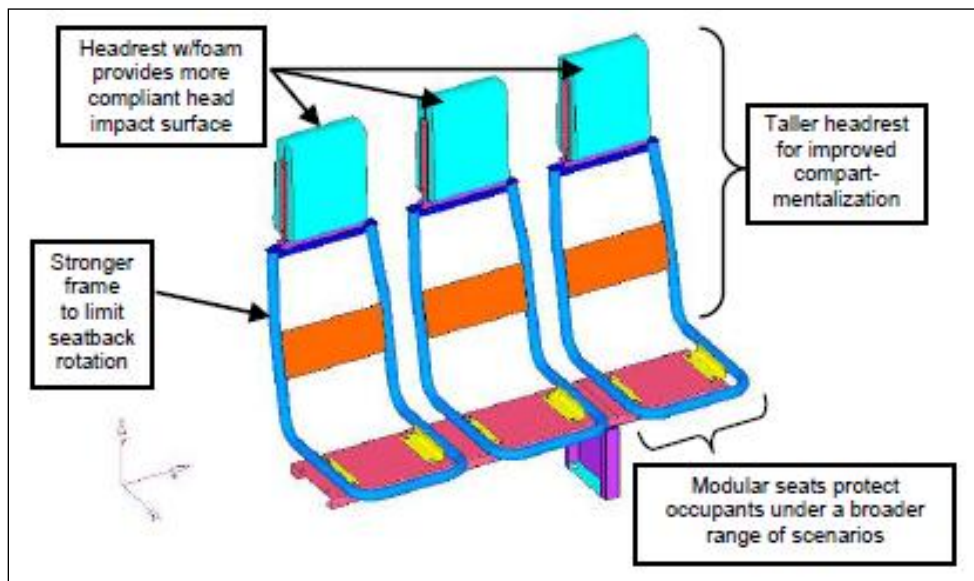
**Figure 11. Pre- and Posttest Photos of Table Test**

### **Improved Commuter Seats**

An optimized commuter seat was developed to help protect occupants under the severe collision conditions expected in the leading cab car of a CEM train-to-train impact test. The results from the two-car CEM test indicated that an improved seat design was necessary to meet occupant protection requirements in the leading cars of a CEM consist. Pretest computer modeling indicated that the SIV in the cab car of the CEM train-to-train test could approach 25 mph, depending on the seating configuration. For this reason, rear-facing seats were proposed in the cab car as a strategy to mitigate the high SIV in the lead car. Forward-facing seats were proposed in the first passenger car behind the cab car.

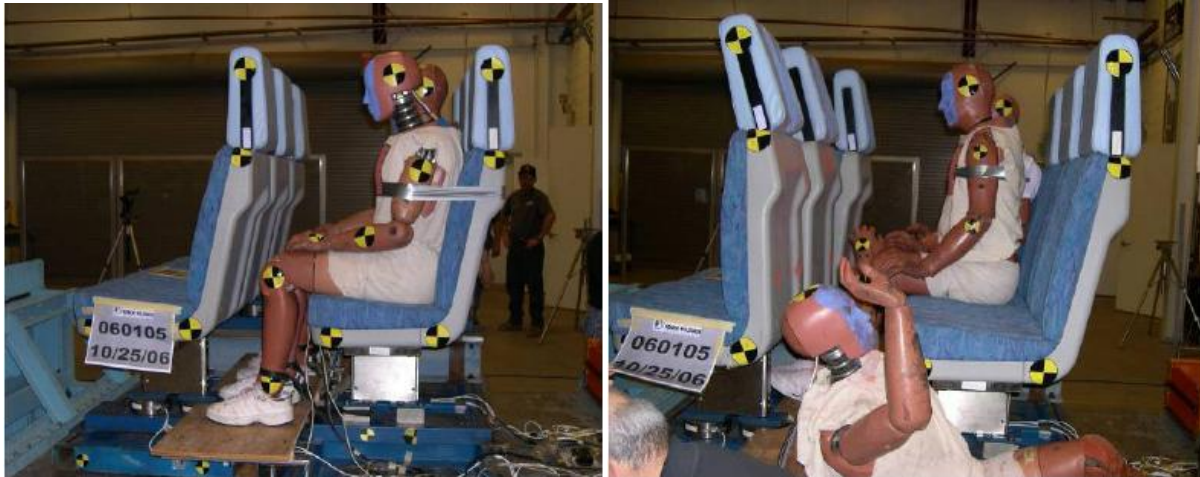
During development of the new seat, several requirements were established for occupant protection and seat performance under test conditions similar to those expected in the CEM train-to-train test [16]. To meet the occupant protection requirements, the ATDs must be compartmentalized, and the head, neck, chest, and femur injury criteria must be within the limits defined in 49 CFR Part 571, 208 - Occupant Crash Protection [21], which is used by the automotive industry. The standards in the APTA Standard for Row-to-Row Seating in Commuter Rail Cars [22] must also be met, which include seat performance criteria. The seat must remain attached to the test sled at all attachment points, and the permanent seat deformations must not significantly impede an occupant from standing and exiting the seat. Seat cushions must also remain fastened to the seat frame.

The new seat design is based on an existing two-passenger seat design that meets the APTA standard for row-to-row seating in commuter rail cars. The principal modifications to this design are a third passenger seat, stronger seat backs, taller headrests, and reinforced attachments to the floor and wall. When compared with the M-style seat, the prototype seat is stiffer, taller, and more modular, with padding on the head impact surface and a knee bolster to transfer loads from the knees into the seat frame. Figure 12 shows a schematic of the prototype seat structure.



**Figure 12. Schematic of Prototype Commuter Seat**

Sled tests were conducted using three instrumented ATDs in each test. The rear-facing seat was tested using a 12g, 250-millisecond (ms) triangular crash pulse, which approximates the collision conditions in the leading cab car of the CEM train-to-train test. The forward-facing seat was tested using the standard 8g, 250-millisecond triangular crash pulse, which approximates the collision conditions in the first passenger car behind the cab car. Figure 13 and Figure 14 show pre- and posttest photographs from the 8g forward-facing sled test and the 12g rear-facing sled test, respectively.



**Figure 13. Pre- and Posttest Photos of Forward-Facing 8g Sled Test**



**Figure 14. Pre- and Posttest Photos of Rear-Facing 12g Sled Test**

The final test results indicate that all test requirements were met: the seats remained attached to the test sled; the ATDs were compartmentalized; all the injury criteria were within defined tolerance thresholds; and all the seat cushions remained attached.

### **2.3 Technical Basis for Criteria**

The criteria are both the conditions to be evaluated and the metrics for assessment. One example is the traditional buff strength requirement [23] in which a load of 800 kip applied to the buff stops is the condition to be evaluated, and no permanent deformation is the assessment metric. Another example is FRA's Tier II CEM scenario [2] in which a collision at 30 mph with similar like train is the condition to be evaluated, and preservation of the occupied volume is the assessment metric. This style of criteria separates out the procedure used to evaluate the condition(s) and to determine the value of the metric(s). In theory, one could use either analysis or testing to evaluate either example.

The criteria are influenced by the current Tier I regulations [23], which apply to passenger equipment operated at speeds up to 125 mph, and by the current Tier II regulations [2], which

apply beyond 125 mph up to speeds not exceeding 150 mph. The criteria have also been influenced by European standards EuroNorm (EN) 12663 [24], which includes requirements for OVI, and EN 15227 [3], which includes requirements for CEM. Several different categories of equipment are addressed in the European standards. These categories are based on the equipment type and operating environment in revenue service. The CEM requirements of EN 15227 essentially overlay the traditional strength-based requirements in EN 12663. In a similar manner, the CEM specifications developed for Metrolink [1] overlay the current Tier I requirements [23]. Consequently, a train built to the Metrolink CEM specifications will meet the Tier I structural requirements. In addition, the Metrolink CEM requirements are intended to provide a level of crashworthiness that significantly exceeds the level provided by the Tier I requirements alone. Above these influences, the criteria and procedures were developed to take advantage of the latest technology in rail equipment crashworthiness.

The numerical values of the pass/fail criteria have been selected to provide a level of crashworthiness equivalent to the current Tier I regulations. In some cases, aspects of the regulations have been relaxed; others have been increased or supplemented. For example, the OVI requirements have been relaxed from the current regulations and criteria for preservation of the occupied volume for a collision with a conventional locomotive-led train have been added to compensate. In other cases, such as for roof integrity, the existing regulations can be applied to alternatively designed equipment and are unchanged.

Because the latest technology in rail equipment crashworthiness has been used to develop the criteria and procedures, aspects of the resulting criteria and procedures are fundamentally different from their corresponding regulations. Although technical results from sophisticated analyses and tests have been necessary, judgment was also needed to develop the criteria and procedures. This judgment was provided by ETF and ultimately accepted by FRA. ETF is a government/industry working group, organized under the auspices of RSAC [25]. This section summarizes the technical information that helped inform the ETF's judgments.

For describing the technical basis, the recommended criteria are grouped into three categories:

- Train-level
- Car-level
- Interior occupant protection

The train-level requirements are based on a train collision scenario. In the prescribed scenario, the space for the crew and passengers is to be preserved, the colliding equipment is not to override, coupled equipment is not to override, and the trucks are to remain attached. These requirements are significantly different from the existing Tier I regulations. Indeed, there are no specific train-level or scenario-based requirements in Tier I for crashworthiness.

The car-level requirements are intended to provide a robust occupied volume that can support the demands of the CEM features without being overloaded and can also preserve the occupied volume in a range of accidents, including highway-rail grade crossing collisions and derailments. These car-level requirements essentially correspond to the Tier I regulations, except for OVI. The OVI requirement is substantially different from the traditional 800-kilopound buff strength requirement. The traditional requirement can be difficult to apply to designs that differ from

traditional North American passenger car designs. The OVI requirement has been developed with the intent that it may be applied to a wide range of equipment designs.

The interior occupant protection requirements are based on APTA standards. FRA and APTA have worked together closely to develop these standards, and APTA has diligently applied the results of FRA's research in maintaining and updating them.

### 2.3.1 Train-Level

There are four train-level criteria:

- Scenario
- Colliding equipment override
- Connected equipment override
- Truck attachment

#### Scenario

In the scenario, shown in Figure 15, a cab car- or an MU locomotive-led alternatively designed train collides with a conventional locomotive-led passenger train. The principal requirement is that all of the space for the passengers and crew be preserved for a closing speed of 20 mph.



**Figure 15. Schematic of Collision Scenario**

The scenario criteria describe the information needed to compare the overall effectiveness of the OVI and other crashworthiness features of the alternatively designed equipment with the overall effectiveness of equipment designed to Tier I standards. In combination with the OVI criteria, the scenario criteria are intended to ensure that the space for the passengers and crew is preserved under moderately severe accident conditions. Uniquely for the scenario criteria, there is no directly corresponding FRA regulation.

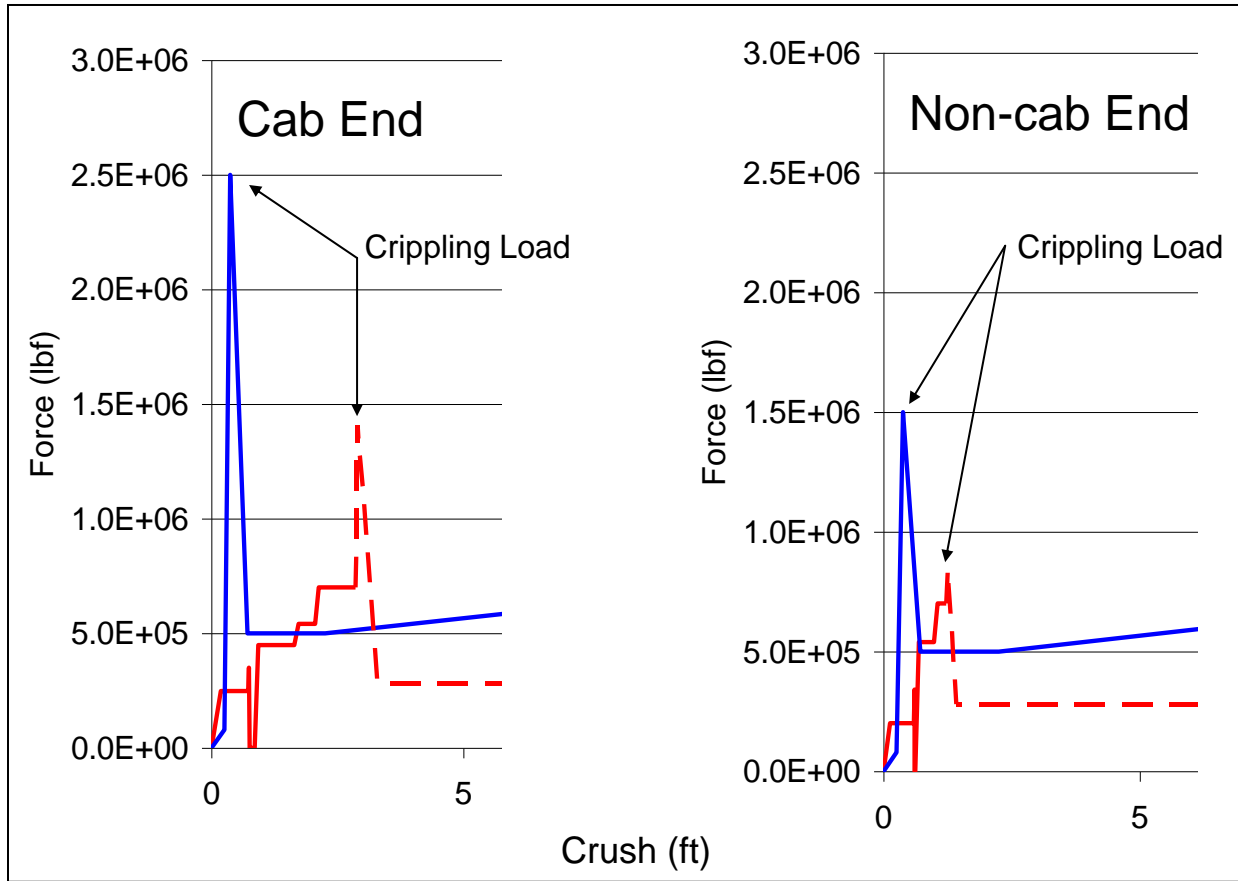
Tier I-compliant equipment performance in the prescribed scenario is dependent on a number of factors, including train makeup—whether the equipment is push-pull or MU and the number of cars in the consist [26]. The maximum collision speed for which all of the space for the passengers and crew is preserved for single-level equipment ranges from about 10 mph for a long train pushed by a locomotive to about 18 mph for a short MU train. There is some uncertainty in this range, and actual performance may be somewhat better or worse. The 20-mile per hour speed used in the scenario criteria, then, is an upper estimate of what Tier I-compliant equipment may achieve in the prescribed scenario.

Figure 16 shows a photograph from the accident that occurred in Placentia, CA, on April 23, 2002 [27]. In this accident, a locomotive-led freight train collided with a cab car-led passenger train at a closing speed of approximately 22 mph. Overall, 161 of the passengers and crew were transported to local hospitals. Two of these passengers sustained fatal injuries. Both of the passengers who sustained fatal injuries were seated in a facing seat configuration with an intervening workstation table. There was sufficient energy in this collision to cripple the structure of the impacting cab car. The majority of the structural deformation occurred at the rear of the cab car in the location of the stairwell. There was sufficient deformation that the passengers could not pass through that area and had to be evacuated through side windows. In essence, the conditions of this accident were just beyond the crashworthiness capabilities of this equipment.



**Figure 16. Aerial Photograph of Placentia Accident [27]**

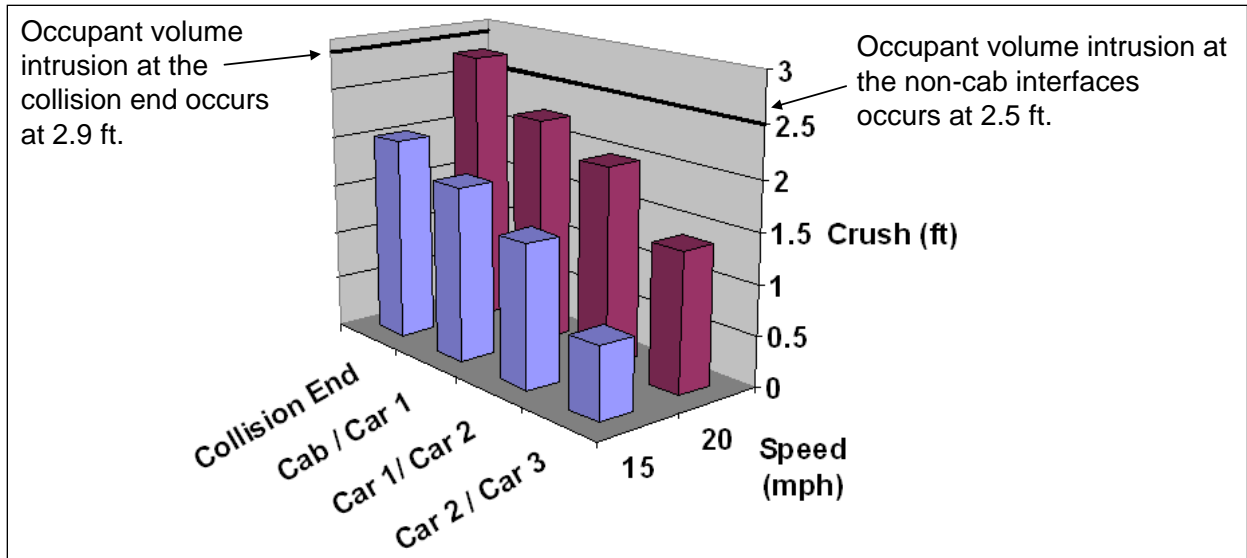
EN 15227-compliant equipment performance in the prescribed scenario has been estimated, based on information submitted, as part of a recent waiver request by Caltrain [28]. The crashworthiness of the EN-compliant equipment was evaluated using the same model as the Tier I-compliant equipment [26]. The primary inputs to the model are the masses of the equipment and the force-crush characteristics. The mass of the initially moving, EN-compliant train is 3,800 kip, and the mass of the Tier I-compliant locomotive-led train is 5,010 kip. The estimated force-crush characteristics are shown in Figure 17. As seen in the plots, the load required to cripple the Tier I-compliant equipment is greater than the load required to cripple the EN-compliant equipment. However, the energy required to cripple the EN-compliant equipment is greater than the energy required to cripple the Tier I-compliant equipment.



**Figure 17. Estimated Force-Crush Characteristics for Tier I-Compliant (blue) and EN-Compliant (red) Equipment**

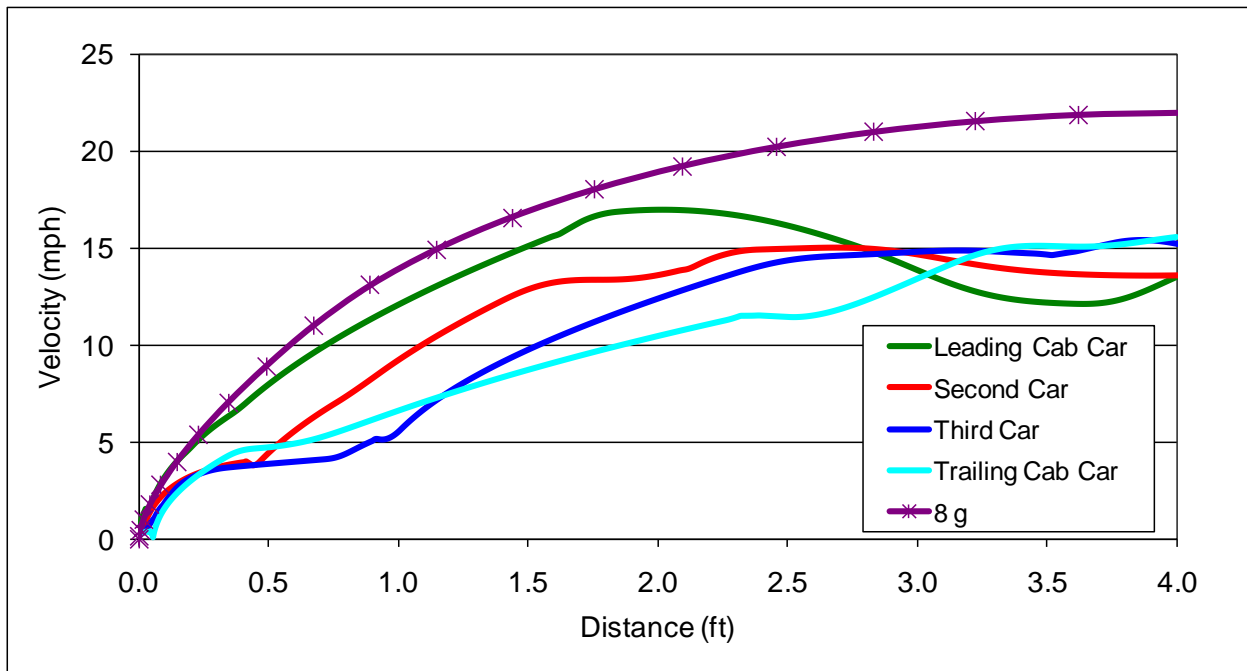
Figure 18 shows the distribution of interface crush in the EN-compliant train for collision speeds of 15 and 20 mph. For speeds up to 20 mph, there is no intrusion into the occupied volume. The energy-absorbing features are effective in keeping the load applied to the occupied volume below the load needed to cripple the structure.





**Figure 18. Distribution of Crush in the EN-Compliant Train in Prescribed Scenario, Closing Speeds of 15 and 20 mph**

Figure 19 shows the SIV at the center of gravity (CG) of each of the cars in the EN-compliant train for the scenario conditions at 20 mph. The plot also shows the SIV associated with the 8g deceleration pulse described in the Tier I requirements [23] and in the APTA standards [29]. The SIVs of the EN-compliant equipment for a 20-mile per hour closing speed collision are less than those associated with the 8g crash pulse. These results indicate that interior seats and other fixtures that are compliant with FRA regulations and APTA standards would be effective in protecting the occupants of the EN-compliant equipment.

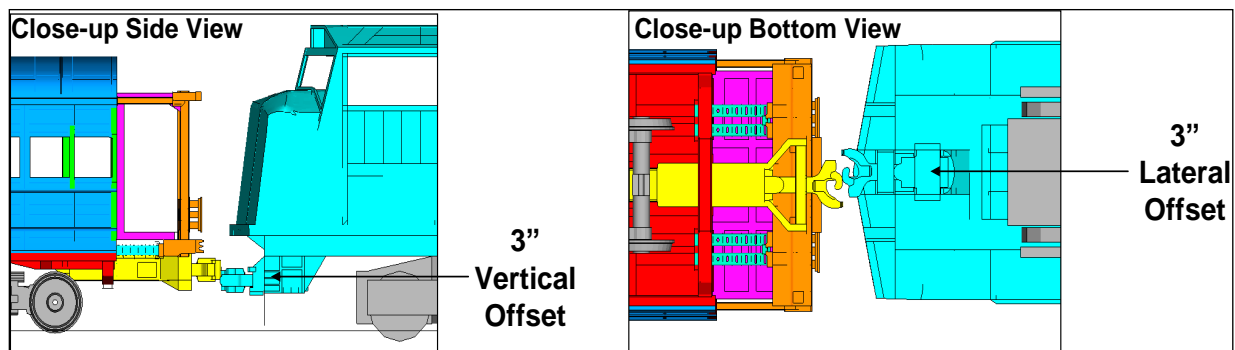


**Figure 19. SIV Plot for EN-Compliant Equipment**

The overall conclusion is that equipment compliant with the traditional strength-based requirements of EN 12663 and the CEM requirements of EN 15227 provides a level of crashworthiness in train-to-train collisions that is comparable to equipment compliant with the strength-based requirements of the Tier I regulations. There is a concern for high-energy collisions. If a cab car-led Tier I-compliant train were to collide with a cab car-led EN-compliant train at a speed greater than approximately 20 mph, the capacity of the CEM features would be exhausted. The stronger occupied volume of the Tier I-compliant train could allow it to potentially overwhelm the EN-compliant train. As a result, the EN-compliant train may lose a significant portion of its occupied volume; the extent of the damage would depend on how much the collision speed exceeds 20 mph. However, if two cab car-led Tier I-compliant trains were to collide at a speed above approximately 20 mph, one would likely override the other; again, the extent of damage would depend on how much the collision speed exceeds 20 mph. The overridden train may experience a significant loss of its occupied volume. In both cases, it is difficult to predict the outcome with confidence. As best as can be judged, the total consequences—injuries and fatalities—of either 20-mile per hour collision would likely be the same.

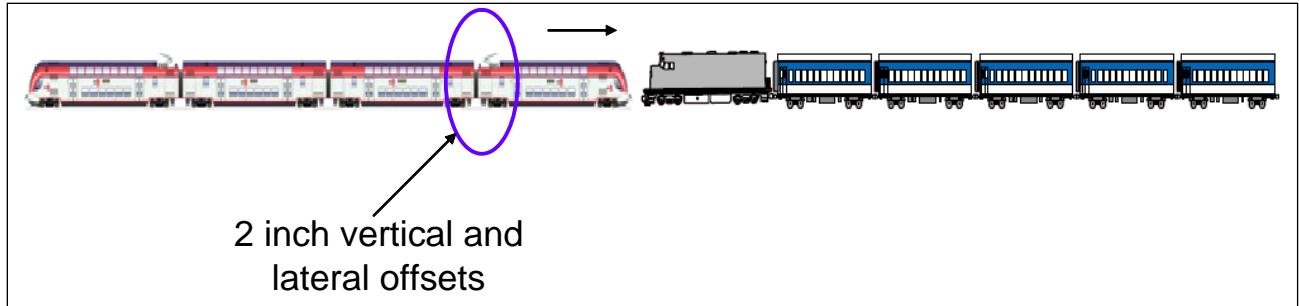
### Colliding Equipment Override and Connected Equipment Override

The colliding and connected car override criteria prescribe the kinematic behavior of the equipment for ideal and offset conditions. The ideal condition is that with the equipment positioned at its design height and centered on the track. The offsets for colliding equipment—3 in vertically and 3 in laterally—are based on the offsets used by Metrolink in procuring their equipment with CEM features [1]. The offset conditions are intended to help ensure that the override features are robust. The offset initial conditions are illustrated in Figure 20.

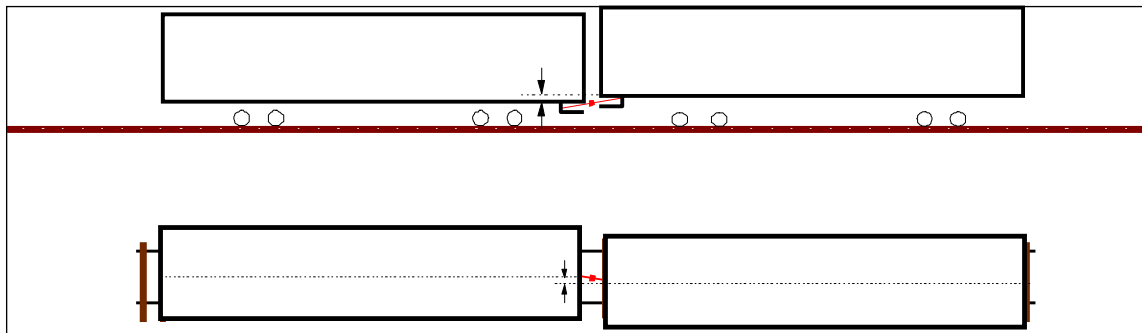


**Figure 20. Illustration of Offset Conditions for Colliding Equipment**

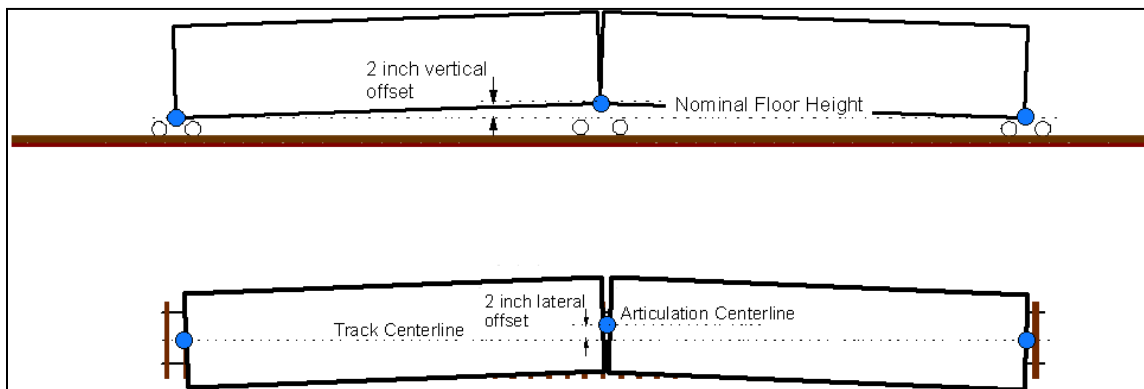
The lateral offset for connected pieces of equipment is based on the conventional and CEM two-car impact tests [30, 31]. The location of the prescribed connected car offsets is at the first connected interface in the train, as shown in Figure 21. These offsets have different influences on coupled equipment than on articulated equipment. Offset coupled equipment is illustrated in Figure 22, and offset articulated equipment is shown in Figure 23.



**Figure 21. Location of Offsets in Moving Consist: First Connected Interface**

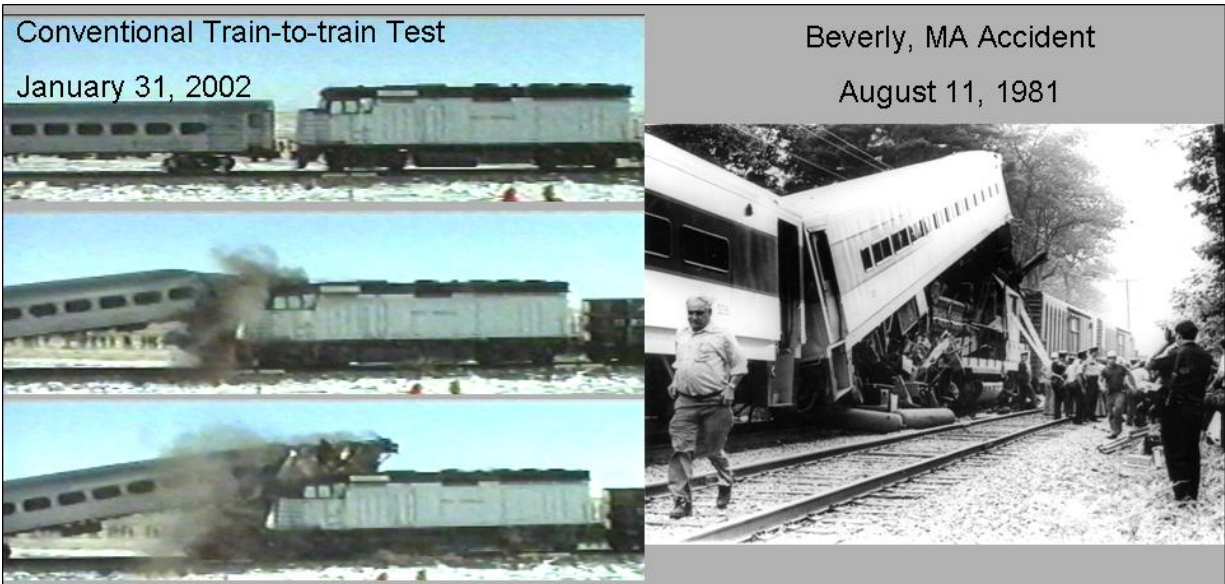


**Figure 22. Illustration of Offsets for Coupled Cars**



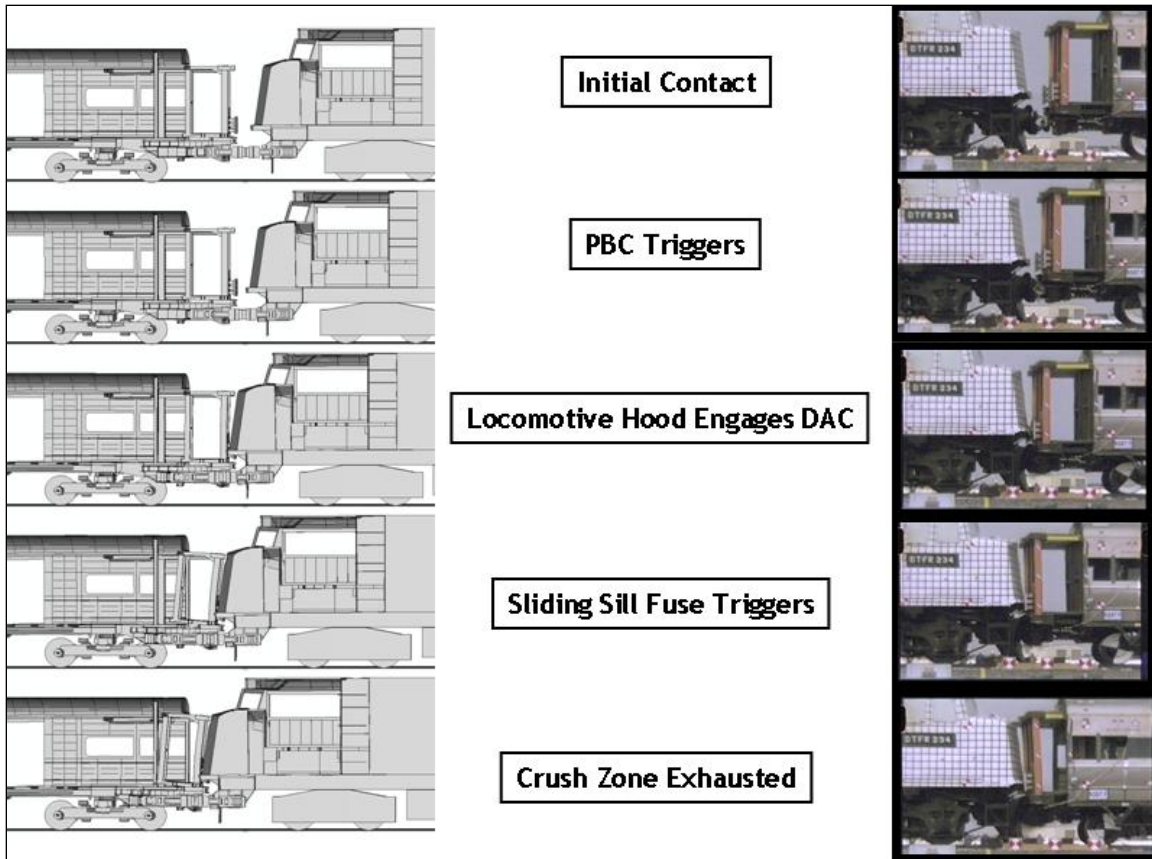
**Figure 23. Illustration of Offsets for Articulated Cars**

Figure 24 shows the interaction of colliding equipment for both a train-to-train test [15] and an actual train-to-train collision in Beverly, MA [32]. In both cases, the colliding cab car overrode the colliding conventional locomotive. The deformation mode observed in the test involved the end frame of the cab car engaging the short hood of the conventional locomotive. Deformation of the cab car structure behind the end frame led to the override. In essence, the underframe structure deformed into a ramp, allowing the cab car to override the conventional locomotive. Photographs from the Beverly, MA, accident indicate that the same mechanism allowed override in the accident as in the test. In both the test and the accident, the anticlimbing features were effective; the failure occurred in the underframe structures.



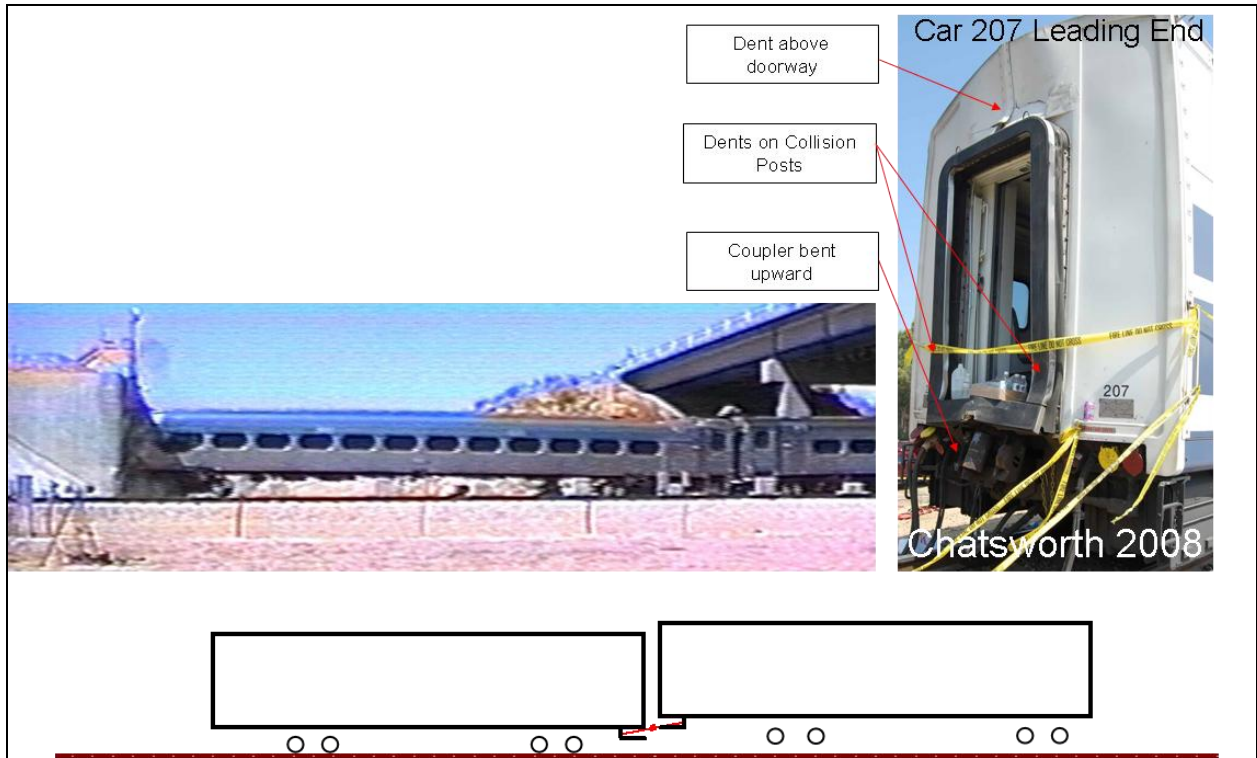
**Figure 24. Cab Car Interaction with Conventional Locomotive in a Collision**

Figure 25 shows analysis predictions and test images for the interaction of colliding CEM equipment [15]. The test conditions for the CEM equipment shown in Figure 25 are the same as the test conditions for the conventional equipment shown on the left in Figure 24. In both tests, a passenger train led by a CEM-equipped cab car moving at 30 mph collided with a standing conventional locomotive-led train of equal weight. As can be seen in both the analysis and test footage, the interaction of the colliding CEM equipment is very different from the colliding non-CEM equipment interaction shown in Figure 24. As suggested by the annotations in Figure 25, the sequence of events is different for non-CEM and CEM equipment. In this case, the CEM features increase the speed at which override would occur. For this particular equipment, the energy-absorbing features would be exhausted at some speed above 30 mph. Once this occurs, the main structure may be overloaded and may fail in a manner similar to the non-CEM equipment.



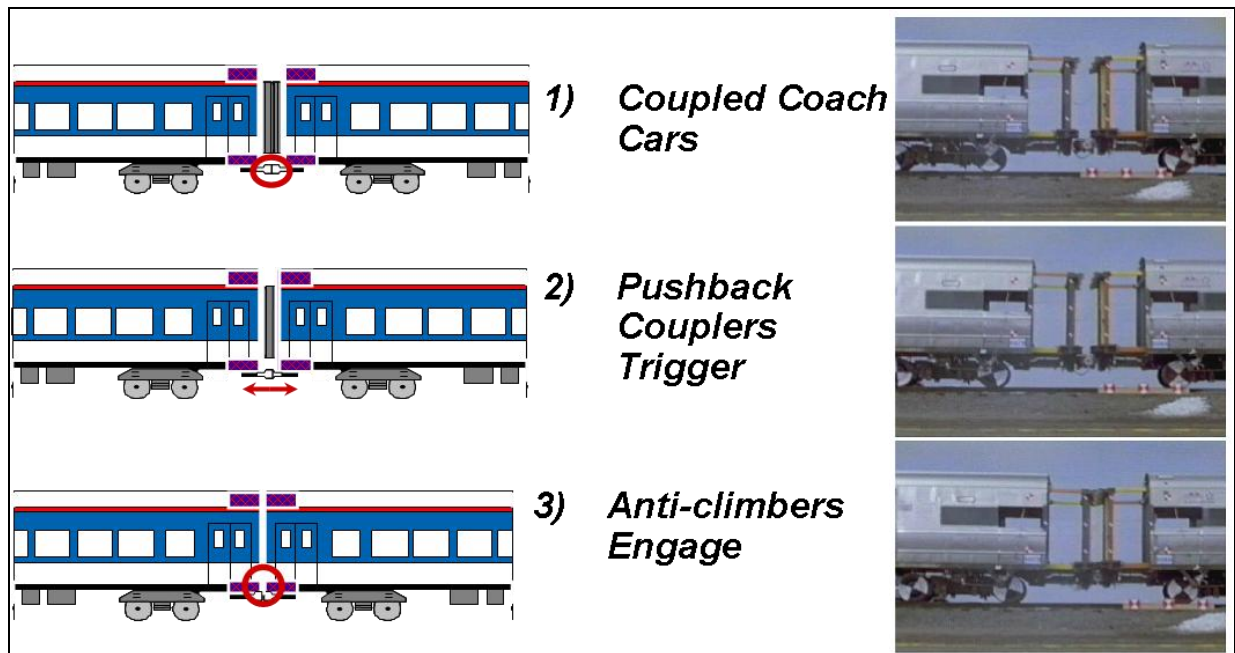
**Figure 25. CEM Cab Car Interaction with Conventional Locomotive in a Collision**

Figure 26 shows connected equipment interaction for both an impact test [15] and a train-to-train collision [34]. In both cases, override was inhibited, and the end structures of the two cars transferred load without any intrusion into the occupied volume. The end frames, however, did not fully align themselves. In both cases, the collision posts were essential to the transfer of load. The schematic at the bottom of the figure illustrates the misalignment observed in the test. The car as shown on the right of the schematic is attempting to override the car on the left. The vertical motion is arrested by the interactions of the couplers with the couplers' support structures. The longitudinal load is transferred from the end beam of the car on the right to the collision posts of the car on the left. The deformation damage seen in the car from the accident is consistent with the load supported by the car on the left in the schematic. Override between coupled passenger cars is rare in the United States; no known cases have occurred in more than 30 years.



**Figure 26. Non-CEM-Connected Equipment Interaction in a Collision**

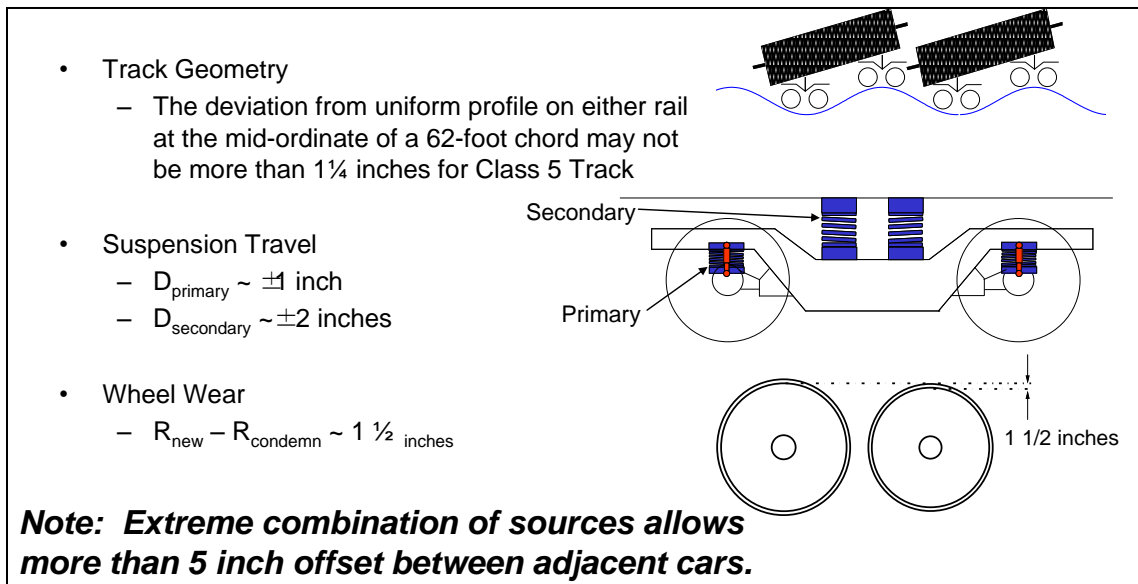
Figure 27 shows analysis predictions and test measurements for the interaction of connected CEM equipment [16]. For the CEM equipment, the end frames of the cars are aligned. For this design, vertical displacement is controlled by an interlocking anticlimber mounted on the end beam. Longitudinal load is transferred through the end beams and also through the antitelescoping (AT) plate at roof level. Similarly to the behavior of colliding equipment, the sequence of events for connected CEM equipment is different from the sequence for connected non-CEM equipment.



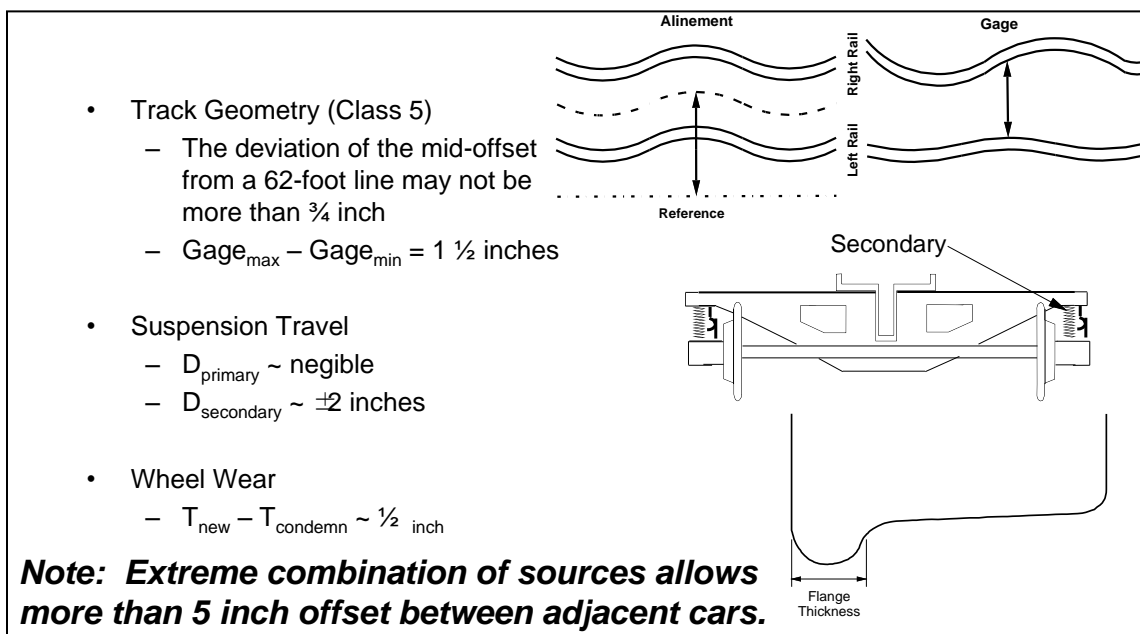
**Figure 27. CEM Connected Equipment Interaction in a Collision**

High longitudinal forces develop throughout the train during a collision. For both the colliding equipment and connected equipment, override occurs as a result of the vertical loads that develop because the high longitudinal loads are not perfectly aligned. Small pitch angles of the cars can lead to significant vertical loads. As the car structures deform, the vertical loads can increase in an unstable manner. Conventional practice for preventing climbing allows misalignments and provides for a high vertical load capacity. CEM is oriented toward minimizing the misalignments, thereby minimizing the vertical loads. Because the two approaches are fundamentally different, their specifications are different. Evaluating equivalence between anticlimbing features designed using conventional practice and those designed using a CEM approach involves technical judgment.

The potential for offset between colliding and connected equipment comes principally from three sources: variations in track geometry, suspension response, and wheel wear. These sources are illustrated in Figure 28 for vertical offsets and in Figure 29 for lateral offsets.



**Figure 28. Illustration of Principal Sources of Vertical Offset between Cars**



**Figure 29. Illustration of Principal Sources of Lateral Offset between Cars**

The colliding and connected equipment override criteria are fundamentally different from the corresponding FRA regulations. The regulations prescribe load capacity of particular features in their undeformed state. The criteria prescribe kinematic behavior; for the scenario conditions, the underframes must remain aligned within limits, and the wheels of the trucks must not lift from the rails by more than the specified limited amount as the CEM features of the car structure crush. Because of this fundamental difference in approach, it is difficult to assess equivalence in technical terms. In terms of intent, in promulgating the requirements, FRA stated: “The purpose of the anti-climbing mechanism is to prevent the override or telescoping of one passenger train

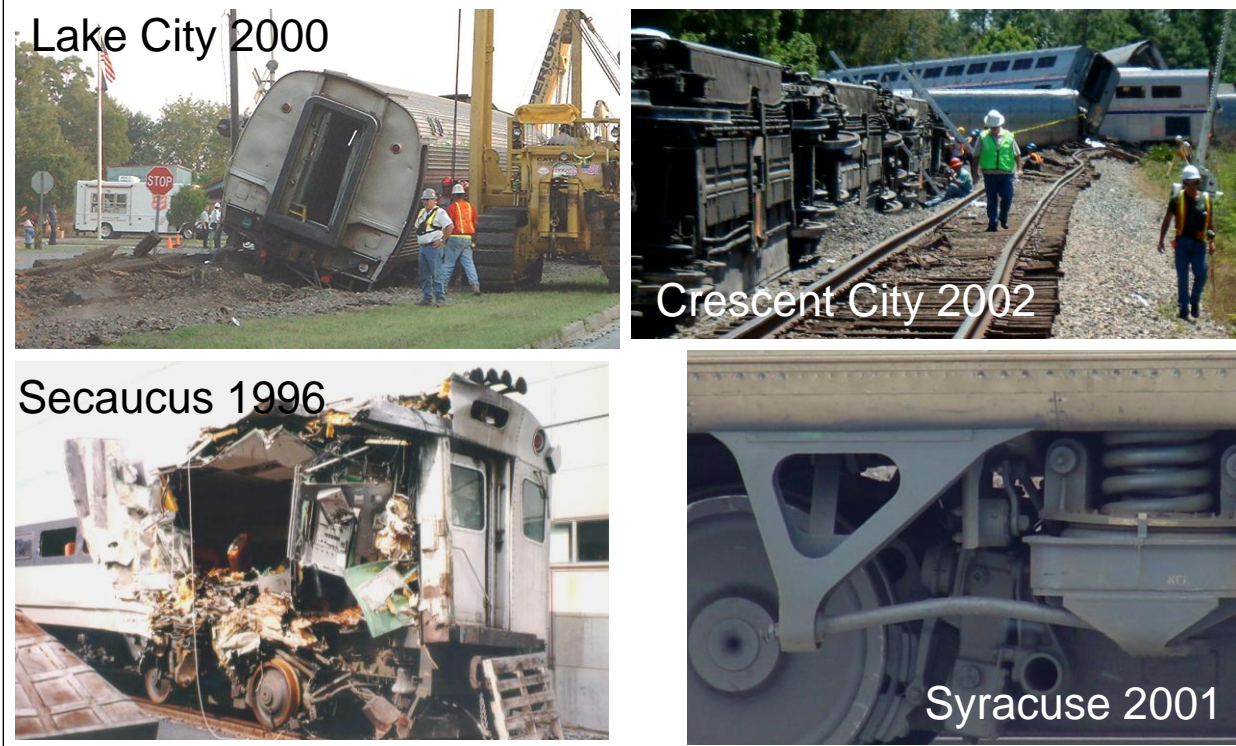


unit into another in a derailment or collision. . . . The potential for override to occur is influenced by the dynamic motions of the cars, the relative heights of the vehicles' underframes, and the changing geometry of the vehicles' structures as they crush during the collision. . . . While all three factors play a role in the occurrence of override, results of actual collisions indicate that the changing geometry of the car structures as they crush—which, in effect, creates a ramp during the collision—can overwhelm the influence of the difference in sill heights” [23]. The intent of the criteria is the same as the intent of the regulation, even though the technical approach is very different.

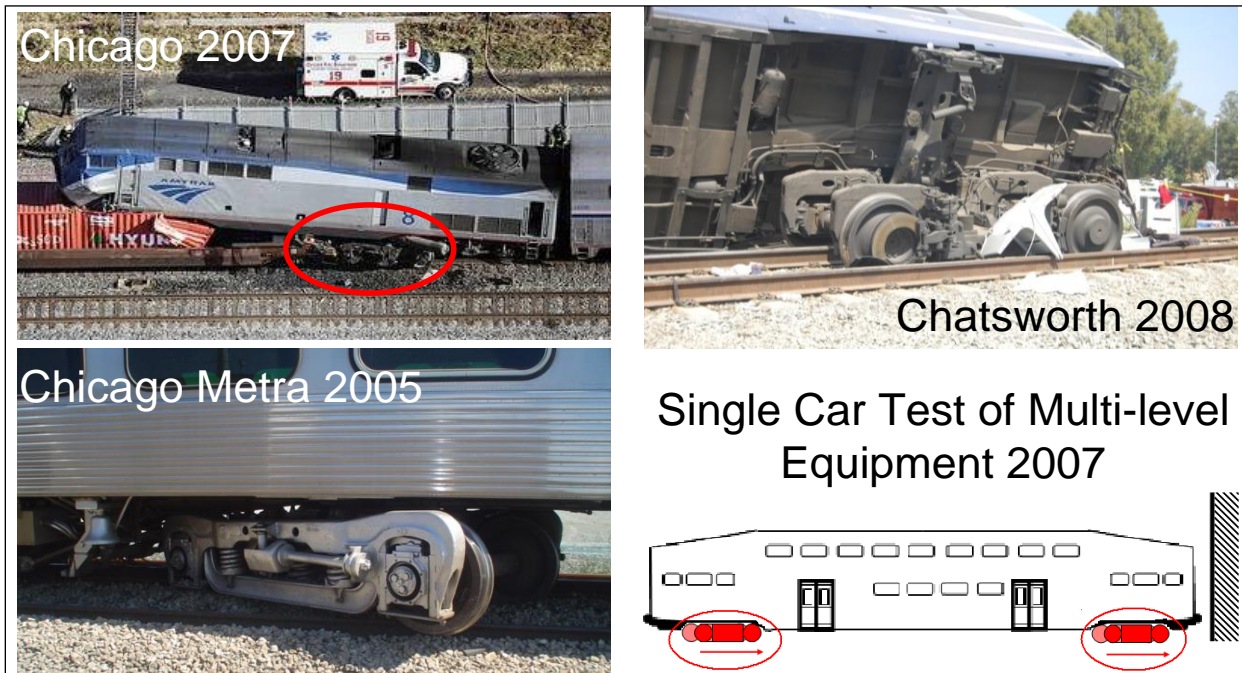
### **Truck Attachment**

The truck attachment criteria are based on the requirements of EN 12663 with the addition of a dynamic, longitudinal load requirement. In brief, for the scenario conditions, the dynamic requirement is that the average deceleration of the car should be less than 5g, and the peak deceleration of the truck should be less than 10g. The purpose of the dynamic longitudinal requirement is to ensure that the quasi-static load assumption is appropriate. As an approximation, about twice the permanent-deformation load is required to fail the attachment designed not to deform plastically [35]. Further, a dynamic amplification factor of 2 is typically used for linear elastic systems [36]. An attachment designed for a quasi-static load of 5g without permanent deformation should be able to support a dynamic load of 10g without failure.

Truck attachments compliant with Tier I requirements are effective in many accidents but have not been effective in retaining the trucks in all circumstances. Figure 30 shows accidents in which the trucks have remained attached. Figure 31 shows accidents and a full-scale test in which trucks have become detached.



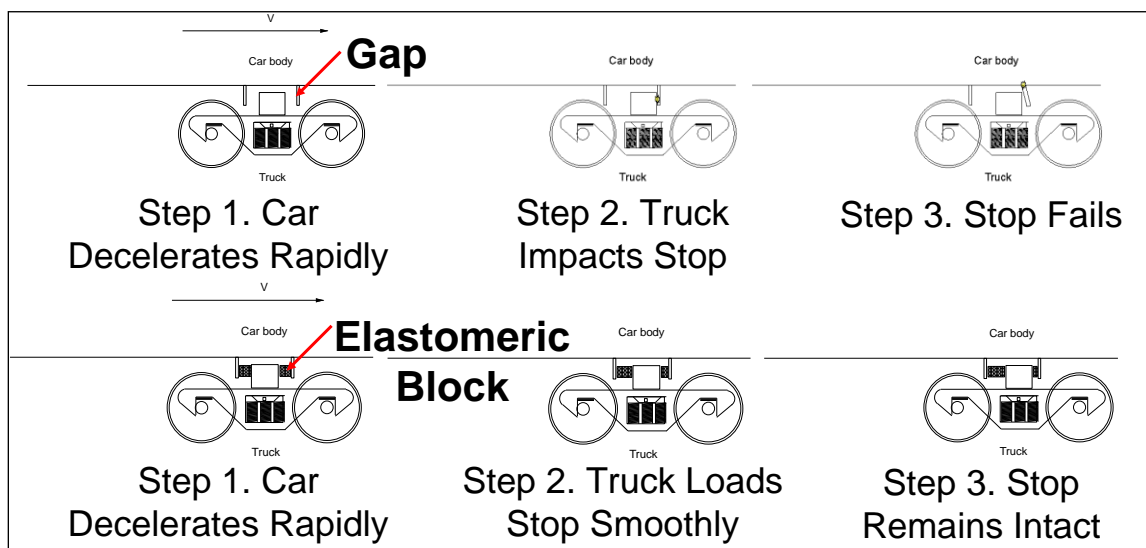
**Figure 30. Accident Conditions in Which Trucks Have Remained Attached**



**Figure 31. Accident Conditions in Which Trucks Have Become Detached**

Some of the accident conditions in which trucks remained attached are similar to accident conditions in which trucks became detached. The reason for detachment is not in the conditions but in the equipment. For some truck attachments, a relatively soft longitudinal suspension is used with a hard stop; for others, a relatively stiff longitudinal suspension is used with a stop. If

the suspension is initially soft, the stop can be loaded abruptly, which can cause it to fail. If the suspension is initially firm, then the stop is loaded more smoothly and is therefore less likely to fail. This difference in attachment is illustrated in Figure 32.



**Figure 32. Illustration of the Influence of Longitudinal Suspension on Suspension Stop Loading**

CEM features are unlikely to influence truck forces in a derailment or rollover. CEM features may increase the forces acting on truck attachments in a collision. Although CEM features may limit the peak acceleration acting on the carbody, the force acting on the truck is more closely related to the average deceleration. The load between the carbody and the truck is determined by the impulse imparted to the truck, which is related to the average deceleration of the carbody. Because CEM features act to increase average deceleration to better preserve occupied volume [37], the inclusion of CEM features may increase the severity of the impulse imparted to the trucks in a collision.

In promulgating the current requirements, FRA stated: “Whether the truck separates from the car body if the car rolls over, or . . . from being sheared off, the truck may become a hazardous projectile. . . .” For the 2g vertical load requirement specifically, FRA stated: “The intent . . . is to prevent the truck from separating from the car body if it is raised or rolls over.” For the 250,000-pound load requirement in any horizontal direction, FRA stated: “The fundamental reason . . . is to prevent the truck from shearing off. . . . This force may be possessed by one rail vehicle . . . as it collides with the truck of another rail vehicle. . . .” [23].

Table 2 summarizes and compares the requirements of the CFR and the criteria for truck attachment. Overall, the criteria for truck attachment are intended to be equivalent to the current requirements, but there are differences in the longitudinal, lateral, and vertical requirements.

**Table 2. Summary of CFR Requirements and Criteria for Truck Attachment**

<b>Direction</b>	<b>CFR</b>	<b>Criteria</b>
Longitudinal	Load: 250 kip Pass/fail: Remains attached	<i>Option A</i> Load 1: 5g quasi-static Pass/fail: No plastic deformation  Load 2: Dynamic crash pulse, calculated in scenario Pass/fail: Average deceleration $\leq 5g$ , Peak deceleration $\leq 10g$
		<i>Option B</i> Load: Dynamic crash pulse, calculated in scenario Pass/fail: Truck remains attached
Lateral	Load: 250 kip Pass/fail: Remains attached	Load: 1g quasi-static Pass/fail: No plastic deformation
Vertical	Load: 2g static Pass/fail: Remains attached	Load: 3g quasi-static Pass/fail: No plastic deformation

**Longitudinal**

Under some circumstances, the individual criteria may be more stringent than the CFR requirements; in other circumstances, the individual CFR requirements may be more stringent. For equipment such as Metrolink’s current multilevel equipment and most of Metra’s gallery-style equipment, the criteria are intended to be more stringent. For equipment such as Amtrak’s Amfleet I and II cars, the CFR is more stringent. If the truck attachment is resilient, as it is for the Amfleet equipment, then the criteria are less stringent. If the truck attachment is initially soft with a hard stop, as it is for the Metrolink equipment, then the criteria are more stringent.

**Lateral**

The CFR is more stringent than the criteria. The criteria would result in truck attachment failure for loads between 20 and 40 kip for trucks weighing between 10 and 20 kip, with the assumption that the failure load is twice the load required for plastic deformation. The rationale for using a lower lateral load comes from accident investigations. Damage observed in these investigations indicates that the longitudinal loads on the truck during an accident are greater than the lateral loads. The truck failures that have been observed are primarily because of the longitudinal loads. In some accidents, lateral load has contributed to attachment failure, but the damage suggests that its contribution is small compared to the longitudinal load.

**Vertical**

The criteria are more stringent than the CFR, requiring a load somewhere between 60 and 120 kip for truck attachment failure.

Overall, the criteria for truck attachment are intended to be equivalent to the current regulation; some aspects are more stringent, and other aspects are less stringent than the current CFR

requirement. The longitudinal criteria are expected to be more effective than the current regulation, the lateral criteria are expected to be less effective, and the vertical criteria are expected to be the same. The sum is expected to be at least the same, if not even a bit better, as most truck attachment failures occur primarily as a result of an excessive longitudinal load.

### **2.3.2 Car-Level**

There are six car-level criteria:

- OVI
- End frame strength, cab end
- End frame strength, noncab end
- Side strength
- Roof strength
- Fluid entry inhibition

### **Occupied Vehicle Integrity**

Preservation of occupied volume is essential to the crashworthiness of any rail car. The regulation and standards governing this aspect of the car include a strength-based design requirement for the car to support a quasi-static load of 800,000 lb along the line of draft without experiencing permanent deformation. Because conventional passenger rail cars carry both the service and collision longitudinal loads along the line of draft, the regulations require a minimum elastic resistance to a load along that load path. The load specified in the regulations is readily applied to cars with a traditional buff stop arrangement and an apparent line of draft. However, application of this load presents some difficulty for vehicles without conventional buff stops, a difficult-to-define line of draft, or a collision load path that differs from the service load path.

A strength-based approach was used in developing the options in the OVI criteria for alternatively designed equipment. Car-level OVI requirements are designed to work in concert with the train-level scenario to ensure that the space for the passengers and crew is preserved in moderately severe accident conditions. In addition, as two of the options allow permanent deformation to occur, it is anticipated that analysis will be used to demonstrate that a car meets a particular option. Analysis requires proper validation through nondestructive testing of the vehicle undergoing evaluation. Testing and analysis procedures are discussed in detail in **Section 4 – Procedures**.

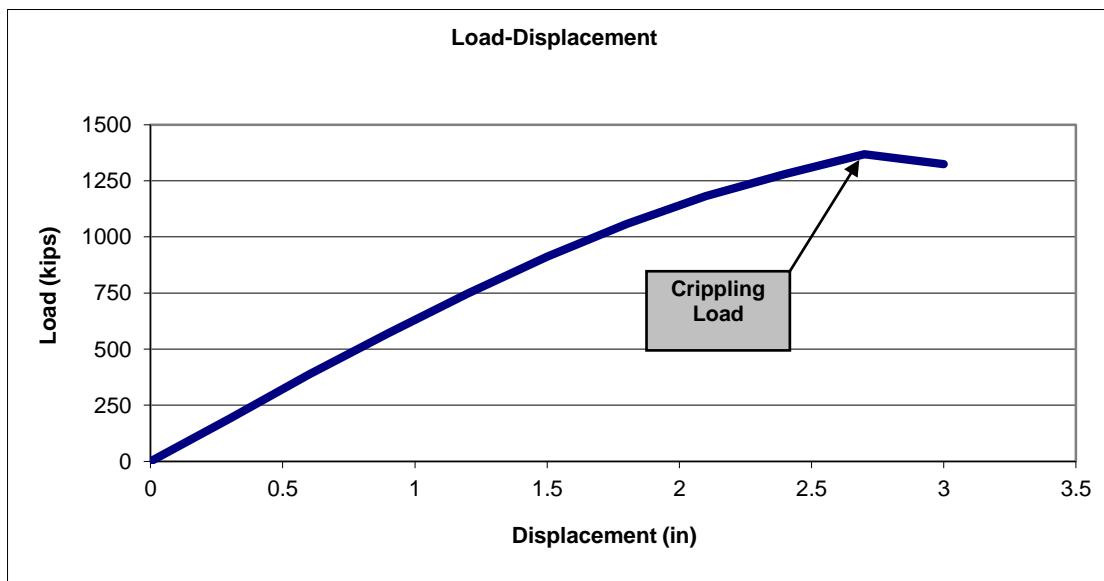
To recognize the variety of designs currently operating in other parts of the world (e.g., high-floor, partial-low floor, coupled, articulated, EMU, DMU, multilevel, etc.), the OVI criteria options were designed to be readily applied to a variety of designs. Rather than placing the load along the line of draft, the options all recommend that the load be placed along the collision load path. This load placement ensures that the OVI is evaluated in a manner based on the way it will be loaded during a collision. The three options were developed to help ensure a comparable level of OVI among vehicles meeting any one option. A design needs to demonstrate that it meets at least one of the three options, or it otherwise must comply with the regulation itself.

Option A requires a carbody to support a quasi-static load of 800,000 lb applied along the collision load path without permanent deformation of the body structure. This option is most

closely related to the U.S. requirement of 800,000 lb applied along the line of draft. However, as alternatively designed equipment may feature a nonconventional line of draft load path, particularly for collision loads, the load is applied to the collision load path as determined by the manufacturer. The locations where high longitudinal loads can be applied to the carbody structure are determined as part of the design development. Because the applied load is the same magnitude as the load required by the existing regulation, the pass/fail criterion of no permanent deformation throughout the body structure is the same as in the regulation.

Option B requires a carbody to support a quasi-static load of 1,000,000 lb applied along the collision load path with a limited amount of permanent deformation. This load is 25 percent higher than the 800,000-pound load required by the regulation. Because the load magnitude has been increased, the pass/fail criterion allows some permanent deformation under this loading condition. Permanent deformation is limited to 5 percent plastic equivalent strain throughout the occupied volume. Additionally, no 15-foot section of occupied volume may decrease in length by more than 1 percent. Values chosen for “limited permanent deformation” were developed based on analyses performed on conventional and alternatively designed passenger equipment under the given load.

Option C requires a carbody to support a quasi-static load of 1,200,000 lb applied along the collision load path without crippling the body structure. Crippling of the body structure has been defined as the largest load the occupied volume can support. This value is indicated by the peak on a load-displacement characteristic. An example load-displacement characteristic, with crippling load indicated, is shown in Figure 33.



**Figure 33. Example Load-Displacement Characteristic Indicating Crippling Load**

This load is 50 percent larger than the 800,000-pound load required by the regulation. A large load value was chosen to provide a safety margin over the minimum elastic load met by Tier I-compliant equipment. The load magnitude was chosen based on analysis of the capabilities of conventional and alternatively designed equipment.

### **End Frame Strength, Cab-End**

The end frame strength requirements consist of multiple regulations. These regulations include requirements for the strength of collision posts (49 CFR 238.211) and corner posts (49 CFR 238.213). The intent of the end frame strength requirements on the cab end is to prevent occupied volume intrusion from objects impacting the end of the car above the level of the underframe [38]. Figure 34 shows the lead MU cab car from a collision in Portage, IN. The MU train struck a truck transporting steel coils at a highway-rail grade crossing. One coil penetrated the occupied volume through the end frame, resulting in three fatalities.



**Figure 34. Lead Cab Car after Striking Truck at Highway-Rail Grade Crossing (Portage, IN – 1998)**

An option is presented to allow vehicles without conventional corner and/or collision posts to demonstrate an equivalent level of intrusion prevention. The specified option applies Appendix F of 49 CFR Part 238 to both the corner and collision posts, respectively. Appendix F includes performance requirements for dynamic testing of the corner and collision post structures as well as target levels of energy absorption for each post. The requirements of Appendix F are applicable to a variety of end-structure geometries and not just those resembling conventional end frame designs. A combination of testing and analysis may be used to demonstrate that a design meets the requirements of Appendix F, with any difficult-to-analyze or critical-to-performance components being tested.

### **End Frame Strength, Noncab-End**

Noncab end frame strength is also covered by multiple regulations. There are regulations for corner posts of specified design (§ 238.213) and collision posts of specified design (§ 238.211). As an option to the collision post requirements, a vehicle design with pushback couplers and interlocking anticlimbers capable of preventing coupled vehicles from climbing and overriding each other does not require collision posts at the interior coupling location. The collision posts on these noncab ends serve principally to prevent intrusion by the coupled car in case of override. If this mode of deformation has been eliminated through pushback couplers and anti-climbers, collision posts are not required.

Corner posts serve a somewhat different function from collision posts on noncab ends. Although they can act along with collision posts to prevent an overriding car from compromising occupied volume, corner posts also serve to prevent loss of occupied volume when struck by another train or a wayside obstruction. In particular, corner posts are effective at preventing intrusion by an object dragging along the side of the train consist. Figure 35 shows a postaccident photo from a 1997 accident in Gary, IN, in which the locomotive-hauled passenger consist struck a truck at a grade crossing. The truck damaged the side of the leading locomotive and the leading corner of the first trailing coach.



**Figure 35. Corner and Side Damage to Trailing Coach (Gary, IN – 1997)**

The option for corner posts requires some structure at the corners of the occupied volume capable of resisting intrusion. However, this structure does not have to be a post, per se. The design loads that are applied to the corner post (as part of the regulation) on a Tier I-compliant



design can be applied to the corner structure on an alternatively designed vehicle. The structure must be capable of meeting the requirements of the design loads specified in the regulation. A combination of testing and analysis may be used to demonstrate that a design meets the requirements, with any difficult-to-analyze or critical-to-performance components being tested.

### Side Strength

The side strength regulations are intended to “help to resist penetration of the passenger car’s side structure by an outside object” [23]. Localized penetration can be the result of a highway-rail grade crossing collision in which a highway vehicle impacts the side of the train or of a raking collision between two trains on adjacent tracks. The side structure stiffness requirement also offers resistance to global crush during a derailment in which a passenger car may end up on its side. Figure 36 shows damage to the side structure of an MU locomotive that had struck construction equipment that was fouling the right-of-way. The construction equipment was initially struck by the corner post of the MU locomotive but caused damage along the length of the sidewall. This accident occurred in Hewlett, NY, in 2001.



**Figure 36. MU Side Structure Damage after Striking Construction Equipment (Hewlett, NY – 2001)**

The side strength criteria do not specify an option to the regulation. The regulation consists of design requirements prescribing a minimum section modulus for the side structure about a transverse axis and a minimum section modulus about a vertical axis. The regulation also prescribes a minimum thickness of material, which may be used for the side sheathing with an allowance for thinner material of higher strength.

## **Rollover Strength**

The rollover strength requirements are intended to prevent intrusion into the occupied volume in the event of a rollover in which the vehicle is being supported by the roof structure or the side structure [23]. The roof strength criteria do not specify an option to the regulation. The regulation consists of two performance requirements to help ensure adequate strength in the event of vehicle rollover. The first requirement is for the side structure to support the weight of the vehicle without exceeding one-half its yield or critical buckling stress, whichever is less. The second requirement is for the roof structure to support the weight of the overturned car with damage limited to the roof sheathing and framing. Additionally, throughout the other structural members of the occupied volume, the stress may not exceed one-half the yield or critical buckling stress, whichever is less. Figure 37 shows a derailed car supported on its roof and side structure from a derailment that occurred in Nodaway, IA, in 2001.



**Figure 37. Derailed Car Supported by its Roof and Side Structures (Nodaway, IA – 2001)**

## **Fluid Entry Inhibition**

This requirement applies specifically to the lead vehicle in the train. The purpose of the requirement is to protect the occupied volume of the cab, particularly against fluid entry resulting from a grade-crossing collision [23]. In grade crossing collisions between cab car- or MU

locomotive-led trains and highway vehicles transporting bulk liquid commodities, there is a potential for the fluid to enter the occupied volume of the car.

The fluid entry inhibition criteria do not specify an option to the regulation. The regulation allows for some variation in design and materials for the end structure of the car, so long as the overall combination of material thickness and strength is equivalent to the specified value. See 75 FR 1180, 1217 (Jan. 8, 2010).

### **2.3.3 Interior Occupant Protection**

There are two occupant protection criteria:

- Interior fixture attachment
- Occupant protection features

#### **Interior Fixture Attachment**

The interior fixture attachment requirements are intended to help ensure that fixtures mounted to the walls, ceiling, or floor in occupied areas do not detach during an accident and become projectiles that could impact occupants. Furthermore, fixtures that remain attached may assist in compartmentalizing occupants during an accident, preventing tertiary impacts with other occupants or objects. There are no specified options for complying with the interior fixture attachment criteria. The Federal regulations in 49 CFR 238.233 apply to all Tier I equipment, regardless of design.

The following FRA regulations related to interior fitting attachment may also apply:

- § 229.45 – General condition
- § 229.119 – Cabs, floors, and passageways
- § 229.135 – Event recorders
- § 238.115 – Emergency lighting
- § 238.117 – Protection against personal injury
- § 238.121 – Emergency communication
- § 238.221 – Glazing
- § 238.223 – Locomotive fuel tanks
- § 238.225 – Electrical system
- § 238.307 – Periodic mechanical inspection of passenger cars and unpowered vehicles used in passenger trains

The following APTA standards related to interior fitting attachment may also apply:

- APTA SS-C&S-006-98, Rev. 1 – Standard for Attachment Strength of Interior Fittings for Passenger Railroad Equipment
- APTA SS-C&S-011-99 – Standard for Cab Crew Seating Design and Performance
- APTA SS-C&S-016-99 Rev. 2 – Standard for Passenger Seats in Passenger Rail Cars
- APTA SS-C&S-034-99, Rev. 2 – Standard for the Design and Construction of Passenger Railroad Rolling Stock

These APTA standards constitute the industry standards for interior fitting attachment strength, and FRA looks to these standards as complementary to FRA's requirements. See 64 FR 25540, 25541 (May 12, 1999). APTA's standards on interior fitting attachment strength are generally more specific than FRA's requirements.

### **Occupant Protection Features**

The occupant protection features criteria are intended to provide minimum seat requirements related to seat attachment strength, human injury criteria associated with dynamic seat testing, and flame and smoke standards. These criteria are specified in APTA SS-C&S-016-99, Rev. 2 – Standard for Passenger Seats in Passenger Rail Cars, and APTA SS-C&S-011-99 – Standard for Cab Crew Seating Design and Performance. These safety standards were originated in 1999, and they overlay FRA's requirements for seats in 49 CFR § 238.233 and for fire safety in § 238.103. They are necessary to help ensure that seats remain attached during an accident, that the forces and accelerations experienced by an occupant are within human tolerance levels, and that the materials used to fabricate the seats do not pose significant smoke or fire hazards.

EN has limited requirements for occupant protection. Generally, EN requires that survival space must be preserved under specific collision conditions, but there are no specific requirements to minimize injury associated with secondary impacts between the occupant and the seat.

As seats in new conventional equipment must comply with the requirements of these safety standards, so too must the seats used in alternatively designed equipment comply with safety standards. There are no options specified for complying with the occupant protection features criteria.

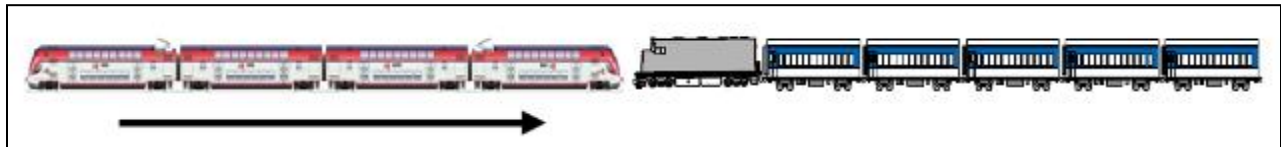
### 3. Criteria

---

#### 3.1 Requirement: Collision with Conventional Equipment

Although there is no analog to this collision scenario presently included in the CFR for Tier I passenger equipment, the combination of a dynamic collision evaluation (**Section 3.1**) and a quasi-static OVI evaluation (**Section 3.2**) helps provide assurance of sufficient resistance to loss of occupied volume. If a waiver of the requirements of § 238.203 is sought based on the guidance provided in this document, it is expected that the vehicle in question will be shown to meet the criteria contained within both **Section 3.1** and **Section 3.2** of this document.

The evaluation collision scenario is defined as follows:



**Figure 38. Collision Scenario**

#### Equipment

- **Initially Moving Train:** The train is made up of alternatively designed equipment at AWO ready-to-run condition. The length of the consist reflects its planned operational use. If train configurations of varying consist length are intended for use, the configurations having the longest and shortest consist lengths shall be evaluated. If the train is intended for push-pull service, then both the cab car-led and conventional locomotive-led configurations shall be evaluated separately.
- **Initially Standing Train:** This train is a conventional locomotive-led passenger train. The train consists of one leading, conventional locomotive weighing 260,000 lb and five conventional passenger cars each weighing 95,000 lb. Details on the locomotive geometry and conventional passenger cars can be found in **Appendix C. Locomotive and Passenger Car Input Data**.

#### Initial Conditions

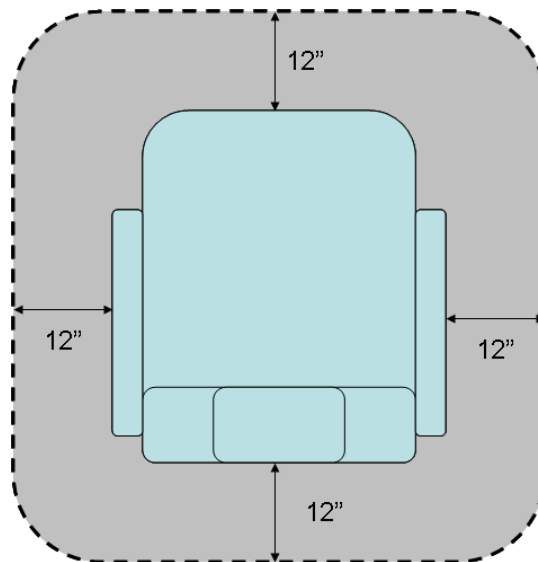
- Tangent, Level Track.
- Moving Train Impact Speed:
  - A) 20 mph, if cab car- or MU locomotive-led train, or
  - B) 25 mph, if conventional locomotive-led train
- Coupler knuckles are closed for each colliding vehicle.
- Moving and standing train are not braked.
- The standing train has only 1 degree of freedom (longitudinal direction).

#### Results

- Preserve interior spaces occupied by passengers.
  - The occupied volume for the passengers shall have no more than 10 in of longitudinal, permanent deformation; or

- Global vehicle shortening shall be no more than 1 percent over any 15 ft of the occupied volume.
- Maintain safe secondary impact environment.
  - Compare the secondary impact velocity (SIV) curve, calculated at the CG of each car/locomotive, to the SIV curve associated with the 8g, 250-millisecond triangular crash pulse.
- Preserve interior space for engineer.
  - Each seat in the operating compartment shall have a survival space where there is no intrusion after the collision scenario;
  - The survival space shall be a minimum of 12 in from the edge of the seat;
  - Flip-down seats will not be used;
  - There shall be a clear exit path for the occupants after the collision scenario;
  - The vertical height of the compartment (floor to ceiling) shall not be reduced by more than 20 percent after the collision scenarios; and
  - The operating console shall not move closer to the engineer's seat after the collision scenario.

Figure 39 shows an overhead view of the engineer's seat. The 12-inch-wide minimum survival space on each side of the seat is indicated in this figure. No intrusion is permitted to occur within the boundaries of the dashed line during the collision scenario.



**Figure 39. Engineer's Seat with Survival Space Indicated**

### **3.2 Requirement: Occupied Volume Integrity**

The combination of a dynamic collision evaluation (**Section 3.1**) and a quasi-static OVI evaluation (**Section 3.2**) helps provide assurance of sufficient resistance to loss of occupied volume. If a waiver of the requirements of § 238.203 is sought based on the guidance provided in this document, it is expected that the vehicle in question will be shown to meet the criteria contained within both **Section 3.1** and **Section 3.2** of this document.

#### **Title 49 CFR Requirement**

§ 238.203. Static end strength.

This subpart is excerpted in **Appendix B. Selected CFR References**.

\*\*\*\*\*

#### **Options**

The following options are provided as alternatives to the stated regulation to demonstrate sufficient OVI. The equipment must comply with either the regulation or at least one of these alternatives.

#### **Option A**

Passenger equipment shall resist a minimum quasi-static end load of 800,000 lb applied on the collision load path without permanent deformation of the occupied volume.

#### **Option B**

Passenger equipment shall resist a minimum quasi-static end load of 1,000,000 lb applied on the collision load path with limited permanent deformation of the occupied volume. This load shall be supported without exceeding either of the following two conditions:

- Local plastic strains of 5 percent; or
- Vehicle shortening of 1 percent over any 15 ft of the occupied volume.

#### **Option C**

Passenger equipment shall resist a minimum quasi-static end load of 1,200,000 lb applied on the collision load path without crippling the body structure. Crippling of the body structure is defined as the maximum point on the load-displacement characteristic.

### 3.3 Requirement: Colliding Equipment Override

#### Title 49 CFR Requirement

§ 238.205. Anticlimbing mechanism.

This subpart is excerpted in **Appendix B. Selected CFR References.**

\*\*\*\*\*

#### Option

Given the scenario described in **Section 3.1**, anticlimb features shall be demonstrated for each of the following sets of initial conditions:

- 1) All cars in the moving and standing consists are positioned at their nominal running heights.
- 2) The interface of the colliding equipment is perturbed laterally and vertically by 3 in.

The pass/fail criteria are as follows:

- The relative difference in elevation between the underframes of the colliding and connected equipment shall not change by more than 4 in; and
- The tread of any wheel of the alternatively designed equipment shall not rise above the top of rail more than 4 in.



### 3.4 Requirement: Connected Equipment Override

#### Title 49 CFR Requirement

§ 238.205. Anticlimbing mechanism.

§ 238.207. Link between coupling mechanism and carbody.

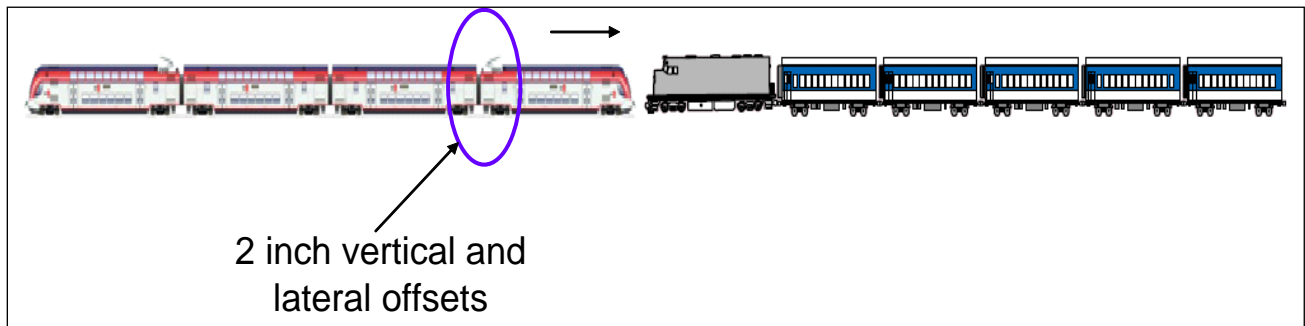
These subparts are excerpted in **Appendix B. Selected CFR References.**

\*\*\*\*\*

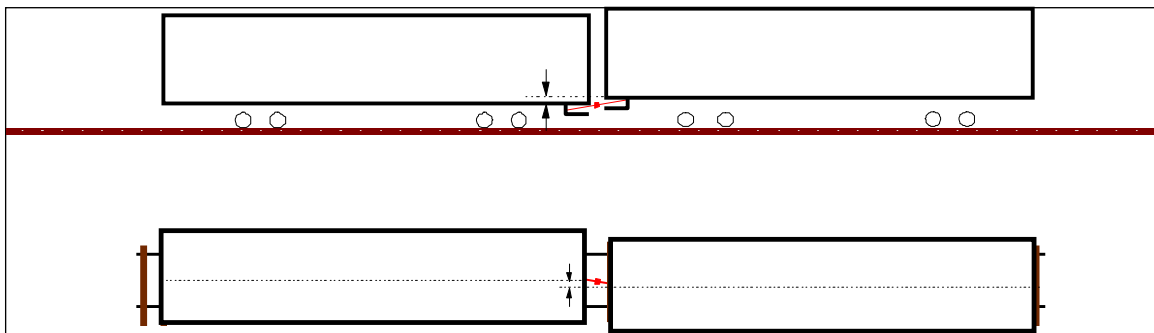
#### Option

Given the scenario described in **Section 3.1**, anticlimb features shall be demonstrated for each of the following sets of initial conditions:

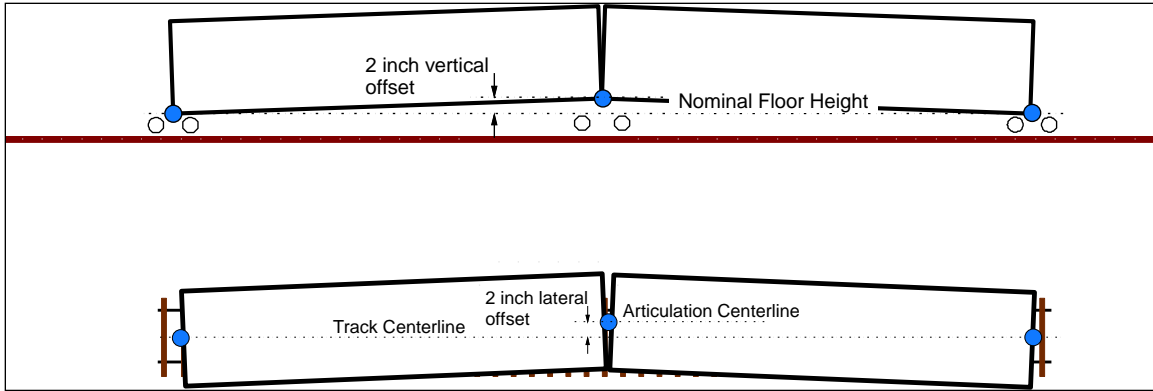
- 1) All cars in the moving and standing consists are positioned at their nominal running heights.
- 2) The first car-to-car interface of the initially moving consist is perturbed laterally and vertically by 2 in.



**Figure 40. Location of Offsets in Moving Consist**



**Figure 41. Illustration of Offsets for Coupled Cars**



**Figure 42. Illustration of Offsets for Articulated Cars**

The pass/fail criteria are as follows:

- The relative difference in elevation between the underframes of the connected equipment shall not change by more than 4 in; and
- The tread of any wheel of the alternatively designed equipment shall not rise above the top of rail more than 4 in.

### **3.5 Requirement: Fluid Entry Inhibition**

#### **Title 49 CFR Requirement**

§ 238.209. Forward end structure of locomotives, including cab cars and MU locomotives.

This subpart is excerpted in **Appendix B. Selected CFR References.**

\*\*\*\*\*

#### **Option**

None specified. FRA makes clear that aluminum and other material—not steel plate alone—can be used to keep fluids and debris from entering the ends of the car, as required by § 238.209.

However, the material must have strength at least equivalent to that for the steel plate specified.

### **3.6 Requirement: End Structure Integrity of Cab End**

#### **Title 49 CFR Requirement**

§ 238.211. Collision posts.

§ 238.213. Corner posts.

These subparts are excerpted in **Appendix B. Selected CFR References.**

\*\*\*\*\*

#### **Option**

The option presented below allows the use of Appendix F to Part 238 to demonstrate end structure integrity for the cab end of the car. In Appendix F, the phrases “collision post” and “corner post” are used to describe the end structure of the car. For purposes of this option, this wording can be thought of as referring to any structure at the specified locations, whether that structure is or is not a post.

#### **Title 49 CFR**

§ 238.209. Forward end structure of locomotives, including cab cars and MU locomotives

Appendix F to Part 238—Alternative Dynamic Performance Requirements for Front End Structures of Cab Cars and MU Locomotives

This subpart is excerpted in **Appendix B. Selected CFR References.**

### **3.7 Requirement: End Structure Integrity of Noncab End**

#### **Title 49 CFR Requirement**

§ 238.211. Collision posts.

§ 238.213. Corner posts.

These subparts are excerpted in **Appendix B. Selected CFR References.**

\*\*\*\*\*

#### **Collision Post Option**

Collision posts are not required for equipment with pushback couplers and interlocking anticlimbers, provided that the intercar connection is capable of preventing disengagement and telescoping to the same extent as equipment satisfying the anticlimbing and collision post requirements contained in 49 CFR Part 238. (See Option for § 238.205. Anticlimbing mechanism, for description of criteria for determining whether connection is capable of preventing disengagement and telescoping.)

#### **Corner Post Option**

(a) Each passenger car shall have at each end of the car, placed ahead of the occupied volume, two side structures capable of resisting:

- (1) A 150,000-pound horizontal force applied at floor height without failure;
- (2) A 20,000-pound horizontal force applied at ceiling height without failure; and
- (3) A 30,000-pound horizontal force applied at a point 18 in above the top of the floor without permanent deformation.

(b) For purposes of this section, the orientation of the applied horizontal forces shall range from longitudinal inward to transverse inward.

**3.8 Requirement: Roof Integrity**

**Title 49 CFR Requirement**

§ 238.215. Rollover strength.

This subpart is excerpted in **Appendix B. Selected CFR References.**

\*\*\*\*\*

**Option**

None specified.

**3.9 Requirement: Side Structure Integrity**

**Title 49 CFR Requirement**

§ 238.217. Side structure.

This subpart is excerpted in **Appendix B. Selected CFR References.**

\*\*\*\*\*

**Option**

None specified.

### 3.10 Requirement: Truck Attachment

#### Title 49 CFR Requirement

§ 238.219. Truck-to-carbody attachment.

This subpart is excerpted in **Appendix B. Selected CFR References.**

\*\*\*\*\*

#### Options

The following options are provided as alternatives to the stated regulation to demonstrate sufficient truck-to-carbody attachment. The equipment must comply with either the regulation or at least one of these alternatives to demonstrate compliance with the criteria stated in this document.

#### Option A

Passenger equipment shall have a truck-to-carbody attachment with strength sufficient to resist without yield the following individually applied quasi-static loads on the mass of the truck at its CG: 3g vertically; 5g longitudinally, along with the resulting vertical reaction to this load; and 1g laterally, along with the resulting vertical reaction to this load. For the purposes of this option, the mass of the truck includes axles, wheels, bearings, the truck-mounted brake system, suspension system components, and any other component attached to the truck by design.

In addition, for the nominal initial condition given in the scenario described in **Section 3.1**:

- The average longitudinal deceleration of the car during the impact shall not exceed 5g; and
- The peak longitudinal deceleration of the truck shall not exceed 10g.

\*\*\*\*\*

#### Option B

Passenger equipment shall have a truck-to-carbody attachment with strength sufficient to resist without yield the following individually applied quasi-static loads on the mass of the truck, at its CG: 3g vertically and 1g laterally, along with the resulting vertical reaction to these loads. For the purposes of this option, the mass of the truck includes axles, wheels, bearings, the truck-mounted brake system, suspension system components, and any other component attached to the truck by design.

In addition, the truck shall remain attached during the scenario described in **Section 3.1**.

\*\*\*\*\*



### 3.11 Requirement: Interior Fixture Attachment

Relevant definitions excerpted from 49 CFR 238.5:

**Interior fitting** means any component in the passenger compartment which is mounted to the floor, ceiling, sidewalls, or end walls and projects into the passenger compartment more than 25 mm (1 in) from the surface or surfaces to which it is mounted. Interior fittings do not include side and end walls, floors, door pockets, or ceiling lining materials, for example.

**Passenger compartment** means an area of a passenger car that consists of a seating area and any vestibule that is connected to the seating area by an open passageway.

#### **Title 49 CFR Requirement**

§ 238.233. Interior fittings and surfaces.

For guidance on the application of § 238.233, which is excerpted in **Appendix B. Selected CFR References**, see the PowerPoint document, *FRA Guidance on Interior Fitting Attachment Strength*.

\*\*\*\*\*

#### **Included by reference:**

APTA SS-C&S-006-98, Rev. 1,  
Standard for Attachment Strength of Interior Fittings for Passenger Railroad Equipment

APTA SS-C&S-034-99, Rev. 2,  
Standard for the Design and Construction of Passenger Railroad Rolling Stock

\*\*\*\*\*

#### **Option**

None specified.

### **3.12 Requirement: Occupant Protection Features**

#### **Included by reference:**

APTA SS-C&S-016-99, Rev. 2

Standard for Row-to-Row Seating in Commuter Rail Cars

APTA SS-C&S-011-99

Standard for Cab Crew Seating Design and Performance

## 4. Example Procedures

---

### 4.1 Introduction

This section includes examples of procedures that may be used to evaluate equipment designs using the criteria described in **Section 3 – Criteria**. These procedures are examples of one way of applying the criteria; however, there may be other ways of applying the criteria. Example procedures are provided for those criteria with an option specified. Entities submitting waiver requests may select any engineering-based procedure that they find appropriate. An overview of the procedure used by the submitting entity should be included in the waiver request. The purpose of these examples is to show that the criteria are practical and can be applied using modern engineering techniques.

## 4.2 Guidance Summary

**Table 3. Guidance Summary for Criteria and Evaluation**

Requirement	Summary of Load Case	Summary of Criteria
Collision with conventional equipment	Alternatively designed train in collision with conventional locomotive-led train: (a) 20 mph, cab car- or MU locomotive-led; or (b) 25 mph, conventional locomotive-led	Preserve occupied volume for passengers Preserve survival space in operating cab
OVI	On the intended collision load path: (a) 800 kip (b) 1,000 kip (c) 1,200 kip	(a) No permanent deformation (b) Limited permanent deformation (c) Without crippling
Colliding equipment override	Alternatively designed equipment collision with conventional locomotive: (a) all equipment aligned; or (b) consists offset 3 in vertical and laterally	No override and wheel lift minimized
Connected equipment override	Alternatively-designed equipment in collision with conventional locomotive, with 2-inch vertical/2-inch lateral offsets of first car-to-car connection	No override and wheel lift minimized
Fluid entry inhibition	Based on design review	(a) Equivalent to 1/2-inch steel plate with 25,000 psi yield strength; (b) Designed to inhibit the entry of fluids into the occupied area; and (c) Affixed to structural members
End structure integrity of cab end	(a) Absorb minimum of 135 ft-kip of energy for impact offset 19 in from longitudinal centerline (b) Absorb minimum 120 ft-kip of energy for impact aligned with sidewall	No more than 10 in of longitudinal, permanent deformation
End (corner) structure integrity of noncab end	(a) 150 kip at floor height (b) 30 kip 18 in above floor (c) 20 kip at ceiling height	(a) Without failure (b) Without permanent deformation (c) Without failure
Roof integrity	Equipment upside down, supported by roof	(a) No occupied volume intrusion; and (b) No more than 1/2 yield or buckling
Side structure integrity	Design requirements on sidewall stiffness and material properties	Vertical modulus (in <sup>3</sup> ) > 0.3 × L Horizontal modulus (in <sup>3</sup> ) > 0.2 × L
Truck attachment	Scenario 3.1 plus either: (a) 3g vertical, 1g lateral, 5g longitudinal; or (b) 3g vertical, 1g lateral	Static analyses: Without yielding; and (a) Scenario 3.1: Avg. acc. < 5g and Max. acc. < 10g; or (b) Scenario 3.1: Trucks remain attached
Interior fixture attachment	Fixtures: 8/4/4g Longitudinal/lateral/vertical quasi-static load; and Seats: 8g longitudinal dynamic pulse	Fixtures and seats remain attached
Seats	8g sled test with instrumented HIII ATDs per Rev. 2 of APTA-SS-C&S-016-99	Seats must meet requirements in Rev. 2 of APTA-SS-C&S-016-99, including injury criteria

*Note: Table for use as a summary only for the requirements noted.*

### 4.3 Requirement: Collision with Conventional Equipment

This section includes the criteria and procedures for evaluating alternatively designed equipment for a collision with conventional equipment. The procedures and results in this section show the types of analyses and results that demonstrate compliance with the criteria. Other procedures may be followed in demonstrating compliance.

#### 4.3.1 Criteria

The evaluation collision scenario is defined as follows:

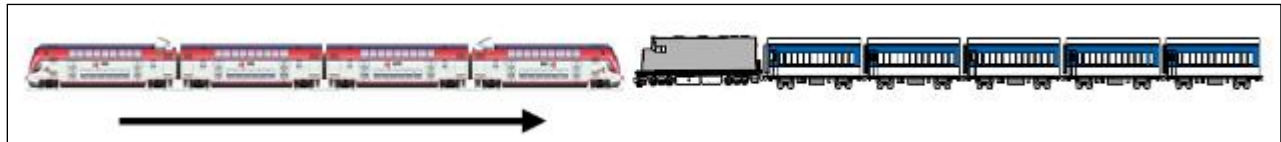


Figure 43. Collision Scenario

#### Equipment

- **Initially Moving Train:** The train is made up of alternatively designed equipment at AW0 ready-to-run condition. The length of the consist reflects its planned operational use. If train configurations of varying consist length are intended for use, the configurations having the longest and shortest consist lengths shall be evaluated. If the train is intended for push-pull service, then both the cab car-led and conventional locomotive-led configurations shall be evaluated separately.
- **Initially Standing Train:** This train is a conventional locomotive-led passenger train. The train consists of one leading, conventional locomotive weighing 260,000 lb and five conventional passenger cars each weighing 95,000 lb. Details on the locomotive geometry and conventional passenger cars can be found in **Appendix C. Locomotive and Passenger Car Input Data**.

#### Initial Conditions

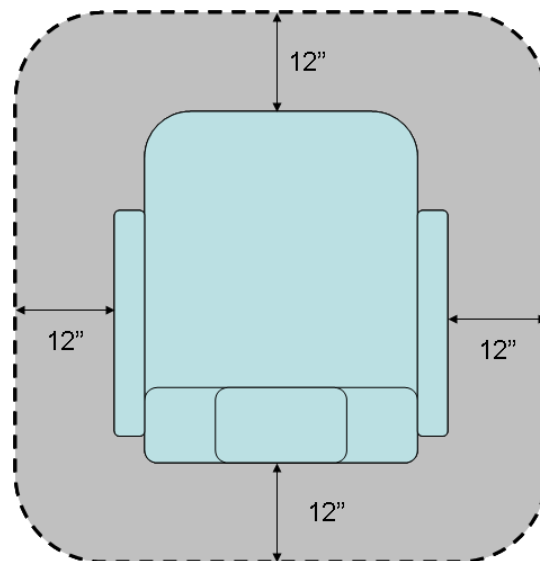
- Tangent, Level Track.
- Moving Train Impact Speed:
  - A) 20 mph, if cab car- or MU locomotive-led train, or
  - B) 25 mph, if conventional locomotive-led train
- Coupler knuckles are closed for each colliding vehicle.
- Moving and standing train are not braked.
- The standing train has only 1 degree of freedom (longitudinal direction).

#### Results

- Preserve interior spaces occupied by passengers.
  - The occupied volume for the passengers shall have no more than 10 in of longitudinal, permanent deformation; or
  - Global vehicle shortening shall be no more than 1 percent over any 15 ft of the occupied volume.
- Maintain safe secondary impact environment.

- Compare the secondary impact velocity (SIV) curve, calculated at the CG of each car/locomotive, to the SIV curve associated with the 8g, 250-millisecond triangular crash pulse.
- Preserve interior space for engineer.
  - Each seat in the operating compartment shall have a survival space where there is no intrusion after the collision scenario;
  - The survival space shall be a minimum of 12 in from the edge of the seat;
  - Flip down seats will not be utilized;
  - There shall be a clear exit path for the occupants after the collision scenario;
  - The vertical height of the compartment (floor to ceiling) shall not be reduced by more than 20 percent after the collision scenarios; and
  - The operating console shall not move closer to the engineer's seat after the collision scenario.

Figure 44 shows an overhead view of the engineer's seat. The 12-inch-wide minimum survival space on each side of the seat is indicated in this figure. No intrusion is permitted to occur within the boundaries of the dashed line during the collision scenario.



**Figure 44. Engineer's Seat with Survival Space Indicated**

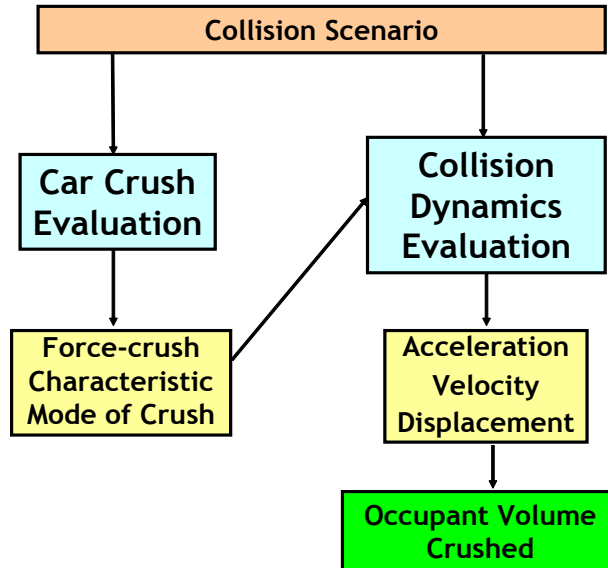
### **4.3.2 Example Procedures**

This section describes the information required for conducting the collision dynamics analyses. Approaches for conducting such analyses include lumped-parameter analysis and finite element analysis, as well as hybrid approaches. In lumped-parameter analysis, each car is represented by a small number of masses and a small number of force-crush characteristics. In the extreme, each car can be represented by a single mass with a single force-crush characteristic between masses (cars). Generally, in a lumped-parameter model, the degrees of freedom available to the masses are restricted, with the extreme being a single degree of freedom model. In finite element analysis, structures are meshed into a large number of elements. Each element has a mass and stiffness connecting it to adjacent elements. A finite element model of a rail passenger carbody

may have more than 500,000 elements, each associated with a mass. In the extreme, all of the structural elements of all of the cars—carbodies, trucks, couplers, etc. —are meshed and represented by finite elements that are able to represent three-dimensional motion of the vehicles. In a hybrid approach, some of the structural elements of the cars that make up the train are modeled with finite elements, and some of the structural elements are represented as lumped masses and force-crush characteristics. Two examples are described in this section, one example with lumped-parameter analysis and the other example with hybrid analysis, using finite elements to model the colliding equipment and lumped-parameters to model the trailing equipment.

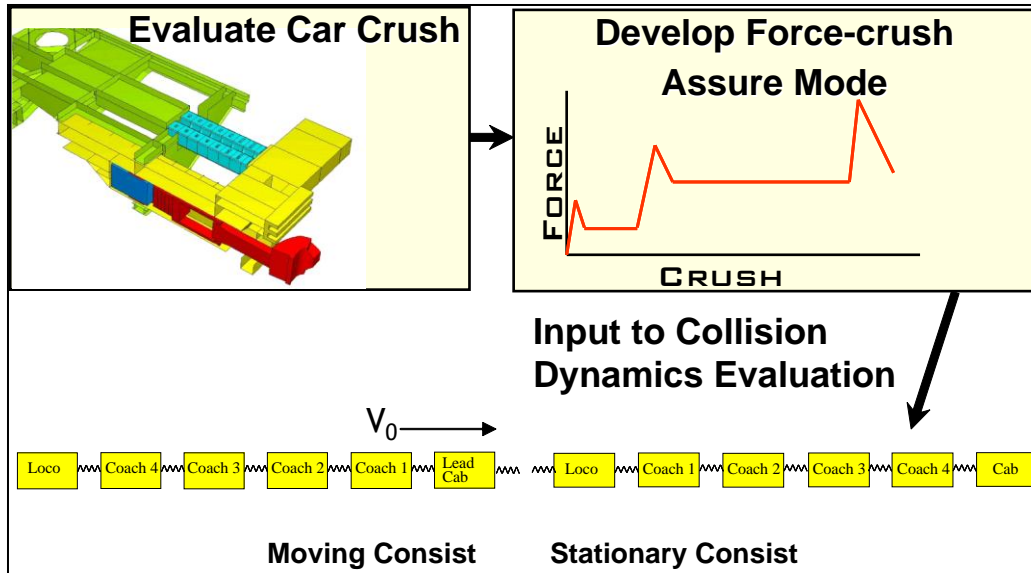
All three approaches—lumped parameter, finite element, and hybrid—can be used to develop the required information. The required result that the occupied volume for the passengers shall have no more than 10 in of longitudinal, permanent deformation is more readily applied to the results of a lumped-parameter analysis, whereas the alternative requirement that results that the global vehicle shortening shall be no more than 1 percent over any 15 ft of the occupied volume is more readily applied to the results from a finite element analysis. Because only one of these two results is necessary, the one that is more readily applied may be selected.

As shown in Figure 45, car crush results are key inputs to the train collision dynamics analyses. Force-crush characteristics from a separate car crush analysis define the car ends in a lumped-parameter model. In addition, the mode of deformation assumed in developing train collision dynamics must be consistent with the mode of deformation observed in the car crush analyses. Force-crush characteristics are computed internally with finite element analysis.



**Figure 45. Flowchart of Evaluation Procedure**

Figure 46 is a graphical illustration of the relationship between the car crush analysis (typically performed with the finite element method), the mode of deformation, and the lumped-parameter train collision dynamics analyses.



**Figure 46. Relationship between Car/Locomotive Crush Evaluation and Train Collision Dynamics Evaluation**

Note that for valid evaluations, a high level of assurance is needed that car crush analytical results are consistent with the train collision dynamics. This can be demonstrated with destructive component tests or nondestructive OVI tests, backed by plastic analysis.

### **Car Crush Evaluation**

A car crush analysis is used to produce the force-crush characteristics and the modes of deformation of each car end. Figure 47 shows the required input and output for a crush evaluation. A typical car crush analysis may be performed using a validated finite element model of the car of interest. Example procedures for validating a finite element model using structural test data are provided in **Validation Procedures**.



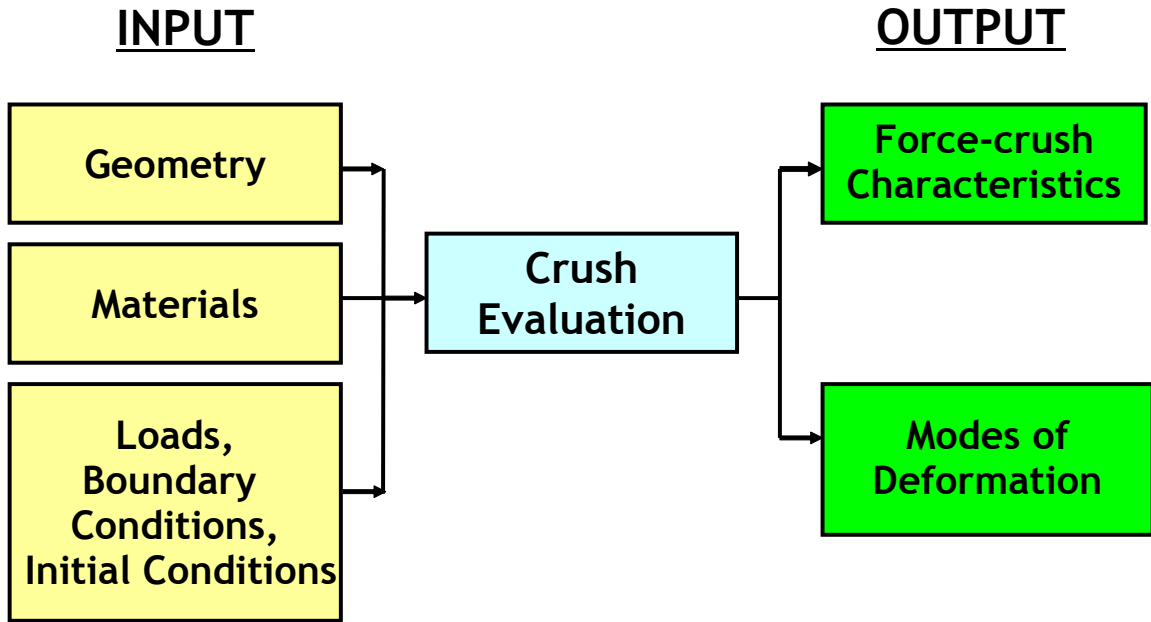


Figure 47. Key Inputs and Outputs for Car Crush Analysis

- Key Output
  - Force-crush characteristic
    - Key Features Meet Targets (e.g., Pushback Coupler (PBC) Trigger Load, Crush Loads)
    - Robust OVI to Support Component Loads
  - Mode of Crush
    - Sequence of Events Meets Target
    - Limited Vertical Displacement for Full Range of Crush
- Procedures
  - Nonlinear Finite Element Modeling
  - Component Testing
  - Nondestructive Occupied Volume Testing

### Train-Level Evaluation

A collision dynamics analysis is used to demonstrate compliance with the scenario requirements. Figure 48 shows the development of a collision dynamics evaluation.

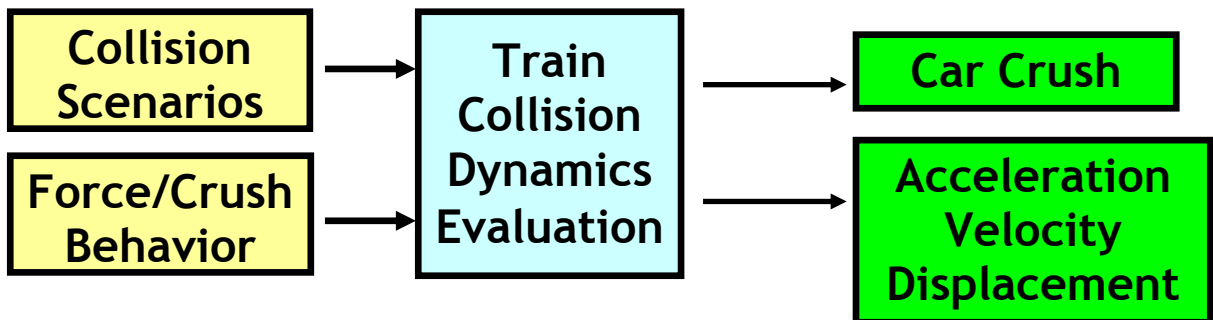
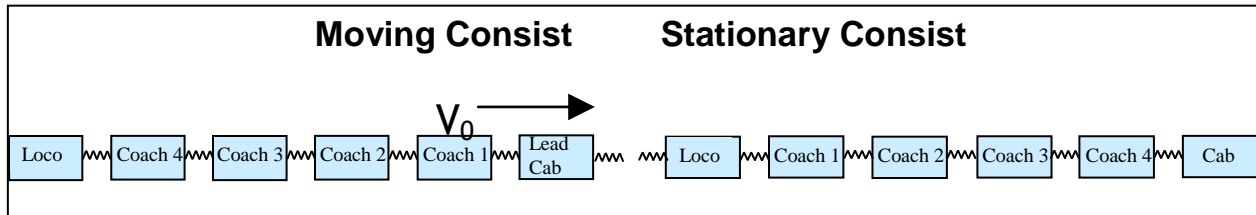


Figure 48. Key Inputs and Outputs for Collision Dynamics Evaluation

*Example Evaluation A: Lumped-Parameter Analysis*

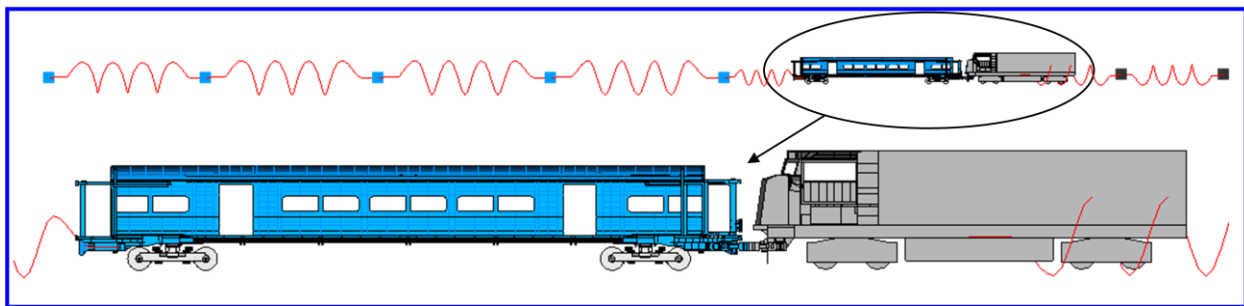
Figure 49 is a schematic of a lumped-mass model for the given collision scenario. The moving consist should include the appropriate number and configuration of vehicles for the equipment being evaluated. In the one-dimensional lumped mass analyses, motion is constrained to translation only. Each vehicle may be considered a single, rigid mass, and car ends are characterized by deformable springs with prescribed force-deflection characteristics.



**Figure 49. Schematic of a Lumped-Parameter Model for a Train-to-Train Collision Scenario**

*Example Evaluation B: Hybrid Finite Element Analysis*

Figure 50 is a schematic of a finite element model for the given collision scenario. In this evaluation, the collision scenario is simulated using three-dimensional finite element analysis at the collision interface with one-dimensional lumped-mass simplification of all trailing cars. The moving consist should include the appropriate number and configuration of vehicles for the equipment being evaluated. The model includes a full three-dimensional representation of the first vehicle in each consist to properly capture the deformation of each vehicle end involved at the collision interface. The trailing vehicles in each consist are modeled using one-dimensional lumped-mass analyses, where motion is constrained to translation only. Each trailing vehicle may be considered a single, rigid mass, and car ends are characterized by deformable springs with prescribed force-deflection characteristics.



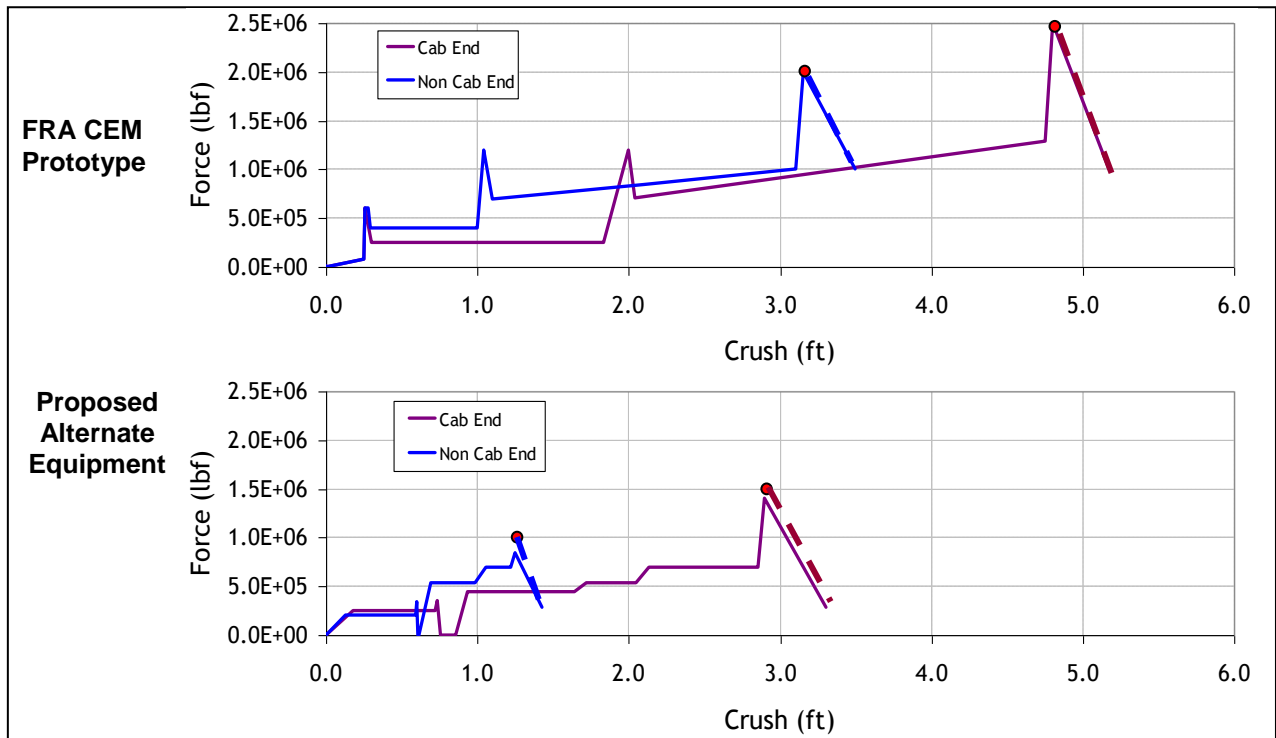
**Figure 50. Schematic of a Finite Element Model for a Train-to-Train Collision Scenario**

Table 4 shows key input parameters, for example, equipment designs. Each vehicle end must preserve occupied space in accordance with the criteria for the collision scenario (see **Section 3 – Criteria**). The point of intrusion for each vehicle end depends on the specific seating configuration and layout of occupied space.

**Table 4. Example of Key Inputs for Collision Dynamics Analysis**

<b>Equipment</b>	<i>Example 1: FRA-Prototype CEM Train</i>	<i>Example 2: Proposed Alternate Train</i>	<i>Scenario 1: Conventional Standing Train</i>
<b>Train Makeup</b>	Cab car, 4 passenger coaches, and conventional locomotive	4 MU consist	Conventional locomotive, 4 passenger coaches, cab car
<b>Speed</b>	20 mph	20 mph	Stationary
<b>Vehicle Weights</b>	Cab car = 95 kip Passenger coach = 95 kip Locomotive = 260 kip	MU = 95 kip	Locomotive = 260 kip Passenger/cab cars = 95 kip
<b>Level of Braking</b>	None	None	None

Figure 51 illustrates another key input to the collision dynamics model, the idealized force-crush characteristics for different types of equipment. The top graph illustrates the force-crush characteristics for the FRA-prototype CEM equipment (both cab end and noncab end) and the second graph illustrates force-crush characteristics, for example, alternatively designed equipment. The dashed line at the right-hand-end of each characteristic represents the behavior of the occupied volume of each vehicle end once its CEM features have been exhausted and its OVI compromised.



## **Figure 51. Example Idealized Force-Crush Characteristics**

### **4.3.3 Example Key Results**

This section discusses example results from the car crush analysis and the collision dynamics analysis. In general, the car crush results will serve as part of the input to the collision dynamics model. The collision dynamics results can then be used to evaluate compliance with the criteria for the collision scenario being evaluated.

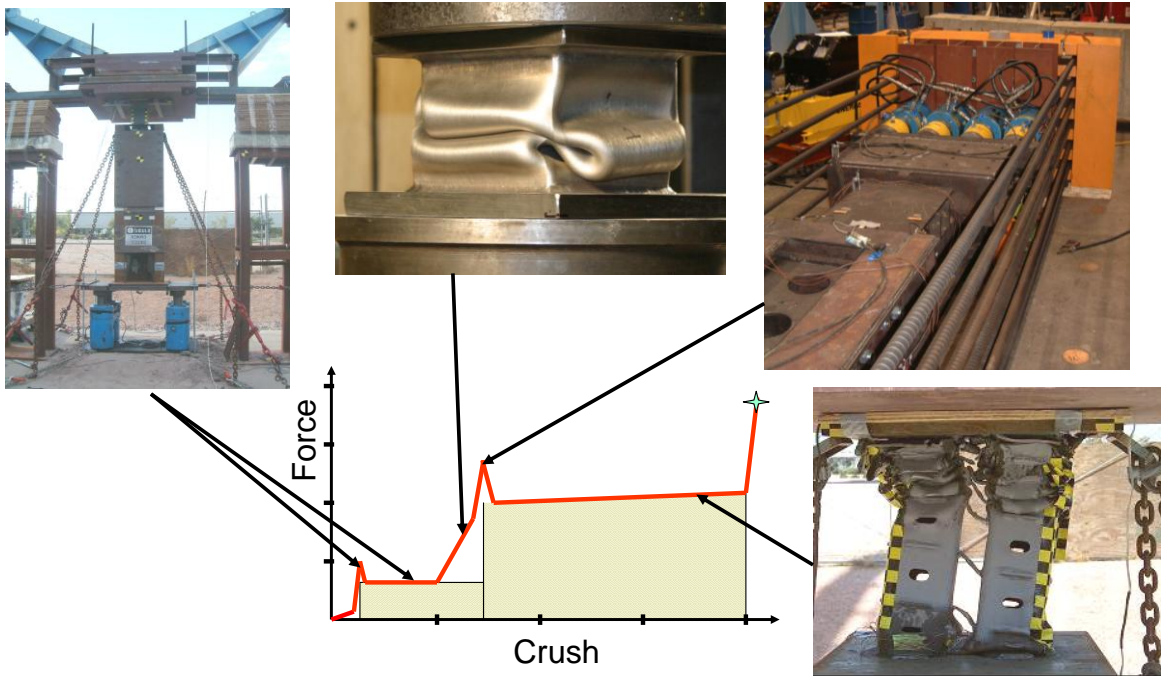
#### **Car Crush Results**

The following section provides an example of developing the idealized force-crush characteristics used as inputs to the collision dynamics evaluation. A combination of component testing and analysis should be used to support the assumptions and measurements in generating the idealized force-crush characteristics. In addition, the requirements of § 238.111—Prerevenue service acceptance testing plan—apply to all passenger vehicles, including their structural and occupant protection components. Table 5 shows the testing and analysis plan used to develop the force-crush characteristic for the FRA-prototype CEM cab-end design. This plan was completed to measure the force-crush characteristic of the car end and confirm that it performed as designed (i.e., confirm the sequence of events, trigger loads, modes of deformation, etc.).

**Table 5. Example Matrix of Component Testing and Analysis**

Component	Detailed Analysis		Component Testing
	Component Level	Car Level	
<b>Primary Energy Absorber</b>	<b>Yes</b>	<b>Yes</b>	<b>Dynamic</b>
<b>Pushback Coupler</b>	<b>Yes</b>	<b>Yes</b>	<b>Dynamic</b>
<b>Sliding Sill/Fixed Sill</b>	<b>Yes</b>	<b>Yes</b>	<b>Static &amp; Dynamic</b>
<b>Combined Pushback Coupler/Sliding Sill/Fixed Sill</b>	<b>Yes</b>	<b>Yes</b>	<b>Dynamic</b>
<b>Roof Absorber</b>	<b>No</b>	<b>Yes</b>	<b>No</b>
<b>Deformable Anticlimber</b>	<b>Yes</b>	<b>Yes</b>	<b>Sub-component</b>

Figure 52 shows various component tests that were conducted to measure key features of the target force-crush characteristic. This test plan included quasi-static and dynamic testing of the energy-absorbing components and the initiation mechanisms within the crush zone. The force-crush behavior measured in the each component test was used in assembling the overall idealized force-crush characteristic for the crush zone.



**Figure 52. Verification of Force-Crush Characteristic through a Series of Full-Scale Structural Component Tests**

The following procedures were used to assemble the force-crush characteristic for the FRA-prototype CEM design:

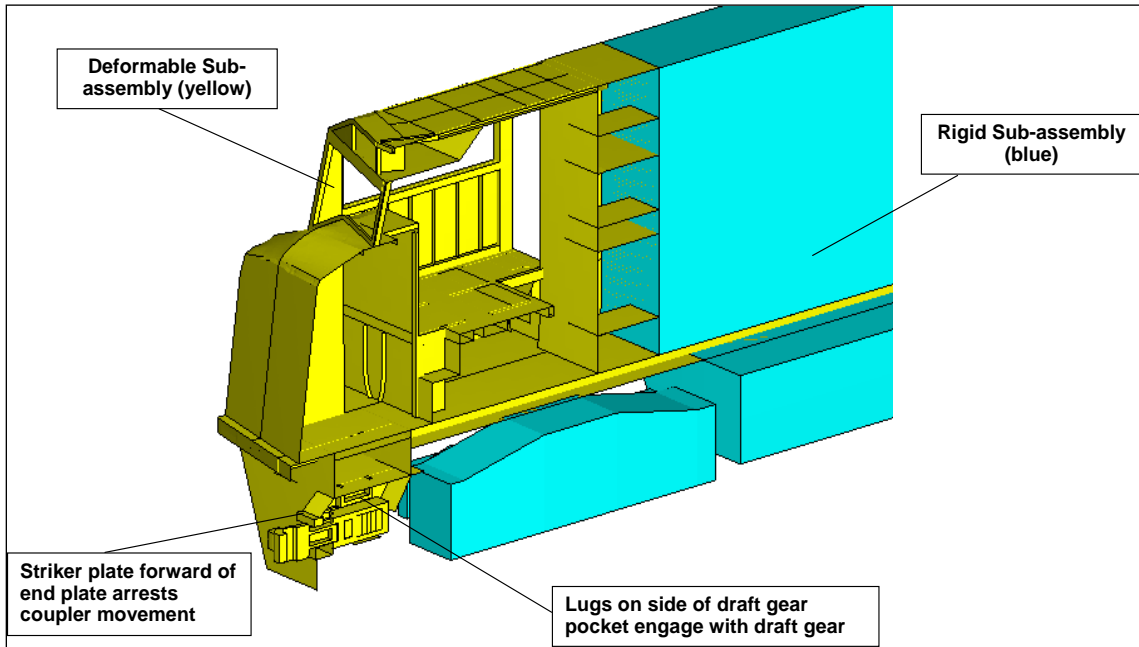
- Component testing
- Nonlinear finite element modeling

A series of component tests demonstrated that criteria were met for the following CEM components:

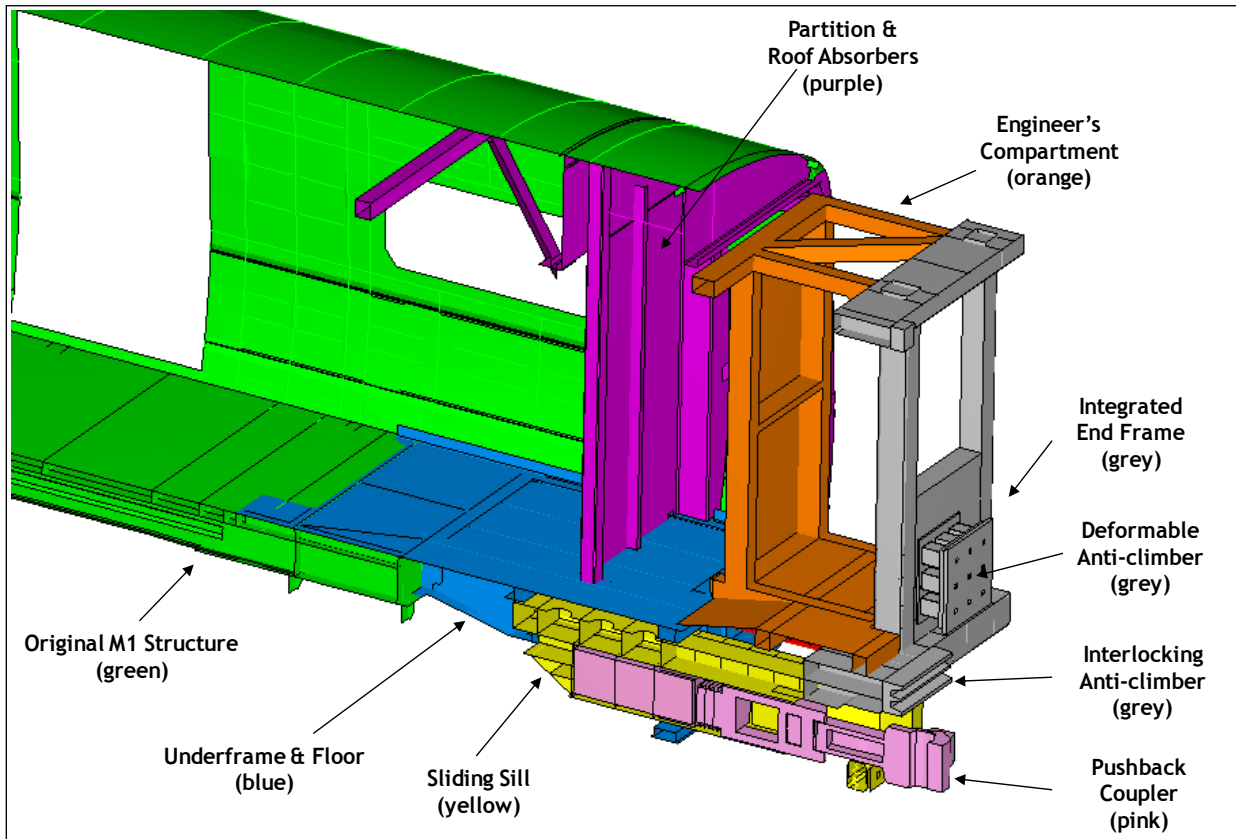
- PBC initiation mechanism force within target range
- Pushback coupler energy absorber force-crush behavior and mode within target ranges
- Primary energy absorbing mechanism (PEAM) initiation mechanism force within target range
- PEAM energy absorber force-crush behavior and mode (average slope) within target ranges

A car-to-locomotive finite element model was developed and used to verify that components worked together as designed to provide the desired force-crush behavior and modes of deformation. Note that, in this example, the locomotive featured deformable geometry. The submodel provided in **Appendix C. Locomotive and Passenger Car Input Data** features rigid geometry:

- FE vehicle model development
  - F40PHM-based locomotive (Figure 53)
  - M1-based cab car with CEM (Figure 54)



**Figure 53. Rigid and Deformable Geometry of an F40PHM-Based Locomotive**

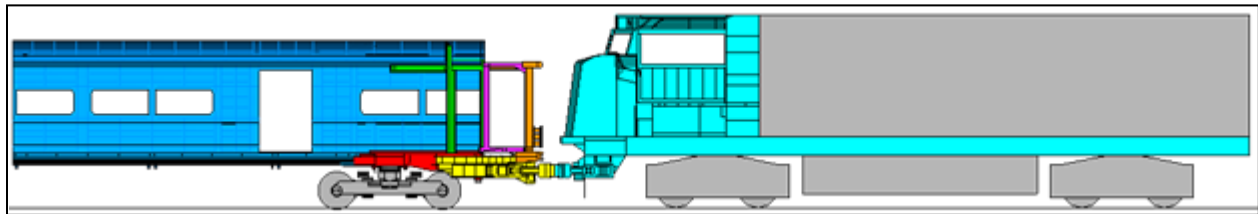


**Figure 54. Cab-End Model of FRA-Prototype CEM Cab Car**

The following analyses were conducted on the cab car to verify that the crush zone met all design requirements and performance criteria for ideal and offset collision conditions:

- Static and quasi-static analyses
- Dynamic crush analysis: ideal conditions
- Dynamic crush analysis: offset conditions

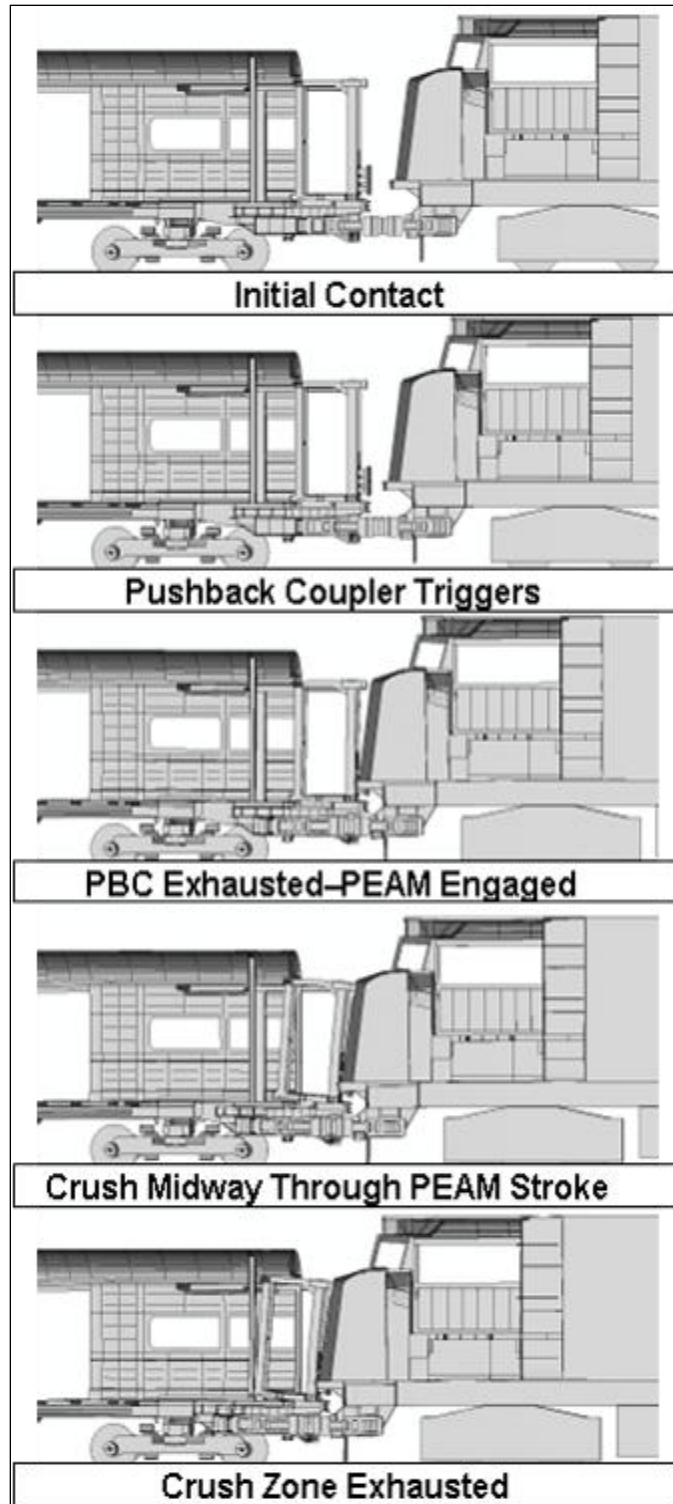
Figure 55 shows the initial conditions for a dynamic crush analysis under ideal conditions (i.e., all cars in the model are positioned at their nominal running heights). The rear of the cab car was fixed in the model, and the conventional locomotive was given an initial velocity of 30 mph.



**Figure 55. Cab Car Ideal Dynamic Crush Analysis**

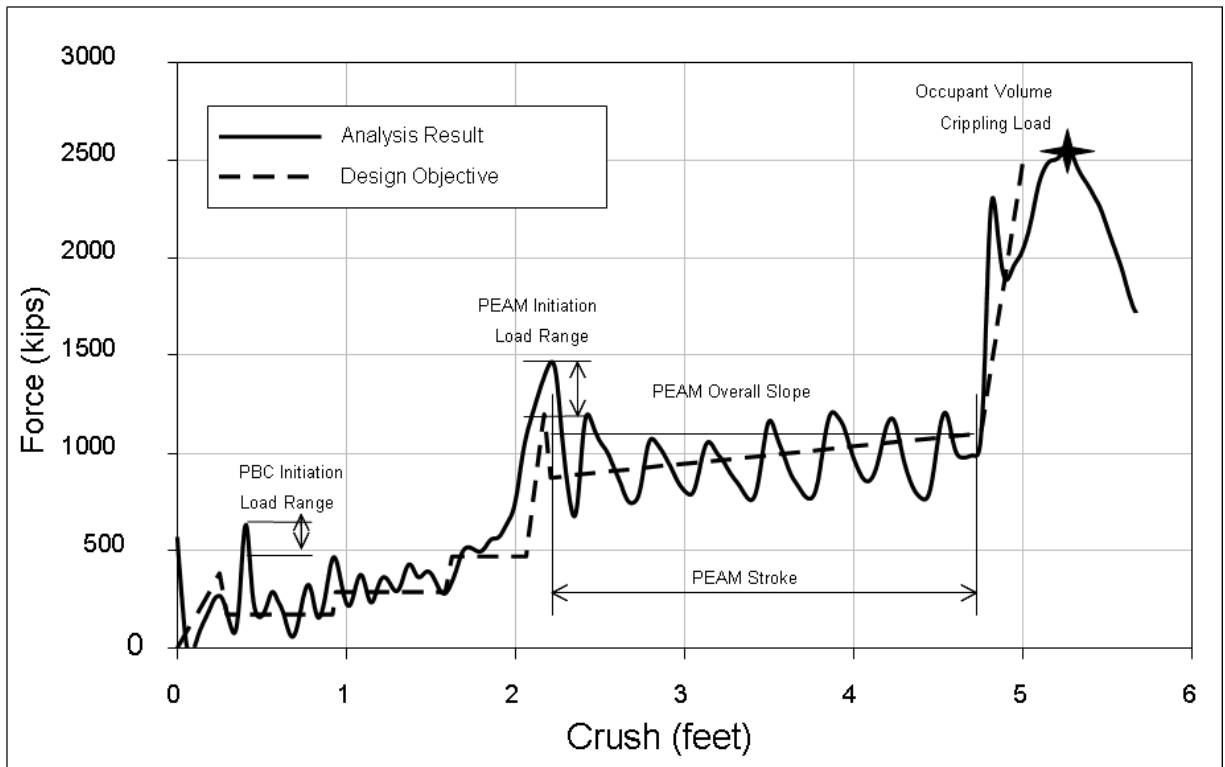
Figure 56 shows the kinematic sequence of crush events from the dynamic crush analysis of ideal impact conditions. The analysis was executed with sufficient initial kinetic energy to fully exhaust the crush zone on the CEM cab car, allowing the full force-crush characteristic to be examined.





**Figure 56. Example Kinematic Sequence of Events from Car-Level Crush Analysis**

The force-crush measurement from the crush analysis is plotted alongside the design objective force-crush characteristic in Figure 57. The dashed line represents the target force-crush characteristic. These results demonstrate that the sequence of events represented by the idealized force-crush characteristics are appropriate inputs for the collision dynamics analyses.



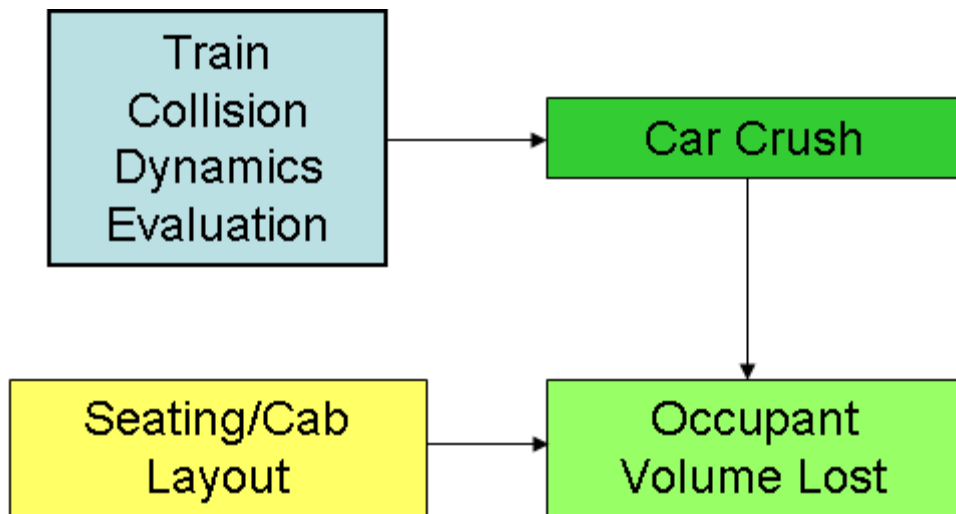
**Figure 57. Example Car-Level Crush Analysis Measured Force-Crush Characteristic**

## Train-Level Evaluation Results

Two key results are required to describe the crashworthiness performance of alternatively designed equipment for the collision scenario:

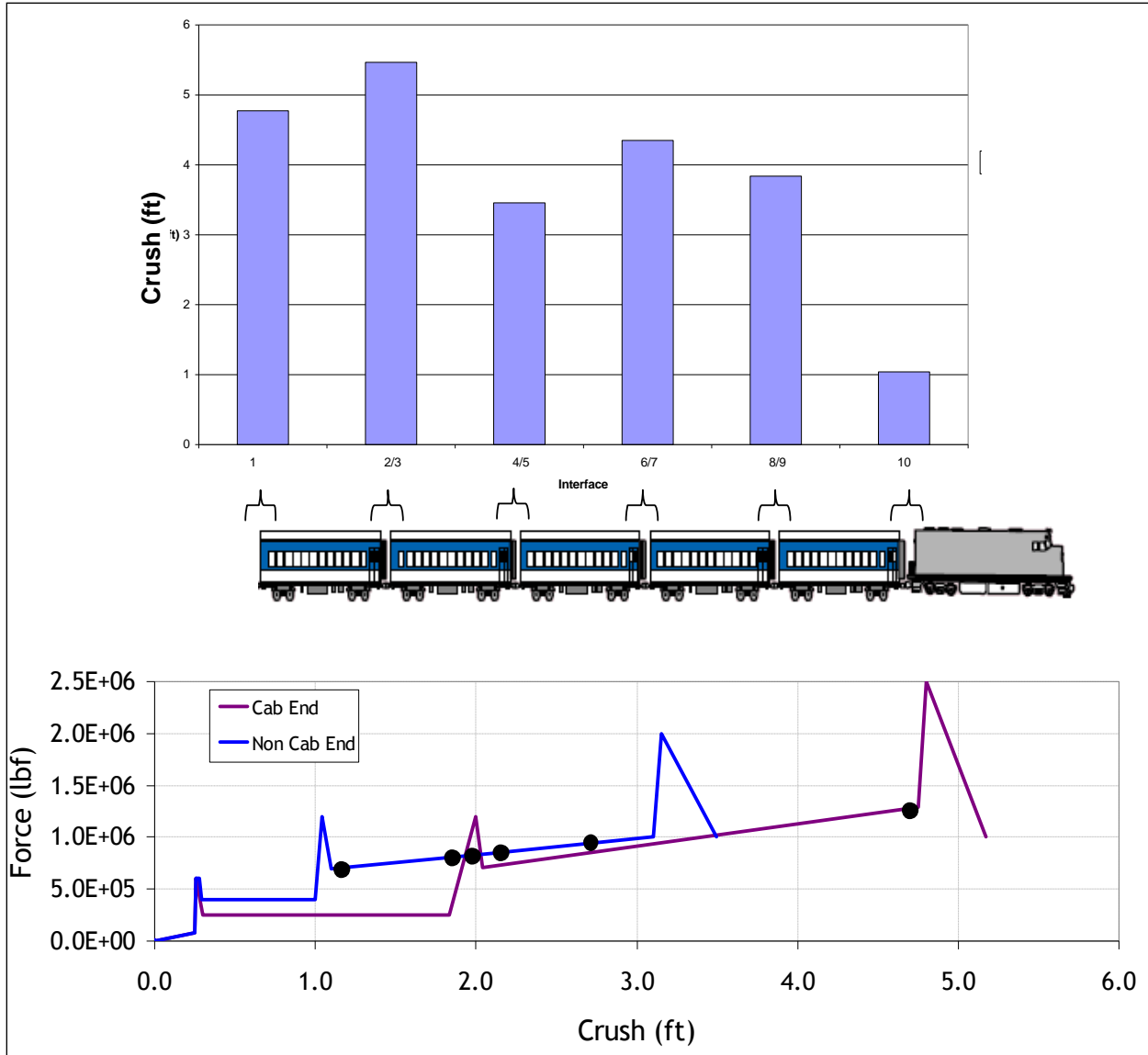
- 1) Crush results demonstrating that occupied volume crush meets the criteria; and
- 2) Gross motions of each car in the consist to estimate the secondary impact environment.

The flowchart in Figure 58 shows a procedure for postprocessing collision dynamics model results to evaluate occupied volume crush. The cab layout on cab ends and seating layout at each car end determine the points at which occupied space is compromised. The total loss of occupied volume in a given analysis must be compared with the values established in **Section 3 – Criteria** to determine whether the scenario meets the crashworthiness and occupant protection performance criteria.



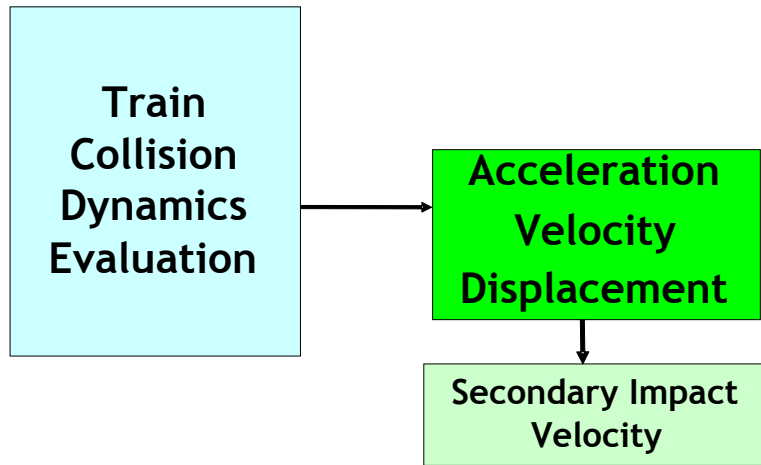
**Figure 58. Flowchart Showing Procedure for Calculating Intrusion into Occupied Volume**

Figure 59 shows example results from a collision dynamics analysis. The bar chart shows crush at each coupled connection in the initially moving consist. The total crush plotted at each connection is the sum of the crush at each of the two connected ends. The points on the corresponding force-crush characteristics indicate the amount of car crush at each car end. These results demonstrate that occupied volume is preserved throughout the train, because the peak load is not exceeded at any car end.



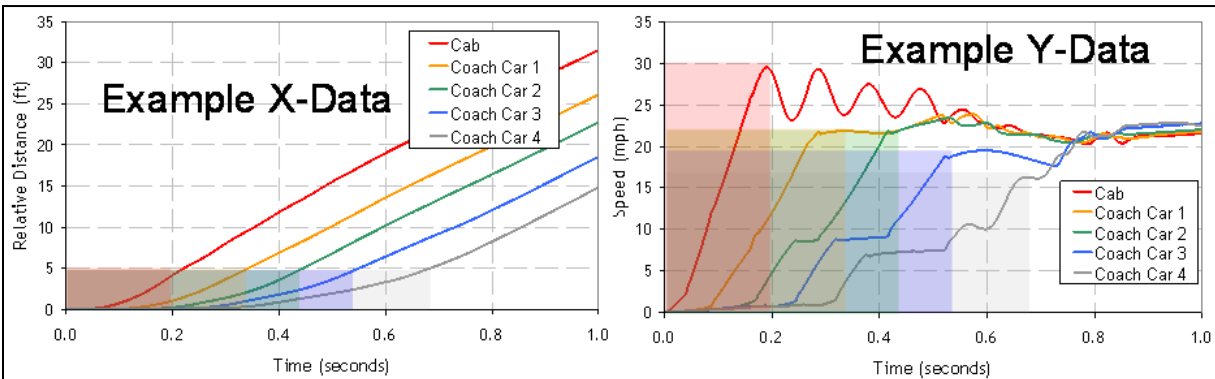
**Figure 59. Example Crush Results from One-Dimensional Lumped Mass Model: Crush Distribution for Each Car End in the Consist**

The flowchart in Figure 60 shows a procedure for postprocessing collision dynamics model results to estimate the secondary impact environment. Output from the collision dynamics analysis includes the acceleration, velocity, and displacement history of each vehicle.



**Figure 60. Flowchart Showing Procedure for Calculating SIV Estimates**

Following this paragraph are results from a train-to-train collision dynamics analysis. These results are shown as an example of the procedures for calculating the secondary impact velocities and do not reflect results for the specific collision conditions described in the criteria document. Figure 61 shows the relative displacement-time data and the relative velocity-time data at the CG of each car in the moving consist. The relative displacement ( $x$ -axis) and velocity ( $y$ -axis) data are plotted against one another to develop the SIV characteristics for each car.



**Figure 61. Relative Displacement and Relative Velocity Plots for Moving Consist**

The SIV characteristics for all of the cars in the moving consist are plotted in Figure 62. From this plot, the SIVs can be estimated for allowable travel distance in specific seating configurations for each car. These results give an estimate of the severity of the collision environment for this equipment with the particular seating configurations planned for use.

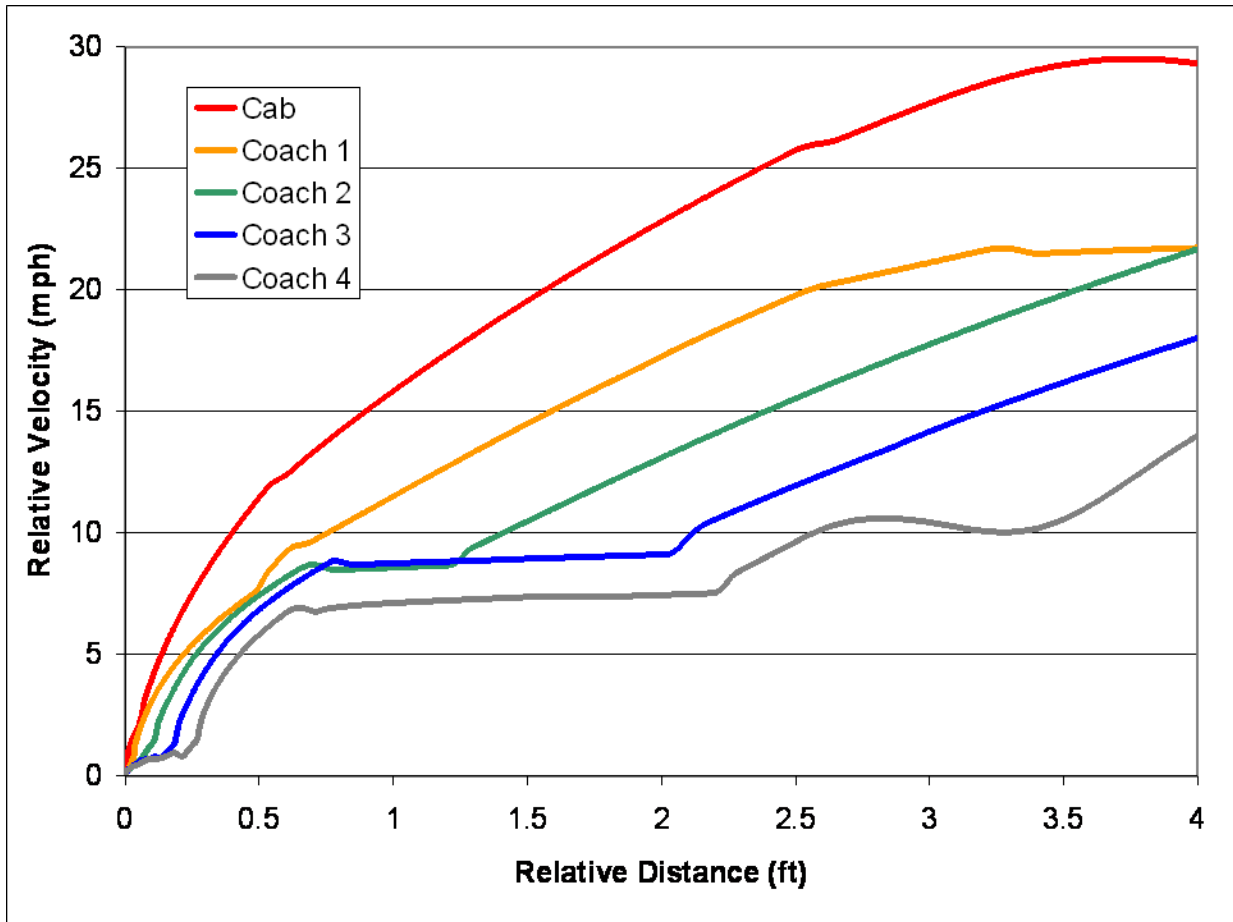


Figure 62. Example SIV Characteristics

#### 4.4 Requirement: Occupied Vehicle Integrity

This section includes the criteria and procedures for alternatively evaluating OVI. The example procedures outlined in **Section 4.4.2** are one way to demonstrate compliance with one of the three options. Other procedures may be used.

##### 4.4.1 Criteria

##### Options

The following options are provided as alternatives to the stated regulation to demonstrate sufficient OVI. The equipment must comply with either the regulation or at least one of these alternatives.

##### Option A

Passenger equipment shall resist a minimum quasi-static end load of 800,000 lb applied on the collision load path without permanent deformation of the occupied volume.

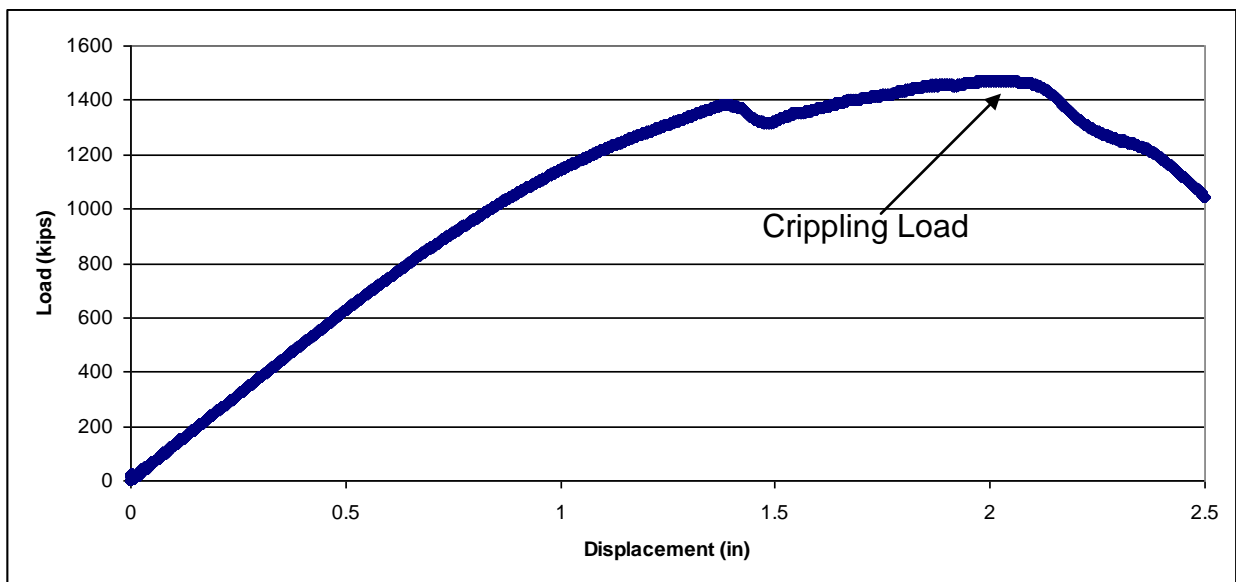
### Option B

Passenger equipment shall resist a minimum quasi-static end load of 1,000,000 lb applied on the collision load path with limited permanent deformation of the occupied volume. This load shall be supported without exceeding either of the following two conditions:

- Local plastic strains of 5 percent; or
- Vehicle shortening of 1 percent over any 15 ft of the occupied volume.

### Option C

Passenger equipment shall resist a minimum quasi-static end load of 1,200,000 lb applied on the collision load path without crippling the body structure. Crippling of the body structure is defined as the maximum point on the load-displacement characteristic. A sample load-displacement characteristic is shown in Figure 63.



**Figure 63. Example of Load-Displacement Characteristic Indicating Crippling**

#### 4.4.2 Example Procedure

The procedures for testing a carbody, analyzing the OVI, and validating the model with test data are discussed in further detail in this section.

#### Testing Procedures

It is expected that quasi-static compression testing will be used as part of a program of model validation for any of the three options. The test procedure used should follow a recognized national or international standard. Regardless of the standard used, the end load should be a minimum of 337,000 lb. This load may otherwise be applied in accordance with the selected standard. The standard used shall be clearly identified, and a copy shall be furnished to FRA if requested.

Testing may be used either to demonstrate a particular car's compliance with an option or as part of a program of model validation.

In all cases, the test procedures should include loading the car to some intermediate load value less than the maximum load to be applied. This allows verification that the instrumentation is functioning properly as well as provides data that can be used to confirm the predicted behavior at the ultimate test load.

Critical measurements for any test should include strains throughout the structure as well as deformation of the occupied volume over the course of the test.

### **Analysis Procedures**

Analysis may be used to demonstrate compliance with any of the three options for OVI. Any analysis that is being used to demonstrate a given design's ability to meet the option must be properly validated with test data. Regardless of the option being used, the procedures for modeling the occupied volume should be the same, aside from the load magnitude being applied.

### **Geometry**

The entire occupied volume (for both passengers and crewmembers) should be modeled. If the carbody is symmetric, symmetry boundary conditions may be used to facilitate efficient execution. Couplers (both front and rear), articulations, and CEM components may be removed from the model. Mesh size should be sufficiently fine to capture stress details where necessary throughout the model.

### **Materials**

Materials used in the model should include their elastic-plastic stress-strain behavior. Where possible, material properties derived from material test results should be used. Material properties may be assumed to be independent of the rate of deformation. Failure modeling of connections (welds, rivets, bolts, etc.) is not required, provided that the analysis does not indicate critical stresses/strains in the vicinity of the connectors.

### **Boundary Conditions**

Vertical support for the carbody model should be provided at the locations where it would be provided in a physical carbody. In most cases, this would be at the points where the trucks' secondary suspension elements interface with the carbody. If an articulation is used in the design, vertical support may also be provided at the location of the articulation in the physical car structure.

Longitudinal restraint may be provided at the rear end of the car by means of a rigid wall. The wall may be divided into multiple parts to facilitate measurement of reaction forces at the floor level, wall level, and roof level. The rigid wall is not permitted to move in any direction.

Lateral restraint may be accomplished through a longitudinal-vertical symmetry boundary condition. If a longitudinal-vertical symmetry plane is not used in a model, a lateral restraint may be provided through the use of a reasonable coefficient of friction between the rear reaction wall and the car structure.

### **Loading**

Loading of the occupied volume should resemble the type of loading the occupied volume on a physical car would experience during a collision situation. Loads should be applied along the collision load path based on the details of the specific design being evaluated. If collision energy



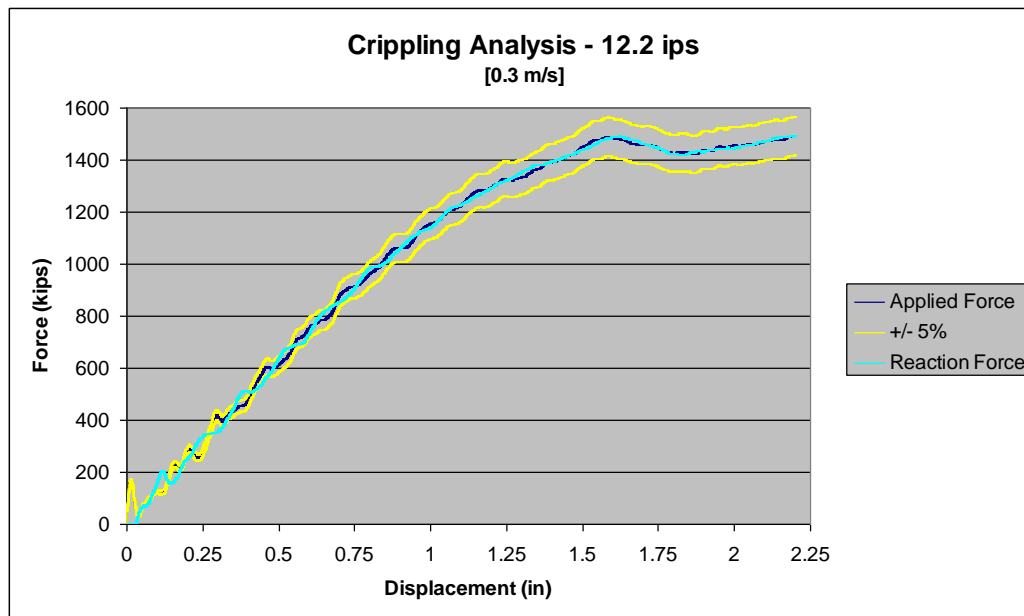
absorbers are removed from the model, loading of the structure may take place through the energy absorber supports at the end of the occupied volume. One way of applying these loads is through the use of a rigid plate at each energy absorber support location. Each rigid plate would have a prescribed displacement that increases with time, allowing the plate to make contact with the energy absorber support in a manner similar to that of the energy absorber reacting against its support.

The prescribed load rate applied to each rigid plate should be the same for a given car design. The rate should be chosen carefully to avoid introducing dynamic effects to the simulation. For all three options, OVI is to be demonstrated for a quasi-static loading case. It is important to ensure that the model is predicting the quasi-static behavior of the car free from dynamic effects.

An analysis conducted in accordance with *either* of the next two conditions should be considered quasi-static.

#### Condition One

For a given simulated load rate, the load at the live end of the model should be the same as the load at the fixed end. Load at the reaction end may vary by up to  $\pm 5$  percent of the load at the live end of the model for the analysis to be considered quasi-static. Figure 64 depicts two example load-displacement characteristics for the same model, one generated at the point of load application and one generated at the reaction location. A  $\pm 5$  percent envelope is plotted on this example graph to demonstrate the quasi-static nature of the analysis.

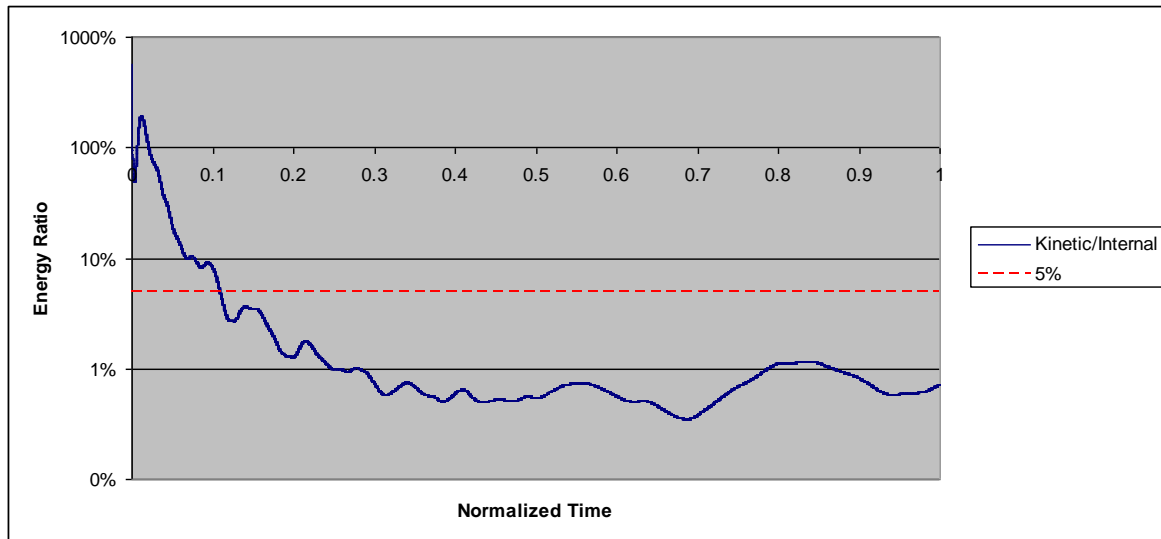


**Figure 64. Example Load-Displacement Characteristics at Front and Back End with 5 Percent Envelope**

#### Condition Two

The ratio of kinetic energy to strain energy within the structure should be small ( $< 5$  percent). The ratio of kinetic energy-to-strain energy may exceed 5 percent during the first 10 percent of the

total simulation time without invalidating the analysis as quasi-static. Figure 65 shows a sample graph of kinetic energy to internal energy plotted against the normalized analysis time.



**Figure 65. Example Ratio of Kinetic Energy to Strain Energy for Analysis**

### Validation Procedures

If analysis is used to demonstrate compliance with any of the three options, the model used must be validated with test data. The model should be validated with data from a compressive strength test of the occupied volume. The load may be applied to the vehicle in a manner consistent with the governing design standard, with an end load magnitude no less than 1,500 kN (337,000 lb) regardless of the load magnitude required by the design standard.

The same occupied volume finite element model should be used to simulate the test and demonstrate compliance with an option. For validation analyses, the effects of gravity should be included in the model. Critical measurements to be compared between tests and analyses include the overall decrease in length of the car, the vertical deflection of the car, and the strain state in the car. Strain measurement locations should be chosen to minimize the local effects resulting from features such as welds, sharp corners, and geometric features that are not relevant to the occupied volume’s global behavior. For displacement data, analytical results within  $\pm 10$  percent of the test measurements should be considered as acceptable validation. For strain data, analytical results within  $\pm 20$  percent of the test measurements should be considered as acceptable validation.

### Procedures Specific to Option A

Compliance with Option A requires demonstrating (through testing or a combination of testing and analysis) that at a load of 800,000 lb distributed along points in the collision load path, the occupied volume experiences no permanent deformation.

For a test, the pass/fail criterion of “no permanent deformation” may be verified by a lack of visible damage as well as displacement measurements indicating no permanent set in the overall

dimensions of the car. In addition, strain gage results should not indicate stresses above the yield stress of the material.

For compliance demonstrated by analysis, highly localized areas of stress exceeding yield (“hotspots”) may be allowed as discussed below. An analysis may include the designated energy-absorbing elements, or these may be removed. If the energy-absorbing elements remain within the model, permanent deformation within designated energy-absorbing areas should not constitute failure to meet Option A.

Plastic strains can develop in a model that would not be apparent in a test under the same conditions, in many cases, because of assumptions and simplifications made in any finite element model. For example, sharp corners and idealized member-to-member connections may result in artificially high strains in localized regions. In consideration of this, plastic strains may be permitted within an analysis that otherwise demonstrates meeting Option A under all of the following conditions:

- Plastic analysis of the model shows the affected areas to be small with plastic strain not exceeding 1 percent;
- With removal of the simulated load, there is no permanent set in the overall dimension of the occupied volume; and
- The function of the structure is not compromised.

Deliverables should include, at a minimum:

- Contour plots indicating maximum strains in model under 800,000-pound load;
- Contour plots indicating deformation (vertical, lateral, and longitudinal) in model under 800,000-pound load;
- Evidence of model validation, including comparison of test and analytical deflections and stresses;
- Load-displacement characteristic, including loading and unloading behavior for the entire structure; and
- Load-displacement characteristics at each load application point.

### **Procedures Specific to Option B**

Using a validated finite element model, demonstrate that at a load of 1,000,000 lb in line with the collision load path, the maximum plastic strain experienced by the structure of the car is  $\leq 5$  percent. Under this load condition, vehicle shortening may not exceed 1 percent for any 15-foot length of occupied volume.

Plastic strains may develop that exceed the 5 percent permitted under Option B. In many cases, these strains develop because of assumptions and simplifications made in any finite element model. For example, sharp corners and idealized member-to-member connections may result in artificially high strains in localized regions. In consideration of this, plastic strains exceeding 5 percent should be permitted within an analysis that otherwise demonstrates meeting Option B under all of the following conditions:

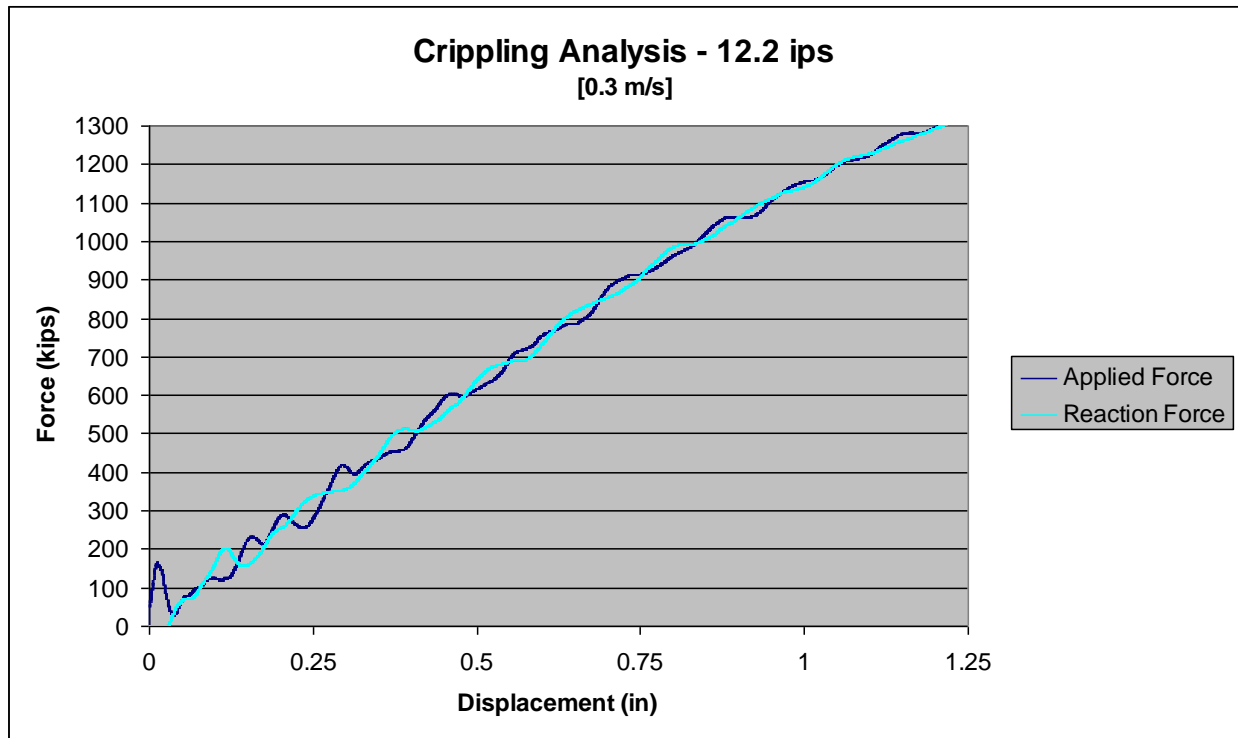
- The maximum plastic strain value is <10 percent; and
- Strains exceeding 5 percent are not located on any primary longitudinal load carrying component.

Deliverables should include, at a minimum:

- Contour plots indicating maximum strains in the model under the 1,000,000-pound load;
- Contour plots indicating deformation (vertical, lateral, and longitudinal) in the model under the 1,000,000-pound load;
- Evidence of model validation, including comparison of test and analytical deflections and stresses;
- Load-displacement characteristic up to 1,000,000 lb for the entire structure; and
- Load-displacement characteristics at each load application point.

## Procedures Specific to Option C

Using a validated finite element analysis, researchers demonstrate that the crippling load is  $>1,200,000$  lb. This property can be readily observed on a load-displacement characteristic. Note that for vehicles with crippling loads exceeding  $1,200,000$  lb, only that portion of the characteristic showing no crippling at  $1,200,000$  lb needs to be provided. Figure 66 shows a sample load-displacement characteristic taken from the front and back of the same car model. This example characteristic only shows the force up to  $1,200,000$  lb, at which point crippling has not yet occurred.



**Figure 66. Example Load-Displacement Characteristic Showing Crippling Load Exceeds 1,200,000 lb**

Deliverables should include, at a minimum:

- Contour plots indicating maximum strains in the model under the  $1,200,000$ -pound load;
- Contour plots indicating deformation (vertical, lateral, and longitudinal) in the model under the  $1,200,000$ -pound load;
- Evidence of model validation, including comparison of test and analytical deflections and stresses;
- Load-displacement characteristic up to  $1,200,000$  lb for the entire structure; and
- Load-displacement characteristics at each load application point.

If analysis is taken beyond crippling, contour plots for strain and deflection at crippling load should also be provided.

## **4.5 Requirement: Colliding Equipment Override**

This section includes the criteria and example procedures for evaluating colliding equipment override. The procedures and results in this section show the types of analyses and results that demonstrate compliance with the criteria. Other procedures may be used in evaluating a particular vehicle design.

### **4.5.1 Criteria**

Given the scenario described in **Section 3.1**, anticlimb features shall be demonstrated for each of the following sets of initial conditions:

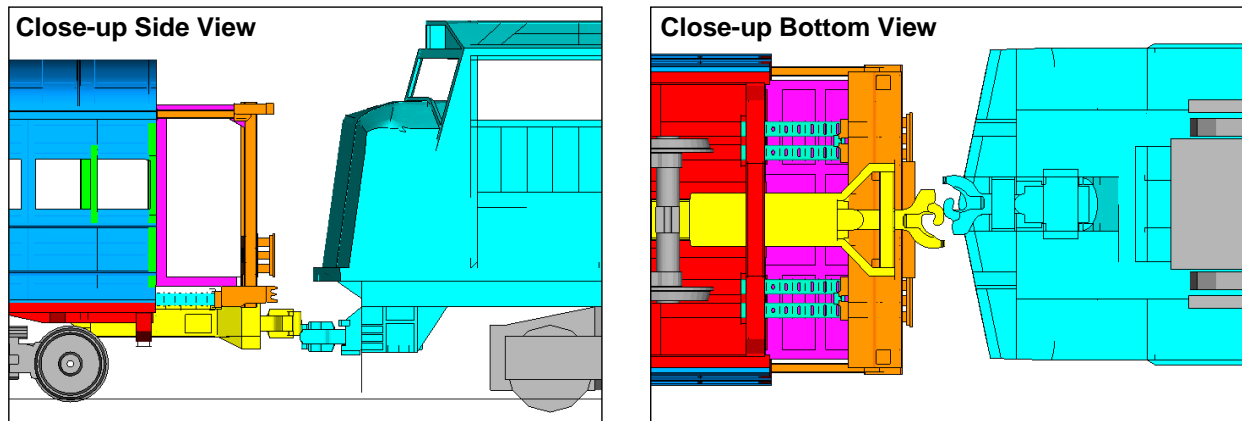
- 1) All cars in the moving and standing consists are positioned at their nominal running height.
- 2) The interface of the colliding equipment is perturbed laterally and vertically by 3 in.

The pass/fail criteria are as follows:

- The relative difference in elevation of the underframes between the colliding and connected equipment shall not change by more than 4 in; and
- The tread of any wheel of the alternatively designed equipment shall not rise above the top of rail more than 4 in.

### 4.5.2 Example Procedure

The following example procedure illustrates the type of crush analyses performed on the FRA-Prototype CEM Equipment to demonstrate that the anticlimb features will limit the potential for override in a train-to-train collision scenario. Two different collision scenarios are analyzed: one impact under ideal conditions and second impact under offset conditions. Figure 67 shows the initial conditions for an offset analysis with the conventional locomotive lowered and moved laterally by a prescribed amount. This analysis was run in preparation for a test, and the offset values do not match those given in **Section 3 – Criteria**. However, the same analysis techniques used to prepare for the test may be used to show that the criteria are met.

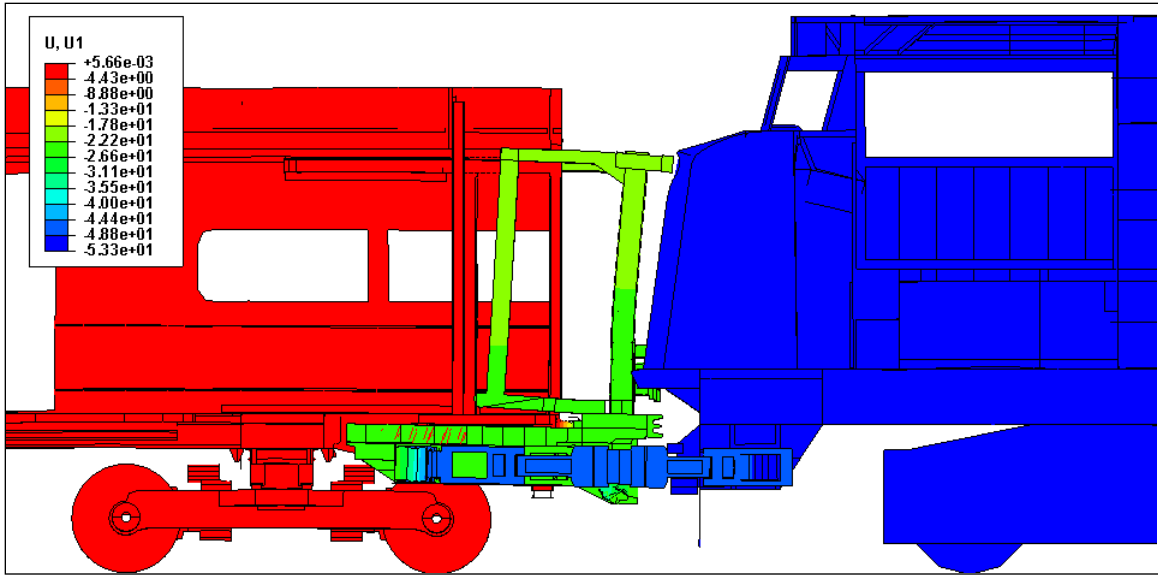


**Figure 67. Dynamic Crush Analysis with Lateral and Vertical Offsets**

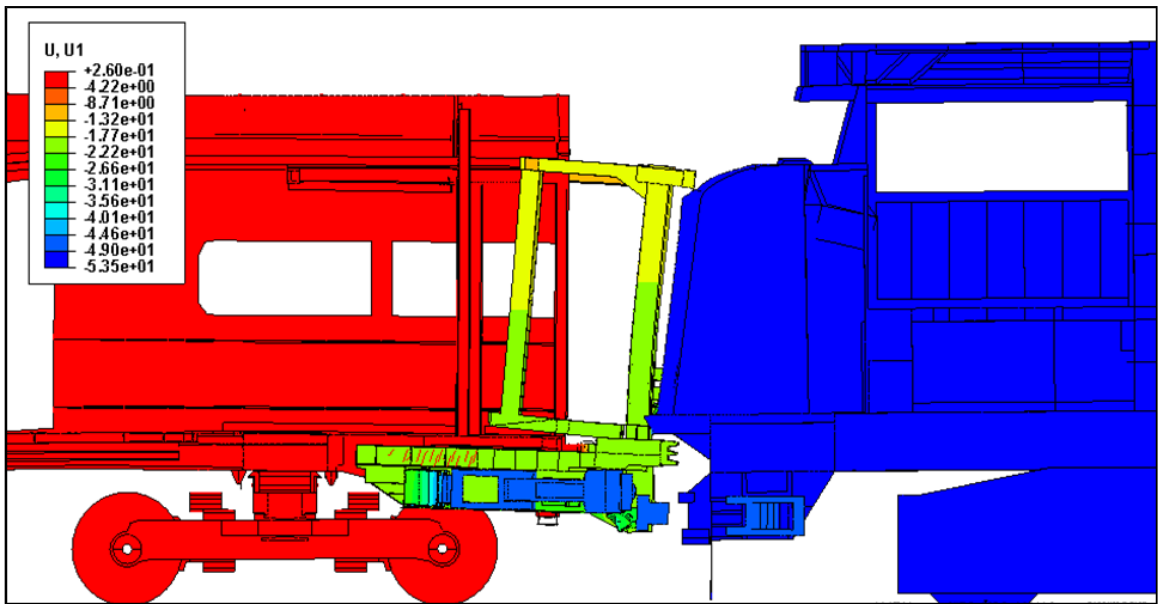
Note that although only the impacting interface is shown in this figure, compliance with the criteria requires analysis of the alternatively designed equipment in the configuration intended for use. If the alternatively designed equipment may be used in multiple configurations (e.g., a single four-car trainset, or two four-car trainsets coupled together), analysis of each such configuration is required.

### 4.5.3 Example Key Results

Figure 68 and Figure 69 show the deformation of the cab car from the analysis under ideal conditions and from the offset case, respectively. In both cases, the cab car lifted <1 in, and the vertical displacement of the conventional locomotive was negligible. In neither case were any of the trucks unloaded nor did any wheel lift occur. Consequently, these analyses demonstrate the requirements of the criteria are met.



**Figure 68. Displacement Results from Dynamic Crush Analysis: Ideal Impact Conditions**



**Figure 69. Displacement Results from Dynamic Crush Analysis: Offset Impact Conditions**



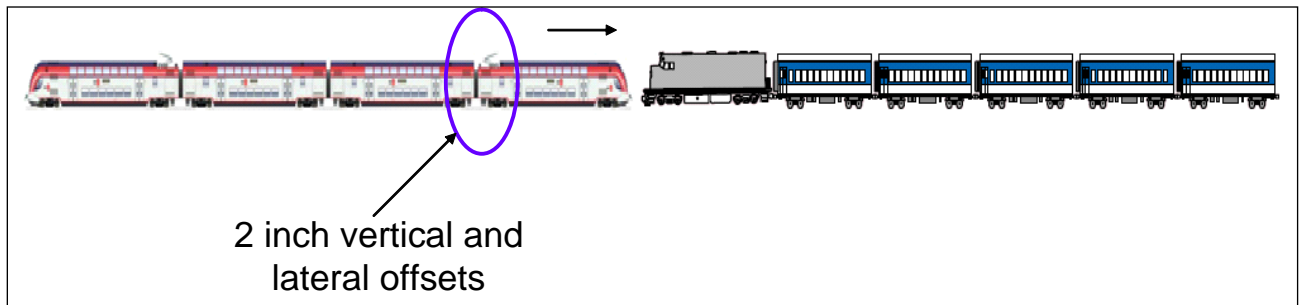
## 4.6 Requirement: Connected Equipment Override

This section includes the criteria and example procedures for evaluating connected equipment override. The procedures and results in this section show the types of analyses and results that demonstrate compliance with the criteria. Other procedures may be used in evaluating a particular design.

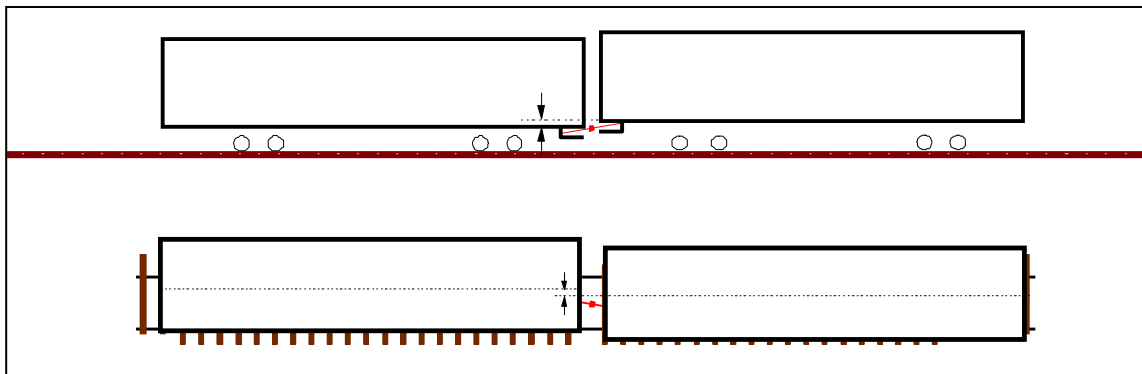
### 4.6.1 Criteria

Given the scenario described in **Section 3.1**, anticlimb features shall be demonstrated for each of the following sets of initial conditions:

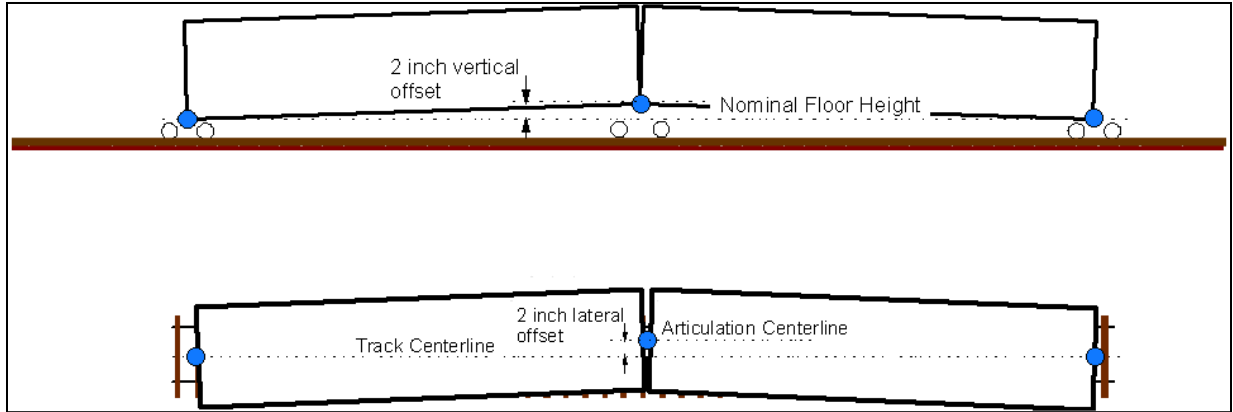
- 1) All cars in the moving and standing consists are positioned at their nominal running heights.
- 2) The first car-to-car interface of the initially-moving consist is perturbed laterally and vertically by 2 in.



**Figure 70. Location of Offsets in Moving Consist**



**Figure 71. Illustration of Offset for Coupled Cars**



**Figure 72. Illustration of Offset for Articulated Cars**

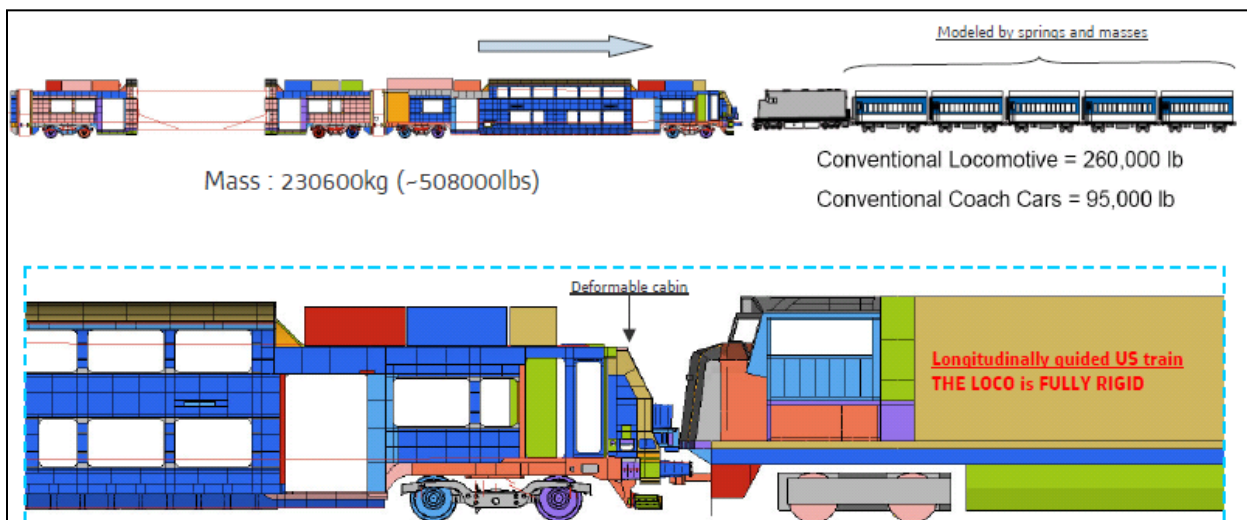
The pass/fail criteria are as follows:

- The relative difference in elevation between the underframes of the colliding and connected equipment shall not change by more than 4 in; and
- The tread of any wheel of the alternatively designed equipment shall not rise above the top of rail more than 4 in.

#### **4.6.2 Example Procedure**

Using a finite element model that included the first two cars of the passenger train and the rigid geometry of the standing locomotive, a dynamic crush analysis was conducted to evaluate the ideal impact conditions.

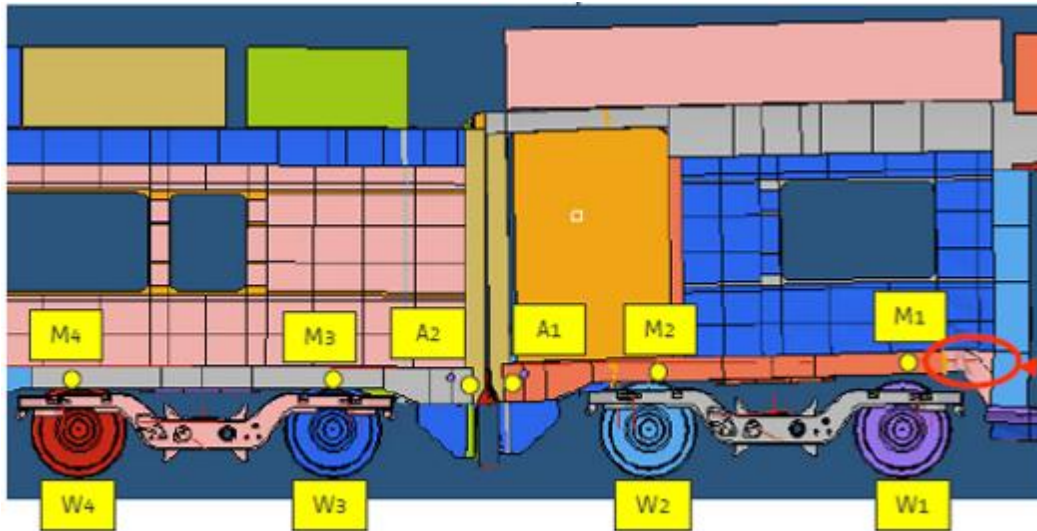
The same model can be used with different initial conditions for the offset impact condition. Figure 73 shows the model used for the ideal condition example analysis. This analysis was performed by Alstom, on a multilevel, MU trainset.



**Figure 73. Dynamic Crush Analysis: Ideal Impact Conditions (Courtesy of Alstom)**

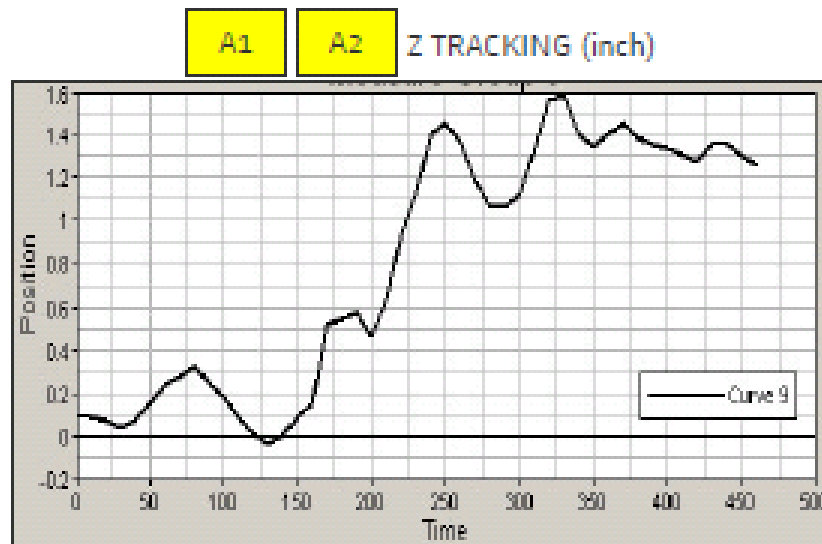
### 1.1.1 4.6.3 Example Key Results

Figure 74 is a graphic from the analysis at the time of maximum vertical displacement between the two cars at the first coupled interface. There are various labels on the figure indicating points that were tracked for vertical displacement. Also, in the lower-right portion of the figure there is a red oval around the gooseneck area of the underframe. There was a modest amount of permanent deformation at this location, which was the principal source of the vertical motion.



**Figure 74. Deformation in Coupled Car Dynamic Crush Analysis: Ideal Impact Conditions (Courtesy of Alstom)**

Figure 75 shows the time history of the relative vertical displacement between the two coupled cars shown in Figure 74. The maximum relative displacement is 1.6 in, which is less than the 4 in allowed by the criteria.



**Figure 75. Relative Vertical Displacement of the Underframes of Two Coupled Cars (Courtesy of Alstom)**

Figure 76 shows the vertical displacement-time history of the wheels seen in Figure 74. As can be seen on the plot shown in the figure, the wheels remain on the track for the entire simulation. This demonstrates compliance with the criteria that no wheel lifts above the rail by 4 in or more.

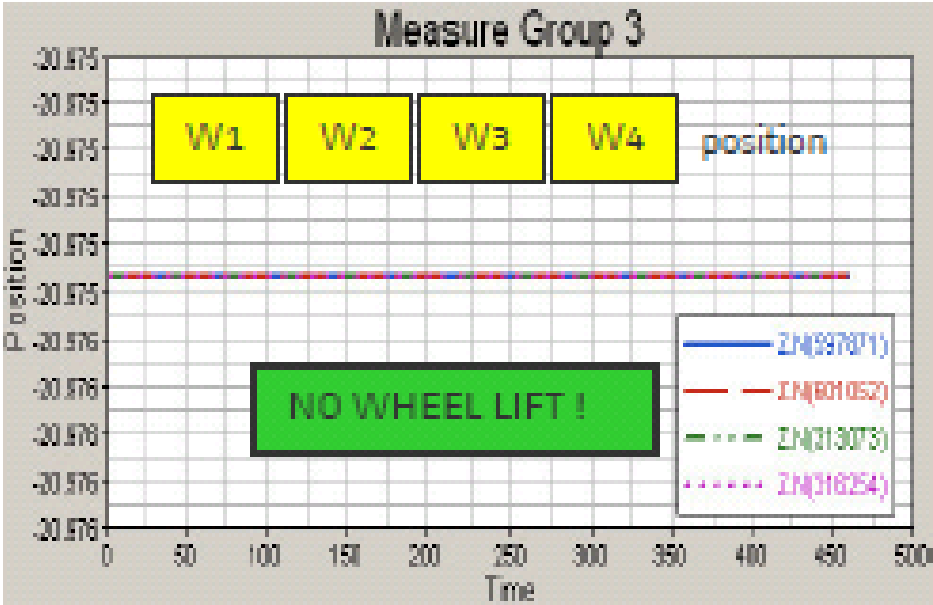


Figure 76. Vertical Displacement of Four Wheels (Courtesy Alstom)

## **4.7 Requirement – End Structure Integrity of Cab End**

This section describes analysis and test procedures that may be used to show compliance with 49 CFR 238, Appendix F. Three examples are provided: one based on a full-scale dynamic impact test of a conventional cab car, a second based on component tests for a conventional cab car, and a third based on component tests for a CEM cab. Analysis is used in all three cases, and an example procedure for analysis is described first. The full-scale tests are then described, followed by the component tests for the conventional cab car, and finally the component tests for the CEM cab car. Both quasi-static and dynamic tests are described for the CEM equipment. Three examples are provided in order to more fully describe the range of equipment that can be addressed with Appendix F and to more fully describe the range of procedures that may be used to show compliance. However, what is described here is illustrative and is not prescriptive. Other engineering procedures that provide a comparable level of confidence in the crashworthiness performance of the cab car end frame may also be used.

### **4.7.1 Criteria**

#### **Option**

#### **Title 49 CFR**

§ 238.209. Forward end structure of locomotives, including cab cars and MU locomotives

Appendix F to Part 238—Alternative Dynamic Performance Requirements for Front End Structures of Cab Cars and MU Locomotives

These subparts are excerpted in **Appendix B. Selected CFR References.**

\*\*\*\*\*

#### **4.7.2 Example Procedures**

Procedures for evaluating the end structure integrity for the cab end are divided into two major categories: analysis and testing. It is anticipated that a combination of testing and analysis will be used to demonstrate compliance with 49 CFR 238, Appendix F. Three testing example procedures are presented: a full-scale test of an entire car, a full-scale test of the end structure components, and a series of component tests for a CEM cab car.

##### **Example Procedures: Analysis**

Analysis is a crucial part of demonstrating that the requirements of the quasi-static or dynamic scenario are met. Analysis should be performed before designing any tests. For the corner and collision post test scenarios, a symmetric model cannot be used, because the loading is not symmetric. The model can be truncated in the longitudinal direction so that only the cab end is modeled. The model should contain sufficient length of the car so that there is no strain at the truncated end. The finite element model should be of the test condition, with the rigid indenter described in the rule. The model should show that the end frame meets the requirements in § 238.211 and § 238.213, or in Appendix F.

For the FRA prototype state-of-the-art (SOA) end frame design and the corresponding full-scale tests, a sophisticated finite element model was built and refined. On the basis of the results of the 2002 full-scale dynamic test in which a heavy steel coil impacted the corner post of an SOA end frame design, some fracture was expected in certain key end frame components during the 2008 tests. For this reason, a material failure model, based on the Bao-Wierzbicki fracture criterion, was implemented in the finite element model of the car end frame using the general purpose FE software program ABAQUS/Explicit. The finite element model with material failure was used to assess the effect(s) of fracture on the deformation behavior of the car end structures during quasi-static and dynamic testing. Particular attention was paid to the ability of such structures to absorb energy.

The material failure model was implemented in ABAQUS/Explicit for use with shell elements. A series of preliminary simulations was first conducted to assess the effects of element type and mesh refinement on the deformation and fracture behavior of structures similar to those found on cab car and MU locomotive end frames and to demonstrate that the Bao-Wierzbicki failure model can be effectively applied using shell elements.

Model parameters were validated through comparison to the results of the 2002 testing. Material strength and failure parameters were derived from test data for A710 steel. The model was then used to simulate the three full-scale tests that were conducted during 2008 as part of the FRA program—dynamic impact testing of a collision post, and quasi-static load testing of a collision post and a corner post. Analysis of the results of the two collision post tests revealed the need for revisions to both the design of some key end frame components and to key material failure parameters. With the revised model, pretest predictions for the outcome of the corner post test were found to be in very good agreement with the actual test results.

Overall, the results of the tests in comparison with their pretest analyses show that, at this time, actual testing is necessary to demonstrate performance. However, as modeling methods improve

and are shown to predict failure and energy absorption more accurately, there is the potential that use of analysis alone will in the future be acceptable for demonstrating crashworthiness performance.

### **Example Procedure: Full-Scale Test**

For the example test, a 14,000-pound cart impacted a standing cab car at a speed of 18.7 mph. The cart had a rigid coil shape mounted on the leading end that concentrated the impact load on one collision post. The requirements for protecting the engineer's space state that there can be no more than 10 in of longitudinal deflection, and none of the attachments of any of the structural members may separate. Figure 77 shows still photographs of the test, taken from the high-speed video.



**Figure 77. Still Photographs from High-Speed Video, Collision Post Test**

During the test, the collision post deformed inward by approximately 7.4 in and absorbed approximately 138,000 ft-lb of energy. The attachment between the post and the roof member (AT beam) remained intact. The connection between the post and the floor member (buffer beam) did not completely separate; however, the forward flange and both side webs fractured. The post itself did not completely fail. There was material failure in the back and the sides of the post at the impact location. Overall, the end frame was successful in absorbing energy and preserving space for the operating crew and the passengers.

### **Example Procedure: End Frame Component Test**

For some designs, including the SOA end frame, it may be permissible to run a component test of the end frame of the car rather than a test of the entire vehicle. An analysis of the scenario, either quasi-static or dynamic, should be performed. This test is appropriate when pretest analysis shows the end frame deforms to meet the scenario requirements, but the carbody inboard of the end frame does not deform.

Figure 78 and Figure 79 show the equivalent plastic strain taken from pretest finite element models of the SOA corner and collision posts. Dashed red lines on the figures indicate where the end frame could be truncated for a component test. For this end frame, the longitudinal connecting members for the AT beam and the buffer beam experience deformation, whereas the roof rails and the side sill do not. Also, the draft sill does not experience deformation.

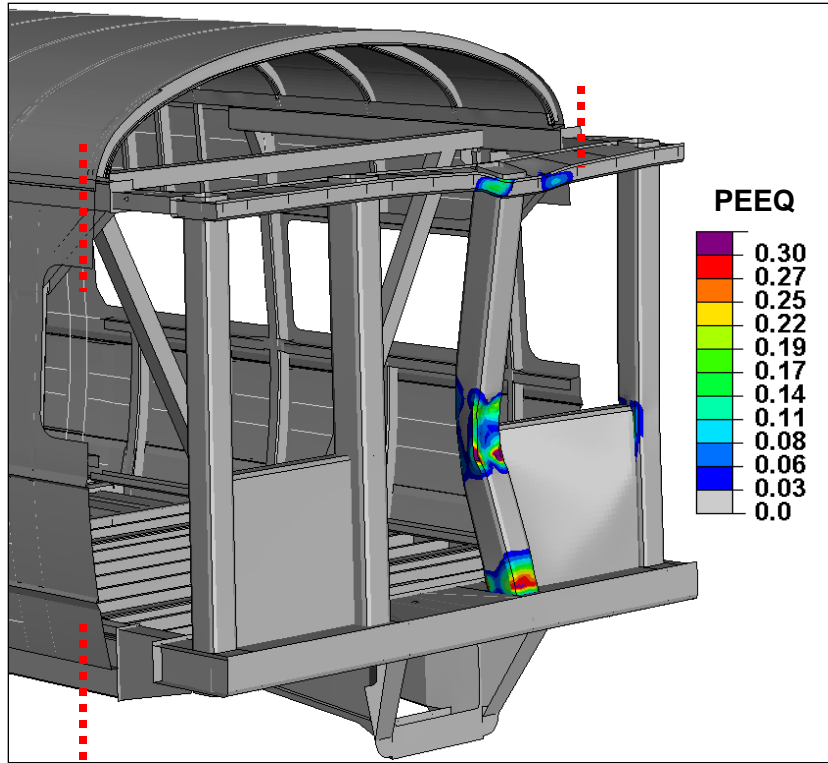


Figure 78. Contours of Equivalent Plastic Strain for the Quasi-Static Collision Post Load Case

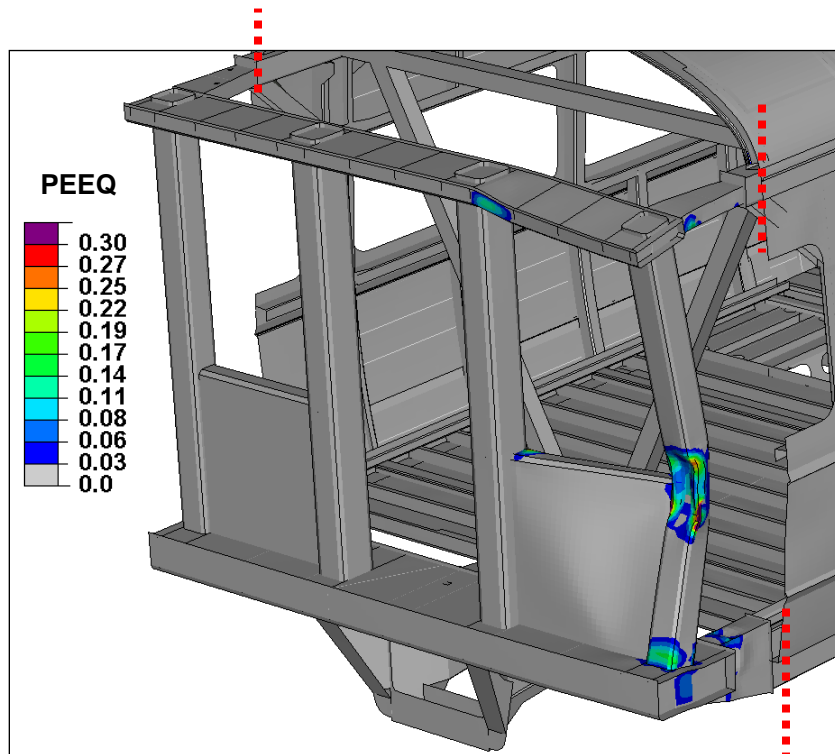
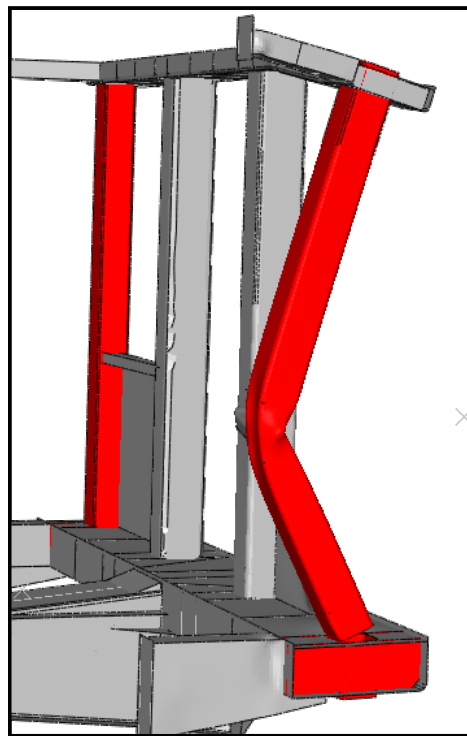


Figure 79. Contours of Equivalent Plastic Strain for the Quasi-Static Corner Post Load Case



Once the deformable region has been determined, a test component and a test fixture need to be designed. The test component for the SOA end frame is similar to the component shown in Figure 80. The test component contains all the parts that are likely to deform under the scenario, as shown by the analysis. The test fixture should be designed to hold the component fixed, possibly against a wall or on the ground. Once the test fixture and the test component have been designed and fabricated, a quasi-static or dynamic load can be imparted to the test article. The energy imparted to the test article should be equal to or greater than 135,000 ft-lb for the collision post location and  $\geq 120,000$  ft-lb for the corner post location. The structure should deform by less than 10 in while absorbing the required amount of energy. A separate test should be run for each location. Although it is permissible to use the very same test specimen to demonstrate compliance with both of these sections, the forces imparted to the test specimen for purposes of demonstrating compliance with one set of these requirements may weaken the sample structurally and thus make it more difficult to demonstrate compliance with the other set of requirements. Consequently, the final rule does not impose the additional obligation to use the very same test specimen to demonstrate compliance with both the requirements of § 238.211 and those of § 238.213.



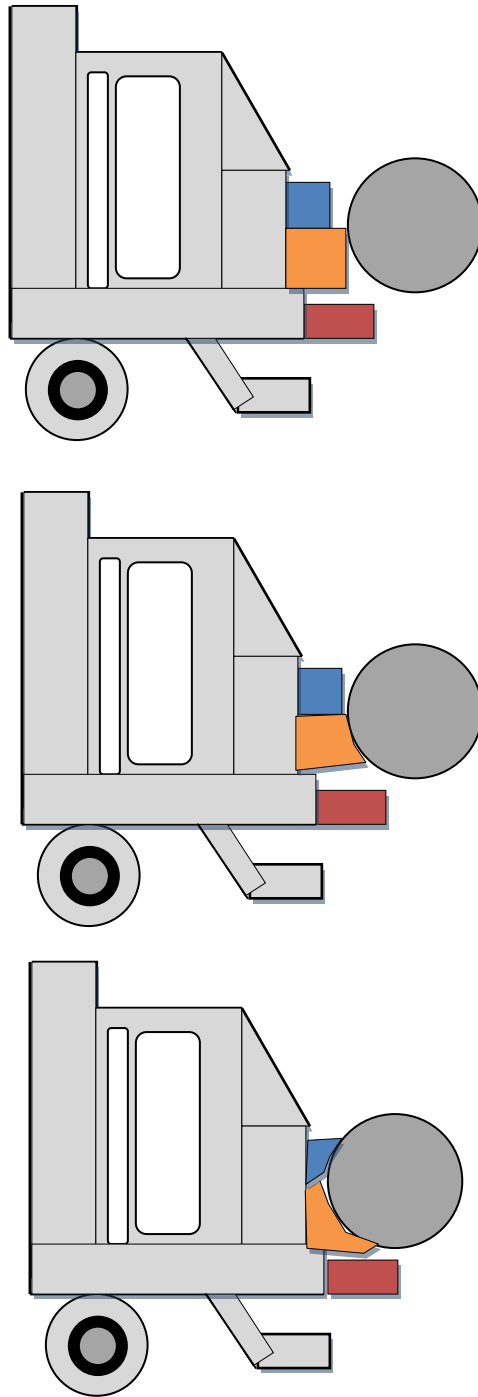
**Figure 80. Test Component Approximation for Component Test**

Once the FE model has been validated, particularly the modeling of fracture, it is possible that future minor modifications to the end frame design can be evaluated using analysis only, rather than testing.

### **Combined Component Test and Analysis: Crushable Component Example**

For some designs, it might be permissible that only crushable elements will need to be tested. For this to occur, the analysis must show that nearly all the required energy is absorbed in the crushable elements. The support structure to the crushable elements must not appreciably deform.

Figure 81 shows an example CEM cab car design with crushable components. For this hypothetical scenario, all the energy is absorbed by the crushable elements. The analysis should show that no energy is absorbed by the supporting structure. For this example, either the quasi-static or the dynamic scenario can be evaluated.



**Figure 81. Example Analysis Results of Car with Deformable Energy Absorbers**

Figure 82 shows an example of a dynamic drop tower test of a CEM crushable component. Figure 83 shows an example of a quasi-static test of a CEM crushable component. Either type of test is acceptable for a component test. The test instrumentation should measure key characteristics of the component, including force-crush behavior and mode of deformation. The results of the component test should be compared with the analysis predictions. The analysis should be refined to match the test results if necessary.



**Figure 82. Example of a Dynamic Drop Tower Test of a CEM Component**



**Figure 83. Example of a Quasi-Static Test of a CEM Component**

Table 6 summarizes the analyses and tests conducted to verify that the design complies with Appendix F. Detailed analyses are performed on the components and on the car. The component models are verified with tests. The component models are used to assemble the car model.

**Table 6. Example Matrix of Component Testing and Analyses**

<b>Component</b>	<b>Detailed Analysis</b>		<b>Component Testing</b>
	Component Level	Car Level	
Outboard Energy Absorber	Yes	Yes	Dynamic
Center Energy Absorber	Yes	Yes	Static

## **4.8 Requirement – End Structure Integrity of Noncab End**

### **4.8.1 Criteria**

#### **Collision Post Option**

Collision posts are not required for equipment with pushback couplers and interlocking anti-climbers, intercar connection is capable of preventing disengagement and telescoping to the same extent as equipment satisfying the anticlimbing and collision post requirements contained in 49 CFR Part 238. (See Option for § 238.205, Anticlimbing mechanism, for description of criteria for determining whether the connection is capable of preventing disengagement and telescoping to that extent.)

#### **Corner Post Option**

(a) Each passenger car shall have at each end of the car, placed ahead of the occupied volume, two side structures capable of resisting:

- (1) A 150,000-pound horizontal force applied at floor height without failure;
- (2) A 20,000-pound horizontal force applied at ceiling height without failure; and
- (3) A 30,000-pound horizontal force applied at a point 18 in above the top of the floor without permanent deformation.

(b) For the purposes of this option, the orientation of the applied horizontal forces shall range from longitudinal inward to transverse inward.

## 4.8.2 Example Procedures

### Criteria 1: 150,000 lb at Underframe Attachment without Failure

#### Analysis Method

There are multiple ways of demonstrating compliance through analysis, such as 1) manual calculations or 2) a quasi-static nonlinear finite element model of the end structure that incorporates material failure. The load may be introduced through a rigid indenter with an area no larger than  $6 \times 6$  in that is applied to the vehicle at the point of attachment of the side structure to the underframe. The resulting force-crush curve must show that the structure can withstand 150,000 lb with no structural failure anywhere in the vehicle. Figure 84 shows a schematic of the load application scenario.

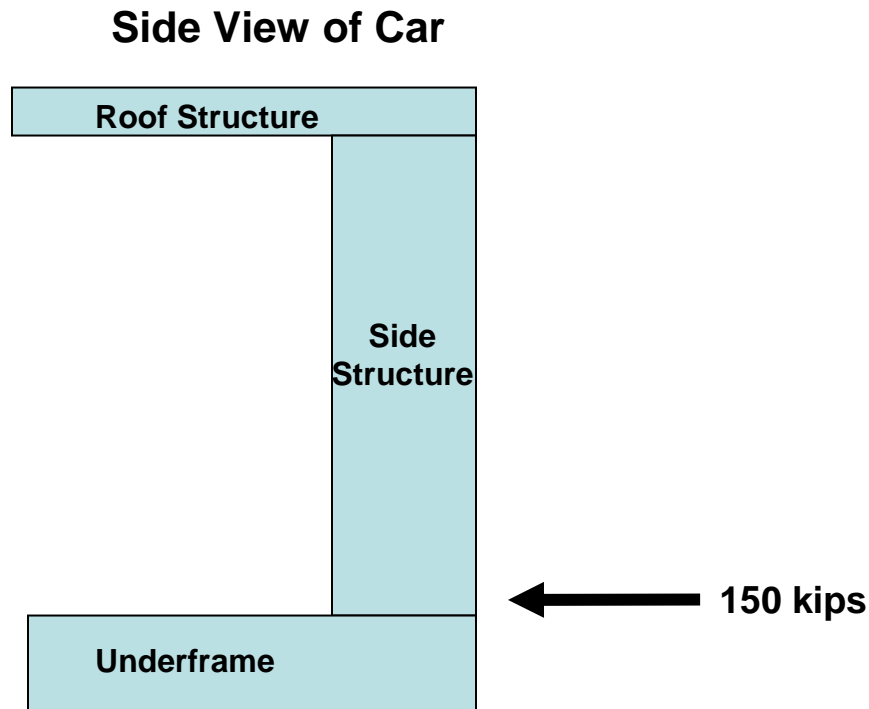


Figure 84. Side View of Car Showing 150-Kilopound Load

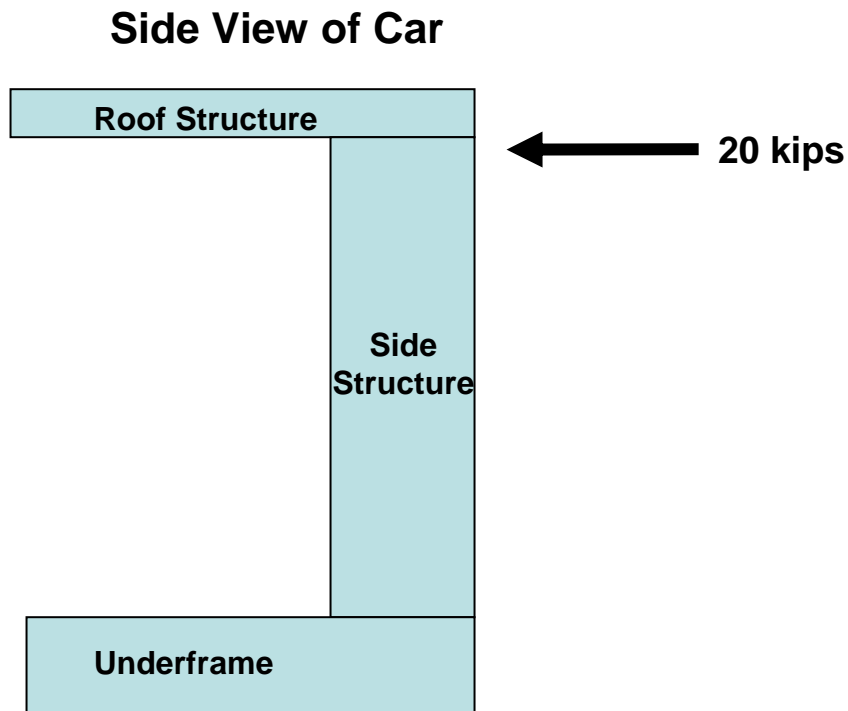
#### Testing Method

Compliance may be demonstrated with a full-scale vehicle test. A test fixture with an area no larger than  $6 \times 6$  in may be used to apply the load at the point of attachment of the side structure to the underframe. The resulting measured force-crush curve must show that the structure can withstand 150,000 lb with no structural failure anywhere in the vehicle.

## Criteria 2: 20,000 lb at Roof Attachment without Failure

### Analysis Method

There are multiple ways of demonstrating compliance through analysis, such as 1) manual calculations or 2) a quasi-static nonlinear finite element model of the end structure that incorporates material failure. The load may be introduced through a rigid indenter with an area no larger than  $6 \times 6$  in that is applied to the vehicle at the point of attachment of the side structure to the roof structure. The resulting force-crush curve must show that the structure can withstand 20,000 lb with no structural failure anywhere in the vehicle. Figure 85 shows a schematic of the load application scenario.



**Figure 85. Side View of Car Showing 20-Kilopound Load**

### Testing Method

Compliance may be demonstrated with a full-scale vehicle test. A test fixture with an area no larger than  $6 \times 6$  in may be used to apply the load at the point of attachment of the side structure to the roof structure. The resulting measured force-crush curve must show that the structure can withstand 20,000 lb with no structural failure anywhere in the vehicle.



### Criteria 3: 30,000 lb 18 in above Floor without Permanent Deformation

#### Analysis Method

There are multiple ways of demonstrating compliance through analysis, such as 1) manual calculations or 2) a quasi-static nonlinear finite element model of the end structure that incorporates material failure. The load may be introduced through a rigid indenter with an area no larger than  $6 \times 6$  in that is applied to the vehicle at the side structure 18 in above the level of the floor. The analysis must show that the structure can withstand 30,000 lb with no permanent deformation anywhere in the vehicle outside of the point of load application.

Figure 86 shows a schematic of the load application scenario. Figure 87 shows an example of the load being applied to a finite element model with a rigid indenter.

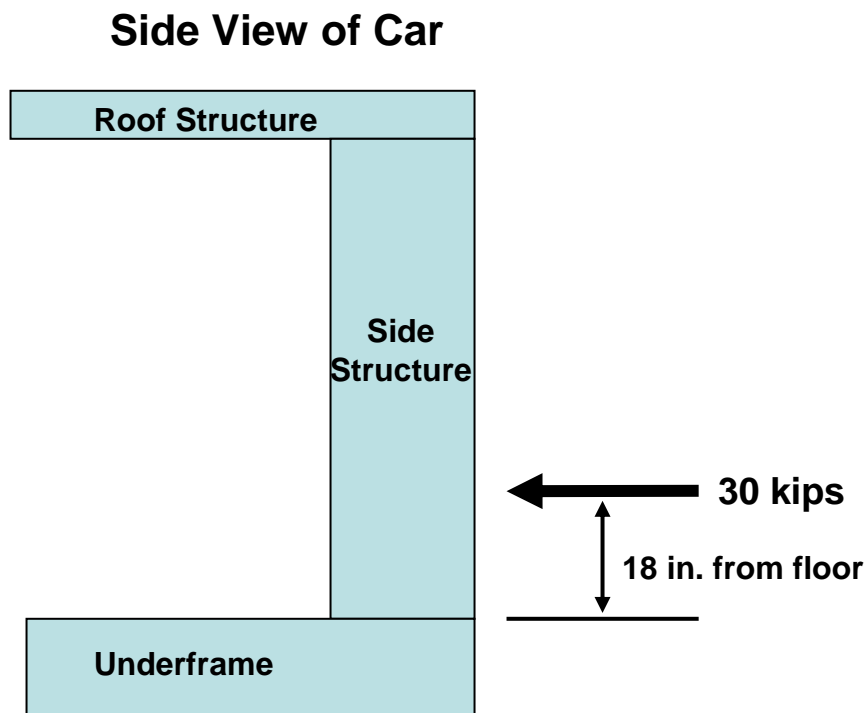
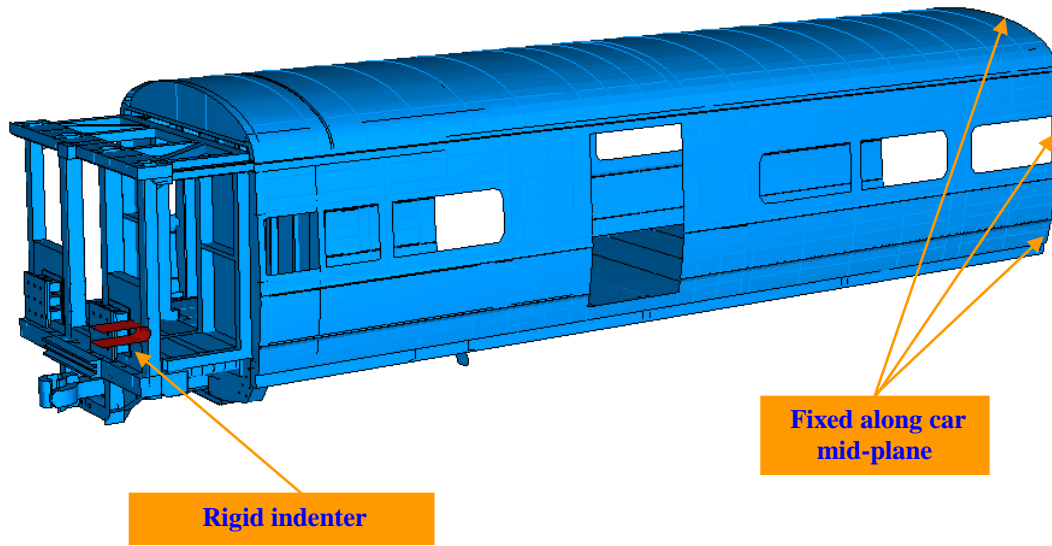


Figure 86. Side View of Car Showing 30-Kilopound Load



**Figure 87. Finite Element Model Showing Side Structure Load and Boundary Conditions**

### **Testing Method**

Compliance may be demonstrated with a full-scale vehicle test. A test fixture with an area no larger than  $6 \times 6$  in may be used to apply the load to the side structure 18 in above the floor. The resulting measurements must show that the structure can withstand 30,000 lb with no permanent deformation anywhere in the vehicle.

## 4.9 Requirement: Truck Attachment

This section includes the criteria and example procedures for evaluating truck attachment strength. The procedures and results in this section show the types of analyses and results that demonstrate compliance with the criteria. Other procedures may be followed in demonstrating compliance.

### 4.9.1 Criteria

The following options are provided as alternatives to the stated regulation in order to demonstrate sufficient truck-to-car-body attachment. The equipment must comply with either the regulation or at least one of these alternatives to demonstrate compliance with the criteria stated in this document.

#### Option A

Passenger equipment shall have a truck-to-carbody attachment with strength sufficient to resist without yield the following individually applied quasi-static loads on the mass of the truck at its CG: 3g vertically; 5g longitudinally, along with the resulting vertical reaction to this load; and 1g laterally, along with the resulting vertical reaction to this load. For the purposes of this option, the mass of the truck includes axles, wheels, bearings, the truck-mounted brake system, suspension system components, and any other component attached to the truck by design.

In addition, for the nominal initial condition given in the scenario described in **Section 3.1**:

- The average longitudinal deceleration of the car during the impact shall not exceed 5g; and
- The peak longitudinal deceleration of the truck shall not exceed 10g.

\*\*\*\*\*

#### Option B

Passenger equipment shall have a truck-to-carbody attachment with strength sufficient to resist without yield the following individually applied quasi-static loads on the mass of the truck at its CG: 3g vertically and 1g laterally, along with the resulting vertical reaction to these loads. For the purposes of this option, the mass of the truck includes axles, wheels, bearings, the truck-mounted brake system, suspension system components, and any other component attached to the truck by design.

In addition, the truck shall remain attached during the scenario described in **Section 3.1**.

\*\*\*\*\*

### 4.9.2 Example Procedure

The truck attachment was evaluated using Option A in this example. This evaluation was made through the results of a single simulation. This simulation was performed for ideal, in-line initial conditions. This same simulation was also used to evaluate the **Scenario** (described in **Section 3.1**), **Colliding Equipment Override (Section 3.3)**, and **Connected Equipment Override (Section 3.4)**. The model is shown in Figure 73.

### 4.9.3 Example Results

Figure 88 shows the deceleration-time history of the cab car described in **Section 4.8** and Figure 89 shows the deceleration-time history of the lead truck of that cab car. As shown in Figure 88, the average deceleration of the cab car was just over 4g, which is less than the 5g permitted by the criteria. The average deceleration was calculated from initial contact between the cab car and locomotive until the contact force dropped to 0. The peak deceleration of the cab car is 15g, which is nearly four times the average deceleration. The cab car deceleration time-history shown in Figure 88 is a direct output from the simulation. As shown in Figure 89, the maximum deceleration of the truck is 10g, which is the maximum permitted by the criteria. The truck deceleration time-history is also a direct output from the simulation and has been filtered with a zero-phase fourth-order Butterworth filter meeting the SAE CFC 100 specification. The simulation results indicate both of the criteria are met.

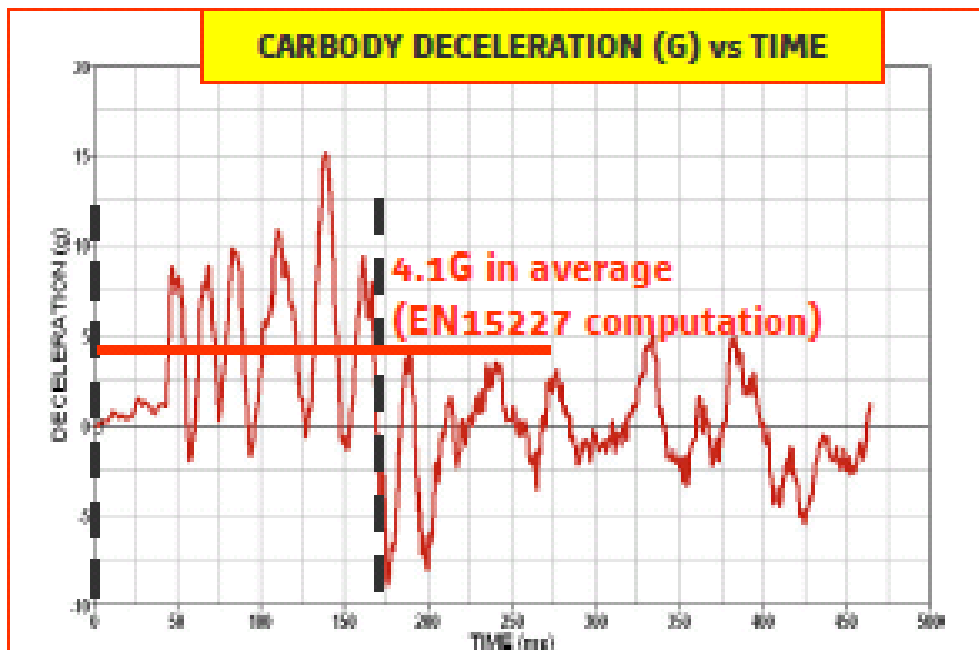


Figure 88. Cab Car Deceleration-Time History (Courtesy of Alstom)

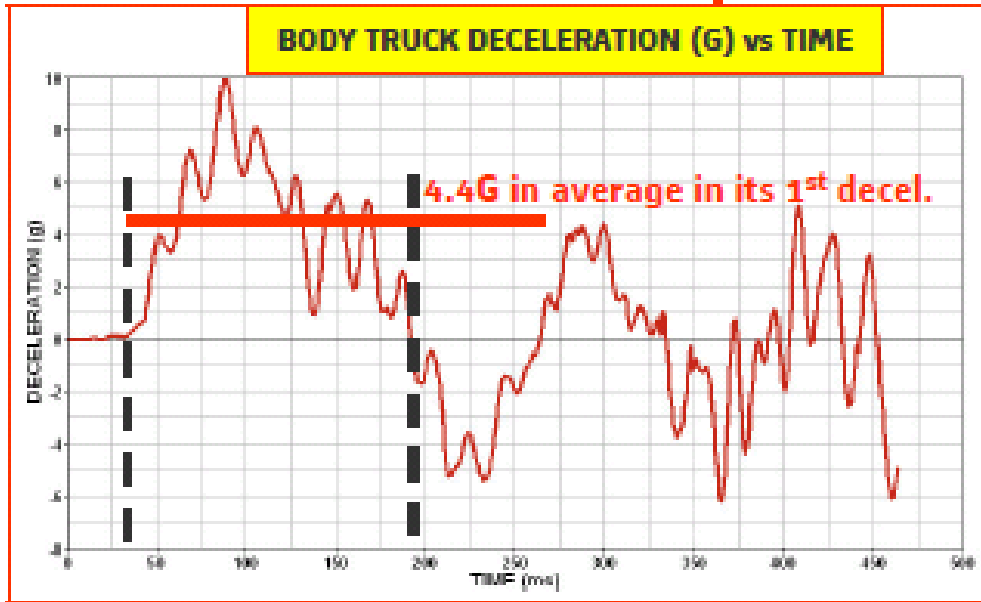


Figure 89. Cab Car Lead Truck Deceleration-time History (Courtesy of Alstom)

#### **4.10 Summary and Next Steps**

Criteria and procedures for assessing the crashworthiness and occupant protection performance of alternatively designed equipment to be used in Tier I service have been developed. These criteria and procedures take advantage of the latest technology in rail equipment crashworthiness; they also include aspects that are fundamentally different from current regulations, such as the scenario-based, train-level requirements. No such requirements are specified in FRA's current Tier I regulations. Numerical values of the pass/fail criteria have been selected to provide a level of crashworthiness equivalent to the current Tier I regulations. For example, the OVI requirements have been relaxed from the current regulations, and criteria for preservation of the occupied volume for a collision with a conventional locomotive-led train have been added to compensate. In other cases, such as for roof integrity, the existing regulations can be directly applied to alternatively designed equipment and are unchanged.

Because the latest technology in rail equipment crashworthiness has been used as a basis for the criteria and procedures, many aspects of the resulting criteria and procedures are fundamentally different from their corresponding regulations. Although technical results from sophisticated analyses and tests have been necessary, judgment was also needed to develop the criteria and procedures. This judgment was provided by ETF and accepted by FRA. It is anticipated that the product of this effort—the criteria and procedures—and the process used—the government/industry working group—will serve as the model for the development of criteria and procedures by which to evaluate alternatively designed passenger equipment with other safety regulations.

## 5. References

---

1. Tyrell, D., Martinez, E., Jacobsen, K., Parent, D., Severson, K., Priante, M., & Perlman, A. B. *Overview of a Crash Energy Management Specification for Passenger Rail Equipment*, American Society of Mechanical Engineers, Paper No. JRC2006-94044, April 2006.
2. Code of Federal Regulations, Title 49, Part 238, Subpart E—Specific Requirements for Tier II Passenger Equipment.
3. EN 15227, Railway Applications—Crashworthiness Requirements for Railway Vehicle Bodies, Ref. No. EN15227:2008:E.
4. Tyrell, D., & Tsai, T. *Improved Crashworthiness of Rail Passenger Equipment in the United States*, World Congress on Railway Research, Montreal, Canada, June 2006.
5. Lacôte, F., Cléon, L.-M., Lagneau, H., Dannawi, M., Demonsant, E., & Wiart, A. *Les Tolérances à la Collision Des Matériaux Ferroviaires*, Revue générale des chemin de fer, Gauthier-Villars, November 1993.
6. Scholes, A., & Lewis, J. *Development of Crashworthiness for Railway Vehicle Structures*, Proceeding of the Institute of Mechanical Engineers, Vol. 207 Part F: Journal of Rail and Rapid Transit, 1993.
7. Tyrell, D. C., & Perlman, A. B. *Evaluation of Rail Passenger Equipment Crashworthiness Strategies*, Transportation Research Record No. 1825, pp. 8-14, National Academy Press, 2003.
8. Bing, A. *Collision Avoidance and Accident Survivability, Volume 1: Collision Threat*, DOT/FRA/ORD-93-02.I, FRA, U.S. Department of Transportation, 1993.
9. Tyrell, D., Jacobsen, K., & Martinez, E. *A Train-to-Train Impact Test of Crash Energy Management Passenger Rail Equipment: Structural Results*, American Society of Mechanical Engineers, Paper No. IMECE2006-13597, November 2006.
10. Carolan, M., & Muhlanger, M. *Strategy for Alternative Occupant Volume Testing*, American Society of Mechanical Engineers, Paper No. RTDF2009-18025, October 2009.
11. Tyrell, D. C., Severson, K. J., & Marquis, B. J. *Analysis of Occupant Protection Strategies in Train Collisions*, American Society of Mechanical Engineers, AMD-Vol. 210, BED-Vol. 30, pp. 539-557, 1995.

12. Parent, D., Tyrell, D., & Perlman, A. B. *Evaluating Abdominal Injury in Workstation Table Impacts*, Compendium of Papers, 84th Annual Meeting, Transportation Research Board, January 2005.
13. Severson, K., Perlman, A. B., & Stringfellow, R. *Quasi-Static and Dynamic Sled Testing of Prototype Commuter Rail Passenger Seats*, American Society of Mechanical Engineers, Paper No. JRC2008-63051, April 2008.
14. Carolan, M. *Evaluation of Occupant Volume Strength in Conventional Passenger Railroad Equipment*, Tufts University Master's Thesis, May 2008
15. Tyrell, D. *Passenger Rail Train-to-Train Impact Test Volume I: Overview and Selected Results*, U.S. Department of Transportation, DOT/FRA/ORD-03/17.I, July 2003.
16. Tyrell, D., & Martinez, E. *A Train-to-Train Impact Test of Crash Energy Management Passenger Rail Equipment*, Sixth International Symposium on the Passive Safety of Rail Vehicles, Berlin, Germany, December 2006.
17. Rancatore, B., Llana, P., Van Ingen-Dunn, C., & Bradney, C. *Occupant Protection Experiments in Support of a Full-Scale Train-to-Train Crash Energy Management Equipment Collision Test*, U.S. Department of Transportation, DOT/FRA/ORD-09/14, July 2009.
18. Parent, D., Tyrell, D., Rancatore, R., & Perlman, A. B. *Design of a Workstation Table with Improved Crashworthiness Performance*, American Society of Mechanical Engineers, Paper No. IMECE2005-82779, November 2005.
19. Tyrell, D., Jacobsen, K., Parent, D., & Perlman, A. B. *Preparations for a Train-to-Train Impact Test of Crash-Energy Management Passenger Rail Equipment*, American Society of Mechanical Engineers, Paper No. IMECE2005-70045, March 2005.
20. Severson, K., & Parent, D. *Train-to-Train Impact Test of Crash Energy Management Passenger Rail Equipment: Occupant Experiments*, American Society of Mechanical Engineers, Paper No. IMECE2006-14420, November 2006.
21. Code of Federal Regulations, Title 49, Part 571, Standard No. 208, Occupant Crash Protection, October 2002.
22. APTA SS-C&S-016-99, Rev. 1, Standard for Row-to-Row Seating in Commuter Rail Cars, American Public Transportation Association, Washington, DC.
23. Code of Federal Regulations, Title 49, Part 238, Subpart C—Specific Requirements for Tier I Passenger Equipment.



24. EN12663, Railway Applications – Structural Requirement of Railway Vehicle Bodies – Part 1: Railway Vehicles Other than Freight Wagons, Ref. No. prEN12663-1:2007
25. Cothen, G., Schulte, C., Horn, J., & Tyrell, D. *Consensus Rulemaking at the Federal Railroad Administration*, TR News, Transportation Research Board, Number 236, January-February 2005.
26. Priante, M., Tyrell, D., & Perlman, A. B. *The Influence of Train Type, Car Weight, and Train Length on Passenger Train Crashworthiness*, American Society of Mechanical Engineers, Paper No. IMECE2005-70042, March 2005.
27. National Transportation Safety Board. *Head-On Collision between BNSF and Metrolink Trains, and Subsequent Derailment, in Placentia, California on April 23, 2002: Factual Report, Survival Factors Issues*. DCA- 02-MR-004, 2/20/03.
28. Petition of Peninsula Joint Powers Board/Caltrain for Approval of Mixed Use and Waiver of Certain Federal Railroad Administration Regulations Pursuant to 49 CFR Section 238.203, 49 CFR Section 238.205, 49 CFR Section 238.207, 49 CFR Section 238.211, 49 CFR Section 238.213. Docket ID: FRA-2009-0124.
29. American Public Transportation Association, Member Services Department, Manual of Standards and Recommended Practices for Passenger Rail Equipment, Issue of July 1, 1999.
30. Tyrell, D., Severson, K., Zolock, J., & Perlman, A. B. *Passenger Rail Two-Car Impact Test Volume I: Overview and Selected Results*, U.S. Department of Transportation, DOT/FRA/ORD-01/22.I, January 2002.
31. Jacobsen, K., Tyrell, D., & Perlman, A. B. *Impact Tests of Crash Energy Management Passenger Rail Cars: Analysis and Structural Measurements*, American Society of Mechanical Engineers, Paper No. IMECE2004-61252, November 2004.
32. National Transportation Safety Board. *Railroad Accident Report: Head-On Collision of Boston and Maine Corporation Extra 1731 East and Massachusetts Bay Transportation Authority Train No. 570 on Former Boston and Maine Corporation Tracks, Beverly, Massachusetts, August 11, 1981*, PB82-916301, NTSB-RAR-82-1, 1982.
33. Jacobsen, K. *Collision Dynamics Modeling of Crash Energy Management Passenger Rail Equipment*, Tufts University Master's Thesis, January 2008.
34. National Transportation Safety Board. *Railroad Accident Report: Collision of Metrolink Train 111 with Union Pacific Train LOF65-12 Chatsworth, California, September 12, 2008*, RAR-10-01.

35. Tyrell, D. C., Martinez, E. E., & Wierzbicki T. *Crashworthiness Studies of Locomotive Wide Nose Short Hood Designs, Crashworthiness, Occupant Protection and Biomechanics in Transportation Systems*. American Society of Mechanical Engineers, AMD Vol. 237/BED Vol. 45, 1999.
36. Thompson, W. T. *Theory of Vibration with Applications*, Prentice-Hall, Inc., 1981.
37. Tyrell, D. C., Severson, K. J., & Marquis, B. J. *Crashworthiness of Passenger Trains*, U.S. Department of Transportation, DOT/FRA/ORD-97/10, 1998.
38. Code of Federal Regulations, Title 49, Appendix F to Part 238—Alternative Dynamic Performance Requirements for Front End Structures of Cab Cars and MU Locomotives.

## **Appendix A. Selected Train Incidents**

---

Passenger train accidents can occur under a wide range of circumstances, but those that can be mitigated by crashworthiness features of the train can be placed into three broad categories:

1. Collisions with another train
2. Collisions with objects, such as at a grade-crossing
3. Single train events, such as a derailment

Further classifications can be made within each of these categories. For example, significant differences may be expected for a conventional locomotive-led train colliding with another conventional locomotive-led train than for a conventional locomotive-led train colliding with a cab car-led train. Track route alignment can also significantly influence the consequences of a collision; the consequences of a head-on collision on tangent track may be expected to be significantly different from an oblique collision at a switch. Similarly, the consequences of a grade-crossing collision with a heavy highway truck are likely to be significantly different from a grade-crossing collision with an automobile. For all accident types, the collision speed can also profoundly influence the consequences of the collision. Categorizing the accidents facilitates calculation of the likelihood of an accident within a collision category as well as the development of strategies for protecting the occupants for accidents in that collision category.

This appendix describes one accident in each of the categories to illustrate the types of threats that crashworthiness features are intended to mitigate.

### **Collisions with another Train**

Train-to-train collisions include collisions between a passenger train and a freight train, as well as collisions between a cab car-led train and a conventional locomotive-led train.

#### The Glendale Incident

Figure A1 shows a photograph of the incident that occurred in Glendale, CA, on January 26, 2005. Eight of the 11 fatalities occurred in Metrolink train 100, the southbound cab car-led passenger train. Three of the fatalities occurred in train 901, the northbound conventional locomotive-led passenger train. The trailing cab car from train 901 is on its side, shown in the middle right side of the photograph. This incident was investigated by several of the authors, as part of FRA's ongoing field study of injuries and fatalities in passenger train accidents [12].



**Figure A1. Aerial Photograph of Glendale Incident**

Train 100, traveling south at 62 mph, collided with a sport utility vehicle (SUV), which was situated perpendicular to the track with its front wheels between the rails. This impact occurred approximately 150 feet southeast of the grade crossing at Chevy Chase Drive. The SUV was lower than it would have been at a grade crossing, with the wheels of the SUV on the ties and ballast, below the running surface of the rails. This situation made it easier for some part of the SUV to get under the cab car and derail it. The Glendale incident involved three collisions:

1. The initial collision of train 100 with the SUV. Some part of the SUV—the engine block, transmission, differential, or other solid piece—became trapped under the cab car. The cab car then encountered special track work—switch components. The solid piece from the SUV interacted with the switch components in such a way that the front end of the cab car entered a siding. The back end of the cab car and the trailing equipment remained on the mainline track. These events led to:
  - a) A collision of train 100 with the freight train parked in the siding. The front of the cab car impacted a six-axle freight locomotive coupled to a second six-axle freight locomotive in turn coupled to a number of cars loaded with ballast. The impact with the freight locomotive crushed the front end of the cab car, shortening the cab car by more than 26 feet. Before impact with the locomotive, the cab car was skewed. The lead truck of the cab car derailed and was guided by the rails of the siding track into the freight locomotive. The rear truck of the cab car appears to have stayed on the mainline track so that the cab car was traveling with the front on one track and the back on another track. The impact with the freight locomotive appears to have caused the back

of the cab car to derail and swing out further into the right-of-way of the adjacent second mainline track. These events led to:

- b) A raking collision of trains 100 and 901. As the back end of train 100's cab car swung around, it struck the side of train 901, which was traveling north at 51 mph. The back end of train 100's cab car and the front end of train 100's first trailer car first impacted the side of train 901's middle passenger car, and proceeded to rake down the side of train 901.

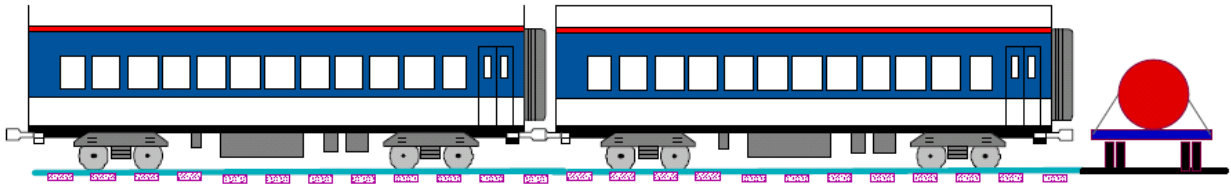
Metrolink, a commuter rail authority in Los Angeles, CA, was preparing to purchase new equipment at the time of this fatal incident in Glendale. As part of its response to the incident, Metrolink decided to incorporate recent results of the Volpe Center's passenger train crashworthiness research to its ongoing procurement. In coordination with APTA, Metrolink approached FRA and the Federal Transit Administration (FTA) to develop design specifications. In turn, FRA and FTA formed the ad hoc Crash Energy Management Working Group in May 2005. This working group included government engineers and participants from the rail industry, including passenger railroads, suppliers, labor organizations, and industry consultants. The working group developed a detailed technical specification for crush zones in passenger cars for Metrolink to include in its procurement specifications, as well as for other passenger railroads to include in future procurements of their own. The specification is a guide to using CEM technology.

Metrolink released its specification in September 2005, as part of an invitation for bid. In May 2006, the award was made to Rotem, a division of Hyundai (now Hyundai Rotem Co.), that manufactures rail equipment. FRA and the Volpe Center are continuing to work with Metrolink, to help assure that the supplier meets the requirements. The first new equipment with these CEM features was delivered to Metrolink in March 2010 and was put into service by December 2010.

### **Collisions with Objects**

The category of Collisions with Objects includes any collision between a train and something other than another train, such as a collision with a highway vehicle at a grade-crossing, as well as a collision with a displaced intermodal trailer fouling the right-of-way.

On June 18, 1998, a cab car-led, two-car MU commuter train collided with a highway truck that had become immobilized at a grade-crossing in Portage, IN. The highway truck consisted of a tractor with two trailers. The trailers were loaded with coils of sheet steel. The second trailer, the one farthest from the tractor, was stopped on the tracks. The train collided with the second trailer, and during the impact, a coil of steel broke free and punctured the end of the cab car. The train was traveling at a speed between 69 and 109 kilometers per hour (43 and 68 mph) when it hit the highway truck. As a result of the collision, three people were killed: a deadheading railroad employee and two passengers. The initial conditions of the accident are shown schematically in Figure A2.



**Figure A2. Schematic Drawing of Portage, IN, Grade Crossing Collision**

Figure A3 shows postaccident photographs of the cab car, the highway truck trailer, and the coil of steel. The coil of steel weighed approximately 178 kN (40 kip) and was approximately 1.8 meters (6 feet) in diameter. It received little damage during the collision. The height of the floor of the trailer was several inches below the height of the floor of the cab car. Because of the shape of the coil, it moved upward when it hit the end of the cab car. As shown in the photograph, the coil of steel punctured the end of the cab car. The coil stopped inside the cab car after traveling about half the car's length, destroying about one-quarter of the passenger seats in the car.



**Figure A3. Postcollision Photographs of Cab Car, Truck Trailer, and Steel Coil Involved in Portage, IN, Grade Crossing Collision**

### Single Train Events

Single train events such as derailments can result in cars rolling on their sides or roofs. Such events are not generally associated with significant structural damage to the cars or loss of occupied volume due to structural crushing of the cars. Derailments can be associated with a large number of injuries and, often depending on the postderailment conditions, fatalities. Injuries such as those that have occurred during derailments can be mitigated with occupant protection measures.

On April 18, 2002, Amtrak Auto Train P052-18 derailed 21 of 40 cars on the CSXT near Crescent City, FL. The train was made up of 2 locomotives, 16 passenger cars, and 24 freight cars used for the transport of automobiles. The train was carrying 413 passengers and 33 Amtrak crewmembers. The train was traversing a left-hand curve at about 56 mph when the derailment occurred. As a result of the derailment, there were 4 fatalities, 36 serious injuries, and 106 minor injuries. Three fatalities were due to ejection through windows of the derailed cars. The fourth fatality was also due to ejection, but investigators were unable to determine where in the train the passenger was located at the time of derailment. The passenger may have been walking between cars when the train derailed.

Figure A4 shows an aerial view of the train postderailment. The two lead locomotive units and first two passenger cars remained upright and on the tracks. The 3rd through 23rd cars derailed, 16 of which were Amtrak Superliner passenger cars. Figure A6 shows the first derailed car in the train. The coupled connections remained attached between the first six derailed passenger cars.



**Figure A4. Aerial View of Crescent City Derailment on April 18, 2002 (from NTSB report)**

Figure A5 shows a photograph of the seventh passenger car as it is being uprighted. Two of the fatally injured passengers were in this car. As can be seen in the figure, most of the windows are not properly in their frames. Most of the windows appear to have been pushed in after the car derailed. There are scuffs and scrapes on the side of the car that suggest it slid some distance on its side. With the frames open, the ground would have been moving past the windows as the car slid. One potential mechanism for ejection is that a hand or a foot touched the ground, and the passenger was thereby pulled out of the car as it continued to slide.



**Figure A5. Seventh Passenger Car, Uprighted**

Figure A6 shows a photograph of the third passenger car. The couplers at both ends are intact and coupled up with the adjacent cars. Note also that all of the trucks visible are attached. None of the trucks became detached in this accident.





**Figure A6. View of First Derailed Passenger Car Looking toward Lead End of Train**

The photographs in Figure A7 show closeup views of the couplers at the lead and trailing end of the first derailed passenger car. The couplers can rotate to a significant angle—on the order of 30 degrees—before they are constrained by the support structure. The car is kept from tipping at least in part by the coupler at the leading end of the car, whereas the coupler at the trailing end is acting to roll the car over.



**Figure A7. Closeup Views of the Couplers of the First Derailed Passenger Car**

Figure A8 shows a photograph of a transition area in the train. The leading cars shown on the left are derailed but in line with the track. The cars in the middle of the photograph are derailed, perpendicular to the track, and are stacked side-to-side. The coupler between the in-line section and the stacked section is broken. The couplers in the stacked section broke during the accident. Behind the stacked section is another part of the train—the automobile-carrying freight cars. None of the freight car couplers is broken. The first freight car is neither parallel nor perpendicular to the track. It is at an angle in between, something less than 45 degrees. The freight cars behind it are at progressively smaller angles until they come into line with the track.



**Figure A8. View of Coupled Connection between Derailed Cars**

Figure A9 shows the trailing end of the seventh passenger car. This is the last car to remain in line. The coupler shank broke inboard, close to where it is connected to the coupler head. Most of the failed couplers failed in this manner.



**Figure A9. Trailing End of Seventh Passenger Car**

Figure A10 shows the coupler between the last passenger car and the first auto car. The couplers from the seventh passenger car to the last passenger car were all broken. The mode of coupler failure is the same for most of the couplers and is shown Figure A9. None of the couplers between the freight cars appeared to break. The couplers used on the freight cars are the same

design as used on the passenger cars. The loading condition shown in Figure A10 appears to be similar to the loading condition that caused the coupler failures.



**Figure A10. Coupler between the Last Passenger Car and the First Auto Car**

## Appendix B. Selected CFR References

---

The following are terms defined in § 238.5 (Definitions) that are used within this report. The complete text of § 238.5 contains other definitions that are not used in this report.

### § 238.5 Definitions

*Anti-climbing mechanism* means the parts at the ends of adjoining vehicles in a train that are designed to engage when subjected to large buff loads to prevent the override of one vehicle by another.

*Collision posts* means structural members of the end structures of a vehicle that extend vertically from the underframe to which they are securely attached and that provide protection to occupied compartments from an object penetrating the vehicle during a collision.

*Corner posts* means structural members located at the intersection of the front or rear surface with the side surface of a rail vehicle and which extend vertically from the underframe to the roof. Corner posts may be combined with collision posts to become part of the end structure.

*Crash energy management* means an approach to the design of rail passenger equipment which controls the dissipation of energy during a collision to protect the occupied volumes from crushing and to limit the decelerations on passengers and crewmembers in those volumes. This may be accomplished by designing energy-absorbing structures of low strength in the unoccupied volumes of a rail vehicle or passenger train to collapse in a controlled manner, while providing higher structural strength in the occupied volumes. Energy deflection can also be part of a crash energy management approach. Crash energy management can be used to help provide anti-climbing resistance and to reduce the risk of train buckling during a collision.

*Crewmember* means a railroad employee called to perform service covered by the Federal hours of service laws at 49 U.S.C. 21103 and subject to the railroad's operating rules and program of operational tests and inspections required in § 217.9 and § 217.11 of this chapter.

*Critical buckling stress* means the minimum stress necessary to initiate buckling of a structural member.

*End structure* means the main support structure projecting upward from the underframe of a locomotive, passenger car, or other rail vehicle. The end structure is securely attached to the underframe at each end of a rail vehicle.

*Fuel tank, external* means a fuel containment vessel that extends outside the car body structure of a locomotive.

*Fuel tank, internal* means a fuel containment vessel that does not extend outside the car body structure of a locomotive.

*Full-height collision post, corner post, or side frame post* means any vertical framing member in the rail car body structure that spans the distance between the underframe and the roof at the car body section where the post is located. For collision posts located at the approximate third points laterally of an end frame, the term “full-height” applies to posts that extend and connect to supporting structural members in the roof at the location of the posts, or to a beam connected to the top of the end-frame and supported by the roof rails (or anti-telescoping plate), or to both.

*In passenger service/in revenue service* means a train or passenger equipment that is carrying, or available to carry, passengers. Passengers need not have paid a fare in order for the equipment to be considered in passenger or in revenue service.

*In service*, when used in connection with passenger equipment, means:

- (1) Passenger equipment subject to this part that is in passenger or revenue service in the United States; and
- (2) All other passenger equipment subject to this part in the United States, unless the passenger equipment:
  - (i) Is being handled in accordance with §§ 238.15, 238.17, 238.305(d), or 238.503(f), as applicable;
  - (ii) Is in a repair shop or on a repair track;
  - (iii) Is on a storage track and is not carrying passengers; or
  - (iv) Has been delivered in interchange but has not been accepted by the receiving railroad.

*Interior fitting* means any component in the passenger compartment which is mounted to the floor, ceiling, sidewalls, or end walls and projects into the passenger compartment more than 25 mm (1 in.) from the surface or surfaces to which it is mounted. Interior fittings do not include side and end walls, floors, door pockets, or ceiling lining materials, for example.

*Lateral* means the horizontal direction perpendicular to the direction of travel.

*Locomotive* means a piece of on-track rail equipment, other than hi-rail, specialized maintenance, or other similar equipment, which may consist of one or more units operated from a single control stand with one or more propelling motors designed for moving other passenger equipment; with one or more propelling motors designed to transport freight or passenger traffic, or both; or without propelling motors but with one or more control stands. This term does not include a locomotive propelled by steam power unless it is used to haul an intercity or commuter passenger train. Nor does this term include a freight locomotive when used to haul a passenger train due to failure of a passenger locomotive.

*Locomotive cab* means the compartment or space on board a locomotive where the control stand is located and which is normally occupied by the engineer when the locomotive is operated.

*Locomotive, cab car* means rail rolling equipment intended to provide transportation for members of the general public that is without propelling motors but equipped with one or more control stands.

*Locomotive, MU* means rail rolling equipment self-propelled by any power source and intended to provide transportation for members of the general public; however, this term does not include an MU locomotive propelled by steam power unless it is used to haul an intercity or commuter passenger train.

*Longitudinal* means in a direction parallel to the normal direction of travel.

*95th-percentile adult male* means, except as used in §238.447(f)(2), a person weighing 215 pounds and possessing the following dimensions: erect sitting height: 38 inches; hip breadth (sitting): 16.5 inches; hip circumference (sitting): 47.2 inches; waist circumference (sitting): 42.5 inches; chest depth: 10.5 inches; and chest circumference 44.5 inches.

*Occupied volume* means the volume of a rail vehicle or passenger train where passengers or crewmembers are normally located during service operation, such as the operating cab and passenger seating and sleeping areas. The entire width of a vehicle's end compartment that contains a control stand is an occupied volume. A vestibule is typically not considered occupied, except when it contains a control stand for use as a control cab.

*Ordered*, as applied to acquisition of equipment, means that the acquiring entity has given a notice to proceed to manufacture the equipment that represents a firm financial commitment to compensate the manufacturer for the contract price of the equipment or for damages if the order is nullified. Equipment is not ordered if future exercise of a contract option is required to place the remanufacturing process in motion.

*Override* means to climb over the normal coupling or side buffers and linking mechanism and impact the end of the adjoining rail vehicle or unit above the underframe.

*Passenger car* means rail rolling equipment intended to provide transportation for members of the general public and includes a self-propelled car designed to carry passengers, baggage, mail, or express. This term includes a passenger coach, cab car, and an MU locomotive. In the context of articulated equipment, "passenger car" means that segment of the rail rolling equipment located between two trucks. This term does not include a private car.

*Passenger coach* means rail rolling equipment intended to provide transportation for members of the general public that is without propelling motors and without a control stand.

*Passenger compartment* means an area of a passenger car that consists of a seating area and any vestibule that is connected to the seating area by an open passageway.

*Passenger equipment*—means

(1) All powered and unpowered passenger cars, locomotives used to haul a passenger car, and any other rail rolling equipment used in a train with one or more passenger cars. Passenger equipment includes—

(i) A passenger coach,

(ii) A cab car,

(iii) A MU locomotive,

(iv) A locomotive not intended to provide transportation for a member of the general public that is used to power a passenger train, and

(v) Any non-self-propelled vehicle used in a passenger train, including an express car, baggage car, mail car, freight car, or a private car.

(2) In the context of articulated equipment, “passenger equipment” means a segment of rail rolling equipment located between two trucks that is used in a train with one or more passenger cars. This term does not include a freight locomotive when used to haul a passenger train due to failure of a passenger locomotive.

*Permanent deformation* means the undergoing of a permanent change in shape of a structural member of a rail vehicle.

*Public highway-rail grade crossing* means a location where a public highway, road or street, including associated sidewalks or pathways, crosses one or more active railroad tracks at grade.

*Railroad* means any form of nonhighway ground transportation that runs on rails or electromagnetic guideways and any entity providing such transportation, including—

(i) Commuter or other short-haul railroad passenger service in a metropolitan or suburban area and commuter railroad service that was operated by the Consolidated Rail Corporation on January 1, 1979; and

(ii) High speed ground transportation systems that connect metropolitan areas, without regard to whether those systems use new technologies not associated with traditional railroads; but does not include rapid transit operations in an urban area that are not connected to the general railroad system of transportation.

*Rollover strength* means the strength provided to protect the structural integrity of a rail vehicle in the event the vehicle leaves the track and impacts the ground on its side or roof.

*Roof rail* means the longitudinal structural member at the intersection of the side wall and the roof sheathing.

*Seating area* means an area of a passenger car that normally contains passenger seating.

*Semi-permanently coupled* means coupled by means of a drawbar or other coupling mechanism that requires tools to perform the uncoupling operation. Coupling and uncoupling of each semi-permanently coupled unit in a train can be performed safely only while at a maintenance or shop location where personnel can safely get under a unit or between units.

*Semi-monocoque* means a type of rail vehicle construction where the shell or skin acts as a single unit with the supporting frame to resist and transmit the loads acting on the rail vehicle.

*Shear strength* means the ability of a structural member to resist forces or components of forces acting perpendicular to compression or tension forces, or both, in the member.

*Side posts* means main vertical structural elements in the sides of a rail vehicle.

*Side sill* means that portion of the underframe or side at the bottom of the rail vehicle side wall.

*Skin* means the outer covering of a fuel tank and a rail vehicle. The skin may be covered with another coating of material such as fiberglass.

*Telescope* means override an adjoining rail vehicle or unit and penetrate into the interior of that adjoining vehicle or unit because of compressive forces.

*Tier I* means operating at speeds not exceeding 125 mph.

*Tier II* means operating at speeds exceeding 125 mph but not exceeding 150 mph.

*Trailer car* means a rail vehicle that neither propels a Tier II passenger train nor is the leading unit in a Tier II passenger train. A trailer car is normally without a control stand and is normally occupied by passengers.

*Train* means a locomotive unit or locomotive units coupled, with or without cars. For the purposes of the provisions of this part related to power brakes, the term “train” does not include such equipment when being used in switching service.

*Train, commuter* means a passenger train providing commuter service within an urban, suburban, or metropolitan area. The term includes a passenger train provided by an instrumentality of a State or a political subdivision of a State.

*Train, passenger* means a train that transports or is available to transport members of the general public. If a train is composed of a mixture of passenger and freight equipment, that train is a passenger train for purposes of this part.

*Trainset, passenger* means a passenger train.

*Transverse* means in a direction perpendicular to the normal direction of travel.



*Ultimate strength* means the load at which a structural member fractures or ceases to resist any load.

*Underframe* means the lower horizontal support structure of a rail vehicle.

*Unit* means passenger equipment of any type, except a freight locomotive when used to haul a passenger train due to failure of a passenger locomotive.

*Unoccupied volume* means the volume of a rail vehicle or passenger train which does not contain seating and is not normally occupied by passengers or crewmembers.

*Vehicle, rail* means passenger equipment of any type and includes a car, trailer car, locomotive, power car, tender, or similar vehicle. This term does not include a freight locomotive when used to haul a passenger train due to failure of a passenger locomotive.

*Vestibule* means an area of a passenger car that normally does not contain seating and is used in passing from the seating area to the side exit doors.

*Yield strength* means the ability of a structural member to resist a change in length caused by a heavy load. Exceeding the yield strength may cause permanent deformation of the member.

\*\*\*\*\*

**§ 238.111 Pre-revenue service acceptance testing plan.**

(a) *Passenger equipment that has previously been used in revenue service in the United States.* For passenger equipment that has previously been used in revenue service in the United States, each railroad shall test the equipment on its system prior to placing such equipment in revenue service for the first time on its railroad to ensure the compatibility of the equipment with the railroad's operating system (including the track, and signal system). A description of such testing shall be retained by the railroad and made available to FRA for inspection and copying upon request. For purposes of this paragraph, passenger equipment that has previously been used in revenue service in the United States means:

- (1) The actual equipment used in such service;
- (2) Equipment manufactured identically to that actual equipment; and
- (3) Equipment manufactured similarly to that actual equipment with no material differences in safety-critical components or systems.

(b) *Passenger equipment that has not been used in revenue service in the United States.* Before using passenger equipment for the first time on its system that has not been used in revenue service in the United States, each railroad shall:

- (1) Prepare a pre-revenue service acceptance testing plan for the equipment which contains the following elements:

- (i) An identification of any waivers of FRA or other Federal safety regulations required for the testing or for revenue service operation of the equipment;
  - (ii) A clear statement of the test objectives. One of the principal test objectives shall be to demonstrate that the equipment meets the safety requirements specified in this part when operated in the environment in which it is to be used;
  - (iii) A planned schedule for conducting the testing;
  - (iv) A description of the railroad property or facilities to be used to conduct the testing;
  - (v) A detailed description of how the testing is to be conducted, including a description of the criteria to be used to evaluate the equipment's performance;
  - (vi) A description of how the test results are to be recorded;
  - (vii) A description of any special instrumentation to be used during the tests;
  - (viii) A description of the information or data to be obtained;
  - (ix) A description of how the information or data obtained is to be analyzed or used;
  - (x) A description of any criteria to be used as safety limits during the testing;
  - (xi) A description of the criteria to be used to measure or determine the success or failure of the tests. If acceptance is to be based on extrapolation of less than full-level testing results, the analysis to be done to justify the validity of the extrapolation shall be described;
  - (xii) Quality control procedures to ensure that the inspection, testing, and maintenance procedures are followed;
  - (xiii) Criteria to be used for the revenue service operation of the equipment; and
  - (xiv) A description of any testing of the equipment that has previously been performed.
- (2) Submit a copy of the plan to FRA at least 30 days prior to testing the equipment and include with that submission notification of the times and places of the pre-revenue service tests to permit FRA observation of such tests. For Tier II passenger equipment, the railroad shall obtain FRA approval of the plan under the procedures specified in § 238.21.
- (3) Comply with the plan, including fully executing the tests required by the plan.
- (4) Document in writing the results of the tests. For Tier II passenger equipment, the railroad shall report the results of the tests to the FRA Associate Administrator for Safety at least 90 days prior to its intended operation of the equipment in revenue service.

(5) Correct any safety deficiencies identified in the design of the equipment or in the inspection, testing, and maintenance procedures, uncovered during the testing. If safety deficiencies cannot be corrected by design changes, the railroad shall impose operational limitations on the revenue service operation of the equipment that are designed to ensure that the equipment can operate safely. For Tier II passenger equipment, the railroad shall comply with any operational limitations imposed by the FRA Associate Administrator for Safety on the revenue service operation of the equipment for cause stated following FRA review of the results of the test program. This section does not restrict a railroad from petitioning FRA for a waiver of a safety regulation under the procedures specified in part 211 of this chapter.

(6) Make the plan and documentation kept pursuant to that plan available for inspection and copying by FRA upon request.

(7) For Tier II passenger equipment, obtain approval from the FRA Associate Administrator for Safety prior to placing the equipment in revenue service. The Associate Administrator grants such approval upon a showing of the railroad's compliance with the applicable requirements of this part.

(c) If a railroad plans a major upgrade or introduction of new technology on Tier II passenger equipment that has been used in revenue service in the United States and that affects a safety system on such equipment, the railroad shall follow the procedures specified in paragraph (b) of this section prior to placing the equipment in revenue service with such a major upgrade or introduction of new technology.

\*\*\*\*\*

**§ 238.203. Static end strength.**

(a)(1) Except as further specified in this paragraph or in paragraph (d), on or after November 8, 1999 all passenger equipment shall resist a minimum static end load of 800,000 pounds applied on the line of draft without permanent deformation of the body structure.

\*\*\*\*\*

**§ 238.205. Anti-climbing mechanism.**

(a) Except as provided in paragraph (b) of this section, all passenger equipment placed in service for the first time on or after September 8, 2000, and prior to March 9, 2010, shall have at both the forward and rear ends an anti-climbing mechanism capable of resisting an upward or downward vertical force of 100,000 pounds without failure. All passenger equipment placed in service for the first time on or after March 9, 2010, shall have at both the forward and rear ends an anti-climbing mechanism capable of resisting an upward or downward vertical force of 100,000 pounds without permanent deformation. When coupled together in any combination to join two vehicles, AAR Type H and Type F tight-lock couplers satisfy the requirements of this paragraph (a).

\*\*\*\*\*

**§ 238.207. Link between coupling mechanism and car body.**

All passenger equipment placed in service for the first time on or after September 8, 2000 shall have a coupler carrier at each end designed to resist a vertical downward thrust from the coupler

shank of 100,000 pounds for any normal horizontal position of the coupler, without permanent deformation. For passenger equipment that is connected by articulated joints that comply with the requirements of § 238.205(a), such passenger equipment also complies with the requirements of this section.

\*\*\*\*\*

**§ 238.209. Forward end structure of locomotives, including cab cars and MU locomotives.**

(a)(1) The skin covering the forward-facing end of each locomotive, including a cab car and an MU locomotive, shall be:

- (i) Equivalent to a 1/2-inch steel plate with a yield strength of 25,000 pounds-per-square-inch--material of a higher yield strength may be used to decrease the required thickness of the material provided at least an equivalent level of strength is maintained;
- (ii) Designed to inhibit the entry of fluids into the occupied cab area of the equipment; and
- (iii) Affixed to the collision posts or other main vertical structural members of the forward end structure so as to add to the strength of the end structure.

(2) As used in this paragraph (a), the term “skin” does not include forward-facing windows and doors.

(b) The forward end structure of a cab car or an MU locomotive may comply with the requirements of Appendix F to this part in lieu of the requirements of either § 238.211 (Collision posts) or § 238.213 (Corner posts), or both, provided that the end structure is designed to protect the occupied volume for its full height, from the underframe to the anti-telescoping plate (if used) or roof rails.

\*\*\*\*\*

**§ 238.211. Collision posts.**

(a) Except as further specified in this paragraph, paragraphs (b) through (d) of this section, and § 238.209(b)—

(1) All passenger equipment placed in service for the first time on or after September 8, 2000, shall have either:

- (i) Two full-height collision posts, located at approximately the one-third points laterally, at each end. Each collision post shall have an ultimate longitudinal shear strength of not less than 300,000 pounds at a point even with the top of the underframe member to which it is attached. If reinforcement is used to provide the shear value, the reinforcement shall have full value for a distance of 18 inches up from the underframe connection and then taper to a point approximately 30 inches above the underframe connection; or

(ii) An equivalent end structure that can withstand the sum of forces that each collision post in paragraph (a)(1)(i) of this section is required to withstand. For analysis purposes, the required forces may be assumed to be evenly distributed at the end structure at the underframe joint.

(2) The requirements of this paragraph (a) do not apply to unoccupied passenger equipment operating in a passenger train, or to the rear end of a locomotive if the end is unoccupied by design.

(b) Except for a locomotive that is constructed on or after January 1, 2009, and is subject to the requirements of subpart D of part 229 of this chapter, each locomotive, including a cab car and an MU locomotive, ordered on or after September 8, 2000, or placed in service for the first time on or after September 9, 2002, shall have at its forward end, in lieu of the structural protection described in paragraph (a) of this section, either:

(1) Two forward collision posts, located at approximately the one-third points laterally, each capable of withstanding:

(i) A 500,000-pound longitudinal force at the point even with the top of the underframe, without exceeding the ultimate strength of the joint; and

(ii) A 200,000-pound longitudinal force exerted 30 inches above the joint of the post to the underframe, without exceeding the ultimate strength; or

(2) An equivalent end structure that can withstand the sum of the forces that each collision post in paragraph (b)(1) of this section is required to withstand.

(c)(1) Each cab car and MU locomotive ordered on or after May 10, 2010, or placed in service for the first time on or after March 8, 2012, shall have at its forward end, in lieu of the structural protection described in paragraphs (a) and (b) of this section, two forward collision posts, located at approximately the one-third points laterally, meeting the requirements set forth in paragraphs (c)(2) and (c)(3) of this section:

(2) Each collision post acting together with its supporting car body structure shall be capable of withstanding the following loads individually applied at any angle within 15 degrees of the longitudinal axis:

(i) A 500,000-pound horizontal force applied at a point even with the top of the underframe, without exceeding the ultimate strength of either the post or its supporting car body structure;

(ii) A 200,000-pound horizontal force applied at a point 30 inches above the top of the underframe, without exceeding the ultimate strength of either the post or its supporting car body structure; and

(iii) A 60,000-pound horizontal force applied at any height along the post above the top of the underframe, without permanent deformation of either the post or its supporting car body structure.

(3) Prior to or during structural deformation, each collision post acting together with its supporting car body structure shall be capable of absorbing a minimum of 135,000 foot-pounds of energy (0.18 megajoule) with no more than 10 inches of longitudinal, permanent deformation into the occupied volume, in accordance with the following:

(i) The collision post shall be loaded longitudinally at a height of 30 inches above the top of the underframe;

(ii) The load shall be applied with a fixture, or its equivalent, having a width sufficient to distribute the load directly into the webs of the post, but of no more than 36 inches, and either:

(A) A flat plate with a height of 6 inches; or

(B) A curved surface with a diameter of no more than 48 inches; and

(iii) There shall be no complete separation of the post, its connection to the underframe, its connection to either the roof structure or anti-telescoping plate (if used), or of its supporting car body structure.

(d) The end structure requirements of this section apply only to the ends of a semi-permanently coupled consist of articulated units, provided that:

(1) The railroad submits to FRA under the procedures specified in § 238.21 a documented engineering analysis establishing that the articulated connection is capable of preventing disengagement and telescoping to the same extent as equipment satisfying the anti-climbing and collision post requirements contained in this subpart; and

(2) FRA finds the analysis persuasive.

\*\*\*\*\*

**§ 238.213. Corner posts.**

(a)(1) Except as further specified in paragraphs (b) and (c) of this section and § 238.209(b), each passenger car shall have at each end of the car, placed ahead of the occupied volume, two full height corner posts, each capable of resisting together with its supporting car body structure:

(i) A 150,000-pound horizontal force applied at a point even with the top of the underframe, without exceeding the ultimate strength of either the post or its supporting car body structure;

(ii) A 20,000-pound horizontal force applied at the point of attachment to the roof structure, without exceeding the ultimate strength of either the post or its supporting car body structure; and

(iii) A 30,000-pound horizontal force applied at a point 18 inches above the top of the underframe, without permanent deformation of either the post or its supporting car body structure.

(2) For purposes of this paragraph (a), the orientation of the applied horizontal forces shall range from longitudinal inward to lateral inward.

(b)(1) Except as provided in paragraph (c) of this section, each cab car and MU locomotive ordered on or after May 10, 2010, or placed in service for the first time on or after March 8, 2012, shall have at its forward end, in lieu of the structural protection described in paragraph (a) of this section, two corner posts ahead of the occupied volume, meeting all of the requirements set forth in paragraphs (b)(2) and (b)(3) of this section:

(2) Each corner post acting together with its supporting car body structure shall be capable of withstanding the following loads individually applied toward the inside of the vehicle at all angles in the range from longitudinal to lateral:

(i) A 300,000-pound horizontal force applied at a point even with the top of the underframe, without exceeding the ultimate strength of either the post or its supporting car body structure;

(ii) A 100,000-pound horizontal force applied at a point 18 inches above the top of the underframe, without permanent deformation of either the post or its supporting car body structure; and

(iii) A 45,000-pound horizontal force applied at any height along the post above the top of the underframe, without permanent deformation of either the post or its supporting car body structure.

(3) Prior to or during structural deformation, each corner post acting together with its supporting car body structure shall be capable of absorbing a minimum of 120,000 foot-pounds of energy (0.16 megajoule) with no more than 10 inches of longitudinal, permanent deformation into the occupied volume, in accordance with the following:

(i) The corner post shall be loaded longitudinally at a height of 30 inches above the top of the underframe;

(ii) The load shall be applied with a fixture, or its equivalent, having a width sufficient to distribute the load directly into the webs of the post, but of no more than 36 inches and either:

(A) A flat plate with a height of 6 inches; or

(B) A curved surface with a diameter of no more than 48 inches; and

(iii) There shall be no complete separation of the post, its connection to the underframe, its connection to either the roof structure or anti-telescoping plate (if used), or of its supporting car body structure.

(c)(1) Each cab car and MU locomotive ordered on or after May 10, 2010, or placed in service for the first time on or after March 8, 2012, utilizing low-level passenger boarding on the non-

operating side of the cab end shall meet the corner post requirements of paragraph (b) of this section for the corner post on the side of the cab containing the control stand. In lieu of the requirements of paragraph (b) of this section, and after FRA review and approval of a plan, including acceptance criteria, to evaluate compliance with this paragraph (c), each such cab car and MU locomotive may have two corner posts on the opposite (non-operating) side of the cab from the control stand meeting all of the requirements set forth in paragraphs (c)(2) through (c)(4) of this section:

(2) One corner post shall be located ahead of the stepwell and, acting together with its supporting car body structure, shall be capable of withstanding the following horizontal loads individually applied toward the inside of the vehicle:

(i) A 150,000-pound longitudinal force applied at a point even with the top of the underframe, without exceeding the ultimate strength of either the post or its supporting car body structure;

(ii) A 30,000-pound longitudinal force applied at a point 18 inches above the top of the underframe, without permanent deformation of either the post or its supporting car body structure;

(iii) A 30,000-pound longitudinal force applied at the point of attachment to the roof structure, without permanent deformation of either the post or its supporting car body structure;

(iv) A 20,000-pound longitudinal force applied at any height along the post above the top of the underframe, without permanent deformation of either the post or its supporting car body structure;

(v) A 300,000-pound lateral force applied at a point even with the top of the underframe, without exceeding the ultimate strength of either the post or its supporting car body structure;

(vi) A 100,000-pound lateral force applied at a point 18 inches above the top of underframe, without permanent deformation of either the post or its supporting car body structure; and

(vii) A 45,000-pound lateral force applied at any height along the post above the top of the underframe, without permanent deformation of either the post or its supporting car body structure.

(3) A second corner post shall be located behind the stepwell and, acting together with its supporting car body structure, shall be capable of withstanding the following horizontal loads individually applied toward the inside of the vehicle:

(i) A 300,000-pound longitudinal force applied at a point even with the top of the underframe, without exceeding the ultimate strength of either the post or its supporting car body structure;

(ii) A 100,000-pound longitudinal force applied at a point 18 inches above the top of the underframe, without permanent deformation of either the post or its supporting car bodystructure;



(iii) A 45,000-pound longitudinal force applied at any height along the post above the top of the underframe, without permanent deformation of either the post or its supporting car body structure;

(iv) A 100,000-pound lateral force applied at a point even with the top of the underframe, without exceeding the ultimate strength of either the post or its supporting car body structure;

(v) A 30,000-pound lateral force applied at a point 18 inches above the top of the underframe, without permanent deformation of either the post or its supporting car body structure; and

(vi) A 20,000-pound lateral force applied at any height along the post above the top of the underframe, without permanent deformation of body structure.

(4) Prior to or during structural deformation, the two posts in combination acting together with their supporting body structure shall be capable of absorbing a minimum of 120,000 foot-pounds of energy (0.16 megajoule) in accordance with the following:

(i) The corner posts shall be loaded longitudinally at a height of 30 inches above the top of the underframe;

(ii) The load shall be applied with a fixture, or its equivalent, having a width sufficient to distribute the load directly into the webs of the post, but of no more than 36 inches and either:

(A) A flat plate with a height of 6 inches; or

(B) A curved surface with a diameter of no more than 48 inches; and

(iii) The corner post located behind the stepwell shall have no more than 10 inches of longitudinal, permanent deformation. There shall be no complete separation of the corner post located behind the stepwell, its connection to the underframe, its connection to either the roof structure or anti-telescoping plate (if used), or of its supporting car body structure. The corner post ahead of the stepwell is permitted to fail. (A graphical description of the forward end of a cab car or an MU locomotive utilizing low-level passenger boarding on the non-operating side of the cab end is provided in Figure 1 to subpart C of this part.)

\*\*\*\*\*

**§ 238.215. Rollover strength.**

(a) Each passenger car shall be designed to rest on its side and be uniformly supported at the top (“roof rail”), the bottom cords (“side sill”) of the side frame, and, if bi-level, the intermediate floor rail. The allowable stress in the structural members of the occupied volumes for this condition shall be one-half yield or one-half the critical buckling stress, whichever is less. Local yielding to the outer skin of the passenger car is allowed provided that the resulting deformations in no way intrude upon the occupied volume of the car.

(b) Each passenger car shall also be designed to rest on its roof so that any damage in occupied areas is limited to roof sheathing and framing. Other than roof sheathing and framing, the allowable stress in the structural members of the occupied volumes for this condition shall be one-half yield or one-half the critical buckling stress, whichever is less. Deformation to the roof sheathing and framing is allowed to the extent necessary to permit the vehicle to be supported directly on the top chords of the side frames and end frames.

\*\*\*\*\*

**§ 238.217. Side structure.**

Each passenger car shall comply with the following:

(a) *Side posts and corner braces.* (1) For modified girder, semimonocoque, or truss construction, the sum of the section moduli in inches<sup>3</sup>—about a longitudinal axis, taken at the weakest horizontal section between the side sill and side plate—of all posts and braces on each side of the car located between the body corner posts shall be not less than 0.30 multiplied by the distance in feet between the centers of end panels.

(2) For modified girder or semimonocoque construction only, the sum of the section moduli in inches<sup>3</sup>—about a transverse axis, taken at the weakest horizontal section between the side sill and side plate—of all posts, braces and pier panels, to the extent available, on each side of the car located between body corner posts shall be not less than 0.20 multiplied by the distance in feet between the centers of end panels.

(3) The center of an end panel is the point midway between the center of the body corner post and the center of the adjacent side post.

(4) The minimum section moduli or thicknesses specified in paragraph (a) of this section may be adjusted in proportion to the ratio of the yield strength of the material used to that of mild open-hearth steel for a car whose structural members are made of a higher strength steel.

(b) *Sheathing.* (1) Outside sheathing of mild, open-hearth steel when used flat, without reinforcement (other than side posts) in a side frame of modified girder or semimonocoque construction shall not be less than 1/8 inch nominal thickness. Other metals may be used of a thickness in inverse proportion to their yield strengths.

(2) Outside metal sheathing of less than 1/8-inch thickness may be used only if it is reinforced so as to produce at least an equivalent sectional area at a right angle to reinforcements as that of the flat sheathing specified in paragraph (b)(1) of this section.

(3) When the sheathing used for truss construction serves no load-carrying function, the minimum thickness of that sheathing shall be not less than 40 percent of that specified in paragraph (b)(1) of this section.

\*\*\*\*\*

**§ 238.219. Truck-to-car-body attachment.**

Passenger equipment shall have a truck-to-car-body attachment with an ultimate strength sufficient to resist without failure the following individually applied loads: 2g vertically on the mass of the truck; and 250,000 pounds in any horizontal direction on the truck, along with the resulting vertical reaction to this load. For purposes of this section, the mass of the truck includes axles, wheels, bearings, the truck-mounted brake system, suspension system components, and any other component attached to the truck by design.

\*\*\*\*\*

**§ 238.233. Interior fittings and surfaces.**

(a) Each seat in a passenger car shall—

(1) Be securely fastened to the car body so as to withstand an individually applied acceleration of 4g acting in the lateral direction and 4g acting in the upward vertical direction on the deadweight of the seat or seats, if held in tandem; and

(2) Have an attachment to the car body of an ultimate strength capable of resisting simultaneously:

(i) The longitudinal inertial force of 8g acting on the mass of the seat; and

(ii) The load associated with the impact into the seatback of an unrestrained 95th-percentile adult male initially seated behind the seat, when the floor to which the seat is attached decelerates with a triangular crash pulse having a peak of 8g and a duration of 250 milliseconds.

(b) Overhead storage racks in a passenger car shall provide longitudinal and lateral restraint for stowed articles. Overhead storage racks shall be attached to the car body with sufficient strength to resist loads due to the following individually applied accelerations acting on the mass of the luggage stowed as determined by the railroad:

(1) Longitudinal: 8g;

(2) Vertical: 4g; and

(3) Lateral: 4g.

(c) Other interior fittings within a passenger car shall be attached to the car body with sufficient strength to withstand the following individually applied accelerations acting on the mass of the fitting:

(1) Longitudinal: 8g;

(2) Vertical: 4g; and

(3) Lateral: 4g.

(d) To the extent possible, all interior fittings in a passenger car, except seats, shall be recessed or flush-mounted.

(e) Sharp edges and corners in a locomotive cab and a passenger car shall be either avoided or padded to mitigate the consequences of an impact with such surfaces.

(f) Each seat provided for a crewmember regularly assigned to occupy the cab of a locomotive and each floor-mounted seat in the cab shall be secured to the car body with an attachment having an ultimate strength capable of withstanding the loads due to the following individually applied accelerations acting on the combined mass of the seat and a 95th-percentile adult male occupying it:

- (1) Longitudinal: 8g;
- (2) Lateral: 4g; and
- (3) Vertical: 4g.

(g) If, for purposes of showing compliance with the requirements of this section, the strength of a seat attachment is to be demonstrated through sled testing, the seat structure and seat attachment to the sled that is used in such testing must be representative of the actual seat structure in, and seat attachment to, the rail vehicle subject to the requirements of this section. If the attachment strength of any other interior fitting is to be demonstrated through sled testing, for purposes of showing compliance with the requirements of this section, such testing shall be conducted in a similar manner.

\*\*\*\*\*

**Included by reference:**

APTA SS-C&S-006-98, Rev. 1,  
Standard for Attachment Strength of Interior Fittings for Passenger Railroad Equipment

APTA SS-C&S-034-99, Rev. 2 .

Standard for the Design and Construction of Passenger Railroad Rolling Stock

\*\*\*\*\*

**Appendix F to Part 238—Alternative Dynamic Performance Requirements for Front End Structures of Cab Cars and MU Locomotives**

As specified in § 238.209(b), the forward end of a cab car or an MU locomotive may comply with the requirements of this appendix in lieu of the requirements of either § 238.211 (Collision posts) or § 238.213 (Corner posts), or both. The requirements of this appendix are intended to be equivalent to the requirements of those sections and allow for the application of dynamic performance criteria to cab cars and MU locomotives as an alternative to the requirements of those sections. The alternative dynamic performance requirements are applicable to all cab cars and MU locomotives, and may in particular be helpful for evaluating the compliance of cab cars and MU locomotives with shaped noses or crash energy management designs, or both. In any case, the end structure must be designed to protect the occupied volume for its full height, from the underframe to the anti-telescoping plate (if used) or roof rails. The requirements of this appendix are provided only as alternatives to the requirements of §§ 238.211 and 238.213, not in addition to the requirements of those sections. Cab cars and MU locomotives are not required to comply with both the requirements of those sections and the requirements of this appendix, together.

**Alternative Requirements for Collision Posts**

(a)(1) In lieu of meeting the requirements of § 238.211, the front end frame acting together with its supporting car body structure shall be capable of absorbing a minimum of 135,000 foot-

pounds of energy (0.18 megajoule) prior to or during structural deformation by withstanding a frontal impact with a rigid object in accordance with all of the requirements set forth in paragraphs (a)(2) through (a)(4) of this appendix:

(2)(i) The striking surface of the object shall be centered at a height of 30 inches above the top of the underframe;

(ii) The striking surface of the object shall have a width of no more than 36 inches and a diameter of no more than 48 inches;

(iii) The center of the striking surface shall be offset by 19 inches laterally from the center of the cab car or MU locomotive, and on the weaker side of the end frame if the end frame's strength is not symmetrical; and

(iv) Only the striking surface of the object interacts with the end frame structure.

(3) As a result of the impact, there shall be no more than 10 inches of longitudinal, permanent deformation into the occupied volume. There shall also be no complete separation of the post, its connection to the underframe, its connection to either the roof structure or the anti-telescoping plate (if used), or of its supporting car body structure. (A graphical description of the frontal impact is provided in Figure 1 to this appendix.)

(4) The nominal weights of the object and the cab car or MU locomotive, as ballasted, and the speed of the object may be adjusted to impart the minimum of 135,000 footpounds of energy (0.18 megajoule) to be absorbed ( $E_a$ ), in accordance with the following formula:  $E_a = E_0 - E_f$

Where:

$E_0$  = Energy of initially moving object at impact =  $\frac{1}{2} m_1 * V_{02}$ .

$E_f$  = Energy after impact =  $\frac{1}{2} (m_1 + m_2) * V_{f2}$ .

$V_0$  = Speed of initially moving object at impact.

$V_f$  = Speed of both objects after collision =  $m_1 * V_0 / (m_1 + m_2)$ .

$m_1$  = Mass of initially moving object.

$m_2$  = Mass of initially standing object.

(Figure 1 shows as an example a cab car or an MU locomotive having a weight of 100,000 pounds and the impact object having a weight of 14,000 pounds, so that a minimum speed of 18.2 mph would satisfy the collision-energy requirement.)

#### **Alternative Requirements for Corner Posts**

(b)(1) In lieu of meeting the requirements of § 238.213, the front end frame acting together with its supporting car body structure shall be capable of absorbing a minimum of 120,000 footpounds of energy (0.16 megajoule) prior to or during structural deformation by withstanding a frontal impact with a rigid object in accordance with all of the requirements set forth in paragraphs (b)(2) through (b)(4) of this appendix:

(2)(i) The striking surface of the object shall be centered at a height of 30 inches above the top of the underframe;

(ii) The striking surface of the object shall have a width of no more than 36 inches and a diameter of no more than 48 inches;

(iii) The center of the striking surface shall be aligned with the outboard edge of the cab car or MU locomotive, and on the weaker side of the end frame if the end frame's strength is not symmetrical; and

(iv) Only the striking surface of the object interacts with the end frame structure.

(3)(i) Except as provided in paragraph (b)(3)(ii) of this appendix, as a result of the impact, there shall be no more than 10 inches of longitudinal, permanent deformation into the occupied volume. There shall also be no complete separation of the post, its connection to the underframe, its connection to either the roof structure or the anti-telescoping plate (if used), or of its supporting car body structure. (A graphical description of the frontal impact is provided in Figure 2 to this appendix.); and

(ii) After FRA review and approval of a plan, including acceptance criteria, to evaluate compliance with this paragraph (b), cab cars and MU locomotives utilizing low-level passenger boarding on the non-operating side of the cab may have two, full-height corner posts on that side, one post located ahead of the stepwell and one located behind it, so that the corner post located ahead of the stepwell is permitted to fail provided that—

(A) The corner post located behind the stepwell shall have no more than 10 inches of longitudinal, permanent deformation; and

(B) There shall be no complete separation of that post, its connection to the underframe, its connection to either the roof structure or the anti-telescoping plate (if used), or of its supporting car body structure.

(4) The nominal weights of the object and the cab car or MU locomotive, as ballasted, and the speed of the object may be adjusted to impart the minimum of 120,000 foot-pounds of energy (0.16 megajoule) to be absorbed ( $E_a$ ), in accordance with the following formula:  $E_a = E_0 - E_f$

Where:

$E_0$  = Energy of initially moving object at impact =  $\frac{1}{2} m_1 * V_{0i}^2$ .

$E_f$  = Energy after impact =  $\frac{1}{2} (m_1 + m_2) * V_{f2}^2$ .

$V_0$  = Speed of initially moving object at impact.

$V_f$  = Speed of both objects after collision =  $m_1 * V_0 / (m_1 + m_2)$ .

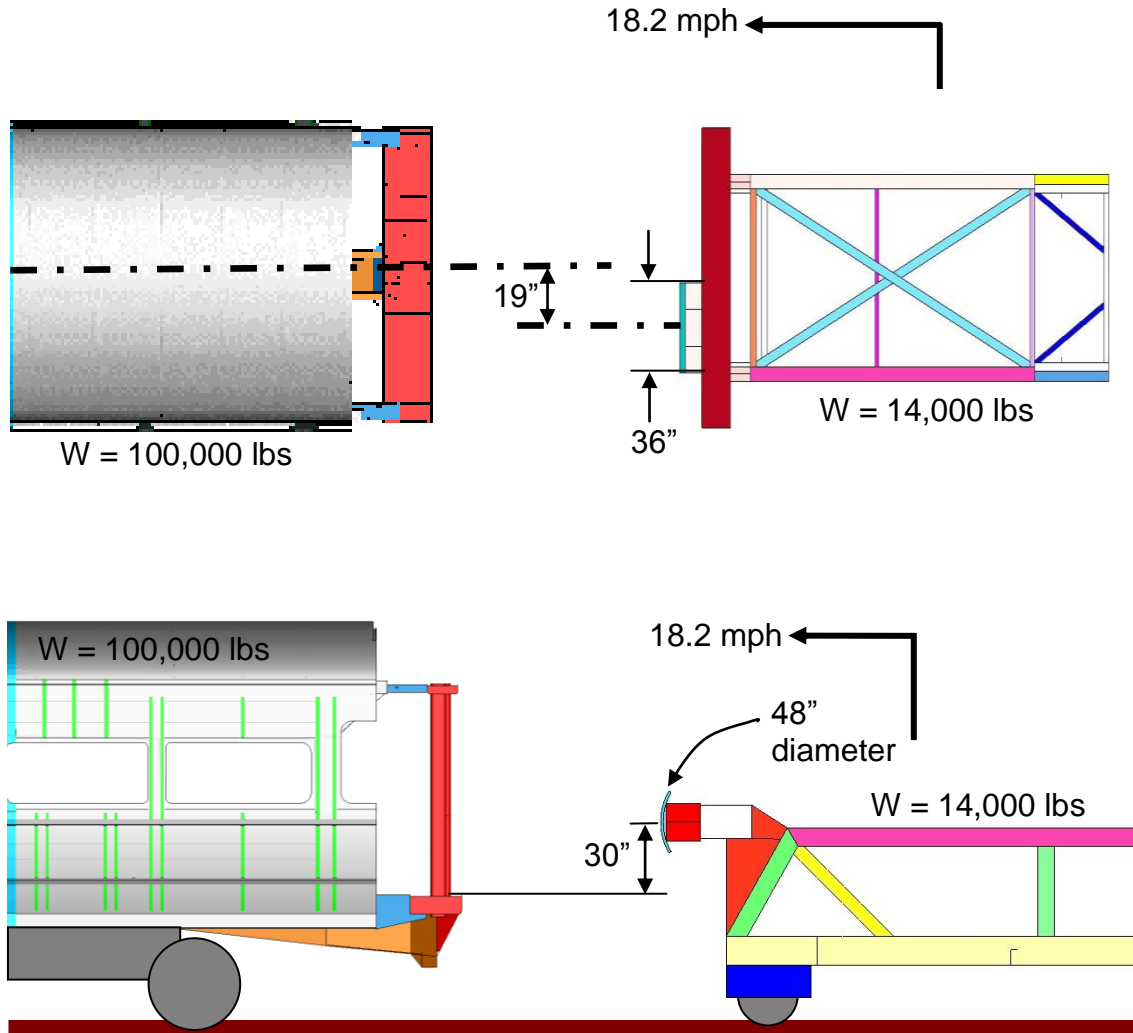
$m_1$  = Mass of initially moving object.

$m_2$  = Mass of initially standing object.

(Figure 2 shows as an example a cab car or an MU locomotive having a weight of 100,000 pounds and the impact object having a weight of 14,000 pounds, so that a minimum speed of 17.1 mph would satisfy the collision-energy requirement.)

FIGURE 1 TO APPENDIX F OF PART 238-

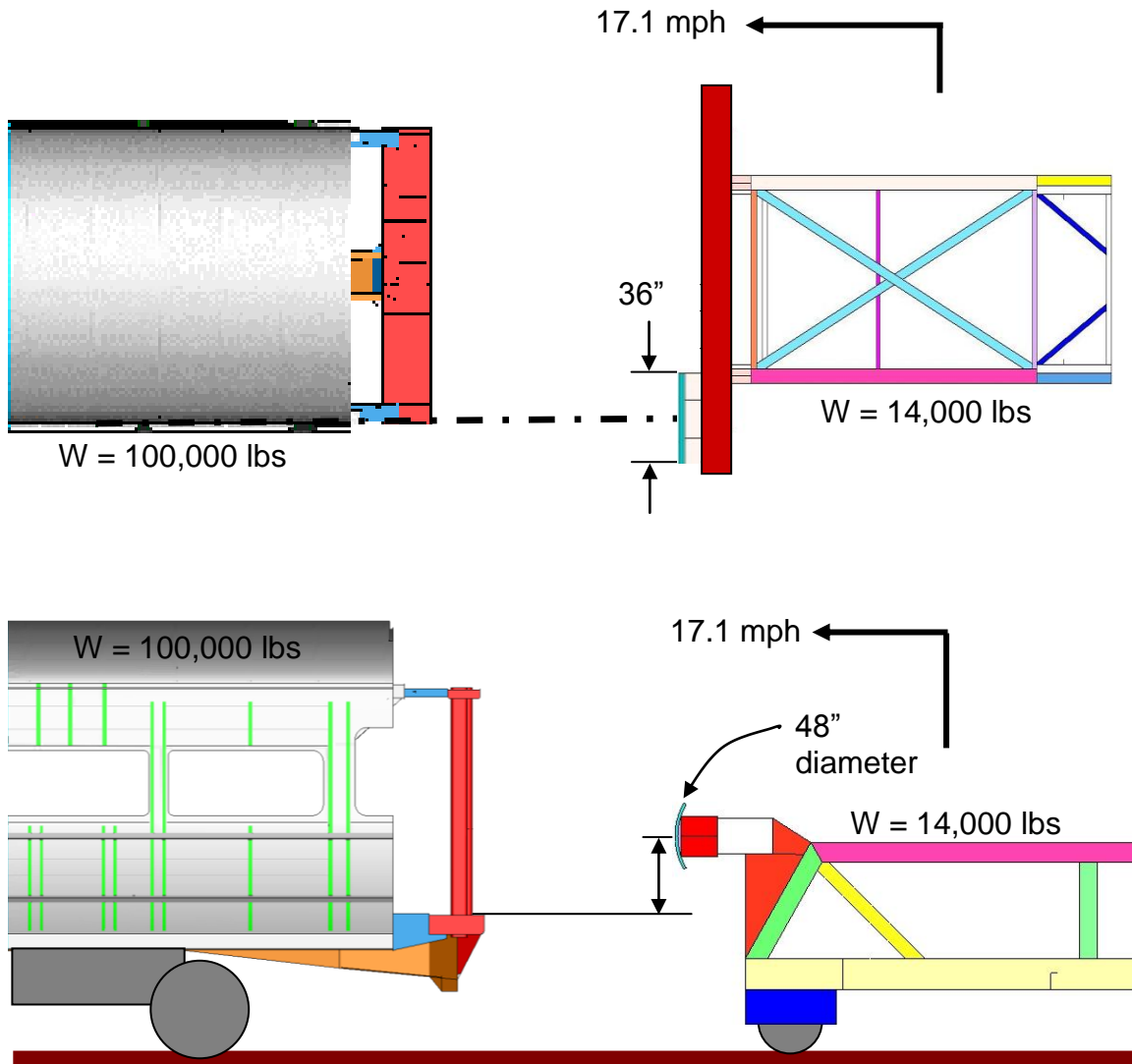
EXAMPLE OF FORWARD END OF CAB CAR OR MU LOCOMOTIVE  
AT IMPACT WITH PROXY OBJECT TO DEMONSTRATE COMPLIANCE WITH  
ALTERNATIVE, COLLISION POST PERFORMANCE STANDARD—  
TOP AND SIDE VIEWS



" = inches.  
lbs = pounds.

**FIGURE 2 TO APPENDIX F OF PART 238-**

**EXAMPLE OF FORWARD END OF CAB CAR OR MU LOCOMOTIVE  
AT IMPACT WITH PROXY OBJECT TO DEMONSTRATE COMPLIANCE WITH  
ALTERNATIVE, CORNER POST PERFORMANCE STANDARD—  
TOP AND SIDE VIEWS**



" = inches.  
lbs = pounds.

\*\*\*\*\*



## Appendix C. Locomotive and Passenger Car Input Data

---

This appendix contains force-crush characteristics for conventional passenger equipment for use in modeling the Collision Scenario. This appendix also contains input data for a rigid, half-symmetric model of an F40-type locomotive. The input data were generated for use with the Abaqus/Explicit finite element code.

### Force-crush Characteristics for Conventional Equipment

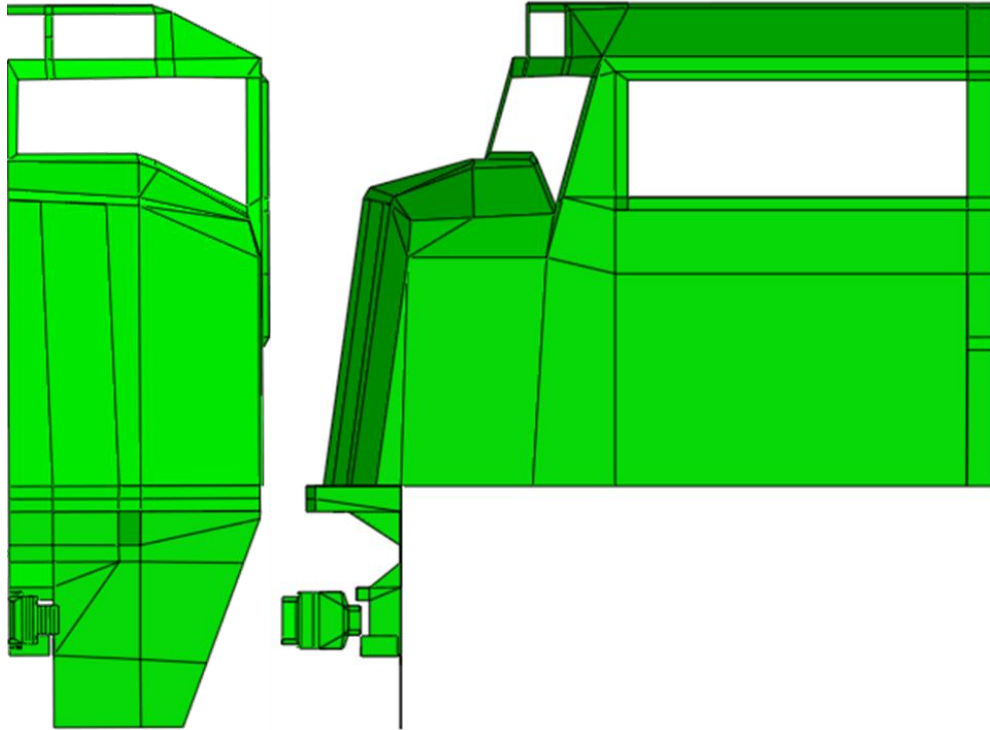
Table A1 contains force-crush characteristics for the conventional passenger equipment. As defined in the **Collision Scenario** in **Section 3.1**, the moving train is made up of conventional passenger equipment. These data can be used to define spring characteristics in a lumped-parameter model of the moving train in the **Collision Scenario**.

**Table A1. Idealized Force-Crush Data for Conventional Equipment**

Vehicle	Crush (in)	Force (lbf)
Conventional Passenger Car	0	0
	3	80,000
	6	2,500,000
Conventional Locomotive	0	0
	2.5	100,000
	5	2,500,000

### Input Data for Rigid Locomotive

The locomotive input file contains geometry for approximately the first 12 ft of the locomotive. Because this input file is for a half-symmetric model, a mass corresponding to 130,000 pounds of weight is attached to the model. Two views of the locomotive are shown in Figure A11.



**Figure A11. Side and Front Views of Rigid Locomotive Model**

\*\*\*\*\* BEGIN INPUT FILE\*\*\*\*\*

\*Heading  
\*\* USDOT/VOLPE CENTER FINITE ELEMENT MODEL  
\*\* FULLY RIGID LOCOMOTIVE DESIGNED FOR 1-D MODELING  
\*\* LOCOMOTIVE BASED ON F-40 TYPE  
\*\* HALF-SYMMETRY INPUT FILE  
\*\* WHOLE LOCOMOTIVE WEIGHT: 260,000 POUNDS  
\*\* UNITS: INCHES/POUNDS/SECONDS  
\*\* JULY, 2010  
\*\* Generated by: Abaqus/CAE 6.10-1  
\*\*  
\*\* PARTS  
\*\*

\*Part, name=PART-1  
\*Node

1,	167.942993,	59.8800011,	98.0625
2,	161.143005,	59.8800011,	98.0625
3,	167.942993,	59.8800011,	66.0625
4,	78.322998,	59.8800011,	66.0625
5,	167.942993,	0.,	179.5625
6,	81.322998,	0.,	179.5625
7,	54.3730011,	0.,	166.862503
8,	167.942993,	33.6899986,	179.5625
9,	81.322998,	59.8800011,	133.942505
10,	78.322998,	59.8800011,	133.942505
11,	78.322998,	59.8800011,	163.502502
12,	81.322998,	59.8800011,	161.502502
13,	78.322998,	59.8800011,	130.942505
14,	78.322998,	59.8800011,	116.002502
15,	161.143005,	59.8800011,	133.942505
16,	161.143005,	59.8800011,	161.502502
17,	161.143005,	59.8800011,	101.0625
18,	161.143005,	59.8800011,	130.942505
19,	161.143005,	59.8800011,	163.502502
20,	167.942993,	59.8800011,	163.502502
21,	167.942993,	59.8800011,	167.0625
22,	167.942993,	37.8079987,	178.462494
23,	81.322998,	33.6899986,	179.5625
24,	81.322998,	37.8079987,	178.472504
25,	57.5040016,	9.,	166.862503
26,	58.125,	10.7849998,	166.862503
27,	66.6159973,	35.0439987,	166.862503
28,	58.132,	10.783,	177.5625
29,	57.4830017,	8.99190044,	177.5625
30,	58.132,	10.783,	179.5625
31,	57.4830017,	8.99190044,	179.5625
32,	75.310997,	59.862999,	167.052505
33,	62.2120018,	59.8800011,	119.8125
34,	63.9179993,	56.5620003,	130.160507
35,	64.3919983,	56.5470009,	131.889496
36,	72.861969,	56.5663757,	162.376297
37,	66.6299973,	35.0439987,	177.5625
38,	48.9730415,	2.24654722,	144.558914
39,	53.9304123,	2.53624678,	162.100143
40,	81.322998,	61.6300011,	133.942505
41,	161.143005,	61.6300011,	133.942505
42,	81.322998,	61.6300011,	130.942505
43,	161.143005,	61.6300011,	130.942505
44,	167.942993,	61.6300011,	101.0625
45,	167.942993,	61.6300011,	161.502502
46,	161.143005,	61.6300011,	101.0625
47,	161.143005,	61.6300011,	161.502502
48,	20.6900311,	0.,	136.253281
49,	18.1748695,	59.2774734,	60.0625
50,	22.07197,	59.2542038,	66.0625
51,	27.934,	41.,	9.0625
52,	18.3192978,	0.,	36.7498283
53,	15.5744066,	0.,	36.7498283
54,	1.76894331,	5.32121038,	28.9578266
55,	3.57440639,	6.60263443,	28.9578266

56,	2.67061162,	5.68379116,	28.9578266
57,	0.401960254,	3.98941922,	28.9578266
58,	0.977025032,	4.76697016,	28.9578266
59,	0.099995479,	3.06867123,	28.9578266
60,	0.099995479,	1.14263237,	30.0413265
61,	0.099995479,	0.,	28.9578266
62,	3.51490474,	0.654233992,	28.9578266
63,	3.98739839,	0.,	28.9578266
64,	0.099995479,	0.,	30.0413265
65,	3.31792188,	0.,	30.0413265
66,	3.40018868,	1.60872662,	28.9578266
67,	2.67061162,	5.68379116,	40.0418282
68,	0.099995479,	1.14263237,	38.9583282
69,	0.099995479,	0.,	40.0418282
70,	0.977025032,	4.76697016,	40.0418282
71,	1.76894331,	5.32121038,	40.0418282
72,	0.099995479,	0.,	38.9583282
73,	3.98739839,	0.,	40.0418282
74,	3.31792188,	0.,	38.9583282
75,	0.099995479,	3.06867123,	40.0418282
76,	0.401960254,	3.98941922,	40.0418282
77,	3.51490474,	0.654233992,	40.0418282
78,	5.75145721,	5.7997303,	40.0418282
79,	15.5720844,	3.87475181,	31.1248264
80,	18.5401859,	3.81961679,	31.1248264
81,	15.5744066,	0.,	31.1248264
82,	3.40018868,	1.60872662,	40.0418282
83,	3.57440639,	6.60263443,	40.0418282
84,	30.2979393,	56.9446068,	128.484482
85,	58.9190598,	59.8919106,	66.0608368
86,	161.143005,	61.6300011,	116.002502
87,	58.7904701,	30.4786301,	144.5345
88,	59.8902054,	34.9131279,	142.917557
89,	161.143005,	59.8800011,	116.002502
90,	57.4934998,	8.99594975,	172.212494
91,	58.1285019,	10.7840004,	172.212494
92,	15.5744066,	0.,	32.2498283
93,	18.3192978,	0.,	31.1248264
94,	18.3192978,	0.,	32.2498283
95,	15.5744066,	1.95114112,	31.1248264
96,	58.2618256,	31.,	142.816605
97,	59.3854752,	34.7812653,	141.263779
98,	67.881691,	38.7345238,	178.0345
99,	66.3495865,	34.3354263,	179.5625
100,	161.143005,	59.8800011,	167.0625
101,	66.1316681,	59.8799019,	133.987289
102,	74.003212,	59.8690262,	162.327911
103,	68.1072845,	39.3478088,	166.862503
104,	161.018005,	59.8800011,	66.0625
105,	14.4651852,	0.,	31.1248264
106,	8.65684605,	0.948336065,	41.1248283
107,	8.69752693,	0.,	41.1248283
108,	8.71603775,	2.63976431,	40.0414925
109,	9.53989887,	2.18784833,	40.0414925
110,	14.1617727,	1.99973011,	31.1248264
111,	5.75145721,	5.7997303,	37.8748283
112,	3.39199758,	9.62334061,	37.8748283
113,	14.4651852,	0.,	37.8748283
114,	10.4428129,	1.99973011,	37.8748283
115,	8.71603775,	2.63976431,	31.1248264
116,	9.53989887,	2.18784833,	37.8748283
117,	3.34182882,	8.61192608,	37.8748283
118,	15.5744066,	0.,	37.8748283
119,	15.5720844,	3.87475181,	37.8748283
120,	13.7156467,	4.44362879,	31.1248264
121,	3.55879021,	10.6221542,	31.1248264
122,	9.53989887,	2.18784833,	31.1248264
123,	8.71603775,	2.63976431,	37.8748283
124,	11.6615076,	6.49122286,	37.8748283
125,	9.37123108,	10.8283968,	37.8748283
126,	14.1617727,	1.99973011,	37.8748283

127,	3.4053607,	7.60121346,	37.8748283
128,	15.5744066,	2.12472296,	37.8748283
129,	18.3192978,	0.,	37.8748283
130,	13.9651852,	0.,	27.8748264
131,	4.45807409,	2.11810708,	27.8748264
132,	14.4744062,	0.,	27.8748264
133,	8.71603775,	2.63976431,	27.8748264
134,	13.7156467,	4.44362879,	37.8748283
135,	3.55879021,	10.6221542,	37.8748283
136,	18.5401859,	3.81961679,	37.8748283
137,	3.57440639,	6.60263443,	37.8748283
138,	14.6130104,	4.054636,	37.8748283
139,	10.4428129,	1.99973011,	31.1248264
140,	8.73545933,	11.5156822,	37.8748283
141,	3.83903623,	11.5952816,	37.8748283
142,	3.70096731,	2.42872977,	40.0414925
143,	14.1742048,	1.95114088,	41.1248283
144,	10.4428129,	1.99973011,	41.1248283
145,	9.53989887,	2.18784833,	41.1248283
146,	13.9651852,	0.,	41.1248283
147,	14.4744062,	0.,	41.1248283
148,	8.71603775,	2.63976431,	41.1248283
149,	8.18554401,	1.77063227,	41.1248283
150,	10.4428129,	1.99973011,	40.0414925
151,	6.90897226,	3.09021854,	41.1248283
152,	6.90897226,	3.09021854,	40.0414925
153,	7.3380537,	2.19558096,	41.1248283
154,	3.70096731,	2.42872977,	41.1248283
155,	4.45807409,	2.11810708,	41.1248283
156,	11.6615076,	6.49122286,	31.1248264
157,	9.37123108,	10.8283968,	31.1248264
158,	3.57440639,	6.60263443,	31.1248264
159,	14.6130104,	4.054636,	31.1248264
160,	8.73545933,	11.5156822,	31.1248264
161,	3.83903623,	11.5952816,	31.1248264
162,	3.34182882,	8.61192608,	31.1248264
163,	3.39199758,	9.62334061,	31.1248264
164,	3.4053607,	7.60121346,	31.1248264
165,	3.70096731,	2.42872977,	27.8748264
166,	8.65684605,	0.948336065,	27.8748264
167,	8.18554401,	1.77063227,	27.8748264
168,	7.83922768,	2.97724795,	31.1248264
169,	3.70096731,	2.42872977,	31.1248264
170,	8.69752693,	0.,	27.8748264
171,	7.83922768,	2.97724795,	27.8748264
172,	10.4428129,	1.99973011,	27.8748264
173,	3.70096731,	2.42872977,	28.9581604
174,	7.3380537,	2.19558096,	27.8748264
175,	14.1742048,	1.95114088,	27.8748264
176,	9.53989887,	2.18784833,	27.8748264
177,	47.7130013,	0.,	142.862503
178,	57.5089989,	0.,	177.5625
179,	57.5089989,	0.,	179.5625
180,	45.2702484,	31.,	142.381302
181,	44.7895966,	35.7113838,	140.807663
182,	44.3954277,	0.,	142.862503
183,	45.0859528,	56.9468269,	129.232864
184,	27.934,	26.02841,	48.1875
185,	26.3169994,	31.,	134.151077
186,	25.4385452,	31.,	132.291351
187,	29.5859261,	59.3337784,	119.820122
188,	27.944397,	59.3558388,	66.062233
189,	11.9149094,	10.3664589,	66.0625
190,	9.76114368,	0.,	66.0625
191,	19.1986504,	0.,	133.730804
192,	11.0030947,	25.8867302,	60.0625
193,	27.934,	0.,	48.1875
194,	27.934,	26.125,	60.0625
195,	11.067338,	26.125,	66.0625
196,	5.72649717,	0.,	60.0625
197,	27.934,	31.,	48.1875

198,	5.70541191,	0.,	63.0624962
199,	12.038866,	31.1362305,	60.0625
200,	18.114048,	59.2658386,	63.0621109
201,	27.9339981,	59.461689,	60.0613098
202,	27.934,	0.,	60.0560417
203,	7.81957102,	10.375,	63.0632477
204,	7.81957102,	10.3664589,	66.0625
205,	27.934,	10.375,	52.159462
206,	27.934,	0.,	52.1595879
207,	27.934,	10.4399996,	9.0625
208,	27.934,	31.0390625,	9.0625
209,	27.934,	46.629631,	24.1736107
210,	27.934,	55.4259262,	47.7847214
211,	27.934,	59.2962952,	58.1736107
212,	27.934,	10.4399996,	26.1248264
213,	27.934,	30.9188347,	25.1098576
214,	7.91185236,	10.375,	60.0625
215,	27.934,	10.375,	60.0625
216,	15.1792574,	26.0783482,	66.0625
217,	5.68432665,	0.,	66.0625
218,	18.0532093,	59.2542038,	66.0625
219,	27.2928429,	10.375,	60.0625
220,	27.934,	0.,	66.0625
221,	27.934,	10.375,	66.0625
222,	13.7154636,	10.3812084,	65.0625
223,	27.2928543,	10.375,	62.0625
224,	25.2556648,	10.375,	65.0625
225,	27.934,	31.125,	66.0625
226,	27.934,	31.125,	60.0625
227,	12.1000671,	31.1362305,	66.0625
228,	16.2295151,	31.1334229,	66.0625
229,	27.934,	25.875,	52.0625
230,	11.0631142,	25.8867302,	63.0293884
231,	27.934,	31.0490627,	52.0634613
232,	12.1452255,	31.1362305,	63.0293884
233,	20.5744057,	0.,	42.1875
234,	17.5744057,	0.,	42.1875
235,	17.5744057,	0.,	39.1875
236,	20.5744057,	10.4399996,	30.3899994
237,	20.5744057,	10.4399996,	39.1875
238,	20.5744057,	10.4399996,	42.1875
239,	17.5744057,	10.4399996,	39.1875
240,	17.5744057,	10.4399996,	42.1875
241,	27.934,	10.4399996,	42.2693863
242,	27.934,	10.4399996,	48.1875
243,	27.184,	9.43999958,	26.1248264
244,	27.184,	0.,	26.1248264
245,	27.184,	9.43999958,	30.8648262
246,	27.184,	0.,	30.8648262
247,	18.5744057,	10.4399996,	28.1248264
248,	18.5744057,	10.4399996,	26.1248264
249,	18.5744057,	9.43999958,	26.1248264
250,	18.5744057,	0.,	26.1248264
251,	18.5744057,	9.43999958,	30.8648262
252,	18.5744057,	0.,	30.8648262
8888888,	150.0,	0.,	34.5
253,	22.2162247,	59.3531151,	60.0625
254,	167.942993,	61.6300011,	116.002502
255,	167.942993,	61.6300011,	130.942505
256,	167.942993,	61.6300011,	133.942505
257,	161.143005,	37.8079987,	178.462494
258,	161.143005,	33.6899986,	179.5625
259,	161.143005,	0.,	179.5625
260,	56.3731041,	9.4654789,	162.199432
261,	57.0013237,	11.2475662,	162.22496
262,	67.0327148,	39.7239189,	162.592499
263,	65.5448227,	35.4830818,	162.57222
264,	23.8785725,	23.25,	132.651215
265,	20.7586231,	7.75,	133.370941

\*Element, type=R3D4

1, 87, 96, 97, 88

2, 91, 26, 25, 90  
3, 28, 91, 90, 29  
4, 30, 28, 29, 31  
6, 13, 42, 40, 10  
7, 47, 45, 20, 19  
8, 44, 46, 2, 1  
11, 201, 188, 225, 226  
12, 202, 215, 221, 220  
13, 233, 238, 242, 193  
14, 197, 213, 209, 210  
15, 212, 207, 208, 213  
16, 213, 208, 51, 209  
17, 234, 240, 238, 233  
18, 239, 240, 234, 235  
19, 239, 237, 238, 240  
20, 226, 225, 227, 232  
21, 197, 231, 229, 184  
22, 231, 226, 194, 229  
23, 215, 194, 229, 205  
24, 202, 215, 205, 206  
25, 206, 205, 242, 193  
26, 205, 229, 184, 242  
27, 203, 204, 217, 198  
28, 203, 214, 196, 198  
29, 204, 203, 230, 195  
30, 195, 230, 232, 227  
31, 230, 203, 214, 192  
32, 232, 230, 192, 199  
33, 232, 227, 218, 200  
34, 199, 232, 200, 49  
35, 218, 227, 228, 50  
36, 228, 227, 195, 216  
37, 195, 204, 189, 216  
38, 204, 217, 190, 189  
39, 220, 190, 189, 221  
40, 228, 225, 221, 189  
41, 6, 31, 99, 23  
43, 31, 29, 178, 179  
44, 23, 99, 98, 24  
47, 98, 103, 27, 37  
48, 30, 28, 37, 99  
50, 16, 47, 41, 15  
51, 21, 20, 19, 100  
52, 100, 19, 11, 32  
53, 34, 35, 88, 97  
54, 35, 101, 102, 36  
55, 11, 12, 16, 19  
57, 10, 9, 12, 11  
58, 101, 10, 11, 102  
59, 41, 43, 42, 40  
60, 15, 41, 40, 9  
61, 33, 14, 13, 101  
64, 13, 14, 89, 18  
65, 89, 86, 43, 18  
66, 89, 17, 46, 86  
67, 89, 104, 4, 14  
68, 104, 3, 1, 2  
69, 4, 14, 33, 85  
71, 185, 186, 191, 48  
73, 187, 186, 228, 50  
74, 225, 228, 50, 188  
75, 34, 183, 181, 97  
76, 97, 181, 180, 96  
77, 84, 183, 181, 185  
79, 96, 180, 182, 177  
80, 48, 185, 180, 182  
81, 251, 245, 243, 249  
82, 249, 243, 244, 250  
83, 252, 250, 249, 251  
84, 246, 245, 251, 252  
85, 46, 44, 254, 86

86, 86, 254, 255, 43  
87, 43, 255, 256, 41  
88, 41, 256, 45, 47  
89, 100, 21, 22, 257  
90, 257, 22, 8, 258  
91, 258, 8, 5, 259  
92, 23, 258, 259, 6  
93, 24, 257, 258, 23  
94, 32, 100, 257, 24  
95, 33, 101, 35, 34  
96, 42, 13, 18, 43  
97, 85, 33, 187, 188  
99, 96, 177, 38, 87  
100, 7, 39, 38, 177  
101, 26, 261, 260, 25  
102, 7, 25, 260, 39  
103, 261, 263, 27, 26  
104, 27, 263, 262, 103  
105, 262, 36, 32, 103  
107, 204, 203, 215, 221  
109, 50, 188, 201, 253  
110, 50, 253, 200, 218  
112, 75, 76, 57, 59  
113, 76, 70, 58, 57  
114, 70, 71, 54, 58  
115, 71, 67, 56, 54  
116, 141, 140, 160, 161  
117, 137, 127, 164, 158  
118, 127, 117, 162, 164  
119, 117, 112, 163, 162  
120, 112, 135, 121, 163  
121, 135, 141, 161, 121  
122, 81, 132, 130, 105  
123, 136, 80, 79, 119  
124, 119, 118, 129, 136  
125, 81, 93, 80, 79  
126, 146, 147, 118, 113  
127, 140, 125, 157, 160  
128, 125, 124, 156, 157  
129, 124, 134, 120, 156  
130, 107, 106, 166, 170  
131, 106, 149, 167, 166  
132, 149, 153, 174, 167  
133, 153, 155, 131, 174  
134, 142, 82, 66, 173  
135, 66, 62, 77, 82  
136, 77, 73, 63, 62  
137, 125, 140, 141, 135  
138, 60, 68, 74, 65  
141, 153, 155, 154, 151  
142, 154, 142, 152, 151  
143, 151, 153, 149, 148  
144, 149, 106, 145, 148  
145, 148, 151, 152, 108  
146, 108, 109, 145, 148  
147, 145, 109, 150, 144  
148, 118, 128, 143, 147  
149, 82, 142, 76, 75  
151, 152, 142, 67, 83  
152, 108, 78, 83, 152  
153, 128, 119, 138, 126  
154, 116, 114, 150, 109  
155, 109, 116, 123, 108  
156, 108, 123, 111, 78  
157, 78, 111, 137, 83  
158, 126, 138, 134, 114  
159, 123, 124, 134, 116  
160, 123, 111, 125, 124  
163, 117, 127, 137, 125  
164, 125, 135, 112, 117  
165, 174, 171, 165, 131



166, 133, 167, 174, 171  
 167, 176, 166, 167, 133  
 168, 81, 95, 175, 132  
 169, 61, 64, 65, 63  
 170, 72, 69, 73, 74  
 171, 63, 73, 74, 65  
 172, 75, 69, 73, 77  
 174, 62, 59, 61, 63  
 176, 59, 57, 173, 66  
 180, 160, 157, 121, 161  
 181, 157, 162, 163, 121  
 182, 157, 158, 164, 162  
 183, 79, 159, 110, 95  
 184, 159, 120, 139, 110  
 186, 175, 110, 139, 172  
 187, 139, 122, 176, 172  
 188, 176, 122, 115, 133  
 189, 133, 115, 168, 171  
 190, 171, 168, 169, 173  
 192, 156, 122, 139, 120  
 195, 158, 55, 173, 169  
 197, 145, 107, 146, 144  
 198, 143, 144, 146, 147  
 199, 142, 71, 70, 76  
 200, 120, 134, 138, 159  
 201, 159, 138, 119, 79  
 202, 172, 170, 166, 176  
 203, 175, 130, 170, 172  
 205, 67, 137, 158, 56  
 210, 158, 168, 156, 157  
 211, 93, 94, 92, 81  
 212, 53, 118, 129, 52  
 215, 170, 107, 113, 105  
 216, 105, 92, 53, 113  
 221, 155, 142, 173, 131  
 222, 61, 64, 60, 59  
 223, 72, 69, 75, 68  
 224, 68, 60, 59, 75  
 226, 143, 126, 150, 144  
 228, 231, 211, 210, 197  
 229, 226, 231, 211, 201  
 230, 221, 215, 194, 225  
 233, 231, 229, 230, 232  
 235, 183, 187, 33, 34  
 236, 212, 248, 247, 236  
 237, 241, 212, 236, 237  
 240, 197, 184, 212, 213  
 242, 190, 189, 265, 191  
 243, 189, 216, 264, 265  
 244, 216, 228, 186, 264  
 \*Element, type=R3D3  
 5, 16, 47, 19  
 9, 2, 17, 46  
 10, 10, 40, 9  
 42, 31, 179, 6  
 45, 24, 32, 98  
 46, 98, 103, 32  
 49, 99, 98, 37  
 56, 11, 32, 102  
 62, 13, 10, 101  
 63, 242, 238, 241  
 70, 84, 185, 186  
 72, 187, 84, 186  
 78, 181, 180, 185  
 98, 50, 188, 187  
 106, 32, 102, 36  
 108, 215, 203, 214  
 111, 200, 253, 49  
 139, 65, 64, 60  
 140, 68, 72, 74  
 150, 142, 71, 67

```

161, 114, 116, 134
162, 111, 137, 125
173, 75, 77, 82
175, 66, 59, 62
177, 173, 58, 57
178, 173, 54, 58
179, 173, 56, 54
185, 175, 110, 95
191, 165, 173, 171
193, 173, 56, 55
194, 115, 122, 156
196, 106, 107, 145
204, 175, 132, 130
206, 56, 158, 55
207, 137, 67, 83
208, 169, 168, 158
209, 168, 115, 156
213, 81, 92, 105
214, 53, 118, 113
217, 130, 105, 170
218, 113, 146, 107
219, 131, 165, 173
220, 142, 155, 154
225, 126, 114, 150
227, 128, 126, 143
231, 225, 194, 226
232, 231, 226, 232
234, 84, 187, 183
238, 241, 237, 238
239, 184, 242, 241
241, 184, 241, 212
*Nset, nset=PART-1-RefPt_, internal
88888888,
*Elset, elset=PART-1, generate
1, 244, 1
*End Part
**
**
** ASSEMBLY
**
*Assembly, name=Assembly
**
*Instance, name=PART-1-1, part=PART-1
*End Instance
**
*Nset, nset=_Ref-Pt_PART-1-1_88888888, internal, instance=PART-1-1
88888888,
*Nset, nset=LOCO_MASS, instance=PART-1-1
88888888,
*Nset, nset=LOCO-NODES, instance=PART-1-1, generate
1, 265, 1
*Elset, elset=LOCO-ELEMENTS, instance=PART-1-1, generate
1, 244, 1
*Rigid Body, ref node=PART-1-1.PART-1-RefPt_, elset=PART-1-1.PART-1
*Element, type=MASS, elset=LOCO_MASS_LOCO_MASS_X_
1, PART-1-1.88888888
*Mass, elset=LOCO_MASS_LOCO_MASS_X_
336.439,
*End Assembly
***** END INPUT FILE*****

```

## **Appendix D. Railroad Safety Advisory Committee Passenger Safety Working Group Engineering Task Force**

---

At the time of acceptance of this report by the Railroad Safety Advisory Committee, the Engineering Task Force included the following members:

Robert Adduci	US DOT/Volpe Center
Dan Alpert	Federal Railroad Administration
Kiichiro Arie	Central Japan Railway Company
Allen Bieber	STV, Inc.
Charlie Bielitz	Federal Railroad Administration
Stephen Bonina	Interfleet Technology
Michael Burshtin	National Railroad Passenger Corporation (AMTRAK)
Gordon Campbell	Interfleet, Inc.
Michael Carolan	US DOT/Volpe Center
Anya Carroll	US DOT/Volpe Center
David Carter	New Jersey TRANSIT
Michael Coltman	US DOT/Volpe Center
Richard F. Conway	MTA Metro-North
Joshua D. Coran	Talgo, Inc.
Mike Denn	Long Island Railroad
Dominic DiBrito	LTK Engineering Services
Bob Dorer	US DOT/Volpe Center
Raymond Dumoulin	Bombardier Transportation
Don Eccleston	Long Island Rail Road LIRR
Dale Engelhardt	National Railroad Passenger Corporation (AMTRAK)

Gary Fairbanks	Federal Railroad Administration
Nora Friend	Talgo, Inc.
Robert Fries	Transportation Technology Center, Inc.
Wayne Friesner	Dallas Area Rapid Transit
Edward Gacsi	New Jersey Transit
Gregory A. Gagarin	National Railroad Passenger Corporation (AMTRAK)
Robert Galbraith	Mitsubishi Electric Power Products, Inc.
Emmanuel Garcia	MTA Metro-North
Brian Gilleran	Federal Railroad Administration
Tim Good	Stadler Rail
Glenn Gough	Siemens Transportation Systems, Inc.
James Grady Department	Association of American Railroads Safety and Operations
Raymond Green	Denton County Transportation Authority
Hugues Gregoire	Bombardier Transportation
Cynthia Gross	Federal Railroad Administration
Dennis Harwig	Edison Welding Institute
Toshiyuki Hasegawa	KPS N.A., Inc.
Tom Hunt	Nippon Sharyo USA, Inc.
Stanton Hunter	California Department of Transportation Division of Rail
Tak Ishigami	Kawasaki Rail Car, Inc.
Kari Jacobsen	US DOT/Volpe Center
Paul Jamieson	Wabtec Transit - Brakes and Couplers
Tony Jones	Voith Turbo

Larry Kelterborn	Interfleet Technology, Inc.
Kevin Kesler	Federal Railroad Administration
Toshinori Kimura	Kawasaki Heavy Industries, LTD
Fujio Kitamura	Japanese Ministry of Land, Infrastructure, Transport and Tourism
Dan Knot	Federal Railroad Administration
Richard Krisak	Metropolitan Atlanta Rapid Transit Authority
Peter Lapre	Federal Railroad Administration, Region 1
Paul Larouche	Bombardier Transportation
Robert Lauby	Federal Railroad Administration
Dan Lauzon	Brotherhood of Locomotive Engineers and Trainmen
Thomas LeBeau	Denton County Transportation Authority
Dominique LeCorre	Alstom Transport
Luca Lenzi	Ansaldobreda
Jack Lockerby	Raul Bravo & Associates
George Long	Siemens Transportation Systems, Inc.
William Lydon, Jr.	Southern California Regional Rail Authority (SCRRA)
Frank Maldari	Long Island Railroad
Kenneth R. Mannen	Kawasaki Rail Car, Inc.
John Mardente	Federal Railroad Administration
Eloy Martinez	Federal Railroad Administration
Michael Masci	Federal Railroad Administration
Ron Mayville	Simpson Gumpertz & Heger
Patrick McLaughlin	Federal Railroad Administration

Dave Mears	American Short Line Railroad Association
James Michel	HNTB Corporation
Jeffrey F. Moller	Association of American Railroads (AAR)
Brenda Moscoso	Federal Railroad Administration
Michelle Muhlanger	US DOT/Volpe Center
Brian Murphy	Bombardier Transportation
Ron Newman	Federal Railroad Administration
Barbara Pelletier	Federal Railroad Administration
Benjamin Perlman	US DOT/Volpe Center
Anand Prabhakaran	Sharma & Associates, Inc.
Mario Raymond	Bombardier Transportation
Lorenzo Reffreger	Ansaldobreda
Robert Scarola	Federal Railroad Administration
Gerhard Schmidt	Siemens Transportation Systems, Inc.
Martin Schroeder	American Public Transportation Association (APTA)
Kristine Severson	US DOT/Volpe Center
Vinny Sharma	Sharma & Associates
Takashi Shizuka	Nippon Sharyo
Melissa Shurland	Federal Railroad Administration
John Sneed	Federal Railroad Administration
Dave (D.E.) Staplin	National Railroad Passenger Corporation (AMTRAK)
Alois Starlinger	Stadler Rail
Rich Stegner	Motive Power

Jo Strang	Federal Railroad Administration
Phil Strong	PS Consulting
Laura Sullivan	US DOT/Volpe Center
Mike Trosino	National Railroad Passenger Corporation (AMTRAK)
Stewart Trout	Massachusetts Bay Commuter Rail Company (MBCR)
Thomas Tulley	Federal Railroad Administration
John Tunna	Transportation Technology Center, Inc.
David Tyrell	US DOT/Volpe Center
Rich Vadnal	Nippon Sharyo
William Verdeyen	Brotherhood of Locomotive Engineers and Trainmen
Teresa Vicente	Talgo, Inc.
Dave Ward	Alstom Transport
Michael P. Wetherell	Denton County Transportation Authority
Charlie Whalen	Federal Railroad Administration
Brian Whitten	Ensco, Inc.
Gary Widell	Nippon Sharyo
Cliff Woodbury	LTK Engineering Services
Eric Wrobley	LTK Engineering Services
Theresa Zemelman	Raul Bravo & Associates

## Definitions

---

### Existing Terms in 49 CFR 238

For consistency with Part 238, terms that are used in this report that are already defined in Part 238 have the same meaning. Terms that are defined in § 238.5 (Definitions) and also used within this report are listed in **Appendix B. Selected CFR References**.

### New Terms

Definitions are being added for terms that are not specifically defined in Part 238. The new definitions are provided as follows:

*Vertical offset* means the additional difference in height above top of rail between the main structures of two pieces of rail equipment from their normal difference, if any, in height.

*Longitudinal load carrying component* means an identifiable structural element of the car body that is capable of carrying axial and bending loads, such as side sills, and carries a significant portion of the applied longitudinal load when the load is applied in-line with the collision load path of the car body. Structural elements capable of carrying only in-plane loads, such as the outer skin, that do not carry a significant portion of the applied load are not considered longitudinal load carrying components.

*Crippling load* means the largest compressive load an occupied volume can sustain before its structure is overwhelmed. It is indicated by the peak on a load-displacement characteristic.



## Abbreviations and Acronyms

---

AAR	Association of American Railroads
APTA	American Public Transportation Association
AT	antitelescoping
ATD	anthropomorphic test dummy
CEM	crash energy management
CFR	Code of Federal Regulations
CG	center of gravity
DMU	diesel multiple-unit locomotive
EMU	electric multiple-unit locomotive
EN	EuroNorm
ETF	Engineering Task Force
FE	finite element
FRA	Federal Railroad Administration
FTA	Federal Transit Administration
g	gravitational acceleration (32.2 feet/second/second)
in	inch(es)
ips	inch(es) per second
kip	kilopound(s)
mph	mile(s) per hour
ms	millisecond(s)
MU	multiple unit
NTSB	National Transportation Safety Board
OVI	occupied volume integrity
PBC	pushback coupler
PEAM	primary energy absorption mechanism
psi	per square inch
RMS	Railway Mail Service
RPO	Railway Post Office
RSAC	Railroad Safety Advisory Committee
RSSB	Rail Safety and Standards Board
SIV	secondary impact velocity
SOA	state-of-the-art